

FCC Test Report

Report No.: RF191115E03-1

FCC ID: Q87-08162

Test Model: MR6350

Series Model: MR6340, MR6330, MR6320

Received Date: Nov. 15, 2019

Test Date: Nov. 21 to 28, 2019

Issued Date: Feb. 12, 2020

Applicant: LINKSYS LLC

Address: 121 Theory Drive Irvine California 92617 United States

Issued By: Bureau Veritas Consumer Products Services (H.K.) Ltd., Taoyuan Branch
Hsin Chu Laboratory

Lab Address: E-2, No.1, Li Hsin 1st Road, Hsinchu Science Park, Hsinchu City 300,
Taiwan

Test Location: E-2, No.1, Li Hsin 1st Road, Hsinchu Science Park, Hsinchu City 300,
Taiwan

**FCC Registration /
Designation Number:** 723255 / TW2022



This report is for your exclusive use. Any copying or replication of this report to or for any other person or entity, or use of our name or trademark, is permitted only with our prior written permission. This report sets forth our findings solely with respect to the test samples identified herein. The results set forth in this report are not indicative or representative of the quality or characteristics of the lot from which a test sample was taken or any similar or identical product unless specifically and expressly noted. Our report includes all of the tests requested by you and the results thereof based upon the information that you provided to us. You have 60 days from date of issuance of this report to notify us of any material error or omission caused by our negligence, provided, however, that such notice shall be in writing and shall specifically address the issue you wish to raise. A failure to raise such issue within the prescribed time shall constitute your unqualified acceptance of the completeness of this report, the tests conducted and the correctness of the report contents. Unless specific mention, the uncertainty of measurement has been explicitly taken into account to declare the compliance or non-compliance to the specification. The report must not be used by the client to claim product certification, approval, or endorsement by TAF or any government agencies.

Table of Contents

Release Control Record	4
1 Certificate of Conformity	5
2 Summary of Test Results	6
2.1 Measurement Uncertainty	6
2.2 Modification Record	6
3 General Information	7
3.1 General Description of EUT	7
3.2 Description of Test Modes	11
3.2.1 Test Mode Applicability and Tested Channel Detail	12
3.3 Duty Cycle of Test Signal	14
3.4 Description of Support Units	15
3.4.1 Configuration of System under Test	16
3.5 General Description of Applied Standard and references	17
4 Test Types and Results	18
4.1 Radiated Emission and Bandedge Measurement	18
4.1.1 Limits of Radiated Emission and Bandedge Measurement	18
4.1.2 Test Instruments	19
4.1.3 Test Procedure	22
4.1.4 Deviation from Test Standard	23
4.1.5 Test Setup	23
4.1.6 EUT Operating Condition	24
4.1.7 Test Results	25
4.2 Conducted Emission Measurement	45
4.2.1 Limits of Conducted Emission Measurement	45
4.2.2 Test Instruments	45
4.2.3 Test Procedure	46
4.2.4 Deviation from Test Standard	46
4.2.5 Test Setup	46
4.2.6 EUT Operating Condition	46
4.2.7 Test Results	47
4.3 Transmit Power Measurement	49
4.3.1 Limits of Transmit Power Measurement	49
4.3.2 Test Setup	49
4.3.3 Test Instruments	49
4.3.4 Test Procedure	49
4.3.5 Deviation from Test Standard	50
4.3.6 EUT Operating Condition	50
4.3.7 Test Result	51
4.4 Occupied Bandwidth Measurement	53
4.4.1 Test Setup	53
4.4.2 Test Instruments	53
4.4.3 Test Procedure	53
4.4.4 Test Results	54
4.5 Peak Power Spectral Density Measurement	60
4.5.1 Limits of Peak Power Spectral Density Measurement	60
4.5.2 Test Setup	60
4.5.3 Test Instruments	60
4.5.4 Test Procedure	60
4.5.5 Deviation from Test Standard	61
4.5.6 EUT Operating Condition	61
4.5.7 Test Results	62
4.6 Frequency Stability Measurement	68
4.6.1 Limits of Frequency Stability Measurement	68

4.6.2 Test Setup.....	68
4.6.3 Test Instruments	68
4.6.4 Test Procedure	68
4.6.5 Deviation from Test Standard	68
4.6.6 EUT Operating Condition	68
4.6.7 Test Results	69
4.7 6dB Bandwidth Measurement	70
4.7.1 Limits of 6dB Bandwidth Measurement.....	70
4.7.2 Test Setup.....	70
4.7.3 Test Instruments	70
4.7.4 Test Procedure	70
4.7.5 Deviation from Test Standard	70
4.7.6 EUT Operating Condition	70
4.7.7 Test Results	71
5 Pictures of Test Arrangements.....	73
Annex A- Radiated Out of Band Emission (OOBE) Measurement (For U-NII-3 band)	74
Appendix – Information of the Testing Laboratories	77

Release Control Record

Issue No.	Description	Date Issued
RF191115E03-1	Original release.	Feb. 12, 2020

1 Certificate of Conformity

Product: Linksys MR6350 Dual-Band WiFi 5 Router, AC1300

Brand: Linksys

Test Model: MR6350

Series Model: MR6340, MR6330, MR6320

Sample Status: ENGINEERING SAMPLE

Applicant: LINKSYS LLC

Test Date: Nov. 21 to 28, 2019

Standard: 47 CFR FCC Part 15, Subpart E (Section 15.407)
ANSI C63.10: 2013

The above equipment has been tested by **Bureau Veritas Consumer Products Services (H.K.) Ltd., Taoyuan Branch**, and found compliance with the requirement of the above standards. The test record, data evaluation & Equipment Under Test (EUT) configurations represented herein are true and accurate accounts of the measurements of the sample's EMC characteristics under the conditions specified in this report.

Prepared by : Vivian Huang , **Date:** Feb. 12, 2020
Vivian Huang / Specialist

Approved by : Clark Lin , **Date:** Feb. 12, 2020
Clark Lin / Technical Manager

2 Summary of Test Results

47 CFR FCC Part 15, Subpart E (Section 15.407)			
FCC Clause	Test Item	Result	Remarks
15.407(b)(6)	AC Power Conducted Emissions	PASS	Meet the requirement of limit. Minimum passing margin is -8.05 dB at 0.47422 MHz.
15.407(b) (1/2/3/4(i/ii)/6)	Radiated Emissions & Band Edge Measurement*	PASS	Meet the requirement of limit. Minimum passing margin is -1.1 dB at 5150.00 MHz.
15.407(a)(1/2/3)	Max Average Transmit Power	PASS	Meet the requirement of limit.
---	Occupied Bandwidth Measurement	-	Reference only.
15.407(a)(1/2/3)	Peak Power Spectral Density	PASS	Meet the requirement of limit.
15.407(e)	6dB bandwidth	PASS	Meet the requirement of limit. (U-NII-3 Band only)
15.407(g)	Frequency Stability	PASS	Meet the requirement of limit.
15.203	Antenna Requirement	PASS	Antenna connector is i-pex(MHF) not a standard connector.

*For U-NII-3 band compliance with rule part 15.407(b)(4)(i), the OOB test plots were recorded in Annex A.

Note:

Determining compliance based on the results of the compliance measurement, not taking into account measurement instrumentation uncertainty.

2.1 Measurement Uncertainty

Where relevant, the following measurement uncertainty levels have been estimated for tests performed on the EUT as specified in CISPR 16-4-2:

Measurement	Frequency	Expanded Uncertainty (k=2) (\pm)
Conducted Emissions at mains ports	150kHz ~ 30MHz	1.8 dB
Radiated Emissions up to 1 GHz	9kHz ~ 30MHz	3.0 dB
	30MHz ~ 1GHz	4.9 dB
Radiated Emissions above 1 GHz	1GHz ~ 6GHz	5.1 dB
	6GHz ~ 18GHz	4.9 dB
	18GHz ~ 40GHz	5.2 dB

2.2 Modification Record

There were no modifications required for compliance.

3 General Information

3.1 General Description of EUT

Product	Linksys MR6350 Dual-Band WiFi 5 Router, AC1300
Brand	Linksys
Test Model	MR6350
Series Model	MR6340, MR6330, MR6320
Status of EUT	ENGINEERING SAMPLE
Driver Version	HW: V01 SW: v1.0.7
Power Supply Rating	12Vdc from power adapter
Modulation Type	CCK, DQPSK, DBPSK for DSSS 64QAM, 16QAM, QPSK, BPSK for OFDM 256QAM for OFDM in 11ac mode and VHT20/40 in 2.4GHz
Modulation Technology	DSSS, OFDM
Transfer Rate	802.11b: up to 11Mbps 802.11a/g: up to 54Mbps 802.11n: up to 300Mbps 802.11ac: up to 866.7Mbps
Operating Frequency	2.4GHz: 2.412 ~ 2.462GHz 5GHz: 5.18~ 5.24GHz, 5.745 ~ 5.825GHz
Number of Channel	2.4GHz: 802.11b, 802.11g, 802.11n (HT20), VHT20: 11 802.11n (HT40), VHT40: 7 5GHz: 802.11a, 802.11n (HT20), 802.11ac (VHT20): 9 802.11n (HT40), 802.11ac (VHT40): 4 802.11ac (VHT80): 2
Output Power	2.4GHz: 827.288 mW 5.18 ~ 5.24GHz: 461.906 mW 5.745 ~ 5.825GHz: 671.324 mW
Antenna Type	Refer to Note
Antenna Connector	Refer to Note
Accessory Device	Adapter x 1
Data Cable Supplied	RJ45 cable x1 (unshielded, 1m)

Note:

1. The EUT has four model names which are identical to each other in all aspects except for the followings:

Brand Name	Model Name	Description
Linksys	MR6350	For Marketing Purpose
	MR6340	
	MR6330	
	MR6320	

Note: From the above models, model: MR6350 was selected as representative model for the test and its data was recorded in this report.

2. There are WLAN and Bluetooth technology used for the EUT. The EUT has two radios as following table:

Radio 1	Radio 2
WLAN 2.4GHz + 5GHz	Bluetooth

3. Simultaneously transmission condition.

Condition	Technology	
1	WLAN (2.4GHz)	WLAN (5GHz)

Note: The emission of the simultaneous operation has been evaluated and no non-compliance was found.

4. The EUT must be supplied power adapter and following different models could be chosen as following table:

No.	Brand	Model No.	Spec.	Plug
1	Ktec	KSA-18W-120150VU	AC Input: 100-240Vac, 0.5A, 50/60Hz DC Output: 12V, 1.5A DC Output Cable: 1.6m, Unshielded	FCC/IC
2	APD	WB-18Q12FU	AC Input: 100-240Vac, 0.6AMAX, 50-60Hz DC Output: 12V, 1.5A DC Output Cable: 1.6m, Unshielded	FCC/IC

Note: From the above adapters, the worst conducted emission test was found in **Adapter 2** and .the worst radiated emission test was found in **Adapter 1**. Therefore only the test data of the modes were recorded in this report.

5. The antennas provided to the EUT, please refer to the following table:

WLAN ANTENNA SPEC.						
Antenna NO.	Model	Antenna Net Gain(dBi)	Frequency range	Antenna Type	Connector Type	Cable Length (mm)
1	ANEP5M2-CCG03-EH	2.93	2.4~2.4835GHz	Dipole	i-pex(MHF)	165
		3.18	5.15~5.25GHz			
		3.18	5.25~5.35GHz			
		3.13	5.47~5.725GHz			
		3.17	5.725~5.85GHz			
2	ANEP5M2-CCG04-EH	2.82	2.4~2.4835GHz	Dipole	i-pex(MHF)	335
		2.95	5.15~5.25GHz			
		2.95	5.25~5.35GHz			
		2.78	5.47~5.725GHz			
		2.85	5.725~5.85GHz			
BLUETOOTH ANTENNA SPEC.						
1	ANTS1M1-CCG00-EH	2.9	2.4~2.4835GHz	Metal	none	N/A

6. The EUT incorporates a MIMO function:

2.4GHz Band		
MODULATION MODE	TX & RX CONFIGURATION	
802.11b	2TX	2RX
802.11g	2TX	2RX
802.11n (HT20)	2TX	2RX
802.11n (HT40)	2TX	2RX
VHT20	2TX	2RX
VHT40	2TX	2RX
5GHz Band		
MODULATION MODE	TX & RX CONFIGURATION	
802.11a	2TX	2RX
802.11n (HT20)	2TX	2RX
802.11n (HT40)	2TX	2RX
802.11ac (VHT20)	2TX	2RX
802.11ac (VHT40)	2TX	2RX
802.11ac (VHT80)	2TX	2RX

Note:

- All of modulation mode support beamforming function except 802.11b modulation mode.
- The EUT support Beamforming and non-beamforming mode, therefore both mode were investigated and the worst case scenario was identified. The worst case data were presented in test report.
- The modulation and bandwidth are similar for 802.11n mode for 20MHz (40MHz) and 802.11ac mode for 20MHz (40MHz), therefore the manufacturer will control the 802.11n mode power as same as 802.11ac and investigated worst case to representative mode in test report. (Final test mode refer section 3.2.1)

7. The power setting are list as below:

802.11a		802.11ac (VHT20)		802.11ac (VHT40)		802.11ac (VHT80)	
Frequency (MHz)	Power Setting	Frequency (MHz)	Power Setting	Frequency (MHz)	Power Setting	Frequency (MHz)	Power Setting
5180	20	5180	20	5190	17.5	5210	17
5200	23	5200	23.5	5230	21	5775	21.5
5240	23.5	5240	23.5	5755	23	-	-
5745	25	5745	25	5795	24.5	-	-
5785	25	5785	25	-	-	-	-
5825	25	5825	25	-	-	-	-

8. The above EUT information is declared by manufacturer and for more detailed features description, please refers to the manufacturer's specifications or user's manual.

3.2 Description of Test Modes

FOR 5180 ~ 5240MHz

4 channels are provided for 802.11a, 802.11n (HT20), 802.11ac (VHT20):

Channel	Frequency	Channel	Frequency
36	5180 MHz	44	5220 MHz
40	5200 MHz	48	5240 MHz

2 channels are provided for 802.11n (HT40), 802.11ac (VHT40):

Channel	Frequency	Channel	Frequency
38	5190 MHz	46	5230 MHz

1 channel is provided for 802.11ac (VHT80):

Channel	Frequency
42	5210 MHz

FOR 5745 ~ 5825MHz:

5 channels are provided for 802.11a, 802.11n (HT20), 802.11ac (VHT20):

Channel	Frequency	Channel	Frequency
149	5745 MHz	161	5805 MHz
153	5765 MHz	165	5825 MHz
157	5785 MHz		

2 channels are provided for 802.11n (HT40), 802.11ac (VHT40):

Channel	Frequency	Channel	Frequency
151	5755 MHz	159	5795 MHz

1 channel is provided for 802.11ac (VHT80):

Channel	Frequency
155	5775 MHz

3.2.1 Test Mode Applicability and Tested Channel Detail

EUT Configure Mode	Applicable To				Description
	RE \geq 1G	RE<1G	PLC	APCM	
-	√	√	√	√	-

Where **RE \geq 1G**: Radiated Emission above 1GHz **RE<1G**: Radiated Emission below 1GHz
PLC: Power Line Conducted Emission **APCM**: Antenna Port Conducted Measurement

NOTE:

- The EUT had been pre-tested on the positioned of laying-flat and wall-mount. The worst case was found when positioned of on wall-mount (for below 1GHz and above 1GHz).

Radiated Emission Test (Above 1GHz):

- Pre-Scan has been conducted to determine the worst-case mode from all possible combinations between available modulations, data rates and antenna ports (if EUT with antenna diversity architecture).
- Following channel(s) was (were) selected for the final test as listed below.

Beamforming Mode						
MODE	AVAILABLE CHANNEL	TESTED CHANNEL	MODULATION TECHNOLOGY	MODULATION TYPE	Data Rate (Mbps)	MODE
802.11a	5180-5240	36 to 48	36, 40, 48	OFDM	BPSK	6
802.11ac (VHT20)		36 to 48	36, 40, 48	OFDM	BPSK	6.5
802.11ac (VHT40)		38 to 46	38, 46	OFDM	BPSK	13.5
802.11ac (VHT80)		42	42	OFDM	BPSK	29.3
802.11a	5745-5825	149 to 165	149, 157, 165	OFDM	BPSK	6
802.11ac (VHT20)		149 to 165	149, 157, 165	OFDM	BPSK	6.5
802.11ac (VHT40)		151 to 159	151, 159	OFDM	BPSK	13.5
802.11ac (VHT80)		155	155	OFDM	BPSK	29.3

Radiated Emission Test (Below 1GHz):

- Pre-Scan has been conducted to determine the worst-case mode from all possible combinations between available modulations, data rates and antenna ports (if EUT with antenna diversity architecture).
- Following channel(s) was (were) selected for the final test as listed below.

Beamforming Mode						
MODE	AVAILABLE CHANNEL	TESTED CHANNEL	MODULATION TECHNOLOGY	MODULATION TYPE	Data Rate (Mbps)	MODE
802.11a	5180-5240 5745-5825	36 to 48 149 to 165	149	OFDM	BPSK	6

Power Line Conducted Emission Test:

- Pre-Scan has been conducted to determine the worst-case mode from all possible combinations between available modulations, data rates and antenna ports (if EUT with antenna diversity architecture).
- Following channel(s) was (were) selected for the final test as listed below.

Beamforming Mode						
MODE	AVAILABLE CHANNEL	TESTED CHANNEL	MODULATION TECHNOLOGY	MODULATION TYPE	Data Rate (Mbps)	MODE
802.11a	5180-5240 5745-5825	36 to 48 149 to 165	149	OFDM	BPSK	6

Antenna Port Conducted Measurement:

- This item includes all test value of each mode, but only includes spectrum plot of worst value of each mode.
- Pre-Scan has been conducted to determine the worst-case mode from all possible combinations between available modulations, data rates and antenna ports (if EUT with antenna diversity architecture).
- Following channel(s) was (were) selected for the final test as listed below.

Beamforming Mode						
MODE	AVAILABLE CHANNEL	TESTED CHANNEL	MODULATION TECHNOLOGY	MODULATION TYPE	Data Rate (Mbps)	MODE
802.11a	5180-5240	36 to 48	36, 40, 48	OFDM	BPSK	6
802.11ac (VHT20)		36 to 48	36, 40, 48	OFDM	BPSK	6.5
802.11ac (VHT40)		38 to 46	38, 46	OFDM	BPSK	13.5
802.11ac (VHT80)		42	42	OFDM	BPSK	29.3
802.11a	5745-5825	149 to 165	149, 157, 165	OFDM	BPSK	6
802.11ac (VHT20)		149 to 165	149, 157, 165	OFDM	BPSK	6.5
802.11ac (VHT40)		151 to 159	151, 159	OFDM	BPSK	13.5
802.11ac (VHT80)		155	155	OFDM	BPSK	29.3

Test Condition:

Applicable To	Environmental Conditions	Input Power	Tested By
RE \geq 1G	25deg. C, 70%RH	120Vac, 60Hz	Jeff Lee
RE $<$ 1G	22deg. C, 61%RH	120Vac, 60Hz	Kevin Ko
PLC	25deg. C, 75%RH	120Vac, 60Hz	Kevin Ko
APCM	25deg. C, 60%RH	120Vac, 60Hz	Robert Cheng

3.3 Duty Cycle of Test Signal

If duty cycle of test signal is $\geq 98\%$, duty factor is not required.

If duty cycle of test signal is $< 98\%$, duty factor shall be considered.

802.11a: Duty cycle = $1.454 \text{ ms} / 1.638 \text{ ms} = 0.888$, Duty factor = $10 * \log (1/\text{Duty cycle}) = 0.52$

802.11ac (VHT20): Duty cycle = $5.026 \text{ ms} / 5.129 \text{ ms} = 0.98$

802.11ac (VHT40): Duty cycle = $1.762 \text{ ms} / 2.126 \text{ ms} = 0.829$, Duty factor = $10 * \log (1/\text{Duty cycle}) = 0.82$

802.11ac (VHT80): Duty cycle = $1.883 \text{ ms} / 2.103 \text{ ms} = 0.895$, Duty factor = $10 * \log (1/\text{Duty cycle}) = 0.48$

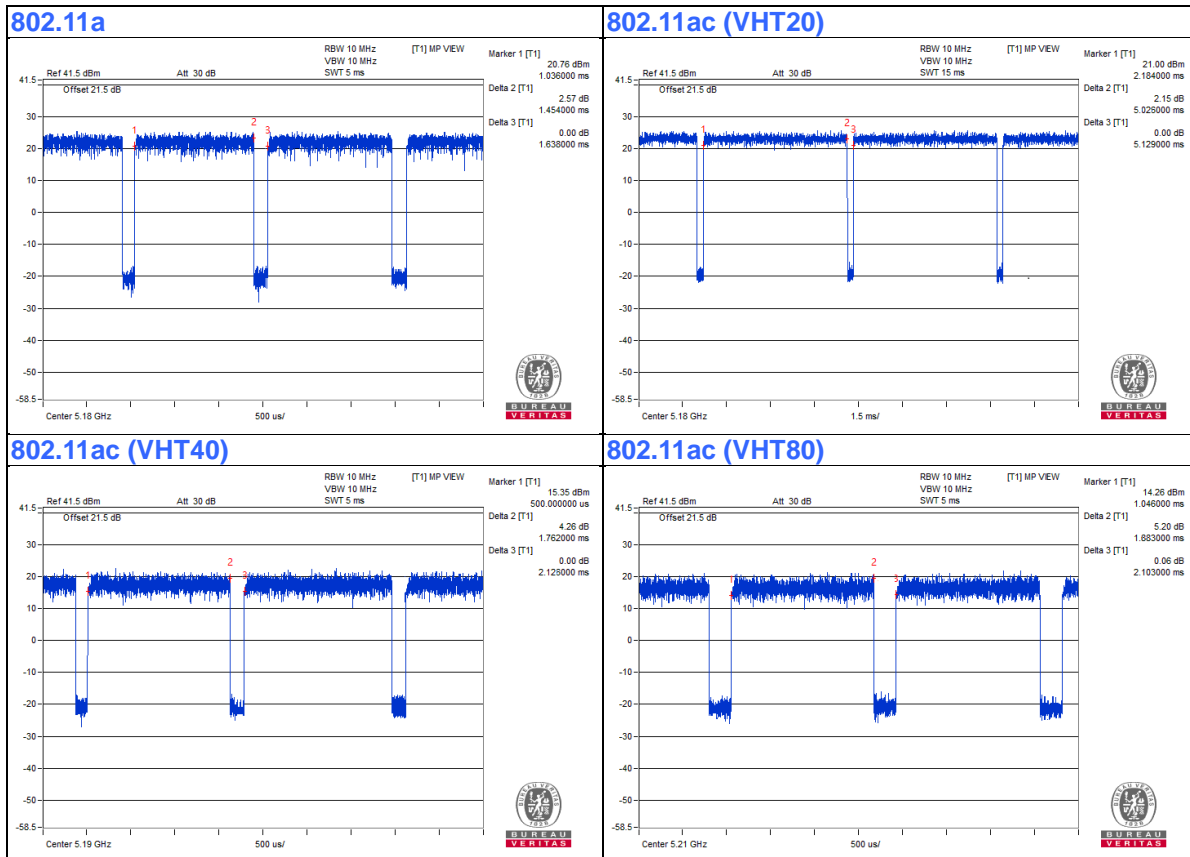

3.4 Description of Support Units

The EUT has been tested as an independent unit together with other necessary accessories or support units. The following support units or accessories were used to form a representative test configuration during the tests.

ID	Product	Brand	Model No.	Serial No.	FCC ID	Remarks
A.	Laptop	DELL	E5430	HYV4VY1	FCC DoC	Provided by Lab
B.	Laptop	DELL	E5430	DM1SKV1	FCC DoC	Provided by Lab
C.	USB Dongle	Sandisk	64G	NA	NA	Provided by Lab

Note:

1. All power cords of the above support units are non-shielded (1.8m).

ID	Descriptions	Qty.	Length (m)	Shielding (Yes/No)	Cores (Qty.)	Remarks
1.	RJ-45 Cable	1	10	No	0	Provided by Lab
2.	RJ-45 Cable	1	10	No	0	Provided by Lab
3.	DC Cable	1	1.6	No	0	Supplied by client

3.4.1 Configuration of System under Test

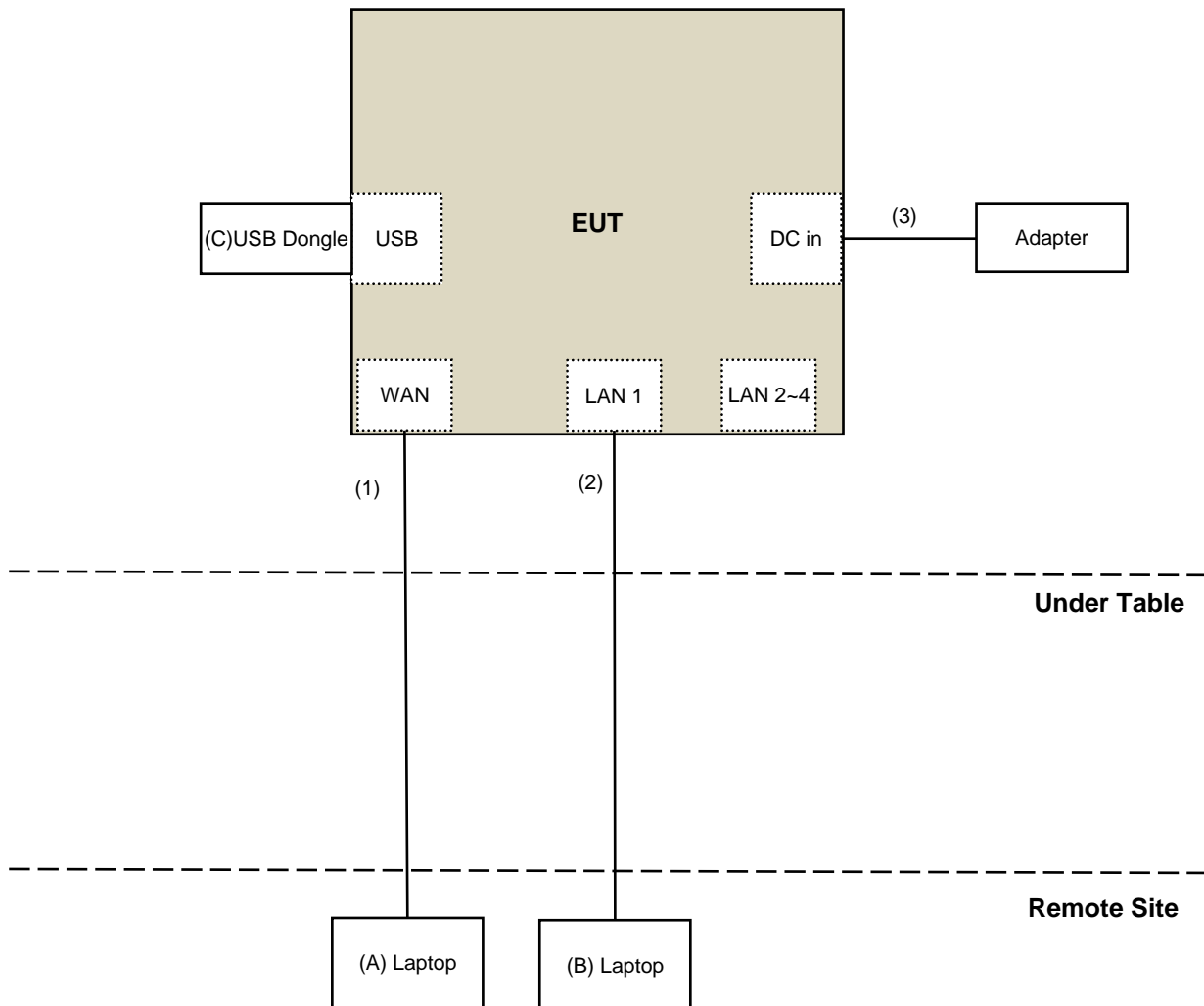

3.5 General Description of Applied Standard and references

The EUT is a RF Product. According to the specifications of the manufacturer, it must comply with the requirements of the following standards:

Test standard:

FCC Part 15, Subpart E (15.407)
ANSI C63.10-2013

All test items have been performed and recorded as per the above standards.

References Test Guidance :

KDB 789033 D02 General UNII Test Procedure New Rules v02r01
KDB 662911 D01 Multiple Transmitter Output v02r01

All test items have been performed as a reference to the above KDB test guidance.

4 Test Types and Results

4.1 Radiated Emission and Bandedge Measurement

4.1.1 Limits of Radiated Emission and Bandedge Measurement

Radiated emissions which fall in the restricted bands must comply with the radiated emission limits specified as below table.

Frequencies (MHz)	Field Strength (microvolts/meter)	Measurement Distance (meters)
0.009 ~ 0.490	2400/F(kHz)	300
0.490 ~ 1.705	24000/F(kHz)	30
1.705 ~ 30.0	30	30
30 ~ 88	100	3
88 ~ 216	150	3
216 ~ 960	200	3
Above 960	500	3

NOTE:

- The lower limit shall apply at the transition frequencies.
- Emission level (dBuV/m) = 20 log Emission level (uV/m).
- For frequencies above 1000MHz, the field strength limits are based on average detector, however, the peak field strength of any emission shall not exceed the maximum permitted average limits, specified above by more than 20dB under any condition of modulation.

Limits of unwanted emission out of the restricted bands

Applicable To		Limit	
789033 D02 General UNII Test Procedure New Rules v02r01		Field Strength at 3m	
		PK:74 (dBµV/m)	AV:54 (dBµV/m)
Frequency Band	Applicable To	EIRP Limit	Equivalent Field Strength at 3m
5150~5250 MHz	15.407(b)(1)	PK:-27 (dBm/MHz)	PK:68.2(dBµV/m)
5250~5350 MHz	15.407(b)(2)		
5470~5725 MHz	15.407(b)(3)		
5725~5850 MHz	<input checked="" type="checkbox"/> 15.407(b)(4)(i)	PK:-27 (dBm/MHz) ^{*1} PK:10 (dBm/MHz) ^{*2} PK:15.6 (dBm/MHz) ^{*3} PK:27 (dBm/MHz) ^{*4}	PK: 68.2(dBµV/m) ^{*1} PK:105.2 (dBµV/m) ^{*2} PK: 110.8(dBµV/m) ^{*3} PK:122.2 (dBµV/m) ^{*4}
	<input type="checkbox"/> 15.407(b)(4)(ii)	Emission limits in section 15.247(d)	
*1 beyond 75 MHz or more above of the band edge.		*2 below the band edge increasing linearly to 10 dBm/MHz at 25 MHz above.	
*3 below the band edge increasing linearly to a level of 15.6 dBm/MHz at 5 MHz above.		*4 from 5 MHz above or below the band edge increasing linearly to a level of 27 dBm/MHz at the band edge.	

Note:

The following formula is used to convert the equipment isotropic radiated power (eirp) to field strength:

$$E = \frac{1000000\sqrt{30P}}{3} \mu\text{V/m, where } P \text{ is the eirp (Watts).}$$

4.1.2 Test Instruments

For OOB test:

DESCRIPTION & MANUFACTURER	MODEL NO.	SERIAL NO.	CALIBRATED DATE	CALIBRATED UNTIL
Test Receiver Keysight	N9038A	MY54450088	July 03, 2019	July 02, 2020
Horn_Antenna SCHWARZBECK	BBHA 9120D	9120D-783	Nov. 25, 2018	Nov. 24, 2019
Pre-Amplifier EMCI	EMC12630SE	980385	Aug. 15, 2019	Aug. 14, 2020
RF Cable	EMC104-SM-SM-1200	160923	Jan. 28, 2019	Jan. 27, 2020
RF Cable	104 RF cable	131215	Jan. 10, 2019	Jan. 09, 2020
RF Cable	EMC104-SM-SM-6000	180418	May 03, 2019	May 02, 2020
Pre-Amplifier EMCI	EMC184045SE	980387	Jan. 28, 2019	Jan. 27, 2020
Horn_Antenna SCHWARZBECK	BBHA 9170	BBHA9170519	Nov. 25, 2018	Nov. 24, 2019
RF Cable	EMC102-KM-KM-1200	160924	Jan. 28, 2019	Jan. 27, 2020
RF Cable	EMC102-KM-KM-1200	160925	Jan. 28, 2019	Jan. 27, 2020
Software	ADT_Radiated_V8.7.08	NA	NA	NA
Boresight Antenna Tower & Turn Table Max-Full	MF-7802BS	MF780208530	NA	NA

Note:

1. The calibration interval of the above test instruments is 12 months and the calibrations are traceable to NML/ROC and NIST/USA.
2. The test was performed in 966 Chamber No. 4.
3. Tested Date: Nov. 21, 2019

For radiated emission test:

DESCRIPTION & MANUFACTURER	MODEL NO.	SERIAL NO.	CALIBRATED DATE	CALIBRATED UNTIL
Test Receiver Keysight	N9038A	MY54450088	July 03, 2019	July 02, 2020
Pre-Amplifier EMCI	EMC001340	980142	May 30, 2019	May 29, 2020
Loop Antenna Electro-Metrics	EM-6879	264	Jan. 22, 2019	Jan. 21, 2020
RF Cable	NA	LOOPCAB-001	Jan. 14, 2019	Jan. 13, 2020
RF Cable	NA	LOOPCAB-002	Jan. 14, 2019	Jan. 13, 2020
Pre-Amplifier Mini-Circuits	ZFL-1000VH2B	AMP-ZFL-01	Oct. 23, 2019	Oct. 22, 2020
Trilog Broadband Antenna SCHWARZBECK	VULB 9168	9168-406	Nov. 11, 2019	Nov. 10, 2020
RF Cable	8D	966-4-1	Mar. 19, 2019	Mar. 18, 2020
RF Cable	8D	966-4-2	Mar. 19, 2019	Mar. 18, 2020
RF Cable	8D	966-4-3	Mar. 19, 2019	Mar. 18, 2020
Fixed attenuator Mini-Circuits	UNAT-5+	PAD-3m-4-01	Sep. 26, 2019	Sep. 25, 2020
Horn_Antenna SCHWARZBECK	BBHA 9120D	9120D-783	Nov. 25, 2018	Nov. 24, 2019
Pre-Amplifier EMCI	EMC12630SE	980385	Aug. 15, 2019	Aug. 14, 2020
RF Cable	EMC104-SM-SM-1200	160923	Jan. 28, 2019	Jan. 27, 2020
RF Cable	104 RF cable	131215	Jan. 10, 2019	Jan. 09, 2020
RF Cable	EMC104-SM-SM-6000	180418	May 03, 2019	May 02, 2020
Pre-Amplifier EMCI	EMC184045SE	980387	Jan. 28, 2019	Jan. 27, 2020
Horn_Antenna SCHWARZBECK	BBHA 9170	BBHA9170519	Nov. 25, 2018	Nov. 24, 2019
RF Cable	EMC102-KM-KM-1200	160924	Jan. 28, 2019	Jan. 27, 2020
RF Cable	EMC102-KM-KM-1200	160925	Jan. 28, 2019	Jan. 27, 2020
Software	ADT_Radiated_V8.7.08	NA	NA	NA
Boresight Antenna Tower & Turn Table Max-Full	MF-7802BS	MF780208530	NA	NA

Note:

1. The calibration interval of the above test instruments is 12 months and the calibrations are traceable to NML/ROC and NIST/USA.
2. The test was performed in 966 Chamber No. 4.
3. Loop antenna was used for all emissions below 30 MHz.
4. Tested Date: Nov. 21 to 23, 2019

For other test:

DESCRIPTION & MANUFACTURER	MODEL NO.	SERIAL NO.	CALIBRATED DATE	CALIBRATED UNTIL
Spectrum Analyzer R&S	FSV40	100964	June 04, 2019	June 03, 2020
Spectrum Analyzer Agilent	E4446A	MY48250253	July 24, 2019	July 23, 2020
Power meter Anritsu	ML2495A	1014008	May 13, 2019	May 12, 2020
Power sensor Anritsu	MA2411B	0917122	May 13, 2019	May 12, 2020
Fixed Attenuator Mini-Circuits	MDCS18N-10	MDCS18N-10-01	Apr. 15, 2019	Apr. 14, 2020
AC Power Source Extech Electronics	6205	1440452	NA	NA
DC Power Supply Topward	6603D	795558	NA	NA
Temperature & Humidity Chamber Giant Force	GTH-150-40-SP-AR	MAA0812-008	Jan. 09, 2019	Jan. 08, 2020
True RMS Clamp Meter FLUKE	325	31130711WS	May 21, 2019	May 20, 2020
ESG Vector signal generator Agilent	E4438C	MY45094468/005 506 602 UK6 UNJ	Nov. 14, 2019	Nov. 13, 2020
Mech Switch Absorptive Mini-Circuits	MSP4TA-18+	0140	Feb. 11, 2019	Feb. 10, 2020
FXD ATTEN Mini-Circuits	BW-S3W2+	MN71981	Feb. 11, 2019	Feb. 10, 2020
Software	ADT_RF Test Software V6.6.5.4	NA	NA	NA

- NOTE:**
1. The test was performed in Oven room 2.
 2. The calibration interval of the above test instruments is 12 months and the calibrations are traceable to NML/ROC and NIST/USA.
 3. Tested Date: Nov. 28, 2019

4.1.3 Test Procedure

For Radiated emission below 30MHz

- a. The EUT was placed on the top of a rotating table 0.8 meters above the ground at a 3 meter chamber room. The table was rotated 360 degrees to determine the position of the highest radiation.
- b. The EUT was set 3 meters away from the interference-receiving antenna, which was mounted on the top of a variable-height antenna tower.
- c. Parallel, perpendicular, and ground-parallel orientations of the antenna are set to make the measurement.
- d. For each suspected emission, the EUT was arranged to its worst case and the rotatable table was turned from 0 degrees to 360 degrees to find the maximum reading.
- e. The test-receiver system was set to Quasi-Peak Detect Function and Specified Bandwidth with Maximum Hold Mode.

NOTE:

1. The resolution bandwidth and video bandwidth of test receiver/spectrum analyzer is 9kHz at frequency below 30MHz.

For Radiated emission above 30MHz

- a. The EUT was placed on the top of a rotating table 0.8 meters (for 30MHz ~ 1GHz) / 1.5 meters (for above 1GHz) above the ground at 3 meter chamber room for test. The table was rotated 360 degrees to determine the position of the highest radiation.
- b. The EUT was set 3 meters away from the interference-receiving antenna, which was mounted on the top of a variable-height antenna tower.
- c. The height of antenna is varied from one meter to four meters above the ground to determine the maximum value of the field strength. Both horizontal and vertical polarizations of the antenna are set to make the measurement.
- d. For each suspected emission, the EUT was arranged to its worst case and then the antenna was tuned to heights from 1 meter to 4 meters and the rotatable table was turned from 0 degrees to 360 degrees to find the maximum reading.
- e. The test-receiver system was set to quasi-peak detect function and specified bandwidth with maximum hold mode when the test frequency is below 1 GHz.
- f. The test-receiver system was set to peak and average detects function and specified bandwidth with maximum hold mode when the test frequency is above 1 GHz. If the peak reading value also meets average limit, measurement with the average detector is unnecessary.

Note:

1. The resolution bandwidth and video bandwidth of test receiver/spectrum analyzer is 120kHz for Quasi-peak detection (QP) at frequency below 1GHz.
2. The resolution bandwidth of test receiver/spectrum analyzer is 1 MHz and the video bandwidth is 3 MHz for Peak detection (PK) at frequency above 1GHz.
3. The resolution bandwidth of test receiver/spectrum analyzer is 1MHz and the video bandwidth is $\geq 1/T$ (Duty cycle $< 98\%$) or 10Hz (Duty cycle $\geq 98\%$) for Average detection (AV) at frequency above 1GHz.
4. All modes of operation were investigated and the worst-case emissions are reported.

4.1.4 Deviation from Test Standard

No deviation.

4.1.5 Test Setup

For Radiated emission below 30MHz

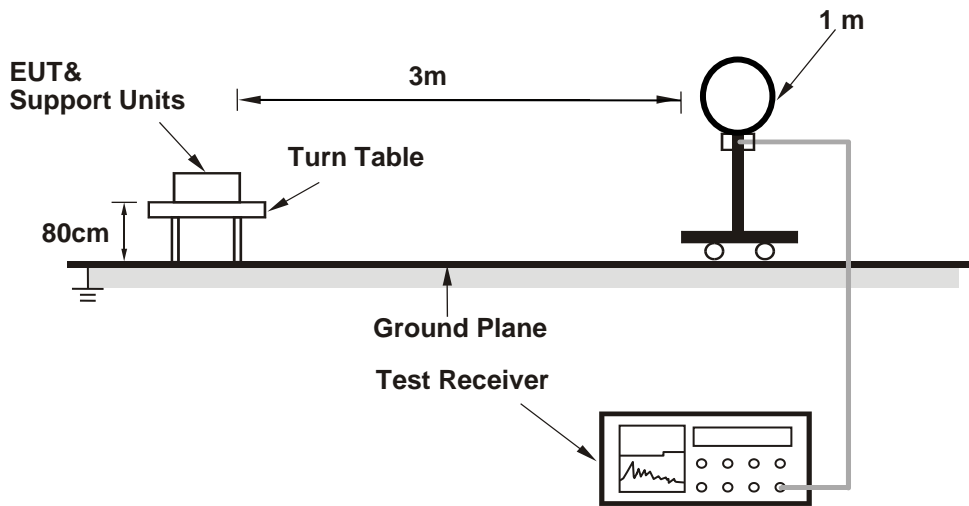

For Radiated emission 30MHz to 1GHz

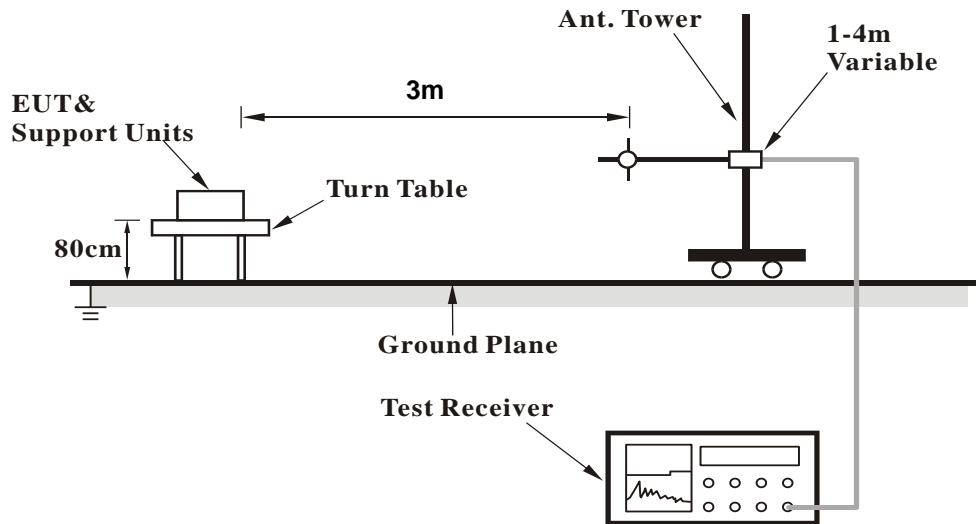

For Radiated emission above 1GHz

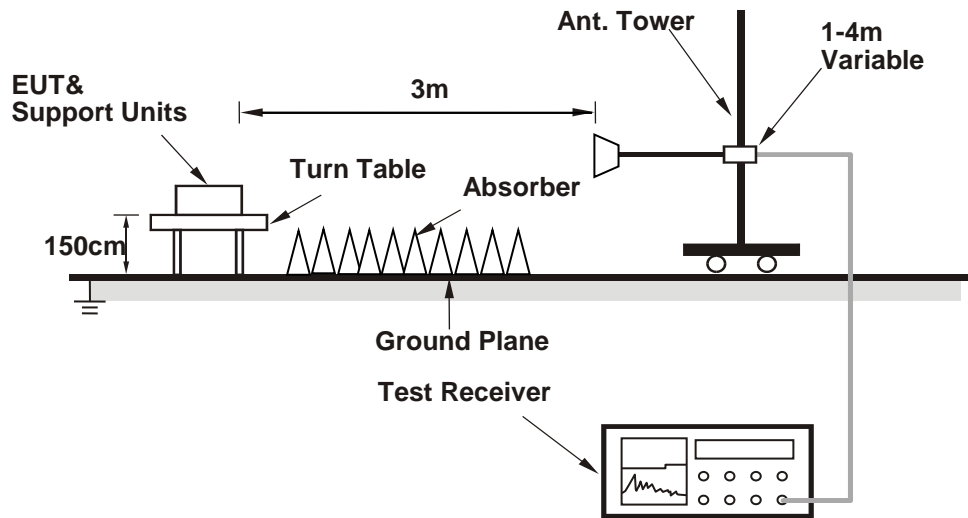

For the actual test configuration, please refer to the attached file (Test Setup Photo).

4.1.6 EUT Operating Condition

- a. Connected the EUT with the Laptop which is placed on remote site.
- b. Controlling software (QDART-Connectivity (1.0.36)) has been activated to set the EUT under transmission condition continuously at specific channel frequency.

4.1.7 Test Results

Above 1GHz Data:

802.11a

CHANNEL	TX Channel 36	DETECTOR FUNCTION	Peak (PK)
FREQUENCY RANGE	1GHz ~ 40GHz		Average (AV)

ANTENNA POLARITY & TEST DISTANCE: HORIZONTAL AT 3 M

NO.	FREQ. (MHz)	EMISSION LEVEL (dBuV/m)	LIMIT (dBuV/m)	MARGIN (dB)	ANTENNA HEIGHT (m)	TABLE ANGLE (Degree)	RAW VALUE (dBuV)	CORRECTION FACTOR (dB/m)
1	5150.00	57.9 PK	74.0	-16.1	2.05 H	83	54.4	3.5
2	5150.00	47.2 AV	54.0	-6.8	2.05 H	83	43.7	3.5
3	*5180.00	101.2 PK			2.05 H	83	97.8	3.4
4	*5180.00	91.4 AV			2.05 H	83	88.0	3.4
5	#10360.00	45.3 PK	68.2	-22.9	1.29 H	44	32.2	13.1
6	15540.00	50.6 PK	74.0	-23.4	1.61 H	22	37.0	13.6
7	15540.00	41.6 AV	54.0	-12.4	1.61 H	22	28.0	13.6

ANTENNA POLARITY & TEST DISTANCE: VERTICAL AT 3 M

NO.	FREQ. (MHz)	EMISSION LEVEL (dBuV/m)	LIMIT (dBuV/m)	MARGIN (dB)	ANTENNA HEIGHT (m)	TABLE ANGLE (Degree)	RAW VALUE (dBuV)	CORRECTION FACTOR (dB/m)
1	5150.00	64.5 PK	74.0	-9.5	1.54 V	334	61.0	3.5
2	5150.00	52.8 AV	54.0	-1.2	1.54 V	334	49.3	3.5
3	*5180.00	109.4 PK			1.54 V	334	106.0	3.4
4	*5180.00	99.2 AV			1.54 V	334	95.8	3.4
5	#10360.00	47.6 PK	68.2	-20.6	1.76 V	315	34.5	13.1
6	15540.00	51.6 PK	74.0	-22.4	1.33 V	6	38.0	13.6
7	15540.00	42.0 AV	54.0	-12.0	1.33 V	6	28.4	13.6

REMARKS:

1. Emission Level(dBuV/m) = Raw Value(dBuV) + Correction Factor(dB/m)
2. Correction Factor(dB/m) = Antenna Factor(dB/m) + Cable Factor(dB) – Pre-Amplifier Factor(dB)
3. Margin value = Emission Level – Limit value
4. The other emission levels were very low against the limit.
5. " * ": Fundamental frequency.
6. " # ": The radiated frequency is out of the restricted band.

CHANNEL	TX Channel 40	DETECTOR FUNCTION	Peak (PK)
FREQUENCY RANGE	1GHz ~ 40GHz		Average (AV)

ANTENNA POLARITY & TEST DISTANCE: HORIZONTAL AT 3 M

NO.	FREQ. (MHz)	EMISSION LEVEL (dBuV/m)	LIMIT (dBuV/m)	MARGIN (dB)	ANTENNA HEIGHT (m)	TABLE ANGLE (Degree)	RAW VALUE (dBuV)	CORRECTION FACTOR (dB/m)
1	*5200.00	110.2 PK			1.17 H	226	106.8	3.4
2	*5200.00	101.4 AV			1.17 H	226	98.0	3.4
3	#10400.00	45.7 PK	68.2	-22.5	1.29 H	109	32.3	13.4
4	15600.00	46.2 PK	74.0	-27.8	2.14 H	294	32.8	13.4
5	15600.00	44.7 AV	54.0	-9.3	2.14 H	294	31.3	13.4

ANTENNA POLARITY & TEST DISTANCE: VERTICAL AT 3 M

NO.	FREQ. (MHz)	EMISSION LEVEL (dBuV/m)	LIMIT (dBuV/m)	MARGIN (dB)	ANTENNA HEIGHT (m)	TABLE ANGLE (Degree)	RAW VALUE (dBuV)	CORRECTION FACTOR (dB/m)
1	*5200.00	119.4 PK			1.46 V	337	116.0	3.4
2	*5200.00	110.3 AV			1.46 V	337	106.9	3.4
3	#10400.00	46.9 PK	68.2	-21.3	1.02 V	200	33.5	13.4
4	15600.00	47.2 PK	74.0	-26.8	1.95 V	239	33.8	13.4
5	15600.00	43.2 AV	54.0	-10.8	1.95 V	239	29.8	13.4

REMARKS:

1. Emission Level(dBuV/m) = Raw Value(dBuV) + Correction Factor(dB/m)
2. Correction Factor(dB/m) = Antenna Factor(dB/m) + Cable Factor(dB) – Pre-Amplifier Factor(dB)
3. Margin value = Emission Level – Limit value
4. The other emission levels were very low against the limit.
5. " * ": Fundamental frequency.
6. " # ": The radiated frequency is out of the restricted band.

CHANNEL	TX Channel 48	DETECTOR FUNCTION	Peak (PK)
FREQUENCY RANGE	1GHz ~ 40GHz		Average (AV)

ANTENNA POLARITY & TEST DISTANCE: HORIZONTAL AT 3 M

NO.	FREQ. (MHz)	EMISSION LEVEL (dBuV/m)	LIMIT (dBuV/m)	MARGIN (dB)	ANTENNA HEIGHT (m)	TABLE ANGLE (Degree)	RAW VALUE (dBuV)	CORRECTION FACTOR (dB/m)
1	5150.00	50.5 PK	74.0	-23.5	2.36 H	111	47.0	3.5
2	5150.00	43.2 AV	54.0	-10.8	2.36 H	111	39.7	3.5
3	*5240.00	114.6 PK			2.36 H	111	111.6	3.0
4	*5240.00	104.3 AV			2.36 H	111	101.3	3.0
5	5350.00	51.2 PK	74.0	-22.8	2.36 H	111	47.9	3.3
6	5350.00	40.1 AV	54.0	-13.9	2.36 H	111	36.8	3.3
7	#10480.00	46.2 PK	68.2	-22.0	2.63 H	5	32.7	13.5
8	15720.00	47.1 PK	74.0	-26.9	1.66 H	334	34.3	12.8
9	15720.00	45.2 AV	54.0	-8.8	1.66 H	334	32.4	12.8

ANTENNA POLARITY & TEST DISTANCE: VERTICAL AT 3 M

NO.	FREQ. (MHz)	EMISSION LEVEL (dBuV/m)	LIMIT (dBuV/m)	MARGIN (dB)	ANTENNA HEIGHT (m)	TABLE ANGLE (Degree)	RAW VALUE (dBuV)	CORRECTION FACTOR (dB/m)
1	5150.00	55.3 PK	74.0	-18.7	1.41 V	334	51.8	3.5
2	5150.00	45.8 AV	54.0	-8.2	1.41 V	334	42.3	3.5
3	*5240.00	121.2 PK			1.41 V	334	118.2	3.0
4	*5240.00	113.4 AV			1.41 V	334	110.4	3.0
5	5350.00	52.7 PK	74.0	-21.3	1.41 V	334	49.4	3.3
6	5350.00	42.0 AV	54.0	-12.0	1.41 V	334	38.7	3.3
7	#10480.00	47.2 PK	68.2	-21.0	1.46 V	26	33.7	13.5
8	15720.00	46.9 PK	74.0	-27.1	1.09 V	172	34.1	12.8
9	15720.00	44.1 AV	54.0	-9.9	1.09 V	172	31.3	12.8

REMARKS:

1. Emission Level(dBuV/m) = Raw Value(dBuV) + Correction Factor(dB/m)
2. Correction Factor(dB/m) = Antenna Factor(dB/m) + Cable Factor(dB) – Pre-Amplifier Factor(dB)
3. Margin value = Emission Level – Limit value
4. The other emission levels were very low against the limit.
5. " * ": Fundamental frequency.
6. " # ": The radiated frequency is out of the restricted band.

CHANNEL	TX Channel 149	DETECTOR FUNCTION	Peak (PK)
FREQUENCY RANGE	1GHz ~ 40GHz		Average (AV)

ANTENNA POLARITY & TEST DISTANCE: HORIZONTAL AT 3 M

NO.	FREQ. (MHz)	EMISSION LEVEL (dBuV/m)	LIMIT (dBuV/m)	MARGIN (dB)	ANTENNA HEIGHT (m)	TABLE ANGLE (Degree)	RAW VALUE (dBuV)	CORRECTION FACTOR (dB/m)
1	*5745.00	114.2 PK			2.43 H	288	110.3	3.9
2	*5745.00	101.9 AV			2.43 H	288	98.0	3.9
3	11490.00	47.3 PK	74.0	-26.7	2.43 H	296	33.1	14.2
4	11490.00	43.8 AV	54.0	-10.2	2.43 H	296	29.6	14.2
5	#17235.00	50.1 PK	68.2	-18.1	2.48 H	229	32.8	17.3

ANTENNA POLARITY & TEST DISTANCE: VERTICAL AT 3 M

NO.	FREQ. (MHz)	EMISSION LEVEL (dBuV/m)	LIMIT (dBuV/m)	MARGIN (dB)	ANTENNA HEIGHT (m)	TABLE ANGLE (Degree)	RAW VALUE (dBuV)	CORRECTION FACTOR (dB/m)
1	*5745.00	125.6 PK			1.67 V	324	121.7	3.9
2	*5745.00	113.4 AV			1.67 V	324	109.5	3.9
3	11490.00	46.4 PK	74.0	-27.6	1.84 V	86	32.2	14.2
4	11490.00	42.6 AV	54.0	-11.4	1.84 V	86	28.4	14.2
5	#17235.00	50.7 PK	68.2	-17.5	2.68 V	77	33.4	17.3

REMARKS:

1. Emission Level(dBuV/m) = Raw Value(dBuV) + Correction Factor(dB/m)
2. Correction Factor(dB/m) = Antenna Factor(dB/m) + Cable Factor(dB) – Pre-Amplifier Factor(dB)
3. Margin value = Emission Level – Limit value
4. The other emission levels were very low against the limit.
5. " * ": Fundamental frequency.
6. " # ": The radiated frequency is out of the restricted band.

CHANNEL	TX Channel 157	DETECTOR FUNCTION	Peak (PK)
FREQUENCY RANGE	1GHz ~ 40GHz		Average (AV)

ANTENNA POLARITY & TEST DISTANCE: HORIZONTAL AT 3 M

NO.	FREQ. (MHz)	EMISSION LEVEL (dBuV/m)	LIMIT (dBuV/m)	MARGIN (dB)	ANTENNA HEIGHT (m)	TABLE ANGLE (Degree)	RAW VALUE (dBuV)	CORRECTION FACTOR (dB/m)
1	*5785.00	113.4 PK			1.73 H	324	109.4	4.0
2	*5785.00	102.5 AV			1.73 H	324	98.5	4.0
3	11570.00	46.2 PK	74.0	-27.8	1.69 H	143	32.0	14.2
4	11570.00	43.1 AV	54.0	-10.9	1.69 H	143	28.9	14.2
5	#17355.00	49.8 PK	68.2	-18.4	2.50 H	18	32.1	17.7

ANTENNA POLARITY & TEST DISTANCE: VERTICAL AT 3 M

NO.	FREQ. (MHz)	EMISSION LEVEL (dBuV/m)	LIMIT (dBuV/m)	MARGIN (dB)	ANTENNA HEIGHT (m)	TABLE ANGLE (Degree)	RAW VALUE (dBuV)	CORRECTION FACTOR (dB/m)
1	*5785.00	125.9 PK			1.70 V	314	121.9	4.0
2	*5785.00	113.9 AV			1.70 V	314	109.9	4.0
3	11570.00	47.7 PK	74.0	-26.3	2.34 V	40	33.5	14.2
4	11570.00	43.2 AV	54.0	-10.8	2.34 V	40	29.0	14.2
5	#17355.00	49.9 PK	68.2	-18.3	1.75 V	33	32.2	17.7

REMARKS:

1. Emission Level(dBuV/m) = Raw Value(dBuV) + Correction Factor(dB/m)
2. Correction Factor(dB/m) = Antenna Factor(dB/m) + Cable Factor(dB) – Pre-Amplifier Factor(dB)
3. Margin value = Emission Level – Limit value
4. The other emission levels were very low against the limit.
5. " * ": Fundamental frequency.
6. " # ": The radiated frequency is out of the restricted band.

CHANNEL	TX Channel 165	DETECTOR FUNCTION	Peak (PK)
FREQUENCY RANGE	1GHz ~ 40GHz		Average (AV)

ANTENNA POLARITY & TEST DISTANCE: HORIZONTAL AT 3 M

NO.	FREQ. (MHz)	EMISSION LEVEL (dBuV/m)	LIMIT (dBuV/m)	MARGIN (dB)	ANTENNA HEIGHT (m)	TABLE ANGLE (Degree)	RAW VALUE (dBuV)	CORRECTION FACTOR (dB/m)
1	*5825.00	114.5 PK			1.89 H	53	110.3	4.2
2	*5825.00	105.5 AV			1.89 H	53	101.3	4.2
3	11650.00	47.4 PK	74.0	-26.6	1.32 H	272	33.5	13.9
4	11650.00	43.0 AV	54.0	-11.0	1.32 H	272	29.1	13.9
5	#17475.00	49.7 PK	68.2	-18.5	1.32 H	290	30.9	18.8

ANTENNA POLARITY & TEST DISTANCE: VERTICAL AT 3 M

NO.	FREQ. (MHz)	EMISSION LEVEL (dBuV/m)	LIMIT (dBuV/m)	MARGIN (dB)	ANTENNA HEIGHT (m)	TABLE ANGLE (Degree)	RAW VALUE (dBuV)	CORRECTION FACTOR (dB/m)
1	*5825.00	125.8 PK			1.62 V	337	121.6	4.2
2	*5825.00	113.8 AV			1.62 V	337	109.6	4.2
3	11650.00	46.5 PK	74.0	-27.5	2.32 V	155	32.6	13.9
4	11650.00	43.8 AV	54.0	-10.2	2.32 V	155	29.9	13.9
5	#17475.00	49.6 PK	68.2	-18.6	1.20 V	157	30.8	18.8

REMARKS:

1. Emission Level(dBuV/m) = Raw Value(dBuV) + Correction Factor(dB/m)
2. Correction Factor(dB/m) = Antenna Factor(dB/m) + Cable Factor(dB) – Pre-Amplifier Factor(dB)
3. Margin value = Emission Level – Limit value
4. The other emission levels were very low against the limit.
5. " * ": Fundamental frequency.
6. " # ": The radiated frequency is out of the restricted band.

802.11ac (VHT20)

CHANNEL	TX Channel 36	DETECTOR FUNCTION	Peak (PK)
FREQUENCY RANGE	1GHz ~ 40GHz		Average (AV)

ANTENNA POLARITY & TEST DISTANCE: HORIZONTAL AT 3 M								
NO.	FREQ. (MHz)	EMISSION LEVEL (dBuV/m)	LIMIT (dBuV/m)	MARGIN (dB)	ANTENNA HEIGHT (m)	TABLE ANGLE (Degree)	RAW VALUE (dBuV)	CORRECTION FACTOR (dB/m)
1	4824.00	44.2 PK	74.0	-29.8	1.81 H	66	41.9	2.3
2	4824.00	43.1 AV	54.0	-10.9	1.81 H	66	40.8	2.3
3	5150.00	54.3 PK	74.0	-19.7	1.81 H	66	50.8	3.5
4	5150.00	49.8 AV	54.0	-4.2	1.81 H	66	46.3	3.5
5	*5180.00	101.4 PK			1.81 H	66	98.0	3.4
6	*5180.00	92.5 AV			1.81 H	66	89.1	3.4
7	#10360.00	46.4 PK	68.2	-21.8	1.91 H	321	33.3	13.1
8	15540.00	50.2 PK	74.0	-23.8	1.07 H	10	36.6	13.6
9	15540.00	44.6 AV	54.0	-9.4	1.07 H	10	31.0	13.6

ANTENNA POLARITY & TEST DISTANCE: VERTICAL AT 3 M								
NO.	FREQ. (MHz)	EMISSION LEVEL (dBuV/m)	LIMIT (dBuV/m)	MARGIN (dB)	ANTENNA HEIGHT (m)	TABLE ANGLE (Degree)	RAW VALUE (dBuV)	CORRECTION FACTOR (dB/m)
1	4824.00	45.6 PK	74.0	-28.4	1.55 V	330	43.3	2.3
2	4824.00	44.0 AV	54.0	-10.0	1.55 V	330	41.7	2.3
3	5150.00	60.8 PK	74.0	-13.2	1.55 V	330	57.3	3.5
4	5150.00	52.9 AV	54.0	-1.1	1.55 V	330	49.4	3.5
5	*5180.00	110.7 PK			1.55 V	330	107.3	3.4
6	*5180.00	100.5 AV			1.55 V	330	97.1	3.4
7	#10360.00	47.2 PK	68.2	-21.0	2.10 V	10	34.1	13.1
8	15540.00	49.9 PK	74.0	-24.1	1.96 V	327	36.3	13.6
9	15540.00	45.8 AV	54.0	-8.2	1.96 V	327	32.2	13.6

REMARKS:

1. Emission Level(dBuV/m) = Raw Value(dBuV) + Correction Factor(dB/m)
2. Correction Factor(dB/m) = Antenna Factor(dB/m) + Cable Factor(dB) – Pre-Amplifier Factor(dB)
3. Margin value = Emission Level – Limit value
4. The other emission levels were very low against the limit.
5. " * ": Fundamental frequency.
6. " # ": The radiated frequency is out of the restricted band.

CHANNEL	TX Channel 40	DETECTOR FUNCTION	Peak (PK)
FREQUENCY RANGE	1GHz ~ 40GHz		Average (AV)

ANTENNA POLARITY & TEST DISTANCE: HORIZONTAL AT 3 M

NO.	FREQ. (MHz)	EMISSION LEVEL (dBuV/m)	LIMIT (dBuV/m)	MARGIN (dB)	ANTENNA HEIGHT (m)	TABLE ANGLE (Degree)	RAW VALUE (dBuV)	CORRECTION FACTOR (dB/m)
1	5150.00	63.2 PK	74.0	-10.8	1.07 H	159	59.7	3.5
2	5150.00	46.2 AV	54.0	-7.8	1.07 H	159	42.7	3.5
3	*5200.00	115.6 PK			1.07 H	159	112.2	3.4
4	*5200.00	101.5 AV			1.07 H	159	98.1	3.4
5	5376.00	45.6 PK	74.0	-28.4	1.07 H	159	42.2	3.4
6	5376.00	41.2 AV	54.0	-12.8	1.07 H	159	37.8	3.4
7	#10400.00	47.6 PK	68.2	-20.6	1.37 H	225	34.2	13.4
8	15600.00	50.7 PK	74.0	-23.3	1.79 H	329	37.3	13.4
9	15600.00	44.9 AV	54.0	-9.1	1.79 H	329	31.5	13.4

ANTENNA POLARITY & TEST DISTANCE: VERTICAL AT 3 M

NO.	FREQ. (MHz)	EMISSION LEVEL (dBuV/m)	LIMIT (dBuV/m)	MARGIN (dB)	ANTENNA HEIGHT (m)	TABLE ANGLE (Degree)	RAW VALUE (dBuV)	CORRECTION FACTOR (dB/m)
1	5150.00	66.3 PK	74.0	-7.7	1.51 V	23	62.8	3.5
2	5150.00	51.4 AV	54.0	-2.6	1.51 V	23	47.9	3.5
3	*5200.00	122.5 PK			1.51 V	23	119.1	3.4
4	*5200.00	111.4 AV			1.51 V	23	108.0	3.4
5	5376.00	51.9 PK	74.0	-22.1	1.51 V	23	48.5	3.4
6	5376.00	43.5 AV	54.0	-10.5	1.51 V	23	40.1	3.4
7	#10400.00	46.5 PK	68.2	-21.7	2.60 V	275	33.1	13.4
8	15600.00	50.2 PK	74.0	-23.8	2.21 V	314	36.8	13.4
9	15600.00	45.1 AV	54.0	-8.9	2.21 V	314	31.7	13.4

REMARKS:

1. Emission Level(dBuV/m) = Raw Value(dBuV) + Correction Factor(dB/m)
2. Correction Factor(dB/m) = Antenna Factor(dB/m) + Cable Factor(dB) – Pre-Amplifier Factor(dB)
3. Margin value = Emission Level – Limit value
4. The other emission levels were very low against the limit.
5. " * ": Fundamental frequency.
6. " # ": The radiated frequency is out of the restricted band.

CHANNEL	TX Channel 48	DETECTOR FUNCTION	Peak (PK)
FREQUENCY RANGE	1GHz ~ 40GHz		Average (AV)

ANTENNA POLARITY & TEST DISTANCE: HORIZONTAL AT 3 M

NO.	FREQ. (MHz)	EMISSION LEVEL (dBuV/m)	LIMIT (dBuV/m)	MARGIN (dB)	ANTENNA HEIGHT (m)	TABLE ANGLE (Degree)	RAW VALUE (dBuV)	CORRECTION FACTOR (dB/m)
1	*5240.00	114.2 PK			2.11 H	355	111.2	3.0
2	*5240.00	101.2 AV			2.11 H	355	98.2	3.0
3	5350.00	45.0 PK	74.0	-29.0	2.11 H	355	41.7	3.3
4	5350.00	41.2 AV	54.0	-12.8	2.11 H	355	37.9	3.3
5	#10480.00	47.1 PK	68.2	-21.1	2.61 H	70	33.6	13.5
6	15720.00	50.7 PK	74.0	-23.3	1.84 H	332	37.9	12.8
7	15720.00	45.8 AV	54.0	-8.2	1.84 H	332	33.0	12.8

ANTENNA POLARITY & TEST DISTANCE: VERTICAL AT 3 M

NO.	FREQ. (MHz)	EMISSION LEVEL (dBuV/m)	LIMIT (dBuV/m)	MARGIN (dB)	ANTENNA HEIGHT (m)	TABLE ANGLE (Degree)	RAW VALUE (dBuV)	CORRECTION FACTOR (dB/m)
1	*5240.00	121.8 PK			1.54 V	40	118.8	3.0
2	*5240.00	112.2 AV			1.54 V	40	109.2	3.0
3	5350.00	51.0 PK	74.0	-23.0	1.54 V	40	47.7	3.3
4	5350.00	42.0 AV	54.0	-12.0	1.54 V	40	38.7	3.3
5	#10480.00	46.5 PK	68.2	-21.7	2.63 V	120	33.0	13.5
6	15720.00	50.0 PK	74.0	-24.0	1.99 V	272	37.2	12.8
7	15720.00	45.3 AV	54.0	-8.7	1.99 V	272	32.5	12.8

REMARKS:

1. Emission Level(dBuV/m) = Raw Value(dBuV) + Correction Factor(dB/m)
2. Correction Factor(dB/m) = Antenna Factor(dB/m) + Cable Factor(dB) – Pre-Amplifier Factor(dB)
3. Margin value = Emission Level – Limit value
4. The other emission levels were very low against the limit.
5. " * ": Fundamental frequency.
6. " # ": The radiated frequency is out of the restricted band.

CHANNEL	TX Channel 149	DETECTOR FUNCTION	Peak (PK)
FREQUENCY RANGE	1GHz ~ 40GHz		Average (AV)

ANTENNA POLARITY & TEST DISTANCE: HORIZONTAL AT 3 M

NO.	FREQ. (MHz)	EMISSION LEVEL (dBuV/m)	LIMIT (dBuV/m)	MARGIN (dB)	ANTENNA HEIGHT (m)	TABLE ANGLE (Degree)	RAW VALUE (dBuV)	CORRECTION FACTOR (dB/m)
1	*5745.00	112.6 PK			2.33 H	8	108.7	3.9
2	*5745.00	99.8 AV			2.33 H	8	95.9	3.9
3	11490.00	47.0 PK	74.0	-27.0	2.66 H	220	32.8	14.2
4	11490.00	42.6 AV	54.0	-11.4	2.66 H	220	28.4	14.2
5	#17235.00	49.5 PK	68.2	-18.7	2.67 H	34	32.2	17.3

ANTENNA POLARITY & TEST DISTANCE: VERTICAL AT 3 M

NO.	FREQ. (MHz)	EMISSION LEVEL (dBuV/m)	LIMIT (dBuV/m)	MARGIN (dB)	ANTENNA HEIGHT (m)	TABLE ANGLE (Degree)	RAW VALUE (dBuV)	CORRECTION FACTOR (dB/m)
1	*5745.00	125.6 PK			1.67 V	344	121.7	3.9
2	*5745.00	104.7 AV			1.67 V	344	100.8	3.9
3	11490.00	46.9 PK	74.0	-27.1	2.39 V	59	32.7	14.2
4	11490.00	42.2 AV	54.0	-11.8	2.39 V	59	28.0	14.2
5	#17235.00	49.9 PK	68.2	-18.3	2.59 V	2	32.6	17.3

REMARKS:

1. Emission Level(dBuV/m) = Raw Value(dBuV) + Correction Factor(dB/m)
2. Correction Factor(dB/m) = Antenna Factor(dB/m) + Cable Factor(dB) – Pre-Amplifier Factor(dB)
3. Margin value = Emission Level – Limit value
4. The other emission levels were very low against the limit.
5. " * ": Fundamental frequency.
6. " # ": The radiated frequency is out of the restricted band.

CHANNEL	TX Channel 157	DETECTOR FUNCTION	Peak (PK)
FREQUENCY RANGE	1GHz ~ 40GHz		Average (AV)

ANTENNA POLARITY & TEST DISTANCE: HORIZONTAL AT 3 M

NO.	FREQ. (MHz)	EMISSION LEVEL (dBuV/m)	LIMIT (dBuV/m)	MARGIN (dB)	ANTENNA HEIGHT (m)	TABLE ANGLE (Degree)	RAW VALUE (dBuV)	CORRECTION FACTOR (dB/m)
1	*5785.00	114.7 PK			1.26 H	349	110.7	4.0
2	*5785.00	101.5 AV			1.26 H	349	97.5	4.0
3	11570.00	47.9 PK	74.0	-26.1	2.37 H	144	33.7	14.2
4	11570.00	43.6 AV	54.0	-10.4	2.37 H	144	29.4	14.2
5	#17355.00	50.6 PK	68.2	-17.6	1.37 H	259	32.9	17.7

ANTENNA POLARITY & TEST DISTANCE: VERTICAL AT 3 M

NO.	FREQ. (MHz)	EMISSION LEVEL (dBuV/m)	LIMIT (dBuV/m)	MARGIN (dB)	ANTENNA HEIGHT (m)	TABLE ANGLE (Degree)	RAW VALUE (dBuV)	CORRECTION FACTOR (dB/m)
1	*5785.00	125.7 PK			1.69 V	331	121.7	4.0
2	*5785.00	104.7 AV			1.69 V	331	100.7	4.0
3	11570.00	46.7 PK	74.0	-27.3	2.66 V	265	32.5	14.2
4	11570.00	42.3 AV	54.0	-11.7	2.66 V	265	28.1	14.2
5	#17355.00	50.6 PK	68.2	-17.6	1.46 V	97	32.9	17.7

REMARKS:

1. Emission Level(dBuV/m) = Raw Value(dBuV) + Correction Factor(dB/m)
2. Correction Factor(dB/m) = Antenna Factor(dB/m) + Cable Factor(dB) – Pre-Amplifier Factor(dB)
3. Margin value = Emission Level – Limit value
4. The other emission levels were very low against the limit.
5. " * ": Fundamental frequency.
6. " # ": The radiated frequency is out of the restricted band.

CHANNEL	TX Channel 165	DETECTOR FUNCTION	Peak (PK)
FREQUENCY RANGE	1GHz ~ 40GHz		Average (AV)

ANTENNA POLARITY & TEST DISTANCE: HORIZONTAL AT 3 M

NO.	FREQ. (MHz)	EMISSION LEVEL (dBuV/m)	LIMIT (dBuV/m)	MARGIN (dB)	ANTENNA HEIGHT (m)	TABLE ANGLE (Degree)	RAW VALUE (dBuV)	CORRECTION FACTOR (dB/m)
1	*5825.00	113.9 PK			2.41 H	155	109.7	4.2
2	*5825.00	100.5 AV			2.41 H	155	96.3	4.2
3	11650.00	47.7 PK	74.0	-26.3	2.18 H	4	33.8	13.9
4	11650.00	43.3 AV	54.0	-10.7	2.18 H	4	29.4	13.9
5	#17475.00	49.2 PK	68.2	-19.0	1.30 H	70	30.4	18.8

ANTENNA POLARITY & TEST DISTANCE: VERTICAL AT 3 M

NO.	FREQ. (MHz)	EMISSION LEVEL (dBuV/m)	LIMIT (dBuV/m)	MARGIN (dB)	ANTENNA HEIGHT (m)	TABLE ANGLE (Degree)	RAW VALUE (dBuV)	CORRECTION FACTOR (dB/m)
1	*5825.00	125.5 PK			1.71 V	343	121.3	4.2
2	*5825.00	104.3 AV			1.71 V	343	100.1	4.2
3	11650.00	46.9 PK	74.0	-27.1	2.65 V	149	33.0	13.9
4	11650.00	42.2 AV	54.0	-11.8	2.65 V	149	28.3	13.9
5	#17475.00	49.3 PK	68.2	-18.9	2.07 V	5	30.5	18.8

REMARKS:

1. Emission Level(dBuV/m) = Raw Value(dBuV) + Correction Factor(dB/m)
2. Correction Factor(dB/m) = Antenna Factor(dB/m) + Cable Factor(dB) – Pre-Amplifier Factor(dB)
3. Margin value = Emission Level – Limit value
4. The other emission levels were very low against the limit.
5. " * ": Fundamental frequency.
6. " # ": The radiated frequency is out of the restricted band.

802.11ac (VHT40)

CHANNEL	TX Channel 38	DETECTOR FUNCTION	Peak (PK)
FREQUENCY RANGE	1GHz ~ 40GHz		Average (AV)

ANTENNA POLARITY & TEST DISTANCE: HORIZONTAL AT 3 M

NO.	FREQ. (MHz)	EMISSION LEVEL (dBuV/m)	LIMIT (dBuV/m)	MARGIN (dB)	ANTENNA HEIGHT (m)	TABLE ANGLE (Degree)	RAW VALUE (dBuV)	CORRECTION FACTOR (dB/m)
1	5150.00	54.2 PK	74.0	-19.8	2.56 H	220	50.7	3.5
2	5150.00	51.1 AV	54.0	-2.9	2.56 H	220	47.6	3.5
3	*5190.00	105.2 PK			2.56 H	220	101.8	3.4
4	*5190.00	95.4 AV			2.56 H	220	92.0	3.4
5	#10380.00	47.7 PK	68.2	-20.5	1.46 H	43	34.4	13.3
6	15570.00	49.4 PK	74.0	-24.6	2.32 H	346	36.0	13.4
7	15570.00	45.3 AV	54.0	-8.7	2.32 H	346	31.9	13.4

ANTENNA POLARITY & TEST DISTANCE: VERTICAL AT 3 M

NO.	FREQ. (MHz)	EMISSION LEVEL (dBuV/m)	LIMIT (dBuV/m)	MARGIN (dB)	ANTENNA HEIGHT (m)	TABLE ANGLE (Degree)	RAW VALUE (dBuV)	CORRECTION FACTOR (dB/m)
1	5150.00	63.9 PK	74.0	-10.1	1.63 V	7	60.4	3.5
2	5150.00	52.2 AV	54.0	-1.8	1.63 V	7	48.7	3.5
3	*5190.00	114.3 PK			1.63 V	7	110.9	3.4
4	*5190.00	103.7 AV			1.63 V	7	100.3	3.4
5	#10380.00	46.5 PK	68.2	-21.7	1.83 V	325	33.2	13.3
6	15570.00	49.8 PK	74.0	-24.2	1.80 V	42	36.4	13.4
7	15570.00	45.0 AV	54.0	-9.0	1.80 V	42	31.6	13.4

REMARKS:

- Emission Level(dBuV/m) = Raw Value(dBuV) + Correction Factor(dB/m)
- Correction Factor(dB/m) = Antenna Factor(dB/m) + Cable Factor(dB) – Pre-Amplifier Factor(dB)
- Margin value = Emission Level – Limit value
- The other emission levels were very low against the limit.
- " * ": Fundamental frequency.
- " # ": The radiated frequency is out of the restricted band.

CHANNEL	TX Channel 46	DETECTOR FUNCTION	Peak (PK)
FREQUENCY RANGE	1GHz ~ 40GHz		Average (AV)

ANTENNA POLARITY & TEST DISTANCE: HORIZONTAL AT 3 M

NO.	FREQ. (MHz)	EMISSION LEVEL (dBuV/m)	LIMIT (dBuV/m)	MARGIN (dB)	ANTENNA HEIGHT (m)	TABLE ANGLE (Degree)	RAW VALUE (dBuV)	CORRECTION FACTOR (dB/m)
1	*5230.00	112.4 PK			2.58 H	22	109.3	3.1
2	*5230.00	107.5 AV			2.58 H	22	104.4	3.1
3	5350.00	59.2 PK	74.0	-14.8	2.58 H	22	55.9	3.3
4	5350.00	49.7 AV	54.0	-4.3	2.58 H	22	46.4	3.3
5	#10460.00	46.8 PK	68.2	-21.4	1.42 H	53	33.3	13.5
6	15690.00	50.0 PK	74.0	-24.0	1.22 H	261	37.1	12.9
7	15690.00	44.4 AV	54.0	-9.6	1.22 H	261	31.5	12.9

ANTENNA POLARITY & TEST DISTANCE: VERTICAL AT 3 M

NO.	FREQ. (MHz)	EMISSION LEVEL (dBuV/m)	LIMIT (dBuV/m)	MARGIN (dB)	ANTENNA HEIGHT (m)	TABLE ANGLE (Degree)	RAW VALUE (dBuV)	CORRECTION FACTOR (dB/m)
1	*5230.00	120.0 PK			2.07 V	1	116.9	3.1
2	*5230.00	108.6 AV			2.07 V	1	105.5	3.1
3	5350.00	64.2 PK	74.0	-9.8	2.07 V	1	60.9	3.3
4	5350.00	52.3 AV	54.0	-1.7	2.07 V	1	49.0	3.3
5	#10460.00	47.8 PK	68.2	-20.4	1.50 V	191	34.3	13.5
6	15690.00	50.1 PK	74.0	-23.9	2.01 V	104	37.2	12.9
7	15690.00	45.1 AV	54.0	-8.9	2.01 V	104	32.2	12.9

REMARKS:

1. Emission Level(dBuV/m) = Raw Value(dBuV) + Correction Factor(dB/m)
2. Correction Factor(dB/m) = Antenna Factor(dB/m) + Cable Factor(dB) – Pre-Amplifier Factor(dB)
3. Margin value = Emission Level – Limit value
4. The other emission levels were very low against the limit.
5. " * ": Fundamental frequency.
6. " # ": The radiated frequency is out of the restricted band.

CHANNEL	TX Channel 151	DETECTOR FUNCTION	Peak (PK)
FREQUENCY RANGE	1GHz ~ 40GHz		Average (AV)

ANTENNA POLARITY & TEST DISTANCE: HORIZONTAL AT 3 M

NO.	FREQ. (MHz)	EMISSION LEVEL (dBuV/m)	LIMIT (dBuV/m)	MARGIN (dB)	ANTENNA HEIGHT (m)	TABLE ANGLE (Degree)	RAW VALUE (dBuV)	CORRECTION FACTOR (dB/m)
1	*5755.00	109.7 PK			1.76 H	347	105.8	3.9
2	*5755.00	98.7 AV			1.76 H	347	94.8	3.9
3	11510.00	47.9 PK	74.0	-26.1	1.14 H	326	33.7	14.2
4	11510.00	42.4 AV	54.0	-11.6	1.14 H	326	28.2	14.2
5	#17265.00	50.9 PK	68.2	-17.3	1.90 H	109	33.7	17.2

ANTENNA POLARITY & TEST DISTANCE: VERTICAL AT 3 M

NO.	FREQ. (MHz)	EMISSION LEVEL (dBuV/m)	LIMIT (dBuV/m)	MARGIN (dB)	ANTENNA HEIGHT (m)	TABLE ANGLE (Degree)	RAW VALUE (dBuV)	CORRECTION FACTOR (dB/m)
1	*5755.00	115.8 PK			1.50 V	27	111.9	3.9
2	*5755.00	105.9 AV			1.50 V	27	102.0	3.9
3	11510.00	47.4 PK	74.0	-26.6	1.71 V	147	33.2	14.2
4	11510.00	42.3 AV	54.0	-11.7	1.71 V	147	28.1	14.2
5	#17265.00	49.5 PK	68.2	-18.7	2.00 V	83	32.3	17.2

REMARKS:

1. Emission Level(dBuV/m) = Raw Value(dBuV) + Correction Factor(dB/m)
2. Correction Factor(dB/m) = Antenna Factor(dB/m) + Cable Factor(dB) – Pre-Amplifier Factor(dB)
3. Margin value = Emission Level – Limit value
4. The other emission levels were very low against the limit.
5. " * ": Fundamental frequency.
6. " # ": The radiated frequency is out of the restricted band.

CHANNEL	TX Channel 159	DETECTOR FUNCTION	Peak (PK)
FREQUENCY RANGE	1GHz ~ 40GHz		Average (AV)

ANTENNA POLARITY & TEST DISTANCE: HORIZONTAL AT 3 M

NO.	FREQ. (MHz)	EMISSION LEVEL (dBuV/m)	LIMIT (dBuV/m)	MARGIN (dB)	ANTENNA HEIGHT (m)	TABLE ANGLE (Degree)	RAW VALUE (dBuV)	CORRECTION FACTOR (dB/m)
1	*5795.00	108.9 PK			1.82 H	360	104.9	4.0
2	*5795.00	98.0 AV			1.82 H	360	94.0	4.0
3	11590.00	46.1 PK	74.0	-27.9	1.42 H	46	31.9	14.2
4	11590.00	43.6 AV	54.0	-10.4	1.42 H	46	29.4	14.2
5	#17385.00	49.9 PK	68.2	-18.3	1.08 H	161	32.1	17.8

ANTENNA POLARITY & TEST DISTANCE: VERTICAL AT 3 M

NO.	FREQ. (MHz)	EMISSION LEVEL (dBuV/m)	LIMIT (dBuV/m)	MARGIN (dB)	ANTENNA HEIGHT (m)	TABLE ANGLE (Degree)	RAW VALUE (dBuV)	CORRECTION FACTOR (dB/m)
1	*5795.00	116.1 PK			1.52 V	35	112.1	4.0
2	*5795.00	106.2 AV			1.52 V	35	102.2	4.0
3	11590.00	47.8 PK	74.0	-26.2	1.79 V	200	33.6	14.2
4	11590.00	42.4 AV	54.0	-11.6	1.79 V	200	28.2	14.2
5	#17385.00	50.6 PK	68.2	-17.6	2.36 V	293	32.8	17.8

REMARKS:

1. Emission Level(dBuV/m) = Raw Value(dBuV) + Correction Factor(dB/m)
2. Correction Factor(dB/m) = Antenna Factor(dB/m) + Cable Factor(dB) – Pre-Amplifier Factor(dB)
3. Margin value = Emission Level – Limit value
4. The other emission levels were very low against the limit.
5. " * ": Fundamental frequency.
6. " # ": The radiated frequency is out of the restricted band.

802.11ac (VHT80)

CHANNEL	TX Channel 42	DETECTOR FUNCTION	Peak (PK)
FREQUENCY RANGE	1GHz ~ 40GHz		Average (AV)

ANTENNA POLARITY & TEST DISTANCE: HORIZONTAL AT 3 M

NO.	FREQ. (MHz)	EMISSION LEVEL (dBuV/m)	LIMIT (dBuV/m)	MARGIN (dB)	ANTENNA HEIGHT (m)	TABLE ANGLE (Degree)	RAW VALUE (dBuV)	CORRECTION FACTOR (dB/m)
1	5150.00	54.2 PK	74.0	-19.8	2.28 H	93	50.7	3.5
2	5150.00	50.1 AV	54.0	-3.9	2.28 H	93	46.6	3.5
3	*5210.00	108.6 PK			2.28 H	93	105.3	3.3
4	*5210.00	94.6 AV			2.28 H	93	91.3	3.3
5	5350.00	50.1 PK	74.0	-23.9	2.28 H	93	46.8	3.3
6	5350.00	44.2 AV	54.0	-9.8	2.28 H	93	40.9	3.3
7	#10420.00	46.6 PK	68.2	-21.6	1.35 H	350	33.1	13.5
8	15630.00	50.3 PK	74.0	-23.7	1.88 H	75	37.1	13.2
9	15630.00	45.8 AV	54.0	-8.2	1.88 H	75	32.6	13.2

ANTENNA POLARITY & TEST DISTANCE: VERTICAL AT 3 M

NO.	FREQ. (MHz)	EMISSION LEVEL (dBuV/m)	LIMIT (dBuV/m)	MARGIN (dB)	ANTENNA HEIGHT (m)	TABLE ANGLE (Degree)	RAW VALUE (dBuV)	CORRECTION FACTOR (dB/m)
1	5150.00	60.9 PK	74.0	-13.1	1.48 V	2	57.4	3.5
2	5150.00	52.8 AV	54.0	-1.2	1.48 V	2	49.3	3.5
3	*5210.00	114.2 PK			1.48 V	2	110.9	3.3
4	*5210.00	100.8 AV			1.48 V	2	97.5	3.3
5	5350.00	56.0 PK	74.0	-18.0	1.48 V	2	52.7	3.3
6	5350.00	45.1 AV	54.0	-8.9	1.48 V	2	41.8	3.3
7	#10420.00	47.6 PK	68.2	-20.6	1.40 V	168	34.1	13.5
8	15630.00	50.2 PK	74.0	-23.8	1.99 V	64	37.0	13.2
9	15630.00	45.4 AV	54.0	-8.6	1.99 V	64	32.2	13.2

REMARKS:

- Emission Level(dBuV/m) = Raw Value(dBuV) + Correction Factor(dB/m)
- Correction Factor(dB/m) = Antenna Factor(dB/m) + Cable Factor(dB) – Pre-Amplifier Factor(dB)
- Margin value = Emission Level – Limit value
- The other emission levels were very low against the limit.
- " * ": Fundamental frequency.
- " # ": The radiated frequency is out of the restricted band.

CHANNEL	TX Channel 155	DETECTOR FUNCTION	Peak (PK)
FREQUENCY RANGE	1GHz ~ 40GHz		Average (AV)

ANTENNA POLARITY & TEST DISTANCE: HORIZONTAL AT 3 M

NO.	FREQ. (MHz)	EMISSION LEVEL (dBuV/m)	LIMIT (dBuV/m)	MARGIN (dB)	ANTENNA HEIGHT (m)	TABLE ANGLE (Degree)	RAW VALUE (dBuV)	CORRECTION FACTOR (dB/m)
1	*5775.00	110.7 PK			2.41 H	240	106.8	3.9
2	*5775.00	101.4 AV			2.41 H	240	97.5	3.9
3	11550.00	47.7 PK	74.0	-26.3	2.39 H	296	33.5	14.2
4	11550.00	43.7 AV	54.0	-10.3	2.39 H	296	29.5	14.2
5	#17325.00	50.8 PK	68.2	-17.4	1.08 H	22	33.4	17.4

ANTENNA POLARITY & TEST DISTANCE: VERTICAL AT 3 M

NO.	FREQ. (MHz)	EMISSION LEVEL (dBuV/m)	LIMIT (dBuV/m)	MARGIN (dB)	ANTENNA HEIGHT (m)	TABLE ANGLE (Degree)	RAW VALUE (dBuV)	CORRECTION FACTOR (dB/m)
1	*5775.00	117.2 PK			1.36 V	360	113.3	3.9
2	*5775.00	105.4 AV			1.36 V	360	101.5	3.9
3	11550.00	46.1 PK	74.0	-27.9	2.29 V	207	31.9	14.2
4	11550.00	42.3 AV	54.0	-11.7	2.29 V	207	28.1	14.2
5	#17325.00	50.2 PK	68.2	-18.0	2.48 V	158	32.8	17.4

REMARKS:

1. Emission Level(dBuV/m) = Raw Value(dBuV) + Correction Factor(dB/m)
2. Correction Factor(dB/m) = Antenna Factor(dB/m) + Cable Factor(dB) – Pre-Amplifier Factor(dB)
3. Margin value = Emission Level – Limit value
4. The other emission levels were very low against the limit.
5. " * ": Fundamental frequency.
6. " # ": The radiated frequency is out of the restricted band.

Below 1GHz Data:

802.11a

CHANNEL	TX Channel 149	DETECTOR FUNCTION	Quasi-Peak (QP)
FREQUENCY RANGE	30MHz ~ 1GHz		

ANTENNA POLARITY & TEST DISTANCE: HORIZONTAL AT 3 M								
NO.	FREQ. (MHz)	EMISSION LEVEL (dBuV/m)	LIMIT (dBuV/m)	MARGIN (dB)	ANTENNA HEIGHT (m)	TABLE ANGLE (Degree)	RAW VALUE (dBuV)	CORRECTION FACTOR (dB/m)
1	58.76	33.3 QP	40.0	-6.7	3.00 H	230	42.0	-8.7
2	146.79	33.9 QP	43.5	-9.6	2.00 H	36	41.7	-7.8
3	249.32	31.4 QP	46.0	-14.6	1.00 H	360	40.0	-8.6
4	471.50	29.8 QP	46.0	-16.2	1.00 H	360	32.0	-2.2
5	734.63	33.7 QP	46.0	-12.3	3.00 H	201	30.3	3.4
6	854.16	36.0 QP	46.0	-10.0	3.00 H	77	30.9	5.1

REMARKS:

1. Emission Level(dBuV/m) = Raw Value(dBuV) + Correction Factor(dB/m)
2. Correction Factor(dB/m) = Antenna Factor(dB/m) + Cable Factor(dB) – Pre-Amplifier Factor(dB)
3. Margin value = Emission Level – Limit value
4. The other emission levels were very low against the limit of frequency range 30MHz~1000MHz.
5. The emission levels were very low against the limit of frequency range 9kHz~30MHz: the amplitude of spurious emissions attenuated more than 20 dB below the permissible value to be report.

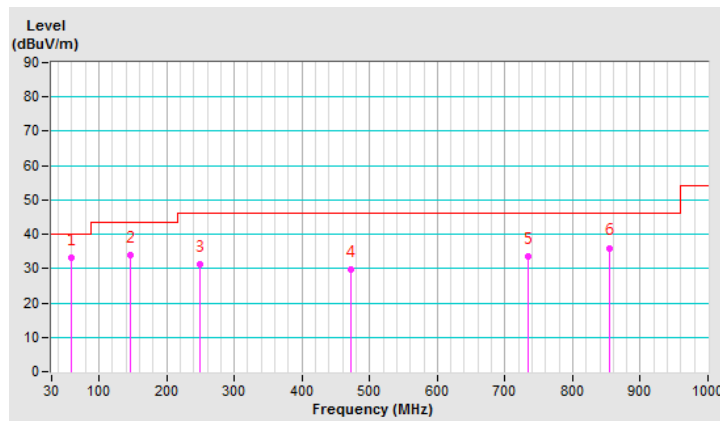

CHANNEL	TX Channel 149	DETECTOR FUNCTION	Quasi-Peak (QP)
FREQUENCY RANGE	30MHz ~ 1GHz		

ANTENNA POLARITY & TEST DISTANCE: VERTICAL AT 3 M

NO.	FREQ. (MHz)	EMISSION LEVEL (dBuV/m)	LIMIT (dBuV/m)	MARGIN (dB)	ANTENNA HEIGHT (m)	TABLE ANGLE (Degree)	RAW VALUE (dBuV)	CORRECTION FACTOR (dB/m)
1	39.68	37.0 QP	40.0	-3.0	1.00 V	326	45.7	-8.7
2	53.79	35.7 QP	40.0	-4.3	2.00 V	158	44.0	-8.3
3	146.84	26.9 QP	43.5	-16.6	3.00 V	360	34.6	-7.7
4	249.61	27.1 QP	46.0	-18.9	1.00 V	360	35.7	-8.6
5	800.69	34.9 QP	46.0	-11.1	4.00 V	64	30.8	4.1
6	868.78	37.4 QP	46.0	-8.6	3.00 V	212	31.9	5.5

REMARKS:

1. Emission Level(dBuV/m) = Raw Value(dBuV) + Correction Factor(dB/m)
2. Correction Factor(dB/m) = Antenna Factor(dB/m) + Cable Factor(dB) – Pre-Amplifier Factor(dB)
3. Margin value = Emission Level – Limit value
4. The other emission levels were very low against the limit of frequency range 30MHz~1000MHz.
5. The emission levels were very low against the limit of frequency range 9kHz~30MHz: the amplitude of spurious emissions attenuated more than 20 dB below the permissible value to be report.

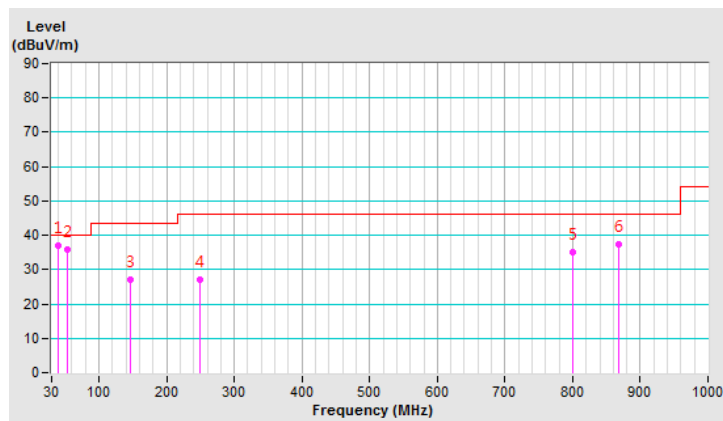

4.2 Conducted Emission Measurement

4.2.1 Limits of Conducted Emission Measurement

Frequency (MHz)	Conducted Limit (dBuV)	
	Quasi-peak	Average
0.15 - 0.5	66 - 56	56 - 46
0.50 - 5.0	56	46
5.0 - 30.0	60	50

Note: 1. The lower limit shall apply at the transition frequencies.

2. The limit decreases in line with the logarithm of the frequency in the range of 0.15 to 0.50MHz.

4.2.2 Test Instruments

DESCRIPTION & MANUFACTURER	MODEL NO.	SERIAL NO.	CALIBRATED DATE	CALIBRATED UNTIL
Test Receiver R&S	ESCS 30	847124/029	Oct. 23, 2019	Oct. 22, 2020
Line-Impedance Stabilization Network (for EUT) R&S	ESH3-Z5	848773/004	Oct. 23, 2019	Oct. 22, 2020
Line-Impedance Stabilization Network (for Peripheral) R&S	ESH3-Z5	835239/001	Mar. 17, 2019	Mar. 16, 2020
50 ohms Terminator	50	3	Oct. 23, 2019	Oct. 22, 2020
RF Cable	5D-FB	COCCAB-001	Sep. 27, 2019	Sep. 26, 2020
Fixed attenuator EMCI	STI02-2200-10	003	Mar. 14, 2019	Mar. 13, 2020
Software BVADT	BVADT_Cond_V7.3.7.4	NA	NA	NA

Note:

1. The calibration interval of the above test instruments are 12 months and the calibrations are traceable to NML/ROC and NIST/USA.
2. The test was performed in Conduction 1.
- 3 Tested Date: Nov. 23, 2019

4.2.3 Test Procedure

- The EUT was placed 0.4 meters from the conducting wall of the shielded room with EUT being connected to the power mains through a line impedance stabilization network (LISN). Other support units were connected to the power mains through another LISN. The two LISNs provide 50 ohm/ 50uH of coupling impedance for the measuring instrument.
- Both lines of the power mains connected to the EUT were checked for maximum conducted interference.
- The frequency range from 150kHz to 30MHz was searched. Emission levels under (Limit - 20dB) was not recorded.

NOTE: All modes of operation were investigated and the worst-case emissions are reported.

4.2.4 Deviation from Test Standard

No deviation.

4.2.5 Test Setup

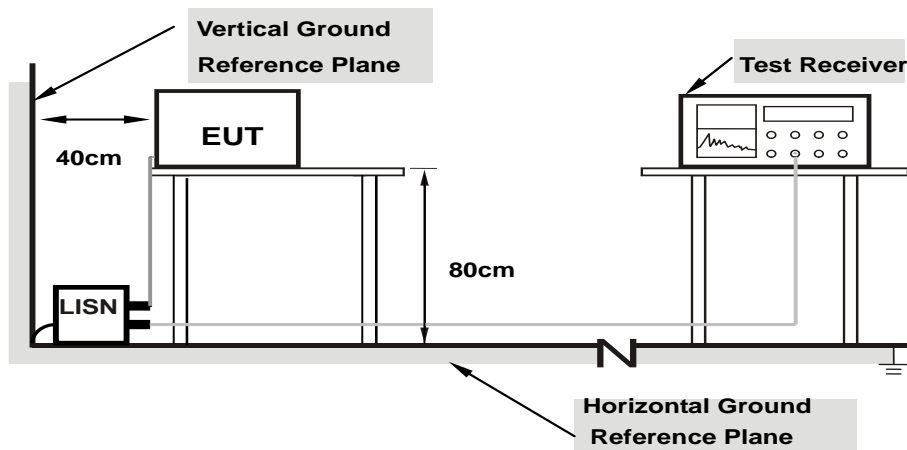

Note: 1.Support units were connected to second LISN.

For the actual test configuration, please refer to the attached file (Test Setup Photo).

4.2.6 EUT Operating Condition

Same as 4.1.6.

4.2.7 Test Results

Phase	Line (L)	Detector Function	Quasi-Peak (QP) / Average (AV)
-------	----------	-------------------	--------------------------------

No	Freq. [MHz]	Corr.	Reading Value		Emission Level		Limit		Margin	
		Factor (dB)	[dB (uV)]		[dB (uV)]		[dB (uV)]		(dB)	
			Q.P.	AV.	Q.P.	AV.	Q.P.	AV.	Q.P.	AV.
1	0.15000	9.99	31.88	17.11	41.87	27.10	66.00	56.00	-24.13	-28.90
2	0.18125	9.99	27.90	13.00	37.89	22.99	64.43	54.43	-26.54	-31.44
3	0.22422	9.99	26.52	13.01	36.51	23.00	62.66	52.66	-26.15	-29.66
4	0.47422	10.01	34.24	28.38	44.25	38.39	56.44	46.44	-12.19	-8.05
5	0.50938	10.01	30.27	24.98	40.28	34.99	56.00	46.00	-15.72	-11.01
6	25.76953	11.58	20.38	13.36	31.96	24.94	60.00	50.00	-28.04	-25.06

REMARKS:

1. Q.P. and AV. are abbreviations of quasi-peak and average individually.
2. The emission levels of other frequencies were very low against the limit.
3. Margin value = Emission level - Limit value
4. Correction factor = Insertion loss + Cable loss
5. Emission Level = Correction Factor + Reading Value.

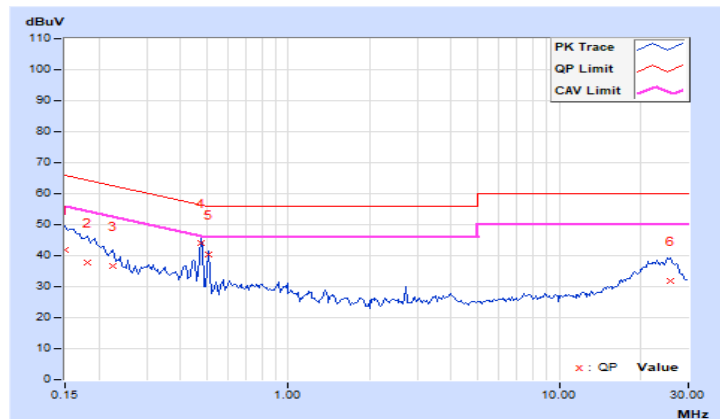

Phase	Neutral (N)	Detector Function	Quasi-Peak (QP) / Average (AV)
-------	-------------	-------------------	--------------------------------

No	Freq. [MHz]	Corr. Factor	Reading Value [dB (uV)]		Emission Level [dB (uV)]		Limit [dB (uV)]		Margin (dB)	
		(dB)	Q.P.	AV.	Q.P.	AV.	Q.P.	AV.	Q.P.	AV.
	1	0.16172	9.99	36.91	20.67	46.90	30.66	65.38	55.38	-18.48
2	0.19297	9.99	32.84	16.17	42.83	26.16	63.91	53.91	-21.08	-27.75
3	0.22422	9.99	29.60	12.40	39.59	22.39	62.66	52.66	-23.07	-30.27
4	0.47813	10.02	30.11	25.33	40.13	35.35	56.37	46.37	-16.24	-11.02
5	0.51328	10.02	29.67	21.06	39.69	31.08	56.00	46.00	-16.31	-14.92
6	25.96094	11.25	20.79	13.90	32.04	25.15	60.00	50.00	-27.96	-24.85

REMARKS:

1. Q.P. and AV. are abbreviations of quasi-peak and average individually.
2. The emission levels of other frequencies were very low against the limit.
3. Margin value = Emission level - Limit value
4. Correction factor = Insertion loss + Cable loss
5. Emission Level = Correction Factor + Reading Value.

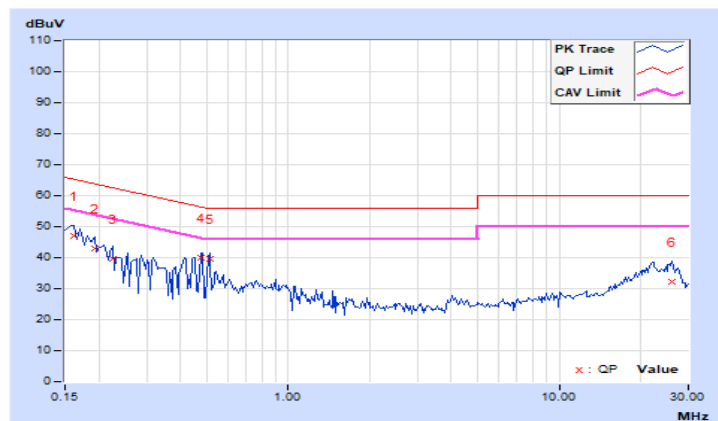

4.3 Transmit Power Measurement

4.3.1 Limits of Transmit Power Measurement

Operation Band	EUT Category		Limit
U-NII-1		Outdoor Access Point	1 Watt (30 dBm) (Max. e.i.r.p \leq 125mW(21 dBm) at any elevation angle above 30 degrees as measured from the horizon)
		Fixed point-to-point Access Point	1 Watt (30 dBm)
	√	Indoor Access Point	1 Watt (30 dBm)
		Client device	250mW (24 dBm)
U-NII-2A			250mW (24 dBm) or 11 dBm+10 log B*
U-NII-2C			250mW (24 dBm) or 11 dBm+10 log B*
U-NII-3	√		1 Watt (30 dBm)

*B is the 26 dB emission bandwidth in megahertz

Per KDB 662911 Method of conducted output power measurement on IEEE 802.11 devices,

Array Gain = 0 dB (i.e., no array gain) for $N_{ANT} \leq 4$;

Array Gain = 0 dB (i.e., no array gain) for channel widths ≥ 40 MHz for any N_{ANT} ;

Array Gain = $5 \log(N_{ANT}/N_{SS})$ dB or 3 dB, whichever is less for 20-MHz channel widths with $N_{ANT} \geq 5$.

For power measurements on all other devices: Array Gain = $10 \log(N_{ANT}/N_{SS})$ dB.

4.3.2 Test Setup

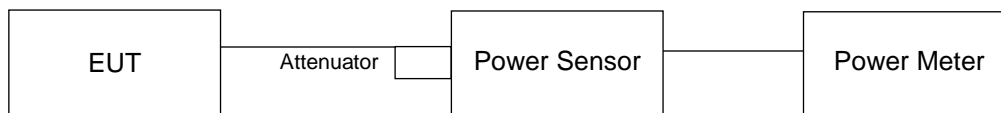

4.3.3 Test Instruments

Refer to section 4.1.2 to get information of above instrument.

4.3.4 Test Procedure

Method PM is used to perform output power measurement, trigger and gating function of wide band power meter is enabled to measure max output power of TX on burst. Duty factor is not added to measured value.

4.3.5 Deviation from Test Standard

No deviation.

4.3.6 EUT Operating Condition

The software provided by client to enable the EUT under transmission condition continuously at lowest, middle and highest channel frequencies individually.

4.3.7 Test Result

Beamforming Mode
802.11a

Chan.	Chan. Freq. (MHz)	Maximum Conducted Power (dBm)		Total Power (mW)	Total Power (dBm)	Limit (dBm)	Pass / Fail
		Chain 0	Chain 1				
36	5180	19.71	20.17	197.533	22.96	29.92	Pass
40	5200	22.87	23.33	408.92	26.12	29.92	Pass
48	5240	23.46	23.67	454.629	26.58	29.92	Pass
149	5745	25.53	24.97	671.324	28.27	29.98	Pass
157	5785	24.76	24.73	596.393	27.76	29.98	Pass
165	5825	25.13	24.93	637.009	28.04	29.98	Pass

Note: 1. For UNII-1: Directional gain = $10 \log[(10^{G0/20} + 10^{G1/20})^2 / 2] = 6.08\text{dBi} > 6\text{dBi}$, so the power limit shall be reduced to $30-(6.08-6) = 29.92\text{dBm}$.

2. For UNII-3: Directional gain = $10 \log[(10^{G0/20} + 10^{G1/20})^2 / 2] = 6.02\text{dBi} > 6\text{dBi}$, so the power limit shall be reduced to $30-(6.02-6) = 29.98\text{dBm}$.

802.11ac (VHT20)

Chan.	Chan. Freq. (MHz)	Maximum Conducted Power (dBm)		Total Power (mW)	Total Power (dBm)	Limit (dBm)	Pass / Fail
		Chain 0	Chain 1				
36	5180	19.64	20.93	215.925	23.34	29.92	Pass
40	5200	23.35	23.46	438.092	26.42	29.92	Pass
48	5240	23.59	23.68	461.906	26.65	29.92	Pass
149	5745	25.28	24.83	641.376	28.07	29.98	Pass
157	5785	24.68	24.62	583.499	27.66	29.98	Pass
165	5825	25.12	24.73	622.254	27.94	29.98	Pass

Note: 1. For UNII-1: Directional gain = $10 \log[(10^{G0/20} + 10^{G1/20})^2 / 2] = 6.08\text{dBi} > 6\text{dBi}$, so the power limit shall be reduced to $30-(6.08-6) = 29.92\text{dBm}$.

2. For UNII-3: Directional gain = $10 \log[(10^{G0/20} + 10^{G1/20})^2 / 2] = 6.02\text{dBi} > 6\text{dBi}$, so the power limit shall be reduced to $30-(6.02-6) = 29.98\text{dBm}$.

802.11ac (VHT40)

Chan.	Chan. Freq. (MHz)	Maximum Conducted Power (dBm)		Total Power (mW)	Total Power (dBm)	Limit (dBm)	Pass / Fail
		Chain 0	Chain 1				
38	5190	17.12	17.63	109.466	20.39	29.92	Pass
46	5230	21.41	21.69	285.928	24.56	29.92	Pass
151	5755	23.44	23.56	447.786	26.51	29.98	Pass
159	5795	24.98	24.45	593.387	27.73	29.98	Pass

Note: 1. For UNII-1: Directional gain = $10 \log[(10^{G0/20} + 10^{G1/20})^2 / 2] = 6.08\text{dBi} > 6\text{dBi}$, so the power limit shall be reduced to $30-(6.08-6) = 29.92\text{dBm}$.

2. For UNII-3: Directional gain = $10 \log[(10^{G0/20} + 10^{G1/20})^2 / 2] = 6.02\text{dBi} > 6\text{dBi}$, so the power limit shall be reduced to $30-(6.02-6) = 29.98\text{dBm}$.

802.11ac (VHT80)

Chan.	Chan. Freq. (MHz)	Maximum Conducted Power (dBm)		Total Power (mW)	Total Power (dBm)	Limit (dBm)	Pass / Fail
		Chain 0	Chain 1				
42	5210	16.85	17.26	101.628	20.07	29.92	Pass
155	5775	21.77	21.68	297.545	24.74	29.98	Pass

- Note:** 1. For UNII-1: Directional gain = $10 \log[(10^{G_0/20} + 10^{G_1/20})^2 / 2] = 6.08\text{dBi} > 6\text{dBi}$, so the power limit shall be reduced to $30 - (6.08 - 6) = 29.92\text{dBm}$.
2. For UNII-3: Directional gain = $10 \log[(10^{G_0/20} + 10^{G_1/20})^2 / 2] = 6.02\text{dBi} > 6\text{dBi}$, so the power limit shall be reduced to $30 - (6.02 - 6) = 29.98\text{dBm}$.

4.4 Occupied Bandwidth Measurement

4.4.1 Test Setup

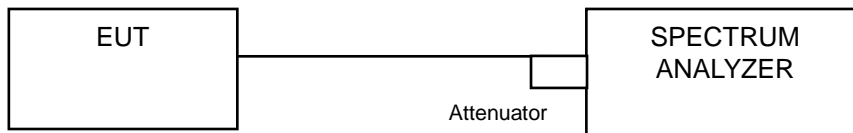

4.4.2 Test Instruments

Refer to section 4.1.2 to get information of above instrument.

4.4.3 Test Procedure

The transmitter output was connected to the spectrum analyzer through an attenuator. The bandwidth of the fundamental frequency was measured by spectrum analyzer with resolution bandwidth in the range of 1% to 5% of the anticipated emission bandwidth, and a video bandwidth at least 3x the resolution bandwidth and set the detector to SAMPLE. The width of a frequency band such that, below the lower and above the upper frequency limits, the mean powers emitted are each equal to a specified percentage 0.5% of the total mean power of a given emission.

4.4.4 Test Results

802.11a

Channel	Channel Frequency (MHz)	Occupied Bandwidth (MHz)	
		Chain 0	Chain 1
36	5180	16.56	16.56
40	5200	18.12	20.28
48	5240	19.56	18.72
149	5745	34.08	29.16
157	5785	34.56	31.44
165	5825	33.96	33.12

802.11ac (VHT20)

Channel	Channel Frequency (MHz)	Occupied Bandwidth (MHz)	
		Chain 0	Chain 1
36	5180	17.76	17.64
40	5200	23.40	23.88
48	5240	18.48	19.32
149	5745	30.48	30.84
157	5785	31.92	31.80
165	5825	32.76	32.88

802.11ac (VHT40)

Channel	Channel Frequency (MHz)	Occupied Bandwidth (MHz)	
		Chain 0	Chain 1
38	5190	36.24	36.24
46	5230	36.48	36.72
151	5755	45.12	46.56
159	5795	67.44	62.64

802.11ac (VHT80)

Channel	Channel Frequency (MHz)	Occupied Bandwidth (MHz)	
		Chain 0	Chain 1
42	5210	75.84	75.84
155	5775	76.80	77.28

Spectrum Plot of Max. Value

802.11a_Chain 0 / CH157

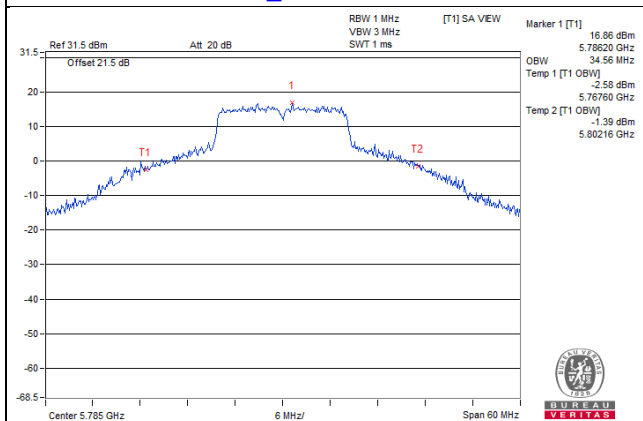

802.11ac (VHT20)_Chain 1 / CH165

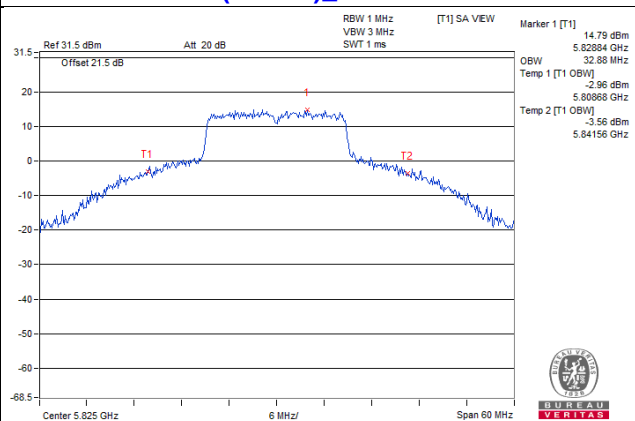

802.11ac (VHT40)_Chain 0 / CH159

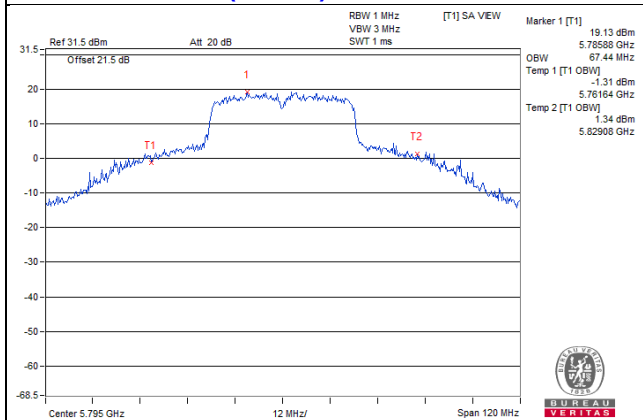

802.11ac (VHT80)_Chain 1 / CH155

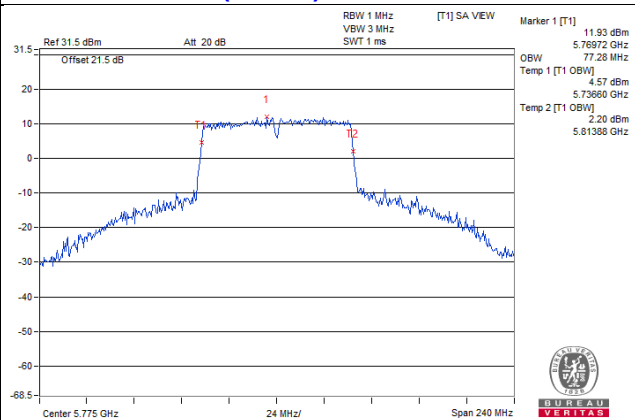

Spectrum Plot for near by DFS band
(DFS is required, if 99% OCP straddle into U-NII-2A band)

802.11a_Chain 0 / CH48

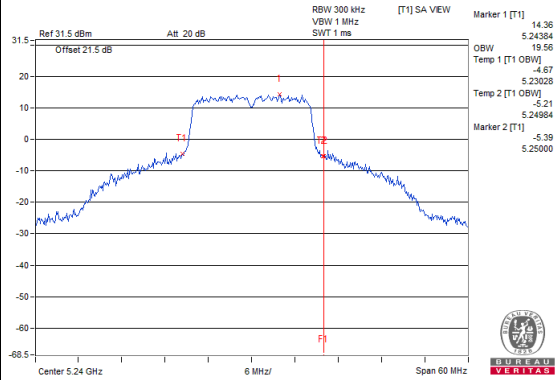

802.11a_Chain 1 / CH48

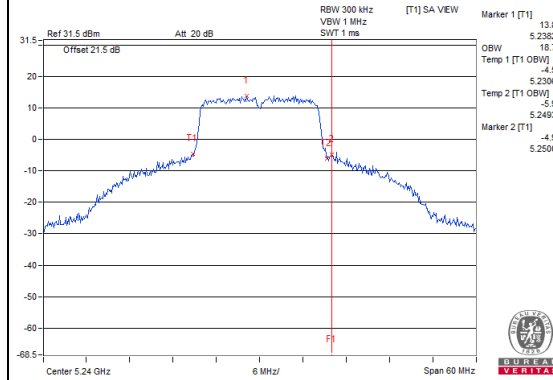

802.11ac (VHT20)_Chain 0 / CH48

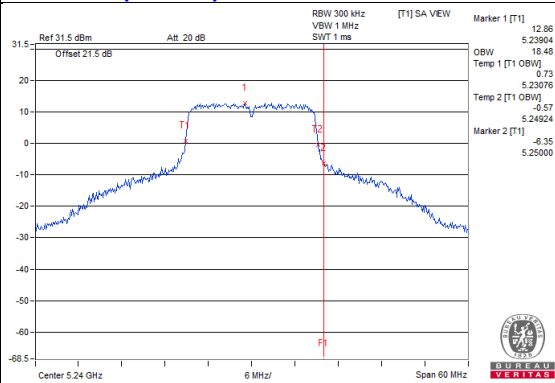

802.11ac (VHT20)_Chain 1 / CH48

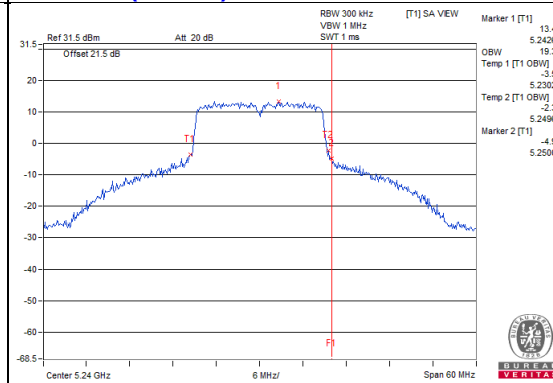

**Spectrum Plot for near by DFS band
(DFS is required, if 99% OCP straddle into U-NII-2A band)**

802.11ac (VHT40)_Chain 0 / CH46

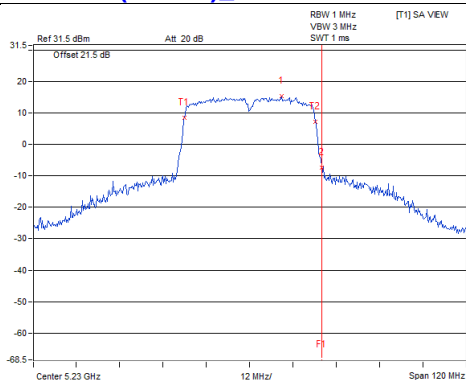

RBW 1 MHz
VBW 3 MHz
SWT 1 ms

Marker 1 [T1]
15.34 dBm
5.23888 GHz

OBW 36.48 MHz
Temp 1 [T1] OBW 5.37 dBm
5.21176 GHz
Temp 2 [T1] OBW 7.07 dBm
5.24824 GHz

Marker 2 [T1]
-7.30 dBm
5.25000 GHz

802.11ac (VHT40)_Chain 1 / CH46

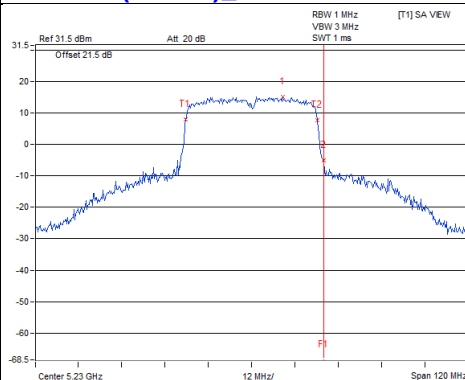

RBW 1 MHz
VBW 3 MHz
SWT 1 ms

Marker 1 [T1]
15.13 dBm
5.23964 GHz

OBW 36.72 MHz
Temp 1 [T1] OBW 7.94 dBm
5.21152 GHz
Temp 2 [T1] OBW 7.73 dBm
5.24824 GHz

Marker 2 [T1]
-5.14 dBm
5.25000 GHz

802.11ac (VHT80)_Chain 0 / CH42

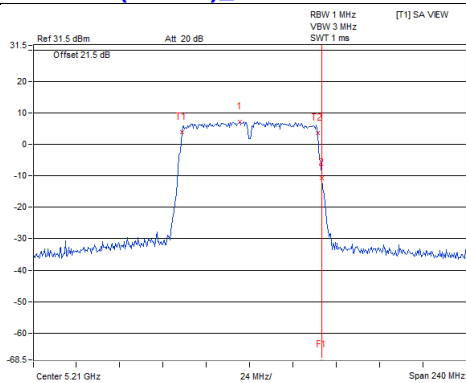

RBW 1 MHz
VBW 3 MHz
SWT 1 ms

Marker 1 [T1]
-7.27 dBm
5.20424 GHz

OBW 75.84 MHz
Temp 1 [T1] OBW 3.89 dBm
5.17208 GHz
Temp 2 [T1] OBW 3.87 dBm
5.24792 GHz

Marker 2 [T1]
-10.76 dBm
5.25000 GHz

802.11ac (VHT80)_Chain 1 / CH42

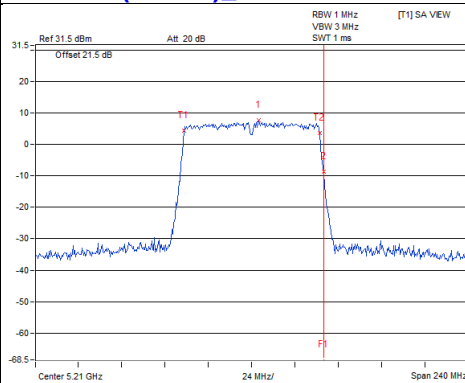

RBW 1 MHz
VBW 3 MHz
SWT 1 ms

Marker 1 [T1]
7.66 dBm
5.21354 GHz

OBW 75.84 MHz
Temp 1 [T1] OBW 4.37 dBm
5.17208 GHz
Temp 2 [T1] OBW 3.56 dBm
5.24792 GHz

Marker 2 [T1]
-6.68 dBm
5.25000 GHz

**Spectrum Plot for near by DFS band
(DFS is required, if 99% OCP straddle into U-NII-2C band)**

802.11a_Chain 0 / CH149

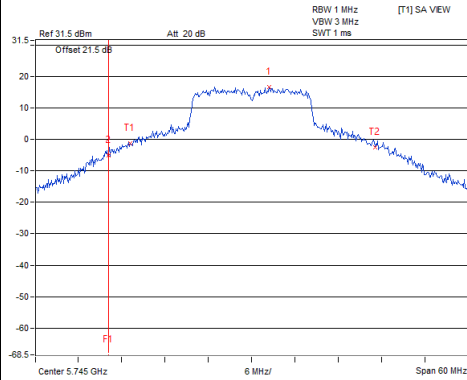

802.11a_Chain 1 / CH149

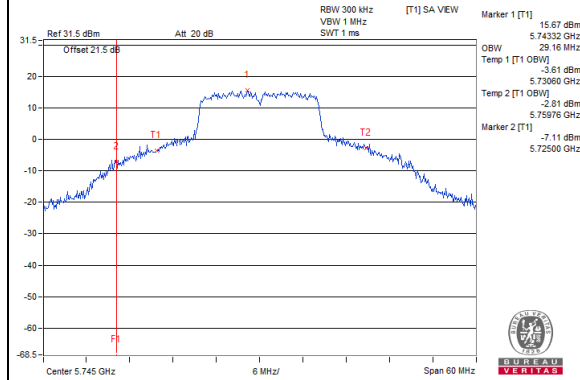

802.11ac (VHT20)_Chain 0 / CH149

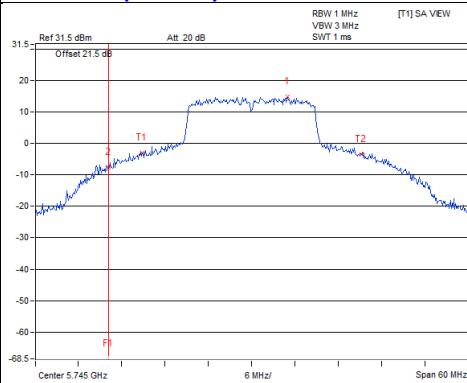

802.11ac (VHT20)_Chain 1 / CH149

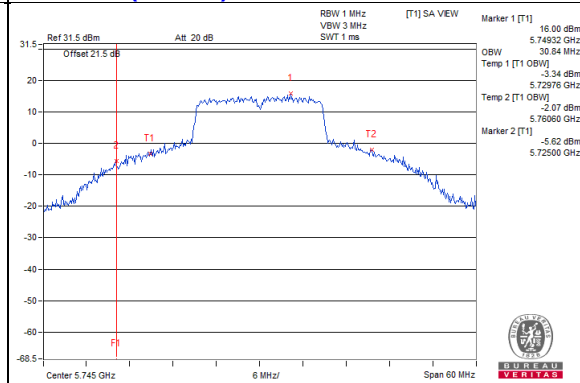

**Spectrum Plot for near by DFS band
(DFS is required, if 99% OCP straddle into U-NII-2C band)**

802.11ac (VHT40)_Chain 0 / CH151

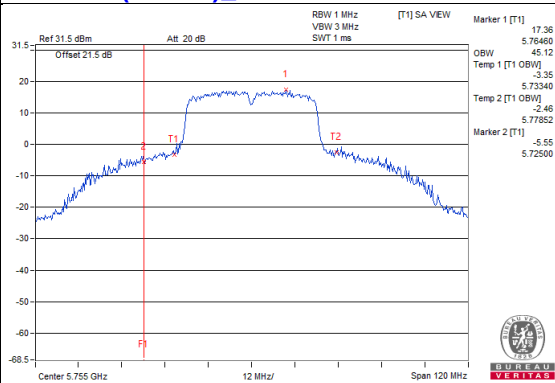

802.11ac (VHT40)_Chain 1 / CH151

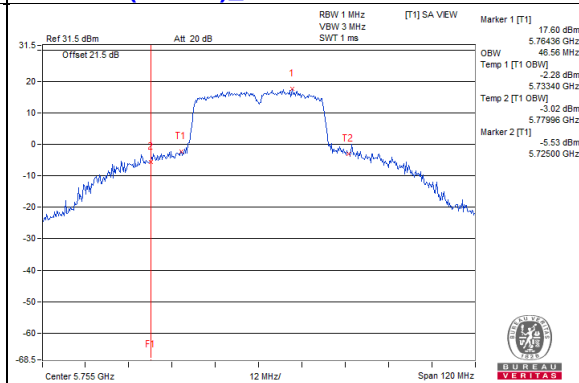

802.11ac (VHT80)_Chain 0 / CH155

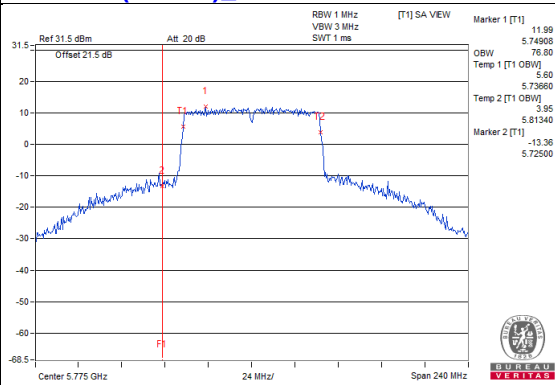

802.11ac (VHT80)_Chain 1 / CH155

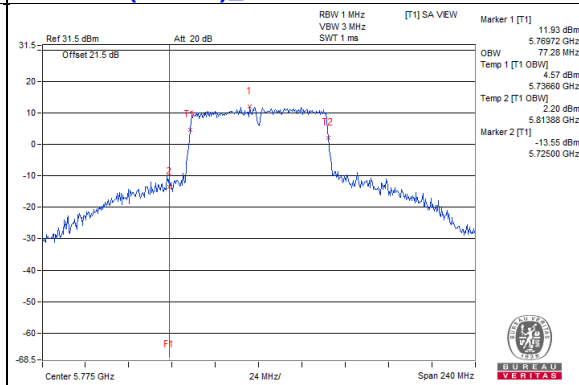

4.5 Peak Power Spectral Density Measurement

4.5.1 Limits of Peak Power Spectral Density Measurement

Operation Band	EUT Category		Limit
U-NII-1		Outdoor Access Point	17dBm/ MHz
		Fixed point-to-point Access Point	
	√	Indoor Access Point	
		Client device	11dBm/ MHz
U-NII-2A			11dBm/ MHz
U-NII-2C			11dBm/ MHz
U-NII-3		√	30dBm/ 500kHz

4.5.2 Test Setup

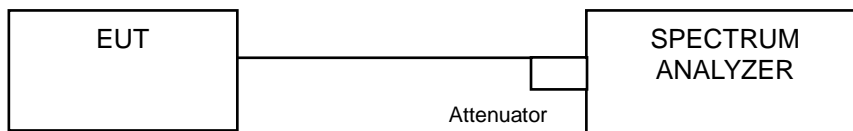

4.5.3 Test Instruments

Refer to section 4.1.2 to get information of above instrument.

4.5.4 Test Procedure

For 802.11ac (VHT20)

For U-NII-1:

Using method SA-1

1. Set span to encompass the entire emission bandwidth (EBW) of the signal.
2. Set RBW = 1 MHz, Set VBW \geq 3 MHz, Detector = RMS
3. Sweep time = auto, trigger set to "free run".
4. Trace average at least 100 traces in power averaging mode.
5. Record the max value

※For U-NII-3:

1. Set span to encompass the entire emission bandwidth (EBW) of the signal.
2. Set RBW = 300 kHz, Set VBW \geq 1 MHz, Detector = RMS
3. Use the peak marker function to determine the maximum power level in any 300 kHz band segment within the fundamental EBW.
4. Scale the observed power level to an equivalent value in 500 kHz by adjusting (reducing) the measured power by a bandwidth correction factor (BWCF) where $BWCF = 10\log(500 \text{ kHz}/300\text{kHz})$
5. Sweep time = auto, trigger set to "free run".
6. Trace average at least 100 traces in power averaging mode.
7. Record the max value

For 802.11a, 802.11ac (VHT40), 802.11ac (VHT80)

For U-NII-1:

Using method SA-2

1. Set span to encompass the entire emission bandwidth (EBW) of the signal.
2. Set RBW = 1 MHz, Set VBW \geq 3 MHz, Detector = RMS
3. Sweep time = auto, trigger set to "free run".
4. Trace average at least 100 traces in power averaging mode.
5. Record the max value and add $10 \log (1/\text{duty cycle})$

※For U-NII-3:

1. Set span to encompass the entire emission bandwidth (EBW) of the signal.
2. Set RBW = 300 kHz, Set VBW \geq 1 MHz, Detector = RMS
3. Use the peak marker function to determine the maximum power level in any 300 kHz band segment within the fundamental EBW.
4. Scale the observed power level to an equivalent value in 500 kHz by adjusting (reducing) the measured power by a bandwidth correction factor (BWCF) where $\text{BWCF} = 10 \log(500 \text{ kHz}/300 \text{ kHz})$
5. Sweep time = auto, trigger set to "free run".
6. Trace average at least 100 traces in power averaging mode.
7. Record the max value and add $10 \log (1/\text{duty cycle})$

4.5.5 Deviation from Test Standard

No deviation.

4.5.6 EUT Operating Condition

Same as Item 4.3.6.

4.5.7 Test Results

For U-NII-1:

802.11a

Chan.	Chan. Freq. (MHz)	PSD W/O Duty Factor (dBm/MHz)		Duty Factor (dB)	Total PSD With Duty Factor (dBm/MHz)	Max. Limit (dBm/MHz)	Pass / Fail
		Chain 0	Chain 1				
36	5180	6.56	6.58	0.52	10.10	16.92	Pass
40	5200	9.34	9.26	0.52	12.83	16.92	Pass
48	5240	9.46	9.12	0.52	12.82	16.92	Pass

- Note:**
- Method a) of power density measurement of KDB 662911 is using for calculating total power density. Total power density is summing entire spectra across corresponding frequency bins on the various outputs by computer.
 - Directional gain = $10 \log[(10^{G_0/20} + 10^{G_1/20})^2 / 2] = 6.08\text{dBi} > 6\text{dBi}$, so the power limit shall be reduced to $17-(6.08-6) = 16.92\text{dBm}$.
 - Refer to section 3.3 for duty cycle spectrum plot.

802.11ac (VHT20)

Chan.	Chan. Freq. (MHz)	PSD W/O Duty Factor (dBm/MHz)		Total PSD With Duty Factor (dBm/MHz)	Max. Limit (dBm/MHz)	Pass / Fail
		Chain 0	Chain 1			
36	5180	1.23	6.53	7.65	16.92	Pass
40	5200	4.20	9.42	10.56	16.92	Pass
48	5240	4.03	9.01	10.21	16.92	Pass

- Note:**
- Method a) of power density measurement of KDB 662911 is using for calculating total power density. Total power density is summing entire spectra across corresponding frequency bins on the various outputs by computer.
 - Directional gain = $10 \log[(10^{G_0/20} + 10^{G_1/20})^2 / 2] = 6.08\text{dBi} > 6\text{dBi}$, so the power limit shall be reduced to $17-(6.08-6) = 16.92\text{dBm}$.

802.11ac (VHT40)

Chan.	Chan. Freq. (MHz)	PSD W/O Duty Factor (dBm/MHz)		Duty Factor (dB)	Total PSD With Duty Factor (dBm/MHz)	Max. Limit (dBm/MHz)	Pass / Fail
		Chain 0	Chain 1				
38	5190	1.11	1.42	0.82	5.10	16.92	Pass
46	5230	4.94	5.02	0.82	8.81	16.92	Pass

- Note:**
- Method a) of power density measurement of KDB 662911 is using for calculating total power density. Total power density is summing entire spectra across corresponding frequency bins on the various outputs by computer.
 - Directional gain = $10 \log[(10^{G_0/20} + 10^{G_1/20})^2 / 2] = 6.08\text{dBi} > 6\text{dBi}$, so the power limit shall be reduced to $17-(6.08-6) = 16.92\text{dBm}$.
 - Refer to section 3.3 for duty cycle spectrum plot.

802.11ac (VHT80)

Chan.	Chan. Freq. (MHz)	PSD W/O Duty Factor (dBm/MHz)		Duty Factor (dB)	Total PSD With Duty Factor (dBm/MHz)	Max. Limit (dBm/MHz)	Pass / Fail
		Chain 0	Chain 1				
42	5210	-3.06	-2.87	0.48	0.53	16.92	Pass

- Note:**
- Method a) of power density measurement of KDB 662911 is using for calculating total power density. Total power density is summing entire spectra across corresponding frequency bins on the various outputs by computer.
 - Directional gain = $10 \log[(10^{G0/20} + 10^{G1/20})^2 / 2] = 6.08\text{dBi} > 6\text{dBi}$, so the power limit shall be reduced to $17-(6.08-6) = 16.92\text{dBm}$.
 - Refer to section 3.3 for duty cycle spectrum plot.

Spectrum Plot of Worst Value

802.11a_Chain 0 / CH48

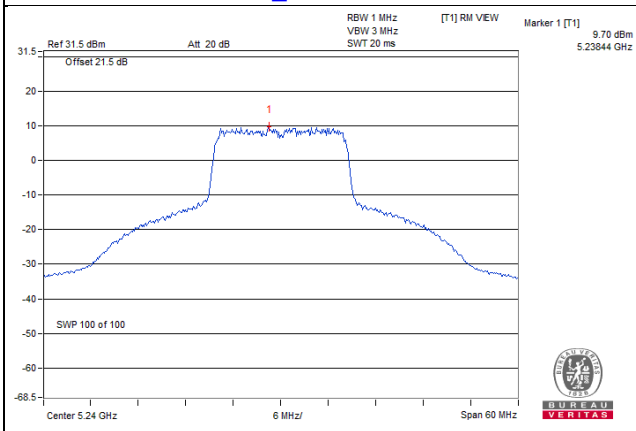

802.11ac (VHT20)_Chain 1 / CH40

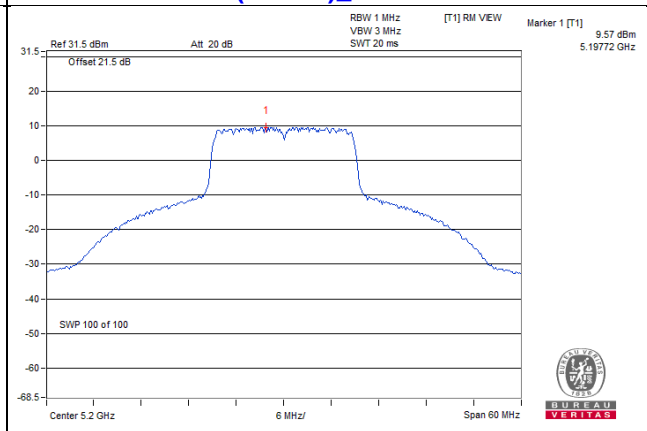

802.11ac (VHT40)_Chain 1 / CH46

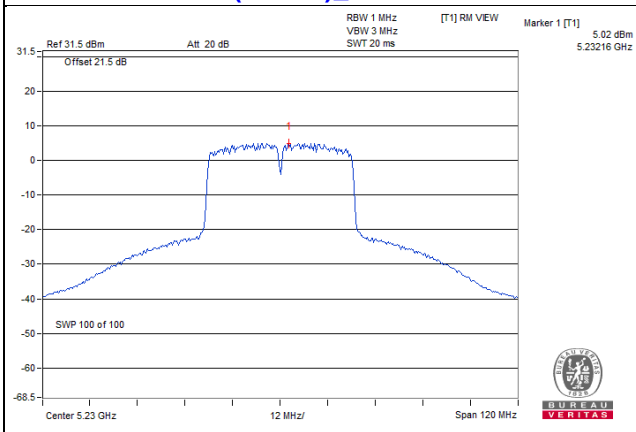

802.11ac (VHT80)_Chain 1 / CH42

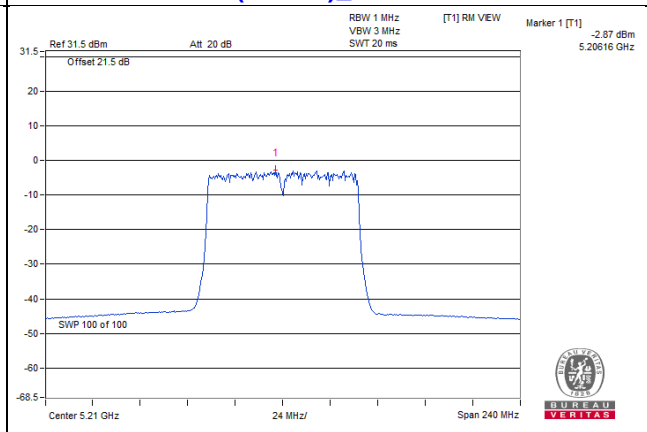

For U-NII-3:
802.11a

Chan.	Freq. (MHz)	PSD W/O Duty Factor (dBm/300kHz)		Total PSD With Duty Factor		Duty Factor (dB)	Total PSD With Duty Factor (dBm/500kHz)	Limit (dBm/500kHz)	Pass /Fail
		Chain 0	Chain 1	mW/300kHz	dBm/300kHz				
149	5745	2.54	2.25	3.9131	5.93	0.52	8.15	29.98	Pass
157	5785	2.54	2.36	3.9616	5.98	0.52	8.20	29.98	Pass
165	5825	2.43	1.86	3.7001	5.68	0.52	7.90	29.98	Pass

- Note: 1. Method b) Measure and sum spectral maxima across the outputs of KDB 662911 is using for calculating total power density.
2. The directional gain $= 10 \log[(10^{G0/20} + 10^{G1/20})^2 / 2] = 6.02\text{dBi} > 6\text{dBi}$, so the power density limit shall be reduced to $30 - (6.02 - 6) = 29.98 \text{ dBm}$.
3. Refer to section 3.3 for duty cycle spectrum plot.

802.11ac (VHT20)

Chan.	Freq. (MHz)	PSD (dBm/300kHz)		Total PSD		Total PSD (dBm/500kHz)	Limit (dBm/500kHz)	Pass /Fail
		Chain 0	Chain 1	mW/300kHz	dBm/300kHz			
149	5745	-4.00	1.96	1.9685	2.94	5.16	29.98	Pass
157	5785	-2.95	1.90	2.0558	3.13	5.35	29.98	Pass
165	5825	-2.86	2.03	2.1135	3.25	5.47	29.98	Pass

- Note: 1. Method b) Measure and sum spectral maxima across the outputs of KDB 662911 is using for calculating total power density.
2. The directional gain $= 10 \log[(10^{G0/20} + 10^{G1/20})^2 / 2] = 6.02\text{dBi} > 6\text{dBi}$, so the power density limit shall be reduced to $30 - (6.02 - 6) = 29.98 \text{ dBm}$.

802.11ac (VHT40)

Chan.	Freq. (MHz)	PSD W/O Duty Factor (dBm/300kHz)		Total PSD With Duty Factor		Duty Factor (dB)	Total PSD With Duty Factor (dBm/500kHz)	Limit (dBm/500kHz)	Pass /Fail
		Chain 0	Chain 1	mW/300kHz	dBm/300kHz				
151	5755	-2.21	-2.19	1.4541	1.63	0.82	3.85	29.98	Pass
159	5795	-0.79	-1.54	1.8523	2.68	0.82	4.90	29.98	Pass

- Note: 1. Method b) Measure and sum spectral maxima across the outputs of KDB 662911 is using for calculating total power density.
2. The directional gain $= 10 \log[(10^{G0/20} + 10^{G1/20})^2 / 2] = 6.02\text{dBi} > 6\text{dBi}$, so the power density limit shall be reduced to $30 - (6.02 - 6) = 29.98 \text{ dBm}$.
3. Refer to section 3.3 for duty cycle spectrum plot.

802.11ac (VHT80)

Chan.	Freq. (MHz)	PSD W/O Duty Factor (dBm/300kHz)		Total PSD With Duty Factor		Duty Factor (dB)	Total PSD With Duty Factor (dBm/500kHz)	Limit (dBm/500kHz)	Pass /Fail
		Chain 0	Chain 1	mW/300kHz	dBm/300kHz				
155	5775	-7.37	-7.59	0.3992	-3.99	0.48	-1.77	29.98	Pass

- Note: 1. Method b) Measure and sum spectral maxima across the outputs of KDB 662911 is using for calculating total power density.
2. The directional gain = $10 \log[(10^{G0/20} + 10^{G1/20})^2 / 2] = 6.02\text{dBi} > 6\text{dBi}$, so the power density limit shall be reduced to $30 - (6.02 - 6) = 29.98 \text{ dBm}$.
3. Refer to section 3.3 for duty cycle spectrum plot.

Spectrum Plot of Worst Value

802.11a_Chain 0 / CH149

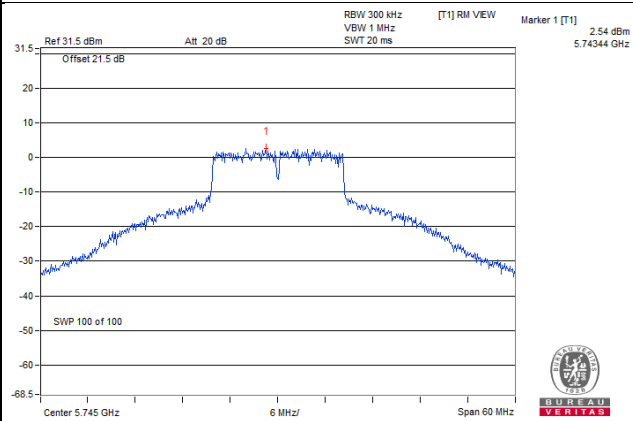

802.11ac (VHT20)_Chain 1 / CH165

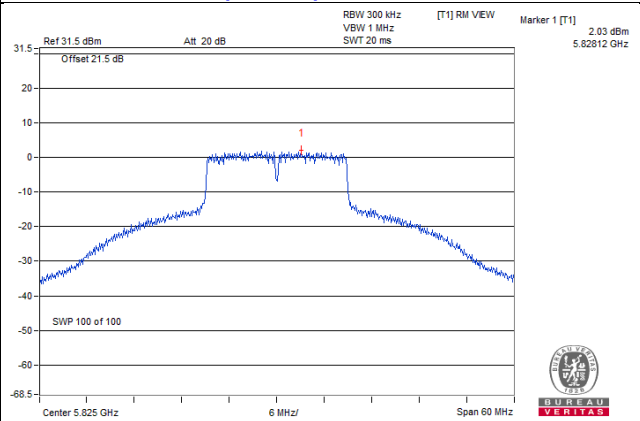

802.11ac (VHT40)_Chain 0 / CH159

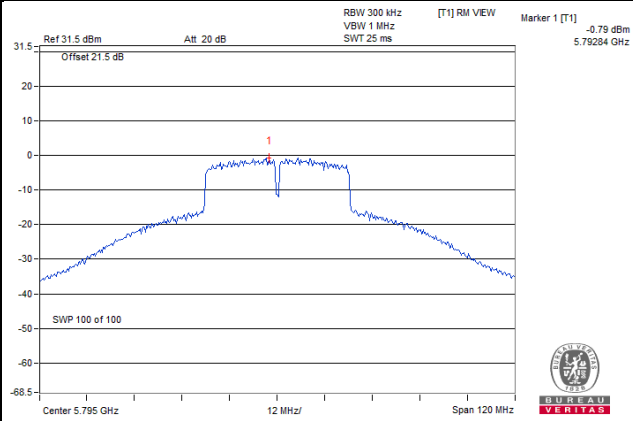

802.11ac (VHT80)_Chain 0 / CH155

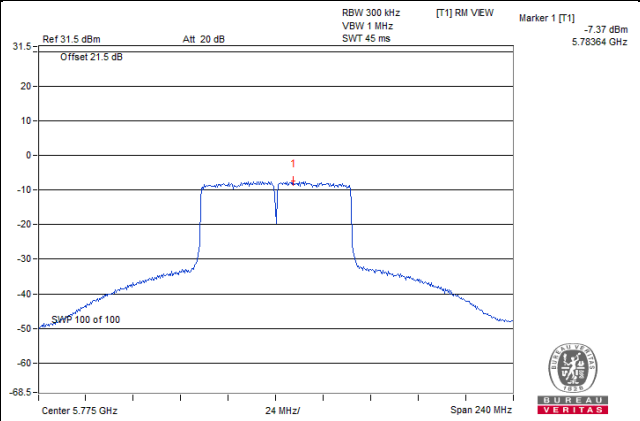

4.6 Frequency Stability Measurement

4.6.1 Limits of Frequency Stability Measurement

The frequency of the carrier signal shall be maintained within band of operation

4.6.2 Test Setup

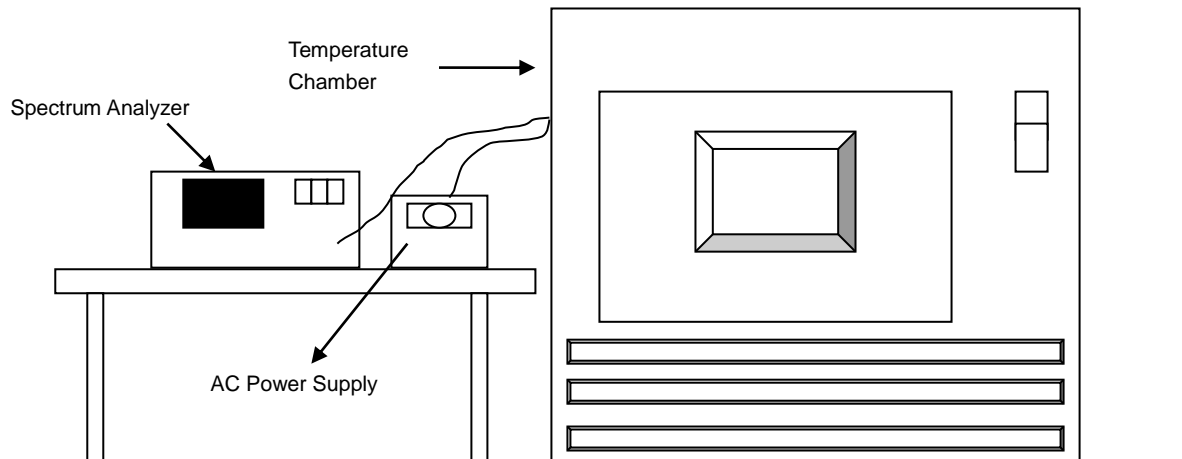

4.6.3 Test Instruments

Refer to section 4.1.2 to get information of above instrument.

4.6.4 Test Procedure

- The EUT was placed inside the environmental test chamber and powered by nominal AC voltage.
- Turn the EUT on and couple its output to a spectrum analyzer.
- Turn the EUT off and set the chamber to the highest temperature specified.
- Allow sufficient time (approximately 30 min) for the temperature of the chamber to stabilize, turn the EUT on and measure the operating frequency after 2, 5, and 10 Minutes.
- Repeat step (d) with the temperature chamber set to the next desired temperature until measurements down to the lowest specified temperature have been completed.
- The test chamber was allowed to stabilize at +20 degree C for a minimum of 30 Minutes. The supply voltage was then adjusted on the EUT from 85% to 115% and the frequency record.

4.6.5 Deviation from Test Standard

No deviation.

4.6.6 EUT Operating Condition

Set the EUT transmit at un-modulation mode to test frequency stability.

4.6.7 Test Results

Frequency Stability Versus Temp.									
Operating Frequency: 5180 MHz									
TEMP. (°C)	Power Supply (Vac)	0 Minute		2 Minutes		5 Minutes		10 Minutes	
		Measured Frequency (MHz)	Pass/Fail	Measured Frequency (MHz)	Pass/Fail	Measured Frequency (MHz)	Pass/Fail	Measured Frequency (MHz)	Pass/Fail
40	120	5180.0222	PASS	5180.0189	PASS	5180.0208	PASS	5180.0216	PASS
30	120	5180.0007	PASS	5180.0041	PASS	5180.0013	PASS	5180.0027	PASS
20	120	5179.9749	PASS	5179.9777	PASS	5179.9792	PASS	5179.9773	PASS
10	120	5180.0053	PASS	5180.0043	PASS	5180.0051	PASS	5180.0063	PASS
0	120	5179.984	PASS	5179.9862	PASS	5179.9848	PASS	5179.987	PASS

Frequency Stability Versus Voltage									
Operating Frequency: 5180 MHz									
TEMP. (°C)	Power Supply (Vac)	0 Minute		2 Minutes		5 Minutes		10 Minutes	
		Measured Frequency (MHz)	Pass/Fail	Measured Frequency (MHz)	Pass/Fail	Measured Frequency (MHz)	Pass/Fail	Measured Frequency (MHz)	Pass/Fail
20	138	5180.0047	PASS	5180.0036	PASS	5180.0044	PASS	5180.0069	PASS
	120	5180.0053	PASS	5180.0043	PASS	5180.0051	PASS	5180.0063	PASS
	102	5180.0051	PASS	5180.0044	PASS	5180.0042	PASS	5180.0071	PASS

4.7 6dB Bandwidth Measurement

4.7.1 Limits of 6dB Bandwidth Measurement

The minimum of 6dB Bandwidth Measurement is 0.5MHz.

4.7.2 Test Setup

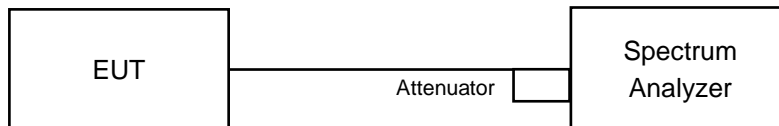

4.7.3 Test Instruments

Refer to section 4.1.2 to get information of above instrument.

4.7.4 Test Procedure

MEASUREMENT PROCEDURE REF

- a. Set resolution bandwidth (RBW) = 100kHz
- b. Set the video bandwidth (VBW) $\geq 3 \times$ RBW, Detector = Peak.
- c. Trace mode = max hold.
- d. Sweep = auto couple.
- e. Measure the maximum width of the emission that is constrained by the frequencies associated with the two amplitude points (upper and lower) that are attenuated by 6 dB relative to the maximum level measured in the fundamental emission

4.7.5 Deviation from Test Standard

No deviation.

4.7.6 EUT Operating Condition

The software provided by client to enable the EUT under transmission condition continuously at lowest, middle and highest channel frequencies individually.

4.7.7 Test Results

802.11a

Channel	Frequency (MHz)	6dB Bandwidth (MHz)		Minimum Limit (MHz)	Pass / Fail
		Chain 0	Chain 1		
149	5745	16.39	16.39	0.5	Pass
157	5785	16.40	16.40	0.5	Pass
165	5825	16.38	16.38	0.5	Pass

802.11ac (VHT20)

Channel	Frequency (MHz)	6dB Bandwidth (MHz)		Minimum Limit (MHz)	Pass / Fail
		Chain 0	Chain 1		
149	5745	17.62	17.61	0.5	Pass
157	5785	17.62	17.63	0.5	Pass
165	5825	17.60	17.66	0.5	Pass

802.11ac (VHT40)

Channel	Frequency (MHz)	6dB Bandwidth (MHz)		Minimum Limit (MHz)	Pass / Fail
		Chain 0	Chain 1		
151	5755	35.22	35.24	0.5	Pass
159	5795	35.81	35.15	0.5	Pass

802.11ac (VHT80)

Channel	Frequency (MHz)	6dB Bandwidth (MHz)		Minimum Limit (MHz)	Pass / Fail
		Chain 0	Chain 1		
155	5775	75.94	75.98	0.5	Pass

Spectrum Plot of Worst Value

802.11a_Chain 0 / CH165

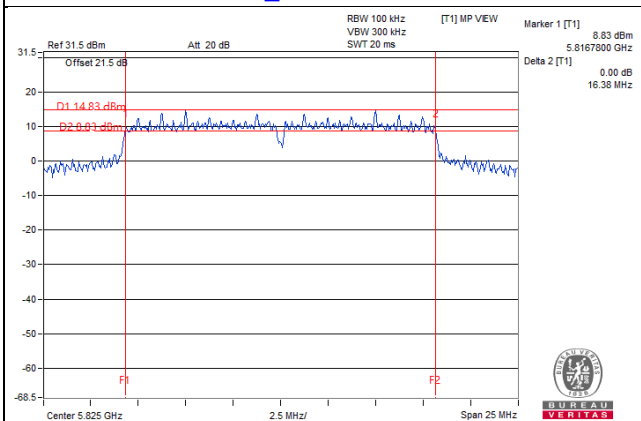

802.11ac (VHT20)_Chain 0 / CH165

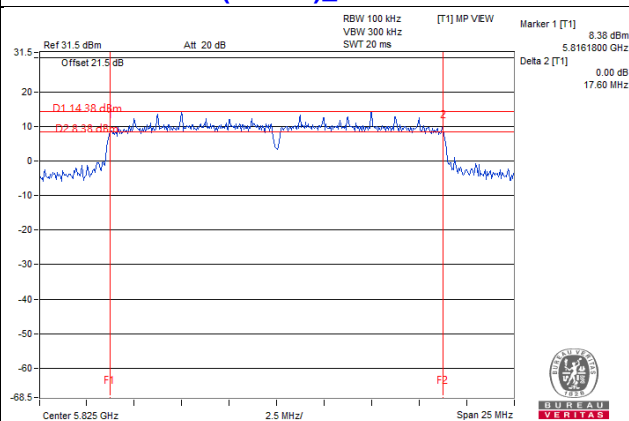

802.11ac (VHT40)_Chain 1 / CH159

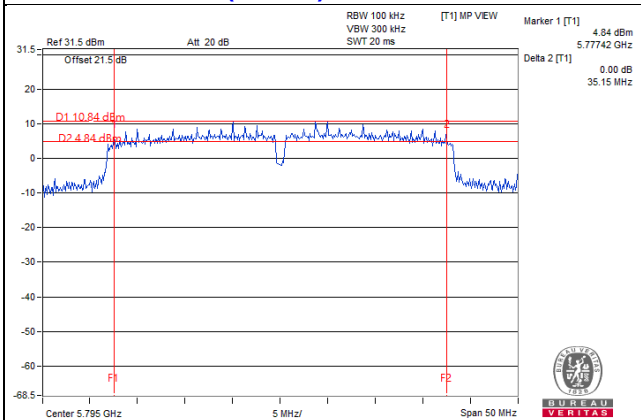

802.11ac (VHT80)_Chain 0 / CH155

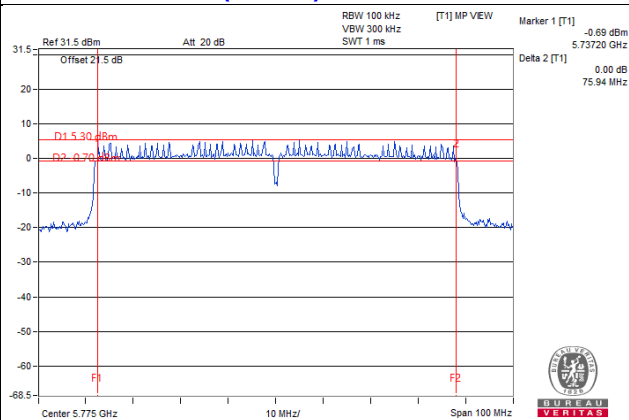

5 Pictures of Test Arrangements

Please refer to the attached file (Test Setup Photo).

Annex A- Radiated Out of Band Emission (OOBE) Measurement (For U-NII-3 band)

802.11a

CH 149 5745 MHz

Horizontal

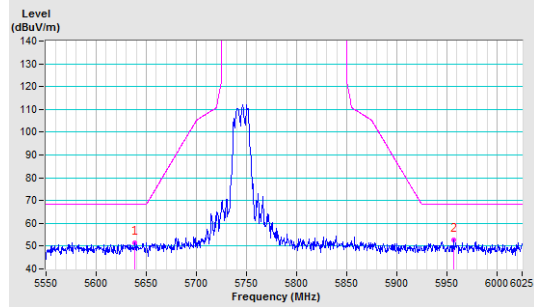

Vertical

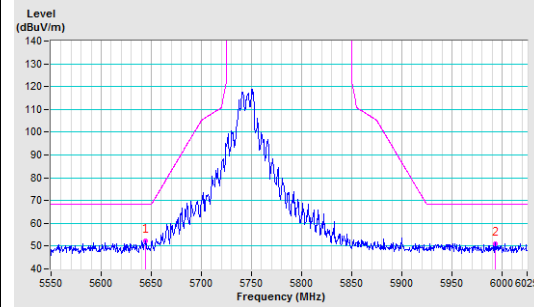

CH 157 5785 MHz

Horizontal

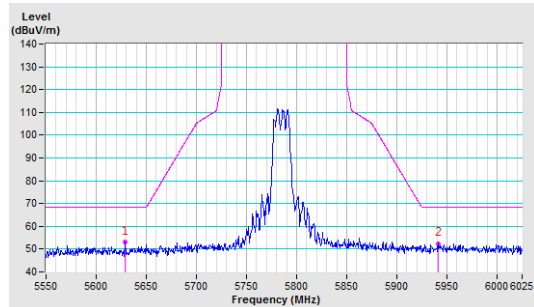

Vertical

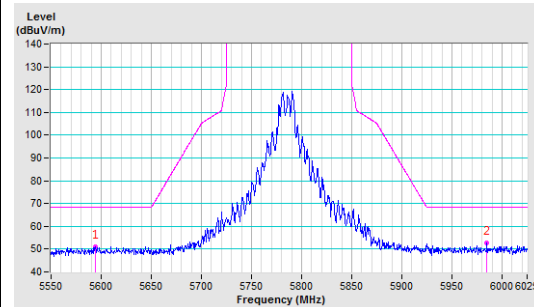

CH 165 5825 MHz

Horizontal

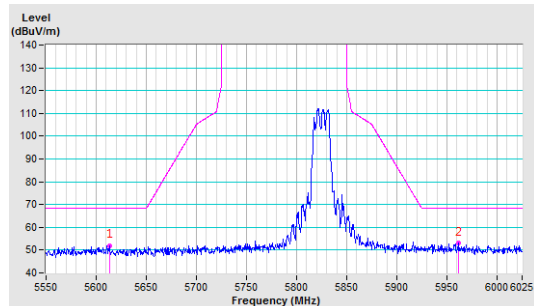

Vertical

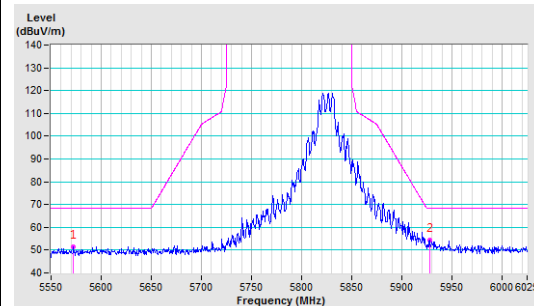

802.11ac (VHT20)

CH 149 5745 MHz

Horizontal

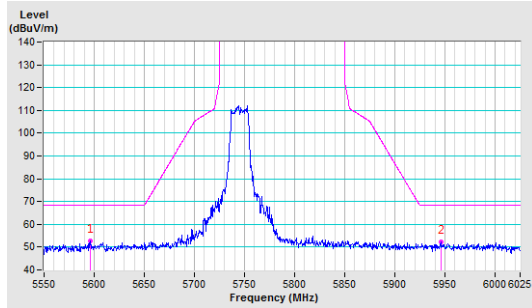

Vertical

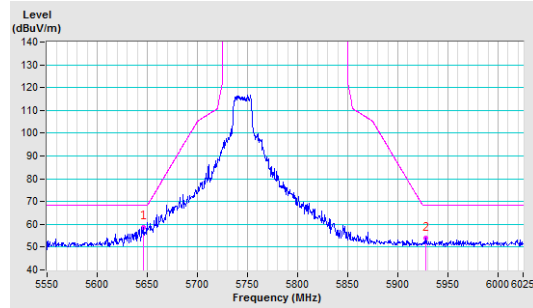

CH 157 5785 MHz

Horizontal

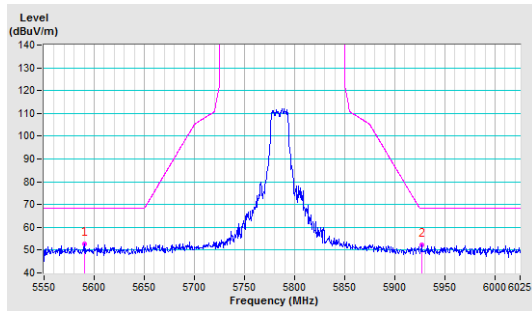

Vertical

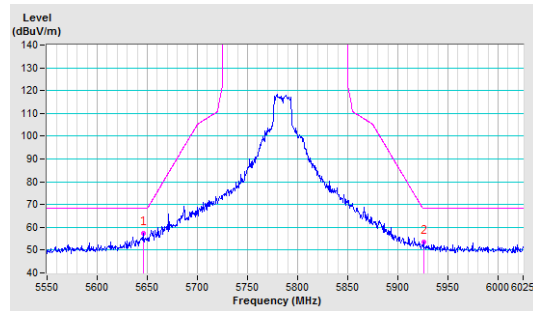

CH 165 5825 MHz

Horizontal

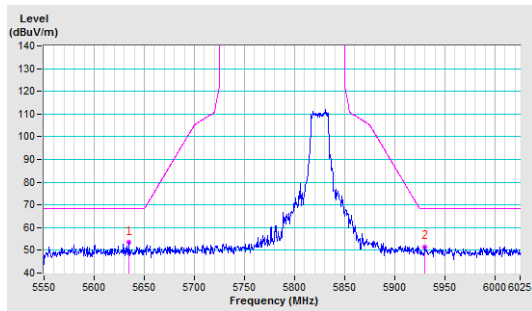

Vertical

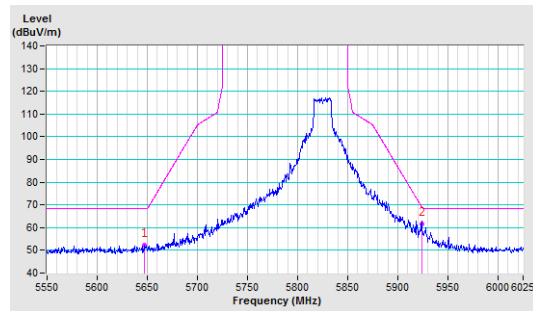

802.11ac (VHT40)

CH 151 5755 MHz

Horizontal

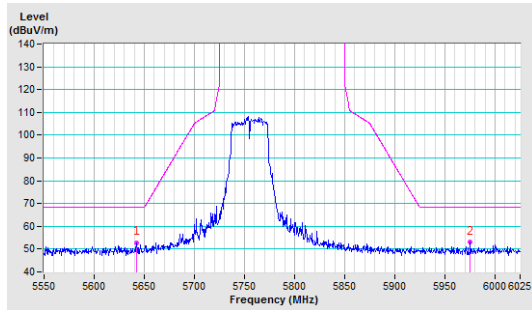

Vertical

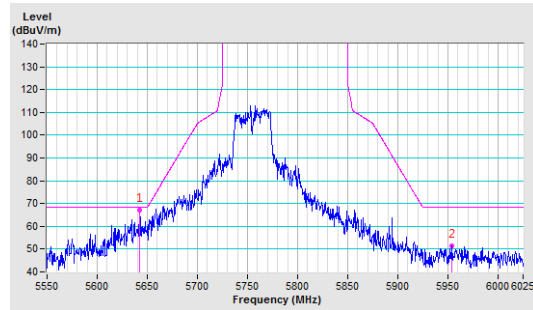

CH 159 5795 MHz

Horizontal

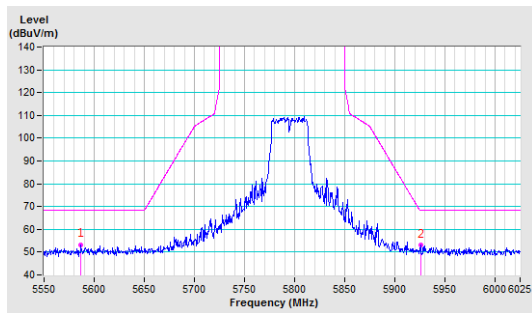

Vertical

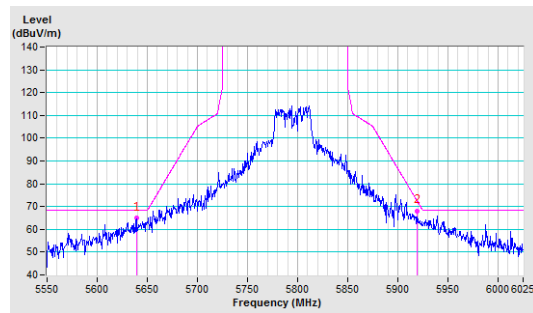

802.11ac (VHT80)

CH 155 5775 MHz

Horizontal

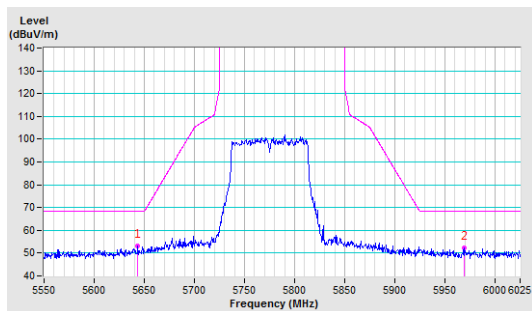

Vertical

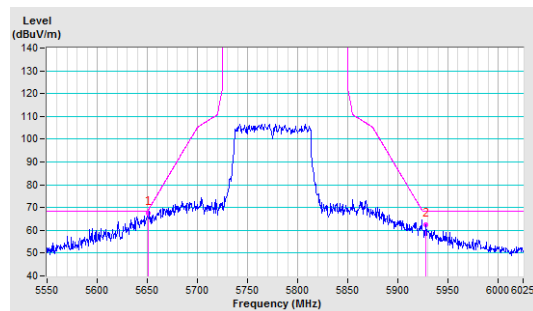

Appendix – Information of the Testing Laboratories

We, Bureau Veritas Consumer Products Services (H.K.) Ltd., Taoyuan Branch, were founded in 1988 to provide our best service in EMC, Radio, Telecom and Safety consultation. Our laboratories are FCC recognized accredited test firms and accredited according to ISO/IEC 17025.

If you have any comments, please feel free to contact us at the following:

Lin Kou EMC/RF Lab

Tel: 886-2-26052180

Fax: 886-2-26051924

Hsin Chu EMC/RF/Telecom Lab

Tel: 886-3-6668565

Fax: 886-3-6668323

Hwa Ya EMC/RF/Safety Lab

Tel: 886-3-3183232

Fax: 886-3-3270892

Email: service.adt@tw.bureauveritas.com

Web Site: www.bureauveritas-adt.com

The address and road map of all our labs can be found in our web site also.

--- END ---