

FCC Test Report (DFS Band)

Report No.: RF191227E08C-1

FCC ID: Q87-08151

Test Model: MR7350

Series Model: MR7340, MR7320, MR7310

Received Date: Jan. 13, 2020

Test Date: Jan. 13 to May 07, 2020

Issued Date: June 12, 2020

Applicant: LINKSYS LLC

Address: 121 Theory Drive Irvine California 92617 United States

Issued By: Bureau Veritas Consumer Products Services (H.K.) Ltd., Taoyuan Branch
Hsin Chu Laboratory

Lab Address: E-2, No.1, Li Hsin 1st Road, Hsinchu Science Park, Hsinchu City 300,
Taiwan

Test Location: E-2, No.1, Li Hsin 1st Road, Hsinchu Science Park, Hsinchu City 300,
Taiwan

**FCC Registration /
Designation Number:** 723255 / TW2022



This report is for your exclusive use. Any copying or replication of this report to or for any other person or entity, or use of our name or trademark, is permitted only with our prior written permission. This report sets forth our findings solely with respect to the test samples identified herein. The results set forth in this report are not indicative or representative of the quality or characteristics of the lot from which a test sample was taken or any similar or identical product unless specifically and expressly noted. Our report includes all of the tests requested by you and the results thereof based upon the information that you provided to us. You have 60 days from date of issuance of this report to notify us of any material error or omission caused by our negligence, provided, however, that such notice shall be in writing and shall specifically address the issue you wish to raise. A failure to raise such issue within the prescribed time shall constitute your unqualified acceptance of the completeness of this report, the tests conducted and the correctness of the report contents. Unless specific mention, the uncertainty of measurement has been explicitly taken into account to declare the compliance or non-compliance to the specification. The report must not be used by the client to claim product certification, approval, or endorsement by TAF or any government agencies.

Table of Contents

Release Control Record	4
1 Certificate of Conformity	5
2 Summary of Test Results	6
2.1 Measurement Uncertainty	6
2.2 Modification Record	6
3 General Information	7
3.1 General Description of EUT (DFS Band)	7
3.2 Description of Test Modes	10
3.2.1 Test Mode Applicability and Tested Channel Detail	11
3.3 Duty Cycle of Test Signal	14
3.4 Description of Support Units	15
3.4.1 Configuration of System under Test	16
3.5 General Description of Applied Standards and References	17
4 Test Types and Results	18
4.1 Radiated Emission and Bandedge Measurement	18
4.1.1 Limits of Radiated Emission and Bandedge Measurement	18
4.1.2 Test Instruments	19
4.1.3 Test Procedure	22
4.1.4 Deviation from Test Standard	22
4.1.5 Test Setup	23
4.1.6 EUT Operating Condition	24
4.1.7 Test Results	25
4.2 Conducted Emission Measurement	51
4.2.1 Limits of Conducted Emission Measurement	51
4.2.2 Test Instruments	51
4.2.3 Test Procedure	52
4.2.4 Deviation from Test Standard	52
4.2.5 Test Setup	52
4.2.6 EUT Operating Condition	52
4.2.7 Test Results	53
4.3 Transmit Power Measurement	55
4.3.1 Limits of Transmit Power Measurement	55
4.3.2 Test Setup	55
4.3.3 Test Instruments	56
4.3.4 Test Procedure	56
4.3.5 Deviation from Test Standard	56
4.3.6 EUT Operating Condition	56
4.3.7 Test Results	57
4.4 Occupied Bandwidth Measurement	73
4.4.1 Test Setup	73
4.4.2 Test Instruments	73
4.4.3 Test Procedure	73
4.4.4 Test Results	74
4.5 Peak Power Spectral Density Measurement	79
4.5.1 Limits of Peak Power Spectral Density Measurement	79
4.5.2 Test Setup	79
4.5.3 Test Instruments	79
4.5.4 Test Procedure	79
4.5.5 Deviation from Test Standard	80
4.5.6 EUT Operating Condition	80
4.5.7 Test Results	81
4.6 Frequency Stability Measurement	86
4.6.1 Limits of Frequency Stability Measurement	86

4.6.2	Test Setup.....	86
4.6.3	Test Instruments	86
4.6.4	Test Procedure	86
4.6.5	Deviation from Test Standard	86
4.6.6	EUT Operating Condition	86
4.6.7	Test Results	87
4.7	6dB Bandwidth Measurement	88
4.7.1	Limits of 6dB Bandwidth Measurement.....	88
4.7.2	Test Setup.....	88
4.7.3	Test Instruments	88
4.7.4	Test Procedure	88
4.7.5	Deviation from Test Standard	88
4.7.6	EUT Operating Condition	88
4.7.7	Test Results	89
5	Pictures of Test Arrangements.....	91
	Annex A - Band-Edge Measurement (For U-NII-2A, U-NII-2C band)	92
	Appendix – Information of the Testing Laboratories	99

Release Control Record

Issue No.	Description	Date Issued
RF191227E08C-1	Original release.	June 12, 2020

1 Certificate of Conformity

Product: Linksys Dual-Band 802.11ax Wireless Router
Brand: Linksys
Test Model: MR7350
Series Model: MR7340, MR7320, MR7310
Sample Status: ENGINEERING SAMPLE
Applicant: LINKSYS LLC
Test Date: Jan. 13 to May 07, 2020
Standard: 47 CFR FCC Part 15, Subpart E (Section 15.407)
ANSI C63.10: 2013

The above equipment has been tested by **Bureau Veritas Consumer Products Services (H.K.) Ltd., Taoyuan Branch**, and found compliance with the requirement of the above standards. The test record, data evaluation & Equipment Under Test (EUT) configurations represented herein are true and accurate accounts of the measurements of the sample's EMC characteristics under the conditions specified in this report.

Prepared by : Vivian Huang , **Date:** June 12, 2020
Vivian Huang / Specialist

Approved by : Clark Lin , **Date:** June 12, 2020
Clark Lin / Technical Manager

2 Summary of Test Results

47 CFR FCC Part 15, Subpart E (Section 15.407)			
FCC Clause	Test Item	Result	Remarks
15.407(b)(6)	AC Power Conducted Emissions	Pass	Meet the requirement of limit. Minimum passing margin is -10.00 dB at 0.16172 MHz.
15.407(b) (1/2/3/4(i/ii)/6)	Radiated Emissions & Band Edge Measurement*	Pass	Meet the requirement of limit. Minimum passing margin is -1.0 dB at 5350.00 MHz and 5470.00 MHz.
15.407(a)(1/2/3)	Max Average Transmit Power	Pass	Meet the requirement of limit.
---	Occupied Bandwidth Measurement	-	Reference only.
15.407(a)(1/2/3)	Peak Power Spectral Density	Pass	Meet the requirement of limit.
15.407(e)	6dB bandwidth	Pass	Meet the requirement of limit. (U-NII-3 Band only)
15.407(g)	Frequency Stability	Pass	Meet the requirement of limit.
15.203	Antenna Requirement	Pass	Antenna connector is i-pex(MHF) not a standard connector.

Note:

- For U-NII-2A, U-NII-2C band compliance with rule 15.407(b) of the band-edge items, the test plots were recorded in Annex A. Test Procedures refer to report 4.1.3.
- Determining compliance based on the results of the compliance measurement, not taking into account measurement instrumentation uncertainty.

2.1 Measurement Uncertainty

Where relevant, the following measurement uncertainty levels have been estimated for tests performed on the EUT as specified in CISPR 16-4-2:

Measurement	Frequency	Expanded Uncertainty (k=2) (±)
Conducted Emissions at mains ports	150kHz ~ 30MHz	1.9 dB
Radiated Emissions up to 1 GHz	9kHz ~ 30MHz	3.1 dB
	30MHz ~ 1GHz	5.5 dB
Radiated Emissions above 1 GHz	1GHz ~ 18GHz	5.1 dB
	18GHz ~ 40GHz	5.3 dB

2.2 Modification Record

There were no modifications required for compliance.

3 General Information

3.1 General Description of EUT (DFS Band)

Product	Linksys Dual-Band 802.11ax Wireless Router
Brand	Linksys
Test Model	MR7350
Series Model	MR7340, MR7320, MR7310
Status of EUT	ENGINEERING SAMPLE
Power Supply Rating	12Vdc from power adapter
Modulation Type	64QAM, 16QAM, QPSK, BPSK for OFDM 256QAM for OFDM in 11ac mode 1024QAM for OFDMA in 11ax HE mode
Modulation Technology	OFDM, OFDMA
Transfer Rate	802.11a: up to 54 Mbps 802.11n: up to 300 Mbps 802.11ac: up to 866.7 Mbps 802.11ax: up to 1201.0 Mbps
Operating Frequency	5.26GHz ~ 5.32GHz, 5.5 ~ 5.72GHz
Number of Channel	802.11a, 802.11n (HT20), 802.11ac (VHT20), 80211ax (HE20): 16 802.11n (HT40), 802.11ac (VHT40), 80211ax (HE40): 8 802.11ac (VHT80), 80211ax (HE80): 4
Output Power	CDD Mode: 5.26 ~ 5.32 GHz: 240.165 mW 5.5 ~ 5.72 GHz: 236.132 mW Beamforming Mode: 5.26 ~ 5.32 GHz: 228.498 mW 5.5 ~ 5.72 GHz: 232.256 mW
Antenna Type	Refer to Note
Antenna Connector	Refer to Note
Accessory Device	Adapter x 1
Data Cable Supplied	RJ-45 Cable x 1 (Unshielded, 1 m)

Note:

- This report is prepared for FCC class II change. The difference compared with the Report No.: RF191227E08-1 as the following:
 - ◆ Add DFS band <5.26GHz ~ 5.32GHz, 5.5 ~ 5.72GHz> by software.
- According to above conditions, for DFS band all of test items need to be performed and all data was verified to meet the requirements.
- The EUT has below model names, which are identical to each other in all aspects except for the following table:

Brand Name	Model No.	Description
Linksys	MR7350	For Marketing Purpose
	MR7340	
	MR7320	
	MR7310	

Note: From the above models, model: MR7350 was selected as representative model for the test and its data was recorded in this report.

- The EUT has below radios as following table:

Radio 1	Radio 2
WLAN (2.4GHz+5GHz)	Bluetooth

5. Simultaneously transmission condition.

Condition	Technology		
1	WLAN (2.4GHz)	WLAN (5GHz)	Bluetooth

Note: The emission of the simultaneous operation has been evaluated and no non-compliance was found.

6. The EUT must be supplied with a power adapter as following table:

No.	Brand	Model No.	Spec.
1	Ktec	KSA-24W-120200HU	Input: 100-240Vac, 0.6A, 50/60Hz Output: 12V, 2A DC output cable: Unshielded, 1.5m
2	APD	WB-24J12FU	Input: 100-240Vac, 0.7A, 50-60Hz Output: 12V, 2A DC output cable: Unshielded, 1.5m

Note: From the above adapters, the AC Power Conducted Emission and Radiated Emissions test worse case was found in **Adapter No. 2**. Therefore only the test data of the mode was recorded in this report.

7. The antennas provided to the EUT, please refer to the following table:

Antenna No.	Antenna Net Gain (dBi)	Frequency Range (GHz)	Antenna Type	Connector Type	Cable Length (mm)
WiFi 1	2.05	2.4~2.4835	Dipole	i-pex(MHF)	330
	2.44	5.15~5.25			
	2.71	5.25~5.35			
	3.07	5.47~5.725			
	3.02	5.725~5.85			
WiFi 2	2.39	2.4~2.4835	Dipole	i-pex(MHF)	80
	3.07	5.15~5.25			
	3.03	5.25~5.35			
	3.08	5.47~5.725			
	3.13	5.725~5.85			
BT	3.6	2.4~2.4835	Metal	none	NA

8. The EUT incorporates a MIMO function:

2.4GHz Band		
MODULATION MODE	TX & RX CONFIGURATION	
802.11b	2TX	2RX
802.11g	2TX	2RX
802.11n (HT20)	2TX	2RX
802.11n (HT40)	2TX	2RX
VHT20	2TX	2RX
VHT40	2TX	2RX
802.11ax (HE20)	2TX	2RX
802.11ax (HE40)	2TX	2RX
5GHz Band		
MODULATION MODE	TX & RX CONFIGURATION	
802.11a	2TX	2RX
802.11n (HT20)	2TX	2RX
802.11n (HT40)	2TX	2RX
802.11ac (VHT20)	2TX	2RX
802.11ac (VHT40)	2TX	2RX
802.11ac (VHT80)	2TX	2RX
802.11ax (HE20)	2TX	2RX
802.11ax (HE40)	2TX	2RX
802.11ax (HE80)	2TX	2RX

Note:

1. All of modulation mode support beamforming function except 802.11a/b/g modulation mode.
2. The EUT support Beamforming and CDD mode, therefore both mode were investigated and the worst case scenario was identified. The worst case data were presented in test report.
3. The modulation and bandwidth are similar for 802.11n mode for 20MHz (40MHz), 802.11ac mode for 20MHz (40MHz, 80MHz) and 802.11ax mode for 20MHz (40MHz, 80MHz), therefore the manufacturer will control the power for 802.11n/ac mode is the same as the 802.11ax or more lower than it and investigated worst case to representative mode in test report. (Final test mode refer to section 3.2.1)

9. The power setting are list as below:

802.11a		802.11ac (VHT20)		802.11ac (VHT40)		802.11ac (VHT80)		802.11ax (HE20)		802.11ax (HE40)		802.11ax (HE80)	
Freq. (MHz)	Power Setting	Freq. (MHz)	Power Setting	Freq. (MHz)	Power Setting	Freq. (MHz)	Power Setting	Freq. (MHz)	Power Setting	Freq. (MHz)	Power Setting	Freq. (MHz)	Power Setting
5260	17.5	5260	20	5270	20	5290	19	5260	20	5270	20	5290	19
5300	17.5	5300	20	5310	19	5530	19	5300	20	5310	19	5530	19
5320	17.5	5320	20	5510	19	5610	20	5320	20	5510	19	5610	20
5500	17.5	5500	20	5550	20	5690	20	5500	20	5550	20	5690	20
5580	17.5	5580	20	5670	19			5580	20	5670	19		
5700	17.5	5700	20	5710	19			5700	20	5710	19		
5720	17.5	5720	20					5720	20				

10. The above EUT information is declared by manufacturer and for more detailed features description, please refers to the manufacturer's specifications or user's manual.

3.2 Description of Test Modes

FOR 5260 ~ 5320MHz

4 channels are provided for 802.11a, 802.11n (HT20), 802.11ac (VHT20), 802.11ax (HE20):

Channel	Frequency	Channel	Frequency
52	5260 MHz	60	5300 MHz
56	5280 MHz	64	5320 MHz

2 channels are provided for 802.11n (HT40), 802.11ac (VHT40), 802.11ax (HE40):

Channel	Frequency	Channel	Frequency
54	5270 MHz	62	5310 MHz

1 channel is provided for 802.11ac (VHT80), 802.11ax (HE80):

Channel	Frequency
58	5290 MHz

FOR 5500 ~ 5720MHz

12 channels are provided for 802.11a, 802.11n (HT20), 802.11ac (VHT20), 802.11ax (HE20):

Channel	Frequency	Channel	Frequency
100	5500 MHz	124	5620 MHz
104	5520 MHz	128	5640 MHz
108	5540 MHz	132	5660 MHz
112	5560 MHz	136	5680 MHz
116	5580 MHz	140	5700 MHz
120	5600 MHz	144	5720 MHz

6 channels are provided for 802.11n (HT40), 802.11ac (VHT40), 802.11ax (HE40):

Channel	Frequency	Channel	Frequency
102	5510 MHz	126	5630 MHz
110	5550 MHz	134	5670 MHz
118	5590 MHz	142	5710 MHz

3 channels are provided for 802.11ac (VHT80), 802.11ax (HE80):

Channel	Frequency	Channel	Frequency
106	5530 MHz	138	5690 MHz
122	5610 MHz		

3.2.1 Test Mode Applicability and Tested Channel Detail

EUT Configure Mode	Applicable To				Description
	RE≥1G	RE<1G	PLC	APCM	
-	√	√	√	√	-

Where **RE≥1G**: Radiated Emission above 1GHz **RE<1G**: Radiated Emission below 1GHz
PLC: Power Line Conducted Emission **APCM**: Antenna Port Conducted Measurement

Radiated Emission Test (Above 1GHz):

- Pre-Scan has been conducted to determine the worst-case mode from all possible combinations between available modulations, data rates and antenna ports (if EUT with antenna diversity architecture).
- Following channel(s) was (were) selected for the final test as listed below.

CDD Mode						
Mode	FREQ. Band (MHz)	Available Channel	Tested Channel	Modulation Technology	Modulation Type	Data Rate Parameter
802.11a	5260-5320	52 to 64	52, 60, 64	OFDM	BPSK	6Mb/s
802.11a	5500-5720	100 to 144	100, 116, 140, 144	OFDM	BPSK	6Mb/s
Beamforming Mode						
Mode	FREQ. Band (MHz)	Available Channel	Tested Channel	Modulation Technology	Modulation Type	Data Rate Parameter
802.11ax (HE20)	5260-5320	52 to 64	52, 60, 64	OFDMA	BPSK	MCS0
802.11ax (HE40)		54 to 62	54, 62	OFDMA	BPSK	MCS0
802.11ax (HE80)		58	58	OFDMA	BPSK	MCS0
802.11ax (HE20)	5500-5720	100 to 144	100, 116, 140, 144	OFDMA	BPSK	MCS0
802.11ax (HE40)		102 to 142	102, 110, 134, 142	OFDMA	BPSK	MCS0
802.11ax (HE80)		106 to 138	106, 122, 138	OFDMA	BPSK	MCS0

Radiated Emission Test (Below 1GHz):

- Pre-Scan has been conducted to determine the worst-case mode from all possible combinations between available modulations, data rates and antenna ports (if EUT with antenna diversity architecture).
- Following channel(s) was (were) selected for the final test as listed below.

CDD Mode						
Mode	FREQ. Band (MHz)	Available Channel	Tested Channel	Modulation Technology	Modulation Type	Data Rate Parameter
802.11a	5260-5320 5500-5720	52, 60, 64 100, 116, 140, 144	144	OFDM	BPSK	6Mb/s

Power Line Conducted Emission Test:

- Pre-Scan has been conducted to determine the worst-case mode from all possible combinations between available modulations, data rates and antenna ports (if EUT with antenna diversity architecture).
- Following channel(s) was (were) selected for the final test as listed below.

CDD Mode						
Mode	FREQ. Band (MHz)	Available Channel	Tested Channel	Modulation Technology	Modulation Type	Data Rate Parameter
802.11a	5260-5320 5500-5720	52, 60, 64 100, 116, 140, 144	144	OFDM	BPSK	6Mb/s

Antenna Port Conducted Measurement:

- This item includes all test value of each mode, but only includes spectrum plot of worst value of each mode.
- Pre-Scan has been conducted to determine the worst-case mode from all possible combinations between available modulations, data rates and antenna ports (if EUT with antenna diversity architecture).
- Following channel(s) was (were) selected for the final test as listed below.

CDD Mode						
Mode	FREQ. Band (MHz)	Available Channel	Tested Channel	Modulation Technology	Modulation Type	Data Rate Parameter
802.11a	5260-5320	52 to 64	52, 60, 64	OFDM	BPSK	6Mb/s
802.11a	5500-5720	100 to 144	100, 116, 140, 144	OFDM	BPSK	6Mb/s
Beamforming Mode						
Mode	FREQ. Band (MHz)	Available Channel	Tested Channel	Modulation Technology	Modulation Type	Data Rate Parameter
802.11ac (VHT20) (Output power only)	5260-5320	52 to 64	52, 60, 64	OFDM	BPSK	MCS0
802.11ac (VHT40) (Output power only)		54 to 62	54, 62	OFDM	BPSK	MCS0
802.11ac (VHT80) (Output power only)		58	58	OFDM	BPSK	MCS0
802.11ax (HE20)		52 to 64	52, 60, 64	OFDMA	BPSK	MCS0
802.11ax (HE40)		54 to 62	54, 62	OFDMA	BPSK	MCS0
802.11ax (HE80)		58	58	OFDMA	BPSK	MCS0
802.11ac (VHT20) (Output power only)	5500-5720	100 to 144	100, 116, 140, 144	OFDM	BPSK	MCS0
802.11ac (VHT40) (Output power only)		102 to 142	102, 110, 134, 142	OFDM	BPSK	MCS0
802.11ac (VHT80) (Output power only)		106 to 138	106, 122, 138	OFDM	BPSK	MCS0
802.11ax (HE20)		100 to 144	100, 116, 140, 144	OFDMA	BPSK	MCS0
802.11ax (HE40)		102 to 142	102, 110, 134, 142	OFDMA	BPSK	MCS0
802.11ax (HE80)		106 to 138	106, 122, 138	OFDMA	BPSK	MCS0

Test Condition:

Applicable To	Environmental Conditions	Input Power	Tested By
RE \geq 1G	25deg. C, 75%RH	120Vac, 60Hz	Kevin Ko
RE<1G	23deg. C, 65%RH	120Vac, 60Hz	Tom Yang
PLC	25deg. C, 75%RH	120Vac, 60Hz	Kevin Ko
APCM	26deg. C, 72%RH	120Vac, 60Hz	Andy Ho

3.3 Duty Cycle of Test Signal

If duty cycle of test signal is < 98%, duty factor shall be considered.

802.11a: Duty cycle = 0.528 ms/0.559 ms = 0.945, Duty factor = $10 * \log(1/\text{Duty cycle}) = 0.25 \text{ dB}$

802.11ax (HE20): Duty cycle = 0.464 ms/0.494 ms = 0.939, Duty factor = $10 * \log(1/\text{Duty cycle}) = 0.27 \text{ dB}$

802.11ax (HE40): Duty cycle = 0.684 ms/0.717 ms = 0.954, Duty factor = $10 * \log(1/\text{Duty cycle}) = 0.20 \text{ dB}$

802.11ax (HE80): Duty cycle = 0.685 ms/0.717 ms = 0.955, Duty factor = $10 * \log(1/\text{Duty cycle}) = 0.20 \text{ dB}$

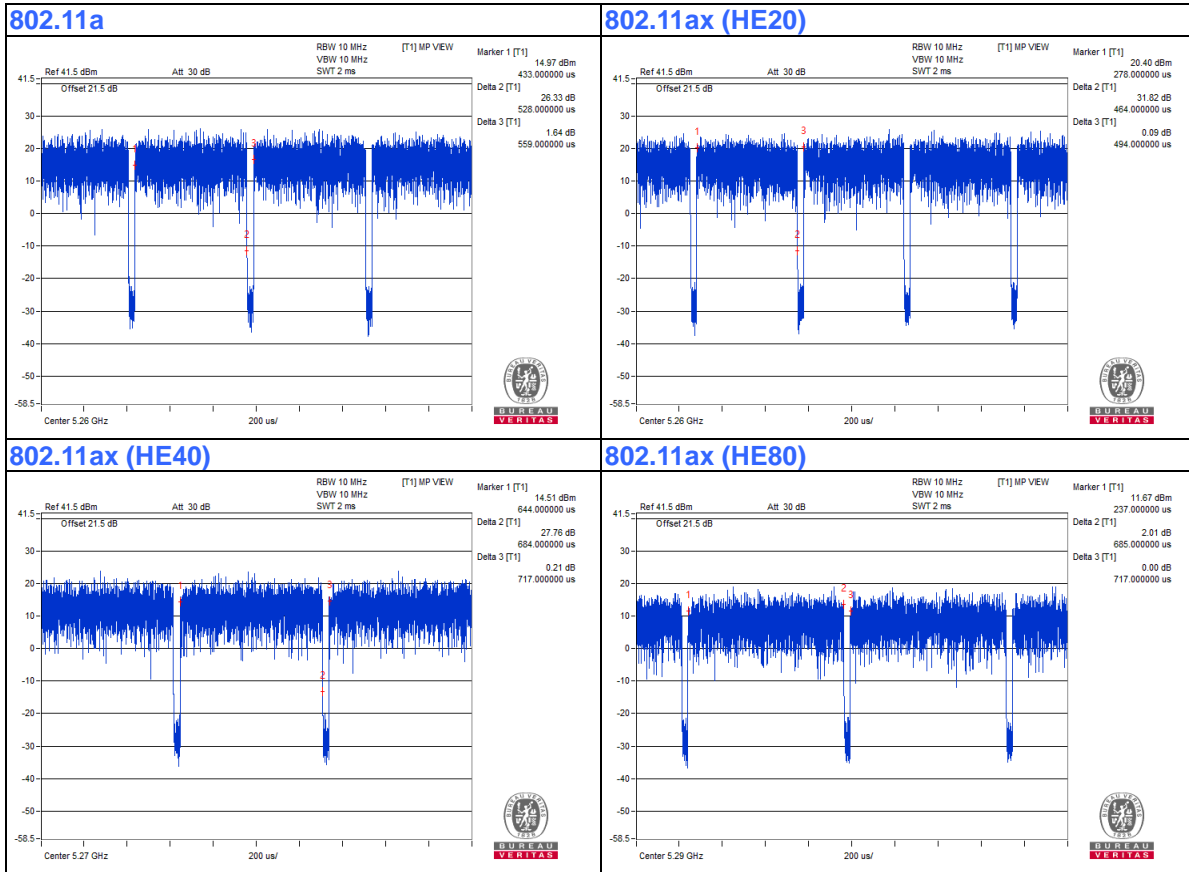

3.4 Description of Support Units

The EUT has been tested as an independent unit together with other necessary accessories or support units. The following support units or accessories were used to form a representative test configuration during the tests.

ID	Product	Brand	Model No.	Serial No.	FCC ID	Remarks
A.	Laptop	DELL	E6420	B92T3R1	FCC DoC	Provided by Lab
B.	Laptop	DELL	E5430	HYV4VY1	FCC DoC	Provided by Lab
C.	USB 3.0 Disk	SanDisk	BM181225896Z	NA	NA	Provided by Lab

Note:

1. All power cords of the above support units are non-shielded (1.8m).

ID	Descriptions	Qty.	Length (m)	Shielding (Yes/No)	Cores (Qty.)	Remarks
1.	RJ-45 Cable	1	10	No	0	Provided by Lab
2.	RJ-45 Cable	1	10	No	0	Provided by Lab
3.	DC Cable	1	1.5	No	0	Supplied by client

3.4.1 Configuration of System under Test

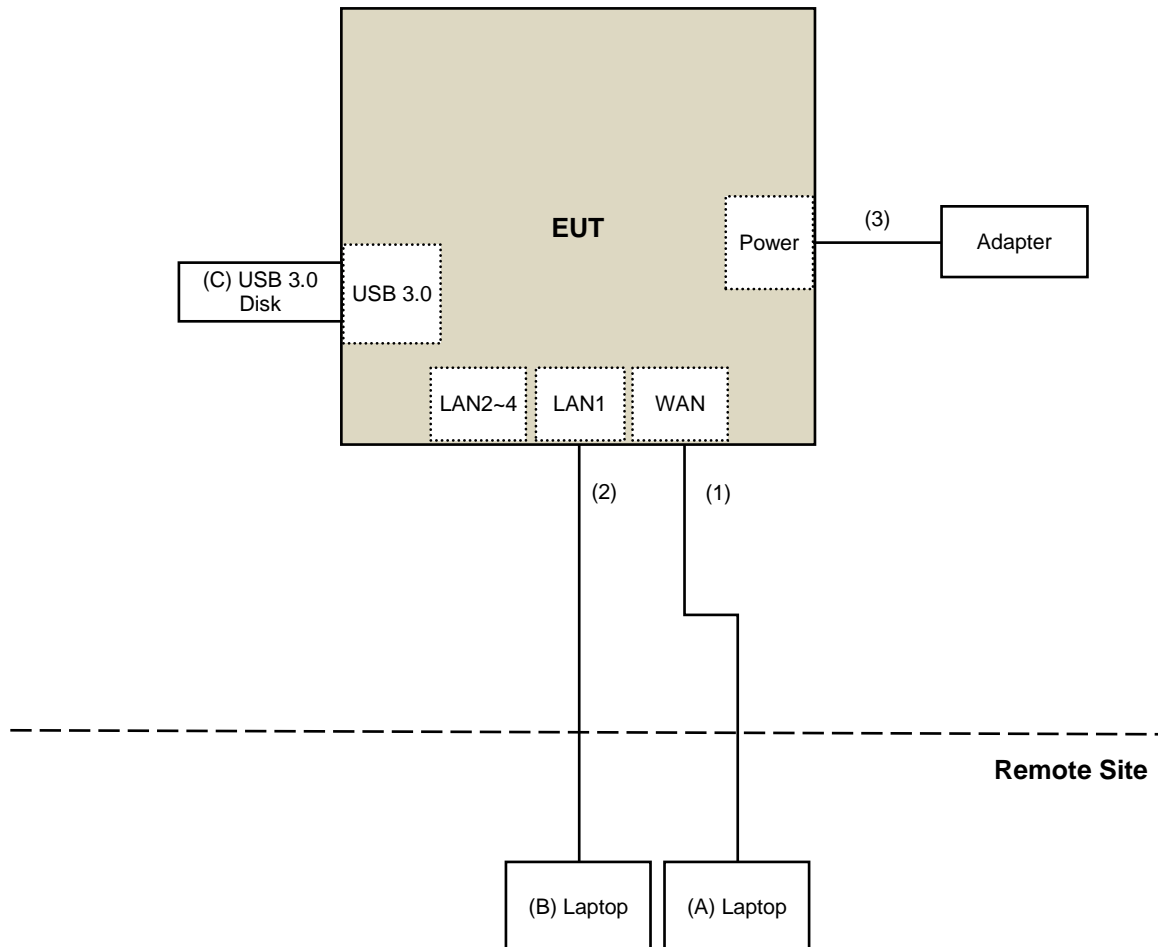

3.5 General Description of Applied Standards and References

The EUT is a RF Product. According to the specifications of the manufacturer, it must comply with the requirements of the following standards and references:

Test standard:

FCC Part 15, Subpart E (15.407)

ANSI C63.10-2013

All test items have been performed and recorded as per the above standards.

References Test Guidance:

KDB 789033 D02 General UNII Test Procedure New Rules v02r01

KDB 662911 D01 Multiple Transmitter Output v02r01

All test items have been performed as a reference to the above KDB test guidance.

4 Test Types and Results

4.1 Radiated Emission and Bandedge Measurement

4.1.1 Limits of Radiated Emission and Bandedge Measurement

Radiated emissions which fall in the restricted bands must comply with the radiated emission limits specified as below table.

Frequencies (MHz)	Field Strength (microvolts/meter)	Measurement Distance (meters)
0.009 ~ 0.490	2400/F(kHz)	300
0.490 ~ 1.705	24000/F(kHz)	30
1.705 ~ 30.0	30	30
30 ~ 88	100	3
88 ~ 216	150	3
216 ~ 960	200	3
Above 960	500	3

NOTE:

- The lower limit shall apply at the transition frequencies.
- Emission level (dBuV/m) = 20 log Emission level (uV/m).
- For frequencies above 1000MHz, the field strength limits are based on average detector, however, the peak field strength of any emission shall not exceed the maximum permitted average limits, specified above by more than 20dB under any condition of modulation.

Limits of unwanted emission out of the restricted bands

Applicable To		Limit	
789033 D02 General UNII Test Procedure New Rules v02r01		Field Strength at 3m	
		PK:74 (dBμV/m)	AV:54 (dBμV/m)
Frequency Band	Applicable To	EIRP Limit	Equivalent Field Strength at 3m
5150~5250 MHz	15.407(b)(1)	PK:-27 (dBm/MHz)	PK:68.2(dBμV/m)
5250~5350 MHz	15.407(b)(2)		
5470~5725 MHz	15.407(b)(3)		
5725~5850 MHz	15.407(b)(4)(i)	PK:-27 (dBm/MHz) ^{*1} PK:10 (dBm/MHz) ^{*2} PK:15.6 (dBm/MHz) ^{*3} PK:27 (dBm/MHz) ^{*4}	PK: 68.2(dBμV/m) ^{*1} PK:105.2 (dBμV/m) ^{*2} PK: 110.8(dBμV/m) ^{*3} PK:122.2 (dBμV/m) ^{*4}
^{*1} beyond 75 MHz or more above of the band edge.		^{*2} below the band edge increasing linearly to 10 dBm/MHz at 25 MHz above.	
^{*3} below the band edge increasing linearly to a level of 15.6 dBm/MHz at 5 MHz above.		^{*4} from 5 MHz above or below the band edge increasing linearly to a level of 27 dBm/MHz at the band edge.	

Note:

The following formula is used to convert the equipment isotropic radiated power (eirp) to field strength:

$$E = \frac{1000000\sqrt{30P}}{3} \mu\text{V/m, where } P \text{ is the eirp (Watts).}$$

4.1.2 Test Instruments

For Radiated Emission below 1GHz Test:

DESCRIPTION & MANUFACTURER	MODEL NO.	SERIAL NO.	CALIBRATED DATE	CALIBRATED UNTIL
Test Receiver Agilent	N9038A	MY51210202	Dec. 13, 2019	Dec. 12, 2020
Pre-Amplifier EMCI	EMC001340	980142	May 30, 2019	May 29, 2020
Loop Antenna Electro-Metrics	EM-6879	264	Jan. 22, 2019	Jan. 21, 2020
RF Cable	NA	LOOPCAB-001	Jan. 08, 2020	Jan. 07, 2021
RF Cable	NA	LOOPCAB-002	Jan. 08, 2020	Jan. 07, 2021
Pre-Amplifier Mini-Circuits	ZFL-1000VH2B	AMP-ZFL-01	Oct. 23, 2019	Oct. 22, 2020
Trilog Broadband Antenna SCHWARZBECK	VULB 9168	9168-406	Nov. 11, 2019	Nov. 10, 2020
RF Cable	8D	966-4-1	Mar. 19, 2019	Mar. 18, 2020
RF Cable	8D	966-4-2	Mar. 19, 2019	Mar. 18, 2020
RF Cable	8D	966-4-3	Mar. 19, 2019	Mar. 18, 2020
Fixed attenuator Mini-Circuits	UNAT-5+	PAD-3m-4-01	Sep. 26, 2019	Sep. 25, 2020
Software	ADT_Radiated_V8.7.08	NA	NA	NA
Boresight Antenna Tower & Turn Table Max-Full	MF-7802BS	MF780208530	NA	NA

Note:

1. The calibration interval of the above test instruments is 12 months and the calibrations are traceable to NML/ROC and NIST/USA.
2. The test was performed in 966 Chamber No. 4.
3. Tested Date: Jan. 13, 2020

For Radiated Emission above 1GHz Test:

DESCRIPTION & MANUFACTURER	MODEL NO.	SERIAL NO.	CALIBRATED DATE	CALIBRATED UNTIL
Test Receiver Agilent	N9038A	MY51210202	Dec. 13, 2019	Dec. 12, 2020
Horn_Antenna SCHWARZBECK	BBHA 9120D	9120D-783	Nov. 24, 2019	Nov. 23, 2020
Pre-Amplifier EMCI	EMC12630SE	980385	Aug. 15, 2019	Aug. 14, 2020
RF Cable	EMC104-SM-SM-1200	160923	Jan. 15, 2020	Jan. 14, 2021
RF Cable	EMC104-SM-SM-2000	180502	Apr. 29, 2020	Apr. 28, 2021
RF Cable	EMC104-SM-SM-6000	180418	Apr. 29, 2020	Apr. 28, 2021
Pre-Amplifier EMCI	EMC184045SE	980387	Jan. 15, 2020	Jan. 14, 2021
Horn_Antenna SCHWARZBECK	BBHA 9170	BBHA9170519	Nov. 24, 2019	Nov. 23, 2020
RF Cable	EMC102-KM-KM-1200	160924	Jan. 15, 2020	Jan. 14, 2021
RF Cable	EMC-KM-KM-4000	200214	Mar. 11, 2020	Mar. 10, 2021
Software	ADT_Radiated_V8.7.08	NA	NA	NA
Boresight Antenna Tower & Turn Table Max-Full	MF-7802BS	MF780208530	NA	NA

Note:

1. The calibration interval of the above test instruments is 12 months and the calibrations are traceable to NML/ROC and NIST/USA.
2. The test was performed in 966 Chamber No. 4.
3. Tested Date: May 03, 2020

For other test items:

DESCRIPTION & MANUFACTURER	MODEL NO.	SERIAL NO.	CALIBRATED DATE	CALIBRATED UNTIL
Spectrum Analyzer R&S	FSV40	100964	June 04, 2019	June 03, 2020
Power meter Anritsu	ML2495A	1014008	May 13, 2019	May 12, 2020
Power sensor Anritsu	MA2411B	0917122	May 13, 2019	May 12, 2020
Fixed Attenuator Mini-Circuits	MDCS18N-10	MDCS18N-10-01	Apr. 14, 2020	Apr. 13, 2021
AC Power Source Extech Electronics	6205	1440452	NA	NA
Temperature & Humidity Chamber Giant Force	GTH-150-40-SP- AR	MAA0812-008	Jan. 16, 2020	Jan. 15, 2021
True RMS Clamp Meter FLUKE	325	31130711WS	May 21, 2019	May 20, 2020
Software	ADT_RF Test Software V6.6.5.4	NA	NA	NA

- NOTE:**
1. The test was performed in Oven room 2.
 2. The calibration interval of the above test instruments is 12 months and the calibrations are traceable to NML/ROC and NIST/USA.
 3. Tested Date: May 07, 2020

4.1.3 Test Procedure

For Radiated emission below 30MHz

- a. The EUT was placed on the top of a rotating table 0.8 meters above the ground at a 3 meter chamber room. The table was rotated 360 degrees to determine the position of the highest radiation.
- b. The EUT was set 3 meters away from the interference-receiving antenna, which was mounted on the top of a variable-height antenna tower.
- c. Parallel, perpendicular, and ground-parallel orientations of the antenna are set to make the measurement.
- d. For each suspected emission, the EUT was arranged to its worst case and the rotatable table was turned from 0 degrees to 360 degrees to find the maximum reading.
- e. The test-receiver system was set to Quasi-Peak Detect Function and Specified Bandwidth with Maximum Hold Mode.

Note:

1. The resolution bandwidth and video bandwidth of test receiver/spectrum analyzer is 9kHz at frequency below 30MHz.

For Radiated emission above 30MHz

- a. The EUT was placed on the top of a rotating table 0.8 meters (for 30MHz ~ 1GHz) / 1.5 meters (for above 1GHz) above the ground at 3 meter chamber room for test. The table was rotated 360 degrees to determine the position of the highest radiation.
- b. The EUT was set 3 meters away from the interference-receiving antenna, which was mounted on the top of a variable-height antenna tower.
- c. The height of antenna is varied from one meter to four meters above the ground to determine the maximum value of the field strength. Both horizontal and vertical polarizations of the antenna are set to make the measurement.
- d. For each suspected emission, the EUT was arranged to its worst case and then the antenna was tuned to heights from 1 meter to 4 meters and the rotatable table was turned from 0 degrees to 360 degrees to find the maximum reading.
- e. The test-receiver system was set to quasi-peak detect function and specified bandwidth with maximum hold mode when the test frequency is below 1 GHz.
- f. The test-receiver system was set to peak and average detects function and specified bandwidth with maximum hold mode when the test frequency is above 1 GHz. If the peak reading value also meets average limit, measurement with the average detector is unnecessary.

Note:

1. The resolution bandwidth and video bandwidth of test receiver/spectrum analyzer is 120kHz for Quasi-peak detection (QP) at frequency below 1GHz.
2. The resolution bandwidth of test receiver/spectrum analyzer is 1 MHz and the video bandwidth is 3 MHz for Peak detection (PK) at frequency above 1GHz.
3. The resolution bandwidth of test receiver/spectrum analyzer is 1MHz and the video bandwidth is $\geq 1/T$ (Duty cycle < 98%) or 10Hz (Duty cycle $\geq 98\%$) for Average detection (AV) at frequency above 1GHz.
4. All modes of operation were investigated and the worst-case emissions are reported.

4.1.4 Deviation from Test Standard

No deviation.

4.1.5 Test Setup

For Radiated emission below 30MHz

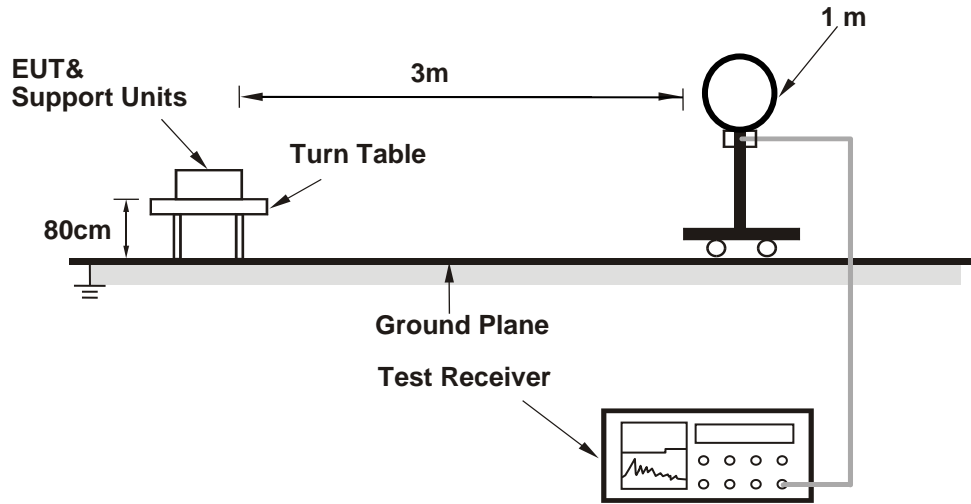

For Radiated emission 30MHz to 1GHz

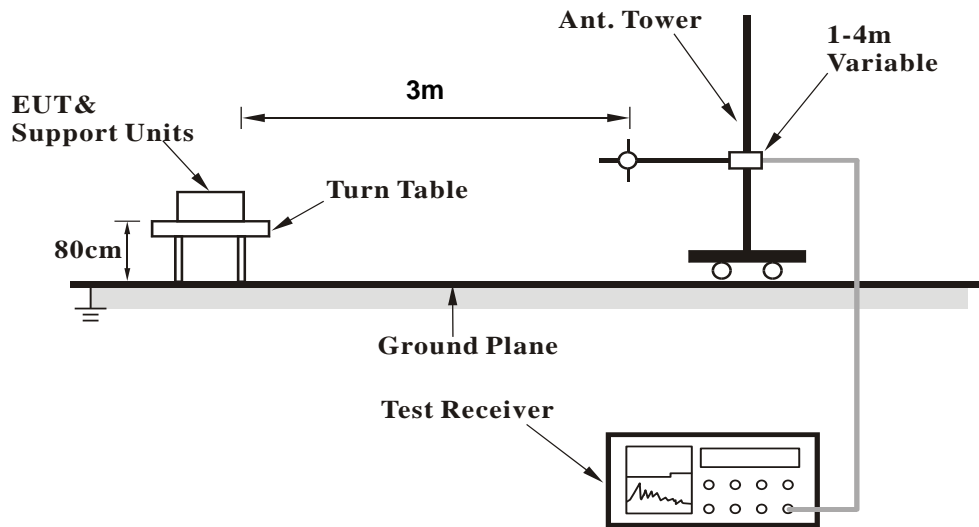

For Radiated emission above 1GHz

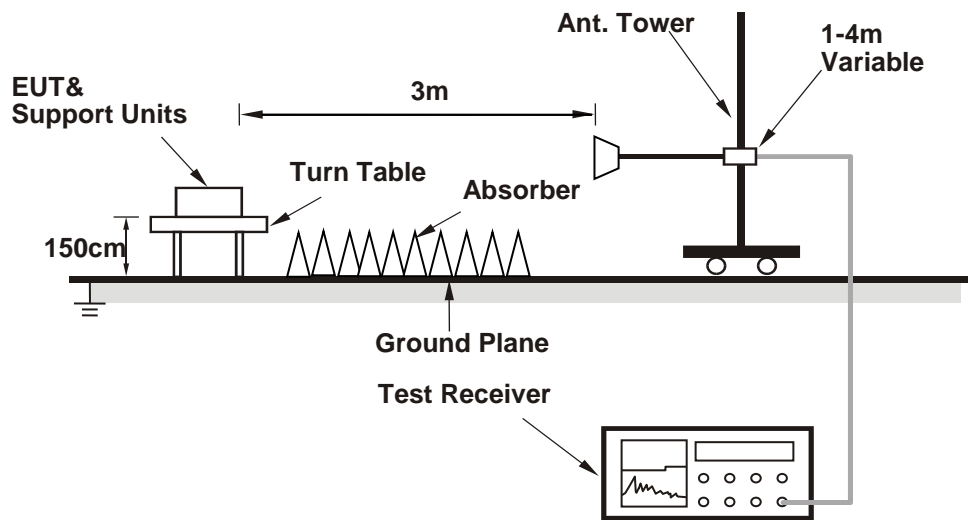

For the actual test configuration, please refer to the attached file (Test Setup Photo).

4.1.6 EUT Operating Condition

- Connected the EUT with the Laptop which is placed on remote site.
- Controlling software (qdart_conn.win.1.0_installer_00073.2 for CDD mode; paste Hyperterminal MR7350 TxBf EMI command for Beamforming mode) has been activated to set the EUT under transmission condition continuously at specific channel frequency.

4.1.7 Test Results

Above 1GHz Data:

802.11a

CHANNEL	TX Channel 52	DETECTOR FUNCTION	Peak (PK)
FREQUENCY RANGE	1GHz ~ 40GHz		Average (AV)

ANTENNA POLARITY & TEST DISTANCE: HORIZONTAL AT 3 M

NO.	FREQ. (MHz)	EMISSION LEVEL (dBuV/m)	LIMIT (dBuV/m)	MARGIN (dB)	ANTENNA HEIGHT (m)	TABLE ANGLE (Degree)	RAW VALUE (dBuV)	CORRECTION FACTOR (dB/m)
1	*5260.00	117.1 PK			1.49 H	355	113.9	3.2
2	*5260.00	104.7 AV			1.49 H	355	101.5	3.2
3	5376.05	49.7 PK	74.0	-24.3	1.49 H	355	46.4	3.3
4	5376.05	41.1 AV	54.0	-12.9	1.49 H	355	37.8	3.3
5	#10520.00	44.9 PK	68.2	-23.3	1.83 H	270	31.0	13.9
6	15780.00	57.1 PK	74.0	-16.9	1.65 H	25	43.4	13.7
7	15780.00	45.3 AV	54.0	-8.7	1.65 H	25	31.6	13.7

ANTENNA POLARITY & TEST DISTANCE: VERTICAL AT 3 M

NO.	FREQ. (MHz)	EMISSION LEVEL (dBuV/m)	LIMIT (dBuV/m)	MARGIN (dB)	ANTENNA HEIGHT (m)	TABLE ANGLE (Degree)	RAW VALUE (dBuV)	CORRECTION FACTOR (dB/m)
1	*5260.00	122.5 PK			1.52 V	11	119.3	3.2
2	*5260.00	114.4 AV			1.52 V	11	111.2	3.2
3	5350.00	57.4 PK	74.0	-16.6	1.52 V	11	54.0	3.4
4	5350.00	47.6 AV	54.0	-6.4	1.52 V	11	44.2	3.4
5	#10520.00	46.2 PK	68.2	-22.0	2.00 V	291	32.3	13.9
6	15780.00	60.9 PK	74.0	-13.1	1.08 V	156	47.2	13.7
7	15780.00	50.1 AV	54.0	-3.9	1.08 V	156	36.4	13.7

REMARKS:

1. Emission Level(dBuV/m) = Raw Value(dBuV) + Correction Factor(dB/m)
2. Correction Factor(dB/m) = Antenna Factor(dB/m) + Cable Factor(dB) – Pre-Amplifier Factor(dB)
3. Margin value = Emission Level – Limit value
4. The other emission levels were very low against the limit.
5. " * ": Fundamental frequency.
6. " # ": The radiated frequency is out of the restricted band.

CHANNEL	TX Channel 60	DETECTOR FUNCTION	Peak (PK)
FREQUENCY RANGE	1GHz ~ 40GHz		Average (AV)

ANTENNA POLARITY & TEST DISTANCE: HORIZONTAL AT 3 M

NO.	FREQ. (MHz)	EMISSION LEVEL (dBuV/m)	LIMIT (dBuV/m)	MARGIN (dB)	ANTENNA HEIGHT (m)	TABLE ANGLE (Degree)	RAW VALUE (dBuV)	CORRECTION FACTOR (dB/m)
1	*5300.00	117.4 PK			1.52 H	319	114.1	3.3
2	*5300.00	104.9 AV			1.52 H	319	101.6	3.3
3	5350.00	53.4 PK	74.0	-20.6	1.52 H	319	50.0	3.4
4	5350.00	41.2 AV	54.0	-12.8	1.52 H	319	37.8	3.4
5	10600.00	44.5 PK	74.0	-29.5	1.81 H	260	31.0	13.5
6	10600.00	34.9 AV	54.0	-19.1	1.81 H	260	21.4	13.5
7	15900.00	57.3 PK	74.0	-16.7	1.74 H	19	44.0	13.3
8	15900.00	46.0 AV	54.0	-8.0	1.74 H	19	32.7	13.3

ANTENNA POLARITY & TEST DISTANCE: VERTICAL AT 3 M

NO.	FREQ. (MHz)	EMISSION LEVEL (dBuV/m)	LIMIT (dBuV/m)	MARGIN (dB)	ANTENNA HEIGHT (m)	TABLE ANGLE (Degree)	RAW VALUE (dBuV)	CORRECTION FACTOR (dB/m)
1	*5300.00	123.8 PK			1.59 V	12	120.5	3.3
2	*5300.00	114.9 AV			1.59 V	12	111.6	3.3
3	5350.00	61.8 PK	74.0	-12.2	1.59 V	12	58.4	3.4
4	5350.00	50.5 AV	54.0	-3.5	1.59 V	12	47.1	3.4
5	10600.00	45.3 PK	74.0	-28.7	2.12 V	275	31.8	13.5
6	10600.00	34.3 AV	54.0	-19.7	2.12 V	275	20.8	13.5
7	15900.00	61.0 PK	74.0	-13.0	1.04 V	149	47.7	13.3
8	15900.00	49.7 AV	54.0	-4.3	1.04 V	149	36.4	13.3

REMARKS:

1. Emission Level(dBuV/m) = Raw Value(dBuV) + Correction Factor(dB/m)
2. Correction Factor(dB/m) = Antenna Factor(dB/m) + Cable Factor(dB) – Pre-Amplifier Factor(dB)
3. Margin value = Emission Level – Limit value
4. The other emission levels were very low against the limit.
5. " * ": Fundamental frequency.

CHANNEL	TX Channel 64	DETECTOR FUNCTION	Peak (PK)
FREQUENCY RANGE	1GHz ~ 40GHz		Average (AV)

ANTENNA POLARITY & TEST DISTANCE: HORIZONTAL AT 3 M

NO.	FREQ. (MHz)	EMISSION LEVEL (dBuV/m)	LIMIT (dBuV/m)	MARGIN (dB)	ANTENNA HEIGHT (m)	TABLE ANGLE (Degree)	RAW VALUE (dBuV)	CORRECTION FACTOR (dB/m)
1	*5320.00	111.1 PK			1.48 H	329	107.8	3.3
2	*5320.00	101.7 AV			1.48 H	329	98.4	3.3
3	5350.00	51.1 PK	74.0	-22.9	1.48 H	329	47.7	3.4
4	5350.00	41.4 AV	54.0	-12.6	1.48 H	329	38.0	3.4
5	10640.00	45.2 PK	74.0	-28.8	1.81 H	263	31.5	13.7
6	10640.00	33.4 AV	54.0	-20.6	1.81 H	263	19.7	13.7
7	15960.00	57.0 PK	74.0	-17.0	1.60 H	23	43.4	13.6
8	15960.00	45.4 AV	54.0	-8.6	1.60 H	23	31.8	13.6

ANTENNA POLARITY & TEST DISTANCE: VERTICAL AT 3 M

NO.	FREQ. (MHz)	EMISSION LEVEL (dBuV/m)	LIMIT (dBuV/m)	MARGIN (dB)	ANTENNA HEIGHT (m)	TABLE ANGLE (Degree)	RAW VALUE (dBuV)	CORRECTION FACTOR (dB/m)
1	*5320.00	121.4 PK			1.60 V	12	118.1	3.3
2	*5320.00	112.8 AV			1.60 V	12	109.5	3.3
3	5350.00	60.3 PK	74.0	-13.7	1.60 V	12	56.9	3.4
4	5350.00	52.8 AV	54.0	-1.2	1.60 V	12	49.4	3.4
5	10640.00	45.9 PK	74.0	-28.1	2.11 V	310	32.2	13.7
6	10640.00	33.8 AV	54.0	-20.2	2.11 V	310	20.1	13.7
7	15960.00	61.4 PK	74.0	-12.6	1.00 V	137	47.8	13.6
8	15960.00	49.1 AV	54.0	-4.9	1.00 V	137	35.5	13.6

REMARKS:

1. Emission Level(dBuV/m) = Raw Value(dBuV) + Correction Factor(dB/m)
2. Correction Factor(dB/m) = Antenna Factor(dB/m) + Cable Factor(dB) – Pre-Amplifier Factor(dB)
3. Margin value = Emission Level – Limit value
4. The other emission levels were very low against the limit.
5. " * ": Fundamental frequency.

CHANNEL	TX Channel 100	DETECTOR FUNCTION	Peak (PK)
FREQUENCY RANGE	1GHz ~ 40GHz		Average (AV)

ANTENNA POLARITY & TEST DISTANCE: HORIZONTAL AT 3 M

NO.	FREQ. (MHz)	EMISSION LEVEL (dBuV/m)	LIMIT (dBuV/m)	MARGIN (dB)	ANTENNA HEIGHT (m)	TABLE ANGLE (Degree)	RAW VALUE (dBuV)	CORRECTION FACTOR (dB/m)
1	5460.00	49.8 PK	74.0	-24.2	1.57 H	318	46.2	3.6
2	5460.00	39.3 AV	54.0	-14.7	1.57 H	318	35.7	3.6
3	#5470.00	58.4 PK	68.2	-9.8	1.57 H	318	54.8	3.6
4	*5500.00	110.8 PK			1.57 H	318	107.1	3.7
5	*5500.00	102.4 AV			1.57 H	318	98.7	3.7
6	11000.00	45.4 PK	74.0	-28.6	1.86 H	273	31.4	14.0
7	11000.00	33.2 AV	54.0	-20.8	1.86 H	273	19.2	14.0
8	#16500.00	56.6 PK	68.2	-11.6	1.75 H	27	40.8	15.8

ANTENNA POLARITY & TEST DISTANCE: VERTICAL AT 3 M

NO.	FREQ. (MHz)	EMISSION LEVEL (dBuV/m)	LIMIT (dBuV/m)	MARGIN (dB)	ANTENNA HEIGHT (m)	TABLE ANGLE (Degree)	RAW VALUE (dBuV)	CORRECTION FACTOR (dB/m)
1	5460.00	59.7 PK	74.0	-14.3	1.92 V	346	56.1	3.6
2	5460.00	46.5 AV	54.0	-7.5	1.92 V	346	42.9	3.6
3	#5470.00	67.1 PK	68.2	-1.1	1.92 V	346	63.5	3.6
4	*5500.00	121.5 PK			1.92 V	346	117.8	3.7
5	*5500.00	112.5 AV			1.92 V	346	108.8	3.7
6	11000.00	46.4 PK	74.0	-27.6	2.15 V	269	32.4	14.0
7	11000.00	34.2 AV	54.0	-19.8	2.15 V	269	20.2	14.0
8	#16500.00	60.9 PK	68.2	-7.3	1.12 V	139	45.1	15.8

REMARKS:

1. Emission Level(dBuV/m) = Raw Value(dBuV) + Correction Factor(dB/m)
2. Correction Factor(dB/m) = Antenna Factor(dB/m) + Cable Factor(dB) – Pre-Amplifier Factor(dB)
3. Margin value = Emission Level – Limit value
4. The other emission levels were very low against the limit.
5. " * ": Fundamental frequency.
6. " # ": The radiated frequency is out of the restricted band.

CHANNEL	TX Channel 116	DETECTOR FUNCTION	Peak (PK)
FREQUENCY RANGE	1GHz ~ 40GHz		Average (AV)

ANTENNA POLARITY & TEST DISTANCE: HORIZONTAL AT 3 M

NO.	FREQ. (MHz)	EMISSION LEVEL (dBuV/m)	LIMIT (dBuV/m)	MARGIN (dB)	ANTENNA HEIGHT (m)	TABLE ANGLE (Degree)	RAW VALUE (dBuV)	CORRECTION FACTOR (dB/m)
1	*5580.00	116.3 PK			1.58 H	311	112.5	3.8
2	*5580.00	103.8 AV			1.58 H	311	100.0	3.8
3	11160.00	45.0 PK	74.0	-29.0	1.78 H	277	31.3	13.7
4	11160.00	33.0 AV	54.0	-21.0	1.78 H	277	19.3	13.7
5	#16740.00	56.4 PK	68.2	-11.8	1.64 H	16	39.4	17.0

ANTENNA POLARITY & TEST DISTANCE: VERTICAL AT 3 M

NO.	FREQ. (MHz)	EMISSION LEVEL (dBuV/m)	LIMIT (dBuV/m)	MARGIN (dB)	ANTENNA HEIGHT (m)	TABLE ANGLE (Degree)	RAW VALUE (dBuV)	CORRECTION FACTOR (dB/m)
1	*5580.00	122.8 PK			1.76 V	360	119.0	3.8
2	*5580.00	113.5 AV			1.76 V	360	109.7	3.8
3	11160.00	46.9 PK	74.0	-27.1	2.14 V	261	33.2	13.7
4	11160.00	34.0 AV	54.0	-20.0	2.14 V	261	20.3	13.7
5	#16740.00	58.9 PK	68.2	-9.3	1.10 V	143	41.9	17.0

REMARKS:

1. Emission Level(dBuV/m) = Raw Value(dBuV) + Correction Factor(dB/m)
2. Correction Factor(dB/m) = Antenna Factor(dB/m) + Cable Factor(dB) – Pre-Amplifier Factor(dB)
3. Margin value = Emission Level – Limit value
4. The other emission levels were very low against the limit.
5. " * ": Fundamental frequency.
6. " # ": The radiated frequency is out of the restricted band.

CHANNEL	TX Channel 140	DETECTOR FUNCTION	Peak (PK)
FREQUENCY RANGE	1GHz ~ 40GHz		Average (AV)

ANTENNA POLARITY & TEST DISTANCE: HORIZONTAL AT 3 M

NO.	FREQ. (MHz)	EMISSION LEVEL (dBuV/m)	LIMIT (dBuV/m)	MARGIN (dB)	ANTENNA HEIGHT (m)	TABLE ANGLE (Degree)	RAW VALUE (dBuV)	CORRECTION FACTOR (dB/m)
1	*5700.00	112.4 PK			1.52 H	306	108.2	4.2
2	*5700.00	101.9 AV			1.52 H	306	97.7	4.2
3	#5725.00	59.4 PK	68.2	-8.8	1.52 H	306	55.2	4.2
4	11400.00	45.0 PK	74.0	-29.0	1.83 H	274	30.7	14.3
5	11400.00	33.1 AV	54.0	-20.9	1.83 H	274	18.8	14.3
6	#17100.00	56.9 PK	68.2	-11.3	1.79 H	34	39.2	17.7

ANTENNA POLARITY & TEST DISTANCE: VERTICAL AT 3 M

NO.	FREQ. (MHz)	EMISSION LEVEL (dBuV/m)	LIMIT (dBuV/m)	MARGIN (dB)	ANTENNA HEIGHT (m)	TABLE ANGLE (Degree)	RAW VALUE (dBuV)	CORRECTION FACTOR (dB/m)
1	*5700.00	121.3 PK			2.03 V	4	117.1	4.2
2	*5700.00	112.5 AV			2.03 V	4	108.3	4.2
3	#5725.00	66.9 PK	68.2	-1.3	2.03 V	4	62.7	4.2
4	11400.00	45.6 PK	74.0	-28.4	2.10 V	296	31.3	14.3
5	11400.00	33.4 AV	54.0	-20.6	2.10 V	296	19.1	14.3
6	#17100.00	60.8 PK	68.2	-7.4	1.12 V	129	43.1	17.7

REMARKS:

1. Emission Level(dBuV/m) = Raw Value(dBuV) + Correction Factor(dB/m)
2. Correction Factor(dB/m) = Antenna Factor(dB/m) + Cable Factor(dB) – Pre-Amplifier Factor(dB)
3. Margin value = Emission Level – Limit value
4. The other emission levels were very low against the limit.
5. " * ": Fundamental frequency.
6. " # ": The radiated frequency is out of the restricted band.

CHANNEL	TX Channel 144	DETECTOR FUNCTION	Peak (PK)
FREQUENCY RANGE	1GHz ~ 40GHz		Average (AV)

ANTENNA POLARITY & TEST DISTANCE: HORIZONTAL AT 3 M

NO.	FREQ. (MHz)	EMISSION LEVEL (dBuV/m)	LIMIT (dBuV/m)	MARGIN (dB)	ANTENNA HEIGHT (m)	TABLE ANGLE (Degree)	RAW VALUE (dBuV)	CORRECTION FACTOR (dB/m)
1	5460.00	46.8 PK	74.0	-27.2	1.55 H	321	43.2	3.6
2	5460.00	39.5 AV	54.0	-14.5	1.55 H	321	35.9	3.6
3	#5470.00	45.9 PK	68.2	-22.3	1.55 H	321	42.3	3.6
4	*5720.00	111.4 PK			1.55 H	321	107.2	4.2
5	*5720.00	101.8 AV			1.55 H	321	97.6	4.2
6	#5850.00	45.7 PK	68.2	-22.5	1.55 H	321	41.2	4.5
7	11440.00	45.3 PK	74.0	-28.7	1.83 H	279	31.0	14.3
8	11440.00	33.3 AV	54.0	-20.7	1.83 H	279	19.0	14.3
9	#17160.00	57.4 PK	68.2	-10.8	1.80 H	20	39.9	17.5

ANTENNA POLARITY & TEST DISTANCE: VERTICAL AT 3 M

NO.	FREQ. (MHz)	EMISSION LEVEL (dBuV/m)	LIMIT (dBuV/m)	MARGIN (dB)	ANTENNA HEIGHT (m)	TABLE ANGLE (Degree)	RAW VALUE (dBuV)	CORRECTION FACTOR (dB/m)
1	5460.00	55.6 PK	74.0	-18.4	1.99 V	360	52.0	3.6
2	5460.00	46.2 AV	54.0	-7.8	1.99 V	360	42.6	3.6
3	#5470.00	55.2 PK	68.2	-13.0	1.99 V	360	51.6	3.6
4	*5720.00	121.6 PK			1.99 V	360	117.4	4.2
5	*5720.00	112.9 AV			1.99 V	360	108.7	4.2
6	#5850.00	55.6 PK	68.2	-12.6	1.99 V	360	51.1	4.5
7	11440.00	46.7 PK	74.0	-27.3	2.22 V	238	32.4	14.3
8	11440.00	34.2 AV	54.0	-19.8	2.22 V	238	19.9	14.3
9	#17160.00	58.6 PK	68.2	-9.6	1.89 V	269	41.1	17.5

REMARKS:

1. Emission Level(dBuV/m) = Raw Value(dBuV) + Correction Factor(dB/m)
2. Correction Factor(dB/m) = Antenna Factor(dB/m) + Cable Factor(dB) – Pre-Amplifier Factor(dB)
3. Margin value = Emission Level – Limit value
4. The other emission levels were very low against the limit.
5. " * ": Fundamental frequency.
6. " # ": The radiated frequency is out of the restricted band.

802.11ax (HE20)

CHANNEL	TX Channel 52	DETECTOR FUNCTION	Peak (PK)
FREQUENCY RANGE	1GHz ~ 40GHz		Average (AV)

ANTENNA POLARITY & TEST DISTANCE: HORIZONTAL AT 3 M								
NO.	FREQ. (MHz)	EMISSION LEVEL (dBuV/m)	LIMIT (dBuV/m)	MARGIN (dB)	ANTENNA HEIGHT (m)	TABLE ANGLE (Degree)	RAW VALUE (dBuV)	CORRECTION FACTOR (dB/m)
1	*5260.00	109.7 PK			1.36 H	325	106.5	3.2
2	*5260.00	100.1 AV			1.36 H	325	96.9	3.2
3	5375.98	43.8 PK	74.0	-30.2	1.36 H	325	40.5	3.3
4	5375.98	38.6 AV	54.0	-15.4	1.36 H	325	35.3	3.3
5	#10520.00	46.6 PK	68.2	-21.6	2.23 H	263	32.7	13.9
6	15780.00	55.8 PK	74.0	-18.2	1.71 H	25	42.1	13.7
7	15780.00	44.3 AV	54.0	-9.7	1.71 H	25	30.6	13.7

ANTENNA POLARITY & TEST DISTANCE: VERTICAL AT 3 M								
NO.	FREQ. (MHz)	EMISSION LEVEL (dBuV/m)	LIMIT (dBuV/m)	MARGIN (dB)	ANTENNA HEIGHT (m)	TABLE ANGLE (Degree)	RAW VALUE (dBuV)	CORRECTION FACTOR (dB/m)
1	*5260.00	120.8 PK			1.96 V	234	117.6	3.2
2	*5260.00	109.9 AV			1.96 V	234	106.7	3.2
3	5376.07	54.2 PK	74.0	-19.8	1.96 V	234	50.9	3.3
4	5376.07	48.4 AV	54.0	-5.6	1.96 V	234	45.1	3.3
5	#10520.00	47.0 PK	68.2	-21.2	2.00 V	265	33.1	13.9
6	15780.00	57.2 PK	74.0	-16.8	1.19 V	274	43.5	13.7
7	15780.00	47.0 AV	54.0	-7.0	1.19 V	274	33.3	13.7

REMARKS:

1. Emission Level(dBuV/m) = Raw Value(dBuV) + Correction Factor(dB/m)
2. Correction Factor(dB/m) = Antenna Factor(dB/m) + Cable Factor(dB) – Pre-Amplifier Factor(dB)
3. Margin value = Emission Level – Limit value
4. The other emission levels were very low against the limit.
5. " * ": Fundamental frequency.
6. " # ": The radiated frequency is out of the restricted band.

CHANNEL	TX Channel 60	DETECTOR FUNCTION	Peak (PK)
FREQUENCY RANGE	1GHz ~ 40GHz		Average (AV)

ANTENNA POLARITY & TEST DISTANCE: HORIZONTAL AT 3 M

NO.	FREQ. (MHz)	EMISSION LEVEL (dBuV/m)	LIMIT (dBuV/m)	MARGIN (dB)	ANTENNA HEIGHT (m)	TABLE ANGLE (Degree)	RAW VALUE (dBuV)	CORRECTION FACTOR (dB/m)
1	*5300.00	110.0 PK			1.46 H	331	106.7	3.3
2	*5300.00	100.3 AV			1.46 H	331	97.0	3.3
3	5350.00	47.8 PK	74.0	-26.2	1.46 H	331	44.4	3.4
4	5350.00	34.4 AV	54.0	-19.6	1.46 H	331	31.0	3.4
5	5376.10	49.4 PK	74.0	-24.6	1.46 H	331	46.1	3.3
6	5376.10	37.7 AV	54.0	-16.3	1.46 H	331	34.4	3.3
7	10600.00	46.0 PK	74.0	-28.0	1.85 H	256	32.5	13.5
8	10600.00	35.7 AV	54.0	-18.3	1.85 H	256	22.2	13.5
9	15900.00	56.9 PK	74.0	-17.1	1.79 H	31	43.6	13.3
10	15900.00	44.4 AV	54.0	-9.6	1.79 H	31	31.1	13.3

ANTENNA POLARITY & TEST DISTANCE: VERTICAL AT 3 M

NO.	FREQ. (MHz)	EMISSION LEVEL (dBuV/m)	LIMIT (dBuV/m)	MARGIN (dB)	ANTENNA HEIGHT (m)	TABLE ANGLE (Degree)	RAW VALUE (dBuV)	CORRECTION FACTOR (dB/m)
1	*5300.00	120.5 PK			1.99 V	294	117.2	3.3
2	*5300.00	109.5 AV			1.99 V	294	106.2	3.3
3	5350.00	51.6 PK	74.0	-22.4	1.99 V	294	48.2	3.4
4	5350.00	44.0 AV	54.0	-10.0	1.99 V	294	40.6	3.4
5	5376.10	56.3 PK	74.0	-17.7	1.99 V	294	53.0	3.3
6	5376.10	48.9 AV	54.0	-5.1	1.99 V	294	45.6	3.3
7	10600.00	46.8 PK	74.0	-27.2	2.02 V	266	33.3	13.5
8	10600.00	35.4 AV	54.0	-18.6	2.02 V	266	21.9	13.5
9	15900.00	57.1 PK	74.0	-16.9	1.17 V	281	43.8	13.3
10	15900.00	46.6 AV	54.0	-7.4	1.17 V	281	33.3	13.3

REMARKS:

1. Emission Level(dBuV/m) = Raw Value(dBuV) + Correction Factor(dB/m)
2. Correction Factor(dB/m) = Antenna Factor(dB/m) + Cable Factor(dB) – Pre-Amplifier Factor(dB)
3. Margin value = Emission Level – Limit value
4. The other emission levels were very low against the limit.
5. " * ": Fundamental frequency.

CHANNEL	TX Channel 64	DETECTOR FUNCTION	Peak (PK)
FREQUENCY RANGE	1GHz ~ 40GHz		Average (AV)

ANTENNA POLARITY & TEST DISTANCE: HORIZONTAL AT 3 M

NO.	FREQ. (MHz)	EMISSION LEVEL (dBuV/m)	LIMIT (dBuV/m)	MARGIN (dB)	ANTENNA HEIGHT (m)	TABLE ANGLE (Degree)	RAW VALUE (dBuV)	CORRECTION FACTOR (dB/m)
1	*5320.00	109.3 PK			1.44 H	337	106.0	3.3
2	*5320.00	99.7 AV			1.44 H	337	96.4	3.3
3	5350.00	49.3 PK	74.0	-24.7	1.44 H	337	45.9	3.4
4	5350.00	38.1 AV	54.0	-15.9	1.44 H	337	34.7	3.4
5	10640.00	45.9 PK	74.0	-28.1	1.78 H	271	32.2	13.7
6	10640.00	35.4 AV	54.0	-18.6	1.78 H	271	21.7	13.7
7	15960.00	56.0 PK	74.0	-18.0	1.80 H	22	42.4	13.6
8	15960.00	44.0 AV	54.0	-10.0	1.80 H	22	30.4	13.6

ANTENNA POLARITY & TEST DISTANCE: VERTICAL AT 3 M

NO.	FREQ. (MHz)	EMISSION LEVEL (dBuV/m)	LIMIT (dBuV/m)	MARGIN (dB)	ANTENNA HEIGHT (m)	TABLE ANGLE (Degree)	RAW VALUE (dBuV)	CORRECTION FACTOR (dB/m)
1	*5320.00	121.4 PK			1.94 V	298	118.1	3.3
2	*5320.00	109.5 AV			1.94 V	298	106.2	3.3
3	5350.00	61.2 PK	74.0	-12.8	1.94 V	298	57.8	3.4
4	5350.00	48.8 AV	54.0	-5.2	1.94 V	298	45.4	3.4
5	10640.00	47.4 PK	74.0	-26.6	1.99 V	285	33.7	13.7
6	10640.00	35.9 AV	54.0	-18.1	1.99 V	285	22.2	13.7
7	15960.00	57.2 PK	74.0	-16.8	1.13 V	310	43.6	13.6
8	15960.00	46.7 AV	54.0	-7.3	1.13 V	310	33.1	13.6

REMARKS:

1. Emission Level(dBuV/m) = Raw Value(dBuV) + Correction Factor(dB/m)
2. Correction Factor(dB/m) = Antenna Factor(dB/m) + Cable Factor(dB) – Pre-Amplifier Factor(dB)
3. Margin value = Emission Level – Limit value
4. The other emission levels were very low against the limit.
5. " * ": Fundamental frequency.

CHANNEL	TX Channel 100	DETECTOR FUNCTION	Peak (PK)
FREQUENCY RANGE	1GHz ~ 40GHz		Average (AV)

ANTENNA POLARITY & TEST DISTANCE: HORIZONTAL AT 3 M

NO.	FREQ. (MHz)	EMISSION LEVEL (dBuV/m)	LIMIT (dBuV/m)	MARGIN (dB)	ANTENNA HEIGHT (m)	TABLE ANGLE (Degree)	RAW VALUE (dBuV)	CORRECTION FACTOR (dB/m)
1	5460.00	54.3 PK	74.0	-19.7	1.55 H	331	50.7	3.6
2	5460.00	41.4 AV	54.0	-12.6	1.55 H	331	37.8	3.6
3	#5470.00	55.8 PK	68.2	-12.4	1.55 H	331	52.2	3.6
4	*5500.00	109.1 PK			1.55 H	331	105.4	3.7
5	*5500.00	98.9 AV			1.55 H	331	95.2	3.7
6	11000.00	46.0 PK	74.0	-28.0	1.86 H	264	32.0	14.0
7	11000.00	35.6 AV	54.0	-18.4	1.86 H	264	21.6	14.0
8	#16500.00	55.1 PK	68.2	-13.1	1.87 H	29	39.3	15.8

ANTENNA POLARITY & TEST DISTANCE: VERTICAL AT 3 M

NO.	FREQ. (MHz)	EMISSION LEVEL (dBuV/m)	LIMIT (dBuV/m)	MARGIN (dB)	ANTENNA HEIGHT (m)	TABLE ANGLE (Degree)	RAW VALUE (dBuV)	CORRECTION FACTOR (dB/m)
1	5460.00	57.0 PK	74.0	-17.0	1.93 V	301	53.4	3.6
2	5460.00	46.1 AV	54.0	-7.9	1.93 V	301	42.5	3.6
3	#5470.00	64.4 PK	68.2	-3.8	1.93 V	301	60.8	3.6
4	*5500.00	119.7 PK			1.93 V	301	116.0	3.7
5	*5500.00	108.7 AV			1.93 V	301	105.0	3.7
6	11000.00	47.7 PK	74.0	-26.3	2.04 V	269	33.7	14.0
7	11000.00	36.4 AV	54.0	-17.6	2.04 V	269	22.4	14.0
8	#16500.00	56.8 PK	68.2	-11.4	1.13 V	281	41.0	15.8

REMARKS:

1. Emission Level(dBuV/m) = Raw Value(dBuV) + Correction Factor(dB/m)
2. Correction Factor(dB/m) = Antenna Factor(dB/m) + Cable Factor(dB) – Pre-Amplifier Factor(dB)
3. Margin value = Emission Level – Limit value
4. The other emission levels were very low against the limit.
5. " * ": Fundamental frequency.
6. " # ": The radiated frequency is out of the restricted band.

CHANNEL	TX Channel 116	DETECTOR FUNCTION	Peak (PK)
FREQUENCY RANGE	1GHz ~ 40GHz		Average (AV)

ANTENNA POLARITY & TEST DISTANCE: HORIZONTAL AT 3 M

NO.	FREQ. (MHz)	EMISSION LEVEL (dBuV/m)	LIMIT (dBuV/m)	MARGIN (dB)	ANTENNA HEIGHT (m)	TABLE ANGLE (Degree)	RAW VALUE (dBuV)	CORRECTION FACTOR (dB/m)
1	*5580.00	109.5 PK			1.48 H	339	105.7	3.8
2	*5580.00	99.5 AV			1.48 H	339	95.7	3.8
3	11160.00	45.2 PK	74.0	-28.8	1.80 H	266	31.5	13.7
4	11160.00	34.9 AV	54.0	-19.1	1.80 H	266	21.2	13.7
5	#16740.00	55.4 PK	68.2	-12.8	1.77 H	11	38.4	17.0

ANTENNA POLARITY & TEST DISTANCE: VERTICAL AT 3 M

NO.	FREQ. (MHz)	EMISSION LEVEL (dBuV/m)	LIMIT (dBuV/m)	MARGIN (dB)	ANTENNA HEIGHT (m)	TABLE ANGLE (Degree)	RAW VALUE (dBuV)	CORRECTION FACTOR (dB/m)
1	*5580.00	120.4 PK			2.05 V	360	116.6	3.8
2	*5580.00	109.5 AV			2.05 V	360	105.7	3.8
3	11160.00	47.6 PK	74.0	-26.4	1.94 V	287	33.9	13.7
4	11160.00	36.3 AV	54.0	-17.7	1.94 V	287	22.6	13.7
5	#16740.00	57.2 PK	68.2	-11.0	1.18 V	305	40.2	17.0

REMARKS:

1. Emission Level(dBuV/m) = Raw Value(dBuV) + Correction Factor(dB/m)
2. Correction Factor(dB/m) = Antenna Factor(dB/m) + Cable Factor(dB) – Pre-Amplifier Factor(dB)
3. Margin value = Emission Level – Limit value
4. The other emission levels were very low against the limit.
5. " * ": Fundamental frequency.
6. " # ": The radiated frequency is out of the restricted band.

CHANNEL	TX Channel 140	DETECTOR FUNCTION	Peak (PK)
FREQUENCY RANGE	1GHz ~ 40GHz		Average (AV)

ANTENNA POLARITY & TEST DISTANCE: HORIZONTAL AT 3 M

NO.	FREQ. (MHz)	EMISSION LEVEL (dBuV/m)	LIMIT (dBuV/m)	MARGIN (dB)	ANTENNA HEIGHT (m)	TABLE ANGLE (Degree)	RAW VALUE (dBuV)	CORRECTION FACTOR (dB/m)
1	*5700.00	108.2 PK			1.50 H	316	104.0	4.2
2	*5700.00	96.5 AV			1.50 H	316	92.3	4.2
3	#5725.00	56.7 PK	68.2	-11.5	1.50 H	316	52.5	4.2
4	11400.00	45.6 PK	74.0	-28.4	1.81 H	249	31.3	14.3
5	11400.00	35.3 AV	54.0	-18.7	1.81 H	249	21.0	14.3
6	#17100.00	54.3 PK	68.2	-13.9	1.84 H	20	36.6	17.7

ANTENNA POLARITY & TEST DISTANCE: VERTICAL AT 3 M

NO.	FREQ. (MHz)	EMISSION LEVEL (dBuV/m)	LIMIT (dBuV/m)	MARGIN (dB)	ANTENNA HEIGHT (m)	TABLE ANGLE (Degree)	RAW VALUE (dBuV)	CORRECTION FACTOR (dB/m)
1	*5700.00	119.5 PK			2.12 V	360	115.3	4.2
2	*5700.00	107.8 AV			2.12 V	360	103.6	4.2
3	#5725.00	66.3 PK	68.2	-1.9	2.12 V	360	62.1	4.2
4	11400.00	48.5 PK	74.0	-25.5	1.88 V	278	34.2	14.3
5	11400.00	36.9 AV	54.0	-17.1	1.88 V	278	22.6	14.3
6	#17100.00	56.3 PK	68.2	-11.9	1.13 V	290	38.6	17.7

REMARKS:

1. Emission Level(dBuV/m) = Raw Value(dBuV) + Correction Factor(dB/m)
2. Correction Factor(dB/m) = Antenna Factor(dB/m) + Cable Factor(dB) – Pre-Amplifier Factor(dB)
3. Margin value = Emission Level – Limit value
4. The other emission levels were very low against the limit.
5. " * ": Fundamental frequency.
6. " # ": The radiated frequency is out of the restricted band.

CHANNEL	TX Channel 144	DETECTOR FUNCTION	Peak (PK)
FREQUENCY RANGE	1GHz ~ 40GHz		Average (AV)

ANTENNA POLARITY & TEST DISTANCE: HORIZONTAL AT 3 M

NO.	FREQ. (MHz)	EMISSION LEVEL (dBuV/m)	LIMIT (dBuV/m)	MARGIN (dB)	ANTENNA HEIGHT (m)	TABLE ANGLE (Degree)	RAW VALUE (dBuV)	CORRECTION FACTOR (dB/m)
1	5460.00	46.7 PK	74.0	-27.3	1.43 H	334	43.1	3.6
2	5460.00	39.2 AV	54.0	-14.8	1.43 H	334	35.6	3.6
3	#5470.00	45.3 PK	68.2	-22.9	1.43 H	334	41.7	3.6
4	*5720.00	109.6 PK			1.43 H	334	105.4	4.2
5	*5720.00	99.6 AV			1.43 H	334	95.4	4.2
6	#5850.00	45.7 PK	68.2	-22.5	1.43 H	334	41.2	4.5
7	11440.00	44.7 PK	74.0	-29.3	1.78 H	294	30.4	14.3
8	11440.00	33.0 AV	54.0	-21.0	1.78 H	294	18.7	14.3
9	#17160.00	57.5 PK	68.2	-10.7	1.83 H	14	40.0	17.5

ANTENNA POLARITY & TEST DISTANCE: VERTICAL AT 3 M

NO.	FREQ. (MHz)	EMISSION LEVEL (dBuV/m)	LIMIT (dBuV/m)	MARGIN (dB)	ANTENNA HEIGHT (m)	TABLE ANGLE (Degree)	RAW VALUE (dBuV)	CORRECTION FACTOR (dB/m)
1	5460.00	55.7 PK	74.0	-18.3	2.11 V	360	52.1	3.6
2	5460.00	46.3 AV	54.0	-7.7	2.11 V	360	42.7	3.6
3	#5470.00	55.2 PK	68.2	-13.0	2.11 V	360	51.6	3.6
4	*5720.00	120.6 PK			2.11 V	360	116.4	4.2
5	*5720.00	109.9 AV			2.11 V	360	105.7	4.2
6	#5850.00	55.9 PK	68.2	-12.3	2.11 V	360	51.4	4.5
7	11440.00	46.8 PK	74.0	-27.2	2.19 V	232	32.5	14.3
8	11440.00	34.5 AV	54.0	-19.5	2.19 V	232	20.2	14.3
9	#17160.00	58.9 PK	68.2	-9.3	1.92 V	263	41.4	17.5

REMARKS:

1. Emission Level(dBuV/m) = Raw Value(dBuV) + Correction Factor(dB/m)
2. Correction Factor(dB/m) = Antenna Factor(dB/m) + Cable Factor(dB) – Pre-Amplifier Factor(dB)
3. Margin value = Emission Level – Limit value
4. The other emission levels were very low against the limit.
5. " * ": Fundamental frequency.
6. " # ": The radiated frequency is out of the restricted band.

802.11ax (HE40)

CHANNEL	TX Channel 54	DETECTOR FUNCTION	Peak (PK)
FREQUENCY RANGE	1GHz ~ 40GHz		Average (AV)

ANTENNA POLARITY & TEST DISTANCE: HORIZONTAL AT 3 M								
NO.	FREQ. (MHz)	EMISSION LEVEL (dBuV/m)	LIMIT (dBuV/m)	MARGIN (dB)	ANTENNA HEIGHT (m)	TABLE ANGLE (Degree)	RAW VALUE (dBuV)	CORRECTION FACTOR (dB/m)
1	*5270.00	107.1 PK			1.53 H	346	103.9	3.2
2	*5270.00	97.6 AV			1.53 H	346	94.4	3.2
3	5375.98	47.9 PK	74.0	-26.1	1.53 H	346	44.6	3.3
4	5375.98	40.5 AV	54.0	-13.5	1.53 H	346	37.2	3.3
5	#10540.00	45.5 PK	68.2	-22.7	1.81 H	269	31.8	13.7
6	15810.00	56.2 PK	74.0	-17.8	1.73 H	13	42.7	13.5
7	15810.00	44.9 AV	54.0	-9.1	1.73 H	13	31.4	13.5

ANTENNA POLARITY & TEST DISTANCE: VERTICAL AT 3 M								
NO.	FREQ. (MHz)	EMISSION LEVEL (dBuV/m)	LIMIT (dBuV/m)	MARGIN (dB)	ANTENNA HEIGHT (m)	TABLE ANGLE (Degree)	RAW VALUE (dBuV)	CORRECTION FACTOR (dB/m)
1	*5270.00	118.0 PK			1.95 V	300	114.8	3.2
2	*5270.00	107.1 AV			1.95 V	300	103.9	3.2
3	5375.98	53.5 PK	74.0	-20.5	1.95 V	300	50.2	3.3
4	5375.98	42.1 AV	54.0	-11.9	1.95 V	300	38.8	3.3
5	#10540.00	45.9 PK	68.2	-22.3	1.95 V	268	32.2	13.7
6	15810.00	57.3 PK	74.0	-16.7	1.09 V	287	43.8	13.5
7	15810.00	47.6 AV	54.0	-6.4	1.09 V	287	34.1	13.5

REMARKS:

1. Emission Level(dBuV/m) = Raw Value(dBuV) + Correction Factor(dB/m)
2. Correction Factor(dB/m) = Antenna Factor(dB/m) + Cable Factor(dB) – Pre-Amplifier Factor(dB)
3. Margin value = Emission Level – Limit value
4. The other emission levels were very low against the limit.
5. " * ": Fundamental frequency.
6. " # ": The radiated frequency is out of the restricted band.

CHANNEL	TX Channel 62	DETECTOR FUNCTION	Peak (PK)
FREQUENCY RANGE	1GHz ~ 40GHz		Average (AV)

ANTENNA POLARITY & TEST DISTANCE: HORIZONTAL AT 3 M

NO.	FREQ. (MHz)	EMISSION LEVEL (dBuV/m)	LIMIT (dBuV/m)	MARGIN (dB)	ANTENNA HEIGHT (m)	TABLE ANGLE (Degree)	RAW VALUE (dBuV)	CORRECTION FACTOR (dB/m)
1	*5310.00	103.3 PK			1.56 H	327	100.0	3.3
2	*5310.00	91.9 AV			1.56 H	327	88.6	3.3
3	5350.00	50.0 PK	74.0	-24.0	1.56 H	327	46.6	3.4
4	5350.00	41.8 AV	54.0	-12.2	1.56 H	327	38.4	3.4
5	10620.00	44.6 PK	74.0	-29.4	1.77 H	272	30.9	13.7
6	10620.00	34.7 AV	54.0	-19.3	1.77 H	272	21.0	13.7
7	15930.00	53.9 PK	74.0	-20.1	1.74 H	9	40.4	13.5
8	15930.00	45.1 AV	54.0	-8.9	1.74 H	9	31.6	13.5

ANTENNA POLARITY & TEST DISTANCE: VERTICAL AT 3 M

NO.	FREQ. (MHz)	EMISSION LEVEL (dBuV/m)	LIMIT (dBuV/m)	MARGIN (dB)	ANTENNA HEIGHT (m)	TABLE ANGLE (Degree)	RAW VALUE (dBuV)	CORRECTION FACTOR (dB/m)
1	*5310.00	114.5 PK			1.91 V	296	111.2	3.3
2	*5310.00	102.9 AV			1.91 V	296	99.6	3.3
3	5350.00	64.1 PK	74.0	-9.9	1.91 V	296	60.7	3.4
4	5350.00	52.9 AV	54.0	-1.1	1.91 V	296	49.5	3.4
5	10620.00	45.1 PK	74.0	-28.9	1.88 V	271	31.4	13.7
6	10620.00	35.2 AV	54.0	-18.8	1.88 V	271	21.5	13.7
7	15930.00	55.6 PK	74.0	-18.4	1.12 V	290	42.1	13.5
8	15930.00	45.6 AV	54.0	-8.4	1.12 V	290	32.1	13.5

REMARKS:

1. Emission Level(dBuV/m) = Raw Value(dBuV) + Correction Factor(dB/m)
2. Correction Factor(dB/m) = Antenna Factor(dB/m) + Cable Factor(dB) – Pre-Amplifier Factor(dB)
3. Margin value = Emission Level – Limit value
4. The other emission levels were very low against the limit.
5. " * ": Fundamental frequency.

CHANNEL	TX Channel 102	DETECTOR FUNCTION	Peak (PK)
FREQUENCY RANGE	1GHz ~ 40GHz		Average (AV)

ANTENNA POLARITY & TEST DISTANCE: HORIZONTAL AT 3 M

NO.	FREQ. (MHz)	EMISSION LEVEL (dBuV/m)	LIMIT (dBuV/m)	MARGIN (dB)	ANTENNA HEIGHT (m)	TABLE ANGLE (Degree)	RAW VALUE (dBuV)	CORRECTION FACTOR (dB/m)
1	5460.00	57.7 PK	74.0	-16.3	1.49 H	322	54.1	3.6
2	5460.00	44.2 AV	54.0	-9.8	1.49 H	322	40.6	3.6
3	#5470.00	57.4 PK	68.2	-10.8	1.49 H	322	53.8	3.6
4	*5510.00	103.1 PK			1.49 H	322	99.5	3.6
5	*5510.00	92.1 AV			1.49 H	322	88.5	3.6
6	11020.00	44.4 PK	74.0	-29.6	1.74 H	271	30.5	13.9
7	11020.00	34.5 AV	54.0	-19.5	1.74 H	271	20.6	13.9
8	#16530.00	53.7 PK	68.2	-14.5	1.75 H	5	37.7	16.0

ANTENNA POLARITY & TEST DISTANCE: VERTICAL AT 3 M

NO.	FREQ. (MHz)	EMISSION LEVEL (dBuV/m)	LIMIT (dBuV/m)	MARGIN (dB)	ANTENNA HEIGHT (m)	TABLE ANGLE (Degree)	RAW VALUE (dBuV)	CORRECTION FACTOR (dB/m)
1	5460.00	60.4 PK	74.0	-13.6	1.88 V	298	56.8	3.6
2	5460.00	47.7 AV	54.0	-6.3	1.88 V	298	44.1	3.6
3	#5470.00	66.1 PK	68.2	-2.1	1.88 V	298	62.5	3.6
4	*5510.00	115.1 PK			1.88 V	298	111.5	3.6
5	*5510.00	103.2 AV			1.88 V	298	99.6	3.6
6	11020.00	45.1 PK	74.0	-28.9	1.89 V	270	31.2	13.9
7	11020.00	35.2 AV	54.0	-18.8	1.89 V	270	21.3	13.9
8	#16530.00	57.6 PK	68.2	-10.6	1.17 V	297	41.6	16.0

REMARKS:

1. Emission Level(dBuV/m) = Raw Value(dBuV) + Correction Factor(dB/m)
2. Correction Factor(dB/m) = Antenna Factor(dB/m) + Cable Factor(dB) – Pre-Amplifier Factor(dB)
3. Margin value = Emission Level – Limit value
4. The other emission levels were very low against the limit.
5. " * ": Fundamental frequency.
6. " # ": The radiated frequency is out of the restricted band.

CHANNEL	TX Channel 110	DETECTOR FUNCTION	Peak (PK)
FREQUENCY RANGE	1GHz ~ 40GHz		Average (AV)

ANTENNA POLARITY & TEST DISTANCE: HORIZONTAL AT 3 M

NO.	FREQ. (MHz)	EMISSION LEVEL (dBuV/m)	LIMIT (dBuV/m)	MARGIN (dB)	ANTENNA HEIGHT (m)	TABLE ANGLE (Degree)	RAW VALUE (dBuV)	CORRECTION FACTOR (dB/m)
1	5460.00	61.4 PK	74.0	-12.6	1.54 H	340	57.8	3.6
2	5460.00	43.7 AV	54.0	-10.3	1.54 H	340	40.1	3.6
3	#5470.00	56.4 PK	68.2	-11.8	1.54 H	340	52.8	3.6
4	*5550.00	106.9 PK			1.54 H	340	103.2	3.7
5	*5550.00	97.3 AV			1.54 H	340	93.6	3.7
6	11100.00	44.1 PK	74.0	-29.9	1.82 H	265	30.4	13.7
7	11100.00	34.3 AV	54.0	-19.7	1.82 H	265	20.6	13.7
8	#16650.00	56.5 PK	68.2	-11.7	1.68 H	15	39.8	16.7

ANTENNA POLARITY & TEST DISTANCE: VERTICAL AT 3 M

NO.	FREQ. (MHz)	EMISSION LEVEL (dBuV/m)	LIMIT (dBuV/m)	MARGIN (dB)	ANTENNA HEIGHT (m)	TABLE ANGLE (Degree)	RAW VALUE (dBuV)	CORRECTION FACTOR (dB/m)
1	5460.00	60.2 PK	74.0	-13.8	1.97 V	301	56.6	3.6
2	5460.00	44.9 AV	54.0	-9.1	1.97 V	301	41.3	3.6
3	#5470.00	65.7 PK	68.2	-2.5	1.97 V	301	62.1	3.6
4	*5550.00	119.0 PK			1.97 V	301	115.3	3.7
5	*5550.00	106.6 AV			1.97 V	301	102.9	3.7
6	11100.00	46.2 PK	74.0	-27.8	1.86 V	282	32.5	13.7
7	11100.00	36.5 AV	54.0	-17.5	1.86 V	282	22.8	13.7
8	#16650.00	57.5 PK	68.2	-10.7	1.22 V	296	40.8	16.7

REMARKS:

1. Emission Level(dBuV/m) = Raw Value(dBuV) + Correction Factor(dB/m)
2. Correction Factor(dB/m) = Antenna Factor(dB/m) + Cable Factor(dB) – Pre-Amplifier Factor(dB)
3. Margin value = Emission Level – Limit value
4. The other emission levels were very low against the limit.
5. " * ": Fundamental frequency.
6. " # ": The radiated frequency is out of the restricted band.

CHANNEL	TX Channel 134	DETECTOR FUNCTION	Peak (PK)
FREQUENCY RANGE	1GHz ~ 40GHz		Average (AV)

ANTENNA POLARITY & TEST DISTANCE: HORIZONTAL AT 3 M

NO.	FREQ. (MHz)	EMISSION LEVEL (dBuV/m)	LIMIT (dBuV/m)	MARGIN (dB)	ANTENNA HEIGHT (m)	TABLE ANGLE (Degree)	RAW VALUE (dBuV)	CORRECTION FACTOR (dB/m)
1	*5670.00	106.8 PK			1.52 H	334	102.8	4.0
2	*5670.00	96.0 AV			1.52 H	334	92.0	4.0
3	#5725.00	56.8 PK	68.2	-11.4	1.52 H	334	52.6	4.2
4	11340.00	44.5 PK	74.0	-29.5	1.80 H	286	30.2	14.3
5	11340.00	34.3 AV	54.0	-19.7	1.80 H	286	20.0	14.3
6	#17010.00	57.1 PK	68.2	-11.1	1.71 H	20	39.5	17.6

ANTENNA POLARITY & TEST DISTANCE: VERTICAL AT 3 M

NO.	FREQ. (MHz)	EMISSION LEVEL (dBuV/m)	LIMIT (dBuV/m)	MARGIN (dB)	ANTENNA HEIGHT (m)	TABLE ANGLE (Degree)	RAW VALUE (dBuV)	CORRECTION FACTOR (dB/m)
1	*5670.00	117.2 PK			2.01 V	348	113.2	4.0
2	*5670.00	106.1 AV			2.01 V	348	102.1	4.0
3	#5725.00	66.0 PK	68.2	-2.2	2.01 V	348	61.8	4.2
4	11340.00	46.2 PK	74.0	-27.8	1.90 V	267	31.9	14.3
5	11340.00	36.2 AV	54.0	-17.8	1.90 V	267	21.9	14.3
6	#17010.00	58.1 PK	68.2	-10.1	1.09 V	296	40.5	17.6

REMARKS:

1. Emission Level(dBuV/m) = Raw Value(dBuV) + Correction Factor(dB/m)
2. Correction Factor(dB/m) = Antenna Factor(dB/m) + Cable Factor(dB) – Pre-Amplifier Factor(dB)
3. Margin value = Emission Level – Limit value
4. The other emission levels were very low against the limit.
5. " * ": Fundamental frequency.
6. " # ": The radiated frequency is out of the restricted band.

CHANNEL	TX Channel 142	DETECTOR FUNCTION	Peak (PK)
FREQUENCY RANGE	1GHz ~ 40GHz		Average (AV)

ANTENNA POLARITY & TEST DISTANCE: HORIZONTAL AT 3 M

NO.	FREQ. (MHz)	EMISSION LEVEL (dBuV/m)	LIMIT (dBuV/m)	MARGIN (dB)	ANTENNA HEIGHT (m)	TABLE ANGLE (Degree)	RAW VALUE (dBuV)	CORRECTION FACTOR (dB/m)
1	5460.00	46.7 PK	74.0	-27.3	1.52 H	325	43.1	3.6
2	5460.00	38.9 AV	54.0	-15.1	1.52 H	325	35.3	3.6
3	#5470.00	45.2 PK	68.2	-23.0	1.52 H	325	41.6	3.6
4	*5710.00	107.3 PK			1.52 H	325	103.1	4.2
5	*5710.00	97.4 AV			1.52 H	325	93.2	4.2
6	#5850.00	45.7 PK	68.2	-22.5	1.52 H	325	41.2	4.5
7	11420.00	44.8 PK	74.0	-29.2	1.80 H	298	30.6	14.2
8	11420.00	33.0 AV	54.0	-21.0	1.80 H	298	18.8	14.2
9	#17130.00	57.4 PK	68.2	-10.8	1.83 H	23	39.9	17.5

ANTENNA POLARITY & TEST DISTANCE: VERTICAL AT 3 M

NO.	FREQ. (MHz)	EMISSION LEVEL (dBuV/m)	LIMIT (dBuV/m)	MARGIN (dB)	ANTENNA HEIGHT (m)	TABLE ANGLE (Degree)	RAW VALUE (dBuV)	CORRECTION FACTOR (dB/m)
1	5460.00	55.6 PK	74.0	-18.4	2.00 V	293	52.0	3.6
2	5460.00	45.9 AV	54.0	-8.1	2.00 V	293	42.3	3.6
3	#5470.00	55.1 PK	68.2	-13.1	2.00 V	293	51.5	3.6
4	*5710.00	119.0 PK			2.00 V	293	114.8	4.2
5	*5710.00	106.9 AV			2.00 V	293	102.7	4.2
6	#5850.00	55.9 PK	68.2	-12.3	2.00 V	293	51.4	4.5
7	11420.00	46.7 PK	74.0	-27.3	2.24 V	235	32.5	14.2
8	11420.00	34.6 AV	54.0	-19.4	2.24 V	235	20.4	14.2
9	#17130.00	59.3 PK	68.2	-8.9	1.95 V	272	41.8	17.5

REMARKS:

1. Emission Level(dBuV/m) = Raw Value(dBuV) + Correction Factor(dB/m)
2. Correction Factor(dB/m) = Antenna Factor(dB/m) + Cable Factor(dB) – Pre-Amplifier Factor(dB)
3. Margin value = Emission Level – Limit value
4. The other emission levels were very low against the limit.
5. " * ": Fundamental frequency.
6. " # ": The radiated frequency is out of the restricted band.

802.11ax (HE80)

CHANNEL	TX Channel 58	DETECTOR FUNCTION	Peak (PK)
FREQUENCY RANGE	1GHz ~ 40GHz		Average (AV)

ANTENNA POLARITY & TEST DISTANCE: HORIZONTAL AT 3 M

NO.	FREQ. (MHz)	EMISSION LEVEL (dBuV/m)	LIMIT (dBuV/m)	MARGIN (dB)	ANTENNA HEIGHT (m)	TABLE ANGLE (Degree)	RAW VALUE (dBuV)	CORRECTION FACTOR (dB/m)
1	5150.00	48.4 PK	74.0	-25.6	1.52 H	315	45.0	3.4
2	5150.00	38.8 AV	54.0	-15.2	1.52 H	315	35.4	3.4
3	*5290.00	100.7 PK			1.52 H	315	97.4	3.3
4	*5290.00	89.3 AV			1.52 H	315	86.0	3.3
5	5350.00	51.6 PK	74.0	-22.4	1.52 H	315	48.2	3.4
6	5350.00	42.5 AV	54.0	-11.5	1.52 H	315	39.1	3.4
7	#10580.00	44.3 PK	68.2	-23.9	1.66 H	308	30.7	13.6
8	15870.00	53.1 PK	74.0	-20.9	1.70 H	15	39.7	13.4
9	15870.00	42.2 AV	54.0	-11.8	1.70 H	15	28.8	13.4

ANTENNA POLARITY & TEST DISTANCE: VERTICAL AT 3 M

NO.	FREQ. (MHz)	EMISSION LEVEL (dBuV/m)	LIMIT (dBuV/m)	MARGIN (dB)	ANTENNA HEIGHT (m)	TABLE ANGLE (Degree)	RAW VALUE (dBuV)	CORRECTION FACTOR (dB/m)
1	5150.00	58.8 PK	74.0	-15.2	2.01 V	297	55.4	3.4
2	5150.00	43.6 AV	54.0	-10.4	2.01 V	297	40.2	3.4
3	*5290.00	110.7 PK			2.01 V	297	107.4	3.3
4	*5290.00	99.7 AV			2.01 V	297	96.4	3.3
5	5350.00	65.6 PK	74.0	-8.4	2.01 V	297	62.2	3.4
6	5350.00	53.0 AV	54.0	-1.0	2.01 V	297	49.6	3.4
7	#10580.00	46.3 PK	68.2	-21.9	2.01 V	256	32.7	13.6
8	15870.00	57.3 PK	74.0	-16.7	1.00 V	310	43.9	13.4
9	15870.00	45.4 AV	54.0	-8.6	1.00 V	310	32.0	13.4

REMARKS:

- Emission Level(dBuV/m) = Raw Value(dBuV) + Correction Factor(dB/m)
- Correction Factor(dB/m) = Antenna Factor(dB/m) + Cable Factor(dB) – Pre-Amplifier Factor(dB)
- Margin value = Emission Level – Limit value
- The other emission levels were very low against the limit.
- " * ": Fundamental frequency.
- " # ": The radiated frequency is out of the restricted band.

CHANNEL	TX Channel 106	DETECTOR FUNCTION	Peak (PK)
FREQUENCY RANGE	1GHz ~ 40GHz		Average (AV)

ANTENNA POLARITY & TEST DISTANCE: HORIZONTAL AT 3 M

NO.	FREQ. (MHz)	EMISSION LEVEL (dBuV/m)	LIMIT (dBuV/m)	MARGIN (dB)	ANTENNA HEIGHT (m)	TABLE ANGLE (Degree)	RAW VALUE (dBuV)	CORRECTION FACTOR (dB/m)
1	5460.00	51.9 PK	74.0	-22.1	1.43 H	336	48.3	3.6
2	5460.00	43.0 AV	54.0	-11.0	1.43 H	336	39.4	3.6
3	#5470.00	52.7 PK	68.2	-15.5	1.43 H	336	49.1	3.6
4	*5530.00	99.6 PK			1.43 H	336	95.9	3.7
5	*5530.00	88.4 AV			1.43 H	336	84.7	3.7
6	11060.00	44.2 PK	74.0	-29.8	1.71 H	275	30.4	13.8
7	11060.00	33.8 AV	54.0	-20.2	1.71 H	275	20.0	13.8
8	#16590.00	53.8 PK	68.2	-14.4	1.64 H	9	37.4	16.4

ANTENNA POLARITY & TEST DISTANCE: VERTICAL AT 3 M

NO.	FREQ. (MHz)	EMISSION LEVEL (dBuV/m)	LIMIT (dBuV/m)	MARGIN (dB)	ANTENNA HEIGHT (m)	TABLE ANGLE (Degree)	RAW VALUE (dBuV)	CORRECTION FACTOR (dB/m)
1	5460.00	64.8 PK	74.0	-9.2	2.04 V	63	61.2	3.6
2	5460.00	51.7 AV	54.0	-2.3	2.04 V	63	48.1	3.6
3	#5470.00	67.2 PK	68.2	-1.0	2.04 V	63	63.6	3.6
4	*5530.00	111.0 PK			2.04 V	63	107.3	3.7
5	*5530.00	98.9 AV			2.04 V	63	95.2	3.7
6	11060.00	45.9 PK	74.0	-28.1	1.90 V	282	32.1	13.8
7	11060.00	35.6 AV	54.0	-18.4	1.90 V	282	21.8	13.8
8	#16590.00	57.9 PK	68.2	-10.3	1.13 V	276	41.5	16.4

REMARKS:

1. Emission Level(dBuV/m) = Raw Value(dBuV) + Correction Factor(dB/m)
2. Correction Factor(dB/m) = Antenna Factor(dB/m) + Cable Factor(dB) – Pre-Amplifier Factor(dB)
3. Margin value = Emission Level – Limit value
4. The other emission levels were very low against the limit.
5. " * ": Fundamental frequency.
6. " # ": The radiated frequency is out of the restricted band.

CHANNEL	TX Channel 122	DETECTOR FUNCTION	Peak (PK)
FREQUENCY RANGE	1GHz ~ 40GHz		Average (AV)

ANTENNA POLARITY & TEST DISTANCE: HORIZONTAL AT 3 M

NO.	FREQ. (MHz)	EMISSION LEVEL (dBuV/m)	LIMIT (dBuV/m)	MARGIN (dB)	ANTENNA HEIGHT (m)	TABLE ANGLE (Degree)	RAW VALUE (dBuV)	CORRECTION FACTOR (dB/m)
1	*5610.00	103.3 PK			1.38 H	307	99.5	3.8
2	*5610.00	92.6 AV			1.38 H	307	88.8	3.8
3	#5725.00	52.3 PK	68.2	-15.9	1.38 H	307	48.1	4.2
4	11220.00	44.0 PK	74.0	-30.0	1.73 H	271	30.2	13.8
5	11220.00	33.5 AV	54.0	-20.5	1.73 H	271	19.7	13.8
6	#16830.00	54.2 PK	68.2	-14.0	1.57 H	18	37.0	17.2

ANTENNA POLARITY & TEST DISTANCE: VERTICAL AT 3 M

NO.	FREQ. (MHz)	EMISSION LEVEL (dBuV/m)	LIMIT (dBuV/m)	MARGIN (dB)	ANTENNA HEIGHT (m)	TABLE ANGLE (Degree)	RAW VALUE (dBuV)	CORRECTION FACTOR (dB/m)
1	*5610.00	114.2 PK			1.99 V	360	110.4	3.8
2	*5610.00	103.2 AV			1.99 V	360	99.4	3.8
3	#5725.00	64.3 PK	68.2	-3.9	1.99 V	360	60.1	4.2
4	11220.00	46.6 PK	74.0	-27.4	2.06 V	246	32.8	13.8
5	11220.00	36.5 AV	54.0	-17.5	2.06 V	246	22.7	13.8
6	#16830.00	57.8 PK	68.2	-10.4	1.15 V	302	40.6	17.2

REMARKS:

1. Emission Level(dBuV/m) = Raw Value(dBuV) + Correction Factor(dB/m)
2. Correction Factor(dB/m) = Antenna Factor(dB/m) + Cable Factor(dB) – Pre-Amplifier Factor(dB)
3. Margin value = Emission Level – Limit value
4. The other emission levels were very low against the limit.
5. " * ": Fundamental frequency.
6. " # ": The radiated frequency is out of the restricted band.

CHANNEL	TX Channel 138	DETECTOR FUNCTION	Peak (PK)
FREQUENCY RANGE	1GHz ~ 40GHz		Average (AV)

ANTENNA POLARITY & TEST DISTANCE: HORIZONTAL AT 3 M

NO.	FREQ. (MHz)	EMISSION LEVEL (dBuV/m)	LIMIT (dBuV/m)	MARGIN (dB)	ANTENNA HEIGHT (m)	TABLE ANGLE (Degree)	RAW VALUE (dBuV)	CORRECTION FACTOR (dB/m)
1	5460.00	46.7 PK	74.0	-27.3	1.39 H	304	43.1	3.6
2	5460.00	38.9 AV	54.0	-15.1	1.39 H	304	35.3	3.6
3	#5470.00	45.2 PK	68.2	-23.0	1.39 H	304	41.6	3.6
4	*5690.00	103.0 PK			1.39 H	304	98.8	4.2
5	*5690.00	92.6 AV			1.39 H	304	88.4	4.2
6	#5850.00	45.7 PK	68.2	-22.5	1.39 H	304	41.2	4.5
7	11380.00	44.8 PK	74.0	-29.2	1.80 H	298	30.6	14.2
8	11380.00	33.0 AV	54.0	-21.0	1.80 H	298	18.8	14.2
9	#17070.00	57.4 PK	68.2	-10.8	1.83 H	23	39.8	17.6

ANTENNA POLARITY & TEST DISTANCE: VERTICAL AT 3 M

NO.	FREQ. (MHz)	EMISSION LEVEL (dBuV/m)	LIMIT (dBuV/m)	MARGIN (dB)	ANTENNA HEIGHT (m)	TABLE ANGLE (Degree)	RAW VALUE (dBuV)	CORRECTION FACTOR (dB/m)
1	5460.00	55.6 PK	74.0	-18.4	1.94 V	360	52.0	3.6
2	5460.00	45.9 AV	54.0	-8.1	1.94 V	360	42.3	3.6
3	#5470.00	55.1 PK	68.2	-13.1	1.94 V	360	51.5	3.6
4	*5690.00	114.2 PK			1.94 V	360	110.0	4.2
5	*5690.00	103.1 AV			1.94 V	360	98.9	4.2
6	#5850.00	55.9 PK	68.2	-12.3	1.94 V	360	51.4	4.5
7	11380.00	46.7 PK	74.0	-27.3	2.24 V	235	32.5	14.2
8	11380.00	34.6 AV	54.0	-19.4	2.24 V	235	20.4	14.2
9	#17070.00	59.3 PK	68.2	-8.9	1.95 V	272	41.7	17.6

REMARKS:

1. Emission Level(dBuV/m) = Raw Value(dBuV) + Correction Factor(dB/m)
2. Correction Factor(dB/m) = Antenna Factor(dB/m) + Cable Factor(dB) – Pre-Amplifier Factor(dB)
3. Margin value = Emission Level – Limit value
4. The other emission levels were very low against the limit.
5. " * ": Fundamental frequency.
6. " # ": The radiated frequency is out of the restricted band.

Below 1GHz Data:

802.11a

CHANNEL	TX Channel 144	DETECTOR FUNCTION	Quasi-Peak (QP)
FREQUENCY RANGE	9kHz ~ 1GHz		

ANTENNA POLARITY & TEST DISTANCE: HORIZONTAL AT 3 M

NO.	FREQ. (MHz)	EMISSION LEVEL (dBuV/m)	LIMIT (dBuV/m)	MARGIN (dB)	ANTENNA HEIGHT (m)	TABLE ANGLE (Degree)	RAW VALUE (dBuV)	CORRECTION FACTOR (dB/m)
1	39.24	31.2 QP	40.0	-8.8	1.00 H	304	39.8	-8.6
2	58.15	30.5 QP	40.0	-9.5	3.00 H	253	38.9	-8.4
3	107.14	28.7 QP	43.5	-14.8	3.00 H	310	39.6	-10.9
4	150.16	29.8 QP	43.5	-13.7	1.50 H	115	37.5	-7.7
5	237.48	37.8 QP	46.0	-8.2	1.00 H	267	47.1	-9.3
6	288.26	35.5 QP	46.0	-10.5	1.00 H	170	42.7	-7.2

REMARKS:

1. Emission Level(dBuV/m) = Raw Value(dBuV) + Correction Factor(dB/m)
2. Correction Factor(dB/m) = Antenna Factor(dB/m) + Cable Factor(dB) – Pre-Amplifier Factor(dB)
3. Margin value = Emission Level – Limit value
4. The other emission levels were very low against the limit of frequency range 30MHz~1000MHz.
5. The emission levels were very low against the limit of frequency range 9kHz~30MHz: the amplitude of spurious emissions attenuated more than 20 dB below the permissible value to be report.

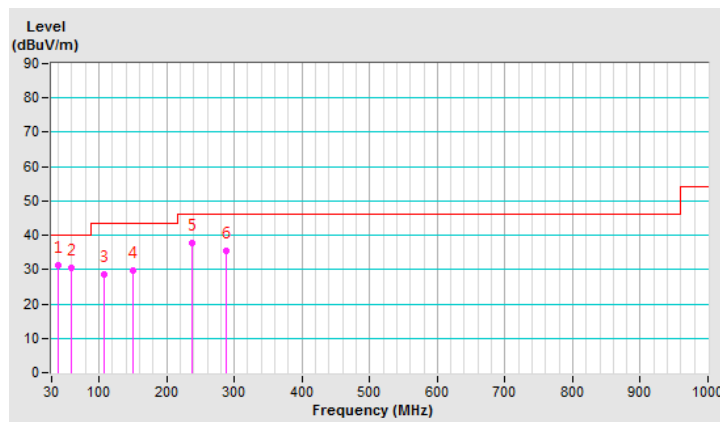

CHANNEL	TX Channel 144	DETECTOR FUNCTION	Quasi-Peak (QP)
FREQUENCY RANGE	9kHz ~ 1GHz		

ANTENNA POLARITY & TEST DISTANCE: VERTICAL AT 3 M

NO.	FREQ. (MHz)	EMISSION LEVEL (dBuV/m)	LIMIT (dBuV/m)	MARGIN (dB)	ANTENNA HEIGHT (m)	TABLE ANGLE (Degree)	RAW VALUE (dBuV)	CORRECTION FACTOR (dB/m)
1	38.83	31.8 QP	40.0	-8.2	2.00 V	110	40.5	-8.7
2	56.94	33.5 QP	40.0	-6.5	1.50 V	233	41.8	-8.3
3	107.53	29.1 QP	43.5	-14.4	1.00 V	8	39.9	-10.8
4	157.26	27.2 QP	43.5	-16.3	1.50 V	360	34.9	-7.7
5	236.39	32.9 QP	46.0	-13.1	1.00 V	207	42.3	-9.4
6	285.84	30.9 QP	46.0	-15.1	1.50 V	131	38.2	-7.3

REMARKS:

1. Emission Level(dBuV/m) = Raw Value(dBuV) + Correction Factor(dB/m)
2. Correction Factor(dB/m) = Antenna Factor(dB/m) + Cable Factor(dB) – Pre-Amplifier Factor(dB)
3. Margin value = Emission Level – Limit value
4. The other emission levels were very low against the limit of frequency range 30MHz~1000MHz.
5. The emission levels were very low against the limit of frequency range 9kHz~30MHz: the amplitude of spurious emissions attenuated more than 20 dB below the permissible value to be report.

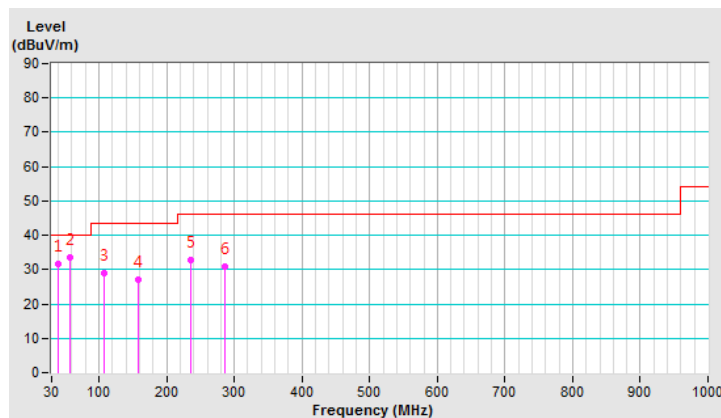

4.2 Conducted Emission Measurement

4.2.1 Limits of Conducted Emission Measurement

Frequency (MHz)	Conducted Limit (dBuV)	
	Quasi-peak	Average
0.15 - 0.5	66 - 56	56 - 46
0.50 - 5.0	56	46
5.0 - 30.0	60	50

Note: 1. The lower limit shall apply at the transition frequencies.

2. The limit decreases in line with the logarithm of the frequency in the range of 0.15 to 0.50MHz.

4.2.2 Test Instruments

DESCRIPTION & MANUFACTURER	MODEL NO.	SERIAL NO.	CALIBRATED DATE	CALIBRATED UNTIL
Test Receiver R&S	ESCS 30	847124/029	Oct. 23, 2019	Oct. 22, 2020
Line-Impedance Stabilization Network (for EUT) R&S	ESH3-Z5	848773/004	Oct. 23, 2019	Oct. 22, 2020
Line-Impedance Stabilization Network (for Peripheral) R&S	ESH3-Z5	835239/001	Mar. 17, 2019	Mar. 16, 2020
50 ohms Terminator	50	3	Oct. 23, 2019	Oct. 22, 2020
RF Cable	5D-FB	COCCAB-001	Sep. 27, 2019	Sep. 26, 2020
Fixed attenuator EMCI	STI02-2200-10	005	Aug. 30, 2019	Aug. 29, 2020
Software BVADT	BVADT_Cond_V7.3.7.4	NA	NA	NA

Note:

1. The calibration interval of the above test instruments are 12 months and the calibrations are traceable to NML/ROC and NIST/USA.
2. The test was performed in Conduction 1.
- 3 Tested Date: Jan. 13, 2020

4.2.3 Test Procedure

- The EUT was placed 0.4 meters from the conducting wall of the shielded room with EUT being connected to the power mains through a line impedance stabilization network (LISN). Other support units were connected to the power mains through another LISN. The two LISNs provide 50 ohm/ 50uH of coupling impedance for the measuring instrument.
- Both lines of the power mains connected to the EUT were checked for maximum conducted interference.
- The frequency range from 150kHz to 30MHz was searched. Emission levels under (Limit - 20dB) was not recorded.

Note: All modes of operation were investigated and the worst-case emissions are reported.

4.2.4 Deviation from Test Standard

No deviation.

4.2.5 Test Setup

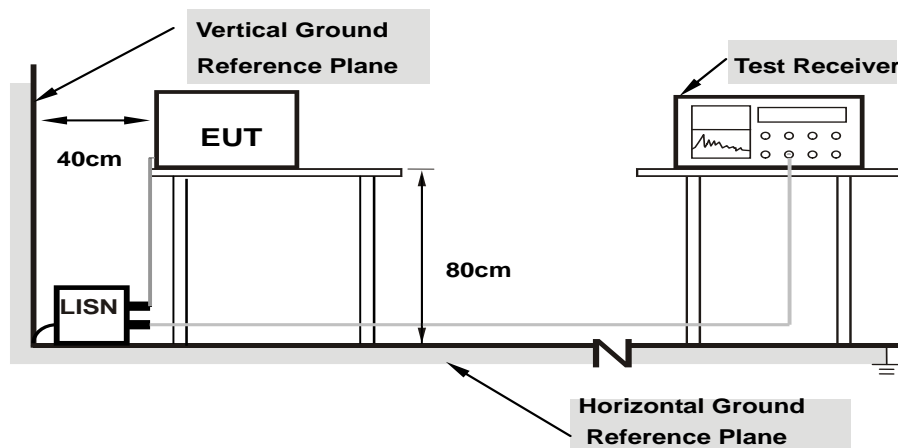

Note: 1.Support units were connected to second LISN.

For the actual test configuration, please refer to the attached file (Test Setup Photo).

4.2.6 EUT Operating Condition

Same as 4.1.6.

4.2.7 Test Results

Phase	Line (L)	Detector Function	Quasi-Peak (QP) / Average (AV)
-------	----------	-------------------	--------------------------------

Phase Of Power : Line (L)										
No	Frequency (MHz)	Correction Factor (dB)	Reading Value (dBuV)		Emission Level (dBuV)		Limit (dBuV)		Margin (dB)	
			Q.P.	AV.	Q.P.	AV.	Q.P.	AV.	Q.P.	AV.
1	0.16172	9.99	45.39	32.65	55.38	42.64	65.38	55.38	-10.00	-12.74
2	0.17344	9.99	38.62	24.09	48.61	34.08	64.79	54.79	-16.18	-20.71
3	0.18125	9.99	37.34	22.58	47.33	32.57	64.43	54.43	-17.10	-21.86
4	0.21250	9.99	31.28	17.38	41.27	27.37	63.11	53.11	-21.84	-25.74
5	0.29063	9.99	32.75	25.38	42.74	35.37	60.51	50.51	-17.77	-15.14
6	0.34141	10.00	17.49	2.11	27.49	12.11	59.17	49.17	-31.68	-37.06

Remarks:

1. Q.P. and AV. are abbreviations of quasi-peak and average individually.
2. The emission levels of other frequencies were very low against the limit.
3. Margin value = Emission level – Limit value
4. Correction factor = Insertion loss + Cable loss
5. Emission Level = Correction Factor + Reading Value

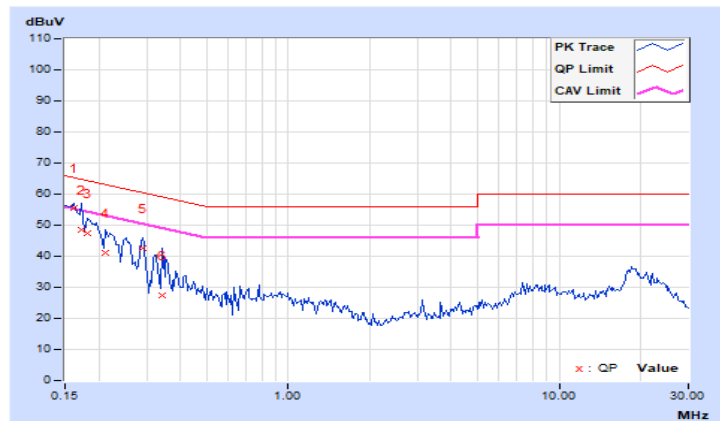

Phase	Neutral (N)	Detector Function	Quasi-Peak (QP) / Average (AV)
-------	-------------	-------------------	--------------------------------

Phase Of Power : Neutral (N)										
No	Frequency (MHz)	Correction Factor (dB)	Reading Value (dBUV)		Emission Level (dBUV)		Limit (dBUV)		Margin (dB)	
			Q.P.	AV.	Q.P.	AV.	Q.P.	AV.	Q.P.	AV.
1	0.15781	9.99	42.86	32.31	52.85	42.30	65.58	55.58	-12.73	-13.28
2	0.18906	9.99	38.32	28.90	48.31	38.89	64.08	54.08	-15.77	-15.19
3	0.22031	9.99	35.84	27.22	45.83	37.21	62.81	52.81	-16.98	-15.60
4	0.25156	10.00	32.75	22.61	42.75	32.61	61.71	51.71	-18.96	-19.10
5	0.29453	10.00	33.15	23.26	43.15	33.26	60.40	50.40	-17.25	-17.14
6	0.31797	10.00	31.64	26.54	41.64	36.54	59.76	49.76	-18.12	-13.22

Remarks:

1. Q.P. and AV. are abbreviations of quasi-peak and average individually.
2. The emission levels of other frequencies were very low against the limit.
3. Margin value = Emission level – Limit value
4. Correction factor = Insertion loss + Cable loss
5. Emission Level = Correction Factor + Reading Value

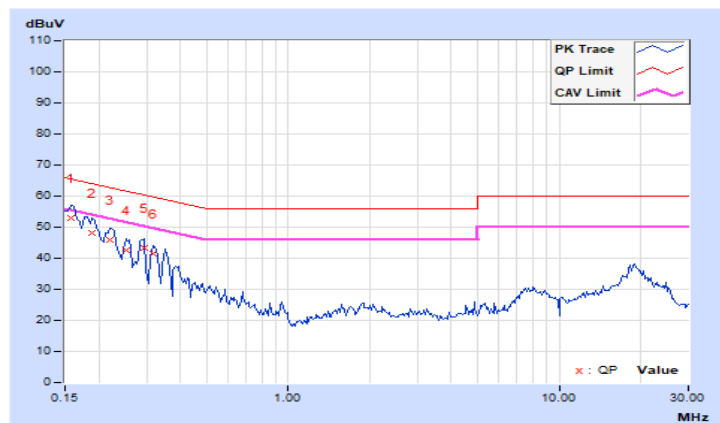

4.3 Transmit Power Measurement

4.3.1 Limits of Transmit Power Measurement

Operation Band	EUT Category		Limit
U-NII-1		Outdoor Access Point	1 Watt (30 dBm) (Max. e.i.r.p \leq 125mW(21 dBm) at any elevation angle above 30 degrees as measured from the horizon)
		Fixed point-to-point Access Point	1 Watt (30 dBm)
		Indoor Access Point	1 Watt (30 dBm)
		Client device	250mW (24 dBm)
U-NII-2A		√	250mW (24 dBm) or 11 dBm+10 log B*
U-NII-2C		√	250mW (24 dBm) or 11 dBm+10 log B*
U-NII-3		√	1 Watt (30 dBm)

*B is the 26 dB emission bandwidth in megahertz

Per KDB 662911 Method of conducted output power measurement on IEEE 802.11 devices,

Array Gain = 0 dB (i.e., no array gain) for $N_{ANT} \leq 4$;

Array Gain = 0 dB (i.e., no array gain) for channel widths ≥ 40 MHz for any N_{ANT} ;

Array Gain = $5 \log(N_{ANT}/N_{SS})$ dB or 3 dB, whichever is less for 20-MHz channel widths with $N_{ANT} \geq 5$.

For power measurements on all other devices: Array Gain = $10 \log(N_{ANT}/N_{SS})$ dB.

4.3.2 Test Setup

FOR POWER OUTPUT MEASUREMENT

For channel straddling 5250MHz and 5725MHz:

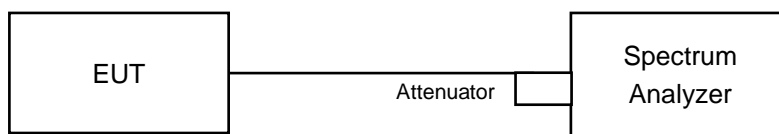

For other channels:

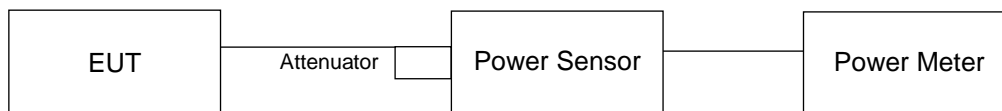

FOR 26dB OCCUPIED BANDWIDTH

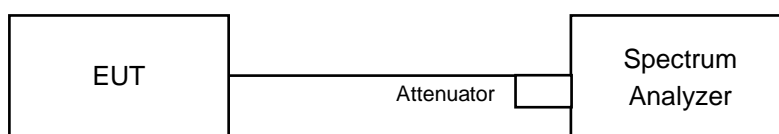

4.3.3 Test Instruments

Refer to section 4.1.2 to get information of above instrument.

4.3.4 Test Procedure

FOR POWER OUTPUT MEASUREMENT

For other channels:

Method PM is used to perform output power measurement, trigger and gating function of wide band power meter is enabled to measure max output power of TX on burst. Duty factor is not added to measured value.

For channel straddling 5725MHz or 5250MHz:

Follow FCC KDB 789033 UNII test procedure:

Method SA-1

1. Set span to encompass the entire emission bandwidth (EBW) of the signal.
2. Set RBW =1MHz.
3. Set the VBW $\geq 3 \times$ RBW.
4. Number of points in sweep ≥ 2 Span / RBW.
5. Sweep time = auto.
6. Set trigger to free run (duty cycle ≥ 98 percent)
7. Detector = RMS.
8. Trace average at least 100 traces in power averaging mode
9. Compute power by integrating the spectrum across the 26 dB EBW of the signal.

FOR 26dB OCCUPIED BANDWIDTH

1. Set RBW = approximately 1% of the emission bandwidth.
2. Set the VBW > RBW.
3. Detector = Peak.
4. Trace mode = max hold.
5. Measure the maximum width of the emission that is 26 dB down from the peak of the emission. Compare this with the RBW setting of the analyzer. Readjust RBW and repeat measurement as needed until the RBW/EBW ratio is approximately 1%.

4.3.5 Deviation from Test Standard

No deviation.

4.3.6 EUT Operating Condition

The software provided by client to enable the EUT under transmission condition continuously at lowest, middle and highest channel frequencies individually.

4.3.7 Test Results

CDD Mode

POWER OUTPUT

802.11a

Chan.	Chan. Freq. (MHz)	Average Power (dBm)		Total Power (mW)	Total Power (dBm)	Limit (dBm)	Pass / Fail
		Chain 0	Chain 1				
52	5260	20.22	21.18	236.416	23.74	24.00	PASS
60	5300	20.26	21.13	235.947	23.73	24.00	PASS
64	5320	20.36	21.19	240.165	23.81	24.00	PASS
100	5500	20.27	21.13	236.132	23.73	24.00	PASS
116	5580	20.25	21.12	235.345	23.72	24.00	PASS
140	5700	20.23	21.16	236.032	23.73	24.00	PASS
*144 (U-NII-2C Band)	5720	15.10	15.61	68.751	18.37	22.80	PASS
*144 (U-NII-3 Band)	5720	8.76	10.08	17.702	12.48	30.00	PASS

Note: * Test was performed in accordance with Measurement follow FCC KDB 789033 UNII test procedure Method SA-2 and use spectrum analyzer test.

The Total Power for the straddle channel and power meter value for reference only:

Chan.	Chan. Freq. (MHz)	Total Power (mW)	Total Power (dBm)	Average Power (dBm)		Total Average Power (mW)	Total Average Power (dBm)
				Chain0	Chain1		
144	5720	86.453	19.37	20.24	21.18	236.902	23.75

Note: For U-NII-2A, U-NII-2C Band output power limitation is determined based on 26dBc bandwidth.

Power Limit = 11dBm + 10logB < U-NII-2A, U-NII-2C >			
Channel Number	Freq.(MHz)	Min. B(MHz)	Determined Conducted Limit (dBm)
52	5260	20.4	24.09 > 24
60	5300	20.7	24.15 > 24
64	5320	20.61	24.14 > 24
100	5500	20.69	24.15 > 24
116	5580	20.32	24.07 > 24
140	5700	20.68	24.15 > 24
144 (U-NII-2C Band)	5720	15.17	22.8 < 24

Beamforming Mode

802.11ac (VHT20)

Chan.	Chan. Freq. (MHz)	Average Power (dBm)		Total Power (mW)	Total Power (dBm)	Limit (dBm)	Pass / Fail
		Chain 0	Chain 1				
52	5260	20.19	20.53	217.452	23.37	24.00	PASS
60	5300	20.30	20.65	223.297	23.49	24.00	PASS
64	5320	20.29	20.45	217.823	23.38	24.00	PASS
100	5500	20.21	20.34	213.098	23.29	23.91	PASS
116	5580	20.32	20.40	217.294	23.37	23.91	PASS
140	5700	20.33	20.39	217.29	23.37	23.91	PASS
*144 (U-NII-2C Band)	5720	13.57	14.01	47.928	16.81	22.86	PASS
*144 (U-NII-3 Band)	5720	8.41	7.83	13.002	11.14	29.91	PASS

Note: * Test was performed in accordance with Measurement follow FCC KDB 789033 UNII test procedure Method SA-2 and use spectrum analyzer test.

1. For U-NII-2A: The directional gain = $10 \log[(10^{G0/20} + 10^{G1/20})^2 / 2] = 5.88 \text{ dBi} < 6 \text{ dBi}$, so the power limit shall not be reduced.
2. For U-NII-2C: The directional gain = $10 \log[(10^{G0/20} + 10^{G1/20})^2 / 2] = 6.09 \text{ dBi} > 6 \text{ dBi}$, therefore the limit needs to reduce, so the power limit shall be reduced to "Determined Conducted Limit-(6.09-6)".
3. For U-NII-3: The directional gain = $10 \log[(10^{G0/20} + 10^{G1/20})^2 / 2] = 6.09 \text{ dBi} > 6 \text{ dBi}$, so the power limit shall be reduced to $30-(6.09-6) = 29.91 \text{ dBm}$

The Total Power for the straddle channel and power meter value for reference only:

Chan.	Chan. Freq. (MHz)	Total Power (mW)	Total Power (dBm)	Average Power (dBm)		Total Average Power (mW)	Total Average Power (dBm)
				Chain0	Chain1		
144	5720	60.93	17.85	20.38	20.38	218.288	23.39

Note: For U-NII-2A, U-NII-2C Band output power limitation is determined based on 26dBc bandwidth.

Power Limit = 11dBm + 10logB < U-NII-2A, U-NII-2C >			
Channel Number	Freq.(MHz)	Min. B(MHz)	Determined Conducted Limit (dBm)
52	5260	21.59	24.34 > 24
60	5300	21.8	24.38 > 24
64	5320	21.84	24.39 > 24
100	5500	21.22	24.26 > 24
116	5580	21.58	24.34 > 24
140	5700	21.99	24.42 > 24
144 (U-NII-2C Band)	5720	15.7	22.95 < 24

802.11ac (VHT40)

Chan.	Chan. Freq. (MHz)	Average Power (dBm)		Total Power (mW)	Total Power (dBm)	Limit (dBm)	Pass / Fail
		Chain 0	Chain 1				
54	5270	20.34	20.12	210.945	23.24	24.00	PASS
62	5310	19.10	19.40	168.379	22.26	24.00	PASS
102	5510	19.52	19.72	183.293	22.63	23.91	PASS
110	5550	20.41	20.29	216.806	23.36	23.91	PASS
134	5670	20.19	20.59	219.023	23.40	23.91	PASS
*142 (U-NII-2C Band)	5710	15.21	14.59	61.963	17.92	23.91	PASS
*142 (U-NII-3 Band)	5710	3.02	5.20	5.316	7.26	29.91	PASS

Note: * Test was performed in accordance with Measurement follow FCC KDB 789033 UNII test procedure Method SA-2 and use spectrum analyzer test.

1. For U-NII-2A: The directional gain = $10 \log[(10^{G0/20} + 10^{G1/20})^2 / 2] = 5.88 \text{ dBi} < 6 \text{ dBi}$, so the power limit shall not be reduced.
2. For U-NII-2C: The directional gain = $10 \log[(10^{G0/20} + 10^{G1/20})^2 / 2] = 6.09 \text{ dBi} > 6 \text{ dBi}$, therefore the limit needs to reduce, so the power limit shall be reduced to "Determined Conducted Limit-(6.09-6)".
3. For U-NII-3: The directional gain = $10 \log[(10^{G0/20} + 10^{G1/20})^2 / 2] = 6.09 \text{ dBi} > 6 \text{ dBi}$, so the power limit shall be reduced to $30 - (6.09 - 6) = 29.91 \text{ dBm}$

The Total Power for the straddle channel and power meter value for reference only:

Chan.	Chan. Freq. (MHz)	Total Power (mW)	Total Power (dBm)	Average Power (dBm)		Total Average Power (mW)	Total Average Power (dBm)
				Chain0	Chain1		
142	5710	67.279	18.28	20.26	20.38	215.314	23.33

Note: For U-NII-2A, U-NII-2C Band output power limitation is determined based on 26dBc bandwidth.

Power Limit = 11dBm + 10logB < U-NII-2A, U-NII-2C >			
Channel Number	Freq.(MHz)	Min. B(MHz)	Determined Conducted Limit (dBm)
54	5260	42.39	27.27 > 24
62	5300	42.4	27.27 > 24
102	5320	42.29	27.26 > 24
110	5500	42.45	27.27 > 24
134	5580	42.24	27.25 > 24
142 (U-NII-2C Band)	5700	36.11	26.57 > 24

802.11ac (VHT80)

Chan.	Chan. Freq. (MHz)	Average Power (dBm)		Total Power (mW)	Total Power (dBm)	Limit (dBm)	Pass / Fail
		Chain 0	Chain 1				
58	5290	19.33	19.42	173.202	22.39	24.00	PASS
106	5530	19.52	19.48	178.252	22.51	23.91	PASS
122	5610	20.34	20.70	225.633	23.53	23.91	PASS
*138 (U-NII-2C Band)	5690	15.21	16.38	76.64	18.84	23.91	PASS
*138 (U-NII-3 Band)	5690	1.38	3.07	3.402	5.32	29.91	PASS

Note: * Test was performed in accordance with Measurement follow FCC KDB 789033 UNII test procedure Method SA-2 and use spectrum analyzer test.

1. For U-NII-2A: The directional gain = $10 \log[(10^{G0/20} + 10^{G1/20})^2 / 2] = 5.88 \text{ dBi} < 6 \text{ dBi}$, so the power limit shall not be reduced.
2. For U-NII-2C: The directional gain = $10 \log[(10^{G0/20} + 10^{G1/20})^2 / 2] = 6.09 \text{ dBi} > 6 \text{ dBi}$, therefore the limit needs to reduce, so the power limit shall be reduced to "Determined Conducted Limit-(6.09-6)".
3. For U-NII-3: The directional gain = $10 \log[(10^{G0/20} + 10^{G1/20})^2 / 2] = 6.09 \text{ dBi} > 6 \text{ dBi}$, so the power limit shall be reduced to $30 - (6.09 - 6) = 29.91 \text{ dBm}$

The Total Power for the straddle channel and power meter value for reference only:

Chan.	Chan. Freq. (MHz)	Total Power (mW)	Total Power (dBm)	Average Power (dBm)		Total Average Power (mW)	Total Average Power (dBm)
				Chain0	Chain1		
138	5690	80.042	19.03	20.35	20.61	223.473	23.49

Note: For U-NII-2A, U-NII-2C Band output power limitation is determined based on 26dBc bandwidth.

Power Limit = 11dBm + 10logB < U-NII-2A, U-NII-2C >			
Channel Number	Freq.(MHz)	Min. B(MHz)	Determined Conducted Limit (dBm)
58	5290	83.03	30.19 > 24
106	5530	83.46	30.21 > 24
122	5610	83	30.19 > 24
138 (U-NII-2C Band)	5690	76.43	29.83 > 24

802.11ax (HE20)

Chan.	Chan. Freq. (MHz)	Average Power (dBm)		Total Power (mW)	Total Power (dBm)	Limit (dBm)	Pass / Fail
		Chain 0	Chain 1				
52	5260	20.37	20.61	223.973	23.50	24.00	PASS
60	5300	20.39	20.71	227.156	23.56	24.00	PASS
64	5320	20.40	20.75	228.498	23.59	24.00	PASS
100	5500	20.38	20.51	221.605	23.46	23.91	PASS
116	5580	20.47	20.59	225.981	23.54	23.91	PASS
140	5700	20.51	20.61	227.541	23.57	23.91	PASS
*144 (U-NII-2C Band)	5720	13.72	14.47	51.54	17.12	22.86	PASS
*144 (U-NII-3 Band)	5720	8.72	7.86	13.557	11.32	29.91	PASS

Note: * Test was performed in accordance with Measurement follow FCC KDB 789033 UNII test procedure Method SA-2 and use spectrum analyzer test.

1. For U-NII-2A: The directional gain = $10 \log[(10^{G0/20} + 10^{G1/20})^2 / 2] = 5.88 \text{ dBi} < 6 \text{ dBi}$, so the power limit shall not be reduced.
2. For U-NII-2C: The directional gain = $10 \log[(10^{G0/20} + 10^{G1/20})^2 / 2] = 6.09 \text{ dBi} > 6 \text{ dBi}$, therefore the limit needs to reduce, so the power limit shall be reduced to "Determined Conducted Limit-(6.09-6)".
3. For U-NII-3: The directional gain = $10 \log[(10^{G0/20} + 10^{G1/20})^2 / 2] = 6.09 \text{ dBi} > 6 \text{ dBi}$, so the power limit shall be reduced to $30-(6.09-6) = 29.91 \text{ dBm}$

The Total Power for the straddle channel and power meter value for reference only:

Chan.	Chan. Freq. (MHz)	Total Power (mW)	Total Power (dBm)	Average Power (dBm)		Total Average Power (mW)	Total Average Power (dBm)
				Chain0	Chain1		
144	5720	65.097	18.14	20.49	20.59	226.495	23.55

Note: For U-NII-2A, U-NII-2C Band output power limitation is determined based on 26dBc bandwidth.

Power Limit = $11 \text{ dBm} + 10 \log B$ < U-NII-2A, U-NII-2C >			
Channel Number	Freq.(MHz)	Min. B(MHz)	Determined Conducted Limit (dBm)
52	5260	21.59	24.34 > 24
60	5300	21.8	24.38 > 24
64	5320	21.84	24.39 > 24
100	5500	21.22	24.26 > 24
116	5580	21.58	24.34 > 24
140	5700	21.99	24.42 > 24
144 (U-NII-2C Band)	5720	15.7	22.95 < 24

802.11ax (HE40)

Chan.	Chan. Freq. (MHz)	Average Power (dBm)		Total Power (mW)	Total Power (dBm)	Limit (dBm)	Pass / Fail
		Chain 0	Chain 1				
54	5270	20.52	20.26	218.889	23.40	24.00	PASS
62	5310	19.12	19.51	170.989	22.33	24.00	PASS
102	5510	19.60	19.83	187.362	22.73	23.91	PASS
110	5550	20.54	20.30	220.392	23.43	23.91	PASS
134	5670	20.24	20.77	225.081	23.52	23.91	PASS
*142 (U-NII-2C Band)	5710	15.35	14.70	63.789	18.05	23.91	PASS
*142 (U-NII-3 Band)	5710	3.33	5.45	5.66	7.53	29.91	PASS

Note: * Test was performed in accordance with Measurement follow FCC KDB 789033 UNII test procedure Method SA-2 and use spectrum analyzer test.

1. For U-NII-2A: The directional gain = $10 \log[(10^{G0/20} + 10^{G1/20})^2 / 2] = 5.88 \text{ dBi} < 6 \text{ dBi}$, so the power limit shall not be reduced.
2. For U-NII-2C: The directional gain = $10 \log[(10^{G0/20} + 10^{G1/20})^2 / 2] = 6.09 \text{ dBi} > 6 \text{ dBi}$, therefore the limit needs to reduce, so the power limit shall be reduced to "Determined Conducted Limit-(6.09-6)".
3. For U-NII-3: The directional gain = $10 \log[(10^{G0/20} + 10^{G1/20})^2 / 2] = 6.09 \text{ dBi} > 6 \text{ dBi}$, so the power limit shall be reduced to $30 - (6.09 - 6) = 29.91 \text{ dBm}$

The Total Power for the straddle channel and power meter value for reference only:

Chan.	Chan. Freq. (MHz)	Total Power (mW)	Total Power (dBm)	Average Power (dBm)		Total Average Power (mW)	Total Average Power (dBm)
				Chain0	Chain1		
142	5710	69.449	18.42	20.38	20.44	219.806	23.42

Note: For U-NII-2A, U-NII-2C Band output power limitation is determined based on 26dBc bandwidth.

Power Limit = 11dBm + 10logB < U-NII-2A, U-NII-2C >			
Channel Number	Freq.(MHz)	Min. B(MHz)	Determined Conducted Limit (dBm)
54	5260	42.39	27.27 > 24
62	5300	42.4	27.27 > 24
102	5320	42.29	27.26 > 24
110	5500	42.45	27.27 > 24
134	5580	42.24	27.25 > 24
142 (U-NII-2C Band)	5700	36.11	26.57 > 24

802.11ax (HE80)

Chan.	Chan. Freq. (MHz)	Average Power (dBm)		Total Power (mW)	Total Power (dBm)	Limit (dBm)	Pass / Fail
		Chain 0	Chain 1				
58	5290	19.48	19.51	178.046	22.51	24.00	PASS
106	5530	19.63	19.59	182.825	22.62	23.91	PASS
122	5610	20.45	20.84	232.256	23.66	23.91	PASS
*138 (U-NII-2C Band)	5690	15.40	16.50	79.342	19.00	23.91	PASS
*138 (U-NII-3 Band)	5690	1.51	3.18	3.495	5.43	29.91	PASS

Note: * Test was performed in accordance with Measurement follow FCC KDB 789033 UNII test procedure Method SA-2 and use spectrum analyzer test.

1. For U-NII-2A: The directional gain = $10 \log[(10^{G0/20} + 10^{G1/20})^2 / 2] = 5.88 \text{ dBi} < 6 \text{ dBi}$, so the power limit shall not be reduced.
2. For U-NII-2C: The directional gain = $10 \log[(10^{G0/20} + 10^{G1/20})^2 / 2] = 6.09 \text{ dBi} > 6 \text{ dBi}$, therefore the limit needs to reduce, so the power limit shall be reduced to "Determined Conducted Limit-(6.09-6)".
3. For U-NII-3: The directional gain = $10 \log[(10^{G0/20} + 10^{G1/20})^2 / 2] = 6.09 \text{ dBi} > 6 \text{ dBi}$, so the power limit shall be reduced to $30 - (6.09 - 6) = 29.91 \text{ dBm}$

The Total Power for the straddle channel and power meter value for reference only:

Chan.	Chan. Freq. (MHz)	Total Power (mW)	Total Power (dBm)	Average Power (dBm)		Total Average Power (mW)	Total Average Power (dBm)
				Chain0	Chain1		
138	5690	82.837	19.18	20.51	20.78	232.135	23.66

Note: For U-NII-2A, U-NII-2C Band output power limitation is determined based on 26dBc bandwidth.

Power Limit = 11dBm + 10logB < U-NII-2A, U-NII-2C >			
Channel Number	Freq.(MHz)	Min. B(MHz)	Determined Conducted Limit (dBm)
58	5290	83.03	30.19 > 24
106	5530	83.46	30.21 > 24
122	5610	83	30.19 > 24
138 (U-NII-2C Band)	5690	76.43	29.83 > 24

For channel straddling 5725MHz of Power

CDD Mode

Spectrum Plot Value of Power

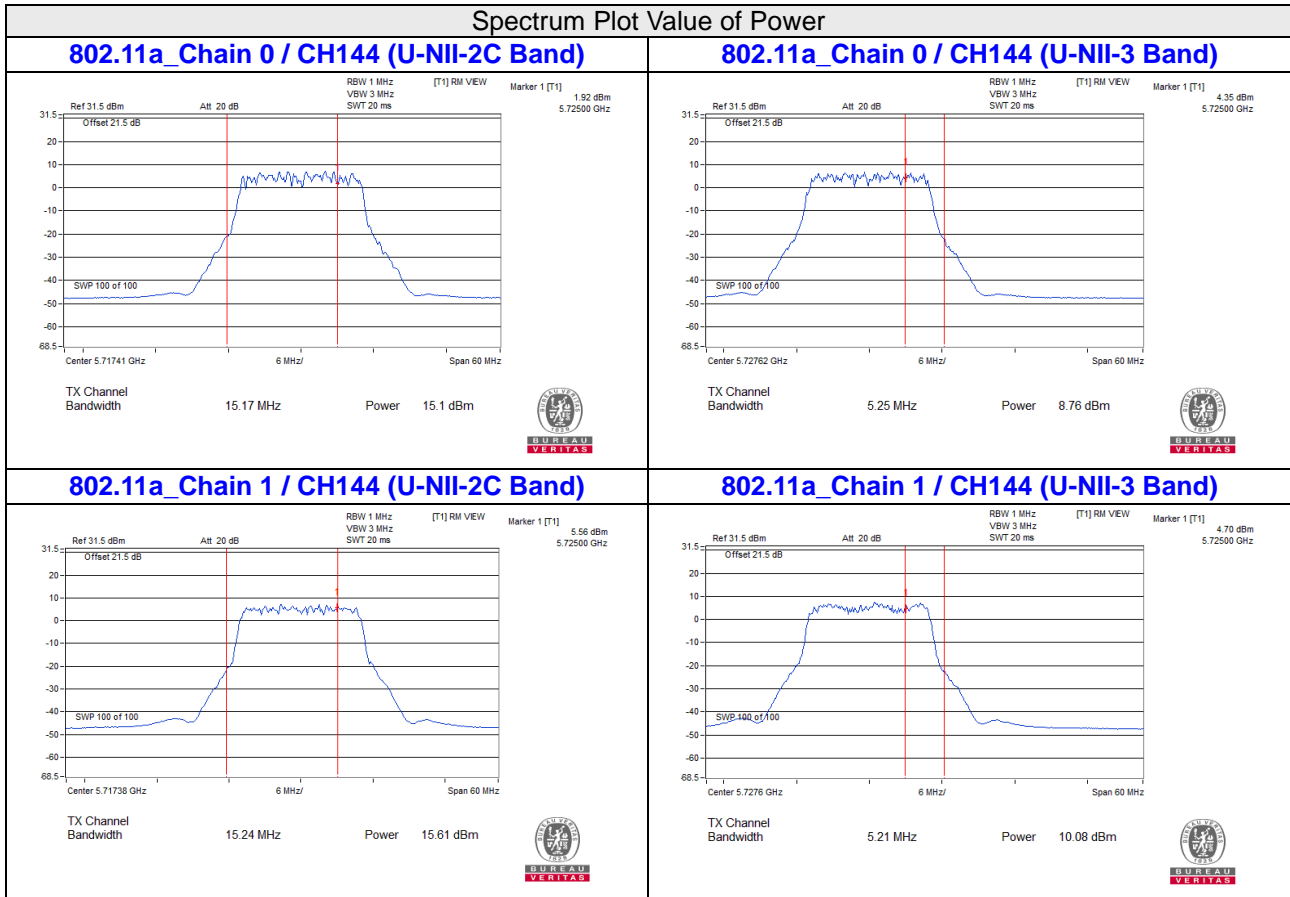

Beamforming Mode

Spectrum Plot Value of Power

802.11ac (VHT20)_Chain 0 / CH144 (U-NII-2C Band)

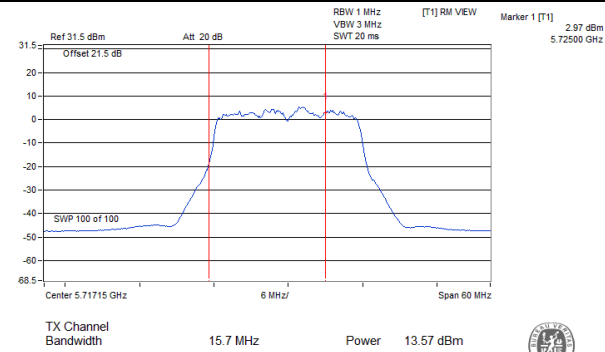

802.11ac (VHT20)_Chain 0 / CH144 (U-NII-3 Band)

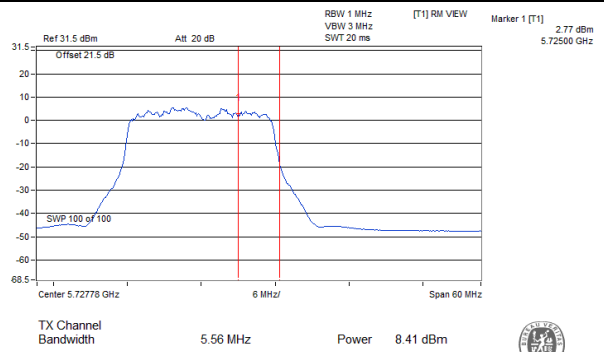

802.11ac (VHT20)_Chain 1 / CH144 (U-NII-2C Band)

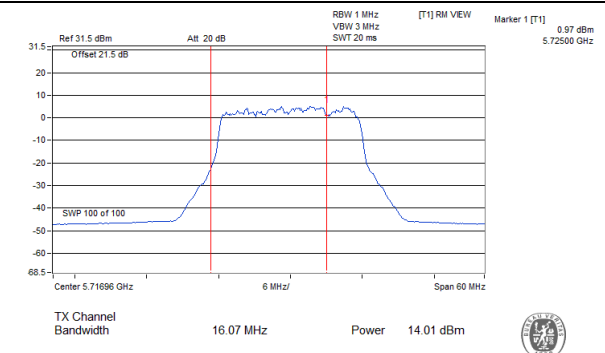

802.11ac (VHT20)_Chain 1 / CH144 (U-NII-3 Band)

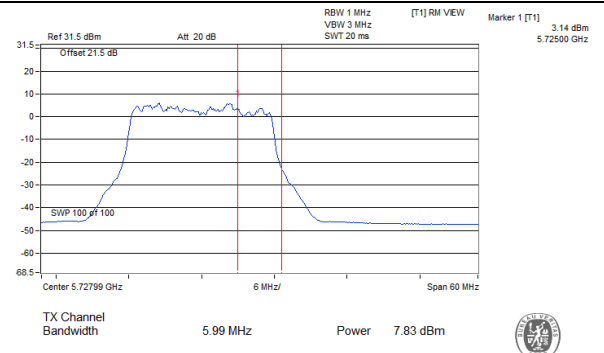

802.11ac (VHT40)_Chain 0 / CH142 (U-NII-2C Band)

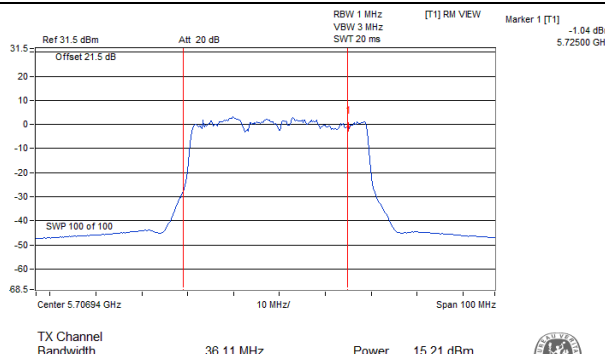

802.11ac (VHT40)_Chain 0 / CH142 (U-NII-3 Band)

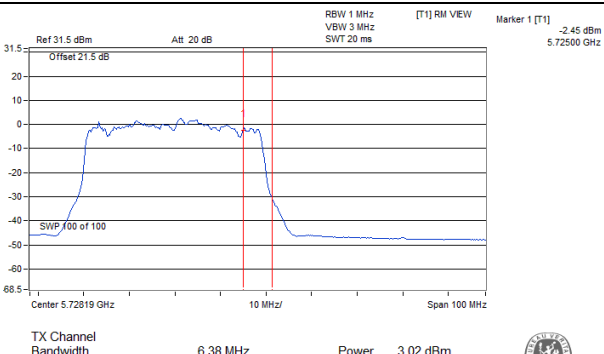

802.11ac (VHT40)_Chain 1 / CH142 (U-NII-2C Band)

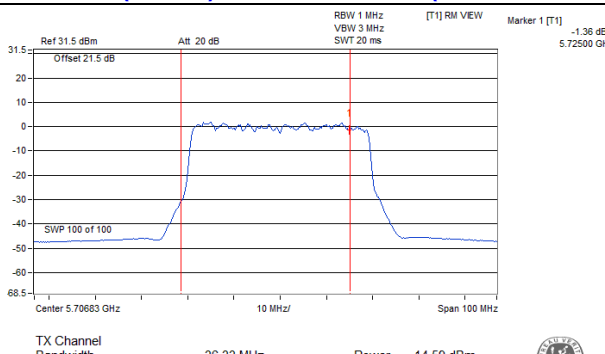

802.11ac (VHT40)_Chain 1 / CH142 (U-NII-3 Band)

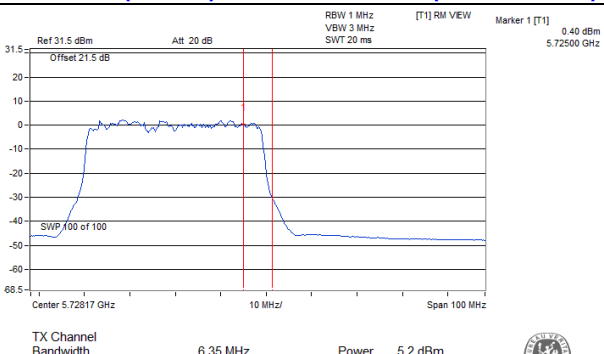

Spectrum Plot Value of Power

802.11ac (VHT80)_Chain 0 / CH138 (U-NII-2C Band)

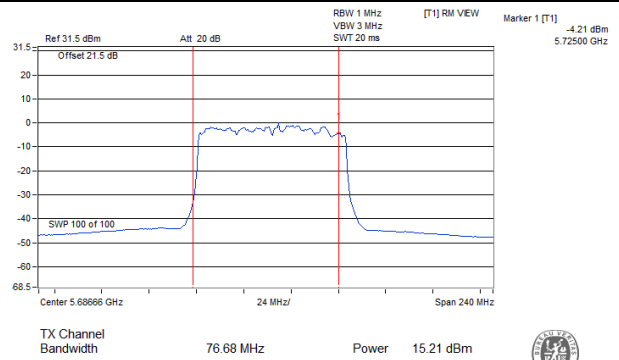

802.11ac (VHT80)_Chain 0 / CH138 (U-NII-3 Band)

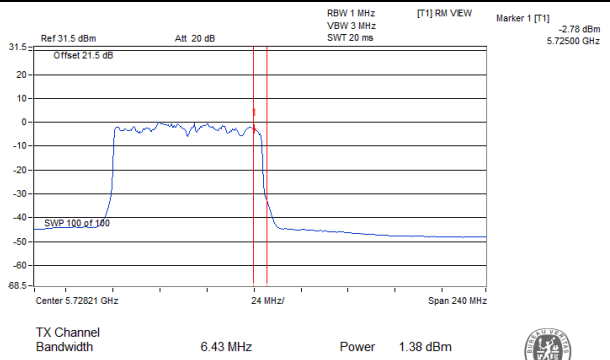

802.11ac (VHT80)_Chain 1 / CH138 (U-NII-2C Band)

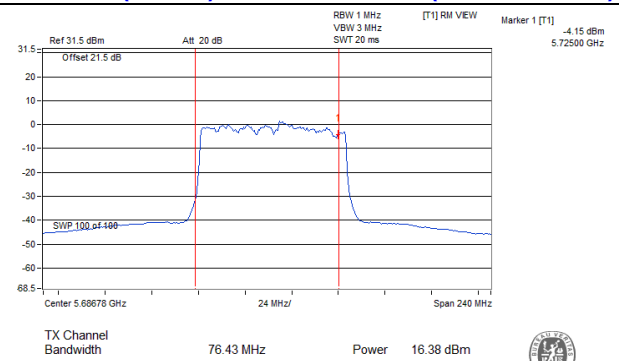

802.11ac (VHT80)_Chain 1 / CH138 (U-NII-3 Band)

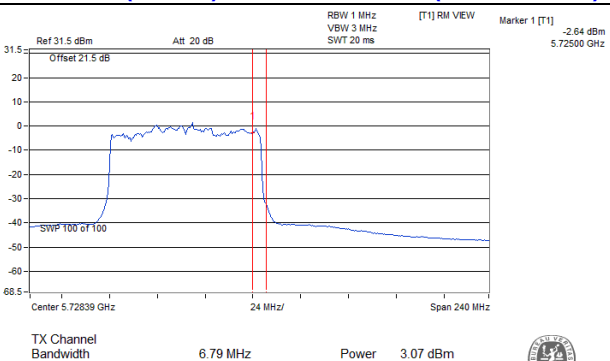

802.11ax (HE20)_Chain 0 / CH144 (U-NII-2C Band)

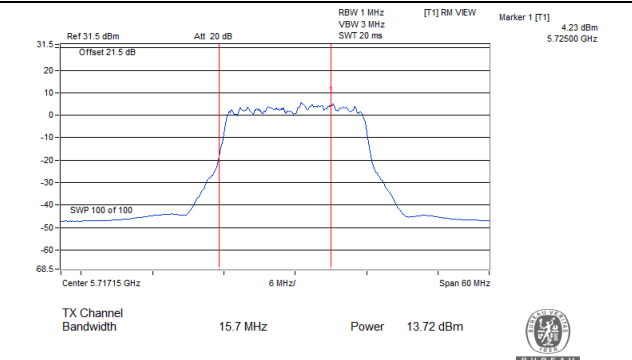

802.11ax (HE20)_Chain 0 / CH144 (U-NII-3 Band)

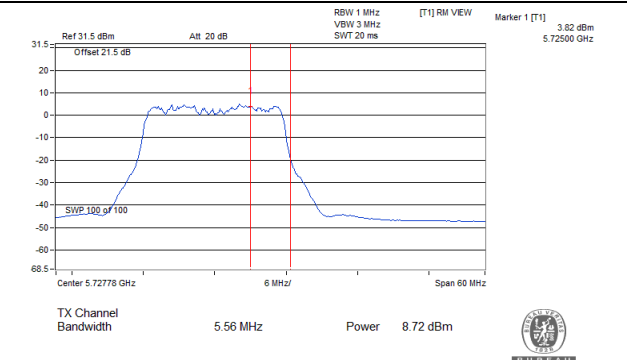

802.11ax (HE20)_Chain 1 / CH144 (U-NII-2C Band)

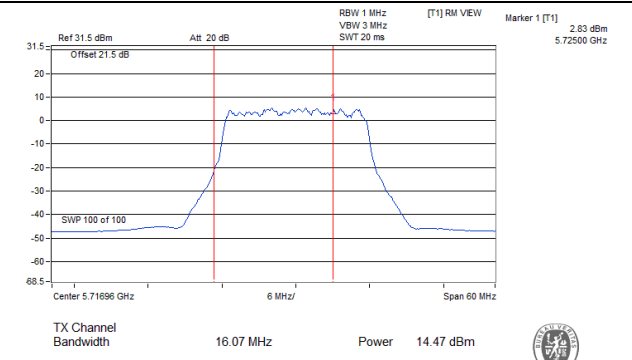

802.11ax (HE20)_Chain 1 / CH144 (U-NII-3 Band)

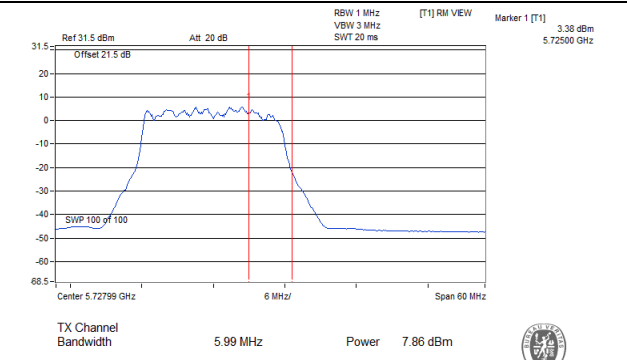

Spectrum Plot Value of Power

802.11ax (HE40)_Chain 0 / CH142 (U-NII-2C Band)

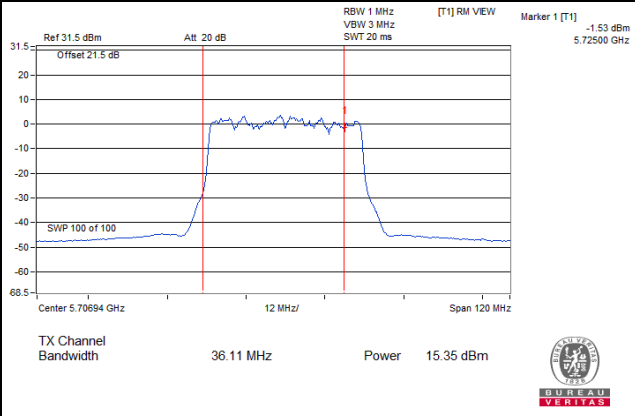

802.11ax (HE40)_Chain 0 / CH142 (U-NII-3 Band)

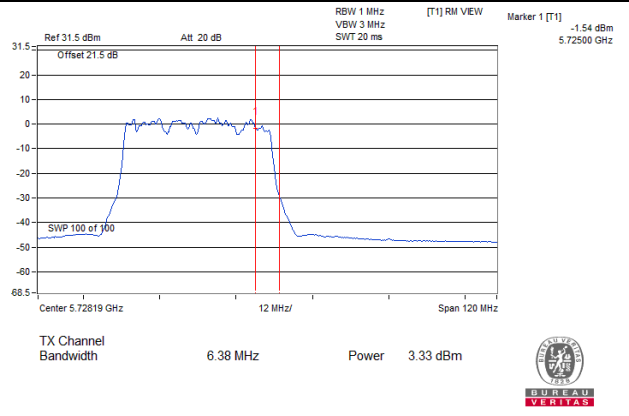

802.11ax (HE40)_Chain 1 / CH142 (U-NII-2C Band)

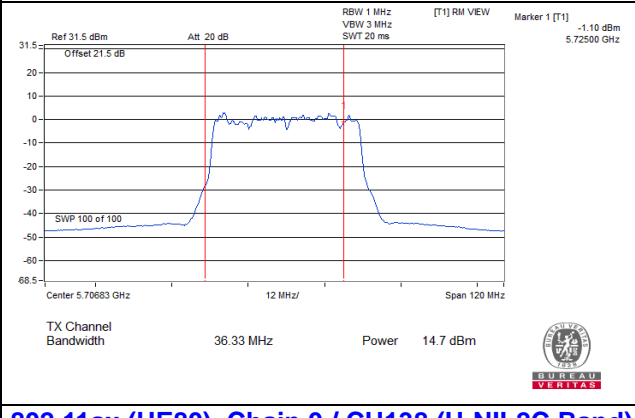

802.11ax (HE40)_Chain 1 / CH142 (U-NII-3 Band)

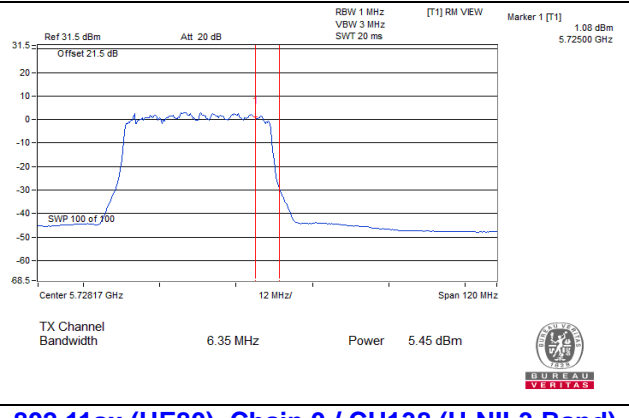

802.11ax (HE80)_Chain 0 / CH138 (U-NII-2C Band)

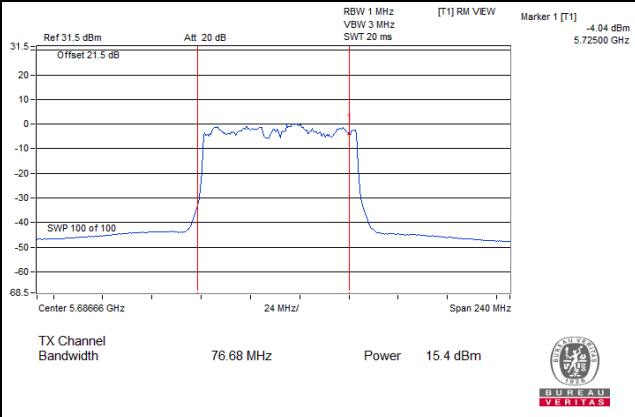

802.11ax (HE80)_Chain 0 / CH138 (U-NII-3 Band)

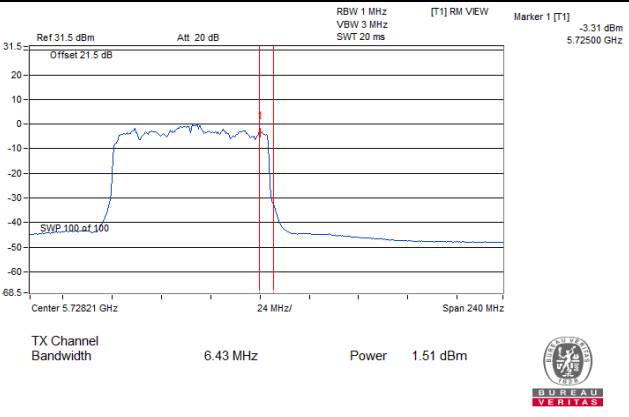

802.11ax (HE80)_Chain 1 / CH138 (U-NII-2C Band)

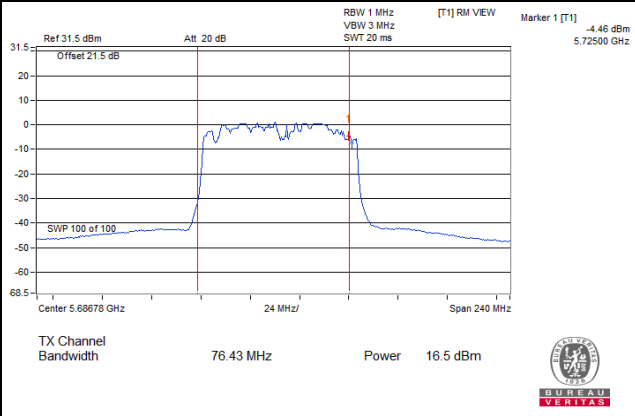

802.11ax (HE80)_Chain 1 / CH138 (U-NII-3 Band)

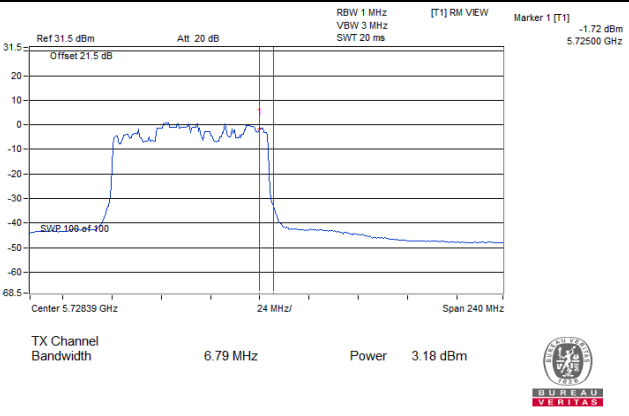

26dB OCCUPIED BANDWIDTH

802.11a

Channel	Frequency (MHz)	26dB Bandwidth (MHz)	
		Chain0	Chain1
52	5260	20.58	20.4
60	5300	20.82	20.7
64	5320	20.63	20.61
100	5500	20.75	20.69
116	5580	20.57	20.32
140	5700	20.69	20.68
144 (U-NII-2C Band)	5720	15.17	15.24

802.11ax (HE20)

Channel	Frequency (MHz)	26dB Bandwidth (MHz)	
		Chain0	Chain1
52	5260	21.59	21.97
60	5300	21.86	21.8
64	5320	21.9	21.84
100	5500	21.22	21.78
116	5580	21.66	21.58
140	5700	21.99	22.11
144 (U-NII-2C Band)	5720	15.7	16.07

802.11ax (HE40)

Channel	Frequency (MHz)	26dB Bandwidth (MHz)	
		Chain0	Chain1
54	5270	42.53	42.39
62	5310	42.4	42.43
102	5510	42.29	42.63
110	5550	42.63	42.45
134	5670	42.24	42.65
142 (U-NII-2C Band)	5710	36.11	36.33

802.11ax (HE80)

Channel	Frequency (MHz)	26dB Bandwidth (MHz)	
		Chain0	Chain1
58	5290	83.3	83.03
106	5530	83.46	83.57
122	5610	83.54	83
138 (U-NII-2C Band)	5690	76.68	76.43

Spectrum Plot of Worst Value

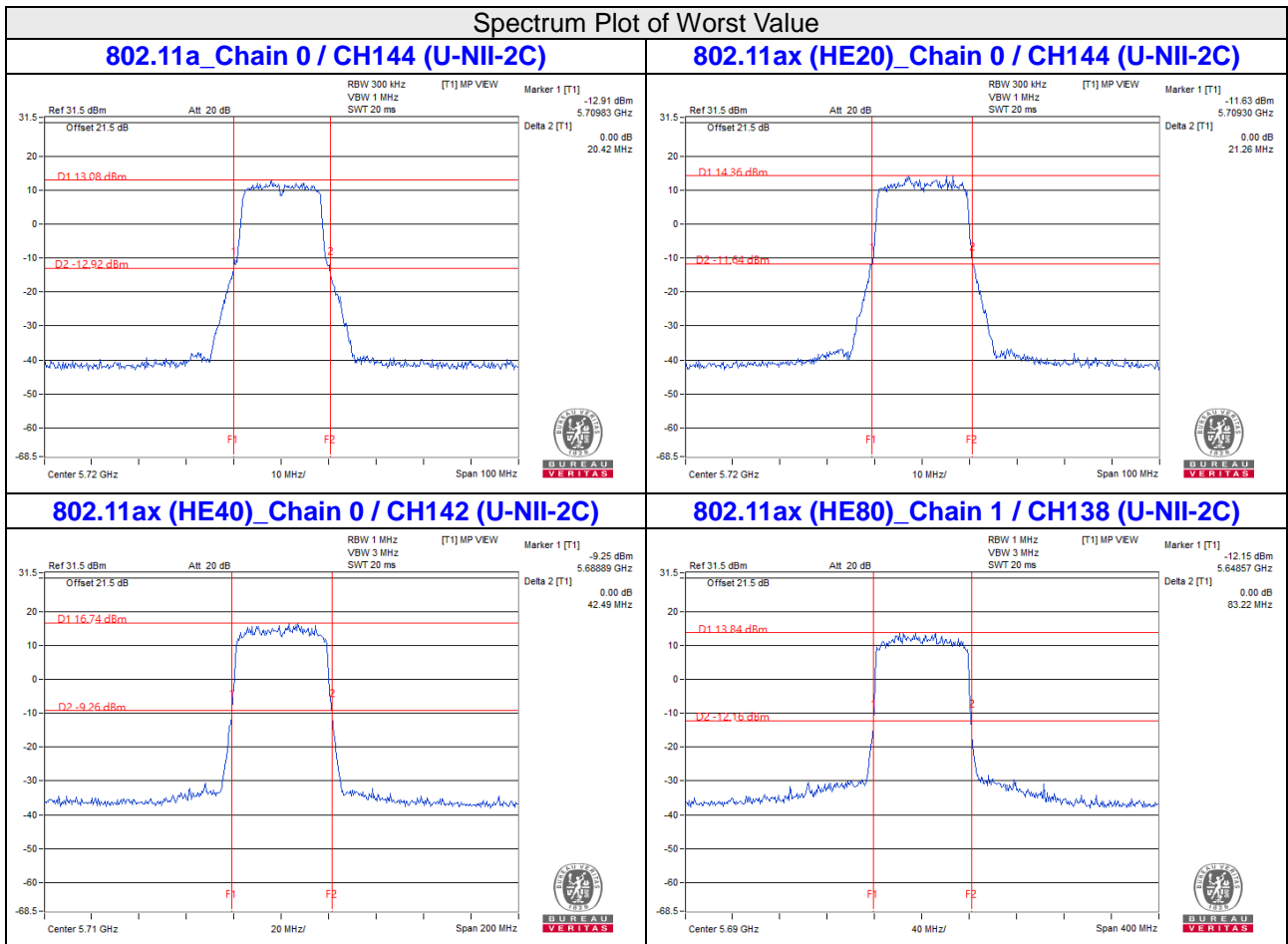

Note:

- For CH144 (U-NII-2C) = 5725MHz - Marker 1
- For CH142 (U-NII-2C) = 5725MHz - Marker 1
- For CH138 (U-NII-2C) = 5725MHz - Marker 1

For channel straddling 5725MHz of 26dB BW

Spectrum Plot Value of 26dB BW

802.11a_Chain 0 / CH144 (U-NII-3 Band)

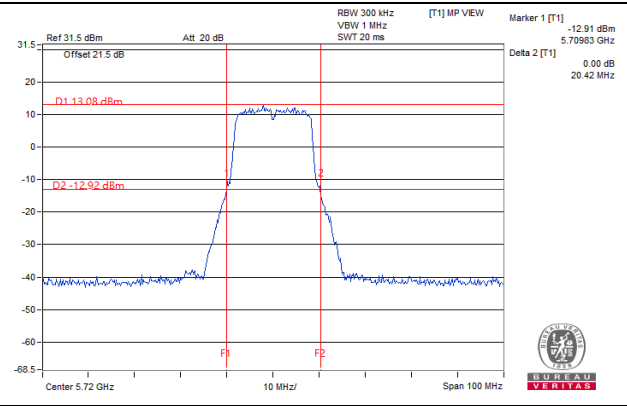

802.11a_Chain 1 / CH144 (U-NII-3 Band)

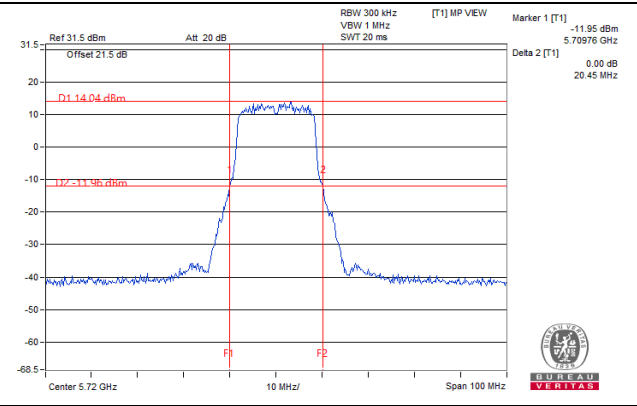

802.11ax (HE20)_Chain 0/ CH144 (U-NII-2C Band)

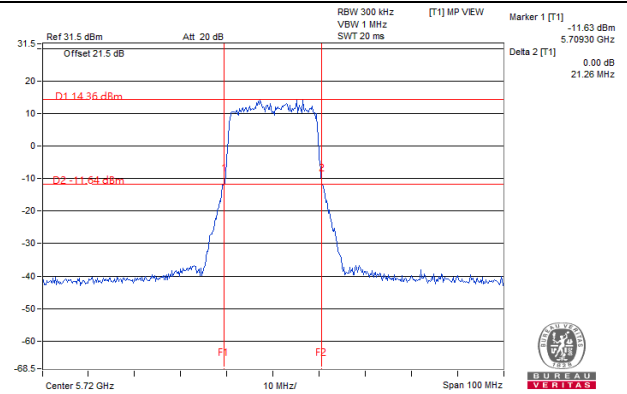

802.11ax (HE20)_Chain 1/ CH144 (U-NII-2C Band)

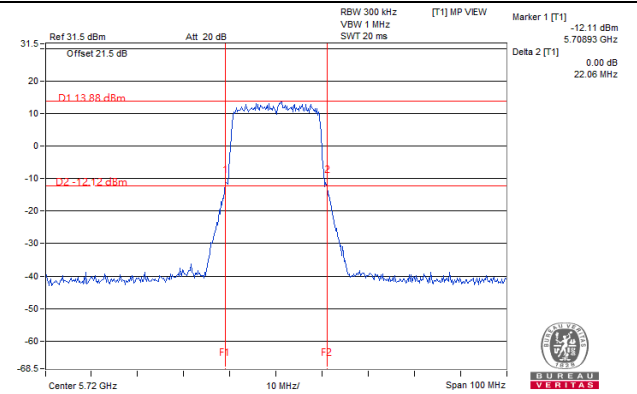

802.11ax (HE40)_Chain 0 / CH142 (U-NII-2C Band)

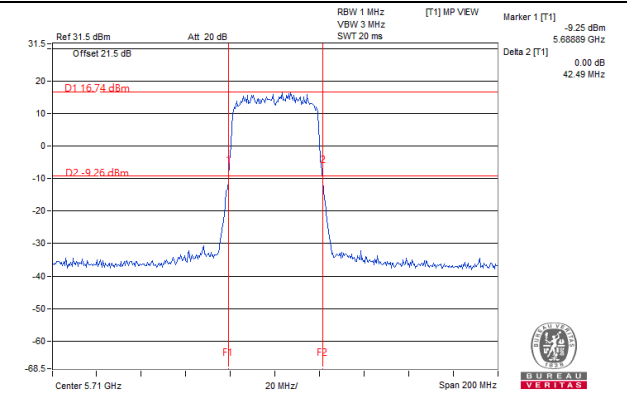

802.11ax (HE40)_Chain 1 / CH142 (U-NII-2C Band)

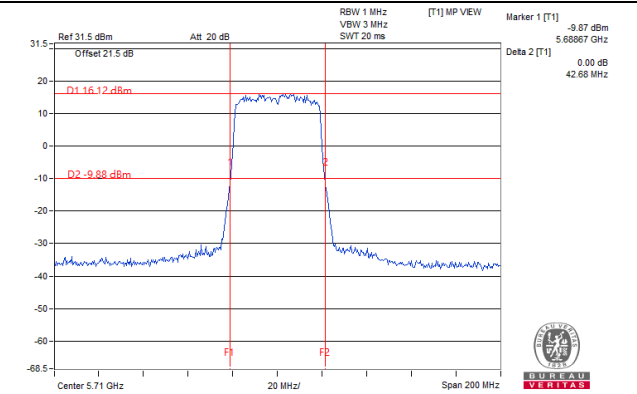

802.11ax (HE80)_Chain 0/ CH138 (U-NII-2C Band)

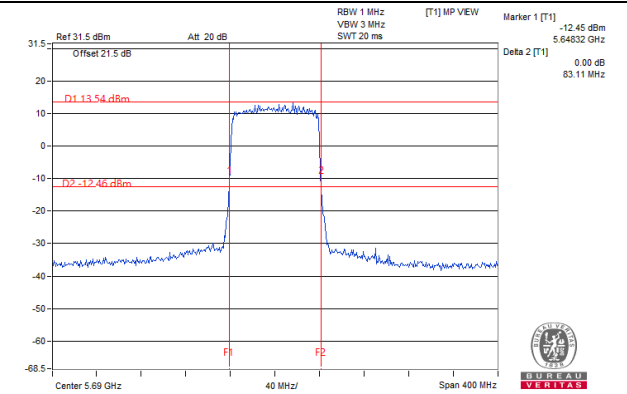

802.11ax (HE80)_Chain 1/ CH138 (U-NII-2C Band)

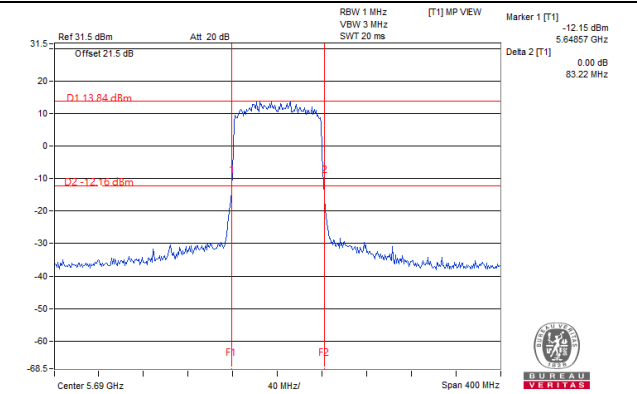

Note:

For CH144 (U-NII-2C Band) = 5725MHz - Marker 1

For CH142 (U-NII-2C Band) = 5725MHz - Marker 1

For CH138 (U-NII-2C Band) = 5725MHz - Marker 1

4.4 Occupied Bandwidth Measurement

4.4.1 Test Setup

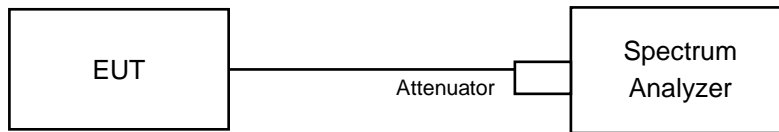

4.4.2 Test Instruments

Refer to section 4.1.2 to get information of above instrument.

4.4.3 Test Procedure

The transmitter output was connected to the spectrum analyzer through an attenuator. The bandwidth of the fundamental frequency was measured by spectrum analyzer with resolution bandwidth in the range of 1% to 5% of the anticipated emission bandwidth, and a video bandwidth at least 3x the resolution bandwidth and set the detector to SAMPLE. The width of a frequency band such that, below the lower and above the upper frequency limits, the mean powers emitted are each equal to a specified percentage 0.5% of the total mean power of a given emission.

4.4.4 Test Results

802.11a

Channel	Channel Frequency (MHz)	Occupied Bandwidth (MHz)	
		Chain 0	Chain 1
52	5260	16.44	16.56
60	5300	16.44	16.44
64	5320	16.56	16.44
100	5500	16.56	16.44
116	5580	16.44	16.56
140	5700	16.44	16.44
144 (U-NII-2C Band)	5720	13.28	13.4
144 (U-NII-3 Band)	5720	3.16	3.16

802.11ax (HE20)

Channel	Channel Frequency (MHz)	Occupied Bandwidth (MHz)	
		Chain 0	Chain 1
52	5260	19.08	18.96
60	5300	18.96	18.96
64	5320	18.96	18.96
100	5500	19.08	19.08
116	5580	19.08	18.84
140	5700	19.08	18.96
144 (U-NII-2C Band)	5720	14.6	14.6
144 (U-NII-3 Band)	5720	4.48	4.48

802.11ax (HE40)

Channel	Channel Frequency (MHz)	Occupied Bandwidth (MHz)	
		Chain 0	Chain 1
54	5270	38.16	38.16
62	5310	38.16	38.16
102	5510	38.16	38.16
110	5550	38.16	37.92
134	5670	38.16	37.92
142 (U-NII-2C Band)	5710	34.2	34.2
142 (U-NII-3 Band)	5710	3.72	3.96

802.11ax (HE80)

Channel	Channel Frequency (MHz)	Occupied Bandwidth (MHz)	
		Chain 0	Chain 1
58	5290	77.28	77.28
106	5530	77.28	77.28
122	5610	77.28	77.28
138 (U-NII-2C Band)	5690	73.88	73.88
138 (U-NII-3 Band)	5690	3.4	3.4

Spectrum Plot of Max. Value

802.11a_Chain 0 / CH64

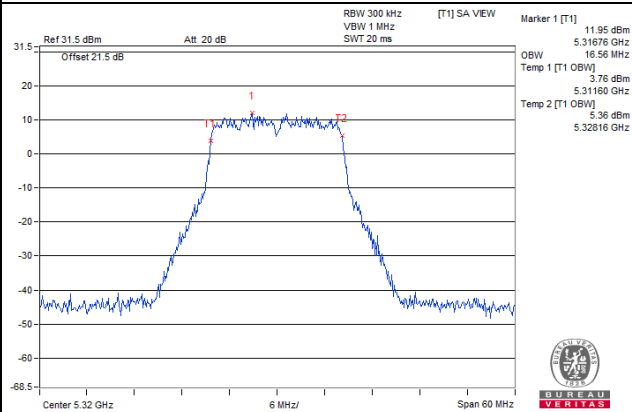

802.11ax (HE20)_Chain 0 / CH52

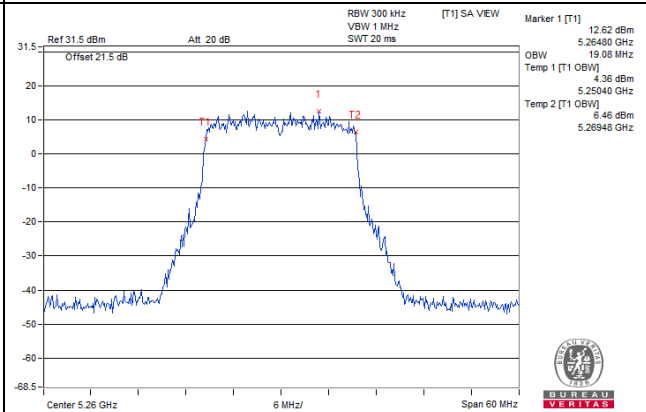

802.11ax (HE40)_Chain 0 / CH54

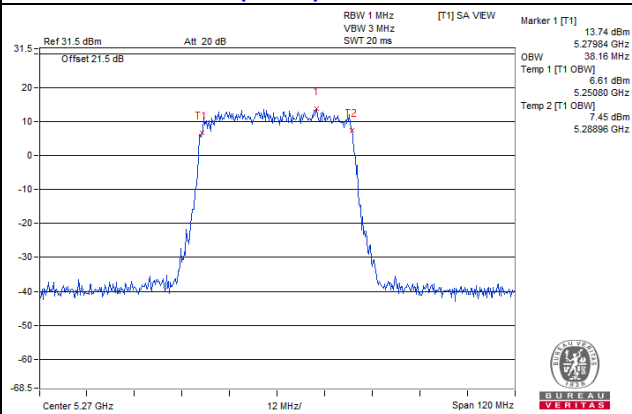

802.11ax (HE80)_Chain 0 / CH58

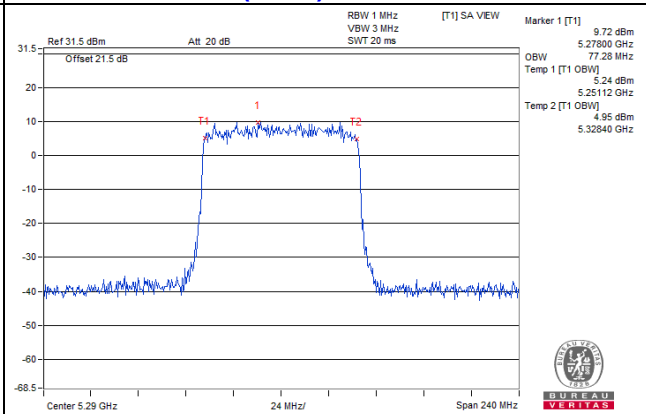

For channel straddling 5725MHz of OCP99 BW

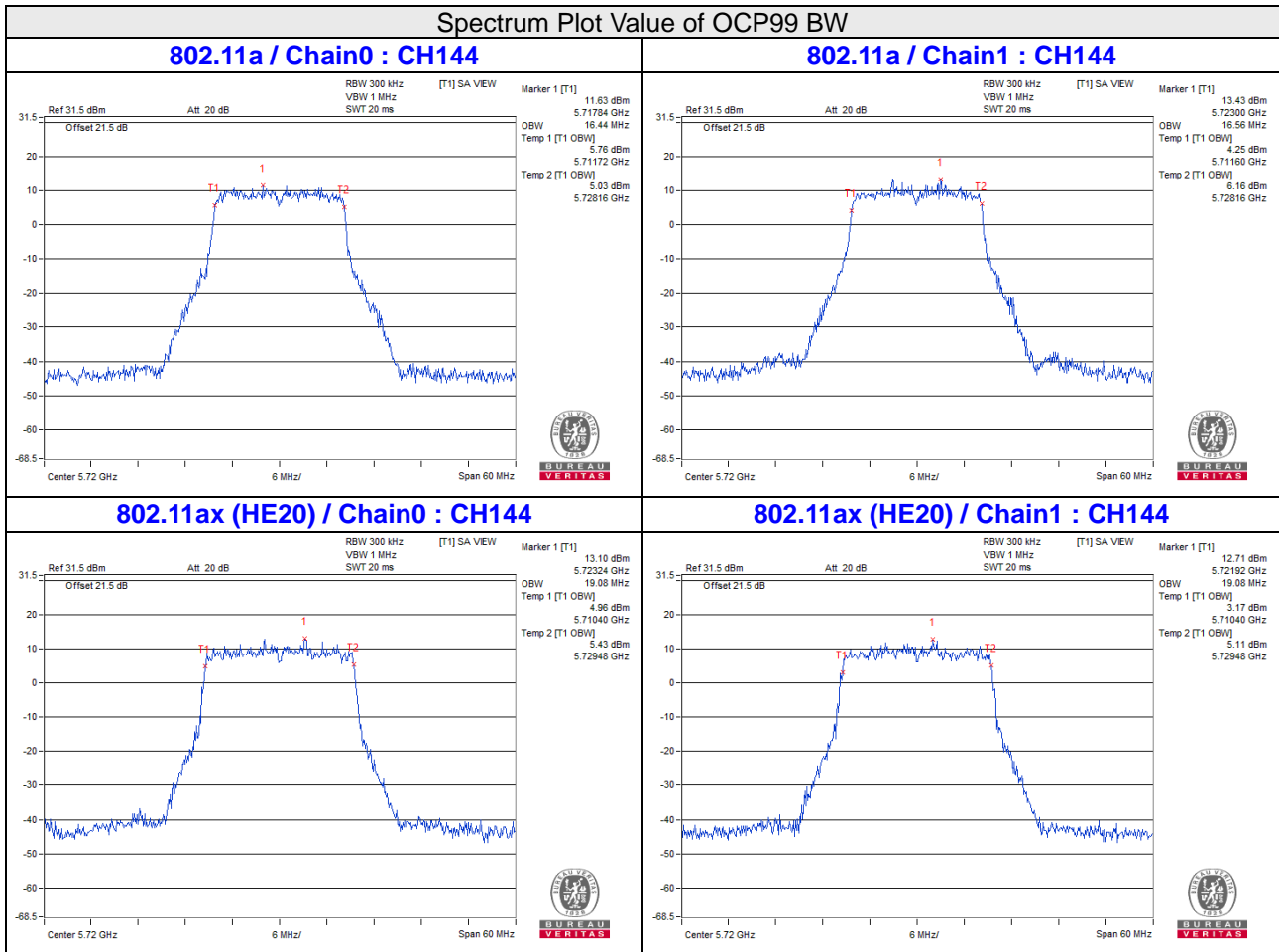

Spectrum Plot Value of OCP99 BW

802.11ax (HE40) / Chain0 : CH142

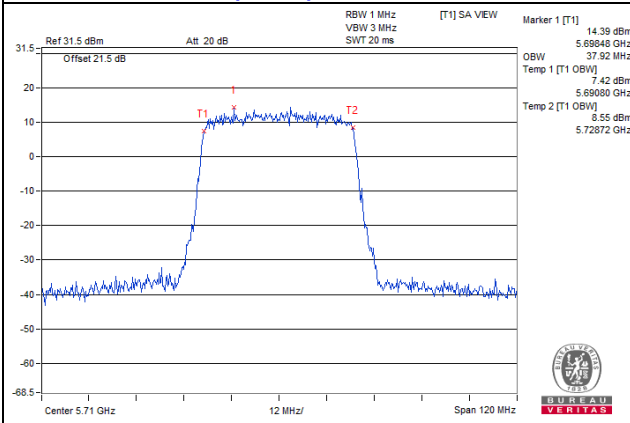

802.11ax (HE40) / Chain1 : CH142

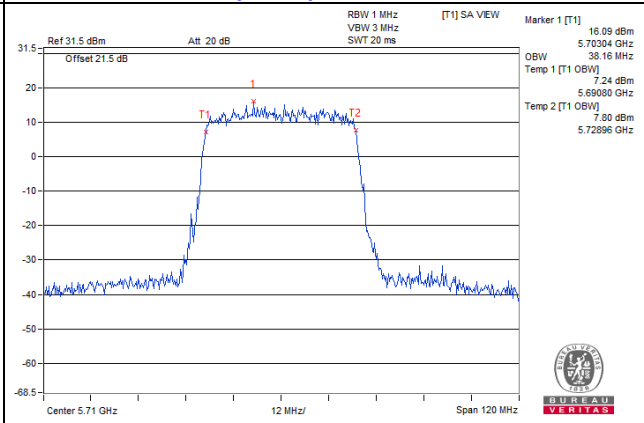

802.11ax (HE80) / Chain0 : CH138

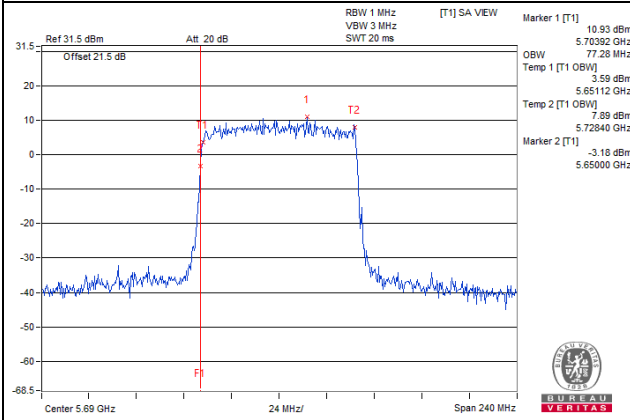

802.11ax (HE80) / Chain1 : CH138

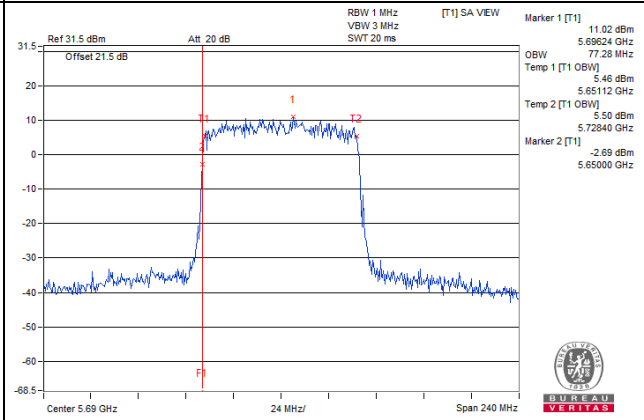

Note:

- For CH144 (U-NII-2C) = 5725MHz - Temp 1
- For CH142 (U-NII-2C) = 5725MHz - Temp 1
- For CH138 (U-NII-2C) = 5725MHz - Temp 1
- For CH144 (U-NII-3) = Temp 2 - 5725MHz
- For CH142 (U-NII-3) = Temp 2 - 5725MHz
- For CH138 (U-NII-3) = Temp 2 - 5725MHz

4.5 Peak Power Spectral Density Measurement

4.5.1 Limits of Peak Power Spectral Density Measurement

Operation Band	EUT Category		Limit
U-NII-1		Outdoor Access Point	17dBm/ MHz
		Fixed point-to-point Access Point	
		Indoor Access Point	
		Client device	11dBm/ MHz
U-NII-2A	√		11dBm/ MHz
U-NII-2C	√		11dBm/ MHz
U-NII-3	√		30dBm/ 500kHz

4.5.2 Test Setup

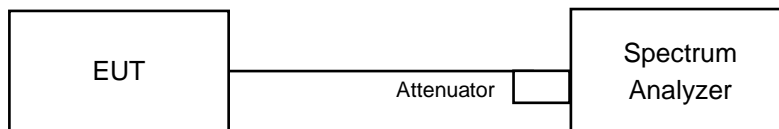

4.5.3 Test Instruments

Refer to section 4.1.2 to get information of above instrument.

4.5.4 Test Procedure

For U-NII-2A, U-NII-2C band:

Using method SA-2

1. Set span to encompass the entire emission bandwidth (EBW) of the signal.
2. Set RBW = 1 MHz, Set VBW ≥ 3 MHz, Detector = RMS
3. Sweep time = auto, trigger set to "free run".
4. Trace average at least 100 traces in power averaging mode.
5. Record the max value and add 10 log (1/duty cycle)

For U-NII-3:

1. Set span to encompass the entire emission bandwidth (EBW) of the signal.
2. Set RBW = 300 kHz, Set VBW ≥ 1 MHz, Detector = RMS
3. Use the peak marker function to determine the maximum power level in any 300 kHz band segment within the fundamental EBW.
4. Scale the observed power level to an equivalent value in 500 kHz by adjusting (reducing) the measured power by a bandwidth correction factor (BWCF) where $BWCF = 10\log(500\text{ kHz}/300\text{ kHz})$
5. Sweep time = auto, trigger set to "free run".
6. Trace average at least 100 traces in power averaging mode.
7. Record the max value and add 10 log (1/duty cycle)

4.5.5 Deviation from Test Standard

No deviation.

4.5.6 EUT Operating Condition

Same as Item 4.3.6.

4.5.7 Test Results

For U-NII-2A, U-NII-2C:

CDD Mode

802.11a

Chan.	Chan. Freq. (MHz)	PSD w/o Duty Factor (dBm/MHz)		Duty Factor (dB)	Total PSD (dBm/MHz)	Max. PSD Limit (dBm/MHz)	Pass / Fail
		Chain 0	Chain 1				
52	5260	6.19	7.59	0.25	10.21	11.00	PASS
60	5300	6.79	8.03	0.25	10.71	11.00	PASS
64	5320	5.94	7.78	0.25	10.22	11.00	PASS
100	5500	5.58	7.57	0.25	9.95	10.91	PASS
116	5580	6.32	7.77	0.25	10.37	10.91	PASS
140	5700	5.89	7.30	0.25	9.91	10.91	PASS
144 (U-NII-2C Band)	5720	4.62	7.30	0.25	9.42	10.91	PASS

- Note: 1. Method a) of power density measurement of KDB 662911 is using for calculating total power density. Total power density is summing entire spectra across corresponding frequency bins on the various outputs by computer.
2. For U-NII-2A: The directional gain = $10 \log[(10^{G0/20} + 10^{G1/20})^2 / 2] = 5.88 \text{ dBi} < 6 \text{ dBi}$, so the power density limit shall not be reduced.
3. For U-NII-2C: The directional gain = $10 \log[(10^{G0/20} + 10^{G1/20})^2 / 2] = 6.09 \text{ dBi} > 6 \text{ dBi}$, so the power density limit shall be reduced to $11 - (6.09 - 6) = 10.91 \text{ dBm}$.
4. Refer to section 3.3 for duty cycle spectrum plot.

Beamforming Mode

802.11ax (HE20)

Chan.	Chan. Freq. (MHz)	PSD w/o Duty Factor (dBm/MHz)		Duty Factor (dB)	Total PSD (dBm/MHz)	Max. PSD Limit (dBm/MHz)	Pass / Fail
		Chain 0	Chain 1				
52	5260	5.90	6.42	0.27	9.45	11.00	PASS
60	5300	5.23	5.87	0.27	8.84	11.00	PASS
64	5320	5.20	5.62	0.27	8.70	11.00	PASS
100	5500	6.11	5.77	0.27	9.22	10.91	PASS
116	5580	4.43	6.26	0.27	8.72	10.91	PASS
140	5700	5.58	5.36	0.27	8.75	10.91	PASS
144 (U-NII-2C Band)	5720	5.39	4.98	0.27	8.47	10.91	PASS

- Note: 1. Method a) of power density measurement of KDB 662911 is using for calculating total power density. Total power density is summing entire spectra across corresponding frequency bins on the various outputs by computer.
2. For U-NII-2A: The directional gain = $10 \log[(10^{G0/20} + 10^{G1/20})^2 / 2] = 5.88 \text{ dBi} < 6 \text{ dBi}$, so the power density limit shall not be reduced.
3. For U-NII-2C: The directional gain = $10 \log[(10^{G0/20} + 10^{G1/20})^2 / 2] = 6.09 \text{ dBi} > 6 \text{ dBi}$, so the power density limit shall be reduced to $11 - (6.09 - 6) = 10.91 \text{ dBm}$.
4. Refer to section 3.3 for duty cycle spectrum plot.

802.11ax (HE40)

Chan.	Chan. Freq. (MHz)	PSD w/o Duty Factor (dBm/MHz)		Duty Factor (dB)	Total PSD (dBm/MHz)	Max. PSD Limit (dBm/MHz)	Pass / Fail
		Chain 0	Chain 1				
54	5270	1.75	1.90	0.20	5.04	11.00	PASS
62	5310	2.49	2.53	0.20	5.72	11.00	PASS
102	5510	1.47	0.80	0.20	4.36	10.91	PASS
110	5550	1.98	2.71	0.20	5.57	10.91	PASS
134	5670	3.40	2.10	0.20	6.01	10.91	PASS
142 (U-NII-2C Band)	5710	3.19	2.83	0.20	6.22	10.91	PASS

- Note: 1. Method a) of power density measurement of KDB 662911 is using for calculating total power density. Total power density is summing entire spectra across corresponding frequency bins on the various outputs by computer.
2. For U-NII-2A: The directional gain $=10 \log[(10^{G0/20} + 10^{G1/20})^2 / 2] = 5.88 \text{ dBi} < 6\text{dBi}$, so the power density limit shall not be reduced.
3. For U-NII-2C: The directional gain $=10 \log[(10^{G0/20} + 10^{G1/20})^2 / 2] = 6.09 \text{ dBi} > 6\text{dBi}$, so the power density limit shall be reduced to $11-(6.09-6) = 10.91 \text{ dBm}$.
4. Refer to section 3.3 for duty cycle spectrum plot.

802.11ax (HE80)

Chan.	Chan. Freq. (MHz)	PSD w/o Duty Factor (dBm/MHz)		Duty Factor (dB)	Total PSD (dBm/MHz)	Max. PSD Limit (dBm/MHz)	Pass / Fail
		Chain 0	Chain 1				
58	5290	-0.31	-0.70	0.20	2.71	11.00	PASS
106	5530	-1.28	-1.46	0.20	1.84	10.91	PASS
122	5610	-0.50	-0.10	0.20	2.91	10.91	PASS
138 (U-NII-2C Band)	5690	-0.37	0.09	0.20	3.08	10.91	PASS

- Note: 1. Method a) of power density measurement of KDB 662911 is using for calculating total power density. Total power density is summing entire spectra across corresponding frequency bins on the various outputs by computer.
2. For U-NII-2A: The directional gain $=10 \log[(10^{G0/20} + 10^{G1/20})^2 / 2] = 5.88 \text{ dBi} < 6\text{dBi}$, so the power density limit shall not be reduced.
3. For U-NII-2C: The directional gain $=10 \log[(10^{G0/20} + 10^{G1/20})^2 / 2] = 6.09 \text{ dBi} > 6\text{dBi}$, so the power density limit shall be reduced to $11-(6.09-6) = 10.91 \text{ dBm}$.
4. Refer to section 3.3 for duty cycle spectrum plot.

Spectrum Plot of Worst Value

802.11a_Chain 1 / CH60

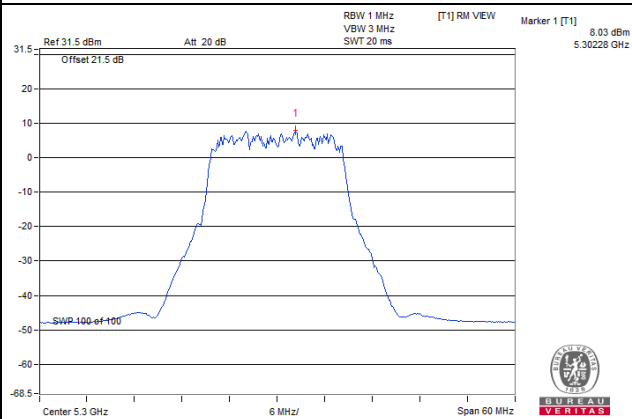

802.11ax (HE20)_Chain 1 / CH52

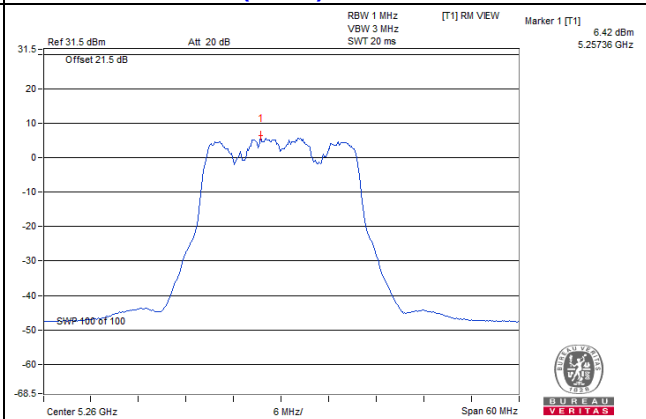

802.11ax (HE40)_Chain 0 / CH134

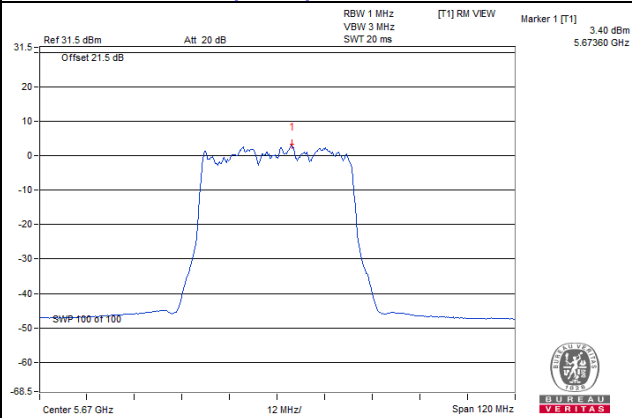

802.11ax (HE80)_Chain 1 / CH138 (U-NII-2C Band)

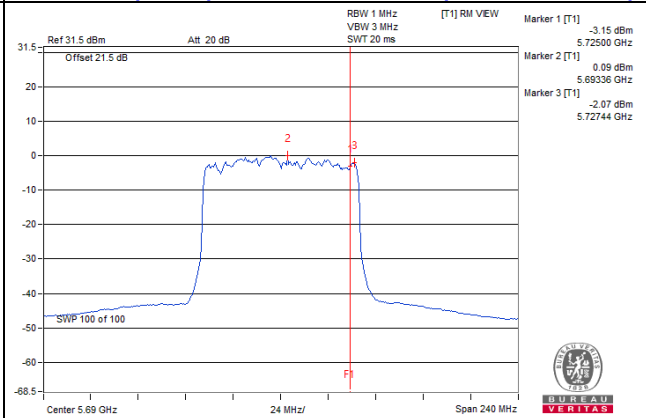

For U-NII-3:

CDD Mode

802.11a

Chan.	Chan. Freq. (MHz)	PSD w/o Duty Factor (dBm/300kHz)		Duty Factor (dB)	Total PSD (dBm/300kHz)	Total PSD (dBm/500kHz)	PSD Limit (dBm/500kHz)	Pass / Fail
		Chain0	Chain1					
144 (U-NII-3)	5720	-2.66	-1.74	0.25	1.08	3.30	29.91	Pass

- Note: 1. Method b) Measure and sum spectral maxima across the outputs of KDB 662911 is using for calculating total power density.
 2. The directional gain is 6.09 dBi > 6dBi, so the power density limit shall be reduced to $30-(6.09-6) = 29.91$ dBm.
 3. Refer to section 3.3 for duty cycle spectrum plot.

Beamforming Mode

802.11ax (HE20)

Chan.	Chan. Freq. (MHz)	PSD w/o Duty Factor (dBm/300kHz)		Duty Factor (dB)	Total PSD (dBm/300kHz)	Total PSD (dBm/500kHz)	PSD Limit (dBm/500kHz)	Pass / Fail
		Chain0	Chain1					
144 (U-NII-3)	5720	-3.97	-4.71	0.27	-1.04	1.18	29.91	Pass

- Note: 1. Method b) Measure and sum spectral maxima across the outputs of KDB 662911 is using for calculating total power density.
 2. The directional gain is 6.09 dBi > 6dBi, so the power density limit shall be reduced to $30-(6.09-6) = 29.91$ dBm.
 3. Refer to section 3.3 for duty cycle spectrum plot.

802.11ax (HE40)

Chan.	Chan. Freq. (MHz)	PSD w/o Duty Factor (dBm/300kHz)		Duty Factor (dB)	Total PSD (dBm/300kHz)	Total PSD (dBm/500kHz)	PSD Limit (dBm/500kHz)	Pass / Fail
		Chain0	Chain1					
142 (U-NII-3)	5720	-7.08	-6.17	0.20	-3.39	-1.17	29.91	Pass

- Note: 1. Method b) Measure and sum spectral maxima across the outputs of KDB 662911 is using for calculating total power density.
 2. The directional gain is 6.09 dBi > 6dBi, so the power density limit shall be reduced to $30-(6.09-6) = 29.91$ dBm.
 3. Refer to section 3.3 for duty cycle spectrum plot.

802.11ax (HE80)

Chan.	Chan. Freq. (MHz)	PSD w/o Duty Factor (dBm/300kHz)		Duty Factor (dB)	Total PSD (dBm/300kHz)	Total PSD (dBm/500kHz)	PSD Limit (dBm/500kHz)	Pass / Fail
		Chain0	Chain1					
138 (U-NII-3)	5720	-11.09	-10.90	0.20	-7.78	-5.56	29.91	Pass

- Note: 1. Method b) Measure and sum spectral maxima across the outputs of KDB 662911 is using for calculating total power density.
 2. The directional gain is 6.09 dBi > 6dBi, so the power density limit shall be reduced to $30-(6.09-6) = 29.91$ dBm.
 3. Refer to section 3.3 for duty cycle spectrum plot.

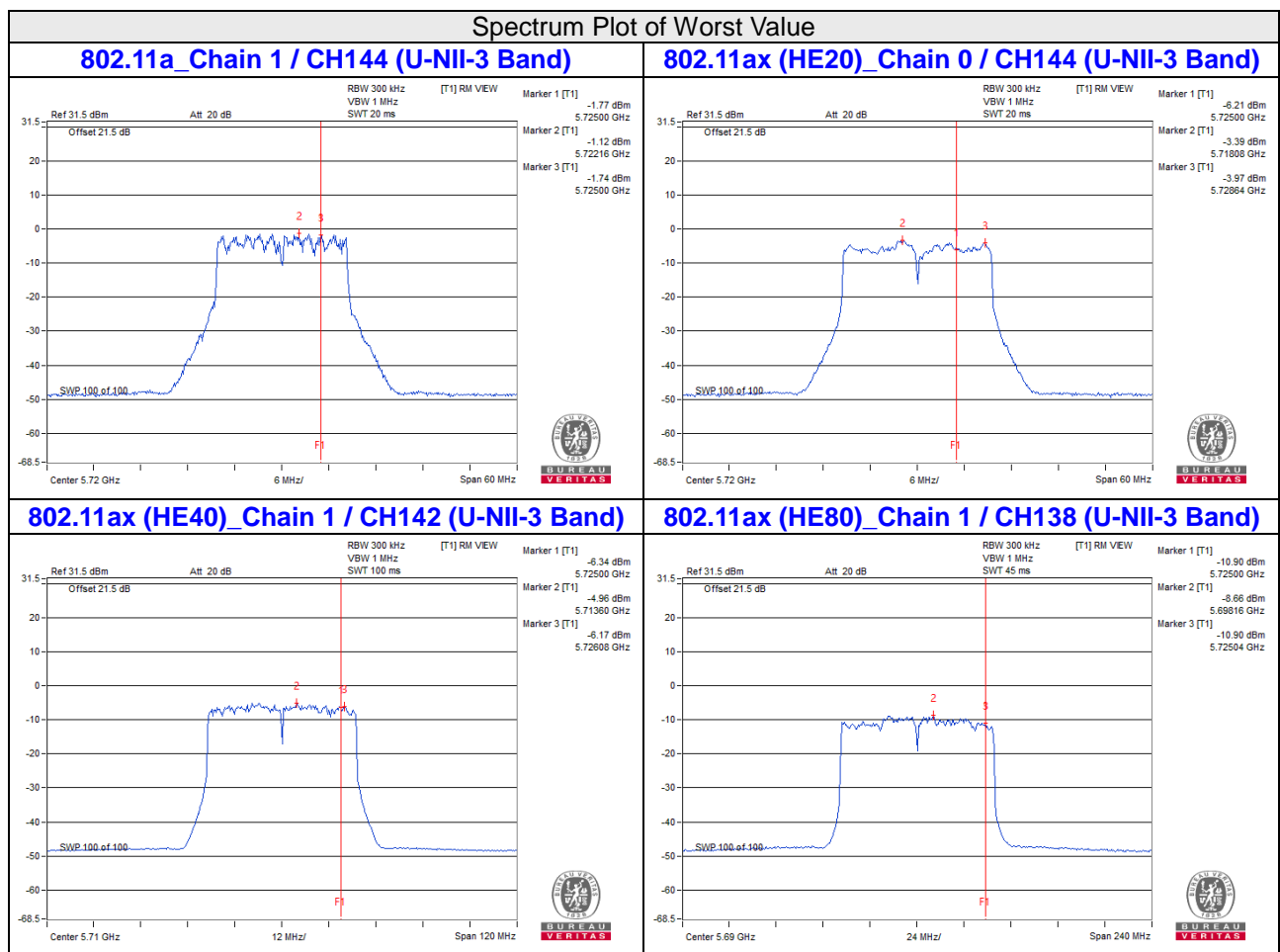

4.6 Frequency Stability Measurement

4.6.1 Limits of Frequency Stability Measurement

The frequency of the carrier signal shall be maintained within band of operation

4.6.2 Test Setup

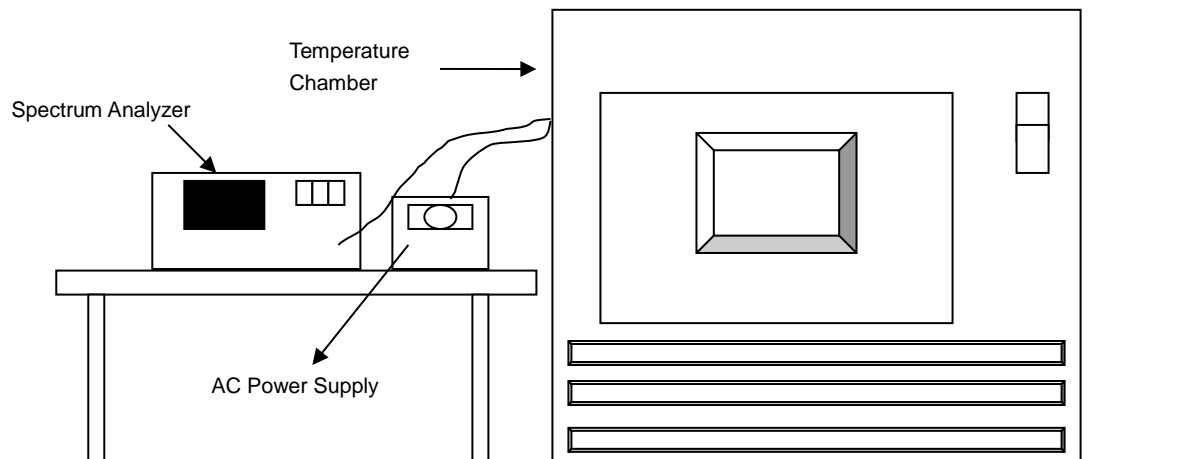

4.6.3 Test Instruments

Refer to section 4.1.2 to get information of above instrument.

4.6.4 Test Procedure

- The EUT was placed inside the environmental test chamber and powered by nominal AC voltage.
- Turn the EUT on and couple its output to a spectrum analyzer.
- Turn the EUT off and set the chamber to the highest temperature specified.
- Allow sufficient time (approximately 30 min) for the temperature of the chamber to stabilize, turn the EUT on and measure the operating frequency after 2, 5, and 10 Minutes.
- Repeat step (d) with the temperature chamber set to the next desired temperature until measurements down to the lowest specified temperature have been completed.
- The test chamber was allowed to stabilize at +20 degree C for a minimum of 30 Minutes. The supply voltage was then adjusted on the EUT from 85% to 115% and the frequency record.

4.6.5 Deviation from Test Standard

No deviation.

4.6.6 EUT Operating Condition

Set the EUT transmit at un-modulation mode to test frequency stability.

4.6.7 Test Results

Frequency Stability Versus Temp.									
Operating Frequency: 5260 MHz									
TEMP. (°C)	Power Supply (Vac)	0 Minute		2 Minutes		5 Minutes		10 Minutes	
		Measured Frequency (MHz)	Pass/Fail	Measured Frequency (MHz)	Pass/Fail	Measured Frequency (MHz)	Pass/Fail	Measured Frequency (MHz)	Pass/Fail
40	120	5260.0057	Pass	5260.0053	Pass	5260.0042	Pass	5260.0071	Pass
30	120	5260.003	Pass	5260.0064	Pass	5260.0068	Pass	5260.0047	Pass
20	120	5259.9951	Pass	5259.9919	Pass	5259.9965	Pass	5259.9936	Pass
10	120	5259.9811	Pass	5259.9815	Pass	5259.9813	Pass	5259.9812	Pass
0	120	5260.0045	Pass	5260.007	Pass	5260.0054	Pass	5260.0063	Pass

Frequency Stability Versus Voltage									
Operating Frequency: 5260 MHz									
TEMP. (°C)	Power Supply (Vac)	0 Minute		2 Minutes		5 Minutes		10 Minutes	
		Measured Frequency (MHz)	Pass/Fail	Measured Frequency (MHz)	Pass/Fail	Measured Frequency (MHz)	Pass/Fail	Measured Frequency (MHz)	Pass/Fail
20	138	5259.9948	PASS	5259.9928	PASS	5259.9962	PASS	5259.9927	PASS
	120	5259.9951	PASS	5259.9919	PASS	5259.9965	PASS	5259.9936	PASS
	102	5259.9961	PASS	5259.9919	PASS	5259.9958	PASS	5259.9945	PASS

4.7 6dB Bandwidth Measurement

4.7.1 Limits of 6dB Bandwidth Measurement

The minimum of 6dB Bandwidth Measurement is 0.5MHz.

4.7.2 Test Setup

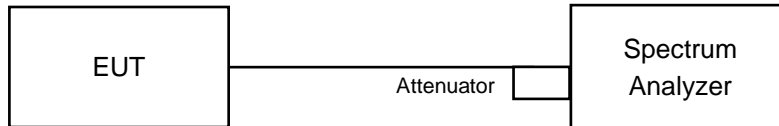

4.7.3 Test Instruments

Refer to section 4.1.2 to get information of above instrument.

4.7.4 Test Procedure

MEASUREMENT PROCEDURE REF

- Set resolution bandwidth (RBW) = 100kHz
- Set the video bandwidth (VBW) $\geq 3 \times$ RBW, Detector = Peak.
- Trace mode = max hold.
- Sweep = auto couple.
- Measure the maximum width of the emission that is constrained by the frequencies associated with the two amplitude points (upper and lower) that are attenuated by 6 dB relative to the maximum level measured in the fundamental emission

4.7.5 Deviation from Test Standard

No deviation.

4.7.6 EUT Operating Condition

The software provided by client to enable the EUT under transmission condition continuously at lowest, middle and highest channel frequencies individually.

4.7.7 Test Results

CDD Mode

802.11a

Channel	Frequency (MHz)	6dB Bandwidth (MHz)		Minimum Limit (MHz)	Pass / Fail
		Chain0	Chain1		
144 (U-NII-3)	5720	3.1	2.88	0.5	Pass

Beamforming Mode

802.11ax (HE20)

Channel	Frequency (MHz)	6dB Bandwidth (MHz)		Minimum Limit (MHz)	Pass / Fail
		Chain0	Chain1		
144 (U-NII-3)	5720	4.06	4.1	0.5	Pass

802.11ax (HE40)

Channel	Frequency (MHz)	6dB Bandwidth (MHz)		Minimum Limit (MHz)	Pass / Fail
		Chain0	Chain1		
142 (U-NII-3)	5710	3.83	3.81	0.5	Pass

802.11ax (HE80)

Channel	Frequency (MHz)	6dB Bandwidth (MHz)		Minimum Limit (MHz)	Pass / Fail
		Chain0	Chain1		
138 (U-NII-3)	5690	3.55	2.45	0.5	Pass

Spectrum Plot of Worst Value

802.11a_Chain 1 / CH144 (U-NII-3 Band)

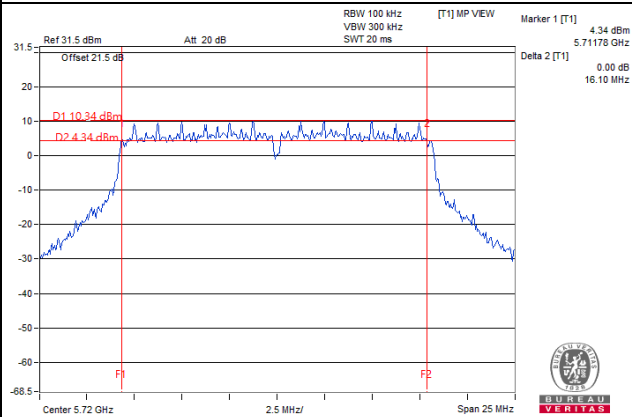

802.11ax (HE20)_Chain 0 / CH144 (U-NII-3 Band)

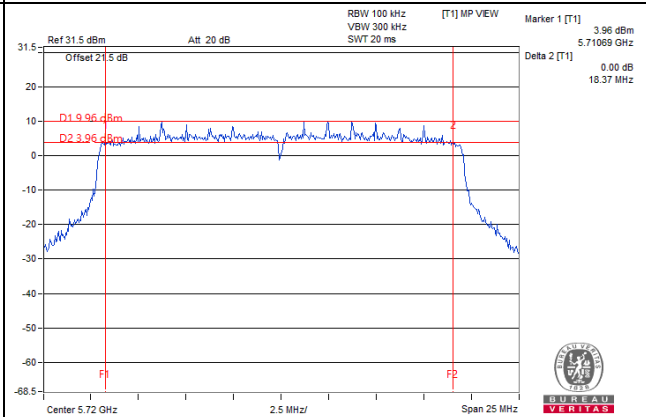

802.11ax (HE40)_Chain 1 / CH142 (U-NII-3 Band)

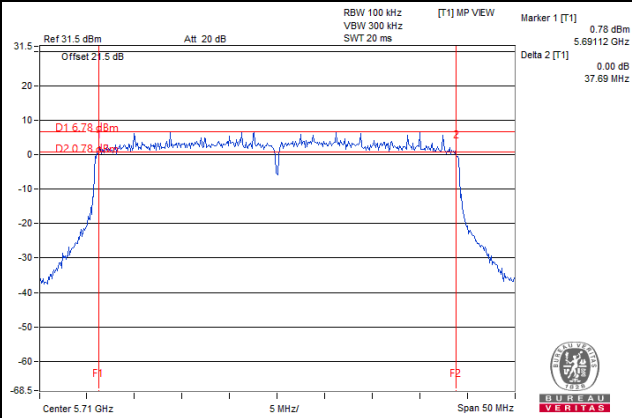

802.11ax (HE80)_Chain 1 / CH138 (U-NII-3 Band)

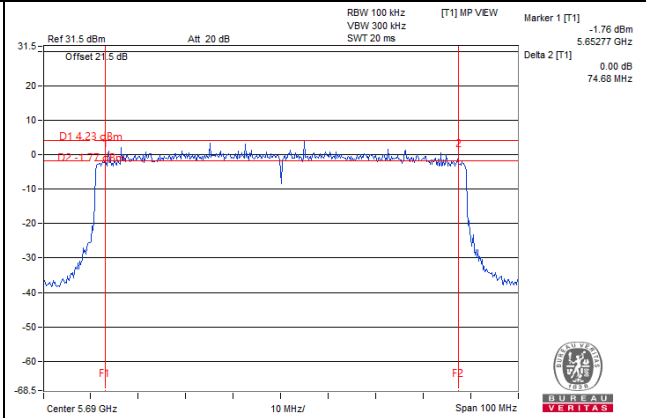

Note: The 6dB bandwidth above 5725MHz = Marker 1 + Delta 2 - 5725MHz

5 Pictures of Test Arrangements

Please refer to the attached file (Test Setup Photo).

Annex A - Band-Edge Measurement (For U-NII-2A, U-NII-2C band)

CDD Mode

802.11a

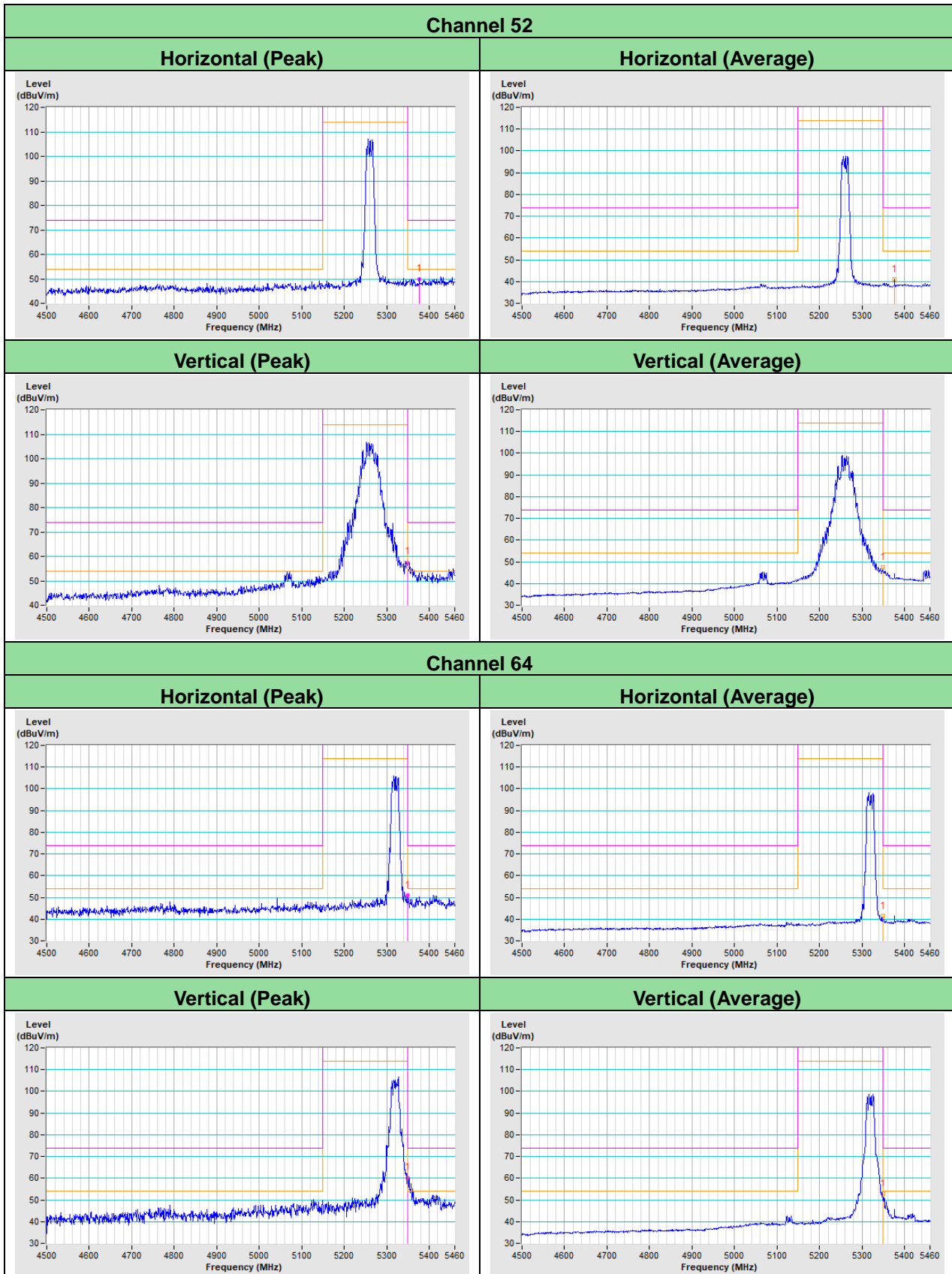

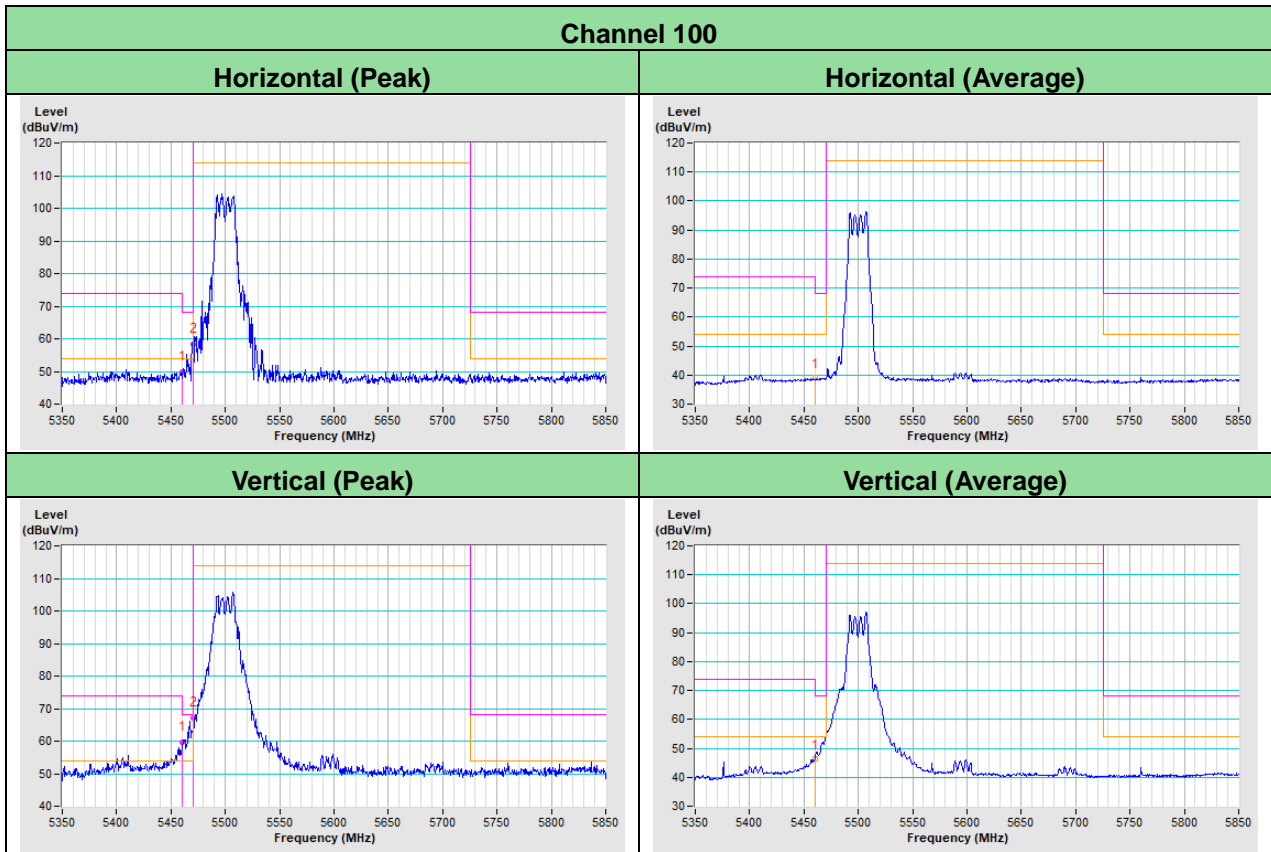

Beamforming Mode

802.11ax (HE20)

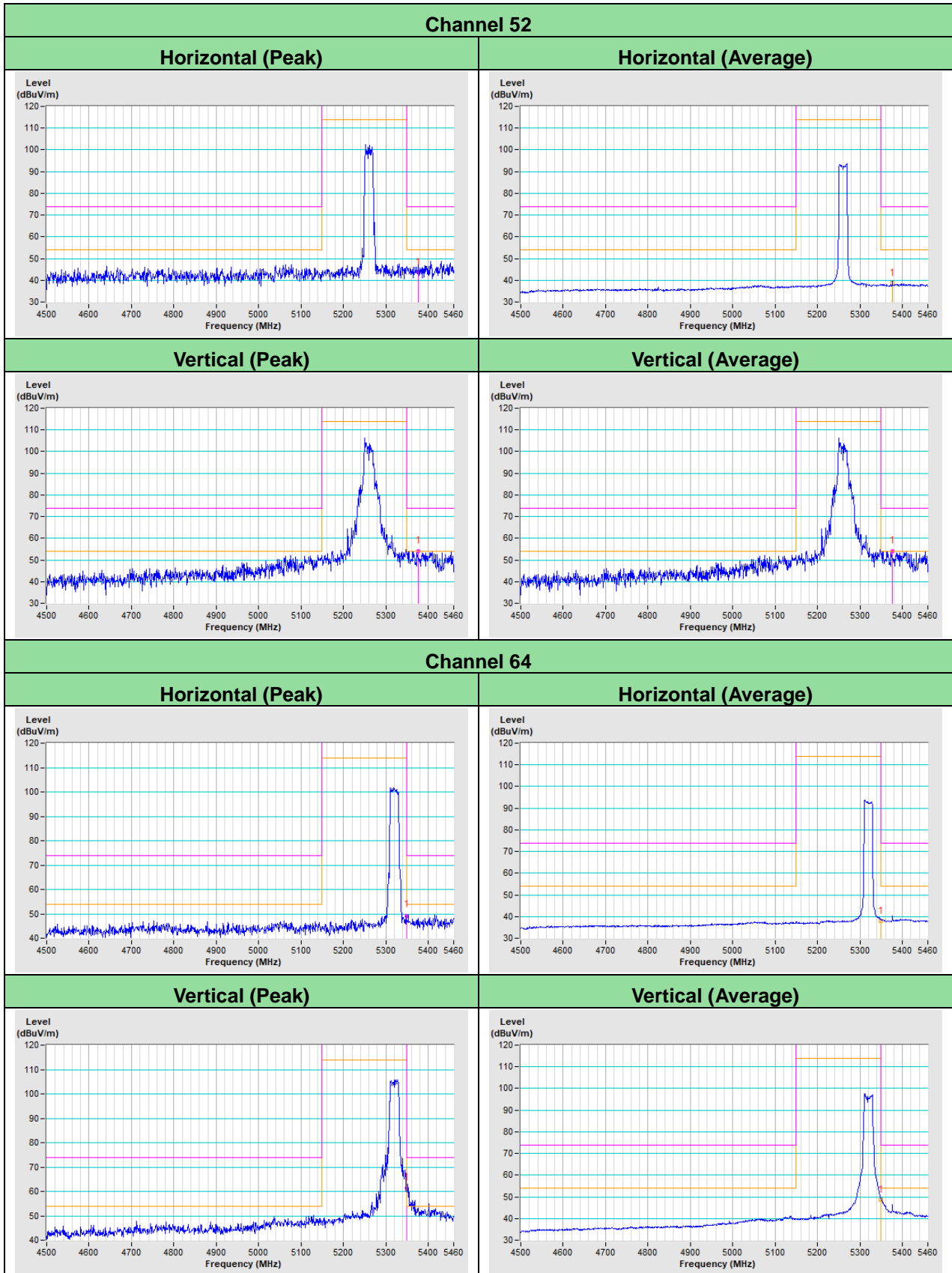

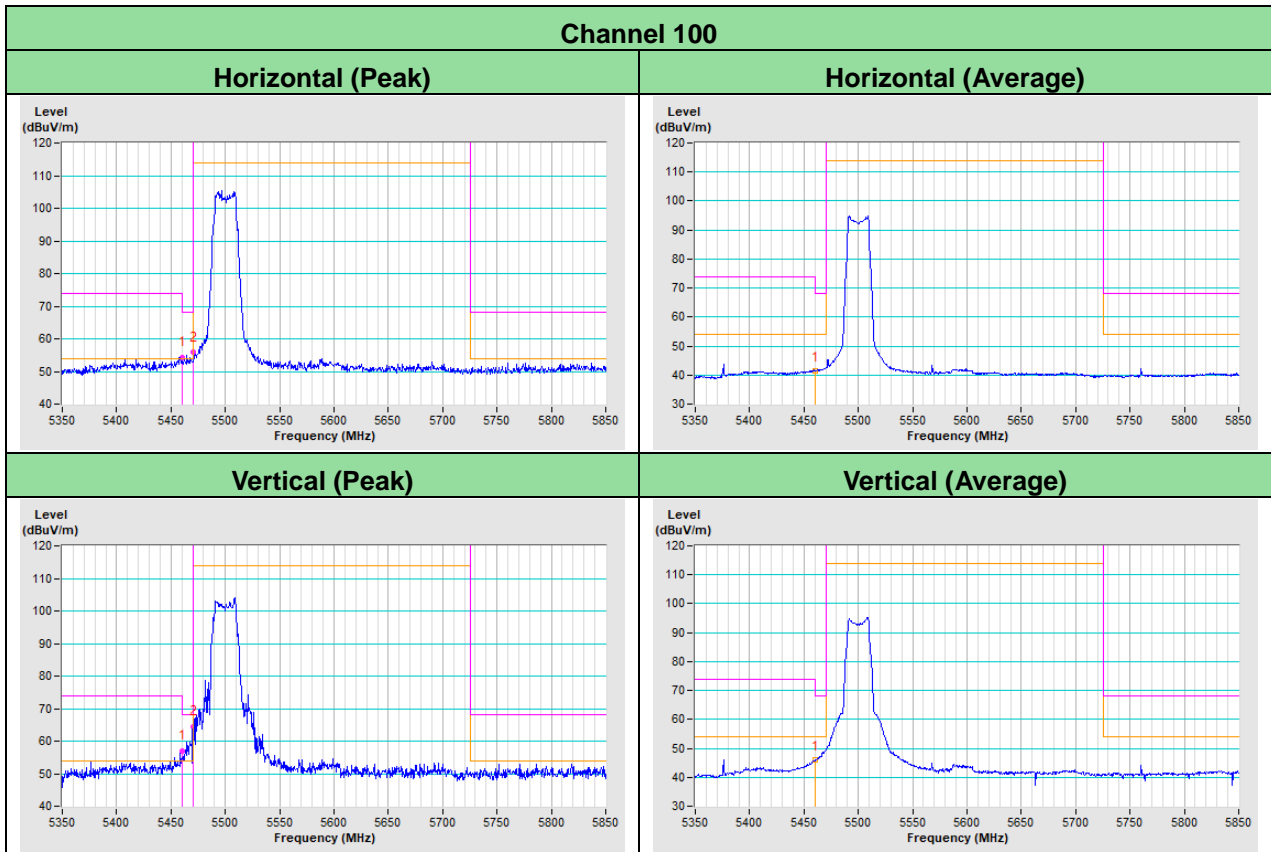

802.11ax (HE40)

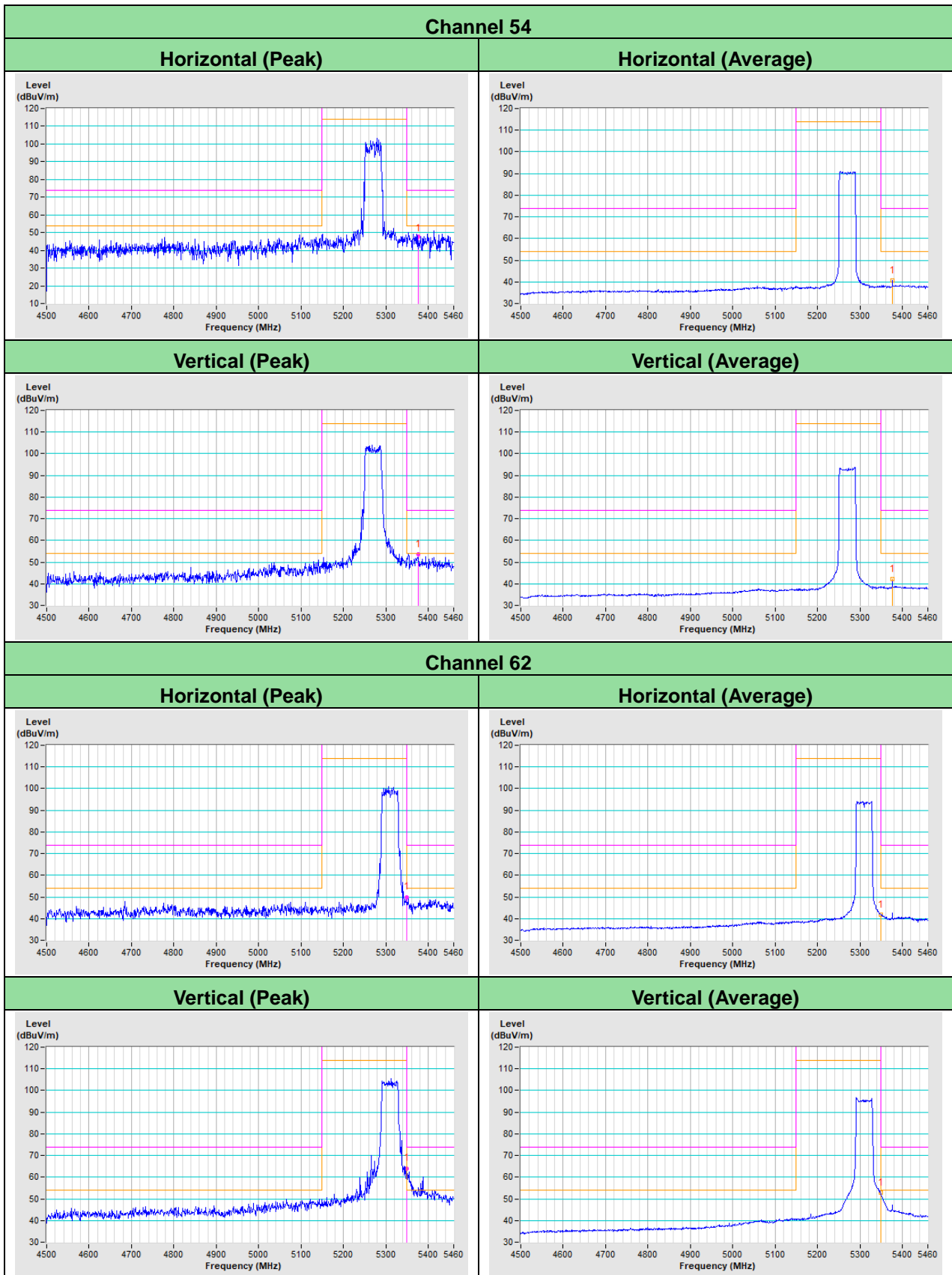

Channel 102

Horizontal (Peak)

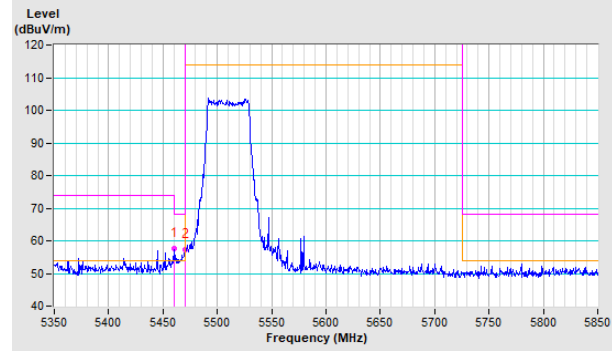

Horizontal (Average)

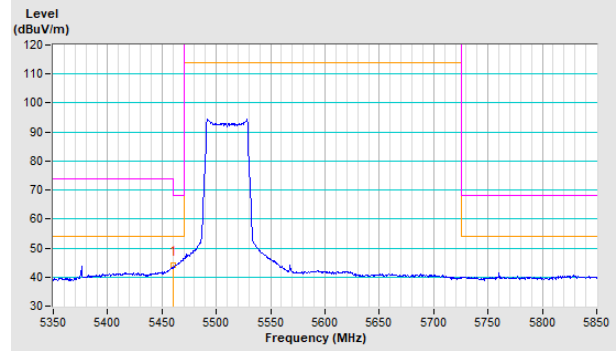

Vertical (Peak)

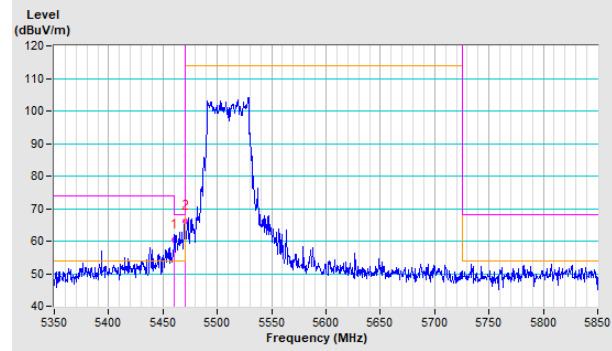

Vertical (Average)

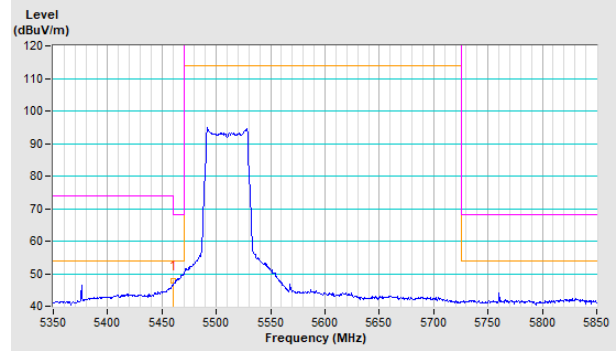

802.11ax (HE80)

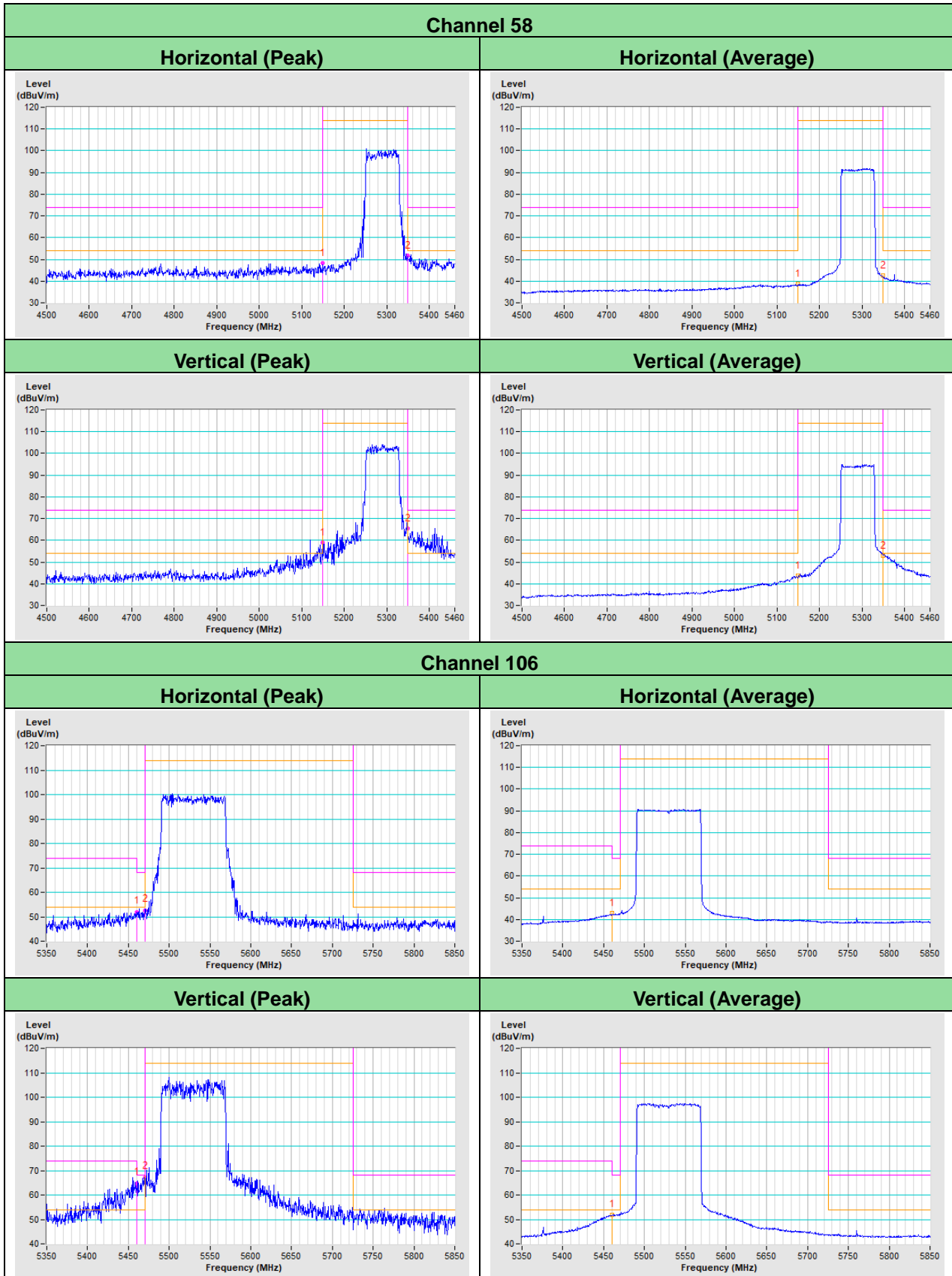

Appendix – Information of the Testing Laboratories

We, Bureau Veritas Consumer Products Services (H.K.) Ltd., Taoyuan Branch, were founded in 1988 to provide our best service in EMC, Radio, Telecom and Safety consultation. Our laboratories are FCC recognized accredited test firms and accredited according to ISO/IEC 17025.

If you have any comments, please feel free to contact us at the following:

Lin Kou EMC/RF Lab

Tel: 886-2-26052180

Fax: 886-2-26051924

Hsin Chu EMC/RF/Telecom Lab

Tel: 886-3-6668565

Fax: 886-3-6668323

Hwa Ya EMC/RF/Safety Lab

Tel: 886-3-3183232

Fax: 886-3-3270892

Email: service.adt@tw.bureauveritas.com

Web Site: www.bureauveritas-adt.com

The address and road map of all our labs can be found in our web site also.

--- END ---