

FCC Test Report

Report No.: RF171208E04-1

FCC ID: Q87-08011

Test Model: WHW03 V2

Series Model: A03 V2

Received Date: Dec. 08, 2017

Test Date: Dec. 20, 2017 to Feb. 05, 2018

Issued Date: Feb. 13, 2018

Applicant: Linksys LLC

Address: 121 Theory Drive, Irvine, CA 92617, USA

Issued By: Bureau Veritas Consumer Products Services (H.K.) Ltd., Taoyuan Branch
Hsin Chu Laboratory

Lab Address: E-2, No.1, Li Hsin 1st Road, Hsinchu Science Park, Hsinchu City 300,
Taiwan R.O.C.

Test Location: E-2, No.1, Li Hsin 1st Road, Hsinchu Science Park, Hsinchu City 300,
Taiwan R.O.C.

**FCC Registration /
Designation Number:** 723255 / TW2022



This report is for your exclusive use. Any copying or replication of this report to or for any other person or entity, or use of our name or trademark, is permitted only with our prior written permission. This report sets forth our findings solely with respect to the test samples identified herein. The results set forth in this report are not indicative or representative of the quality or characteristics of the lot from which a test sample was taken or any similar or identical product unless specifically and expressly noted. Our report includes all of the tests requested by you and the results thereof based upon the information that you provided to us. You have 60 days from date of issuance of this report to notify us of any material error or omission caused by our negligence, provided, however, that such notice shall be in writing and shall specifically address the issue you wish to raise. A failure to raise such issue within the prescribed time shall constitute your unqualified acceptance of the completeness of this report, the tests conducted and the correctness of the report contents. Unless specific mention, the uncertainty of measurement has been explicitly taken into account to declare the compliance or non-compliance to the specification. The report must not be used by the client to claim product certification, approval, or endorsement by TAF or any government agencies.

Table of Contents

Release Control Record	4
1 Certificate of Conformity	5
2 Summary of Test Results	6
2.1 Measurement Uncertainty	6
2.2 Modification Record	6
3 General Information	7
3.1 General Description of EUT	7
3.2 Description of Test Modes	10
3.2.1 Test Mode Applicability and Tested Channel Detail	11
3.3 Duty Cycle of Test Signal	13
3.4 Description of Support Units	14
3.4.1 Configuration of System under Test	14
3.5 General Description of Applied Standard	15
4 Test Types and Results	16
4.1 Radiated Emission and Bandedge Measurement	16
4.1.1 Limits of Radiated Emission and Bandedge Measurement	16
4.1.2 Test Instruments	17
4.1.3 Test Procedure	19
4.1.4 Deviation from Test Standard	19
4.1.5 Test Setup	20
4.1.6 EUT Operating Condition	21
4.1.7 Test Results	22
4.2 Conducted Emission Measurement	41
4.2.1 Limits of Conducted Emission Measurement	41
4.2.2 Test Instruments	41
4.2.3 Test Procedure	42
4.2.4 Deviation from Test Standard	42
4.2.5 Test Setup	42
4.2.6 EUT Operating Condition	42
4.2.7 Test Results (Mode 1)	43
4.2.8 Test Results (Mode 2)	45
4.2.9 Test Results (Mode 3)	47
4.2.10 Test Results (Mode 4)	49
4.3 Transmit Power Measurement	51
4.3.1 Limits of Transmit Power Measurement	51
4.3.2 Test Setup	51
4.3.3 Test Instruments	51
4.3.4 Test Procedure	51
4.3.5 Deviation from Test Standard	51
4.3.6 EUT Operating Condition	51
4.3.7 Test Result	52
4.4 Occupied Bandwidth Measurement	57
4.4.1 Test Setup	57
4.4.2 Test Instruments	57
4.4.3 Test Procedure	57
4.4.4 Test Results	58
4.5 Peak Power Spectral Density Measurement	66
4.5.1 Limits of Peak Power Spectral Density Measurement	66
4.5.2 Test Setup	66
4.5.3 Test Instruments	66
4.5.4 Test Procedure	67
4.5.5 Deviation from Test Standard	67
4.5.6 EUT Operating Condition	67

4.5.7 Test Results	68
4.6 Frequency Stability Measurement.....	74
4.6.1 Limits of Frequency Stability Measurement	74
4.6.2 Test Setup.....	74
4.6.3 Test Instruments	74
4.6.4 Test Procedure	74
4.6.5 Deviation from Test Standard	74
4.6.6 EUT Operating Condition	74
4.6.7 Test Results	75
4.7 6dB Bandwidth Measurement	77
4.7.1 Limits of 6dB Bandwidth Measurement.....	77
4.7.2 Test Setup.....	77
4.7.3 Test Instruments	77
4.7.4 Test Procedure	77
4.7.5 Deviation from Test Standard	77
4.7.6 EUT Operating Condition	77
4.7.7 Test Results	78
5 Pictures of Test Arrangements.....	80
Annex A- Radiated Out of Band Emission (OOBE) Measurement (For U-NII-3 band)	81
Appendix – Information on the Testing Laboratories	84

Release Control Record

Issue No.	Description	Date Issued
RF171208E04-1	Original release.	Feb. 13, 2018

1 Certificate of Conformity

Product: WHOLE HOME WI-FI

Brand: Linksys

Test Model: WHW03 V2

Series Model: A03 V2

Sample Status: ENGINEERING SAMPLE

Applicant: Linksys LLC

Test Date: Dec. 20, 2017 to Feb. 05, 2018

Standard: 47 CFR FCC Part 15, Subpart E (Section 15.407)
ANSI C63.10: 2013

The above equipment has been tested by **Bureau Veritas Consumer Products Services (H.K.) Ltd., Taoyuan Branch**, and found compliance with the requirement of the above standards. The test record, data evaluation & Equipment Under Test (EUT) configurations represented herein are true and accurate accounts of the measurements of the sample's EMC characteristics under the conditions specified in this report.

Prepared by : Wendy Wu , **Date:** Feb. 13, 2018
Wendy Wu / Specialist

Approved by : May Chen , **Date:** Feb. 13, 2018
May Chen / Manager

2 Summary of Test Results

47 CFR FCC Part 15, Subpart E (Section 15.407)			
FCC Clause	Test Item	Result	Remarks
15.407(b)(6)	AC Power Conducted Emissions	Pass	Meet the requirement of limit. Minimum passing margin is -5.4dB at 0.43125MHz.
15.407(b)(1/2/3/4(i/ii)/6)	Radiated Emissions & Band Edge Measurement*	Pass	Meet the requirement of limit. Minimum passing margin is -0.1dB at 5150.00MHz.
15.407(a)(1/2/3)	Max Average Transmit Power	Pass	Meet the requirement of limit.
---	Occupied Bandwidth Measurement	-	Reference only.
15.407(a)(1/2/3)	Peak Power Spectral Density	Pass	Meet the requirement of limit.
15.407(e)	6dB bandwidth	Pass	Meet the requirement of limit. (U-NII-3 Band only)
15.407(g)	Frequency Stability	Pass	Meet the requirement of limit.
15.203	Antenna Requirement	Pass	Antenna connector is i-pex(MHF) not a standard connector.

*For U-NII-3 band compliance with rule part 15.407(b)(4)(i), the OOB test plots were recorded in Annex A.

2.1 Measurement Uncertainty

Where relevant, the following measurement uncertainty levels have been estimated for tests performed on the EUT as specified in CISPR 16-4-2:

Measurement	Frequency	Expanded Uncertainty (k=2) (±)
Conducted Emissions at mains ports	150kHz ~ 30MHz	1.84 dB
Radiated Emissions up to 1 GHz	30MHz ~ 1GHz	5.30 dB
Radiated Emissions above 1 GHz	1GHz ~ 6GHz	5.16 dB
	6GHz ~ 18GHz	4.91 dB
	18GHz ~ 40GHz	5.30 dB

2.2 Modification Record

There were no modifications required for compliance.

3 General Information

3.1 General Description of EUT

Product	WHOLE HOME WI-FI
Brand	Linksys
Test Model	WHW03 V2
Series Model	A03 V2
Status of EUT	ENGINEERING SAMPLE
Driver version	WNC_VELOP_V2_20180206_V0.9
Power Supply Rating	12Vdc from power adapter
Modulation Type	CCK, DQPSK, DBPSK for DSSS 64QAM, 16QAM, QPSK, BPSK for OFDM 256QAM for OFDM in 11ac mode and VHT (20/40) mode in 2.4GHz
Modulation Technology	DSSS, OFDM
Transfer Rate	802.11b: up to 11Mbps 802.11a/g: up to 54Mbps 802.11n: up to 300Mbps 802.11ac: up to 866.7Mbps
Operating Frequency	2.4GHz: 2.412 ~ 2.462GHz 5GHz: 5.18~ 5.24GHz, 5.745 ~ 5.825GHz
Number of Channel	2.4GHz: 802.11b, 802.11g, 802.11n (HT20), VHT20: 11 802.11n (HT40), VHT40: 7 5GHz: 802.11a, 802.11n (HT20), 802.11ac (VHT20): 9 802.11n (HT40), 802.11ac (VHT40): 4 802.11ac (VHT80): 2
Output Power	2.4GHz: CDD Mode: 813.837mW Beamforming Mode: 790.263mW 5GHz: CDD Mode: 5.18 ~ 5.24GHz: 729.665mW 5.745 ~ 5.825GHz: 993.777mW Beamforming Mode: 5.18 ~ 5.24GHz: 729.665mW 5.745 ~ 5.825GHz: 843.554mW
Antenna Type	Refer to Note
Antenna Connector	Refer to Note
Accessory Device	Adapter x 1
Data Cable Supplied	NA

Note:

1. There are WLAN, Bluetooth and Zigbee technology used for the EUT. The EUT has below radios as following table:

Radio 1	Radio 2	Radio 3	Radio 4
WLAN 2.4GHz + 5GHz (low band)	WLAN 5GHz (high band)	Bluetooth	Zigbee

2. The EUT has below model names, which are identical to each other in all aspects except for the following table:

Brand	Model Name	Different
Linksys	WHW03 V2	For marketing request
	A03 V2	

From the above models, model: **WHW03 V2** was selected as representative model for the test and its data was recorded in this report.

3. Simultaneously transmission condition.

Condition	Technology				
1	WLAN 2.4GHz	WLAN 5GHz (low band)	WLAN 5GHz (high band)	Bluetooth	Zigbee

Note: The emission of the simultaneous operation has been evaluated and no non-compliance was found.

4. The EUT must be supplied with a power adapter and following different models could be chosen as following table:

No.	Brand	Model No.	Spec.	Plug
1	LEI	IU24-6120200-WP	Input: 100-240Vac, 0.7A, 50-60Hz Output: 12Vdc, 2A DC output cable (Unshielded, 1.8m)	Universal
2	LEI	MU24A6120200-A1	Input: 100-240Vac, 0.7A, 50-60Hz Output: 12Vdc, 2A DC output cable (Unshielded, 1.8m)	FCC
3	Ktec	KSA-24H-120200D5	Input: 100-240Vac, 0.7A, 50-60Hz Output: 12Vdc, 2A DC output cable (Unshielded, 1.8m)	Universal
4	Ktec	KSA-24H-120200HU	Input: 100-240Vac, 0.7A, 50-60Hz Output: 12Vdc, 2A DC output cable (Unshielded, 1.8m)	FCC

Note: From the above models, the worst radiated emission test was found in **Adapter 1**. Therefore only the test data of the modes were recorded in this report.

5. The DDR3 Memory of EUT as following table

Item	Brand	Model No.	Different
Main source	SK HYNIX	H5TC4G63CFR-PBA	1. For marketing request. 2. DDR3 Memory.
Second source	NANYA	NT5CC256M16EP-EK	

Note: From the above models, the worst case was found in **Main source**. Therefore only the test data of the modes were recorded in this report.

6. The antennas provided to the EUT, please refer to the following table:

Bluetooth						
Ant No.	Brand	Model	Antenna Gain (dBi)	Frequency rang (GHz)	Antenna type	Connector type
1	Aristotle	RFA-BT-9267	1.69	2.4~2.4835	Dipole	i-pex(MHF)
Zigbee						
Ant No.	Brand	Model	Antenna Gain (dBi)	Frequency rang (GHz)	Antenna type	Connector type
1	Aristotle	RFA-ZB-9267	0.85	2.4~2.4835	Dipole	i-pex(MHF)
WLAN						
Ant No.	Brand	Model	Antenna Gain (dBi)	Frequency rang (GHz)	Antenna type	Connector type
1	Aristotle	RFA-05-9267-L	3.55	5.5~5.825	Dipole	i-pex(MHF)
2	Aristotle	RFA-05-9267-R	3.87	5.5~5.825	Dipole	i-pex(MHF)
3	Aristotle	RFA-25-9267-B-V2	3.12	2.4~2.4835	Dipole	i-pex(MHF)
			3.77	5.18~5.320		
4	Aristotle	RFA-25-9267-F-V2	3.26	2.4~2.4835	Dipole	i-pex(MHF)
			3.68	5.18~5.320		

7. The EUT incorporates a MIMO function.

2.4GHz Band			
MODULATION MODE	DATA RATE (MCS)	TX & RX CONFIGURATION	
802.11b	1 ~ 11Mbps	2TX	2RX
802.11g	6 ~ 54Mbps	2TX	2RX
802.11n (HT20)	MCS 0~7	2TX	2RX
	MCS 8~15	2TX	2RX
802.11n (HT40)	MCS 0~7	2TX	2RX
	MCS 8~15	2TX	2RX
VHT20	MCS0~8 Nss=1	2TX	2RX
	MCS0~8 Nss=2	2TX	2RX
VHT40	MCS0~9 Nss=1	2TX	2RX
	MCS0~9 Nss=2	2TX	2RX
5GHz Band			
MODULATION MODE	DATA RATE (MCS)	TX & RX CONFIGURATION	
802.11a	6 ~ 54Mbps	2TX	2RX
802.11n (HT20)	MCS 0~7	2TX	2RX
	MCS 8~15	2TX	2RX
802.11n (HT40)	MCS 0~7	2TX	2RX
	MCS 8~15	2TX	2RX
802.11ac (VHT20)	MCS0~8 Nss=1	2TX	2RX
	MCS0~8 Nss=2	2TX	2RX
802.11ac (VHT40)	MCS0~9 Nss=1	2TX	2RX
	MCS0~9 Nss=2	2TX	2RX
802.11ac (VHT80)	MCS0~9 Nss=1	2TX	2RX
	MCS0~9 Nss=2	2TX	2RX

Note:

- All of modulation mode support beamforming function except 802.11b modulation mode.
- The modulation and bandwidth are similar for 802.11n mode for 20MHz (40MHz) and 802.11ac mode for 20MHz (40MHz), therefore investigated worst case to representative mode in test report. (Final test mode refer section 3.2.1)

8. The above EUT information is declared by manufacturer and for more detailed features description, please refer to the manufacturer's specifications or user's manual.

3.2 Description of Test Modes

FOR 5180 ~ 5240MHz

4 channels are provided for 802.11a, 802.11n (HT20), 802.11ac (VHT20):

Channel	Frequency	Channel	Frequency
36	5180MHz	44	5220MHz
40	5200MHz	48	5240MHz

2 channels are provided for 802.11n (HT40), 802.11ac (VHT40):

Channel	Frequency	Channel	Frequency
38	5190MHz	46	5230MHz

1 channel is provided for 802.11ac (VHT80):

Channel	Frequency
42	5210MHz

FOR 5745 ~ 5825MHz:

5 channels are provided for 802.11a, 802.11n (HT20), 802.11ac (VHT20):

Channel	Frequency	Channel	Frequency
149	5745MHz	161	5805MHz
153	5765MHz	165	5825MHz
157	5785MHz		

2 channels are provided for 802.11n (HT40), 802.11ac (VHT40):

Channel	Frequency	Channel	Frequency
151	5755MHz	159	5795MHz

1 channel is provided for 802.11ac (VHT80):

Channel	Frequency
155	5775MHz

3.2.1 Test Mode Applicability and Tested Channel Detail

EUT Configure Mode	Applicable To				Description
	RE \geq 1G	RE<1G	PLC	APCM	
1	√	√	√	√	Power from Adapter 1
2	-	-	√	-	Power from Adapter 2
3	-	-	√	-	Power from Adapter 3
4	-	-	√	-	Power from Adapter 4

Where **RE \geq 1G**: Radiated Emission above 1GHz **RE<1G**: Radiated Emission below 1GHz
PLC: Power Line Conducted Emission **APCM**: Antenna Port Conducted Measurement

Radiated Emission Test (Above 1GHz):

- Pre-Scan has been conducted to determine the worst-case mode from all possible combinations between available modulations, data rates and antenna ports (if EUT with antenna diversity architecture).
- Following channel(s) was (were) selected for the final test as listed below.

CDD Mode						
Mode	FREQ. Band (MHz)	Available Channel	Tested Channel	Modulation Technology	Modulation Type	Data Rate (Mbps)
802.11a	5180-5240	36 to 48	36, 40, 48	OFDM	BPSK	6
802.11ac (VHT20)		36 to 48	36, 40, 48	OFDM	BPSK	6.5
802.11ac (VHT40)		38 to 46	38, 46	OFDM	BPSK	13.5
802.11ac (VHT80)		42	42	OFDM	BPSK	29.3
802.11a	5745-5825	149 to 165	149, 157, 165	OFDM	BPSK	6
802.11ac (VHT20)		149 to 165	149, 157, 165	OFDM	BPSK	6.5
802.11ac (VHT40)		151 to 159	151, 159	OFDM	BPSK	13.5
802.11ac (VHT80)		155	155	OFDM	BPSK	29.3

Radiated Emission Test (Below 1GHz):

- Pre-Scan has been conducted to determine the worst-case mode from all possible combinations between available modulations, data rates and antenna ports (if EUT with antenna diversity architecture).
- Following channel(s) was (were) selected for the final test as listed below.

CDD Mode						
Mode	FREQ. Band (MHz)	Available Channel	Tested Channel	Modulation Technology	Modulation Type	Data Rate (Mbps)
802.11ac (VHT40)	5180-5320 5745-5825	38 to 46 151 to 159	159	OFDM	BPSK	13.5

Power Line Conducted Emission Test:

- Pre-Scan has been conducted to determine the worst-case mode from all possible combinations between available modulations, data rates and antenna ports (if EUT with antenna diversity architecture).
- Following channel(s) was (were) selected for the final test as listed below.

CDD Mode						
Mode	FREQ. Band (MHz)	Available Channel	Tested Channel	Modulation Technology	Modulation Type	Data Rate (Mbps)
802.11ac (VHT40)	5180-5320 5745-5825	38 to 46 151 to 159	159	OFDM	BPSK	13.5

Antenna Port Conducted Measurement:

- This item includes all test value of each mode, but only includes spectrum plot of worst value of each mode.
- Pre-Scan has been conducted to determine the worst-case mode from all possible combinations between available modulations, data rates and antenna ports (if EUT with antenna diversity architecture).
- Following channel(s) was (were) selected for the final test as listed below.

CDD Mode / Beamforming Mode (output power only)						
Mode	FREQ. Band (MHz)	Available Channel	Tested Channel	Modulation Technology	Modulation Type	Data Rate (Mbps)
802.11a	5180-5240	36 to 48	36, 40, 48	OFDM	BPSK	6
802.11ac (VHT20)		36 to 48	36, 40, 48	OFDM	BPSK	6.5
802.11ac (VHT40)		38 to 46	38, 46	OFDM	BPSK	13.5
802.11ac (VHT80)		42	42	OFDM	BPSK	29.3
802.11a	5745-5825	149 to 165	149, 157, 165	OFDM	BPSK	6
802.11ac (VHT20)		149 to 165	149, 157, 165	OFDM	BPSK	6.5
802.11ac (VHT40)		151 to 159	151, 159	OFDM	BPSK	13.5
802.11ac (VHT80)		155	155	OFDM	BPSK	29.3

Test Condition:

Applicable To	Environmental Conditions	Input Power	Tested By
RE \geq 1G	21deg. C, 65%RH	120Vac, 60Hz	Frank Chuang
RE $<$ 1G	22deg. C, 67%RH	120Vac, 60Hz	Steven Chiang
PLC	24deg. C, 73%RH	120Vac, 60Hz	Andy Ho
APCM	25deg. C, 65%RH	120Vac, 60Hz	Robert Cheng

3.3 Duty Cycle of Test Signal

If duty cycle of test signal is $\geq 98\%$, duty factor is not required.

If duty cycle of test signal is $< 98\%$, duty factor shall be considered.

802.11a: Duty cycle = $2.027 \text{ ms} / 2.105 \text{ ms} = 0.963$, Duty factor = $10 * \log(1/0.963) = 0.16$

802.11ac (VHT20): Duty cycle = $4.967 \text{ ms} / 5.052 \text{ ms} = 0.983$

802.11ac (VHT40): Duty cycle = $2.413 \text{ ms} / 2.502 \text{ ms} = 0.964$, Duty factor = $10 * \log(1/0.964) = 0.16$

802.11ac (VHT80): Duty cycle = $1.135 \text{ ms} / 1.211 \text{ ms} = 0.937$, Duty factor = $10 * \log(1/0.937) = 0.28$

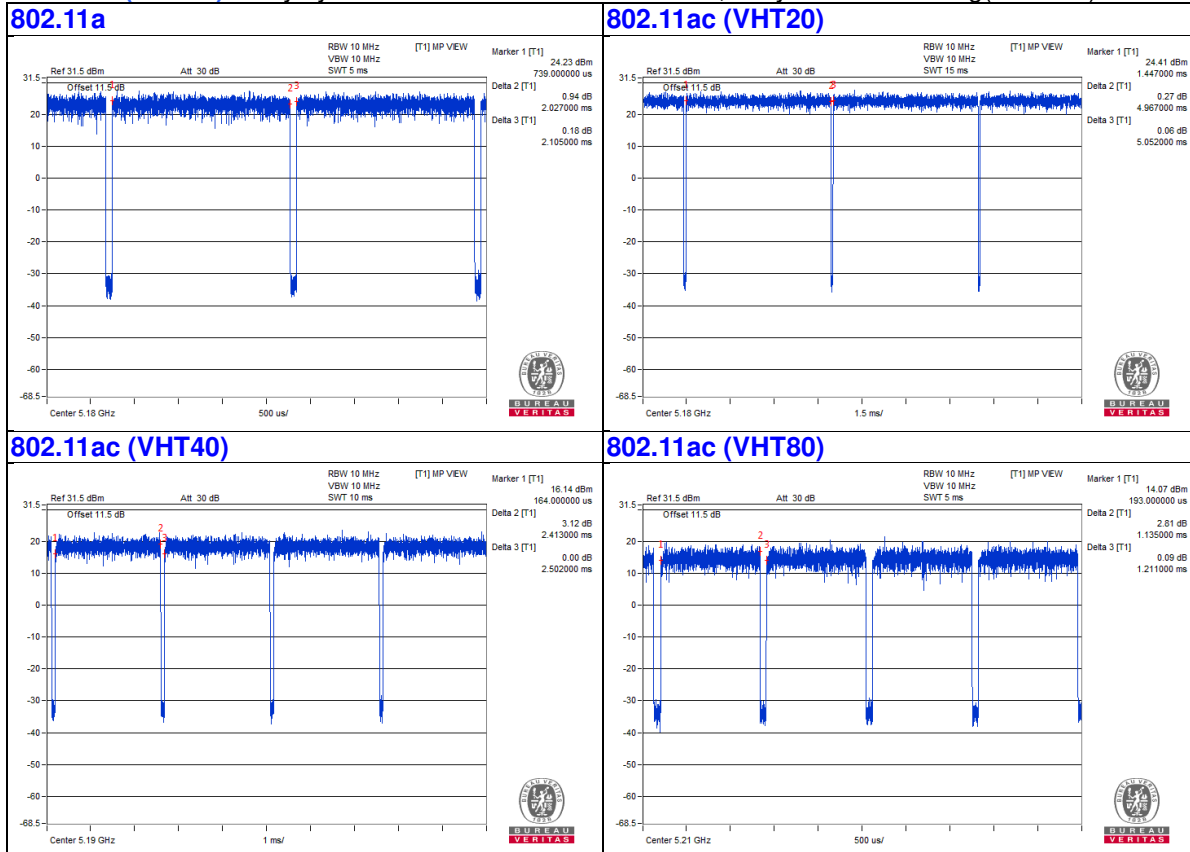

3.4 Description of Support Units

The EUT has been tested as an independent unit together with other necessary accessories or support units. The following support units or accessories were used to form a representative test configuration during the tests.

ID	Product	Brand	Model No.	Serial No.	FCC ID	Remarks
A.	Laptop	DELL	E6420	B92T3R1	FCC DoC	Provided by Lab
B.	Laptop	DELL	E6420	482T3R1	FCC DoC	Provided by Lab

Note:

1. All power cords of the above support units are non-shielded (1.8m).

ID	Descriptions	Qty.	Length (m)	Shielding (Yes/No)	Cores (Qty.)	Remarks
1.	RJ-45 Cable	1	10	No	0	Provided by Lab
2.	RJ-45 Cable	1	10	No	0	Provided by Lab
3.	DC Cable	1	1.8	No	0	Supplied by client

Note: The core(s) is(are) originally attached to the cable(s).

3.4.1 Configuration of System under Test

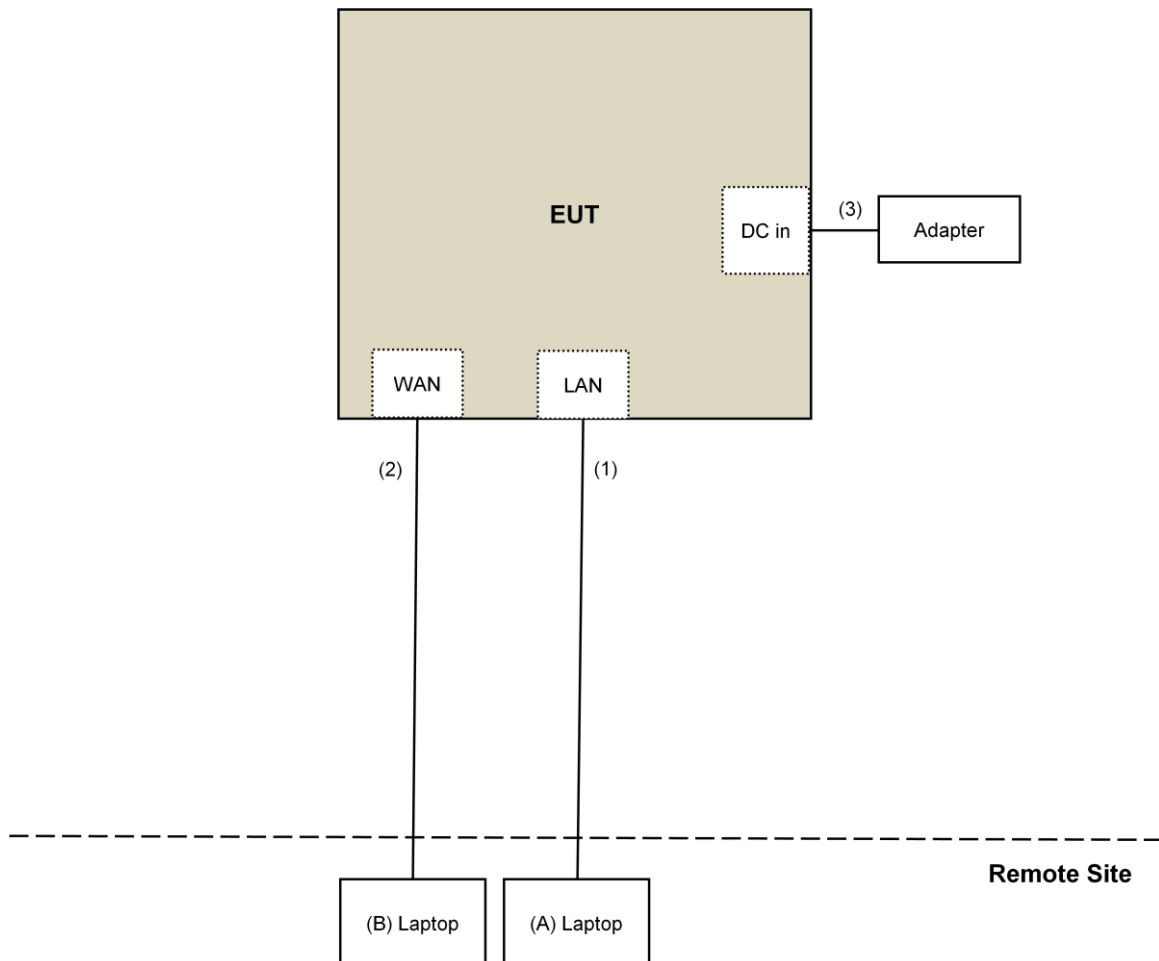

3.5 General Description of Applied Standard

The EUT is a RF Product. According to the specifications of the manufacturer, it must comply with the requirements of the following standards:

FCC Part 15, Subpart E (15.407)
KDB 789033 D02 General UNII Test Procedure New Rules v02r01
KDB 662911 D01 Multiple Transmitter Output v02r01
ANSI C63.10-2013

All test items have been performed and recorded as per the above standards.

NOTE: The EUT has been verified to comply with the requirements of FCC Part 15, Subpart B, Class B (DoC). The test report has been issued separately.

4 Test Types and Results

4.1 Radiated Emission and Bandedge Measurement

4.1.1 Limits of Radiated Emission and Bandedge Measurement

Radiated emissions which fall in the restricted bands must comply with the radiated emission limits specified as below table.

Frequencies (MHz)	Field Strength (microvolts/meter)	Measurement Distance (meters)
0.009 ~ 0.490	2400/F(kHz)	300
0.490 ~ 1.705	24000/F(kHz)	30
1.705 ~ 30.0	30	30
30 ~ 88	100	3
88 ~ 216	150	3
216 ~ 960	200	3
Above 960	500	3

NOTE:

1. The lower limit shall apply at the transition frequencies.
2. Emission level (dBuV/m) = 20 log Emission level (uV/m).
3. For frequencies above 1000MHz, the field strength limits are based on average detector, however, the peak field strength of any emission shall not exceed the maximum permitted average limits, specified above by more than 20dB under any condition of modulation.

Limits of unwanted emission out of the restricted bands

Applicable To		Limit	
789033 D02 General UNII Test Procedure New Rules v02r01		Field Strength at 3m	
		PK:74 (dBμV/m)	AV:54 (dBμV/m)
Frequency Band	Applicable To	EIRP Limit	Equivalent Field Strength at 3m
5150~5250 MHz	15.407(b)(1)	PK:-27 (dBm/MHz)	PK:68.2(dBμV/m)
5250~5350 MHz	15.407(b)(2)		
5470~5725 MHz	15.407(b)(3)		
5725~5850 MHz	<input checked="" type="checkbox"/> 15.407(b)(4)(i)	PK:-27 (dBm/MHz) ^{*1} PK:10 (dBm/MHz) ^{*2} PK:15.6 (dBm/MHz) ^{*3} PK:27 (dBm/MHz) ^{*4}	PK: 68.2(dBμV/m) ^{*1} PK:105.2 (dBμV/m) ^{*2} PK: 110.8(dBμV/m) ^{*3} PK:122.2 (dBμV/m) ^{*4}
	<input type="checkbox"/> 15.407(b)(4)(ii)	Emission limits in section 15.247(d)	
^{*1} beyond 75 MHz or more above of the band edge.		^{*2} below the band edge increasing linearly to 10 dBm/MHz at 25 MHz above.	
^{*3} below the band edge increasing linearly to a level of 15.6 dBm/MHz at 5 MHz above.		^{*4} from 5 MHz above or below the band edge increasing linearly to a level of 27 dBm/MHz at the band edge.	

Note:

The following formula is used to convert the equipment isotropic radiated power (eirp) to field strength:

$$E = \frac{1000000\sqrt{30P}}{3} \mu\text{V/m, where } P \text{ is the eirp (Watts).}$$

4.1.2 Test Instruments

For Radiated Emission below 1GHz and above 1GHz of 802.11ac (VHT40) CH38, 802.11ac (VHT80) CH42:

DESCRIPTION & MANUFACTURER	MODEL NO.	SERIAL NO.	CALIBRATED DATE	CALIBRATED UNTIL
Test Receiver Keysight	N9038A	MY54450088	July 08, 2017	July 07, 2018
Pre-Amplifier ^(*) EMCI	EMC001340	980142	Jan. 20, 2016	Jan. 19, 2018
Loop Antenna ^(*) Electro-Metrics	EM-6879	264	Dec. 16, 2016	Dec. 15, 2018
RF Cable	NA	LOOPCAB-001 LOOPCAB-002	Jan. 17, 2017	Jan. 16, 2018
Pre-Amplifier Mini-Circuits	ZFL-1000VH2B	AMP-ZFL-01	Nov. 09, 2017	Nov. 08, 2018
Trilog Broadband Antenna SCHWARZBECK	VULB 9168	9168-406	Nov. 29, 2017	Nov. 28, 2018
RF Cable	8D	966-4-1 966-4-2 966-4-3	Apr. 01, 2017	Mar. 31, 2018
Fixed attenuator Mini-Circuits	UNAT-5+	PAD-3m-4-01	Oct. 03, 2017	Oct. 02, 2018
Horn_Antenna SCHWARZBECK	BBHA 9120D	9120D-783	Dec. 12, 2017	Dec. 11, 2018
Pre-Amplifier EMCI	EMC12630SE	980385	Feb. 02, 2017	Feb. 01, 2018
RF Cable	EMC104-SM-SM-1200 EMC104-SM-SM-2000 EMC104-SM-SM-5000	160923 150318 150321	Feb. 02, 2017 Mar. 29, 2017 Mar. 29, 2017	Feb. 01, 2018 Mar. 28, 2018 Mar. 28, 2018
Pre-Amplifier EMCI	EMC184045SE	980387	Feb. 02, 2017	Feb. 01, 2018
Horn_Antenna SCHWARZBECK	BBHA 9170	BBHA9170608	Dec. 14, 2017	Dec. 13, 2018
RF Cable	SUCOFLEX 102	36432/2 36433/2	Jan. 15, 2017	Jan. 14, 2018
Software	ADT_Radiated_V8.7.08	NA	NA	NA
Antenna Tower & Turn Table Max-Full	MF-7802	MF780208410	NA	NA
Boresight Antenna Fixture	FBA-01	FBA-SIP02	NA	NA

Note:

1. The calibration interval of the above test instruments is 12 months and the calibrations are traceable to NML/ROC and NIST/USA.
2. *The calibration interval of the above test instruments is 24 months and the calibrations are traceable to NML/ROC and NIST/USA.
3. The test was performed in 966 Chamber No. 4.
4. The CANADA Site Registration No. is 20331-2
5. Loop antenna was used for all emissions below 30 MHz.
6. Tested Date: Dec. 20, 2017 to Jan. 04, 2018

For Other test items:

DESCRIPTION & MANUFACTURER	MODEL NO.	SERIAL NO.	CALIBRATED DATE	CALIBRATED UNTIL
Test Receiver Keysight	N9038A	MY54450088	July 08, 2017	July 07, 2018
Horn_Antenna SCHWARZBECK	BBHA 9120D	9120D-783	Dec. 12, 2017	Dec. 11, 2018
Pre-Amplifier EMCI	EMC12630SE	980385	Jan. 29, 2018	Jan. 28, 2019
RF Cable	EMC104-SM- SM-1200 EMC104-SM- SM-2000 EMC104-SM- SM-5000	160923 150318 150321	Jan. 29, 2018 Jan. 29, 2018 Jan. 29, 2018	Jan. 28, 2019 Jan. 28, 2019 Jan. 28, 2019
Pre-Amplifier EMCI	EMC184045S E	980387	Jan. 29, 2018	Jan. 28, 2019
Horn_Antenna SCHWARZBECK	BBHA 9170	BBHA9170608	Dec. 14, 2017	Dec. 13, 2018
RF Cable	EMC102-KM- KM-1200	160925	Jan. 29, 2018	Jan. 28, 2019
Software	ADT_Radiated _V8.7.08	NA	NA	NA
Antenna Tower & Turn Table Max-Full	MF-7802	MF780208410	NA	NA
Boresight Antenna Fixture	FBA-01	FBA-SIP02	NA	NA
Spectrum Analyzer R&S	FSV40	100964	July 01, 2017	June 30, 2018
Power meter Anritsu	ML2495A	1014008	May 11, 2017	May 10, 2018
Power sensor Anritsu	MA2411B	0917122	May 11, 2017	May 10, 2018
AC Power Source Extech Electronics	6205	1440452	NA	NA
Temperature & Humidity Chamber Giant Force	GTH-150-40-S P-AR	MAA0812-008	Jan. 10, 2018	Jan. 09, 2019
True RMS Clamp Meter FLUKE	325	31130711WS	May 29, 2017	May 28, 2018

Note:

1. The calibration interval of the above test instruments is 12 months and the calibrations are traceable to NML/ROC and NIST/USA.
2. The test was performed in 966 Chamber No. 4.
3. The CANADA Site Registration No. is 20331-2
4. Tested Date: Jan. 29 to Feb. 02, 2018

4.1.3 Test Procedure

For Radiated emission below 30MHz

- a. The EUT was placed on the top of a rotating table 0.8 meters above the ground at a 3 meter chamber room. The table was rotated 360 degrees to determine the position of the highest radiation.
- b. The EUT was set 3 meters away from the interference-receiving antenna, which was mounted on the top of a variable-height antenna tower.
- c. Both X and Y axes of the antenna are set to make the measurement.
- d. For each suspected emission, the EUT was arranged to its worst case and the rotatable table was turned from 0 degrees to 360 degrees to find the maximum reading.
- e. The test-receiver system was set to Quasi-Peak Detect Function and Specified Bandwidth with Maximum Hold Mode.

NOTE:

1. The resolution bandwidth and video bandwidth of test receiver/spectrum analyzer is 9kHz at frequency below 30MHz.

For Radiated emission above 30MHz

- a. The EUT was placed on the top of a rotating table 0.8 meters (for 30MHz ~ 1GHz) / 1.5 meters (for above 1GHz) above the ground at 3 meter chamber room for test. The table was rotated 360 degrees to determine the position of the highest radiation.
- b. The EUT was set 3 meters away from the interference-receiving antenna, which was mounted on the top of a variable-height antenna tower.
- c. The height of antenna is varied from one meter to four meters above the ground to determine the maximum value of the field strength. Both horizontal and vertical polarizations of the antenna are set to make the measurement.
- d. For each suspected emission, the EUT was arranged to its worst case and then the antenna was tuned to heights from 1 meter to 4 meters and the rotatable table was turned from 0 degrees to 360 degrees to find the maximum reading.
- e. The test-receiver system was set to quasi-peak detect function and specified bandwidth with maximum hold mode when the test frequency is below 1 GHz.
- f. The test-receiver system was set to peak and average detects function and specified bandwidth with maximum hold mode when the test frequency is above 1 GHz. If the peak reading value also meets average limit, measurement with the average detector is unnecessary.

Note:

1. The resolution bandwidth and video bandwidth of test receiver/spectrum analyzer is 120kHz for Quasi-peak detection (QP) at frequency below 1GHz.
2. The resolution bandwidth of test receiver/spectrum analyzer is 1 MHz and the video bandwidth is 3 MHz for Peak detection (PK) at frequency above 1GHz.
3. The resolution bandwidth of test receiver/spectrum analyzer is 1MHz and the video bandwidth is $\geq 1/T$ (Duty cycle < 98%) or 10Hz (Duty cycle $\geq 98\%$) for Average detection (AV) at frequency above 1GHz.
4. All modes of operation were investigated and the worst-case emissions are reported.

4.1.4 Deviation from Test Standard

No deviation.

4.1.5 Test Setup

For Radiated emission below 30MHz

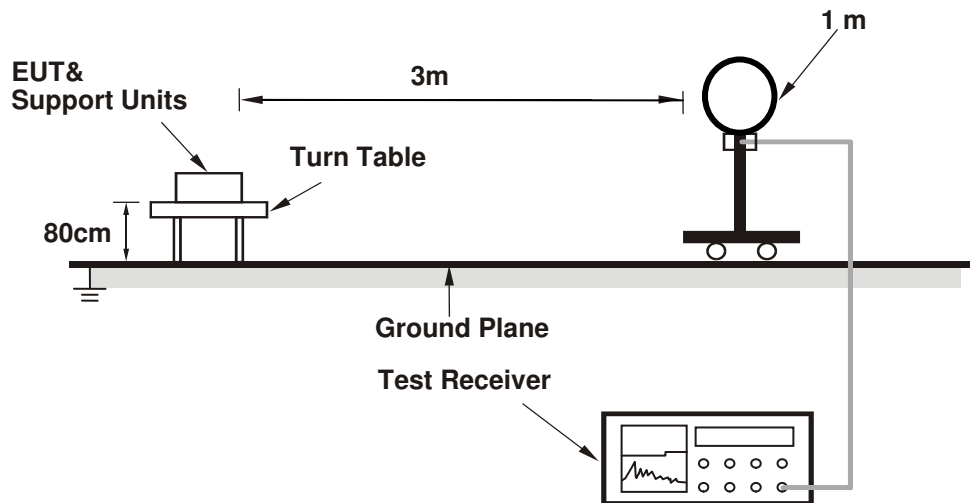

For Radiated emission 30MHz to 1GHz

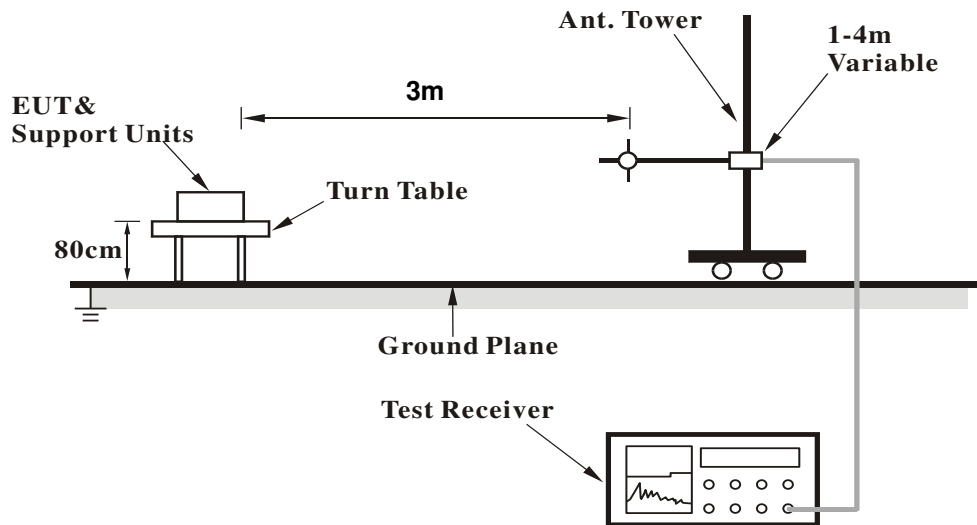

For Radiated emission above 1GHz

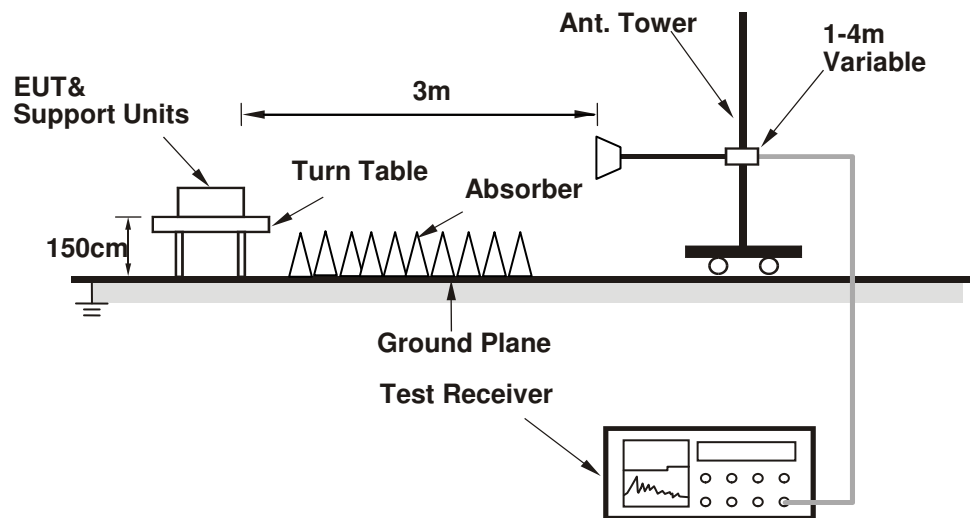

For the actual test configuration, please refer to the attached file (Test Setup Photo).

4.1.6 EUT Operating Condition

- a. Connected the EUT with the Laptop which is placed on remote site.
- b. Controlling software (QDART_1.0.38) has been activated to set the EUT on specific status.

4.1.7 Test Results

Above 1GHz Data:

802.11a

CHANNEL	TX Channel 36	DETECTOR FUNCTION	Peak (PK)
FREQUENCY RANGE	1GHz ~ 40GHz		Average (AV)

ANTENNA POLARITY & TEST DISTANCE: HORIZONTAL AT 3 M

NO.	FREQ. (MHz)	EMISSION LEVEL (dBuV/m)	LIMIT (dBuV/m)	MARGIN (dB)	ANTENNA HEIGHT (m)	TABLE ANGLE (Degree)	RAW VALUE (dBuV)	CORRECTION FACTOR (dB/m)
1	5150.00	65.2 PK	74.0	-8.8	1.03 H	69	60.9	4.3
2	5150.00	52.6 AV	54.0	-1.4	1.03 H	69	48.3	4.3
3	*5180.00	114.2 PK			1.03 H	69	110.1	4.1
4	*5180.00	102.0 AV			1.03 H	69	97.9	4.1
5	#10360.00	50.2 PK	74.0	-23.8	1.70 H	209	36.9	13.3
6	#10360.00	37.2 AV	54.0	-16.8	1.70 H	209	23.9	13.3
7	15540.00	48.3 PK	74.0	-25.7	1.46 H	170	35.4	12.9
8	15540.00	34.5 AV	54.0	-19.5	1.46 H	170	21.6	12.9

ANTENNA POLARITY & TEST DISTANCE: VERTICAL AT 3 M

NO.	FREQ. (MHz)	EMISSION LEVEL (dBuV/m)	LIMIT (dBuV/m)	MARGIN (dB)	ANTENNA HEIGHT (m)	TABLE ANGLE (Degree)	RAW VALUE (dBuV)	CORRECTION FACTOR (dB/m)
1	5150.00	67.7 PK	74.0	-6.3	1.53 V	185	63.4	4.3
2	5150.00	53.9 AV	54.0	-0.1	1.53 V	185	49.6	4.3
3	*5180.00	116.8 PK			1.53 V	185	112.7	4.1
4	*5180.00	104.0 AV			1.53 V	185	99.9	4.1
5	#10360.00	46.1 PK	74.0	-27.9	1.68 V	331	32.8	13.3
6	#10360.00	33.2 AV	54.0	-20.8	1.68 V	331	19.9	13.3
7	15540.00	46.2 PK	74.0	-27.8	1.34 V	210	33.3	12.9
8	15540.00	33.1 AV	54.0	-20.9	1.34 V	210	20.2	12.9

REMARKS:

1. Emission Level(dBuV/m) = Raw Value(dBuV) + Correction Factor(dB/m)
2. Correction Factor(dB/m) = Antenna Factor(dB/m) + Cable Factor(dB) – Pre-Amplifier Factor(dB)
3. The other emission levels were very low against the limit.
4. Margin value = Emission Level – Limit value
5. " * ": Fundamental frequency.
6. " # ": The radiated frequency is out of the restricted band.

CHANNEL	TX Channel 40	DETECTOR FUNCTION	Peak (PK)
FREQUENCY RANGE	1GHz ~ 40GHz		Average (AV)

ANTENNA POLARITY & TEST DISTANCE: HORIZONTAL AT 3 M

NO.	FREQ. (MHz)	EMISSION LEVEL (dBuV/m)	LIMIT (dBuV/m)	MARGIN (dB)	ANTENNA HEIGHT (m)	TABLE ANGLE (Degree)	RAW VALUE (dBuV)	CORRECTION FACTOR (dB/m)
1	5150.00	60.1 PK	74.0	-13.9	1.89 H	277	55.8	4.3
2	5150.00	43.5 AV	54.0	-10.5	1.89 H	277	39.2	4.3
3	*5200.00	118.2 PK			1.89 H	277	114.2	4.0
4	*5200.00	106.2 AV			1.89 H	277	102.2	4.0
5	5350.00	53.8 PK	74.0	-20.2	1.89 H	277	49.8	4.0
6	5350.00	40.3 AV	54.0	-13.7	1.89 H	277	36.3	4.0
7	#10400.00	54.7 PK	74.0	-19.3	1.67 H	305	41.2	13.5
8	#10400.00	40.2 AV	54.0	-13.8	1.67 H	305	26.7	13.5
9	15600.00	56.5 PK	74.0	-17.5	1.55 H	184	43.4	13.1
10	15600.00	41.3 AV	54.0	-12.7	1.55 H	184	28.2	13.1

ANTENNA POLARITY & TEST DISTANCE: VERTICAL AT 3 M

NO.	FREQ. (MHz)	EMISSION LEVEL (dBuV/m)	LIMIT (dBuV/m)	MARGIN (dB)	ANTENNA HEIGHT (m)	TABLE ANGLE (Degree)	RAW VALUE (dBuV)	CORRECTION FACTOR (dB/m)
1	5150.00	64.2 PK	74.0	-9.8	1.80 V	145	59.9	4.3
2	5150.00	53.4 AV	54.0	-0.6	1.80 V	145	49.1	4.3
3	*5200.00	116.1 PK			1.80 V	145	112.1	4.0
4	*5200.00	104.0 AV			1.80 V	145	100.0	4.0
5	5350.00	58.1 PK	74.0	-15.9	1.80 V	145	54.1	4.0
6	5350.00	45.6 AV	54.0	-8.4	1.80 V	145	41.6	4.0
7	#10400.00	48.1 PK	74.0	-25.9	1.42 V	224	34.6	13.5
8	#10400.00	34.3 AV	54.0	-19.7	1.42 V	224	20.8	13.5
9	15600.00	49.9 PK	74.0	-24.1	1.48 V	189	36.8	13.1
10	15600.00	35.9 AV	54.0	-18.1	1.48 V	189	22.8	13.1

REMARKS:

1. Emission Level(dBuV/m) = Raw Value(dBuV) + Correction Factor(dB/m)
2. Correction Factor(dB/m) = Antenna Factor(dB/m) + Cable Factor(dB) – Pre-Amplifier Factor(dB)
3. The other emission levels were very low against the limit.
4. Margin value = Emission Level – Limit value
5. " * ": Fundamental frequency.
6. " # ": The radiated frequency is out of the restricted band.

CHANNEL	TX Channel 48	DETECTOR FUNCTION	Peak (PK)
FREQUENCY RANGE	1GHz ~ 40GHz		Average (AV)

ANTENNA POLARITY & TEST DISTANCE: HORIZONTAL AT 3 M

NO.	FREQ. (MHz)	EMISSION LEVEL (dBuV/m)	LIMIT (dBuV/m)	MARGIN (dB)	ANTENNA HEIGHT (m)	TABLE ANGLE (Degree)	RAW VALUE (dBuV)	CORRECTION FACTOR (dB/m)
1	*5240.00	115.0 PK			1.88 H	226	111.1	3.9
2	*5240.00	102.6 AV			1.88 H	226	98.7	3.9
3	5350.00	51.1 PK	74.0	-22.9	1.88 H	236	47.1	4.0
4	5350.00	39.2 AV	54.0	-14.8	1.88 H	236	35.2	4.0
5	#10480.00	56.4 PK	74.0	-17.6	1.52 H	317	42.4	14.0
6	#10480.00	40.9 AV	54.0	-13.1	1.52 H	317	26.9	14.0
7	15720.00	57.5 PK	74.0	-16.5	1.38 H	178	44.0	13.5
8	15720.00	41.6 AV	54.0	-12.4	1.38 H	178	28.1	13.5

ANTENNA POLARITY & TEST DISTANCE: VERTICAL AT 3 M

NO.	FREQ. (MHz)	EMISSION LEVEL (dBuV/m)	LIMIT (dBuV/m)	MARGIN (dB)	ANTENNA HEIGHT (m)	TABLE ANGLE (Degree)	RAW VALUE (dBuV)	CORRECTION FACTOR (dB/m)
1	*5240.00	117.8 PK			1.99 V	142	113.9	3.9
2	*5240.00	106.2 AV			1.99 V	142	102.3	3.9
3	5350.00	59.2 PK	74.0	-14.8	1.99 V	142	55.2	4.0
4	5350.00	44.2 AV	54.0	-9.8	1.99 V	142	40.2	4.0
5	#10480.00	48.3 PK	74.0	-25.7	1.24 V	223	34.3	14.0
6	#10480.00	34.6 AV	54.0	-19.4	1.24 V	223	20.6	14.0
7	15720.00	49.1 PK	74.0	-24.9	2.00 V	201	35.6	13.5
8	15720.00	35.2 AV	54.0	-18.8	2.00 V	201	21.7	13.5

REMARKS:

1. Emission Level(dBuV/m) = Raw Value(dBuV) + Correction Factor(dB/m)
2. Correction Factor(dB/m) = Antenna Factor(dB/m) + Cable Factor(dB) – Pre-Amplifier Factor(dB)
3. The other emission levels were very low against the limit.
4. Margin value = Emission Level – Limit value
5. " * ": Fundamental frequency.
6. " # ": The radiated frequency is out of the restricted band.

CHANNEL	TX Channel 149	DETECTOR FUNCTION	Peak (PK)
FREQUENCY RANGE	1GHz ~ 40GHz		Average (AV)

ANTENNA POLARITY & TEST DISTANCE: HORIZONTAL AT 3 M

NO.	FREQ. (MHz)	EMISSION LEVEL (dBuV/m)	LIMIT (dBuV/m)	MARGIN (dB)	ANTENNA HEIGHT (m)	TABLE ANGLE (Degree)	RAW VALUE (dBuV)	CORRECTION FACTOR (dB/m)
1	#5621.69	56.4 PK	68.2	-11.8	2.93 H	347	52.0	4.4
2	*5745.00	120.1 PK			2.93 H	347	115.5	4.6
3	*5745.00	107.6 AV			2.93 H	347	103.0	4.6
4	#5981.23	54.7 PK	68.2	-13.5	2.93 H	347	49.7	5.0
5	11490.00	51.7 PK	74.0	-22.3	1.71 H	53	37.6	14.1
6	11490.00	39.3 AV	54.0	-14.7	1.71 H	53	25.2	14.1
7	#17235.00	55.8 PK	74.0	-18.2	1.80 H	74	38.9	16.9
8	#17235.00	42.9 AV	54.0	-11.1	1.80 H	74	26.0	16.9

ANTENNA POLARITY & TEST DISTANCE: VERTICAL AT 3 M

NO.	FREQ. (MHz)	EMISSION LEVEL (dBuV/m)	LIMIT (dBuV/m)	MARGIN (dB)	ANTENNA HEIGHT (m)	TABLE ANGLE (Degree)	RAW VALUE (dBuV)	CORRECTION FACTOR (dB/m)
1	#5618.04	58.0 PK	68.2	-10.2	3.37 V	347	53.6	4.4
2	*5745.00	121.5 PK			3.37 V	347	116.9	4.6
3	*5745.00	109.8 AV			3.37 V	347	105.2	4.6
4	#6013.03	55.8 PK	68.2	-12.4	3.37 V	347	50.7	5.1
5	11490.00	51.1 PK	74.0	-22.9	2.26 V	347	37.0	14.1
6	11490.00	37.1 AV	54.0	-16.9	2.26 V	347	23.0	14.1
7	#17235.00	53.8 PK	74.0	-20.2	1.55 V	214	36.9	16.9
8	#17235.00	40.8 AV	54.0	-13.2	1.55 V	214	23.9	16.9

REMARKS:

1. Emission Level(dBuV/m) = Raw Value(dBuV) + Correction Factor(dB/m)
2. Correction Factor(dB/m) = Antenna Factor(dB/m) + Cable Factor(dB) – Pre-Amplifier Factor(dB)
3. The other emission levels were very low against the limit.
4. Margin value = Emission Level – Limit value
5. " * ": Fundamental frequency.
6. " # ": The radiated frequency is out of the restricted band.

CHANNEL	TX Channel 157	DETECTOR FUNCTION	Peak (PK)
FREQUENCY RANGE	1GHz ~ 40GHz		Average (AV)

ANTENNA POLARITY & TEST DISTANCE: HORIZONTAL AT 3 M

NO.	FREQ. (MHz)	EMISSION LEVEL (dBuV/m)	LIMIT (dBuV/m)	MARGIN (dB)	ANTENNA HEIGHT (m)	TABLE ANGLE (Degree)	RAW VALUE (dBuV)	CORRECTION FACTOR (dB/m)
1	#5631.58	56.9 PK	68.2	-11.3	2.99 H	347	52.4	4.5
2	*5785.00	119.9 PK			2.99 H	347	115.3	4.6
3	*5785.00	107.4 AV			2.99 H	347	102.8	4.6
4	#6018.24	55.0 PK	68.2	-13.2	2.99 H	347	49.8	5.2
5	11570.00	51.8 PK	74.0	-22.2	1.72 H	288	37.7	14.1
6	11570.00	39.6 AV	54.0	-14.4	1.72 H	288	25.5	14.1
7	#17355.00	55.5 PK	74.0	-18.5	1.24 H	80	37.7	17.8
8	#17355.00	42.6 AV	54.0	-11.4	1.24 H	80	24.8	17.8

ANTENNA POLARITY & TEST DISTANCE: VERTICAL AT 3 M

NO.	FREQ. (MHz)	EMISSION LEVEL (dBuV/m)	LIMIT (dBuV/m)	MARGIN (dB)	ANTENNA HEIGHT (m)	TABLE ANGLE (Degree)	RAW VALUE (dBuV)	CORRECTION FACTOR (dB/m)
1	#5628.85	57.7 PK	68.2	-10.5	2.27 V	302	53.2	4.5
2	*5785.00	120.0 PK			2.27 V	302	115.4	4.6
3	*5785.00	109.2 AV			2.27 V	302	104.6	4.6
4	#5957.59	56.0 PK	68.2	-12.2	2.27 V	302	51.1	4.9
5	11570.00	51.3 PK	74.0	-22.7	2.27 V	184	37.2	14.1
6	11570.00	37.2 AV	54.0	-16.8	2.27 V	184	23.1	14.1
7	#17355.00	53.2 PK	74.0	-20.8	1.20 V	84	35.4	17.8
8	#17355.00	40.3 AV	54.0	-13.7	1.20 V	84	22.5	17.8

REMARKS:

1. Emission Level(dBuV/m) = Raw Value(dBuV) + Correction Factor(dB/m)
2. Correction Factor(dB/m) = Antenna Factor(dB/m) + Cable Factor(dB) – Pre-Amplifier Factor(dB)
3. The other emission levels were very low against the limit.
4. Margin value = Emission Level – Limit value
5. " * ": Fundamental frequency.
6. " # ": The radiated frequency is out of the restricted band.

CHANNEL	TX Channel 165	DETECTOR FUNCTION	Peak (PK)
FREQUENCY RANGE	1GHz ~ 40GHz		Average (AV)

ANTENNA POLARITY & TEST DISTANCE: HORIZONTAL AT 3 M

NO.	FREQ. (MHz)	EMISSION LEVEL (dBuV/m)	LIMIT (dBuV/m)	MARGIN (dB)	ANTENNA HEIGHT (m)	TABLE ANGLE (Degree)	RAW VALUE (dBuV)	CORRECTION FACTOR (dB/m)
1	#5657.47	57.1 PK	73.7	-16.6	2.88 H	331	52.7	4.4
2	*5825.00	119.7 PK			2.88 H	331	114.9	4.8
3	*5825.00	107.1 AV			2.88 H	331	102.3	4.8
4	#5932.89	56.3 PK	68.2	-11.9	2.88 H	331	51.4	4.9
5	11650.00	51.4 PK	74.0	-22.6	2.06 H	152	37.4	14.0
6	11650.00	39.1 AV	54.0	-14.9	2.06 H	152	25.1	14.0
7	#17475.00	56.2 PK	74.0	-17.8	1.83 H	174	37.2	19.0
8	#17475.00	43.2 AV	54.0	-10.8	1.83 H	174	24.2	19.0

ANTENNA POLARITY & TEST DISTANCE: VERTICAL AT 3 M

NO.	FREQ. (MHz)	EMISSION LEVEL (dBuV/m)	LIMIT (dBuV/m)	MARGIN (dB)	ANTENNA HEIGHT (m)	TABLE ANGLE (Degree)	RAW VALUE (dBuV)	CORRECTION FACTOR (dB/m)
1	#5642.54	57.1 PK	68.2	-11.1	2.37 V	312	52.6	4.5
2	*5825.00	119.6 PK			2.37 V	312	114.8	4.8
3	*5825.00	108.8 AV			2.37 V	312	104.0	4.8
4	#5939.81	58.5 PK	68.2	-9.7	2.37 V	312	53.6	4.9
5	11650.00	51.6 PK	74.0	-22.4	1.77 V	360	37.6	14.0
6	11650.00	37.6 AV	54.0	-16.4	1.77 V	360	23.6	14.0
7	#17475.00	54.1 PK	74.0	-19.9	2.01 V	39	35.1	19.0
8	#17475.00	41.1 AV	54.0	-12.9	2.01 V	39	22.1	19.0

REMARKS:

1. Emission Level(dBuV/m) = Raw Value(dBuV) + Correction Factor(dB/m)
2. Correction Factor(dB/m) = Antenna Factor(dB/m) + Cable Factor(dB) – Pre-Amplifier Factor(dB)
3. The other emission levels were very low against the limit.
4. Margin value = Emission Level – Limit value
5. " * ": Fundamental frequency.
6. " # ": The radiated frequency is out of the restricted band.

802.11ac (VHT20)

CHANNEL	TX Channel 36	DETECTOR FUNCTION	Peak (PK)
FREQUENCY RANGE	1GHz ~ 40GHz		Average (AV)

ANTENNA POLARITY & TEST DISTANCE: HORIZONTAL AT 3 M

NO.	FREQ. (MHz)	EMISSION LEVEL (dBuV/m)	LIMIT (dBuV/m)	MARGIN (dB)	ANTENNA HEIGHT (m)	TABLE ANGLE (Degree)	RAW VALUE (dBuV)	CORRECTION FACTOR (dB/m)
1	5150.00	64.9 PK	74.0	-9.1	1.02 H	64	60.6	4.3
2	5150.00	52.4 AV	54.0	-1.6	1.02 H	64	48.1	4.3
3	*5180.00	113.7 PK			1.02 H	64	109.6	4.1
4	*5180.00	101.7 AV			1.02 H	64	97.6	4.1
5	#10360.00	50.0 PK	74.0	-24.0	1.74 H	212	36.7	13.3
6	#10360.00	36.9 AV	54.0	-17.1	1.74 H	212	23.6	13.3
7	15540.00	48.4 PK	74.0	-25.6	1.51 H	165	35.5	12.9
8	15540.00	34.4 AV	54.0	-19.6	1.51 H	165	21.5	12.9

ANTENNA POLARITY & TEST DISTANCE: VERTICAL AT 3 M

NO.	FREQ. (MHz)	EMISSION LEVEL (dBuV/m)	LIMIT (dBuV/m)	MARGIN (dB)	ANTENNA HEIGHT (m)	TABLE ANGLE (Degree)	RAW VALUE (dBuV)	CORRECTION FACTOR (dB/m)
1	5150.00	68.0 PK	74.0	-6.0	1.54 V	191	63.7	4.3
2	5150.00	53.8 AV	54.0	-0.2	1.54 V	191	49.5	4.3
3	*5180.00	116.8 PK			1.54 V	191	112.7	4.1
4	*5180.00	104.1 AV			1.54 V	191	100.0	4.1
5	#10360.00	45.9 PK	74.0	-28.1	1.71 V	342	32.6	13.3
6	#10360.00	32.8 AV	54.0	-21.2	1.71 V	342	19.5	13.3
7	15540.00	46.1 PK	74.0	-27.9	1.31 V	219	33.2	12.9
8	15540.00	32.9 AV	54.0	-21.1	1.31 V	219	20.0	12.9

REMARKS:

- Emission Level(dBuV/m) = Raw Value(dBuV) + Correction Factor(dB/m)
- Correction Factor(dB/m) = Antenna Factor(dB/m) + Cable Factor(dB) – Pre-Amplifier Factor(dB)
- The other emission levels were very low against the limit.
- Margin value = Emission Level – Limit value
- " * ": Fundamental frequency.
- " # ": The radiated frequency is out of the restricted band.

CHANNEL	TX Channel 40	DETECTOR FUNCTION	Peak (PK)
FREQUENCY RANGE	1GHz ~ 40GHz		Average (AV)

ANTENNA POLARITY & TEST DISTANCE: HORIZONTAL AT 3 M

NO.	FREQ. (MHz)	EMISSION LEVEL (dBuV/m)	LIMIT (dBuV/m)	MARGIN (dB)	ANTENNA HEIGHT (m)	TABLE ANGLE (Degree)	RAW VALUE (dBuV)	CORRECTION FACTOR (dB/m)
1	5150.00	60.2 PK	74.0	-13.8	1.90 H	286	55.9	4.3
2	5150.00	43.7 AV	54.0	-10.3	1.90 H	286	39.4	4.3
3	*5200.00	118.3 PK			1.90 H	286	114.3	4.0
4	*5200.00	106.3 AV			1.90 H	286	102.3	4.0
5	5350.00	53.8 PK	74.0	-20.2	1.90 H	286	49.8	4.0
6	5350.00	40.4 AV	54.0	-13.6	1.90 H	286	36.4	4.0
7	#10400.00	54.4 PK	74.0	-19.6	1.71 H	315	40.9	13.5
8	#10400.00	39.9 AV	54.0	-14.1	1.71 H	315	26.4	13.5
9	15600.00	56.8 PK	74.0	-17.2	1.52 H	177	43.7	13.1
10	15600.00	41.6 AV	54.0	-12.4	1.52 H	177	28.5	13.1

ANTENNA POLARITY & TEST DISTANCE: VERTICAL AT 3 M

NO.	FREQ. (MHz)	EMISSION LEVEL (dBuV/m)	LIMIT (dBuV/m)	MARGIN (dB)	ANTENNA HEIGHT (m)	TABLE ANGLE (Degree)	RAW VALUE (dBuV)	CORRECTION FACTOR (dB/m)
1	5150.00	63.5 PK	74.0	-10.5	1.76 V	157	59.2	4.3
2	5150.00	52.9 AV	54.0	-1.1	1.76 V	157	48.6	4.3
3	*5200.00	115.6 PK			1.76 V	157	111.6	4.0
4	*5200.00	103.8 AV			1.76 V	157	99.8	4.0
5	5350.00	57.3 PK	74.0	-16.7	1.76 V	157	53.3	4.0
6	5350.00	45.1 AV	54.0	-8.9	1.76 V	157	41.1	4.0
7	#10400.00	48.2 PK	74.0	-25.8	1.45 V	236	34.7	13.5
8	#10400.00	34.5 AV	54.0	-19.5	1.45 V	236	21.0	13.5
9	15600.00	50.7 PK	74.0	-23.3	1.54 V	176	37.6	13.1
10	15600.00	36.4 AV	54.0	-17.6	1.54 V	176	23.3	13.1

REMARKS:

1. Emission Level(dBuV/m) = Raw Value(dBuV) + Correction Factor(dB/m)
2. Correction Factor(dB/m) = Antenna Factor(dB/m) + Cable Factor(dB) – Pre-Amplifier Factor(dB)
3. The other emission levels were very low against the limit.
4. Margin value = Emission Level – Limit value
5. " * ": Fundamental frequency.
6. " # ": The radiated frequency is out of the restricted band.

CHANNEL	TX Channel 48	DETECTOR FUNCTION	Peak (PK)
FREQUENCY RANGE	1GHz ~ 40GHz		Average (AV)

ANTENNA POLARITY & TEST DISTANCE: HORIZONTAL AT 3 M

NO.	FREQ. (MHz)	EMISSION LEVEL (dBuV/m)	LIMIT (dBuV/m)	MARGIN (dB)	ANTENNA HEIGHT (m)	TABLE ANGLE (Degree)	RAW VALUE (dBuV)	CORRECTION FACTOR (dB/m)
1	*5240.00	115.2 PK			1.82 H	237	111.3	3.9
2	*5240.00	103.0 AV			1.82 H	237	99.1	3.9
3	5350.00	51.0 PK	74.0	-23.0	1.82 H	237	47.0	4.0
4	5350.00	39.4 AV	54.0	-14.6	1.82 H	237	35.4	4.0
5	#10480.00	56.7 PK	74.0	-17.3	1.50 H	330	42.7	14.0
6	#10480.00	40.9 AV	54.0	-13.1	1.50 H	330	26.9	14.0
7	15720.00	57.5 PK	74.0	-16.5	1.41 H	180	44.0	13.5
8	15720.00	41.5 AV	54.0	-12.5	1.41 H	180	28.0	13.5

ANTENNA POLARITY & TEST DISTANCE: VERTICAL AT 3 M

NO.	FREQ. (MHz)	EMISSION LEVEL (dBuV/m)	LIMIT (dBuV/m)	MARGIN (dB)	ANTENNA HEIGHT (m)	TABLE ANGLE (Degree)	RAW VALUE (dBuV)	CORRECTION FACTOR (dB/m)
1	*5240.00	118.0 PK			1.99 V	144	114.1	3.9
2	*5240.00	106.2 AV			1.99 V	144	102.3	3.9
3	5350.00	58.7 PK	74.0	-15.3	1.99 V	144	54.7	4.0
4	5350.00	44.4 AV	54.0	-9.6	1.99 V	144	40.4	4.0
5	#10480.00	48.2 PK	74.0	-25.8	1.25 V	224	34.2	14.0
6	#10480.00	34.5 AV	54.0	-19.5	1.25 V	224	20.5	14.0
7	15720.00	48.6 PK	74.0	-25.4	2.01 V	188	35.1	13.5
8	15720.00	34.9 AV	54.0	-19.1	2.01 V	188	21.4	13.5

REMARKS:

1. Emission Level(dBuV/m) = Raw Value(dBuV) + Correction Factor(dB/m)
2. Correction Factor(dB/m) = Antenna Factor(dB/m) + Cable Factor(dB) – Pre-Amplifier Factor(dB)
3. The other emission levels were very low against the limit.
4. Margin value = Emission Level – Limit value
5. " * ": Fundamental frequency.
6. " # ": The radiated frequency is out of the restricted band.

CHANNEL	TX Channel 149	DETECTOR FUNCTION	Peak (PK)
FREQUENCY RANGE	1GHz ~ 40GHz		Average (AV)

ANTENNA POLARITY & TEST DISTANCE: HORIZONTAL AT 3 M

NO.	FREQ. (MHz)	EMISSION LEVEL (dBuV/m)	LIMIT (dBuV/m)	MARGIN (dB)	ANTENNA HEIGHT (m)	TABLE ANGLE (Degree)	RAW VALUE (dBuV)	CORRECTION FACTOR (dB/m)
1	#5622.38	57.8 PK	68.2	-10.4	2.96 H	345	53.4	4.4
2	*5745.00	119.1 PK			2.96 H	345	114.5	4.6
3	*5745.00	107.1 AV			2.96 H	345	102.5	4.6
4	#5941.63	55.3 PK	68.2	-12.9	2.96 H	345	50.4	4.9
5	11490.00	51.0 PK	74.0	-23.0	1.65 H	321	36.9	14.1
6	11490.00	37.9 AV	54.0	-16.1	1.65 H	321	23.8	14.1
7	#17235.00	53.3 PK	74.0	-20.7	1.49 H	310	36.4	16.9
8	#17235.00	39.0 AV	54.0	-15.0	1.49 H	310	22.1	16.9

ANTENNA POLARITY & TEST DISTANCE: VERTICAL AT 3 M

NO.	FREQ. (MHz)	EMISSION LEVEL (dBuV/m)	LIMIT (dBuV/m)	MARGIN (dB)	ANTENNA HEIGHT (m)	TABLE ANGLE (Degree)	RAW VALUE (dBuV)	CORRECTION FACTOR (dB/m)
1	#5632.98	61.4 PK	68.2	-6.8	2.19 V	302	56.9	4.5
2	*5745.00	120.7 PK			2.19 V	302	116.1	4.6
3	*5745.00	109.5 AV			2.19 V	302	104.9	4.6
4	#6011.41	61.5 PK	68.2	-6.7	2.19 V	302	56.4	5.1
5	11490.00	48.7 PK	74.0	-25.3	1.71 V	17	34.6	14.1
6	11490.00	36.1 AV	54.0	-17.9	1.71 V	17	22.0	14.1
7	#17235.00	53.5 PK	74.0	-20.5	1.56 V	333	36.6	16.9
8	#17235.00	39.4 AV	54.0	-14.6	1.56 V	333	22.5	16.9

REMARKS:

1. Emission Level(dBuV/m) = Raw Value(dBuV) + Correction Factor(dB/m)
2. Correction Factor(dB/m) = Antenna Factor(dB/m) + Cable Factor(dB) – Pre-Amplifier Factor(dB)
3. The other emission levels were very low against the limit.
4. Margin value = Emission Level – Limit value
5. " * ": Fundamental frequency.
6. " # ": The radiated frequency is out of the restricted band.

CHANNEL	TX Channel 157	DETECTOR FUNCTION	Peak (PK)
FREQUENCY RANGE	1GHz ~ 40GHz		Average (AV)

ANTENNA POLARITY & TEST DISTANCE: HORIZONTAL AT 3 M

NO.	FREQ. (MHz)	EMISSION LEVEL (dBuV/m)	LIMIT (dBuV/m)	MARGIN (dB)	ANTENNA HEIGHT (m)	TABLE ANGLE (Degree)	RAW VALUE (dBuV)	CORRECTION FACTOR (dB/m)
1	#5642.80	56.7 PK	68.2	-11.5	2.94 H	350	52.2	4.5
2	*5785.00	119.4 PK			2.94 H	350	114.8	4.6
3	*5785.00	107.3 AV			2.94 H	350	102.7	4.6
4	#5993.41	55.0 PK	68.2	-13.2	2.94 H	350	49.9	5.1
5	11570.00	51.9 PK	74.0	-22.1	1.64 H	314	37.8	14.1
6	11570.00	38.5 AV	54.0	-15.5	1.64 H	314	24.4	14.1
7	#17355.00	53.9 PK	74.0	-20.1	1.38 H	316	36.1	17.8
8	#17355.00	39.6 AV	54.0	-14.4	1.38 H	316	21.8	17.8

ANTENNA POLARITY & TEST DISTANCE: VERTICAL AT 3 M

NO.	FREQ. (MHz)	EMISSION LEVEL (dBuV/m)	LIMIT (dBuV/m)	MARGIN (dB)	ANTENNA HEIGHT (m)	TABLE ANGLE (Degree)	RAW VALUE (dBuV)	CORRECTION FACTOR (dB/m)
1	#5589.38	62.4 PK	68.2	-5.8	2.21 V	317	58.0	4.4
2	*5785.00	119.3 PK			2.21 V	317	114.7	4.6
3	*5785.00	109.4 AV			2.21 V	317	104.8	4.6
4	#5946.71	62.0 PK	68.2	-6.2	2.21 V	317	57.1	4.9
5	11570.00	48.1 PK	74.0	-25.9	1.69 V	30	34.0	14.1
6	11570.00	35.9 AV	54.0	-18.1	1.69 V	30	21.8	14.1
7	#17355.00	53.4 PK	74.0	-20.6	1.62 V	325	35.6	17.8
8	#17355.00	39.3 AV	54.0	-14.7	1.62 V	325	21.5	17.8

REMARKS:

1. Emission Level(dBuV/m) = Raw Value(dBuV) + Correction Factor(dB/m)
2. Correction Factor(dB/m) = Antenna Factor(dB/m) + Cable Factor(dB) – Pre-Amplifier Factor(dB)
3. The other emission levels were very low against the limit.
4. Margin value = Emission Level – Limit value
5. " * ": Fundamental frequency.
6. " # ": The radiated frequency is out of the restricted band.

CHANNEL	TX Channel 165	DETECTOR FUNCTION	Peak (PK)
FREQUENCY RANGE	1GHz ~ 40GHz		Average (AV)

ANTENNA POLARITY & TEST DISTANCE: HORIZONTAL AT 3 M

NO.	FREQ. (MHz)	EMISSION LEVEL (dBuV/m)	LIMIT (dBuV/m)	MARGIN (dB)	ANTENNA HEIGHT (m)	TABLE ANGLE (Degree)	RAW VALUE (dBuV)	CORRECTION FACTOR (dB/m)
1	#5620.67	57.0 PK	68.2	-11.2	2.97 H	348	52.6	4.4
2	*5825.00	119.6 PK			2.97 H	348	114.8	4.8
3	*5825.00	107.5 AV			2.97 H	348	102.7	4.8
4	#5951.72	56.9 PK	68.2	-11.3	2.97 H	348	52.0	4.9
5	11650.00	52.0 PK	74.0	-22.0	1.68 H	299	38.0	14.0
6	11650.00	38.5 AV	54.0	-15.5	1.68 H	299	24.5	14.0
7	#17475.00	53.7 PK	74.0	-20.3	1.40 H	311	34.7	19.0
8	#17475.00	39.0 AV	54.0	-15.0	1.40 H	311	20.0	19.0

ANTENNA POLARITY & TEST DISTANCE: VERTICAL AT 3 M

NO.	FREQ. (MHz)	EMISSION LEVEL (dBuV/m)	LIMIT (dBuV/m)	MARGIN (dB)	ANTENNA HEIGHT (m)	TABLE ANGLE (Degree)	RAW VALUE (dBuV)	CORRECTION FACTOR (dB/m)
1	#5604.47	63.8 PK	68.2	-4.4	2.14 V	331	59.4	4.4
2	*5825.00	120.6 PK			2.14 V	331	115.8	4.8
3	*5825.00	109.4 AV			2.14 V	331	104.6	4.8
4	#5928.88	64.1 PK	68.2	-4.1	2.14 V	331	59.2	4.9
5	11650.00	48.0 PK	74.0	-26.0	1.67 V	27	34.0	14.0
6	11650.00	35.2 AV	54.0	-18.8	1.67 V	27	21.2	14.0
7	#17475.00	53.4 PK	74.0	-20.6	1.60 V	334	34.4	19.0
8	#17475.00	39.0 AV	54.0	-15.0	1.60 V	334	20.0	19.0

REMARKS:

1. Emission Level(dBuV/m) = Raw Value(dBuV) + Correction Factor(dB/m)
2. Correction Factor(dB/m) = Antenna Factor(dB/m) + Cable Factor(dB) – Pre-Amplifier Factor(dB)
3. The other emission levels were very low against the limit.
4. Margin value = Emission Level – Limit value
5. " * ": Fundamental frequency.
6. " # ": The radiated frequency is out of the restricted band.

802.11ac (VHT40)

CHANNEL	TX Channel 38	DETECTOR FUNCTION	Peak (PK)
FREQUENCY RANGE	1GHz ~ 40GHz		Average (AV)

ANTENNA POLARITY & TEST DISTANCE: HORIZONTAL AT 3 M

NO.	FREQ. (MHz)	EMISSION LEVEL (dBuV/m)	LIMIT (dBuV/m)	MARGIN (dB)	ANTENNA HEIGHT (m)	TABLE ANGLE (Degree)	RAW VALUE (dBuV)	CORRECTION FACTOR (dB/m)
1	5150.00	69.7 PK	74.0	-4.3	1.74 H	70	65.4	4.3
2	5150.00	52.7 AV	54.0	-1.3	1.74 H	70	48.4	4.3
3	*5190.00	107.9 PK			1.74 H	70	103.8	4.1
4	*5190.00	97.9 AV			1.74 H	70	93.8	4.1
5	5350.00	46.7 PK	74.0	-27.3	1.74 H	70	42.7	4.0
6	5350.00	34.3 AV	54.0	-19.7	1.74 H	70	30.3	4.0
7	#10380.00	54.6 PK	74.0	-19.4	1.71 H	286	41.2	13.4
8	#10380.00	39.9 AV	54.0	-14.1	1.71 H	286	26.5	13.4
9	15570.00	56.2 PK	74.0	-17.8	1.50 H	182	43.2	13.0
10	15570.00	40.4 AV	54.0	-13.6	1.50 H	182	27.4	13.0

ANTENNA POLARITY & TEST DISTANCE: VERTICAL AT 3 M

NO.	FREQ. (MHz)	EMISSION LEVEL (dBuV/m)	LIMIT (dBuV/m)	MARGIN (dB)	ANTENNA HEIGHT (m)	TABLE ANGLE (Degree)	RAW VALUE (dBuV)	CORRECTION FACTOR (dB/m)
1	5150.00	72.3 PK	74.0	-1.7	1.90 V	149	68.0	4.3
2	5150.00	53.9 AV	54.0	-0.1	1.90 V	149	49.6	4.3
3	*5190.00	110.9 PK			1.90 V	149	106.8	4.1
4	*5190.00	100.7 AV			1.90 V	149	96.6	4.1
5	5350.00	49.3 PK	74.0	-24.7	1.90 V	149	45.3	4.0
6	5350.00	35.5 AV	54.0	-18.5	1.90 V	149	31.5	4.0
7	#10380.00	48.4 PK	74.0	-25.6	1.43 V	220	35.0	13.4
8	#10380.00	34.5 AV	54.0	-19.5	1.43 V	220	21.1	13.4
9	15570.00	48.3 PK	74.0	-25.7	1.46 V	168	35.3	13.0
10	15570.00	34.7 AV	54.0	-19.3	1.46 V	168	21.7	13.0

REMARKS:

- Emission Level(dBuV/m) = Raw Value(dBuV) + Correction Factor(dB/m)
- Correction Factor(dB/m) = Antenna Factor(dB/m) + Cable Factor(dB) – Pre-Amplifier Factor(dB)
- The other emission levels were very low against the limit.
- Margin value = Emission Level – Limit value
- " * ": Fundamental frequency.
- " # ": The radiated frequency is out of the restricted band.

CHANNEL	TX Channel 46	DETECTOR FUNCTION	Peak (PK)
FREQUENCY RANGE	1GHz ~ 40GHz		Average (AV)

ANTENNA POLARITY & TEST DISTANCE: HORIZONTAL AT 3 M

NO.	FREQ. (MHz)	EMISSION LEVEL (dBuV/m)	LIMIT (dBuV/m)	MARGIN (dB)	ANTENNA HEIGHT (m)	TABLE ANGLE (Degree)	RAW VALUE (dBuV)	CORRECTION FACTOR (dB/m)
1	5150.00	60.0 PK	74.0	-14.0	1.78 H	46	55.7	4.3
2	5150.00	46.3 AV	54.0	-7.7	1.78 H	46	42.0	4.3
3	*5230.00	111.5 PK			1.78 H	46	107.6	3.9
4	*5230.00	101.7 AV			1.78 H	46	97.8	3.9
5	5350.00	46.6 PK	74.0	-27.4	1.78 H	46	42.6	4.0
6	5350.00	37.0 AV	54.0	-17.0	1.78 H	46	33.0	4.0
7	#10460.00	55.7 PK	74.0	-18.3	1.70 H	333	41.8	13.9
8	#10460.00	41.1 AV	54.0	-12.9	1.70 H	333	27.2	13.9
9	15690.00	56.0 PK	74.0	-18.0	1.46 H	162	42.4	13.6
10	15690.00	40.1 AV	54.0	-13.9	1.46 H	162	26.5	13.6

ANTENNA POLARITY & TEST DISTANCE: VERTICAL AT 3 M

NO.	FREQ. (MHz)	EMISSION LEVEL (dBuV/m)	LIMIT (dBuV/m)	MARGIN (dB)	ANTENNA HEIGHT (m)	TABLE ANGLE (Degree)	RAW VALUE (dBuV)	CORRECTION FACTOR (dB/m)
1	5150.00	63.4 PK	74.0	-10.6	1.65 V	147	59.1	4.3
2	5150.00	47.4 AV	54.0	-6.6	1.65 V	147	43.1	4.3
3	*5230.00	114.0 PK			1.65 V	147	110.1	3.9
4	*5230.00	103.9 AV			1.65 V	147	100.0	3.9
5	5350.00	49.1 PK	74.0	-24.9	1.65 V	147	45.1	4.0
6	5350.00	37.9 AV	54.0	-16.1	1.65 V	147	33.9	4.0
7	#10460.00	47.4 PK	74.0	-26.6	1.52 V	242	33.5	13.9
8	#10460.00	34.1 AV	54.0	-19.9	1.52 V	242	20.2	13.9
9	15690.00	48.7 PK	74.0	-25.3	1.43 V	171	35.1	13.6
10	15690.00	34.7 AV	54.0	-19.3	1.43 V	171	21.1	13.6

REMARKS:

1. Emission Level(dBuV/m) = Raw Value(dBuV) + Correction Factor(dB/m)
2. Correction Factor(dB/m) = Antenna Factor(dB/m) + Cable Factor(dB) – Pre-Amplifier Factor(dB)
3. The other emission levels were very low against the limit.
4. Margin value = Emission Level – Limit value
5. " * ": Fundamental frequency.
6. " # ": The radiated frequency is out of the restricted band.

CHANNEL	TX Channel 151	DETECTOR FUNCTION	Peak (PK)
FREQUENCY RANGE	1GHz ~ 40GHz		Average (AV)

ANTENNA POLARITY & TEST DISTANCE: HORIZONTAL AT 3 M

NO.	FREQ. (MHz)	EMISSION LEVEL (dBuV/m)	LIMIT (dBuV/m)	MARGIN (dB)	ANTENNA HEIGHT (m)	TABLE ANGLE (Degree)	RAW VALUE (dBuV)	CORRECTION FACTOR (dB/m)
1	#5643.72	67.4 PK	68.2	-0.8	2.96 H	350	62.9	4.5
2	*5755.00	115.7 PK			2.96 H	350	111.1	4.6
3	*5755.00	105.9 AV			2.96 H	350	101.3	4.6
4	#5926.94	55.8 PK	68.2	-12.4	2.96 H	350	50.9	4.9
5	11510.00	55.6 PK	74.0	-18.4	1.75 H	310	41.5	14.1
6	11510.00	41.0 AV	54.0	-13.0	1.75 H	310	26.9	14.1
7	#17265.00	56.9 PK	74.0	-17.1	1.55 H	182	39.8	17.1
8	#17265.00	40.7 AV	54.0	-13.3	1.55 H	182	23.6	17.1

ANTENNA POLARITY & TEST DISTANCE: VERTICAL AT 3 M

NO.	FREQ. (MHz)	EMISSION LEVEL (dBuV/m)	LIMIT (dBuV/m)	MARGIN (dB)	ANTENNA HEIGHT (m)	TABLE ANGLE (Degree)	RAW VALUE (dBuV)	CORRECTION FACTOR (dB/m)
1	#5650.94	68.1 PK	68.9	-0.8	2.39 V	321	63.7	4.4
2	*5755.00	118.1 PK			2.39 V	321	113.5	4.6
3	*5755.00	108.7 AV			2.39 V	321	104.1	4.6
4	#5935.51	55.7 PK	68.2	-12.5	2.39 V	321	50.8	4.9
5	11510.00	47.4 PK	74.0	-26.6	1.46 V	233	33.3	14.1
6	11510.00	34.4 AV	54.0	-19.6	1.46 V	233	20.3	14.1
7	#17265.00	49.0 PK	74.0	-25.0	1.49 V	157	31.9	17.1
8	#17265.00	35.0 AV	54.0	-19.0	1.49 V	157	17.9	17.1

REMARKS:

1. Emission Level(dBuV/m) = Raw Value(dBuV) + Correction Factor(dB/m)
2. Correction Factor(dB/m) = Antenna Factor(dB/m) + Cable Factor(dB) – Pre-Amplifier Factor(dB)
3. The other emission levels were very low against the limit.
4. Margin value = Emission Level – Limit value
5. " * ": Fundamental frequency.
6. " # ": The radiated frequency is out of the restricted band.

CHANNEL	TX Channel 159	DETECTOR FUNCTION	Peak (PK)
FREQUENCY RANGE	1GHz ~ 40GHz		Average (AV)

ANTENNA POLARITY & TEST DISTANCE: HORIZONTAL AT 3 M

NO.	FREQ. (MHz)	EMISSION LEVEL (dBuV/m)	LIMIT (dBuV/m)	MARGIN (dB)	ANTENNA HEIGHT (m)	TABLE ANGLE (Degree)	RAW VALUE (dBuV)	CORRECTION FACTOR (dB/m)
1	#5642.58	63.2 PK	68.2	-5.0	2.89 H	349	58.7	4.5
2	*5795.00	115.6 PK			2.89 H	349	110.9	4.7
3	*5795.00	106.1 AV			2.89 H	349	101.4	4.7
4	#5933.87	60.9 PK	68.2	-7.3	2.89 H	349	56.0	4.9
5	11590.00	56.1 PK	74.0	-17.9	1.66 H	322	42.0	14.1
6	11590.00	41.2 AV	54.0	-12.8	1.66 H	322	27.1	14.1
7	#17385.00	56.5 PK	74.0	-17.5	1.56 H	163	38.5	18.0
8	#17385.00	40.6 AV	54.0	-13.4	1.56 H	163	22.6	18.0

ANTENNA POLARITY & TEST DISTANCE: VERTICAL AT 3 M

NO.	FREQ. (MHz)	EMISSION LEVEL (dBuV/m)	LIMIT (dBuV/m)	MARGIN (dB)	ANTENNA HEIGHT (m)	TABLE ANGLE (Degree)	RAW VALUE (dBuV)	CORRECTION FACTOR (dB/m)
1	#5642.42	65.9 PK	68.2	-2.3	2.41 V	325	61.4	4.5
2	*5795.00	118.2 PK			2.41 V	325	113.5	4.7
3	*5795.00	108.9 AV			2.41 V	325	104.2	4.7
4	#5925.17	61.7 PK	68.2	-6.5	2.41 V	325	56.8	4.9
5	11590.00	47.7 PK	74.0	-26.3	1.47 V	226	33.6	14.1
6	11590.00	34.7 AV	54.0	-19.3	1.47 V	226	20.6	14.1
7	#17385.00	49.0 PK	74.0	-25.0	1.43 V	164	31.0	18.0
8	#17385.00	34.9 AV	54.0	-19.1	1.43 V	164	16.9	18.0

REMARKS:

1. Emission Level(dBuV/m) = Raw Value(dBuV) + Correction Factor(dB/m)
2. Correction Factor(dB/m) = Antenna Factor(dB/m) + Cable Factor(dB) – Pre-Amplifier Factor(dB)
3. The other emission levels were very low against the limit.
4. Margin value = Emission Level – Limit value
5. " * ": Fundamental frequency.
6. " # ": The radiated frequency is out of the restricted band.

802.11ac (VHT80)

CHANNEL	TX Channel 42	DETECTOR FUNCTION	Peak (PK)
FREQUENCY RANGE	1GHz ~ 40GHz		Average (AV)

ANTENNA POLARITY & TEST DISTANCE: HORIZONTAL AT 3 M

NO.	FREQ. (MHz)	EMISSION LEVEL (dBuV/m)	LIMIT (dBuV/m)	MARGIN (dB)	ANTENNA HEIGHT (m)	TABLE ANGLE (Degree)	RAW VALUE (dBuV)	CORRECTION FACTOR (dB/m)
1	5147.30	66.8 PK	74.0	-7.2	1.89 H	58	62.5	4.3
2	5147.30	52.6 AV	54.0	-1.4	1.89 H	58	48.3	4.3
3	*5210.00	103.5 PK			1.89 H	58	99.4	4.1
4	*5210.00	94.0 AV			1.89 H	58	89.9	4.1
5	5350.00	49.5 PK	74.0	-24.5	1.89 H	58	45.5	4.0
6	5350.00	38.4 AV	54.0	-15.6	1.89 H	58	34.4	4.0
7	#10420.00	54.8 PK	74.0	-19.2	1.71 H	321	41.2	13.6
8	#10420.00	40.0 AV	54.0	-14.0	1.71 H	321	26.4	13.6
9	15630.00	56.0 PK	74.0	-18.0	1.56 H	184	42.7	13.3
10	15630.00	40.6 AV	54.0	-13.4	1.56 H	184	27.3	13.3

ANTENNA POLARITY & TEST DISTANCE: VERTICAL AT 3 M

NO.	FREQ. (MHz)	EMISSION LEVEL (dBuV/m)	LIMIT (dBuV/m)	MARGIN (dB)	ANTENNA HEIGHT (m)	TABLE ANGLE (Degree)	RAW VALUE (dBuV)	CORRECTION FACTOR (dB/m)
1	5147.30	69.4 PK	74.0	-4.6	1.48 V	146	65.1	4.3
2	5147.30	53.8 AV	54.0	-0.2	1.48 V	146	49.5	4.3
3	*5210.00	106.2 PK			1.48 V	146	102.1	4.1
4	*5210.00	97.3 AV			1.48 V	146	93.2	4.1
5	5350.00	52.1 PK	74.0	-21.9	1.48 V	146	48.1	4.0
6	5350.00	39.6 AV	54.0	-14.4	1.48 V	146	35.6	4.0
7	#10420.00	47.3 PK	74.0	-26.7	1.49 V	226	33.7	13.6
8	#10420.00	34.1 AV	54.0	-19.9	1.49 V	226	20.5	13.6
9	15630.00	47.1 PK	74.0	-26.9	1.48 V	167	33.8	13.3
10	15630.00	33.2 AV	54.0	-20.8	1.48 V	167	19.9	13.3

REMARKS:

1. Emission Level(dBuV/m) = Raw Value(dBuV) + Correction Factor(dB/m)
2. Correction Factor(dB/m) = Antenna Factor(dB/m) + Cable Factor(dB) – Pre-Amplifier Factor(dB)
3. The other emission levels were very low against the limit.
4. Margin value = Emission Level – Limit value
5. " * ": Fundamental frequency.
6. " # ": The radiated frequency is out of the restricted band.

CHANNEL	TX Channel 155	DETECTOR FUNCTION	Peak (PK)
FREQUENCY RANGE	1GHz ~ 40GHz		Average (AV)

ANTENNA POLARITY & TEST DISTANCE: HORIZONTAL AT 3 M

NO.	FREQ. (MHz)	EMISSION LEVEL (dBuV/m)	LIMIT (dBuV/m)	MARGIN (dB)	ANTENNA HEIGHT (m)	TABLE ANGLE (Degree)	RAW VALUE (dBuV)	CORRECTION FACTOR (dB/m)
1	#5635.51	62.6 PK	68.2	-5.6	1.83 H	63	57.8	4.8
2	*5775.00	107.9 PK			2.95 H	338	103.3	4.6
3	*5775.00	98.5 AV			2.95 H	338	93.9	4.6
4	#5935.27	59.5 PK	68.2	-8.7	1.83 H	63	54.1	5.4
5	11550.00	55.6 PK	74.0	-18.4	1.71 H	311	41.5	14.1
6	11550.00	40.8 AV	54.0	-13.2	1.71 H	311	26.7	14.1
7	#17325.00	56.3 PK	74.0	-17.7	1.55 H	169	38.9	17.4
8	#17325.00	40.4 AV	54.0	-13.6	1.55 H	169	23.0	17.4

ANTENNA POLARITY & TEST DISTANCE: VERTICAL AT 3 M

NO.	FREQ. (MHz)	EMISSION LEVEL (dBuV/m)	LIMIT (dBuV/m)	MARGIN (dB)	ANTENNA HEIGHT (m)	TABLE ANGLE (Degree)	RAW VALUE (dBuV)	CORRECTION FACTOR (dB/m)
1	#5644.00	67.7 PK	68.2	-0.5	2.51 V	342	62.9	4.8
2	*5775.00	110.6 PK			2.51 V	342	106.0	4.6
3	*5775.00	101.8 AV			2.51 V	342	97.2	4.6
4	#6006.69	60.6 PK	68.2	-7.6	2.51 V	342	54.9	5.7
5	11550.00	47.8 PK	74.0	-26.2	1.45 V	222	33.7	14.1
6	11550.00	34.6 AV	54.0	-19.4	1.45 V	222	20.5	14.1
7	#17325.00	49.2 PK	74.0	-24.8	1.47 V	171	31.8	17.4
8	#17325.00	35.2 AV	54.0	-18.8	1.47 V	171	17.8	17.4

REMARKS:

1. Emission Level(dBuV/m) = Raw Value(dBuV) + Correction Factor(dB/m)
2. Correction Factor(dB/m) = Antenna Factor(dB/m) + Cable Factor(dB) – Pre-Amplifier Factor(dB)
3. The other emission levels were very low against the limit.
4. Margin value = Emission Level – Limit value
5. " * ": Fundamental frequency.
6. " # ": The radiated frequency is out of the restricted band.

Below 1GHz Data:

802.11ac (VHT40)

CHANNEL	TX Channel 159	DETECTOR FUNCTION	Quasi-Peak (QP)
FREQUENCY RANGE	9kHz ~ 1GHz		

ANTENNA POLARITY & TEST DISTANCE: HORIZONTAL AT 3 M

NO.	FREQ. (MHz)	EMISSION LEVEL (dBuV/m)	LIMIT (dBuV/m)	MARGIN (dB)	ANTENNA HEIGHT (m)	TABLE ANGLE (Degree)	RAW VALUE (dBuV)	CORRECTION FACTOR (dB/m)
1	30.90	31.2 QP	40.0	-8.8	1.00 H	112	40.0	-8.8
2	81.60	33.1 QP	40.0	-6.9	2.00 H	360	46.0	-12.9
3	148.19	28.5 QP	43.5	-15.0	2.00 H	283	36.2	-7.7
4	458.98	23.5 QP	46.0	-22.5	1.50 H	222	26.3	-2.8
5	724.16	27.7 QP	46.0	-18.3	1.50 H	147	26.2	1.5
6	981.59	32.5 QP	54.0	-21.5	3.00 H	358	27.1	5.4

ANTENNA POLARITY & TEST DISTANCE: VERTICAL AT 3 M

NO.	FREQ. (MHz)	EMISSION LEVEL (dBuV/m)	LIMIT (dBuV/m)	MARGIN (dB)	ANTENNA HEIGHT (m)	TABLE ANGLE (Degree)	RAW VALUE (dBuV)	CORRECTION FACTOR (dB/m)
1	36.91	36.9 QP	40.0	-3.1	1.00 V	149	45.5	-8.6
2	85.90	31.0 QP	40.0	-9.0	3.00 V	247	44.6	-13.6
3	241.00	27.6 QP	46.0	-18.4	2.00 V	208	37.0	-9.4
4	554.50	32.8 QP	46.0	-13.2	1.00 V	70	34.1	-1.3
5	708.88	29.2 QP	46.0	-16.8	1.00 V	170	27.9	1.3
6	870.84	31.3 QP	46.0	-14.7	2.00 V	356	27.4	3.9

REMARKS:

1. Emission Level(dBuV/m) = Raw Value(dBuV) + Correction Factor(dB/m)
2. Correction Factor(dB/m) = Antenna Factor(dB/m) + Cable Factor(dB) – Pre-Amplifier Factor(dB)
3. The other emission levels were very low against the limit.
4. Margin value = Emission Level – Limit value

4.2 Conducted Emission Measurement

4.2.1 Limits of Conducted Emission Measurement

Frequency (MHz)	Conducted Limit (dBuV)	
	Quasi-peak	Average
0.15 - 0.5	66 - 56	56 - 46
0.50 - 5.0	56	46
5.0 - 30.0	60	50

Note: 1. The lower limit shall apply at the transition frequencies.

2. The limit decreases in line with the logarithm of the frequency in the range of 0.15 to 0.50MHz.

4.2.2 Test Instruments

DESCRIPTION & MANUFACTURER	MODEL NO.	SERIAL NO.	CALIBRATED DATE	CALIBRATED UNTIL
Test Receiver R&S	ESCS 30	847124/029	Nov. 01, 2017	Oct. 31, 2018
Line-Impedance Stabilization Network (for EUT) R&S	ESH3-Z5	848773/004	Nov. 15, 20167	Nov. 14, 2018
Line-Impedance Stabilization Network (for Peripheral) R&S	ENV216	100072	June 03, 2017	June 02, 2018
50 ohms Terminator	N/A	EMC-02	Sep. 22, 2017	Sep. 21, 2018
RF Cable	5D-FB	COCCAB-001	Sep. 29, 2017	Sep. 28, 2018
10 dB PAD Mini-Circuits	HAT-10+	CONATT-004	June 18, 2017	June 17, 2018
Software BVADT	BVADT_Cond_ V7.3.7.4	NA	NA	NA

Note:

1. The calibration interval of the above test instruments are 12 months and the calibrations are traceable to NML/ROC and NIST/USA.
2. The test was performed in Shielded Room No. 1.
3. Tested Date: Dec. 21 to 22, 2017

4.2.3 Test Procedure

- The EUT was placed 0.4 meters from the conducting wall of the shielded room with EUT being connected to the power mains through a line impedance stabilization network (LISN). Other support units were connected to the power mains through another LISN. The two LISNs provide 50 ohm/ 50uH of coupling impedance for the measuring instrument.
- Both lines of the power mains connected to the EUT were checked for maximum conducted interference.
- The frequency range from 150kHz to 30MHz was searched. Emission levels under (Limit - 20dB) was not recorded.

NOTE: All modes of operation were investigated and the worst-case emissions are reported.

4.2.4 Deviation from Test Standard

No deviation.

4.2.5 Test Setup

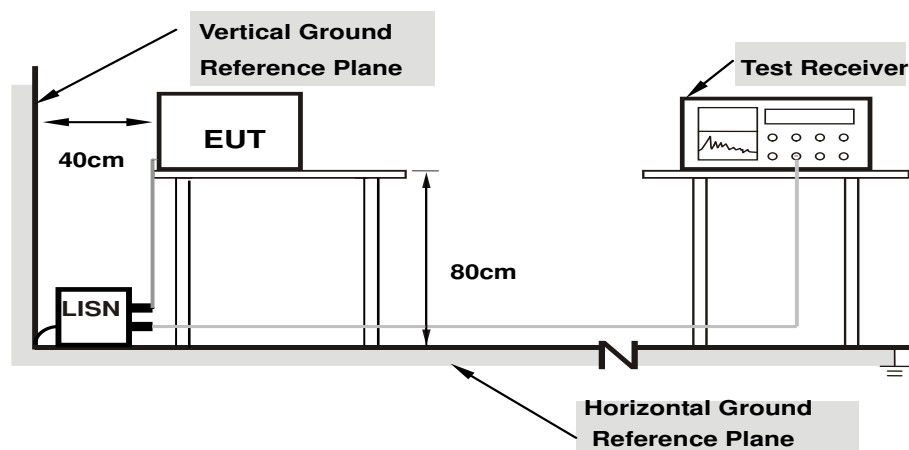

Note: 1.Support units were connected to second LISN.

For the actual test configuration, please refer to the attached file (Test Setup Photo).

4.2.6 EUT Operating Condition

Same as 4.1.6.

4.2.7 Test Results (Mode 1)

Phase	Line (L)	Detector Function	Quasi-Peak (QP) / Average (AV)
-------	----------	-------------------	--------------------------------

No	Freq. [MHz]	Corr. Factor	Reading Value [dB (uV)]		Emission Level [dB (uV)]		Limit [dB (uV)]		Margin (dB)	
		(dB)	Q.P.	AV.	Q.P.	AV.	Q.P.	AV.	Q.P.	AV.
	1	0.15000	10.09	41.32	26.88	51.41	36.97	66.00	56.00	-14.59
2	0.16953	10.08	36.78	22.04	46.86	32.12	64.98	54.98	-18.12	-22.86
3	0.40781	10.12	30.77	29.40	40.89	39.52	57.69	47.69	-16.80	-8.17
4	0.88047	10.16	10.70	4.69	20.86	14.85	56.00	46.00	-35.14	-31.15
5	12.81250	11.02	13.87	8.83	24.89	19.85	60.00	50.00	-35.11	-30.15
6	21.75781	11.61	3.06	-1.92	14.67	9.69	60.00	50.00	-45.33	-40.31

REMARKS:

1. Q.P. and AV. are abbreviations of quasi-peak and average individually.
2. The emission levels of other frequencies were very low against the limit.
3. Margin value = Emission level - Limit value
4. Correction factor = Insertion loss + Cable loss
5. Emission Level = Correction Factor + Reading Value.

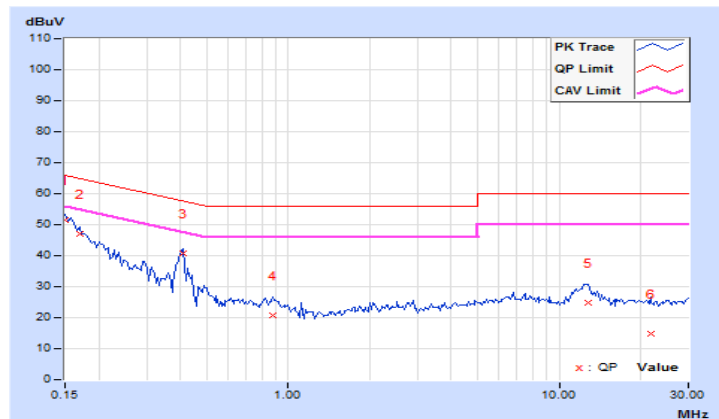

Phase	Neutral (N)	Detector Function	Quasi-Peak (QP) / Average (AV)
-------	-------------	-------------------	--------------------------------

No	Freq.	Corr.	Reading Value		Emission Level		Limit		Margin	
	[MHz]	Factor	[dB (uV)]		[dB (uV)]		[dB (uV)]		(dB)	
		(dB)	Q.P.	AV.	Q.P.	AV.	Q.P.	AV.	Q.P.	AV.
1	0.15000	10.08	41.50	26.56	51.58	36.64	66.00	56.00	-14.42	-19.36
2	0.16953	10.06	36.98	21.81	47.04	31.87	64.98	54.98	-17.94	-23.11
3	0.21250	10.05	29.14	16.68	39.19	26.73	63.11	53.11	-23.92	-26.38
4	0.25156	10.06	25.49	14.07	35.55	24.13	61.71	51.71	-26.16	-27.58
5	0.40478	10.12	25.22	22.99	35.34	33.11	57.75	47.75	-22.41	-14.64
6	12.01953	10.83	18.47	13.39	29.30	24.22	60.00	50.00	-30.70	-25.78

REMARKS:

1. Q.P. and AV. are abbreviations of quasi-peak and average individually.
2. The emission levels of other frequencies were very low against the limit.
3. Margin value = Emission level - Limit value
4. Correction factor = Insertion loss + Cable loss
5. Emission Level = Correction Factor + Reading Value.

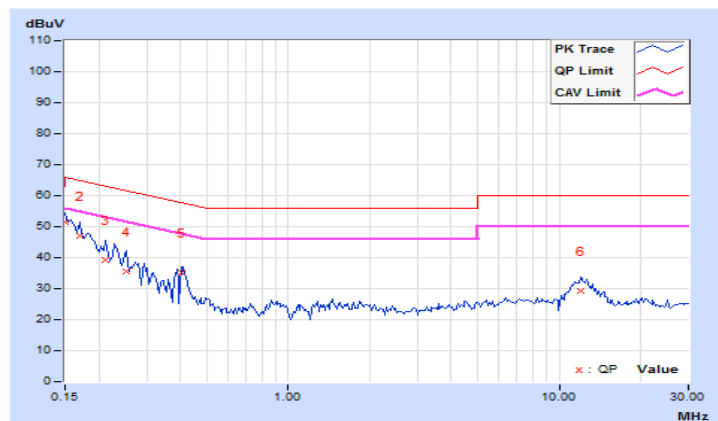

4.2.8 Test Results (Mode 2)

Phase	Line (L)	Detector Function	Quasi-Peak (QP) / Average (AV)
-------	----------	-------------------	--------------------------------

No	Freq. [MHz]	Corr. Factor	Reading Value [dB (uV)]		Emission Level [dB (uV)]		Limit [dB (uV)]		Margin (dB)	
		(dB)	Q.P.	AV.	Q.P.	AV.	Q.P.	AV.	Q.P.	AV.
	1	0.15000	10.09	43.43	28.66	53.52	38.75	66.00	56.00	-12.48
2	0.17344	10.08	38.57	24.72	48.65	34.80	64.79	54.79	-16.14	-19.99
3	0.24375	10.08	25.12	13.63	35.20	23.71	61.97	51.97	-26.77	-28.26
4	0.41563	10.12	32.17	25.38	42.29	35.50	57.54	47.54	-15.25	-12.04
5	0.84141	10.16	14.52	9.99	24.68	20.15	56.00	46.00	-31.32	-25.85
6	12.64844	11.01	14.97	10.18	25.98	21.19	60.00	50.00	-34.02	-28.81

REMARKS:

1. Q.P. and AV. are abbreviations of quasi-peak and average individually.
2. The emission levels of other frequencies were very low against the limit.
3. Margin value = Emission level - Limit value
4. Correction factor = Insertion loss + Cable loss
5. Emission Level = Correction Factor + Reading Value.

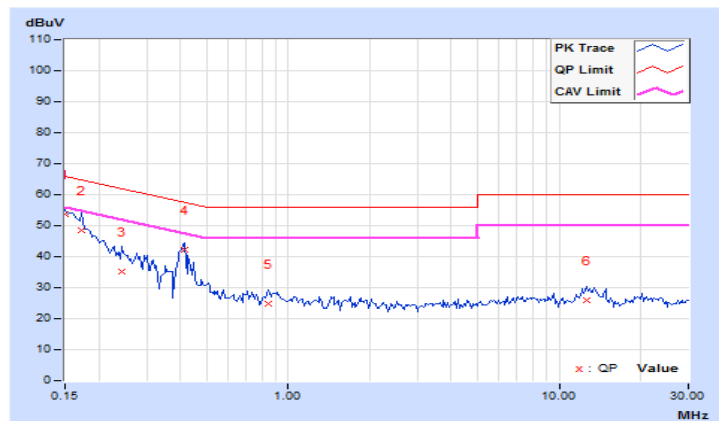

Phase	Neutral (N)	Detector Function	Quasi-Peak (QP) / Average (AV)
-------	-------------	-------------------	--------------------------------

No	Freq. [MHz]	Corr. Factor	Reading Value [dB (uV)]		Emission Level [dB (uV)]		Limit [dB (uV)]		Margin (dB)	
		(dB)	Q.P.	AV.	Q.P.	AV.	Q.P.	AV.	Q.P.	AV.
	1	0.15000	10.08	43.23	28.27	53.31	38.35	66.00	56.00	-12.69
2	0.16172	10.07	41.23	26.67	51.30	36.74	65.38	55.38	-14.08	-18.64
3	0.21641	10.05	30.38	17.65	40.43	27.70	62.96	52.96	-22.53	-25.26
4	0.40781	10.12	30.43	28.89	40.55	39.01	57.69	47.69	-17.14	-8.68
5	0.85313	10.13	13.73	6.65	23.86	16.78	56.00	46.00	-32.14	-29.22
6	12.50000	10.86	17.59	12.48	28.45	23.34	60.00	50.00	-31.55	-26.66

REMARKS:

1. Q.P. and AV. are abbreviations of quasi-peak and average individually.
2. The emission levels of other frequencies were very low against the limit.
3. Margin value = Emission level - Limit value
4. Correction factor = Insertion loss + Cable loss
5. Emission Level = Correction Factor + Reading Value.

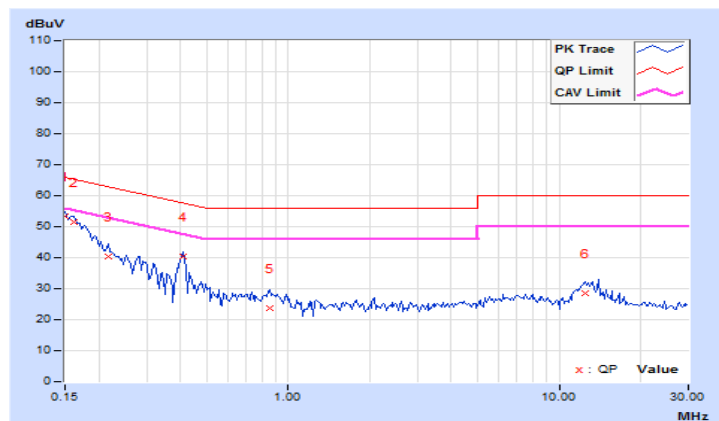

4.2.9 Test Results (Mode 3)

Phase	Line (L)	Detector Function	Quasi-Peak (QP) / Average (AV)
-------	----------	-------------------	--------------------------------

No	Freq. [MHz]	Corr. Factor	Reading Value [dB (uV)]		Emission Level [dB (uV)]		Limit [dB (uV)]		Margin (dB)	
		(dB)	Q.P.	AV.	Q.P.	AV.	Q.P.	AV.	Q.P.	AV.
	1	0.15000	10.09	45.60	29.19	55.69	39.28	66.00	56.00	-10.31
2	0.16172	10.08	43.70	28.07	53.78	38.15	65.38	55.38	-11.60	-17.23
3	0.35313	10.11	31.64	23.49	41.75	33.60	58.89	48.89	-17.14	-15.29
4	0.43125	10.12	38.16	29.96	48.28	40.08	57.23	47.23	-8.95	-7.15
5	0.57188	10.13	26.61	17.68	36.74	27.81	56.00	46.00	-19.26	-18.19
6	16.37500	11.31	30.62	25.34	41.93	36.65	60.00	50.00	-18.07	-13.35

REMARKS:

1. Q.P. and AV. are abbreviations of quasi-peak and average individually.
2. The emission levels of other frequencies were very low against the limit.
3. Margin value = Emission level - Limit value
4. Correction factor = Insertion loss + Cable loss
5. Emission Level = Correction Factor + Reading Value.

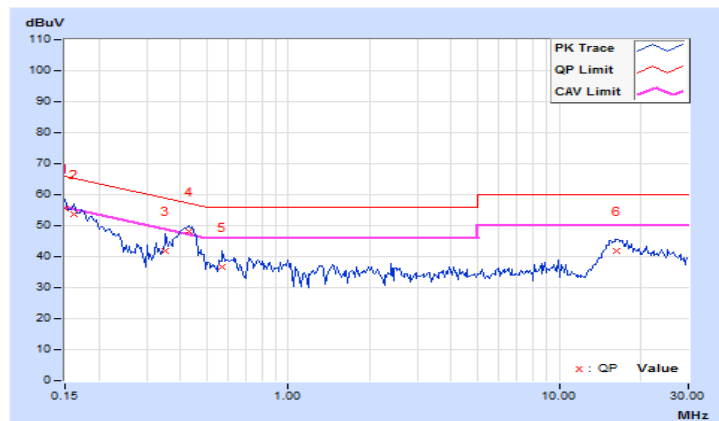

Phase	Neutral (N)	Detector Function	Quasi-Peak (QP) / Average (AV)
-------	-------------	-------------------	--------------------------------

No	Freq.	Corr.	Reading Value		Emission Level		Limit		Margin	
	[MHz]	Factor	[dB (uV)]		[dB (uV)]		[dB (uV)]		(dB)	
		(dB)	Q.P.	AV.	Q.P.	AV.	Q.P.	AV.	Q.P.	AV.
1	0.15000	10.08	45.79	30.30	55.87	40.38	66.00	56.00	-10.13	-15.62
2	0.15781	10.07	44.43	29.33	54.50	39.40	65.58	55.58	-11.08	-16.18
3	0.17734	10.06	41.11	26.51	51.17	36.57	64.61	54.61	-13.44	-18.04
4	0.22031	10.05	35.87	24.03	45.92	34.08	62.81	52.81	-16.89	-18.73
5	0.43125	10.12	39.82	31.40	49.94	41.52	57.23	47.23	-7.29	-5.71
6	16.43750	11.09	31.30	25.91	42.39	37.00	60.00	50.00	-17.61	-13.00

REMARKS:

1. Q.P. and AV. are abbreviations of quasi-peak and average individually.
2. The emission levels of other frequencies were very low against the limit.
3. Margin value = Emission level - Limit value
4. Correction factor = Insertion loss + Cable loss
5. Emission Level = Correction Factor + Reading Value.

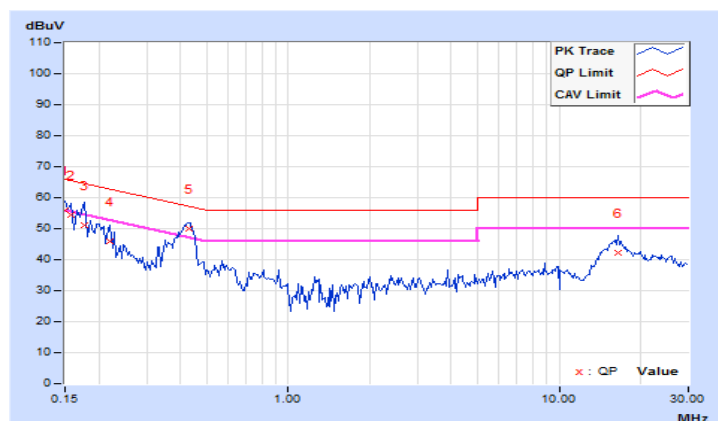

4.2.10 Test Results (Mode 4)

Phase	Line (L)	Detector Function	Quasi-Peak (QP) / Average (AV)
-------	----------	-------------------	--------------------------------

No	Freq. [MHz]	Corr. Factor	Reading Value [dB (uV)]		Emission Level [dB (uV)]		Limit [dB (uV)]		Margin (dB)	
		(dB)	Q.P.	AV.	Q.P.	AV.	Q.P.	AV.	Q.P.	AV.
	1	0.15391	10.08	44.44	28.80	54.52	38.88	65.79	55.79	-11.27
2	0.16172	10.08	43.87	28.24	53.95	38.32	65.38	55.38	-11.43	-17.06
3	0.21641	10.07	36.06	23.30	46.13	33.37	62.96	52.96	-16.83	-19.59
4	0.43125	10.12	36.65	29.17	46.77	39.29	57.23	47.23	-10.46	-7.94
5	0.57188	10.13	24.72	16.13	34.85	26.26	56.00	46.00	-21.15	-19.74
6	16.42969	11.31	28.97	23.60	40.28	34.91	60.00	50.00	-19.72	-15.09

REMARKS:

1. Q.P. and AV. are abbreviations of quasi-peak and average individually.
2. The emission levels of other frequencies were very low against the limit.
3. Margin value = Emission level - Limit value
4. Correction factor = Insertion loss + Cable loss
5. Emission Level = Correction Factor + Reading Value.

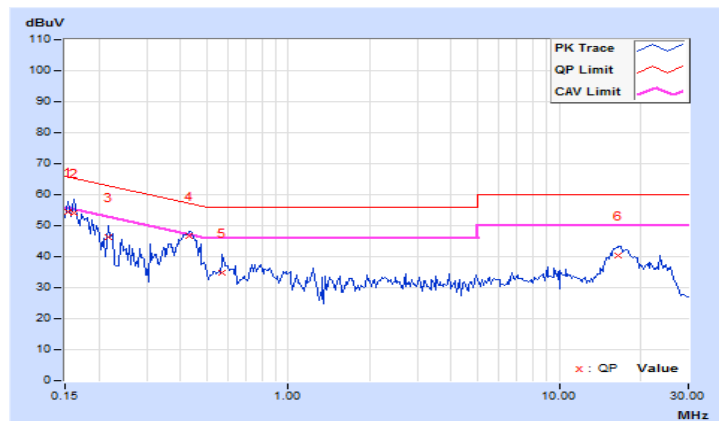

Phase	Neutral (N)	Detector Function	Quasi-Peak (QP) / Average (AV)
-------	-------------	-------------------	--------------------------------

No	Freq. [MHz]	Corr. Factor	Reading Value [dB (uV)]		Emission Level [dB (uV)]		Limit [dB (uV)]		Margin (dB)	
		(dB)	Q.P.	AV.	Q.P.	AV.	Q.P.	AV.	Q.P.	AV.
	1	0.15000	10.08	44.84	29.63	54.92	39.71	66.00	56.00	-11.08
2	0.18516	10.05	39.71	27.48	49.76	37.53	64.25	54.25	-14.49	-16.72
3	0.22422	10.05	35.38	21.84	45.43	31.89	62.66	52.66	-17.23	-20.77
4	0.31406	10.09	25.83	13.55	35.92	23.64	59.86	49.86	-23.94	-26.22
5	0.34141	10.10	30.09	19.81	40.19	29.91	59.17	49.17	-18.98	-19.26
6	0.43125	10.12	39.14	31.71	49.26	41.83	57.23	47.23	-7.97	-5.40
7	16.88672	11.12	29.64	24.34	40.76	35.46	60.00	50.00	-19.24	-14.54

REMARKS:

1. Q.P. and AV. are abbreviations of quasi-peak and average individually.
2. The emission levels of other frequencies were very low against the limit.
3. Margin value = Emission level - Limit value
4. Correction factor = Insertion loss + Cable loss
5. Emission Level = Correction Factor + Reading Value.

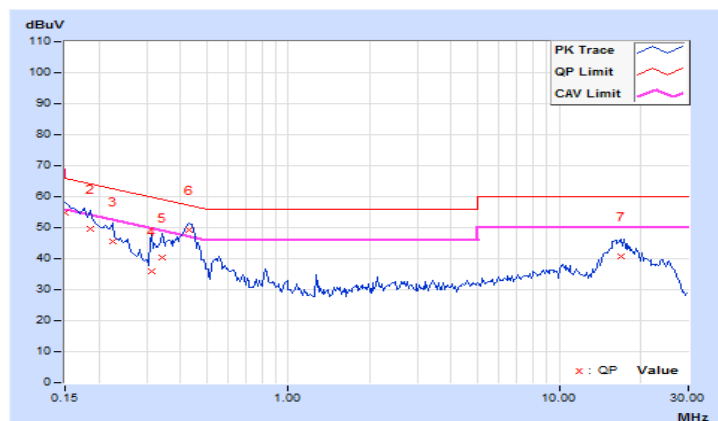

4.3 Transmit Power Measurement

4.3.1 Limits of Transmit Power Measurement

Operation Band	EUT Category		Limit
U-NII-1		Outdoor Access Point	1 Watt (30 dBm) (Max. e.i.r.p \leq 125mW(21 dBm) at any elevation angle above 30 degrees as measured from the horizon)
		Fixed point-to-point Access Point	1 Watt (30 dBm)
	√	Indoor Access Point	1 Watt (30 dBm)
		Client device	250mW (24 dBm)
U-NII-2A	---		250mW (24 dBm) or 11 dBm+10 log B*
U-NII-2C	---		250mW (24 dBm) or 11 dBm+10 log B*
U-NII-3	√		1 Watt (30 dBm)

*B is the 26 dB emission bandwidth in megahertz

Per KDB 662911 Method of conducted output power measurement on IEEE 802.11 devices,

Array Gain = 0 dB (i.e., no array gain) for $N_{ANT} \leq 4$;

Array Gain = 0 dB (i.e., no array gain) for channel widths ≥ 40 MHz for any N_{ANT} ;

Array Gain = $5 \log(N_{ANT}/N_{SS})$ dB or 3 dB, whichever is less for 20-MHz channel widths with $N_{ANT} \geq 5$.

For power measurements on all other devices: Array Gain = $10 \log(N_{ANT}/N_{SS})$ dB.

4.3.2 Test Setup

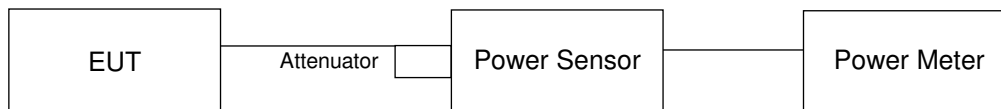

4.3.3 Test Instruments

Refer to section 4.1.2 to get information of above instrument.

4.3.4 Test Procedure

Method PM is used to perform output power measurement, trigger and gating function of wide band power meter is enabled to measure max output power of TX on burst. Duty factor is not added to measured value.

4.3.5 Deviation from Test Standard

No deviation.

4.3.6 EUT Operating Condition

The software provided by client to enable the EUT under transmission condition continuously at lowest, middle and highest channel frequencies individually.

4.3.7 Test Result

Radio 1

CDD Mode

802.11a

Chan.	Chan. Freq. (MHz)	Maximum Conducted Power (dBm)		Total Power (mW)	Total Power (dBm)	Limit (dBm)	Pass / Fail
		Chain 0	Chain 1				
36	5180	22.60	22.65	366.047	25.64	30.00	Pass
40	5200	25.60	25.49	717.075	28.56	30.00	Pass
48	5240	23.03	23.12	406.025	26.09	30.00	Pass

802.11ac (VHT20)

Chan.	Chan. Freq. (MHz)	Maximum Conducted Power (dBm)		Total Power (mW)	Total Power (dBm)	Limit (dBm)	Pass / Fail
		Chain 0	Chain 1				
36	5180	22.62	22.65	366.887	25.65	30.00	Pass
40	5200	25.71	25.53	729.665	28.63	30.00	Pass
48	5240	22.91	22.86	388.631	25.90	30.00	Pass

802.11ac (VHT40)

Chan.	Chan. Freq. (MHz)	Maximum Conducted Power (dBm)		Total Power (mW)	Total Power (dBm)	Limit (dBm)	Pass / Fail
		Chain 0	Chain 1				
38	5190	19.30	19.31	170.424	22.32	30.00	Pass
46	5230	23.82	23.39	459.264	26.62	30.00	Pass

802.11ac (VHT80)

Chan.	Chan. Freq. (MHz)	Maximum Conducted Power (dBm)		Total Power (mW)	Total Power (dBm)	Limit (dBm)	Pass / Fail
		Chain 0	Chain 1				
42	5210	19.68	19.63	184.73	22.67	30.00	Pass

Beamforming Mode

802.11a

Chan.	Chan. Freq. (MHz)	Maximum Conducted Power (dBm)		Total Power (mW)	Total Power (dBm)	Limit (dBm)	Pass / Fail
		Chain 0	Chain 1				
36	5180	22.60	22.65	366.047	25.64	29.26	Pass
40	5200	25.60	25.49	717.075	28.56	29.26	Pass
48	5240	23.03	23.12	406.025	26.09	29.26	Pass

Note: 1. Directional gain = $10 \log[(10^{G0/20} + 10^{G1/20})^2 / 2] = 6.74\text{dBi} > 6\text{dBi}$, so the power limit shall be reduced to $30 - (6.74 - 6) = 29.26\text{dBm}$.

802.11ac (VHT20)

Chan.	Chan. Freq. (MHz)	Maximum Conducted Power (dBm)		Total Power (mW)	Total Power (dBm)	Limit (dBm)	Pass / Fail
		Chain 0	Chain 1				
36	5180	22.62	22.65	366.887	25.65	29.26	Pass
40	5200	25.71	25.53	729.665	28.63	29.26	Pass
48	5240	22.91	22.86	388.631	25.90	29.26	Pass

Note: 1. Directional gain = $10 \log[(10^{G0/20} + 10^{G1/20})^2 / 2] = 6.74\text{dBi} > 6\text{dBi}$, so the power limit shall be reduced to $30 - (6.74 - 6) = 29.26\text{dBm}$.

802.11ac (VHT40)

Chan.	Chan. Freq. (MHz)	Maximum Conducted Power (dBm)		Total Power (mW)	Total Power (dBm)	Limit (dBm)	Pass / Fail
		Chain 0	Chain 1				
38	5190	19.30	19.31	170.424	22.32	29.26	Pass
46	5230	23.82	23.39	459.264	26.62	29.26	Pass

Note: 1. Directional gain = $10 \log[(10^{G0/20} + 10^{G1/20})^2 / 2]$ = 6.74dBi > 6dBi , so the power limit shall be reduced to $30-(6.74-6) = 29.26$ dBm.

802.11ac (VHT80)

Chan.	Chan. Freq. (MHz)	Maximum Conducted Power (dBm)		Total Power (mW)	Total Power (dBm)	Limit (dBm)	Pass / Fail
		Chain 0	Chain 1				
42	5210	19.68	19.63	184.73	22.67	29.26	Pass

Note: 1. Directional gain = $10 \log[(10^{G0/20} + 10^{G1/20})^2 / 2]$ = 6.74dBi > 6dBi , so the power limit shall be reduced to $30-(6.74-6) = 29.26$ dBm.

Radio 2
CDD Mode
802.11a

Chan.	Chan. Freq. (MHz)	Maximum Conducted Power (dBm)		Total Power (mW)	Total Power (dBm)	Limit (dBm)	Pass / Fail
		Chain 0	Chain 1				
149	5745	25.86	26.44	826.033	29.17	30.00	Pass
157	5785	26.02	26.47	843.554	29.26	30.00	Pass
165	5825	25.97	26.25	817.064	29.12	30.00	Pass

802.11ac (VHT20)

Chan.	Chan. Freq. (MHz)	Maximum Conducted Power (dBm)		Total Power (mW)	Total Power (dBm)	Limit (dBm)	Pass / Fail
		Chain 0	Chain 1				
149	5745	25.53	26.23	777.032	28.90	30.00	Pass
157	5785	25.74	26.24	795.7	29.01	30.00	Pass
165	5825	25.65	25.97	762.649	28.82	30.00	Pass

802.11ac (VHT40)

Chan.	Chan. Freq. (MHz)	Maximum Conducted Power (dBm)		Total Power (mW)	Total Power (dBm)	Limit (dBm)	Pass / Fail
		Chain 0	Chain 1				
151	5755	26.69	27.12	981.888	29.92	30.00	Pass
159	5795	26.81	27.11	993.777	29.97	30.00	Pass

802.11ac (VHT80)

Chan.	Chan. Freq. (MHz)	Maximum Conducted Power (dBm)		Total Power (mW)	Total Power (dBm)	Limit (dBm)	Pass / Fail
		Chain 0	Chain 1				
155	5775	22.21	22.50	344.169	25.37	30.00	Pass

Beamforming Mode

802.11a

Chan.	Chan. Freq. (MHz)	Maximum Conducted Power (dBm)		Total Power (mW)	Total Power (dBm)	Limit (dBm)	Pass / Fail
		Chain 0	Chain 1				
149	5745	25.86	26.44	826.033	29.17	29.28	Pass
157	5785	26.02	26.47	843.554	29.26	29.28	Pass
165	5825	25.97	26.25	817.064	29.12	29.28	Pass

Note: 1. Directional gain = $10 \log[(10^{G0/20} + 10^{G1/20})^2 / 2] = 6.72\text{dBi} > 6\text{dBi}$, so the power limit shall be reduced to $30 - (6.72 - 6) = 29.28\text{dBm}$.

802.11ac (VHT20)

Chan.	Chan. Freq. (MHz)	Maximum Conducted Power (dBm)		Total Power (mW)	Total Power (dBm)	Limit (dBm)	Pass / Fail
		Chain 0	Chain 1				
149	5745	25.53	26.23	777.032	28.90	29.28	Pass
157	5785	25.74	26.24	795.7	29.01	29.28	Pass
165	5825	25.65	25.97	762.649	28.82	29.28	Pass

Note: 1. Directional gain = $10 \log[(10^{G0/20} + 10^{G1/20})^2 / 2] = 6.72\text{dBi} > 6\text{dBi}$, so the power limit shall be reduced to $30 - (6.72 - 6) = 29.28\text{dBm}$.

802.11ac (VHT40)

Chan.	Chan. Freq. (MHz)	Maximum Conducted Power (dBm)		Total Power (mW)	Total Power (dBm)	Limit (dBm)	Pass / Fail
		Chain 0	Chain 1				
151	5755	25.69	26.12	779.942	28.92	29.28	Pass
159	5795	25.81	26.11	789.385	28.97	29.28	Pass

Note: 1. Directional gain = $10 \log[(10^{G0/20} + 10^{G1/20})^2 / 2] = 6.72\text{dBi} > 6\text{dBi}$, so the power limit shall be reduced to $30 - (6.72 - 6) = 29.28\text{dBm}$.

802.11ac (VHT80)

Chan.	Chan. Freq. (MHz)	Maximum Conducted Power (dBm)		Total Power (mW)	Total Power (dBm)	Limit (dBm)	Pass / Fail
		Chain 0	Chain 1				
155	5775	22.21	22.50	344.169	25.37	29.28	Pass

Note: 1. Directional gain = $10 \log[(10^{G0/20} + 10^{G1/20})^2 / 2] = 6.72\text{dBi} > 6\text{dBi}$, so the power limit shall be reduced to $30 - (6.72 - 6) = 29.28\text{dBm}$.

4.4 Occupied Bandwidth Measurement

4.4.1 Test Setup

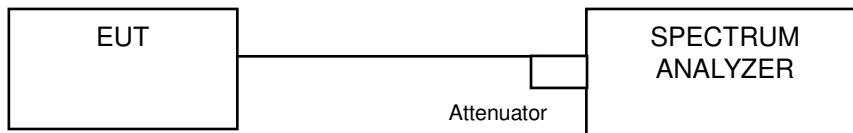

4.4.2 Test Instruments

Refer to section 4.1.2 to get information of above instrument.

4.4.3 Test Procedure

The transmitter output was connected to the spectrum analyzer through an attenuator. The bandwidth of the fundamental frequency was measured by spectrum analyzer with resolution bandwidth in the range of 1% to 5% of the anticipated emission bandwidth, and a video bandwidth at least 3x the resolution bandwidth and set the detector to SAMPLE. The width of a frequency band such that, below the lower and above the upper frequency limits, the mean powers emitted are each equal to a specified percentage 0.5 %of the total mean power of a given emission.

4.4.4 Test Results

Radio 1

802.11a

Channel	Channel Frequency (MHz)	Occupied Bandwidth (MHz)	
		Chain 0	Chain 1
36	5180	16.68	16.68
40	5200	24.12	20.52
48	5240	16.56	16.68

802.11ac (VHT20)

Channel	Channel Frequency (MHz)	Occupied Bandwidth (MHz)	
		Chain 0	Chain 1
36	5180	17.88	17.88
40	5200	24.60	21.48
48	5240	17.88	17.88

802.11ac (VHT40)

Channel	Channel Frequency (MHz)	Occupied Bandwidth (MHz)	
		Chain 0	Chain 1
38	5190	36.48	36.24
46	5230	36.72	36.24

802.11ac (VHT80)

Channel	Channel Frequency (MHz)	Occupied Bandwidth (MHz)	
		Chain 0	Chain 1
42	5210	75.84	75.84

Spectrum Plot of Worst Value

802.11a_Chain0 / CH40

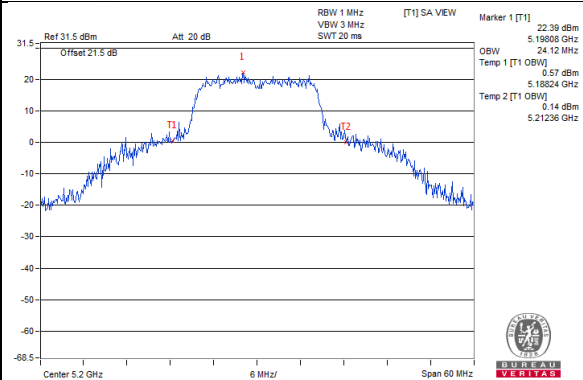

802.11ac (VHT20)_Chain0 / CH40

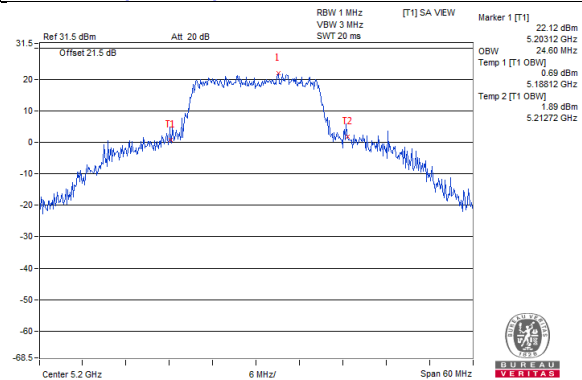

802.11ac (VHT40)_Chain0 / CH46

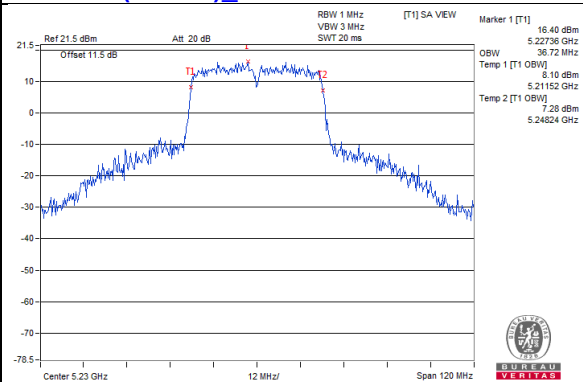

802.11ac (VHT80)_Chain0 / CH42

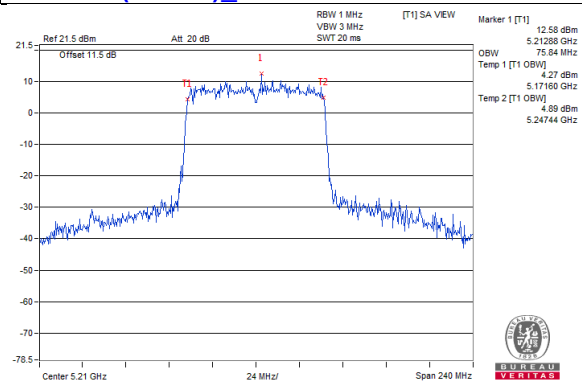

Radio 2
802.11a

Channel	Channel Frequency (MHz)	Occupied Bandwidth (MHz)	
		Chain 0	Chain 1
149	5745	26.76	32.40
157	5785	36.12	38.76
165	5825	38.64	38.16

802.11ac (VHT20)

Channel	Channel Frequency (MHz)	Occupied Bandwidth (MHz)	
		Chain 0	Chain 1
149	5745	27.24	32.28
157	5785	38.16	41.04
165	5825	42.00	40.80

802.11ac (VHT40)

Channel	Channel Frequency (MHz)	Occupied Bandwidth (MHz)	
		Chain 0	Chain 1
151	5755	52.56	55.44
159	5795	73.20	72.00

802.11ac (VHT80)

Channel	Channel Frequency (MHz)	Occupied Bandwidth (MHz)	
		Chain 0	Chain 1
155	5775	76.80	77.76

Spectrum Plot of Worst Value

802.11a_Chain1 / CH157

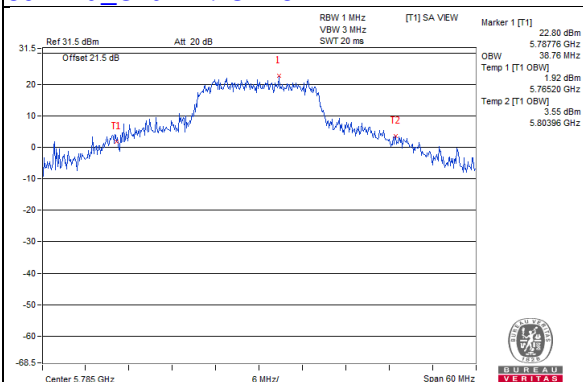

802.11ac (VHT20)_Chain0 / CH165

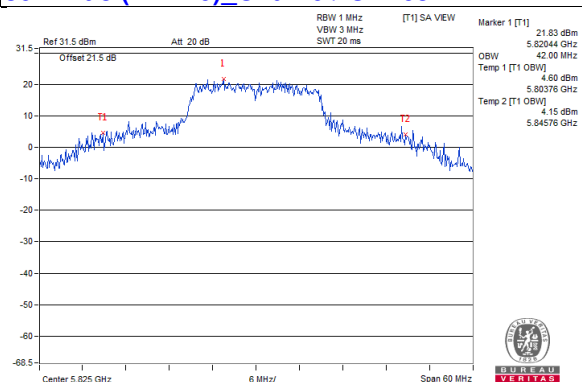

802.11ac (VHT40)_Chain0 / CH159

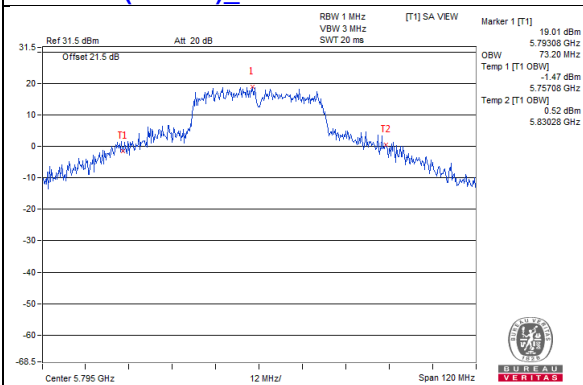

802.11ac (VHT80)_Chain1 / CH155

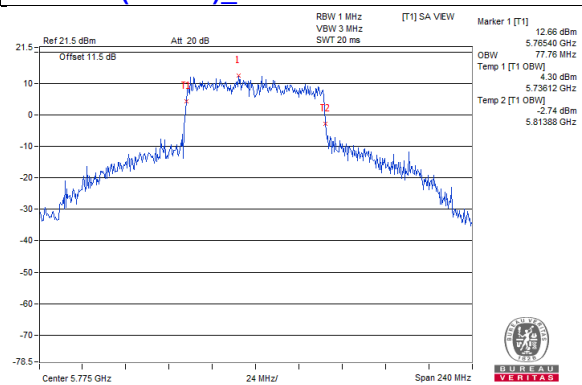

Spectrum Plot for near by DFS band (DFS is required, if 99% OCP straddle into U-NII-2A band)

802.11a_Chain0 / CH48

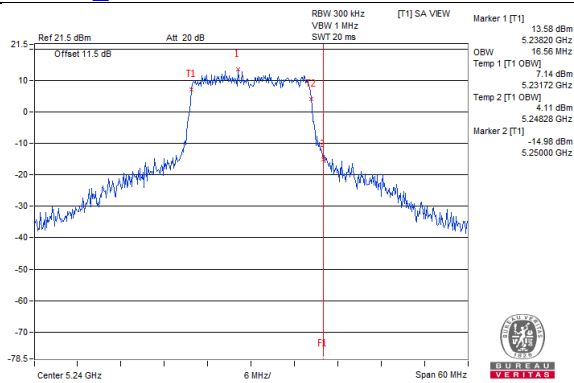

802.11a_Chain1 / CH48

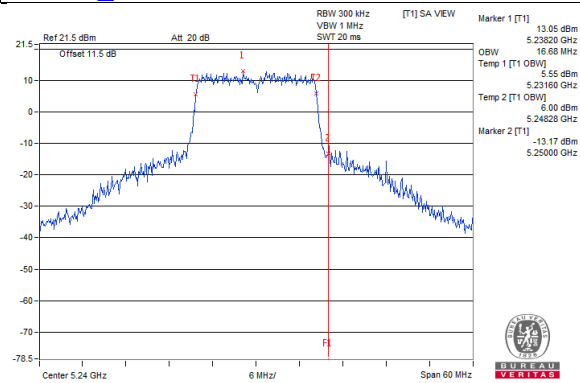

802.11ac(VHT20)_Chain0 / CH48

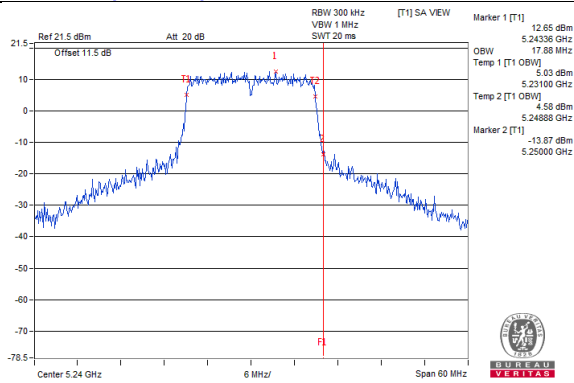

802.11ac(VHT20)_Chain1 / CH48

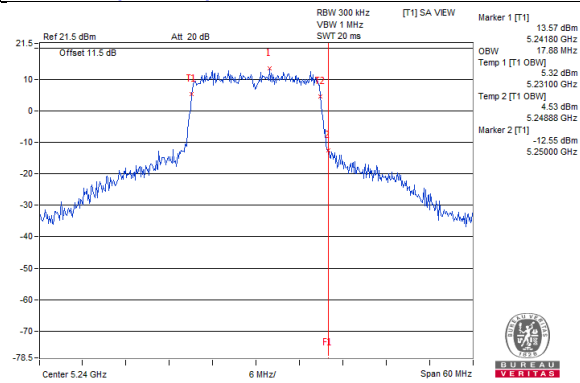

Spectrum Plot for near by DFS band (DFS is required, if 99% OCP straddle into U-NII-2A band)

802.11ac(VHT40)_Chain0 / CH46

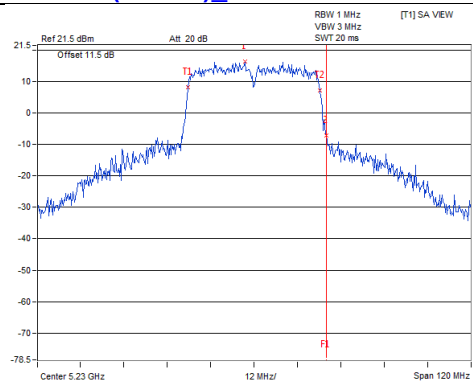

802.11ac(VHT40)_Chain1 / CH46

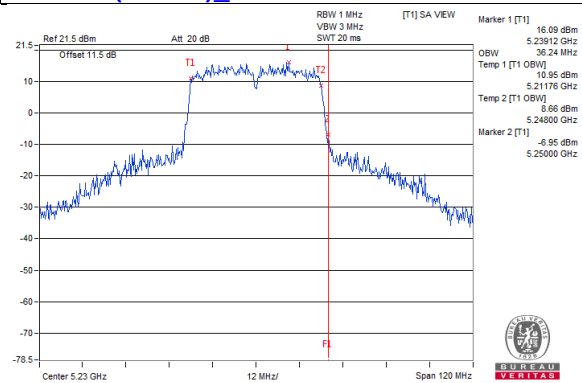

802.11ac(VHT80)_Chain0 / CH42

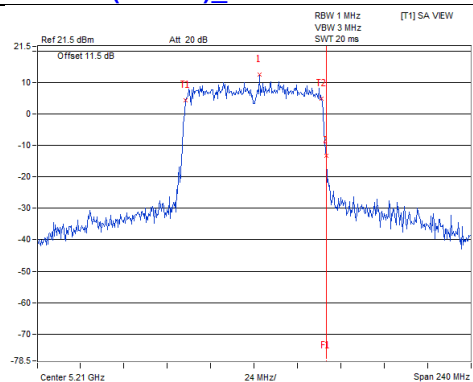

802.11ac(VHT80)_Chain1 / CH42

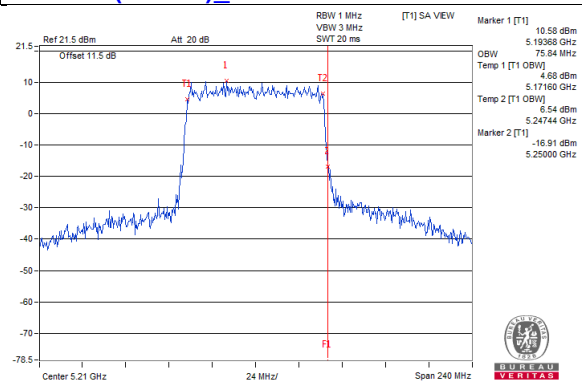

Spectrum Plot for near by DFS band (DFS is required, if 99% OCP straddle into U-NII-2C band)

802.11a_Chain0 / CH149

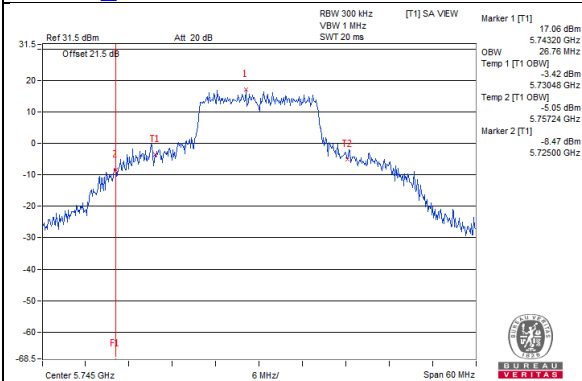

802.11a_Chain1 / CH149

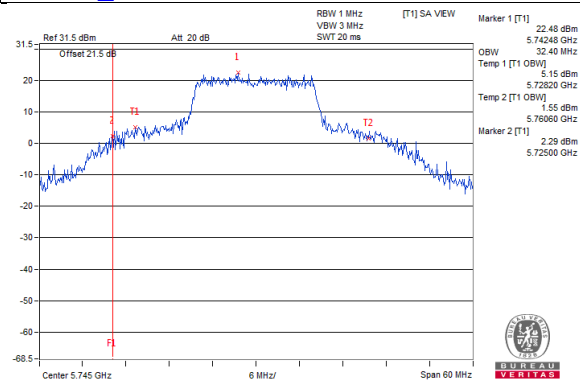

802.11ac(VHT20)_Chain0 / CH149

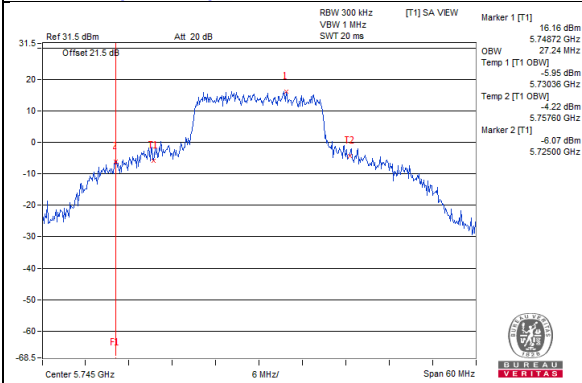

802.11ac(VHT20)_Chain1 / CH149

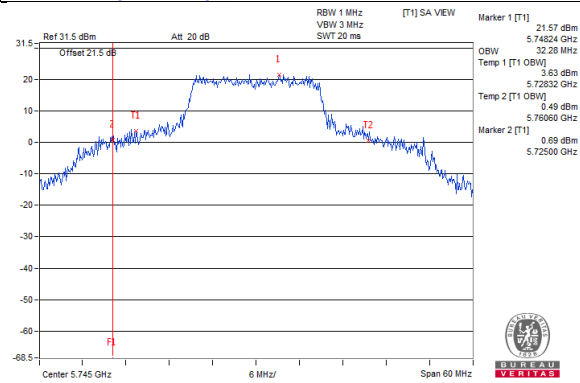

**Spectrum Plot for near by DFS band
(DFS is required, if 99% OCP straddle into U-NII-2C band)**

802.11ac(VHT40)_Chain0 / CH151

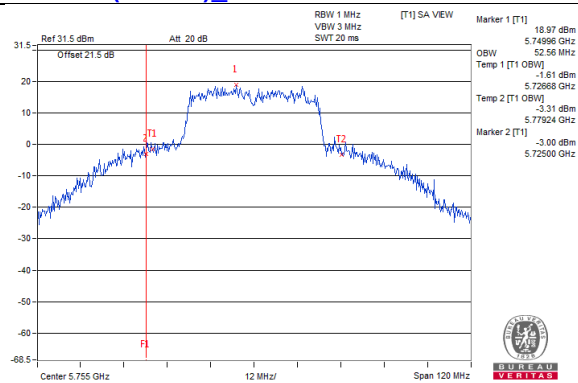

802.11ac(VHT40)_Chain1 / CH151

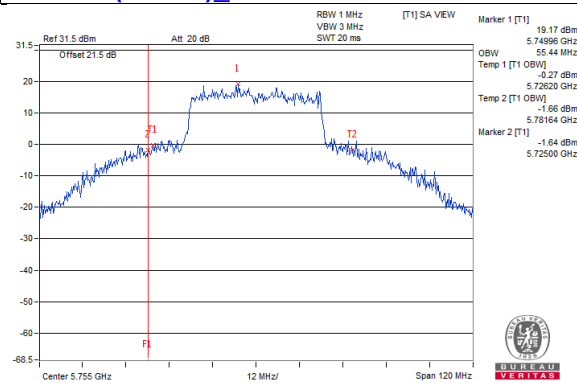

802.11ac(VHT80)_Chain0 / CH155

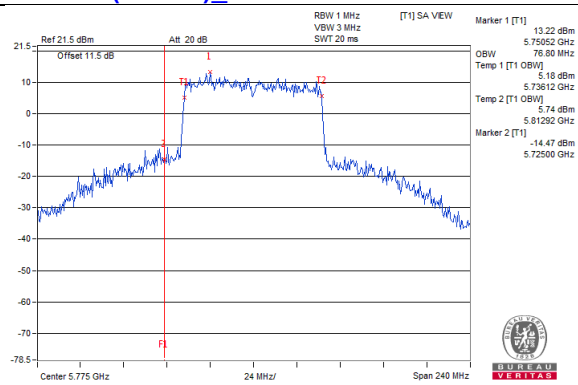

802.11ac(VHT80)_Chain1 / CH155

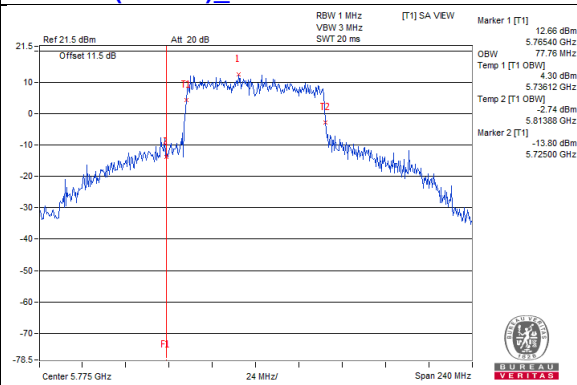

4.5 Peak Power Spectral Density Measurement

4.5.1 Limits of Peak Power Spectral Density Measurement

Operation Band	EUT Category		Limit
U-NII-1		Outdoor Access Point	17dBm/ MHz
		Fixed point-to-point Access Point	
	√	Indoor Access Point	
		Client device	11dBm/ MHz
U-NII-2A	---		11dBm/ MHz
U-NII-2C	---		11dBm/ MHz
U-NII-3	√		30dBm/ 500kHz

4.5.2 Test Setup

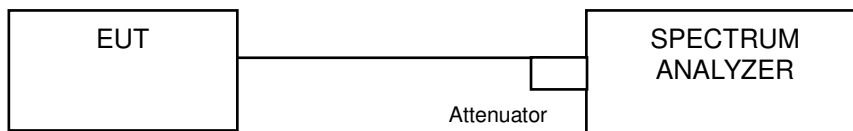

4.5.3 Test Instruments

Refer to section 4.1.2 to get information of above instrument.

4.5.4 Test Procedure

802.11ac (VHT20)

For U-NII-1:

Using method SA-1

1. Set span to encompass the entire emission bandwidth (EBW) of the signal.
2. Set RBW = 1 MHz, Set VBW \geq 3 MHz, Detector = RMS
3. Sweep time = auto, trigger set to "free run".
4. Trace average at least 100 traces in power averaging mode.
5. Record the max value

For U-NII-3:

1. Set span to encompass the entire emission bandwidth (EBW) of the signal.
2. Set RBW = 300 kHz, Set VBW \geq 1 MHz, Detector = RMS
3. Use the peak marker function to determine the maximum power level in any 300 kHz band segment within the fundamental EBW.
4. Scale the observed power level to an equivalent value in 500 kHz by adjusting (reducing) the measured power by a bandwidth correction factor (BWCF) where $BWCF = 10\log(500 \text{ kHz}/300\text{kHz})$
5. Sweep time = auto, trigger set to "free run".
6. Trace average at least 100 traces in power averaging mode.
7. Record the max value

802.11a, 802.11ac (VHT40), 802.11ac (VHT80)

For U-NII-1:

Using method SA-2

1. Set span to encompass the entire emission bandwidth (EBW) of the signal.
2. Set RBW = 1 MHz, Set VBW \geq 3 MHz, Detector = RMS
3. Sweep time = auto, trigger set to "free run".
4. Trace average at least 100 traces in power averaging mode.
5. Record the max value and add $10 \log (1/\text{duty cycle})$

For U-NII-3:

1. Set span to encompass the entire emission bandwidth (EBW) of the signal.
2. Set RBW = 300 kHz, Set VBW \geq 1 MHz, Detector = RMS
3. Use the peak marker function to determine the maximum power level in any 300 kHz band segment within the fundamental EBW.
4. Scale the observed power level to an equivalent value in 500 kHz by adjusting (reducing) the measured power by a bandwidth correction factor (BWCF) where $BWCF = 10\log(500 \text{ kHz}/300\text{kHz})$
5. Sweep time = auto, trigger set to "free run".
6. Trace average at least 100 traces in power averaging mode.
7. Record the max value and add $10 \log (1/\text{duty cycle})$

4.5.5 Deviation from Test Standard

No deviation.

4.5.6 EUT Operating Condition

Same as Item 4.3.6.

4.5.7 Test Results

For U-NII-1:

802.11a

Chan.	Chan. Freq. (MHz)	PSD W/O Duty Factor (dBm)		Duty Factor (dB)	Total PSD With Duty Factor (dBm)	MAX. Limit (dBm)	Pass / Fail
		Chain 0	Chain 1				
36	5180	8.53	8.55	0.16	11.71	16.26	Pass
40	5200	11.87	10.97	0.16	14.62	16.26	Pass
48	5240	8.40	8.69	0.16	11.72	16.26	Pass

- Note:** 1. Method a) of power density measurement of KDB 662911 is using for calculating total power density. Total power density is summing entire spectra across corresponding frequency bins on the various outputs by computer.
2. Directional gain = $10 \log[(10^{G0/20} + 10^{G1/20})^2 / 2] = 6.74\text{dBi} > 6\text{dBi}$, so the power density limit shall be reduced to $17-(6.74-6) = 16.26\text{dBm}$.
3. Refer to section 3.3 for duty cycle spectrum plot.

802.11ac (VHT20)

Chan.	Chan. Freq. (MHz)	PSD (dBm/MHz)		Total Power Density (dBm/MHz)	MAX. Limit (dBm/MHz)	Pass / Fail
		Chain 0	Chain 1			
36	5180	8.45	8.47	11.47	16.26	Pass
40	5200	11.57	11.31	14.45	16.26	Pass
48	5240	8.24	8.56	11.41	16.26	Pass

- Note:** 1. Method a) of power density measurement of KDB 662911 is using for calculating total power density. Total power density is summing entire spectra across corresponding frequency bins on the various outputs by computer.
2. Directional gain = $10 \log[(10^{G0/20} + 10^{G1/20})^2 / 2] = 6.74\text{dBi} > 6\text{dBi}$, so the power density limit shall be reduced to $17-(6.74-6) = 16.26\text{dBm}$.

802.11ac (VHT40)

Chan.	Chan. Freq. (MHz)	PSD W/O Duty Factor (dBm)		Duty Factor (dB)	Total PSD With Duty Factor (dBm)	MAX. Limit (dBm)	Pass / Fail
		Chain 0	Chain 1				
38	5190	3.10	2.63	0.16	6.04	16.26	Pass
46	5230	6.03	5.86	0.16	9.11	16.26	Pass

- Note:**
- Method a) of power density measurement of KDB 662911 is using for calculating total power density. Total power density is summing entire spectra across corresponding frequency bins on the various outputs by computer.
 - Directional gain = $10 \log[(10^{G0/20} + 10^{G1/20})^2 / 2] = 6.74\text{dBi} > 6\text{dBi}$, so the power density limit shall be reduced to $17 - (6.74 - 6) = 16.26\text{dBm}$.
 - Refer to section 3.3 for duty cycle spectrum plot.

802.11ac (VHT80)

Chan.	Chan. Freq. (MHz)	PSD W/O Duty Factor (dBm)		Duty Factor (dB)	Total PSD With Duty Factor (dBm)	MAX. Limit (dBm)	Pass / Fail
		Chain 0	Chain 1				
42	5210	-0.85	-0.48	0.28	2.63	16.26	Pass

- Note:**
- Method a) of power density measurement of KDB 662911 is using for calculating total power density. Total power density is summing entire spectra across corresponding frequency bins on the various outputs by computer.
 - Directional gain = $10 \log[(10^{G0/20} + 10^{G1/20})^2 / 2] = 6.74\text{dBi} > 6\text{dBi}$, so the power density limit shall be reduced to $17 - (6.74 - 6) = 16.26\text{dBm}$.
 - Refer to section 3.3 for duty cycle spectrum plot.

Spectrum Plot of Worst Value

802.11a_Chain 0 / CH40

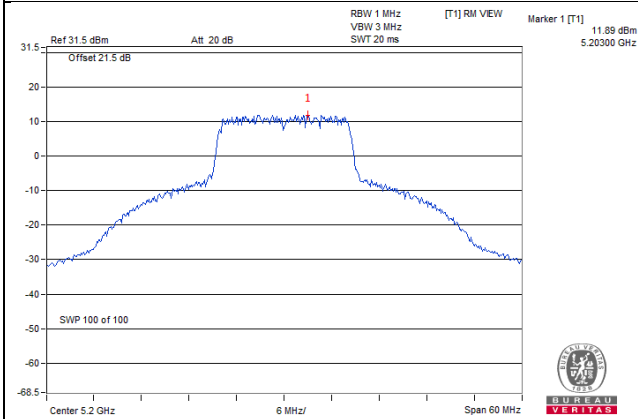

802.11ac (VHT20)_Chain 0 / CH40

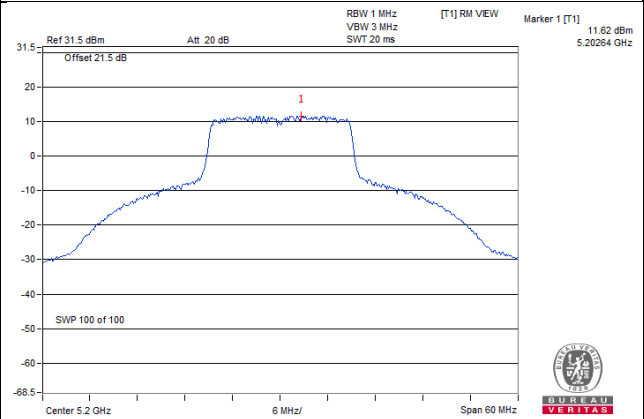

802.11ac (VHT40)_Chain 0 / CH46

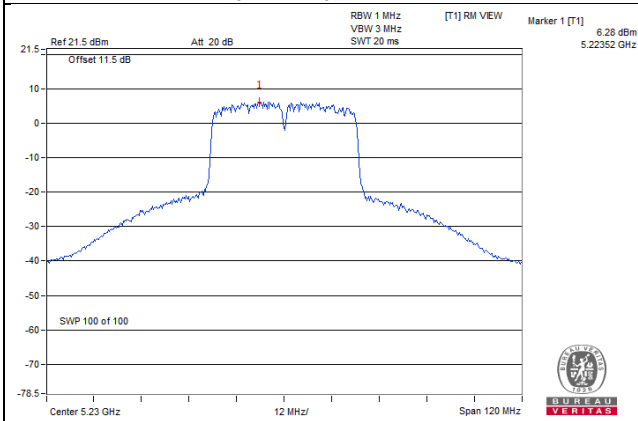

802.11ac (VHT80)_Chain 1 / CH42

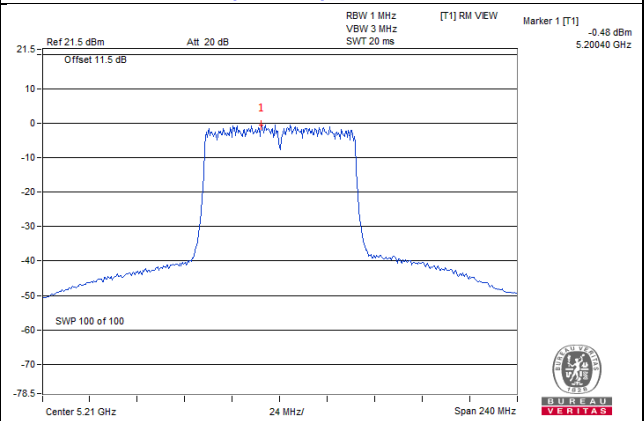

For U-NII-3:
802.11a

TX chain	Chan.	Chan. Freq. (MHz)	PSD W/O Duty Factor		10 log (N=2) dB	Duty Factor (dB)	Total PSD With Duty Factor (dBm/500kHz)	Limit (dBm/500kHz)	Pass /Fail
			(dBm/300kHz)	(dBm/500kHz)					
0	149	5745	3.81	6.03	3.01	0.16	9.20	29.28	Pass
	157	5785	4.12	6.34	3.01	0.16	9.51	29.28	Pass
	165	5825	3.77	5.99	3.01	0.16	9.16	29.28	Pass
1	149	5745	3.95	6.17	3.01	0.16	9.34	29.28	Pass
	157	5785	3.88	6.10	3.01	0.16	9.27	29.28	Pass
	165	5825	3.31	5.53	3.01	0.16	8.70	29.28	Pass

Note: 1. Directional gain = $10 \log[(10^{G1/20} + 10^{G2/20})^2 / 2] = 6.72\text{dBi} > 6\text{dBi}$, so the power density limit shall be reduced to $30-(6.72-6) = 29.28\text{dBm}$.

2. Refer to section 3.3 for duty cycle spectrum plot.

802.11ac (VHT20)

TX chain	Channel	Freq. (MHz)	PSD (dBm/300kHz)	PSD (dBm/500kHz)	10 log (N=2) dB	Total PSD (dBm/500kHz)	Limit (dBm/500kHz)	Pass /Fail
0	149	5745	3.43	5.65	3.01	8.66	29.28	Pass
	157	5785	3.59	5.81	3.01	8.82	29.28	Pass
	165	5825	3.31	5.53	3.01	8.54	29.28	Pass
1	149	5745	3.91	6.13	3.01	9.14	29.28	Pass
	157	5785	3.51	5.73	3.01	8.74	29.28	Pass
	165	5825	3.01	5.23	3.01	8.24	29.28	Pass

Note: 1. Directional gain = $10 \log[(10^{G1/20} + 10^{G2/20})^2 / 2] = 6.72\text{dBi} > 6\text{dBi}$, so the power density limit shall be reduced to $30-(6.72-6) = 29.28\text{dBm}$.

802.11ac (VHT40)

TX chain	Chan.	Chan. Freq. (MHz)	PSD W/O Duty Factor		10 log (N=2) dB	Duty Factor (dB)	Total PSD With Duty Factor (dBm/500kHz)	Limit (dBm/500kHz)	Pass /Fail
			(dBm/300kHz)	(dBm/500kHz)					
0	151	5755	0.42	2.64	3.01	0.16	5.81	29.28	Pass
	159	5795	0.37	2.59	3.01	0.16	5.76	29.28	Pass
1	151	5755	0.39	2.61	3.01	0.16	5.78	29.28	Pass
	159	5795	0.20	2.42	3.01	0.16	5.59	29.28	Pass

Note: 1. Directional gain = $10 \log[(10^{G1/20} + 10^{G2/20})^2 / 2] = 6.72\text{dBi} > 6\text{dBi}$, so the power density limit shall be reduced to $30-(6.72-6) = 29.28\text{dBm}$.

2. Refer to section 3.3 for duty cycle spectrum plot.

802.11ac (VHT80)

TX chain	Chan.	Chan. Freq. (MHz)	PSD W/O Duty Factor		10 log (N=2) dB	Duty Factor (dB)	Total PSD With Duty Factor (dBm/500kHz)	Limit (dBm/500kHz)	Pass /Fail
			(dBm/300kHz)	(dBm/500kHz)					
0	155	5775	-6.15	-3.93	3.01	0.28	-0.64	29.28	Pass
1	155	5775	-6.94	-4.72	3.01	0.28	-1.43	29.28	Pass

Note: 1. Directional gain = $10 \log[(10^{G1/20} + 10^{G2/20})^2 / 2] = 6.72\text{dBi} > 6\text{dBi}$, so the power density limit shall be reduced to $30-(6.72-6) = 29.28\text{dBm}$.

2. Refer to section 3.3 for duty cycle spectrum plot.

Spectrum Plot of Worst Value

802.11a – Chain 0: CH 157

802.11a (VHT20) – Chain 1: CH 149

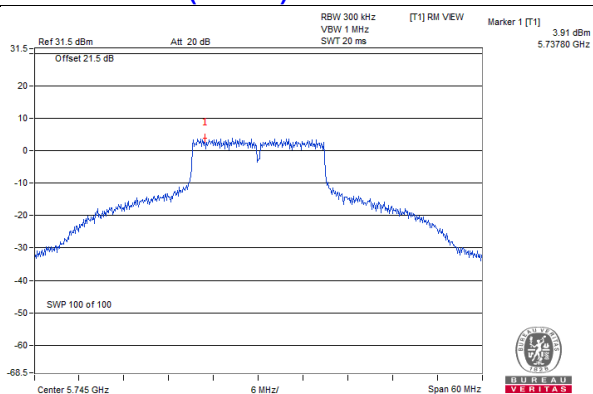
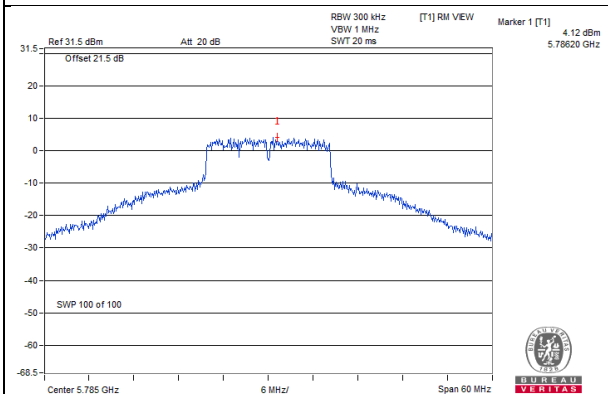

802.11ac (VHT40) – Chain 0: CH 151

802.11ac (VHT80) – Chain 0: CH 155

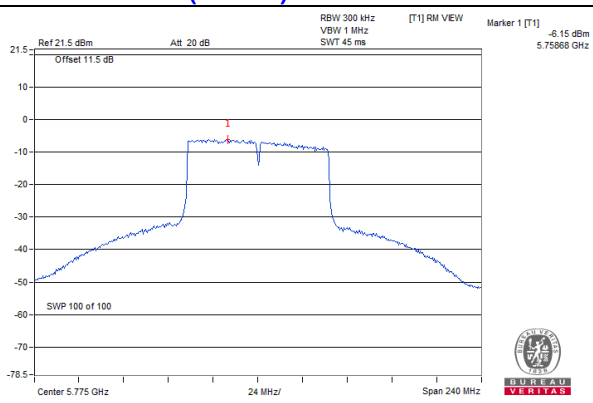
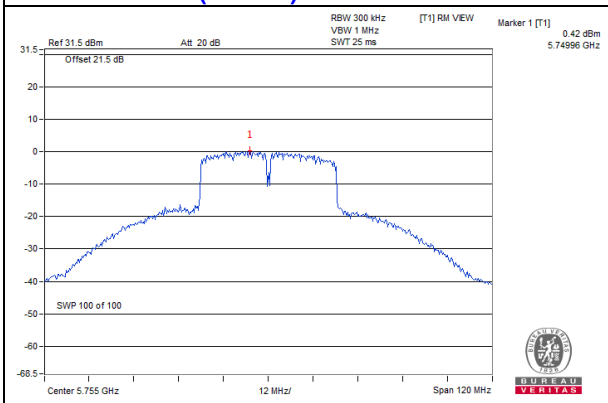

4.6 Frequency Stability Measurement

4.6.1 Limits of Frequency Stability Measurement

The frequency of the carrier signal shall be maintained within band of operation

4.6.2 Test Setup

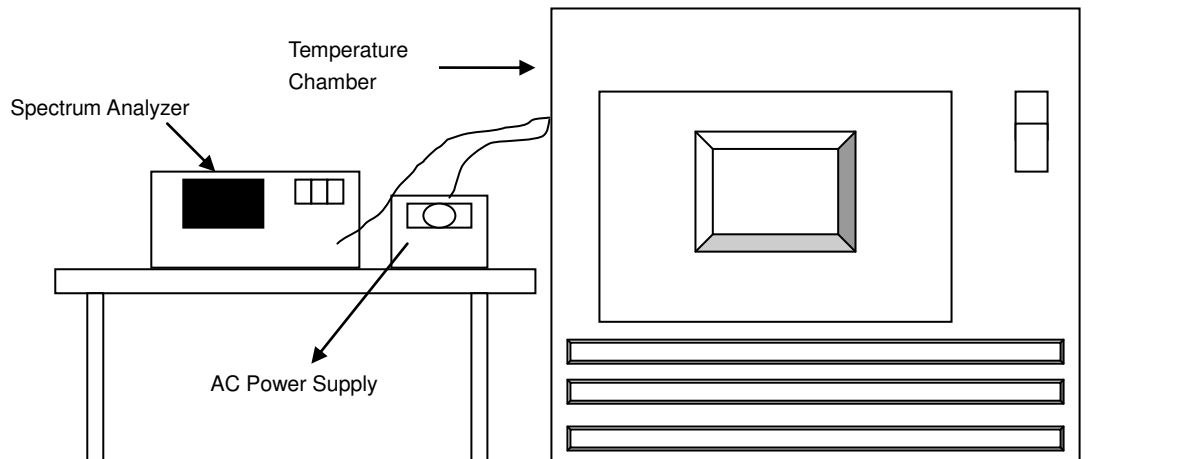

4.6.3 Test Instruments

Refer to section 4.1.2 to get information of above instrument.

4.6.4 Test Procedure

- The EUT was placed inside the environmental test chamber and powered by nominal AC voltage.
- Turn the EUT on and couple its output to a spectrum analyzer.
- Turn the EUT off and set the chamber to the highest temperature specified.
- Allow sufficient time (approximately 30 min) for the temperature of the chamber to stabilize, turn the EUT on and measure the operating frequency after 2, 5, and 10 Minutes.
- Repeat step 2 and 3 with the temperature chamber set to the lowest temperature.
- The test chamber was allowed to stabilize at +20 degree C for a minimum of 30 Minutes. The supply voltage was then adjusted on the EUT from 85% to 115% and the frequency record.

4.6.5 Deviation from Test Standard

No deviation.

4.6.6 EUT Operating Condition

Set the EUT transmit at un-modulation mode to test frequency stability.

4.6.7 Test Results

For U-NII-1:

Frequency Stability Versus Temp.									
Operating Frequency: 5180 MHz									
TEMP. (°C)	Power Supply (Vac)	0 Minute		2 Minutes		5 Minutes		10 Minutes	
		Measured Frequency (MHz)	Pass/Fail	Measured Frequency (MHz)	Pass/Fail	Measured Frequency (MHz)	Pass/Fail	Measured Frequency (MHz)	Pass/Fail
50	120	5179.9902	PASS	5179.988	PASS	5179.9888	PASS	5179.9916	PASS
40	120	5179.9937	PASS	5179.997	PASS	5179.9981	PASS	5179.9979	PASS
30	120	5179.9904	PASS	5179.9918	PASS	5179.9919	PASS	5179.9898	PASS
20	120	5180.0191	PASS	5180.0166	PASS	5180.0176	PASS	5180.0208	PASS
10	120	5179.9834	PASS	5179.9859	PASS	5179.986	PASS	5179.9821	PASS
0	120	5180.0007	PASS	5180.0012	PASS	5179.9971	PASS	5180.0013	PASS
-10	120	5179.9959	PASS	5179.995	PASS	5179.9937	PASS	5179.9947	PASS
-20	120	5180.0253	PASS	5180.0235	PASS	5180.0261	PASS	5180.0241	PASS
-30	120	5180.0109	PASS	5180.0098	PASS	5180.0102	PASS	5180.0111	PASS

Frequency Stability Versus Voltage									
Operating Frequency: 5180 MHz									
TEMP. (°C)	Power Supply (Vac)	0 Minute		2 Minutes		5 Minutes		10 Minutes	
		Measured Frequency (MHz)	Pass/Fail	Measured Frequency (MHz)	Pass/Fail	Measured Frequency (MHz)	Pass/Fail	Measured Frequency (MHz)	Pass/Fail
20	138	5180.02	PASS	5180.0165	PASS	5180.0186	PASS	5180.0205	PASS
	120	5180.0191	PASS	5180.0166	PASS	5180.0176	PASS	5180.0208	PASS
	102	5180.0182	PASS	5180.0168	PASS	5180.0181	PASS	5180.0208	PASS

For U-NII-3:

Frequency Stability Versus Temp.									
Operating Frequency: 5745 MHz									
TEMP. (°C)	Power Supply (Vac)	0 Minute		2 Minutes		5 Minutes		10 Minutes	
		Measured Frequency (MHz)	Pass/Fail	Measured Frequency (MHz)	Pass/Fail	Measured Frequency (MHz)	Pass/Fail	Measured Frequency (MHz)	Pass/Fail
50	120	5745.015	PASS	5745.0157	PASS	5745.0134	PASS	5745.0132	PASS
40	120	5745.0246	PASS	5745.0223	PASS	5745.0231	PASS	5745.0218	PASS
30	120	5745.0104	PASS	5745.013	PASS	5745.0134	PASS	5745.0122	PASS
20	120	5745.0104	PASS	5745.0088	PASS	5745.0082	PASS	5745.0114	PASS
10	120	5744.9846	PASS	5744.9851	PASS	5744.9867	PASS	5744.9884	PASS
0	120	5744.9991	PASS	5744.9976	PASS	5744.9982	PASS	5744.9966	PASS
-10	120	5744.9986	PASS	5745.0018	PASS	5745.0026	PASS	5744.9988	PASS
-20	120	5744.9939	PASS	5744.9922	PASS	5744.9899	PASS	5744.9922	PASS
-30	120	5744.989	PASS	5744.9917	PASS	5744.9863	PASS	5744.9864	PASS

Frequency Stability Versus Voltage									
Operating Frequency: 5745 MHz									
TEMP. (°C)	Power Supply (Vac)	0 Minute		2 Minutes		5 Minutes		10 Minutes	
		Measured Frequency (MHz)	Pass/Fail	Measured Frequency (MHz)	Pass/Fail	Measured Frequency (MHz)	Pass/Fail	Measured Frequency (MHz)	Pass/Fail
20	138	5745.01	PASS	5745.009	PASS	5745.0074	PASS	5745.0125	PASS
	120	5745.0104	PASS	5745.0088	PASS	5745.0082	PASS	5745.0114	PASS
	102	5745.0107	PASS	5745.0098	PASS	5745.0087	PASS	5745.0103	PASS

4.7 6dB Bandwidth Measurement

4.7.1 Limits of 6dB Bandwidth Measurement

The minimum of 6dB Bandwidth Measurement is 0.5MHz.

4.7.2 Test Setup

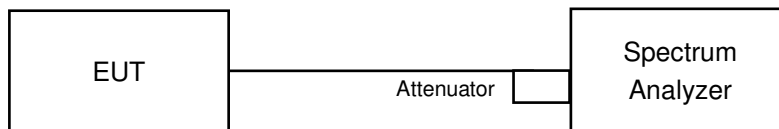

4.7.3 Test Instruments

Refer to section 4.1.2 to get information of above instrument.

4.7.4 Test Procedure

MEASUREMENT PROCEDURE REF

- a. Set resolution bandwidth (RBW) = 100kHz
- b. Set the video bandwidth (VBW) $\geq 3 \times$ RBW, Detector = Peak.
- c. Trace mode = max hold.
- d. Sweep = auto couple.
- e. Measure the maximum width of the emission that is constrained by the frequencies associated with the two amplitude points (upper and lower) that are attenuated by 6 dB relative to the maximum level measured in the fundamental emission

4.7.5 Deviation from Test Standard

No deviation.

4.7.6 EUT Operating Condition

The software provided by client to enable the EUT under transmission condition continuously at lowest, middle and highest channel frequencies individually.

4.7.7 Test Results

802.11a

Channel	Frequency (MHz)	6dB Bandwidth (MHz)		Minimum Limit (MHz)	Pass / Fail
		Chain 0	Chain 1		
149	5745	16.37	16.41	0.5	PASS
157	5785	16.37	16.40	0.5	PASS
165	5825	16.40	16.35	0.5	PASS

802.11ac (VHT20)

Channel	Frequency (MHz)	6dB Bandwidth (MHz)		Minimum Limit (MHz)	Pass / Fail
		Chain 0	Chain 1		
149	5745	17.62	17.66	0.5	PASS
157	5785	17.65	17.66	0.5	PASS
165	5825	17.61	17.65	0.5	PASS

802.11ac (VHT40)

Channel	Frequency (MHz)	6dB Bandwidth (MHz)		Minimum Limit (MHz)	Pass / Fail
		Chain 0	Chain 1		
151	5755	33.30	35.40	0.5	PASS
159	5795	32.04	35.11	0.5	PASS

802.11ac (VHT80)

Channel	Frequency (MHz)	6dB Bandwidth (MHz)		Minimum Limit (MHz)	Pass / Fail
		Chain 0	Chain 1		
155	5775	75.59	74.76	0.5	PASS

Spectrum Plot of Worst Value

802.11a_Chain 1 / CH165

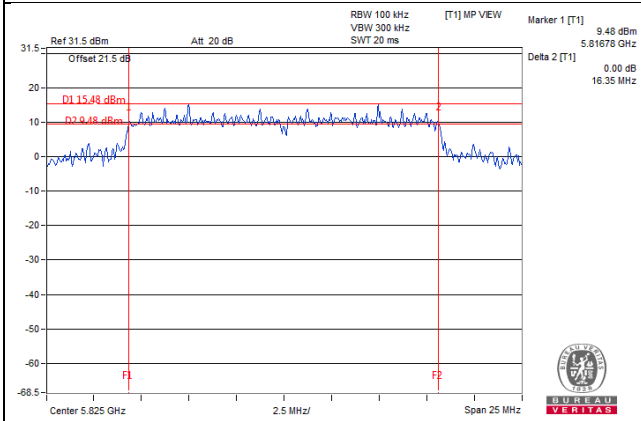

802.11ac (VHT20)_Chain 0 / CH165

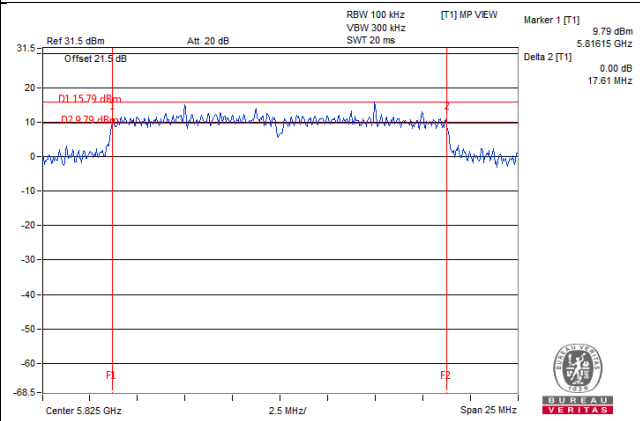

802.11ac (VHT40)_Chain 0 / CH159

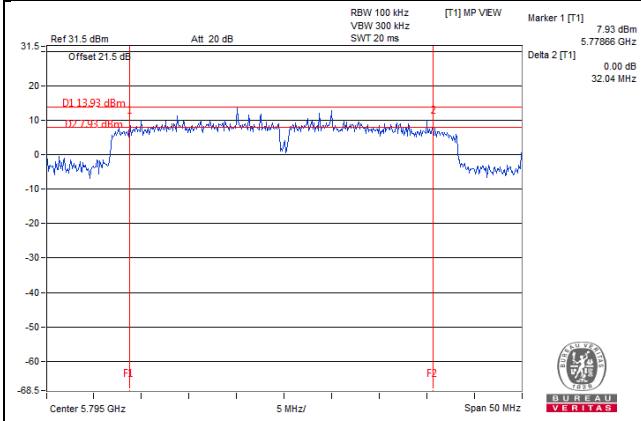

802.11ac (VHT80)_Chain 1 / CH155

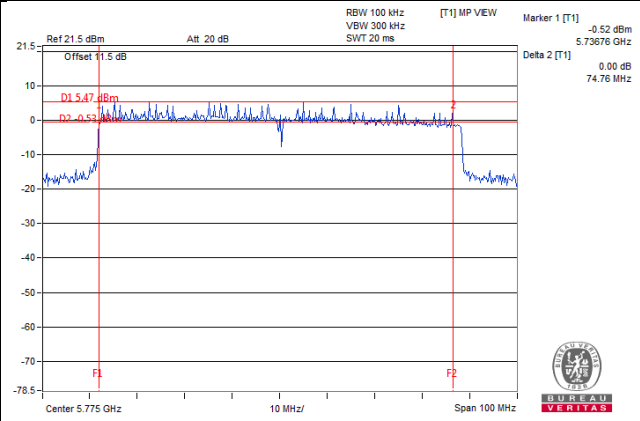

5 Pictures of Test Arrangements

Please refer to the attached file (Test Setup Photo).

Annex A- Radiated Out of Band Emission (OOBE) Measurement (For U-NII-3 band)

802.11a

CH 149 5745 MHz

Horizontal

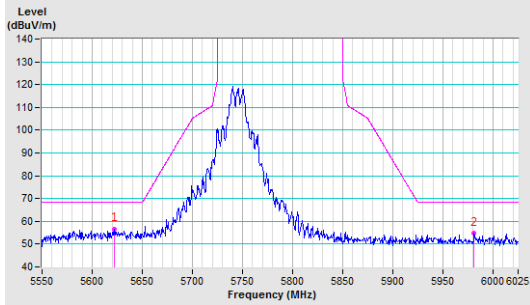

Vertical

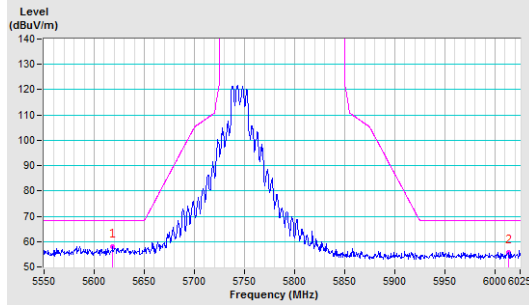

CH 157 5785 MHz

Horizontal

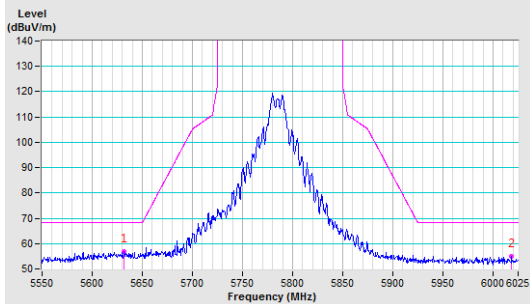

Vertical

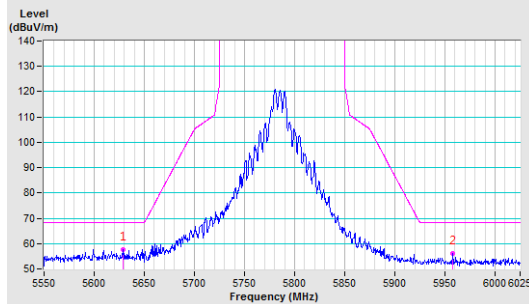

CH 165 5825 MHz

Horizontal

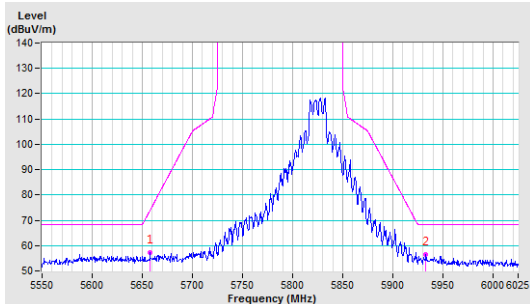

Vertical

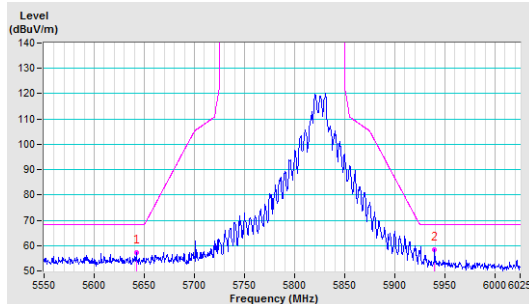

802.11ac (VHT20)

CH 149 5745 MHz

Horizontal

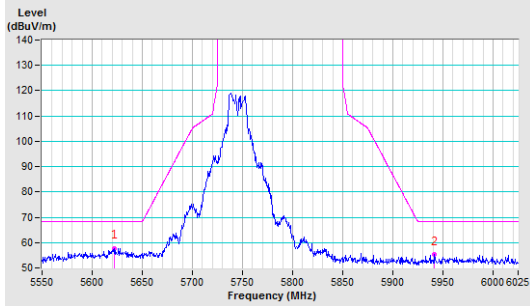

Vertical

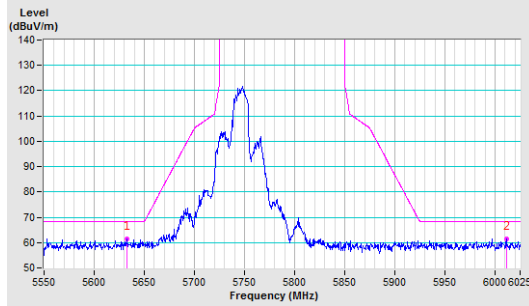

CH 157 5785 MHz

Horizontal

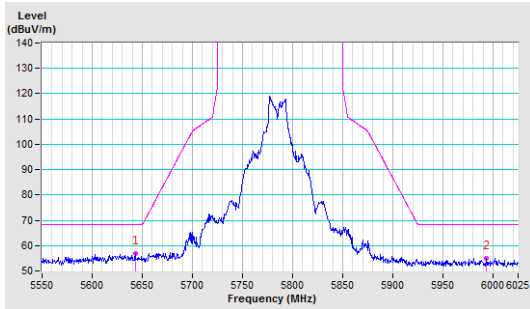

Vertical

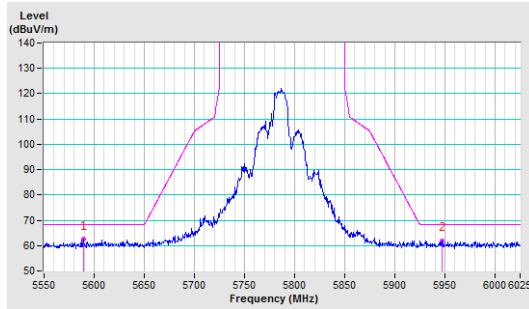

CH 165 5825 MHz

Horizontal

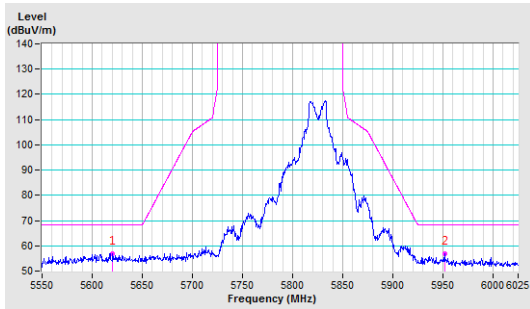

Vertical

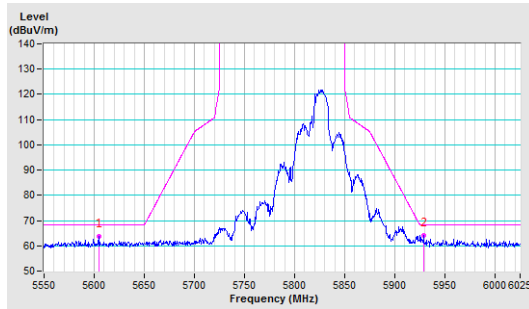

802.11ac (VHT40)

CH 151 5755 MHz

Horizontal

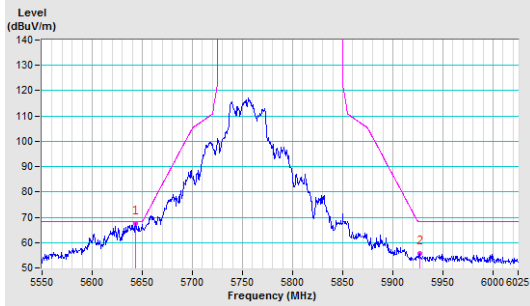

Vertical

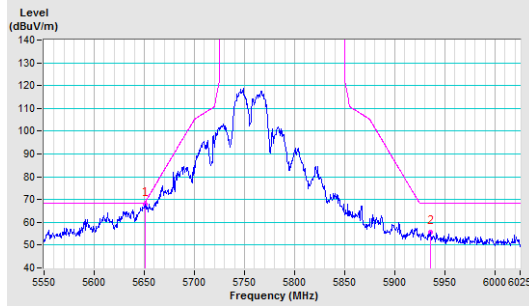

CH 159 5795 MHz

Horizontal

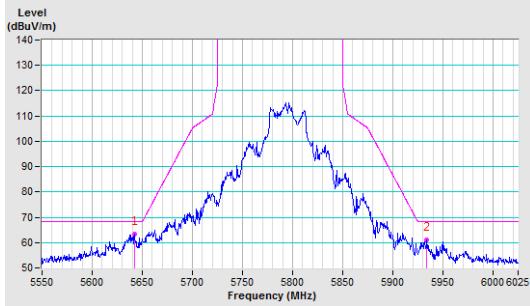

Vertical

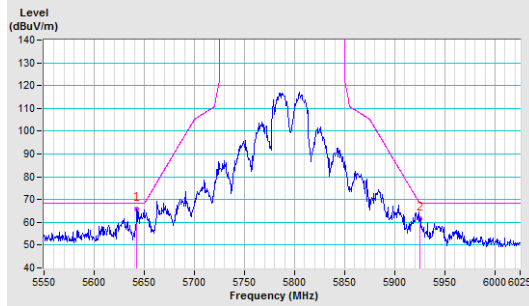

802.11ac (VHT80)

CH 155 5775 MHz

Horizontal

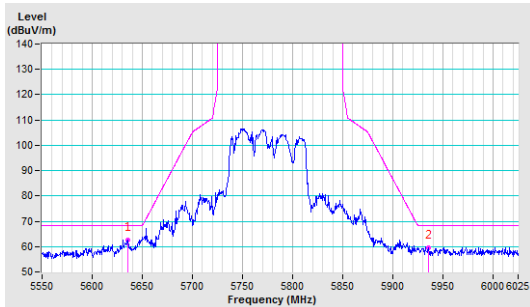

Vertical

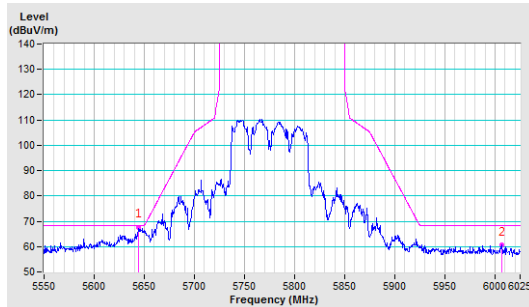

Appendix – Information on the Testing Laboratories

We, Bureau Veritas Consumer Products Services (H.K.) Ltd., Taoyuan Branch, were founded in 1988 to provide our best service in EMC, Radio, Telecom and Safety consultation. Our laboratories are FCC recognized accredited test firms and accredited according to ISO/IEC 17025.

If you have any comments, please feel free to contact us at the following:

Linkou EMC/RF Lab

Tel: 886-2-26052180

Fax: 886-2-26051924

Hsin Chu EMC/RF/Telecom Lab

Tel: 886-3-6668565

Fax: 886-3-6668323

Hwa Ya EMC/RF/Safety Lab

Tel: 886-3-3183232

Fax: 886-3-3270892

Email: service.adt@tw.bureauveritas.com

Web Site: www.bureauveritas-adt.com

The address and road map of all our labs can be found in our web site also.

--- END ---