

FCC Test Report

Report No.: RF180627E05-1

FCC ID: Q87-03367

Test Model: WHW01P

Series Model: VLP01P, A01P

Received Date: June 27, 2018

Test Date: July 04 to 18, 2018

Issued Date: Aug. 23, 2018

Applicant: Linksys LLC

Address: 121 Theory Drive, Irvine, CA 92617, USA

Issued By: Bureau Veritas Consumer Products Services (H.K.) Ltd., Taoyuan Branch
Hsin Chu Laboratory

Lab Address: E-2, No.1, Li Hsin 1st Road, Hsinchu Science Park, Hsinchu City 300,
Taiwan R.O.C.

Test Location (1): E-2, No.1, Li Hsin 1st Road, Hsinchu Science Park, Hsinchu City 300,
Taiwan R.O.C.

Test Location (2): No. 49, Ln. 206, Wende Rd., Shangshan Tsuen, Chiung Lin Hsiang, Hsin
Chu Hsien 307, Taiwan R.O.C.

**FCC Registration /
Designation Number:** 723255 / TW2022 for Test Location (1)
736135 / TW0004 for Test Location (2)



This report is for your exclusive use. Any copying or replication of this report to or for any other person or entity, or use of our name or trademark, is permitted only with our prior written permission. This report sets forth our findings solely with respect to the test samples identified herein. The results set forth in this report are not indicative or representative of the quality or characteristics of the lot from which a test sample was taken or any similar or identical product unless specifically and expressly noted. Our report includes all of the tests requested by you and the results thereof based upon the information that you provided to us. You have 60 days from date of issuance of this report to notify us of any material error or omission caused by our negligence, provided, however, that such notice shall be in writing and shall specifically address the issue you wish to raise. A failure to raise such issue within the prescribed time shall constitute your unqualified acceptance of the completeness of this report, the tests conducted and the correctness of the report contents. Unless specific mention, the uncertainty of measurement has been explicitly taken into account to declare the compliance or non-compliance to the specification. The report must not be used by the client to claim product certification, approval, or endorsement by TAF or any government agencies.

Table of Contents

Release Control Record	4
1 Certificate of Conformity	5
2 Summary of Test Results	6
2.1 Measurement Uncertainty	6
2.2 Modification Record	6
3 General Information	7
3.1 General Description of EUT	7
3.2 Description of Test Modes	10
3.2.1 Test Mode Applicability and Tested Channel Detail	11
3.3 Duty Cycle of Test Signal	13
3.4 Description of Support Units	14
3.4.1 Configuration of System under Test	14
3.5 General Description of Applied Standard	15
4 Test Types and Results	16
4.1 Radiated Emission and Bandedge Measurement	16
4.1.1 Limits of Radiated Emission and Bandedge Measurement	16
4.1.2 Test Instruments	17
4.1.3 Test Procedure	19
4.1.4 Deviation from Test Standard	19
4.1.5 Test Setup	20
4.1.6 EUT Operating Condition	21
4.1.7 Test Results	22
4.2 Conducted Emission Measurement	41
4.2.1 Limits of Conducted Emission Measurement	41
4.2.2 Test Instruments	41
4.2.3 Test Procedure	42
4.2.4 Deviation from Test Standard	42
4.2.5 Test Setup	42
4.2.6 EUT Operating Condition	42
4.2.7 Test Results	43
4.3 Transmit Power Measurement	45
4.3.1 Limits of Transmit Power Measurement	45
4.3.2 Test Setup	45
4.3.3 Test Instruments	45
4.3.4 Test Procedure	45
4.3.5 Deviation from Test Standard	45
4.3.6 EUT Operating Condition	45
4.3.7 Test Result	46
4.4 Occupied Bandwidth Measurement	48
4.4.1 Test Setup	48
4.4.2 Test Instruments	48
4.4.3 Test Procedure	48
4.4.4 Test Results	49
4.5 Peak Power Spectral Density Measurement	53
4.5.1 Limits of Peak Power Spectral Density Measurement	53
4.5.2 Test Setup	53
4.5.3 Test Instruments	53
4.5.4 Test Procedure	54
4.5.5 Deviation from Test Standard	54
4.5.6 EUT Operating Condition	54
4.5.7 Test Results	55
4.6 Frequency Stability Measurement	61
4.6.1 Limits of Frequency Stability Measurement	61

4.6.2	Test Setup.....	61
4.6.3	Test Instruments	61
4.6.4	Test Procedure	61
4.6.5	Deviation from Test Standard	61
4.6.6	EUT Operating Condition	61
4.6.7	Test Results	62
4.7	6dB Bandwidth Measurement	63
4.7.1	Limits of 6dB Bandwidth Measurement.....	63
4.7.2	Test Setup.....	63
4.7.3	Test Instruments	63
4.7.4	Test Procedure	63
4.7.5	Deviation from Test Standard	63
4.7.6	EUT Operating Condition	63
4.7.7	Test Results	64
5	Pictures of Test Arrangements.....	66
	Annex A- Radiated Out of Band Emission (OOBE) Measurement (For U-NII-3 band)	67
	Appendix – Information on the Testing Laboratories	71

Release Control Record

Issue No.	Description	Date Issued
RF180627E05-1	Original release.	Aug. 23, 2018

1 Certificate of Conformity

Product: Velop Plug-In
Brand: Linksys
Test Model: WHW01P
Series Model: VLP01P, A01P
Sample Status: ENGINEERING SAMPLE
Applicant: Linksys LLC
Test Date: July 04 to 18, 2018
Standard: 47 CFR FCC Part 15, Subpart E (Section 15.407)
ANSI C63.10: 2013

The above equipment has been tested by **Bureau Veritas Consumer Products Services (H.K.) Ltd., Taoyuan Branch**, and found compliance with the requirement of the above standards. The test record, data evaluation & Equipment Under Test (EUT) configurations represented herein are true and accurate accounts of the measurements of the sample's EMC characteristics under the conditions specified in this report.

Prepared by : Mary Ko , **Date:** Aug. 23, 2018
Mary Ko / Specialist

Approved by : May Chen , **Date:** Aug. 23, 2018
May Chen / Manager

2 Summary of Test Results

47 CFR FCC Part 15, Subpart E (Section 15.407)			
FCC Clause	Test Item	Result	Remarks
15.407(b)(6)	AC Power Conducted Emissions	PASS	Meet the requirement of limit. Minimum passing margin is -3.02dB at 0.61484MHz.
15.407(b) (1/2/3/4(i/ii)/6)	Radiated Emissions & Band Edge Measurement*	PASS	Meet the requirement of limit. Minimum passing margin is -0.1dB at 5150.00MHz, 5649.00MHz, 5649.90MHz and 5932.17MHz.
15.407(a)(1/2/3)	Max Average Transmit Power	PASS	Meet the requirement of limit.
---	Occupied Bandwidth Measurement	-	Reference only.
15.407(a)(1/2/3)	Peak Power Spectral Density	PASS	Meet the requirement of limit.
15.407(e)	6dB bandwidth	PASS	Meet the requirement of limit. (U-NII-3 Band only)
15.407(g)	Frequency Stability	PASS	Meet the requirement of limit.
15.203	Antenna Requirement	PASS	Antenna connector is U.FL not a standard connector.

*For U-NII-3 band compliance with rule part 15.407(b)(4)(i), the OOB test plots were recorded in Annex A.

2.1 Measurement Uncertainty

Where relevant, the following measurement uncertainty levels have been estimated for tests performed on the EUT as specified in CISPR 16-4-2:

Measurement	Frequency	Expanded Uncertainty (k=2) (±)
Conducted Emissions at mains ports	150kHz ~ 30MHz	1.84 dB
Radiated Emissions up to 1 GHz	30MHz ~ 1GHz	5.33 dB
Radiated Emissions above 1 GHz	1GHz ~ 6GHz	5.10 dB
	6GHz ~ 18GHz	4.85 dB
	18GHz ~ 40GHz	5.24 dB

2.2 Modification Record

There were no modifications required for compliance.

3 General Information

3.1 General Description of EUT

Product	Velop Plug-In
Brand	Linksys
Test Model	WHW01P
Series Model	VLP01P, A01P
Driver version	1.1.6.189558
Status of EUT	ENGINEERING SAMPLE
Power Supply Rating	AC100~240V
Modulation Type	CCK, DQPSK, DBPSK for DSSS 64QAM, 16QAM, QPSK, BPSK for OFDM 256QAM for OFDM in 11ac mode and VHT (20/40) mode in 2.4GHz
Modulation Technology	DSSS, OFDM
Transfer Rate	802.11b: up to 11Mbps 802.11a/g: up to 54Mbps 802.11n: up to 300Mbps 802.11ac: up to 866.7Mbps
Operating Frequency	2.4GHz: 2.412 ~ 2.462GHz 5GHz: 5.18GHz ~ 5.24GHz, 5.745GHz ~ 5.825GHz
Number of Channel	2.4GHz: 802.11b, 802.11g, 802.11n (HT20), VHT20: 11 802.11n (HT40), VHT40: 7 5GHz: 802.11a, 802.11n (HT20), 802.11ac (VHT20): 9 802.11n (HT40), 802.11ac (VHT40): 4 802.11ac (VHT80): 2
Output Power	2.4GHz: CDD Mode: 526.359mW Beamforming Mode: 416.62mW 5GHz: CDD Mode: 5.18 ~ 5.24GHz: 403.327mW 5.745 ~ 5.825GHz: 520.715mW Beamforming Mode: 5.18 ~ 5.24GHz: 403.327mW 5.745 ~ 5.825GHz: 520.715mW
Antenna Type	Refer to Note
Antenna Connector	Refer to Note
Accessory Device	NA

Note:

- The EUT has below model names, which are identical to each other in all aspects except for the following information:

Brand Name	Model Name	Difference
Linksys	WHW01P	for marketing requirement
	VLP01P	
	A01P	

From the above models, model: **WHW01P** was selected as representative model for the test and its data was recorded in this report.

2. There are WLAN, Bluetooth technology used for the EUT. The EUT has below radios as following table:

Radio 1	Radio 2
WLAN (2.4GHz+5GHz)	Bluetooth

3. Simultaneously transmission condition.

Condition	Technology		
1	WLAN 2.4GHz	WLAN 5GHz	Bluetooth

Note: The emission of the simultaneous operation has been evaluated and no non-compliance was found.

4. The antennas provided to the EUT, please refer to the following table:

WLAN						
Ant. No.	Chain No.	Ant. Net Gain (dBi)	Freq. range (GHz)	Ant. Type	Connector Type	Cable Length (mm)
1 (Left)	Chain 0	2.41	2.4~2.4835	Dipole	U.FL	53
		3.15	5.15~5.85			
2 (Right)	Chain 1	3.2	2.4~2.4835	Dipole	U.FL	77
		3.9	5.15~5.85			
Bluetooth						
Ant. No.	Ant. Net Gain (dBi)	Freq. range (GHz)	Ant. Type	Connector Type	Cable Length (mm)	
3	2.13	2.402~2.480	IFA	U.FL	53	

5. The EUT incorporates a MIMO function.

2.4GHz Band			
MODULATION MODE	DATA RATE (MCS)	TX & RX CONFIGURATION	
802.11b	1 ~ 11Mbps	2TX	2RX
802.11g	6 ~ 54Mbps	2TX	2RX
802.11n (HT20)	MCS 0~7	2TX	2RX
	MCS 8~15	2TX	2RX
802.11n (HT40)	MCS 0~7	2TX	2RX
	MCS 8~15	2TX	2RX
VHT20	MCS 0~7	2TX	2RX
	MCS 8~15	2TX	2RX
VHT40	MCS 0~7	2TX	2RX
	MCS 8~15	2TX	2RX
5GHz Band			
MODULATION MODE	DATA RATE (MCS)	TX & RX CONFIGURATION	
802.11a	6 ~ 54Mbps	2TX	2RX
802.11n (HT20)	MCS 0~7	2TX	2RX
	MCS 8~15	2TX	2RX
802.11n (HT40)	MCS 0~7	2TX	2RX
	MCS 8~15	2TX	2RX
802.11ac (VHT20)	MCS 0~8, Nss=1	2TX	2RX
	MCS 0~8, Nss=2	2TX	2RX
802.11ac (VHT40)	MCS 0~9, Nss=1	2TX	2RX
	MCS 0~9, Nss=2	2TX	2RX
802.11ac (VHT80)	MCS 0~9, Nss=1	2TX	2RX
	MCS 0~9, Nss=2	2TX	2RX

Note:

1. All of modulation mode support beamforming function except 802.11b/g/a modulation mode.
2. The EUT support Beamforming and non-beamforming mode, therefore both mode were investigated and the worst case scenario was identified. The worst case data were presented in test report.
3. The modulation and bandwidth are similar for 802.11n mode for 20MHz (40MHz) and 802.11ac mode for 20MHz (40MHz), therefore investigated worst case to representative mode in test report. (Final test mode refer section 3.2.1)

6. The above EUT information is declared by manufacturer and for more detailed features description, please refer to the manufacturer's specifications or user's manual.

3.2 Description of Test Modes

FOR 5180 ~ 5240MHz

4 channels are provided for 802.11a, 802.11n (HT20), 802.11ac (VHT20):

Channel	Frequency	Channel	Frequency
36	5180 MHz	44	5220 MHz
40	5200 MHz	48	5240 MHz

2 channels are provided for 802.11n (HT40), 802.11ac (VHT40):

Channel	Frequency	Channel	Frequency
38	5190 MHz	46	5230 MHz

1 channel is provided for 802.11ac (VHT80):

Channel	Frequency
42	5210 MHz

FOR 5745 ~ 5825MHz:

5 channels are provided for 802.11a, 802.11n (HT20), 802.11ac (VHT20):

Channel	Frequency	Channel	Frequency
149	5745 MHz	161	5805 MHz
153	5765 MHz	165	5825 MHz
157	5785 MHz		

2 channels are provided for 802.11n (HT40), 802.11ac (VHT40):

Channel	Frequency	Channel	Frequency
151	5755 MHz	159	5795 MHz

1 channel is provided for 802.11ac (VHT80):

Channel	Frequency
155	5775 MHz

3.2.1 Test Mode Applicability and Tested Channel Detail

EUT Configure Mode	Applicable To				Description
	RE \geq 1G	RE<1G	PLC	APCM	
-	√	√	√	√	-

Where **RE \geq 1G**: Radiated Emission above 1GHz **RE<1G**: Radiated Emission below 1GHz
PLC: Power Line Conducted Emission **APCM**: Antenna Port Conducted Measurement

NOTE: The EUT had been pre-tested on the positioned of each 3 axis. The worst case was found when positioned on Z-plane

Radiated Emission Test (Above 1GHz):

- Pre-Scan has been conducted to determine the worst-case mode from all possible combinations between available modulations, data rates and antenna ports (if EUT with antenna diversity architecture).
- Following channel(s) was (were) selected for the final test as listed below.

CDD Mode						
Mode	FREQ. Band (MHz)	Available Channel	Tested Channel	Modulation Technology	Modulation Type	Data Rate (Mbps)
802.11a	5180-5240	36 to 48	36, 40, 48	OFDM	BPSK	6
802.11ac (VHT20)		36 to 48	36, 40, 48	OFDM	BPSK	6.5
802.11ac (VHT40)		38 to 46	38, 46	OFDM	BPSK	13.5
802.11ac (VHT80)		42	42	OFDM	BPSK	29.3
802.11a	5745-5825	149 to 165	149, 157, 165	OFDM	BPSK	6
802.11ac (VHT20)		149 to 165	149, 157, 165	OFDM	BPSK	6.5
802.11ac (VHT40)		151 to 159	151, 159	OFDM	BPSK	13.5
802.11ac (VHT80)		155	155	OFDM	BPSK	29.3

Radiated Emission Test (Below 1GHz):

- Pre-Scan has been conducted to determine the worst-case mode from all possible combinations between available modulations, data rates and antenna ports (if EUT with antenna diversity architecture).
- Following channel(s) was (were) selected for the final test as listed below.

CDD Mode						
Mode	FREQ. Band (MHz)	Available Channel	Tested Channel	Modulation Technology	Modulation Type	Data Rate (Mbps)
802.11ac (VHT40)	5180-5240 5745-5825	38 to 46 151 to 159	159	OFDM	BPSK	13.5

Power Line Conducted Emission Test:

- Pre-Scan has been conducted to determine the worst-case mode from all possible combinations between available modulations, data rates and antenna ports (if EUT with antenna diversity architecture).
- Following channel(s) was (were) selected for the final test as listed below.

CDD Mode						
Mode	FREQ. Band (MHz)	Available Channel	Tested Channel	Modulation Technology	Modulation Type	Data Rate (Mbps)
802.11ac (VHT40)	5180-5240 5745-5825	38 to 46 151 to 159	159	OFDM	BPSK	13.5

Antenna Port Conducted Measurement:

- This item includes all test value of each mode, but only includes spectrum plot of worst value of each mode.
- Pre-Scan has been conducted to determine the worst-case mode from all possible combinations between available modulations, data rates and antenna ports (if EUT with antenna diversity architecture).
- Following channel(s) was (were) selected for the final test as listed below.

CDD Mode						
Mode	FREQ. Band (MHz)	Available Channel	Tested Channel	Modulation Technology	Modulation Type	Data Rate (Mbps)
802.11a	5180-5240	36 to 48	36, 40, 48	OFDM	BPSK	6
802.11ac (VHT20)		36 to 48	36, 40, 48	OFDM	BPSK	6.5
802.11ac (VHT40)		38 to 46	38, 46	OFDM	BPSK	13.5
802.11ac (VHT80)		42	42	OFDM	BPSK	29.3
802.11a	5745-5825	149 to 165	149, 157, 165	OFDM	BPSK	6
802.11ac (VHT20)		149 to 165	149, 157, 165	OFDM	BPSK	6.5
802.11ac (VHT40)		151 to 159	151, 159	OFDM	BPSK	13.5
802.11ac (VHT80)		155	155	OFDM	BPSK	29.3
Beamforming Mode (output power only)						
Mode	FREQ. Band (MHz)	Available Channel	Tested Channel	Modulation Technology	Modulation Type	Data Rate (Mbps)
802.11ac (VHT20)	5180-5240	36 to 48	36, 40, 48	OFDM	BPSK	6.5
802.11ac (VHT40)		38 to 46	38, 46	OFDM	BPSK	13.5
802.11ac (VHT80)		42	42	OFDM	BPSK	29.3
802.11ac (VHT20)	5745-5825	149 to 165	149, 157, 165	OFDM	BPSK	6.5
802.11ac (VHT40)		151 to 159	151, 159	OFDM	BPSK	13.5
802.11ac (VHT80)		155	155	OFDM	BPSK	29.3

Test Condition:

Applicable To	Environmental Conditions	Input Power	Tested By
RE \geq 1G	20deg. C, 64%RH	120Vac, 60Hz	Frank chuang
RE $<$ 1G	22deg. C, 68%RH	120Vac, 60Hz	Frank chuang
PLC	25deg. C, 69%RH	120Vac, 60Hz	Cody Lee
APCM	25deg. C, 60%RH	120Vac, 60Hz	Jyunchun Lin

3.3 Duty Cycle of Test Signal

If duty cycle of test signal is $\geq 98\%$, duty factor is not required.

If duty cycle of test signal is $< 98\%$, duty factor shall be considered.

802.11a: Duty cycle = $2.027/2.104 = 0.963$, Duty factor = $10 * \log(1/0.963) = 0.16$

802.11ac (VHT20): Duty cycle = $4.97/5.07 = 0.98$

802.11ac (VHT40): Duty cycle = $2.414/2.5 = 0.966$, Duty factor = $10 * \log(1/0.966) = 0.15$

802.11ac (VHT80): Duty cycle = $1.135/1.217 = 0.933$, Duty factor = $10 * \log(1/0.933) = 0.30$

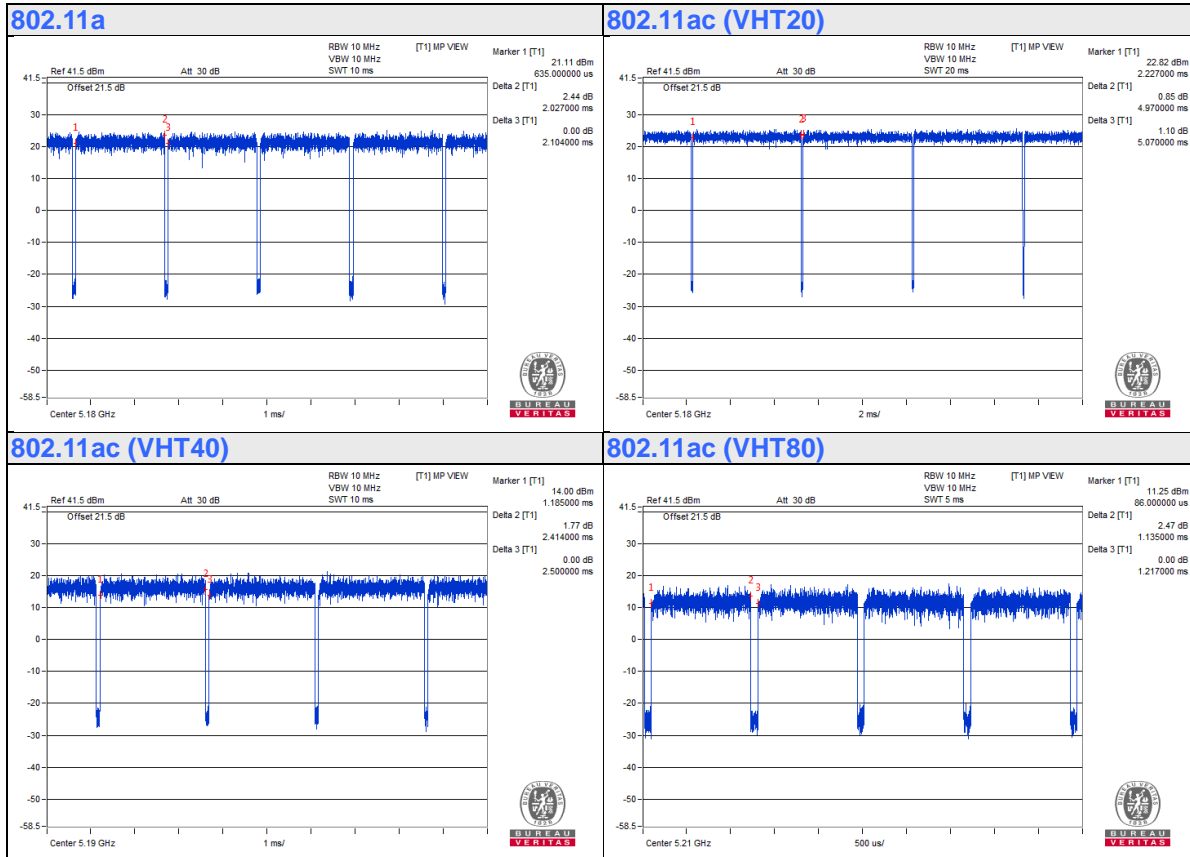

3.4 Description of Support Units

The EUT has been tested as an independent unit together with other necessary accessories or support units. The following support units or accessories were used to form a representative test configuration during the tests.

ID	Descriptions	Qty.	Length (m)	Shielding (Yes/No)	Cores (Qty.)	Remarks
1.	Console Cable	1	0.05	No	0	Supplied by client(for RF Setup)

3.4.1 Configuration of System under Test

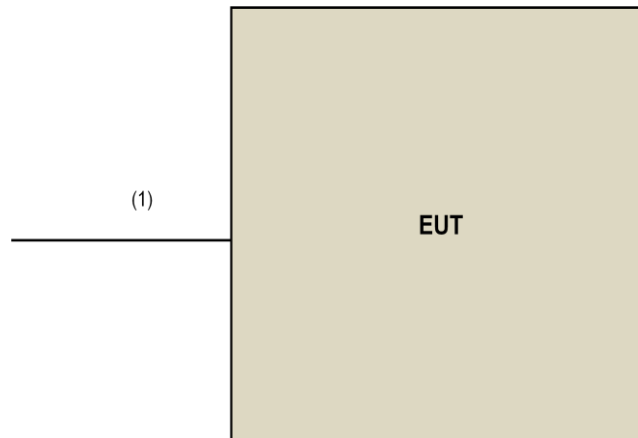

3.5 General Description of Applied Standard

The EUT is a RF Product. According to the specifications of the manufacturer, it must comply with the requirements of the following standards:

FCC Part 15, Subpart E (15.407)
KDB 789033 D02 General UNII Test Procedure New Rules v02r01
KDB 662911 D01 Multiple Transmitter Output v02r01
ANSI C63.10-2013

All test items have been performed and recorded as per the above standards.

4 Test Types and Results

4.1 Radiated Emission and Bandedge Measurement

4.1.1 Limits of Radiated Emission and Bandedge Measurement

Radiated emissions which fall in the restricted bands must comply with the radiated emission limits specified as below table.

Frequencies (MHz)	Field Strength (microvolts/meter)	Measurement Distance (meters)
0.009 ~ 0.490	2400/F(kHz)	300
0.490 ~ 1.705	24000/F(kHz)	30
1.705 ~ 30.0	30	30
30 ~ 88	100	3
88 ~ 216	150	3
216 ~ 960	200	3
Above 960	500	3

NOTE:

- The lower limit shall apply at the transition frequencies.
- Emission level (dBuV/m) = 20 log Emission level (uV/m).
- For frequencies above 1000MHz, the field strength limits are based on average detector, however, the peak field strength of any emission shall not exceed the maximum permitted average limits, specified above by more than 20dB under any condition of modulation.

Limits of unwanted emission out of the restricted bands

Applicable To		Limit	
789033 D02 General UNII Test Procedure New Rules v02r01		Field Strength at 3m	
		PK:74 (dBuV/m)	AV:54 (dBuV/m)
Frequency Band	Applicable To	EIRP Limit	Equivalent Field Strength at 3m
5150~5250 MHz	15.407(b)(1)	PK:-27 (dBm/MHz)	PK:68.2(dBuV/m)
5250~5350 MHz	15.407(b)(2)		
5470~5725 MHz	15.407(b)(3)		
5725~5850 MHz	<input checked="" type="checkbox"/> 15.407(b)(4)(i)	PK:-27 (dBm/MHz) ^{*1} PK:10 (dBm/MHz) ^{*2} PK:15.6 (dBm/MHz) ^{*3} PK:27 (dBm/MHz) ^{*4}	PK: 68.2(dBuV/m) ^{*1} PK:105.2 (dBuV/m) ^{*2} PK: 110.8(dBuV/m) ^{*3} PK:122.2 (dBuV/m) ^{*4}
	<input type="checkbox"/> 15.407(b)(4)(ii)	Emission limits in section 15.247(d)	
^{*1} beyond 75 MHz or more above of the band edge.		^{*2} below the band edge increasing linearly to 10 dBm/MHz at 25 MHz above.	
^{*3} below the band edge increasing linearly to a level of 15.6 dBm/MHz at 5 MHz above.		^{*4} from 5 MHz above or below the band edge increasing linearly to a level of 27 dBm/MHz at the band edge.	

Note:

The following formula is used to convert the equipment isotropic radiated power (eirp) to field strength:

$$E = \frac{1000000\sqrt{30P}}{3} \mu\text{V/m, where P is the eirp (Watts).}$$

4.1.2 Test Instruments

For Below 1GHz test:

DESCRIPTION & MANUFACTURER	MODEL NO.	SERIAL NO.	CALIBRATED DATE	CALIBRATED UNTIL
Test Receiver Keysight	N9038A	MY54450088	July 08, 2017	July 07, 2018
Pre-Amplifier EMCI	EMC001340	980142	Feb. 09, 2018	Feb. 08, 2019
Loop Antenna ^(*) Electro-Metrics	EM-6879	264	Dec. 16, 2016	Dec. 15, 2018
RF Cable	NA	LOOPCAB-001	Jan. 15, 2018	Jan. 14, 2019
RF Cable	NA	LOOPCAB-002	Jan. 15, 2018	Jan. 14, 2019
Pre-Amplifier Mini-Circuits	ZFL-1000VH2B	AMP-ZFL-01	Nov. 09, 2017	Nov. 08, 2018
Trilog Broadband Antenna SCHWARZBECK	VULB 9168	9168-406	Nov. 29, 2017	Nov. 28, 2018
RF Cable	8D	966-4-1	Mar. 21, 2018	Mar. 20, 2019
RF Cable	8D	966-4-2	Mar. 21, 2018	Mar. 20, 2019
RF Cable	8D	966-4-3	Mar. 21, 2018	Mar. 20, 2019
Fixed attenuator Mini-Circuits	UNAT-5+	PAD-3m-4-01	Oct. 03, 2017	Oct. 02, 2018
Software	ADT_Radiated_V8.7.08	NA	NA	NA
Boresight Antenna Tower & Turn Table Max-Full	MF-7802BS	MF780208530	NA	NA

Note:

1. The calibration interval of the above test instruments is 12 months and the calibrations are traceable to NML/ROC and NIST/USA.
2. *The calibration interval of the above test instruments is 24 months and the calibrations are traceable to NML/ROC and NIST/USA.
3. The test was performed in 966 Chamber No. 4.
4. The CANADA Site Registration No. is 20331-2
5. Loop antenna was used for all emissions below 30 MHz.
6. Tested Date: July 04, 2018

For other test:

DESCRIPTION & MANUFACTURER	MODEL NO.	SERIAL NO.	CALIBRATED DATE	CALIBRATED UNTIL
Test Receiver Keysight	N9038A	MY54450088	July 05, 2018	July 04, 2019
Horn_Antenna SCHWARZBECK	BBHA 9120D	9120D-783	Dec. 12, 2017	Dec. 11, 2018
Pre-Amplifier Mini-Circuits	ZVA-183-S+	AMP-ZVA-03	May 10, 2018	May 09, 2019
RF Cable	EMC104-SM-SM-1200	160923	Jan. 29, 2018	Jan. 28, 2019
RF Cable	EMC104-SM-SM-2000	150318	Jan. 29, 2018	Jan. 28, 2019
RF Cable	EMC104-SM-SM-5000	150321	Jan. 29, 2018	Jan. 28, 2019
Pre-Amplifier EMCI	EMC184045SE	980387	Jan. 29, 2018	Jan. 28, 2019
Horn_Antenna SCHWARZBECK	BBHA 9170	BBHA9170608	Dec. 14, 2017	Dec. 13, 2018
RF Cable	EMC102-KM-KM-1200	160925	Jan. 29, 2018	Jan. 28, 2019
Software	ADT_Radiated_V8.7.08	NA	NA	NA
Boresight Antenna Tower & Turn Table Max-Full	MF-7802BS	MF780208530	NA	NA
Spectrum Analyzer R&S	FSV40	100964	June 20, 2018	June 19, 2019
Power meter Anritsu	ML2495A	1014008	May 09, 2018	May 08, 2019
Power sensor Anritsu	MA2411B	0917122	May 09, 2018	May 08, 2019
AC Power Source Extech Electronics	6205	1440452	NA	NA
Temperature & Humidity Chamber Giant Force	GTH-150-40-SP-AR	MAA0812-008	Jan. 10, 2018	Jan. 09, 2019
True RMS Clamp Meter FLUKE	325	31130711WS	May 22, 2018	May 21, 2019

Note:

1. The calibration interval of the above test instruments is 12 months and the calibrations are traceable to NML/ROC and NIST/USA.
2. The test was performed in 966 Chamber No. 4.
3. The CANADA Site Registration No. is 20331-2
4. Tested Date: July 18, 2018

4.1.3 Test Procedure

For Radiated emission below 30MHz

- a. The EUT was placed on the top of a rotating table 0.8 meters above the ground at a 3 meter chamber room. The table was rotated 360 degrees to determine the position of the highest radiation.
- b. The EUT was set 3 meters away from the interference-receiving antenna, which was mounted on the top of a variable-height antenna tower.
- c. Parallel, perpendicular, and ground-parallel orientations of the antenna are set to make the measurement.
- d. For each suspected emission, the EUT was arranged to its worst case and the rotatable table was turned from 0 degrees to 360 degrees to find the maximum reading.
- e. The test-receiver system was set to Quasi-Peak Detect Function and Specified Bandwidth with Maximum Hold Mode.

NOTE:

1. The resolution bandwidth and video bandwidth of test receiver/spectrum analyzer is 9kHz at frequency below 30MHz.

For Radiated emission above 30MHz

- a. The EUT was placed on the top of a rotating table 0.8 meters (for 30MHz ~ 1GHz) / 1.5 meters (for above 1GHz) above the ground at 3 meter chamber room for test. The table was rotated 360 degrees to determine the position of the highest radiation.
- b. The EUT was set 3 meters away from the interference-receiving antenna, which was mounted on the top of a variable-height antenna tower.
- c. The height of antenna is varied from one meter to four meters above the ground to determine the maximum value of the field strength. Both horizontal and vertical polarizations of the antenna are set to make the measurement.
- d. For each suspected emission, the EUT was arranged to its worst case and then the antenna was tuned to heights from 1 meter to 4 meters and the rotatable table was turned from 0 degrees to 360 degrees to find the maximum reading.
- e. The test-receiver system was set to quasi-peak detect function and specified bandwidth with maximum hold mode when the test frequency is below 1 GHz.
- f. The test-receiver system was set to peak and average detects function and specified bandwidth with maximum hold mode when the test frequency is above 1 GHz. If the peak reading value also meets average limit, measurement with the average detector is unnecessary.

Note:

1. The resolution bandwidth and video bandwidth of test receiver/spectrum analyzer is 120kHz for Quasi-peak detection (QP) at frequency below 1GHz.
2. The resolution bandwidth of test receiver/spectrum analyzer is 1 MHz and the video bandwidth is 3 MHz for Peak detection (PK) at frequency above 1GHz.
3. The resolution bandwidth of test receiver/spectrum analyzer is 1MHz and the video bandwidth is $\geq 1/T$ (Duty cycle < 98%) or 10Hz (Duty cycle $\geq 98\%$) for Average detection (AV) at frequency above 1GHz.
4. All modes of operation were investigated and the worst-case emissions are reported.

4.1.4 Deviation from Test Standard

No deviation.

4.1.5 Test Setup

For Radiated emission below 30MHz

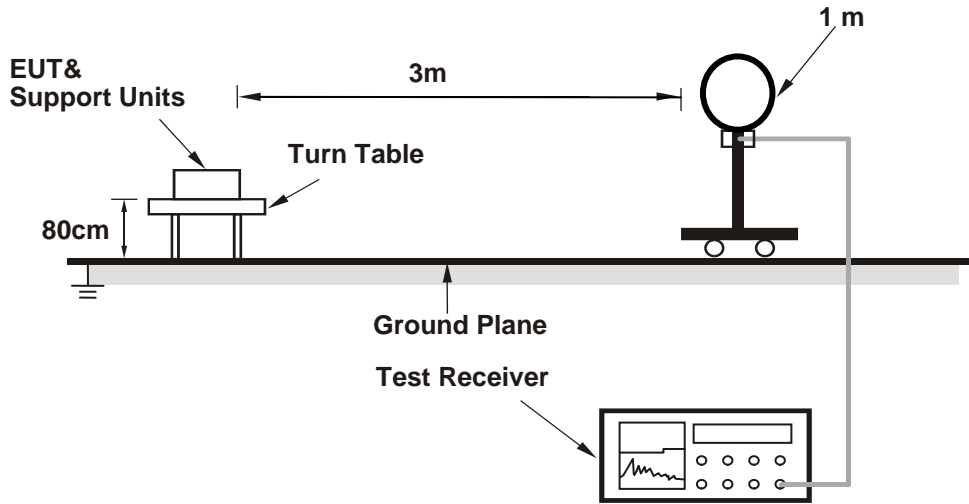

For Radiated emission 30MHz to 1GHz

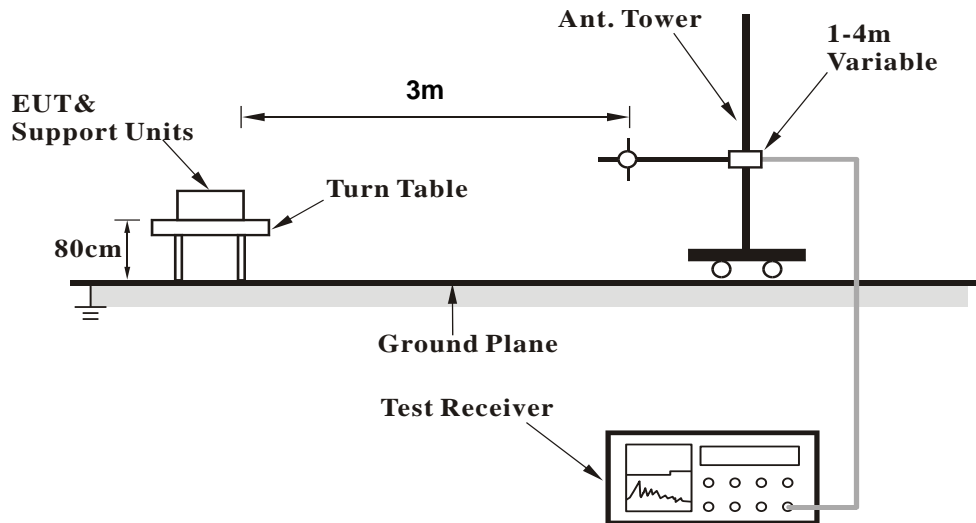

For Radiated emission above 1GHz

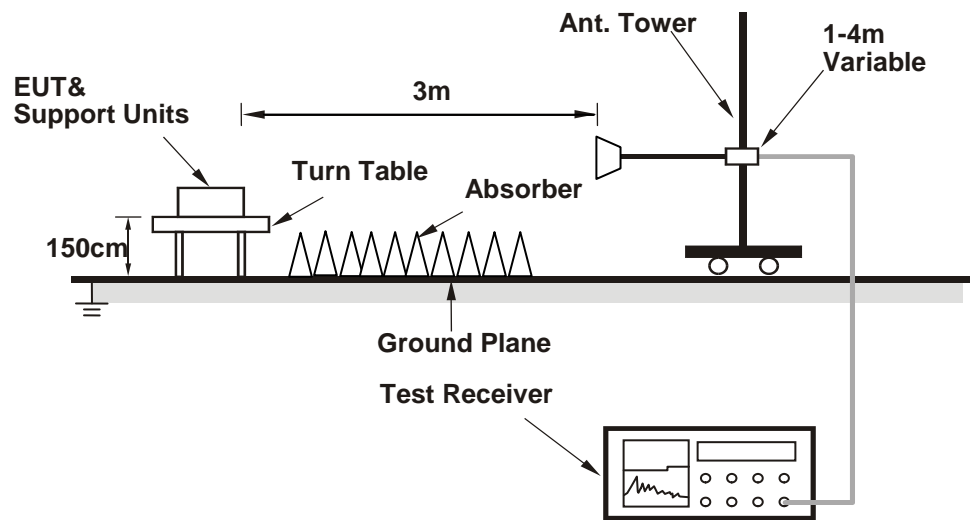

For the actual test configuration, please refer to the attached file (Test Setup Photo).

4.1.6 EUT Operating Condition

- a. Placed the EUT on the testing table.
- a. Controlling software (QDART_1.0.38) has been activated to set the EUT on specific status.

4.1.7 Test Results

Above 1GHz Data:

802.11a

CHANNEL	TX Channel 36	DETECTOR FUNCTION	Peak (PK)
FREQUENCY RANGE	1GHz ~ 40GHz		Average (AV)

ANTENNA POLARITY & TEST DISTANCE: HORIZONTAL AT 3 M

NO.	FREQ. (MHz)	EMISSION LEVEL (dBuV/m)	LIMIT (dBuV/m)	MARGIN (dB)	ANTENNA HEIGHT (m)	TABLE ANGLE (Degree)	RAW VALUE (dBuV)	CORRECTION FACTOR (dB/m)
1	5150.00	72.1 PK	74.0	-1.9	1.01 H	72	69.1	3.0
2	5150.00	53.9 AV	54.0	-0.1	1.01 H	72	50.9	3.0
3	*5180.00	115.8 PK			1.01 H	72	113.0	2.8
4	*5180.00	106.2 AV			1.01 H	72	103.4	2.8
5	#10360.00	56.7 PK	74.0	-17.3	1.30 H	200	44.3	12.4
6	#10360.00	44.7 AV	54.0	-9.3	1.30 H	200	32.3	12.4
7	15540.00	60.4 PK	74.0	-13.6	1.46 H	151	47.6	12.8
8	15540.00	47.4 AV	54.0	-6.6	1.46 H	151	34.6	12.8

ANTENNA POLARITY & TEST DISTANCE: VERTICAL AT 3 M

NO.	FREQ. (MHz)	EMISSION LEVEL (dBuV/m)	LIMIT (dBuV/m)	MARGIN (dB)	ANTENNA HEIGHT (m)	TABLE ANGLE (Degree)	RAW VALUE (dBuV)	CORRECTION FACTOR (dB/m)
1	5150.00	66.8 PK	74.0	-7.2	3.59 V	336	63.8	3.0
2	5150.00	49.8 AV	54.0	-4.2	3.59 V	336	46.8	3.0
3	*5180.00	108.5 PK			3.59 V	336	105.7	2.8
4	*5180.00	99.9 AV			3.59 V	336	97.1	2.8
5	#10360.00	58.8 PK	74.0	-15.2	1.54 V	6	46.4	12.4
6	#10360.00	47.7 AV	54.0	-6.3	1.54 V	6	35.3	12.4
7	15540.00	58.8 PK	74.0	-15.2	3.67 V	331	46.0	12.8
8	15540.00	47.4 AV	54.0	-6.6	3.67 V	331	34.6	12.8

REMARKS:

- Emission Level(dBuV/m) = Raw Value(dBuV) + Correction Factor(dB/m)
- Correction Factor(dB/m) = Antenna Factor(dB/m) + Cable Factor(dB) – Pre-Amplifier Factor(dB)
- The other emission levels were very low against the limit.
- Margin value = Emission Level – Limit value
- " * ": Fundamental frequency.
- " # ": The radiated frequency is out of the restricted band.

CHANNEL	TX Channel 40	DETECTOR FUNCTION	Peak (PK)
FREQUENCY RANGE	1GHz ~ 40GHz		Average (AV)

ANTENNA POLARITY & TEST DISTANCE: HORIZONTAL AT 3 M

NO.	FREQ. (MHz)	EMISSION LEVEL (dBuV/m)	LIMIT (dBuV/m)	MARGIN (dB)	ANTENNA HEIGHT (m)	TABLE ANGLE (Degree)	RAW VALUE (dBuV)	CORRECTION FACTOR (dB/m)
1	5150.00	70.9 PK	74.0	-3.1	1.03 H	73	67.9	3.0
2	5150.00	53.5 AV	54.0	-0.5	1.03 H	73	50.5	3.0
3	*5200.00	120.4 PK			1.03 H	73	117.7	2.7
4	*5200.00	110.1 AV			1.03 H	73	107.4	2.7
5	#10400.00	56.7 PK	74.0	-17.3	1.28 H	208	44.2	12.5
6	#10400.00	44.8 AV	54.0	-9.2	1.28 H	208	32.3	12.5
7	15600.00	60.8 PK	74.0	-13.2	1.45 H	163	48.0	12.8
8	15600.00	47.8 AV	54.0	-6.2	1.45 H	163	35.0	12.8

ANTENNA POLARITY & TEST DISTANCE: VERTICAL AT 3 M

NO.	FREQ. (MHz)	EMISSION LEVEL (dBuV/m)	LIMIT (dBuV/m)	MARGIN (dB)	ANTENNA HEIGHT (m)	TABLE ANGLE (Degree)	RAW VALUE (dBuV)	CORRECTION FACTOR (dB/m)
1	5150.00	66.9 PK	74.0	-7.1	3.56 V	331	63.9	3.0
2	5150.00	50.0 AV	54.0	-4.0	3.56 V	331	47.0	3.0
3	*5200.00	113.9 PK			3.56 V	331	111.2	2.7
4	*5200.00	104.2 AV			3.56 V	331	101.5	2.7
5	#10400.00	59.1 PK	74.0	-14.9	1.53 V	5	46.6	12.5
6	#10400.00	47.7 AV	54.0	-6.3	1.53 V	5	35.2	12.5
7	15600.00	58.8 PK	74.0	-15.2	3.67 V	343	46.0	12.8
8	15600.00	47.2 AV	54.0	-6.8	3.67 V	343	34.4	12.8

REMARKS:

1. Emission Level(dBuV/m) = Raw Value(dBuV) + Correction Factor(dB/m)
2. Correction Factor(dB/m) = Antenna Factor(dB/m) + Cable Factor(dB) – Pre-Amplifier Factor(dB)
3. The other emission levels were very low against the limit.
4. Margin value = Emission Level – Limit value
5. " * ": Fundamental frequency.
6. " # ": The radiated frequency is out of the restricted band.

CHANNEL	TX Channel 48	DETECTOR FUNCTION	Peak (PK)
FREQUENCY RANGE	1GHz ~ 40GHz		Average (AV)

ANTENNA POLARITY & TEST DISTANCE: HORIZONTAL AT 3 M

NO.	FREQ. (MHz)	EMISSION LEVEL (dBuV/m)	LIMIT (dBuV/m)	MARGIN (dB)	ANTENNA HEIGHT (m)	TABLE ANGLE (Degree)	RAW VALUE (dBuV)	CORRECTION FACTOR (dB/m)
1	*5240.00	120.2 PK			1.00 H	77	117.7	2.5
2	*5240.00	109.9 AV			1.00 H	77	107.4	2.5
3	5350.00	59.8 PK	74.0	-14.2	1.00 H	77	57.2	2.6
4	5350.00	42.1 AV	54.0	-11.9	1.00 H	77	39.5	2.6
5	5375.00	58.7 PK	74.0	-15.3	1.00 H	77	56.0	2.7
6	5375.00	44.8 AV	54.0	-9.2	1.00 H	77	42.1	2.7
7	#10480.00	56.7 PK	74.0	-17.3	1.25 H	200	43.7	13.0
8	#10480.00	44.6 AV	54.0	-9.4	1.25 H	200	31.6	13.0
9	15720.00	60.6 PK	74.0	-13.4	1.40 H	160	48.2	12.4
10	15720.00	47.6 AV	54.0	-6.4	1.40 H	160	35.2	12.4

ANTENNA POLARITY & TEST DISTANCE: VERTICAL AT 3 M

NO.	FREQ. (MHz)	EMISSION LEVEL (dBuV/m)	LIMIT (dBuV/m)	MARGIN (dB)	ANTENNA HEIGHT (m)	TABLE ANGLE (Degree)	RAW VALUE (dBuV)	CORRECTION FACTOR (dB/m)
1	*5240.00	114.2 PK			3.56 V	342	111.7	2.5
2	*5240.00	104.1 AV			3.56 V	342	101.6	2.5
3	5350.00	56.2 PK	74.0	-17.8	3.56 V	342	53.6	2.6
4	5350.00	39.8 AV	54.0	-14.2	3.56 V	342	37.2	2.6
5	5375.00	55.5 PK	74.0	-18.5	3.56 V	342	52.8	2.7
6	5375.00	41.7 AV	54.0	-12.3	3.56 V	342	39.0	2.7
7	#10480.00	59.2 PK	74.0	-14.8	1.52 V	35	46.2	13.0
8	#10480.00	47.6 AV	54.0	-6.4	1.52 V	35	34.6	13.0
9	15720.00	59.0 PK	74.0	-15.0	3.69 V	345	46.6	12.4
10	15720.00	47.2 AV	54.0	-6.8	3.69 V	345	34.8	12.4

REMARKS:

- Emission Level(dBuV/m) = Raw Value(dBuV) + Correction Factor(dB/m)
- Correction Factor(dB/m) = Antenna Factor(dB/m) + Cable Factor(dB) – Pre-Amplifier Factor(dB)
- The other emission levels were very low against the limit.
- Margin value = Emission Level – Limit value
- " * ": Fundamental frequency.
- " # ": The radiated frequency is out of the restricted band.

CHANNEL	TX Channel 149	DETECTOR FUNCTION	Peak (PK)
FREQUENCY RANGE	1GHz ~ 40GHz		Average (AV)

ANTENNA POLARITY & TEST DISTANCE: HORIZONTAL AT 3 M

NO.	FREQ. (MHz)	EMISSION LEVEL (dBuV/m)	LIMIT (dBuV/m)	MARGIN (dB)	ANTENNA HEIGHT (m)	TABLE ANGLE (Degree)	RAW VALUE (dBuV)	CORRECTION FACTOR (dB/m)
1	#5647.15	64.5 PK	68.2	-3.7	1.00 H	62	61.3	3.2
2	*5745.00	121.8 PK			1.00 H	62	118.5	3.3
3	*5745.00	111.6 AV			1.00 H	62	108.3	3.3
4	#5979.99	57.2 PK	68.2	-11.0	1.00 H	62	53.6	3.6
5	11490.00	56.8 PK	74.0	-17.2	2.02 H	80	43.4	13.4
6	11490.00	43.8 AV	54.0	-10.2	2.02 H	80	30.4	13.4
7	#17235.00	65.1 PK	74.0	-8.9	1.04 H	270	48.4	16.7
8	#17235.00	51.5 AV	54.0	-2.5	1.04 H	270	34.8	16.7

ANTENNA POLARITY & TEST DISTANCE: VERTICAL AT 3 M

NO.	FREQ. (MHz)	EMISSION LEVEL (dBuV/m)	LIMIT (dBuV/m)	MARGIN (dB)	ANTENNA HEIGHT (m)	TABLE ANGLE (Degree)	RAW VALUE (dBuV)	CORRECTION FACTOR (dB/m)
1	#5623.44	58.0 PK	68.2	-10.2	3.66 V	334	54.7	3.3
2	*5745.00	113.6 PK			3.66 V	334	110.3	3.3
3	*5745.00	103.5 AV			3.66 V	334	100.2	3.3
4	#6000.09	56.6 PK	68.2	-11.6	3.66 V	334	52.9	3.7
5	11490.00	59.3 PK	74.0	-14.7	1.22 V	14	45.9	13.4
6	11490.00	46.2 AV	54.0	-7.8	1.22 V	14	32.8	13.4
7	#17235.00	67.4 PK	74.0	-6.6	3.97 V	360	50.7	16.7
8	#17235.00	53.5 AV	54.0	-0.5	3.97 V	360	36.8	16.7

REMARKS:

1. Emission Level(dBuV/m) = Raw Value(dBuV) + Correction Factor(dB/m)
2. Correction Factor(dB/m) = Antenna Factor(dB/m) + Cable Factor(dB) – Pre-Amplifier Factor(dB)
3. The other emission levels were very low against the limit.
4. Margin value = Emission Level – Limit value
5. " * ": Fundamental frequency.
6. " # ": The radiated frequency is out of the restricted band.

CHANNEL	TX Channel 157	DETECTOR FUNCTION	Peak (PK)
FREQUENCY RANGE	1GHz ~ 40GHz		Average (AV)

ANTENNA POLARITY & TEST DISTANCE: HORIZONTAL AT 3 M

NO.	FREQ. (MHz)	EMISSION LEVEL (dBuV/m)	LIMIT (dBuV/m)	MARGIN (dB)	ANTENNA HEIGHT (m)	TABLE ANGLE (Degree)	RAW VALUE (dBuV)	CORRECTION FACTOR (dB/m)
1	#5649.76	62.8 PK	68.2	-5.4	1.01 H	63	59.6	3.2
2	*5785.00	120.9 PK			1.01 H	63	117.6	3.3
3	*5785.00	111.0 AV			1.01 H	63	107.7	3.3
4	#5931.05	57.9 PK	68.2	-10.3	1.01 H	63	54.3	3.6
5	11570.00	57.3 PK	74.0	-16.7	2.02 H	78	43.9	13.4
6	11570.00	44.1 AV	54.0	-9.9	2.02 H	78	30.7	13.4
7	#17355.00	65.7 PK	74.0	-8.3	1.04 H	284	48.4	17.3
8	#17355.00	52.3 AV	54.0	-1.7	1.04 H	284	35.0	17.3

ANTENNA POLARITY & TEST DISTANCE: VERTICAL AT 3 M

NO.	FREQ. (MHz)	EMISSION LEVEL (dBuV/m)	LIMIT (dBuV/m)	MARGIN (dB)	ANTENNA HEIGHT (m)	TABLE ANGLE (Degree)	RAW VALUE (dBuV)	CORRECTION FACTOR (dB/m)
1	#5593.34	55.7 PK	68.2	-12.5	3.62 V	334	52.5	3.2
2	*5785.00	112.6 PK			3.62 V	334	109.3	3.3
3	*5785.00	102.5 AV			3.62 V	334	99.2	3.3
4	#5981.45	56.3 PK	68.2	-11.9	3.62 V	334	52.6	3.7
5	11570.00	59.1 PK	74.0	-14.9	1.22 V	0	45.7	13.4
6	11570.00	46.0 AV	54.0	-8.0	1.22 V	0	32.6	13.4
7	#17355.00	67.2 PK	74.0	-6.8	3.96 V	18	49.9	17.3
8	#17355.00	53.4 AV	54.0	-0.6	3.96 V	18	36.1	17.3

REMARKS:

1. Emission Level(dBuV/m) = Raw Value(dBuV) + Correction Factor(dB/m)
2. Correction Factor(dB/m) = Antenna Factor(dB/m) + Cable Factor(dB) – Pre-Amplifier Factor(dB)
3. The other emission levels were very low against the limit.
4. Margin value = Emission Level – Limit value
5. " * ": Fundamental frequency.
6. " # ": The radiated frequency is out of the restricted band.

CHANNEL	TX Channel 165	DETECTOR FUNCTION	Peak (PK)
FREQUENCY RANGE	1GHz ~ 40GHz		Average (AV)

ANTENNA POLARITY & TEST DISTANCE: HORIZONTAL AT 3 M

NO.	FREQ. (MHz)	EMISSION LEVEL (dBuV/m)	LIMIT (dBuV/m)	MARGIN (dB)	ANTENNA HEIGHT (m)	TABLE ANGLE (Degree)	RAW VALUE (dBuV)	CORRECTION FACTOR (dB/m)
1	#5638.87	61.3 PK	68.2	-6.9	1.00 H	60	58.1	3.2
2	*5825.00	120.7 PK			1.00 H	60	117.2	3.5
3	*5825.00	110.8 AV			1.00 H	60	107.3	3.5
4	#5928.50	62.0 PK	68.2	-6.2	1.00 H	60	58.4	3.6
5	11650.00	57.8 PK	74.0	-16.2	1.97 H	66	44.5	13.3
6	11650.00	44.5 AV	54.0	-9.5	1.97 H	66	31.2	13.3
7	#17475.00	65.5 PK	74.0	-8.5	1.00 H	289	47.3	18.2
8	#17475.00	51.9 AV	54.0	-2.1	1.00 H	289	33.7	18.2

ANTENNA POLARITY & TEST DISTANCE: VERTICAL AT 3 M

NO.	FREQ. (MHz)	EMISSION LEVEL (dBuV/m)	LIMIT (dBuV/m)	MARGIN (dB)	ANTENNA HEIGHT (m)	TABLE ANGLE (Degree)	RAW VALUE (dBuV)	CORRECTION FACTOR (dB/m)
1	#5632.32	56.9 PK	68.2	-11.3	3.66 V	333	53.7	3.2
2	*5825.00	112.4 PK			3.66 V	333	108.9	3.5
3	*5825.00	102.4 AV			3.66 V	333	98.9	3.5
4	#5940.44	57.2 PK	68.2	-11.0	3.66 V	333	53.7	3.5
5	11650.00	59.6 PK	74.0	-14.4	1.26 V	9	46.3	13.3
6	11650.00	46.3 AV	54.0	-7.7	1.26 V	9	33.0	13.3
7	#17475.00	68.0 PK	74.0	-6.0	3.95 V	17	49.8	18.2
8	#17475.00	53.2 AV	54.0	-0.8	3.95 V	17	35.0	18.2

REMARKS:

1. Emission Level(dBuV/m) = Raw Value(dBuV) + Correction Factor(dB/m)
2. Correction Factor(dB/m) = Antenna Factor(dB/m) + Cable Factor(dB) – Pre-Amplifier Factor(dB)
3. The other emission levels were very low against the limit.
4. Margin value = Emission Level – Limit value
5. " * ": Fundamental frequency.
6. " # ": The radiated frequency is out of the restricted band.

802.11ac (VHT20)

CHANNEL	TX Channel 36	DETECTOR FUNCTION	Peak (PK)
FREQUENCY RANGE	1GHz ~ 40GHz		Average (AV)

ANTENNA POLARITY & TEST DISTANCE: HORIZONTAL AT 3 M

NO.	FREQ. (MHz)	EMISSION LEVEL (dBuV/m)	LIMIT (dBuV/m)	MARGIN (dB)	ANTENNA HEIGHT (m)	TABLE ANGLE (Degree)	RAW VALUE (dBuV)	CORRECTION FACTOR (dB/m)
1	5150.00	70.2 PK	74.0	-3.8	1.07 H	332	67.2	3.0
2	5150.00	53.5 AV	54.0	-0.5	1.07 H	332	50.5	3.0
3	*5180.00	117.6 PK			1.07 H	332	114.8	2.8
4	*5180.00	106.6 AV			1.07 H	332	103.8	2.8
5	#10360.00	56.9 PK	74.0	-17.1	1.26 H	198	44.5	12.4
6	#10360.00	44.7 AV	54.0	-9.3	1.26 H	198	32.3	12.4
7	15540.00	60.0 PK	74.0	-14.0	1.49 H	144	47.2	12.8
8	15540.00	47.0 AV	54.0	-7.0	1.49 H	144	34.2	12.8

ANTENNA POLARITY & TEST DISTANCE: VERTICAL AT 3 M

NO.	FREQ. (MHz)	EMISSION LEVEL (dBuV/m)	LIMIT (dBuV/m)	MARGIN (dB)	ANTENNA HEIGHT (m)	TABLE ANGLE (Degree)	RAW VALUE (dBuV)	CORRECTION FACTOR (dB/m)
1	5150.00	66.5 PK	74.0	-7.5	3.60 V	327	63.5	3.0
2	5150.00	49.5 AV	54.0	-4.5	3.60 V	327	46.5	3.0
3	*5180.00	108.2 PK			3.60 V	327	105.4	2.8
4	*5180.00	99.7 AV			3.60 V	327	96.9	2.8
5	#10360.00	59.5 PK	74.0	-14.5	1.47 V	27	47.1	12.4
6	#10360.00	48.1 AV	54.0	-5.9	1.47 V	27	35.7	12.4
7	15540.00	58.3 PK	74.0	-15.7	3.66 V	360	45.5	12.8
8	15540.00	46.8 AV	54.0	-7.2	3.66 V	360	34.0	12.8

REMARKS:

- Emission Level(dBuV/m) = Raw Value(dBuV) + Correction Factor(dB/m)
- Correction Factor(dB/m) = Antenna Factor(dB/m) + Cable Factor(dB) – Pre-Amplifier Factor(dB)
- The other emission levels were very low against the limit.
- Margin value = Emission Level – Limit value
- " * ": Fundamental frequency.
- " # ": The radiated frequency is out of the restricted band.

CHANNEL	TX Channel 40	DETECTOR FUNCTION	Peak (PK)
FREQUENCY RANGE	1GHz ~ 40GHz		Average (AV)

ANTENNA POLARITY & TEST DISTANCE: HORIZONTAL AT 3 M

NO.	FREQ. (MHz)	EMISSION LEVEL (dBuV/m)	LIMIT (dBuV/m)	MARGIN (dB)	ANTENNA HEIGHT (m)	TABLE ANGLE (Degree)	RAW VALUE (dBuV)	CORRECTION FACTOR (dB/m)
1	5150.00	73.8 PK	74.0	-0.2	1.02 H	72	70.8	3.0
2	5150.00	53.5 AV	54.0	-0.5	1.02 H	72	50.5	3.0
3	*5200.00	122.2 PK			1.02 H	72	119.5	2.7
4	*5200.00	111.3 AV			1.02 H	72	108.6	2.7
5	#10400.00	59.4 PK	74.0	-14.6	1.30 H	182	46.9	12.5
6	#10400.00	47.3 AV	54.0	-6.7	1.30 H	182	34.8	12.5
7	15600.00	64.5 PK	74.0	-9.5	1.02 H	2	51.7	12.8
8	15600.00	50.3 AV	54.0	-3.7	1.02 H	2	37.5	12.8

ANTENNA POLARITY & TEST DISTANCE: VERTICAL AT 3 M

NO.	FREQ. (MHz)	EMISSION LEVEL (dBuV/m)	LIMIT (dBuV/m)	MARGIN (dB)	ANTENNA HEIGHT (m)	TABLE ANGLE (Degree)	RAW VALUE (dBuV)	CORRECTION FACTOR (dB/m)
1	5150.00	66.8 PK	74.0	-7.2	3.55 V	320	63.8	3.0
2	5150.00	50.0 AV	54.0	-4.0	3.55 V	320	47.0	3.0
3	*5200.00	113.6 PK			3.55 V	320	110.9	2.7
4	*5200.00	104.8 AV			3.55 V	320	102.1	2.7
5	#10400.00	59.1 PK	74.0	-14.9	1.47 V	36	46.6	12.5
6	#10400.00	47.6 AV	54.0	-6.4	1.47 V	36	35.1	12.5
7	15600.00	59.3 PK	74.0	-14.7	3.72 V	332	46.5	12.8
8	15600.00	47.3 AV	54.0	-6.7	3.72 V	332	34.5	12.8

REMARKS:

1. Emission Level(dBuV/m) = Raw Value(dBuV) + Correction Factor(dB/m)
2. Correction Factor(dB/m) = Antenna Factor(dB/m) + Cable Factor(dB) – Pre-Amplifier Factor(dB)
3. The other emission levels were very low against the limit.
4. Margin value = Emission Level – Limit value
5. " * ": Fundamental frequency.
6. " # ": The radiated frequency is out of the restricted band.

CHANNEL	TX Channel 48	DETECTOR FUNCTION	Peak (PK)
FREQUENCY RANGE	1GHz ~ 40GHz		Average (AV)

ANTENNA POLARITY & TEST DISTANCE: HORIZONTAL AT 3 M

NO.	FREQ. (MHz)	EMISSION LEVEL (dBuV/m)	LIMIT (dBuV/m)	MARGIN (dB)	ANTENNA HEIGHT (m)	TABLE ANGLE (Degree)	RAW VALUE (dBuV)	CORRECTION FACTOR (dB/m)
1	*5240.00	121.8 PK			1.01 H	68	119.3	2.5
2	*5240.00	110.6 AV			1.01 H	68	108.1	2.5
3	5350.00	59.5 PK	74.0	-14.5	1.01 H	68	56.9	2.6
4	5350.00	42.0 AV	54.0	-12.0	1.01 H	68	39.4	2.6
5	5376.00	58.8 PK	74.0	-15.2	1.01 H	68	56.1	2.7
6	5376.00	44.6 AV	54.0	-9.4	1.01 H	68	41.9	2.7
7	#10480.00	58.2 PK	74.0	-15.8	1.30 H	194	45.2	13.0
8	#10480.00	45.2 AV	54.0	-8.8	1.30 H	194	32.2	13.0
9	15720.00	60.8 PK	74.0	-13.2	1.44 H	145	48.4	12.4
10	15720.00	47.8 AV	54.0	-6.2	1.44 H	145	35.4	12.4

ANTENNA POLARITY & TEST DISTANCE: VERTICAL AT 3 M

NO.	FREQ. (MHz)	EMISSION LEVEL (dBuV/m)	LIMIT (dBuV/m)	MARGIN (dB)	ANTENNA HEIGHT (m)	TABLE ANGLE (Degree)	RAW VALUE (dBuV)	CORRECTION FACTOR (dB/m)
1	*5240.00	112.7 PK			3.64 V	339	110.2	2.5
2	*5240.00	103.8 AV			3.64 V	339	101.3	2.5
3	5350.00	55.9 PK	74.0	-18.1	3.64 V	339	53.3	2.6
4	5350.00	39.6 AV	54.0	-14.4	3.64 V	339	37.0	2.6
5	5376.00	55.7 PK	74.0	-18.3	3.64 V	339	53.0	2.7
6	5376.00	41.2 AV	54.0	-12.8	3.64 V	339	38.5	2.7
7	#10480.00	59.4 PK	74.0	-14.6	1.52 V	28	46.4	13.0
8	#10480.00	47.9 AV	54.0	-6.1	1.52 V	28	34.9	13.0
9	15720.00	58.5 PK	74.0	-15.5	3.72 V	337	46.1	12.4
10	15720.00	46.8 AV	54.0	-7.2	3.72 V	337	34.4	12.4

REMARKS:

1. Emission Level(dBuV/m) = Raw Value(dBuV) + Correction Factor(dB/m)
2. Correction Factor(dB/m) = Antenna Factor(dB/m) + Cable Factor(dB) – Pre-Amplifier Factor(dB)
3. The other emission levels were very low against the limit.
4. Margin value = Emission Level – Limit value
5. " * ": Fundamental frequency.
6. " # ": The radiated frequency is out of the restricted band.

CHANNEL	TX Channel 149	DETECTOR FUNCTION	Peak (PK)
FREQUENCY RANGE	1GHz ~ 40GHz		Average (AV)

ANTENNA POLARITY & TEST DISTANCE: HORIZONTAL AT 3 M

NO.	FREQ. (MHz)	EMISSION LEVEL (dBuV/m)	LIMIT (dBuV/m)	MARGIN (dB)	ANTENNA HEIGHT (m)	TABLE ANGLE (Degree)	RAW VALUE (dBuV)	CORRECTION FACTOR (dB/m)
1	#5559.35	61.5 PK	68.2	-6.7	1.00 H	59	58.4	3.1
2	*5745.00	122.4 PK			1.00 H	59	119.1	3.3
3	*5745.00	111.3 AV			1.00 H	59	108.0	3.3
4	#5997.22	57.6 PK	68.2	-10.6	1.00 H	59	53.9	3.7
5	11490.00	57.8 PK	74.0	-16.2	2.02 H	80	44.4	13.4
6	11490.00	44.5 AV	54.0	-9.5	2.02 H	80	31.1	13.4
7	#17235.00	49.6 PK	74.0	-24.4	1.00 H	277	32.9	16.7
8	#17235.00	39.8 AV	54.0	-14.2	1.00 H	277	23.1	16.7

ANTENNA POLARITY & TEST DISTANCE: VERTICAL AT 3 M

NO.	FREQ. (MHz)	EMISSION LEVEL (dBuV/m)	LIMIT (dBuV/m)	MARGIN (dB)	ANTENNA HEIGHT (m)	TABLE ANGLE (Degree)	RAW VALUE (dBuV)	CORRECTION FACTOR (dB/m)
1	#5618.21	57.4 PK	68.2	-10.8	3.66 V	333	54.1	3.3
2	*5745.00	115.4 PK			3.66 V	333	112.1	3.3
3	*5745.00	104.6 AV			3.66 V	333	101.3	3.3
4	#5986.28	56.2 PK	68.2	-12.0	3.66 V	333	52.5	3.7
5	11490.00	59.4 PK	74.0	-14.6	1.21 V	6	46.0	13.4
6	11490.00	46.1 AV	54.0	-7.9	1.21 V	6	32.7	13.4
7	#17235.00	51.2 PK	74.0	-22.8	1.06 V	175	34.5	16.7
8	#17235.00	40.2 AV	54.0	-13.8	1.06 V	175	23.5	16.7

REMARKS:

1. Emission Level(dBuV/m) = Raw Value(dBuV) + Correction Factor(dB/m)
2. Correction Factor(dB/m) = Antenna Factor(dB/m) + Cable Factor(dB) – Pre-Amplifier Factor(dB)
3. The other emission levels were very low against the limit.
4. Margin value = Emission Level – Limit value
5. " * ": Fundamental frequency.
6. " # ": The radiated frequency is out of the restricted band.

CHANNEL	TX Channel 157	DETECTOR FUNCTION	Peak (PK)
FREQUENCY RANGE	1GHz ~ 40GHz		Average (AV)

ANTENNA POLARITY & TEST DISTANCE: HORIZONTAL AT 3 M

NO.	FREQ. (MHz)	EMISSION LEVEL (dBuV/m)	LIMIT (dBuV/m)	MARGIN (dB)	ANTENNA HEIGHT (m)	TABLE ANGLE (Degree)	RAW VALUE (dBuV)	CORRECTION FACTOR (dB/m)
1	#5591.57	61.4 PK	68.2	-6.8	1.01 H	62	58.2	3.2
2	*5785.00	122.2 PK			1.01 H	62	118.9	3.3
3	*5785.00	111.2 AV			1.01 H	62	107.9	3.3
4	#5978.31	57.8 PK	68.2	-10.4	1.01 H	62	54.2	3.6
5	11570.00	58.2 PK	74.0	-15.8	2.00 H	83	44.8	13.4
6	11570.00	44.7 AV	54.0	-9.3	2.00 H	83	31.3	13.4
7	#17355.00	49.4 PK	74.0	-24.6	1.00 H	275	32.1	17.3
8	#17355.00	39.7 AV	54.0	-14.3	1.00 H	275	22.4	17.3

ANTENNA POLARITY & TEST DISTANCE: VERTICAL AT 3 M

NO.	FREQ. (MHz)	EMISSION LEVEL (dBuV/m)	LIMIT (dBuV/m)	MARGIN (dB)	ANTENNA HEIGHT (m)	TABLE ANGLE (Degree)	RAW VALUE (dBuV)	CORRECTION FACTOR (dB/m)
1	#5617.02	56.8 PK	68.2	-11.4	3.62 V	330	53.5	3.3
2	*5785.00	114.5 PK			3.62 V	330	111.2	3.3
3	*5785.00	104.2 AV			3.62 V	330	100.9	3.3
4	#5975.10	57.1 PK	68.2	-11.1	3.62 V	330	53.5	3.6
5	11570.00	59.1 PK	74.0	-14.9	1.23 V	21	45.7	13.4
6	11570.00	45.7 AV	54.0	-8.3	1.23 V	21	32.3	13.4
7	#17355.00	51.3 PK	74.0	-22.7	1.08 V	168	34.0	17.3
8	#17355.00	40.3 AV	54.0	-13.7	1.08 V	168	23.0	17.3

REMARKS:

1. Emission Level(dBuV/m) = Raw Value(dBuV) + Correction Factor(dB/m)
2. Correction Factor(dB/m) = Antenna Factor(dB/m) + Cable Factor(dB) – Pre-Amplifier Factor(dB)
3. The other emission levels were very low against the limit.
4. Margin value = Emission Level – Limit value
5. " * ": Fundamental frequency.
6. " # ": The radiated frequency is out of the restricted band.

CHANNEL	TX Channel 165	DETECTOR FUNCTION	Peak (PK)
FREQUENCY RANGE	1GHz ~ 40GHz		Average (AV)

ANTENNA POLARITY & TEST DISTANCE: HORIZONTAL AT 3 M

NO.	FREQ. (MHz)	EMISSION LEVEL (dBuV/m)	LIMIT (dBuV/m)	MARGIN (dB)	ANTENNA HEIGHT (m)	TABLE ANGLE (Degree)	RAW VALUE (dBuV)	CORRECTION FACTOR (dB/m)
1	#5642.81	62.8 PK	68.2	-5.4	1.00 H	66	59.6	3.2
2	*5825.00	121.9 PK			1.00 H	66	118.4	3.5
3	*5825.00	111.0 AV			1.00 H	66	107.5	3.5
4	#5934.05	59.3 PK	68.2	-8.9	1.00 H	66	55.7	3.6
5	11650.00	57.3 PK	74.0	-16.7	2.07 H	74	44.0	13.3
6	11650.00	44.1 AV	54.0	-9.9	2.07 H	74	30.8	13.3
7	#17475.00	49.1 PK	74.0	-24.9	1.03 H	267	30.9	18.2
8	#17475.00	39.4 AV	54.0	-14.6	1.03 H	267	21.2	18.2

ANTENNA POLARITY & TEST DISTANCE: VERTICAL AT 3 M

NO.	FREQ. (MHz)	EMISSION LEVEL (dBuV/m)	LIMIT (dBuV/m)	MARGIN (dB)	ANTENNA HEIGHT (m)	TABLE ANGLE (Degree)	RAW VALUE (dBuV)	CORRECTION FACTOR (dB/m)
1	#5573.86	56.5 PK	68.2	-11.7	3.61 V	329	53.3	3.2
2	*5825.00	114.8 PK			3.61 V	329	111.3	3.5
3	*5825.00	104.4 AV			3.61 V	329	100.9	3.5
4	#5946.09	58.0 PK	68.2	-10.2	3.61 V	329	54.5	3.5
5	11650.00	59.7 PK	74.0	-14.3	1.22 V	1	46.4	13.3
6	11650.00	46.5 AV	54.0	-7.5	1.22 V	1	33.2	13.3
7	#17475.00	47.8 PK	74.0	-26.2	1.69 V	3	29.6	18.2
8	#17475.00	36.8 AV	54.0	-17.2	1.69 V	3	18.6	18.2

REMARKS:

1. Emission Level(dBuV/m) = Raw Value(dBuV) + Correction Factor(dB/m)
2. Correction Factor(dB/m) = Antenna Factor(dB/m) + Cable Factor(dB) – Pre-Amplifier Factor(dB)
3. The other emission levels were very low against the limit.
4. Margin value = Emission Level – Limit value
5. " * ": Fundamental frequency.
6. " # ": The radiated frequency is out of the restricted band.

802.11ac (VHT40)

CHANNEL	TX Channel 38	DETECTOR FUNCTION	Peak (PK)
FREQUENCY RANGE	1GHz ~ 40GHz		Average (AV)

ANTENNA POLARITY & TEST DISTANCE: HORIZONTAL AT 3 M

NO.	FREQ. (MHz)	EMISSION LEVEL (dBuV/m)	LIMIT (dBuV/m)	MARGIN (dB)	ANTENNA HEIGHT (m)	TABLE ANGLE (Degree)	RAW VALUE (dBuV)	CORRECTION FACTOR (dB/m)
1	5150.00	68.2 PK	74.0	-5.8	1.37 H	354	65.2	3.0
2	5150.00	53.3 AV	54.0	-0.7	1.37 H	354	50.3	3.0
3	*5190.00	110.9 PK			1.37 H	354	108.1	2.8
4	*5190.00	101.6 AV			1.37 H	354	98.8	2.8
5	5350.00	51.8 PK	74.0	-22.2	1.37 H	354	49.2	2.6
6	5350.00	43.8 AV	54.0	-10.2	1.37 H	354	41.2	2.6
7	#10380.00	51.1 PK	74.0	-22.9	1.24 H	190	38.7	12.4
8	#10380.00	39.6 AV	54.0	-14.4	1.24 H	190	27.2	12.4
9	15570.00	54.3 PK	74.0	-19.7	1.55 H	146	41.5	12.8
10	15570.00	41.6 AV	54.0	-12.4	1.55 H	146	28.8	12.8

ANTENNA POLARITY & TEST DISTANCE: VERTICAL AT 3 M

NO.	FREQ. (MHz)	EMISSION LEVEL (dBuV/m)	LIMIT (dBuV/m)	MARGIN (dB)	ANTENNA HEIGHT (m)	TABLE ANGLE (Degree)	RAW VALUE (dBuV)	CORRECTION FACTOR (dB/m)
1	5150.00	66.3 PK	74.0	-7.7	3.56 V	327	63.3	3.0
2	5150.00	49.8 AV	54.0	-4.2	3.56 V	327	46.8	3.0
3	*5190.00	103.2 PK			3.56 V	327	100.4	2.8
4	*5190.00	94.5 AV			3.56 V	327	91.7	2.8
5	5350.00	48.5 PK	74.0	-25.5	3.56 V	327	45.9	2.6
6	5350.00	39.8 AV	54.0	-14.2	3.56 V	327	37.2	2.6
7	#10380.00	52.6 PK	74.0	-21.4	1.47 V	14	40.2	12.4
8	#10380.00	40.4 AV	54.0	-13.6	1.47 V	14	28.0	12.4
9	15570.00	55.6 PK	74.0	-18.4	3.70 V	348	42.8	12.8
10	15570.00	42.5 AV	54.0	-11.5	3.70 V	348	29.7	12.8

REMARKS:

1. Emission Level(dBuV/m) = Raw Value(dBuV) + Correction Factor(dB/m)
2. Correction Factor(dB/m) = Antenna Factor(dB/m) + Cable Factor(dB) – Pre-Amplifier Factor(dB)
3. The other emission levels were very low against the limit.
4. Margin value = Emission Level – Limit value
5. " * ": Fundamental frequency.
6. " # ": The radiated frequency is out of the restricted band.

CHANNEL	TX Channel 46	DETECTOR FUNCTION	Peak (PK)
FREQUENCY RANGE	1GHz ~ 40GHz		Average (AV)

ANTENNA POLARITY & TEST DISTANCE: HORIZONTAL AT 3 M

NO.	FREQ. (MHz)	EMISSION LEVEL (dBuV/m)	LIMIT (dBuV/m)	MARGIN (dB)	ANTENNA HEIGHT (m)	TABLE ANGLE (Degree)	RAW VALUE (dBuV)	CORRECTION FACTOR (dB/m)
1	*5230.00	117.2 PK			1.01 H	75	114.7	2.5
2	*5230.00	107.5 AV			1.01 H	75	105.0	2.5
3	5350.00	71.6 PK	74.0	-2.4	1.01 H	75	69.0	2.6
4	5350.00	52.8 AV	54.0	-1.2	1.01 H	75	50.2	2.6
5	#10460.00	53.8 PK	74.0	-20.2	1.28 H	203	40.9	12.9
6	#10460.00	42.1 AV	54.0	-11.9	1.28 H	203	29.2	12.9
7	15690.00	56.9 PK	74.0	-17.1	1.53 H	159	44.5	12.4
8	15690.00	44.2 AV	54.0	-9.8	1.53 H	159	31.8	12.4

ANTENNA POLARITY & TEST DISTANCE: VERTICAL AT 3 M

NO.	FREQ. (MHz)	EMISSION LEVEL (dBuV/m)	LIMIT (dBuV/m)	MARGIN (dB)	ANTENNA HEIGHT (m)	TABLE ANGLE (Degree)	RAW VALUE (dBuV)	CORRECTION FACTOR (dB/m)
1	*5230.00	110.9 PK			3.53 V	329	108.4	2.5
2	*5230.00	100.6 AV			3.53 V	329	98.1	2.5
3	5350.00	66.5 PK	74.0	-7.5	3.53 V	329	63.9	2.6
4	5350.00	49.7 AV	54.0	-4.3	3.53 V	329	47.1	2.6
5	#10460.00	53.0 PK	74.0	-21.0	1.53 V	17	40.1	12.9
6	#10460.00	40.6 AV	54.0	-13.4	1.53 V	17	27.7	12.9
7	15690.00	56.3 PK	74.0	-17.7	3.72 V	348	43.9	12.4
8	15690.00	42.9 AV	54.0	-11.1	3.72 V	348	30.5	12.4

REMARKS:

1. Emission Level(dBuV/m) = Raw Value(dBuV) + Correction Factor(dB/m)
2. Correction Factor(dB/m) = Antenna Factor(dB/m) + Cable Factor(dB) – Pre-Amplifier Factor(dB)
3. The other emission levels were very low against the limit.
4. Margin value = Emission Level – Limit value
5. " * ": Fundamental frequency.
6. " # ": The radiated frequency is out of the restricted band.

CHANNEL	TX Channel 151	DETECTOR FUNCTION	Peak (PK)
FREQUENCY RANGE	1GHz ~ 40GHz		Average (AV)

ANTENNA POLARITY & TEST DISTANCE: HORIZONTAL AT 3 M

NO.	FREQ. (MHz)	EMISSION LEVEL (dBuV/m)	LIMIT (dBuV/m)	MARGIN (dB)	ANTENNA HEIGHT (m)	TABLE ANGLE (Degree)	RAW VALUE (dBuV)	CORRECTION FACTOR (dB/m)
1	#5649.90	68.1 PK	68.2	-0.1	1.00 H	66	64.9	3.2
2	*5755.00	117.4 PK			1.00 H	66	114.1	3.3
3	*5755.00	108.0 AV			1.00 H	66	104.7	3.3
4	#5962.36	58.8 PK	68.2	-9.4	1.00 H	66	55.3	3.5
5	11510.00	48.6 PK	74.0	-25.4	1.99 H	79	35.2	13.4
6	11510.00	38.8 AV	54.0	-15.2	1.99 H	79	25.4	13.4
7	#17265.00	49.6 PK	74.0	-24.4	1.00 H	282	32.8	16.8
8	#17265.00	39.6 AV	54.0	-14.4	1.00 H	282	22.8	16.8

ANTENNA POLARITY & TEST DISTANCE: VERTICAL AT 3 M

NO.	FREQ. (MHz)	EMISSION LEVEL (dBuV/m)	LIMIT (dBuV/m)	MARGIN (dB)	ANTENNA HEIGHT (m)	TABLE ANGLE (Degree)	RAW VALUE (dBuV)	CORRECTION FACTOR (dB/m)
1	#5646.34	58.8 PK	68.2	-9.4	3.63 V	336	55.6	3.2
2	*5755.00	109.8 PK			3.63 V	336	106.5	3.3
3	*5755.00	100.4 AV			3.63 V	336	97.1	3.3
4	#5992.28	57.6 PK	68.2	-10.6	3.63 V	336	53.9	3.7
5	11510.00	49.1 PK	74.0	-24.9	1.50 V	12	35.7	13.4
6	11510.00	39.0 AV	54.0	-15.0	1.50 V	12	25.6	13.4
7	#17265.00	50.0 PK	74.0	-24.0	3.71 V	334	33.2	16.8
8	#17265.00	40.2 AV	54.0	-13.8	3.71 V	334	23.4	16.8

REMARKS:

1. Emission Level(dBuV/m) = Raw Value(dBuV) + Correction Factor(dB/m)
2. Correction Factor(dB/m) = Antenna Factor(dB/m) + Cable Factor(dB) – Pre-Amplifier Factor(dB)
3. The other emission levels were very low against the limit.
4. Margin value = Emission Level – Limit value
5. " * ": Fundamental frequency.
6. " # ": The radiated frequency is out of the restricted band.

CHANNEL	TX Channel 159	DETECTOR FUNCTION	Peak (PK)
FREQUENCY RANGE	1GHz ~ 40GHz		Average (AV)

ANTENNA POLARITY & TEST DISTANCE: HORIZONTAL AT 3 M

NO.	FREQ. (MHz)	EMISSION LEVEL (dBuV/m)	LIMIT (dBuV/m)	MARGIN (dB)	ANTENNA HEIGHT (m)	TABLE ANGLE (Degree)	RAW VALUE (dBuV)	CORRECTION FACTOR (dB/m)
1	#5654.14	67.8 PK	71.3	-3.5	1.00 H	67	64.5	3.3
2	*5795.00	119.1 PK			1.00 H	67	115.8	3.3
3	*5795.00	109.2 AV			1.00 H	67	105.9	3.3
4	#5932.17	68.1 PK	68.2	-0.1	1.00 H	67	64.5	3.6
5	11590.00	48.1 PK	74.0	-25.9	2.02 H	88	34.7	13.4
6	11590.00	38.3 AV	54.0	-15.7	2.02 H	88	24.9	13.4
7	#17385.00	49.0 PK	74.0	-25.0	1.02 H	280	31.5	17.5
8	#17385.00	39.3 AV	54.0	-14.7	1.02 H	280	21.8	17.5

ANTENNA POLARITY & TEST DISTANCE: VERTICAL AT 3 M

NO.	FREQ. (MHz)	EMISSION LEVEL (dBuV/m)	LIMIT (dBuV/m)	MARGIN (dB)	ANTENNA HEIGHT (m)	TABLE ANGLE (Degree)	RAW VALUE (dBuV)	CORRECTION FACTOR (dB/m)
1	#5648.88	59.2 PK	68.2	-9.0	3.61 V	332	56.0	3.2
2	*5795.00	111.5 PK			3.61 V	332	108.2	3.3
3	*5795.00	102.2 AV			3.61 V	332	98.9	3.3
4	#5929.32	63.0 PK	68.2	-5.2	3.61 V	332	59.4	3.6
5	11590.00	49.2 PK	74.0	-24.8	1.54 V	0	35.8	13.4
6	11590.00	39.3 AV	54.0	-14.7	1.54 V	0	25.9	13.4
7	#17385.00	50.3 PK	74.0	-23.7	3.69 V	337	32.8	17.5
8	#17385.00	40.5 AV	54.0	-13.5	3.69 V	337	23.0	17.5

REMARKS:

1. Emission Level(dBuV/m) = Raw Value(dBuV) + Correction Factor(dB/m)
2. Correction Factor(dB/m) = Antenna Factor(dB/m) + Cable Factor(dB) – Pre-Amplifier Factor(dB)
3. The other emission levels were very low against the limit.
4. Margin value = Emission Level – Limit value
5. " * ": Fundamental frequency.
6. " # ": The radiated frequency is out of the restricted band.

802.11ac (VHT80)

CHANNEL	TX Channel 42	DETECTOR FUNCTION	Peak (PK)
FREQUENCY RANGE	1GHz ~ 40GHz		Average (AV)

ANTENNA POLARITY & TEST DISTANCE: HORIZONTAL AT 3 M

NO.	FREQ. (MHz)	EMISSION LEVEL (dBuV/m)	LIMIT (dBuV/m)	MARGIN (dB)	ANTENNA HEIGHT (m)	TABLE ANGLE (Degree)	RAW VALUE (dBuV)	CORRECTION FACTOR (dB/m)
1	5150.00	69.8 PK	74.0	-4.2	2.16 H	343	66.8	3.0
2	5150.00	53.9 AV	54.0	-0.1	2.16 H	343	50.9	3.0
3	*5210.00	109.1 PK			2.16 H	343	106.4	2.7
4	*5210.00	99.5 AV			2.16 H	343	96.8	2.7
5	5350.00	57.3 PK	74.0	-16.7	2.16 H	343	54.7	2.6
6	5350.00	45.5 AV	54.0	-8.5	2.16 H	343	42.9	2.6
7	#10420.00	48.2 PK	74.0	-25.8	1.26 H	180	35.6	12.6
8	#10420.00	35.6 AV	54.0	-18.4	1.26 H	180	23.0	12.6
9	15630.00	51.4 PK	74.0	-22.6	1.53 H	147	38.7	12.7
10	15630.00	38.8 AV	54.0	-15.2	1.53 H	147	26.1	12.7

ANTENNA POLARITY & TEST DISTANCE: VERTICAL AT 3 M

NO.	FREQ. (MHz)	EMISSION LEVEL (dBuV/m)	LIMIT (dBuV/m)	MARGIN (dB)	ANTENNA HEIGHT (m)	TABLE ANGLE (Degree)	RAW VALUE (dBuV)	CORRECTION FACTOR (dB/m)
1	5150.00	70.6 PK	74.0	-3.4	3.53 V	310	67.6	3.0
2	5150.00	49.5 AV	54.0	-4.5	3.53 V	310	46.5	3.0
3	*5210.00	102.3 PK			3.53 V	310	99.6	2.7
4	*5210.00	92.5 AV			3.53 V	310	89.8	2.7
5	5350.00	55.0 PK	74.0	-19.0	3.53 V	310	52.4	2.6
6	5350.00	42.8 AV	54.0	-11.2	3.53 V	310	40.2	2.6
7	#10420.00	52.0 PK	74.0	-22.0	1.45 V	10	39.4	12.6
8	#10420.00	40.0 AV	54.0	-14.0	1.45 V	10	27.4	12.6
9	15630.00	55.2 PK	74.0	-18.8	3.73 V	335	42.5	12.7
10	15630.00	42.0 AV	54.0	-12.0	3.73 V	335	29.3	12.7

REMARKS:

- Emission Level(dBuV/m) = Raw Value(dBuV) + Correction Factor(dB/m)
- Correction Factor(dB/m) = Antenna Factor(dB/m) + Cable Factor(dB) – Pre-Amplifier Factor(dB)
- The other emission levels were very low against the limit.
- Margin value = Emission Level – Limit value
- " * ": Fundamental frequency.
- " # ": The radiated frequency is out of the restricted band.

CHANNEL	TX Channel 155	DETECTOR FUNCTION	Peak (PK)
FREQUENCY RANGE	1GHz ~ 40GHz		Average (AV)

ANTENNA POLARITY & TEST DISTANCE: HORIZONTAL AT 3 M

NO.	FREQ. (MHz)	EMISSION LEVEL (dBuV/m)	LIMIT (dBuV/m)	MARGIN (dB)	ANTENNA HEIGHT (m)	TABLE ANGLE (Degree)	RAW VALUE (dBuV)	CORRECTION FACTOR (dB/m)
1	#5649.00	68.1 PK	68.2	-0.1	1.06 H	358	64.9	3.2
2	*5775.00	109.0 PK			2.33 H	339	105.6	3.4
3	*5775.00	99.8 AV			2.33 H	339	96.4	3.4
4	#5930.63	63.3 PK	68.2	-4.9	1.06 H	358	59.7	3.6
5	11550.00	48.4 PK	74.0	-25.6	2.04 H	73	35.1	13.3
6	11550.00	38.6 AV	54.0	-15.4	2.04 H	73	25.3	13.3
7	#17325.00	49.9 PK	74.0	-24.1	1.00 H	297	32.8	17.1
8	#17325.00	39.8 AV	54.0	-14.2	1.00 H	297	22.7	17.1

ANTENNA POLARITY & TEST DISTANCE: VERTICAL AT 3 M

NO.	FREQ. (MHz)	EMISSION LEVEL (dBuV/m)	LIMIT (dBuV/m)	MARGIN (dB)	ANTENNA HEIGHT (m)	TABLE ANGLE (Degree)	RAW VALUE (dBuV)	CORRECTION FACTOR (dB/m)
1	#5646.69	65.0 PK	68.2	-3.2	3.59 V	328	61.8	3.2
2	*5775.00	103.6 PK			3.59 V	328	100.2	3.4
3	*5775.00	94.2 AV			3.59 V	328	90.8	3.4
4	#5928.88	62.1 PK	68.2	-6.1	3.59 V	328	58.5	3.6
5	11550.00	49.1 PK	74.0	-24.9	1.50 V	0	35.8	13.3
6	11550.00	39.1 AV	54.0	-14.9	1.50 V	0	25.8	13.3
7	#17325.00	50.1 PK	74.0	-23.9	3.73 V	345	33.0	17.1
8	#17325.00	40.1 AV	54.0	-13.9	3.73 V	345	23.0	17.1

REMARKS:

1. Emission Level(dBuV/m) = Raw Value(dBuV) + Correction Factor(dB/m)
2. Correction Factor(dB/m) = Antenna Factor(dB/m) + Cable Factor(dB) – Pre-Amplifier Factor(dB)
3. The other emission levels were very low against the limit.
4. Margin value = Emission Level – Limit value
5. " * ": Fundamental frequency.
6. " # ": The radiated frequency is out of the restricted band.

Below 1GHz Data:

802.11ac (VHT40)

CHANNEL	TX Channel 159	DETECTOR FUNCTION	Quasi-Peak (QP)
FREQUENCY RANGE	9kHz ~ 1GHz		

ANTENNA POLARITY & TEST DISTANCE: HORIZONTAL AT 3 M

NO.	FREQ. (MHz)	EMISSION LEVEL (dBuV/m)	LIMIT (dBuV/m)	MARGIN (dB)	ANTENNA HEIGHT (m)	TABLE ANGLE (Degree)	RAW VALUE (dBuV)	CORRECTION FACTOR (dB/m)
1	121.04	26.0 QP	43.5	-17.5	1.50 H	56	35.6	-9.6
2	256.10	29.6 QP	46.0	-16.4	1.00 H	102	38.3	-8.7
3	303.41	31.9 QP	46.0	-14.1	1.00 H	48	38.9	-7.0
4	388.13	32.7 QP	46.0	-13.3	1.00 H	29	37.2	-4.5
5	420.73	33.1 QP	46.0	-12.9	1.00 H	57	36.7	-3.6
6	632.80	31.7 QP	46.0	-14.3	1.50 H	22	30.3	1.4

ANTENNA POLARITY & TEST DISTANCE: VERTICAL AT 3 M

NO.	FREQ. (MHz)	EMISSION LEVEL (dBuV/m)	LIMIT (dBuV/m)	MARGIN (dB)	ANTENNA HEIGHT (m)	TABLE ANGLE (Degree)	RAW VALUE (dBuV)	CORRECTION FACTOR (dB/m)
1	45.93	32.9 QP	40.0	-7.1	1.00 V	32	40.8	-7.9
2	129.64	25.3 QP	43.5	-18.2	1.00 V	69	34.3	-9.0
3	305.96	29.5 QP	46.0	-16.5	1.50 V	308	36.4	-6.9
4	388.46	30.3 QP	46.0	-15.7	1.00 V	337	34.8	-4.5
5	420.86	31.0 QP	46.0	-15.0	1.00 V	345	34.6	-3.6
6	637.17	31.3 QP	46.0	-14.7	1.00 V	109	29.9	1.4

REMARKS:

1. Emission Level(dBuV/m) = Raw Value(dBuV) + Correction Factor(dB/m)
2. Correction Factor(dB/m) = Antenna Factor(dB/m) + Cable Factor(dB) – Pre-Amplifier Factor(dB)
3. The other emission levels were very low against the limit.
4. Margin value = Emission Level – Limit value

4.2 Conducted Emission Measurement

4.2.1 Limits of Conducted Emission Measurement

Frequency (MHz)	Conducted Limit (dBuV)	
	Quasi-peak	Average
0.15 - 0.5	66 - 56	56 - 46
0.50 - 5.0	56	46
5.0 - 30.0	60	50

Note: 1. The lower limit shall apply at the transition frequencies.

2. The limit decreases in line with the logarithm of the frequency in the range of 0.15 to 0.50MHz.

4.2.2 Test Instruments

DESCRIPTION & MANUFACTURER	MODEL NO.	SERIAL NO.	CALIBRATED DATE	CALIBRATED UNTIL
Test Receiver R&S	ESCS 30	100375	May 15, 2018	May 14, 2019
Line-Impedance Stabilization Network (for EUT) SCHWARZBECK	NSLK-8127	8127-522	Aug. 31, 2017	Aug. 30, 2018
Line-Impedance Stabilization Network (for Peripheral) R&S	ENV 216	10072	June 04, 2018	June 03, 2019
RF Cable	5D-FB	COACAB-002	Feb. 23, 2018	Feb. 22, 2019
10 dB PAD EMEC	STI02-2200-10	001	Mar. 16, 2018	Mar. 15, 2019
50 ohms Terminator	N/A	EMC-03	Sep. 22, 2017	Sep. 21, 2018
50 ohms Terminator	N/A	EMC-02	Sep. 22, 2017	Sep. 21, 2018
Software BVADT	BVADT_Cond_ V7.3.7.4	NA	NA	NA

Note:

1. The calibration interval of the above test instruments are 12 months and the calibrations are traceable to NML/ROC and NIST/USA.
2. The test was performed in Conducted Room C
3. The VCCI Con C Registration No. is C-3611.
4. Tested Date: July 04, 2018

4.2.3 Test Procedure

- The EUT was placed 0.4 meters from the conducting wall of the shielded room with EUT being connected to the power mains through a line impedance stabilization network (LISN). Other support units were connected to the power mains through another LISN. The two LISNs provide 50 ohm/ 50uH of coupling impedance for the measuring instrument.
- Both lines of the power mains connected to the EUT were checked for maximum conducted interference.
- The frequency range from 150kHz to 30MHz was searched. Emission levels under (Limit - 20dB) was not recorded.

NOTE: All modes of operation were investigated and the worst-case emissions are reported.

4.2.4 Deviation from Test Standard

No deviation.

4.2.5 Test Setup

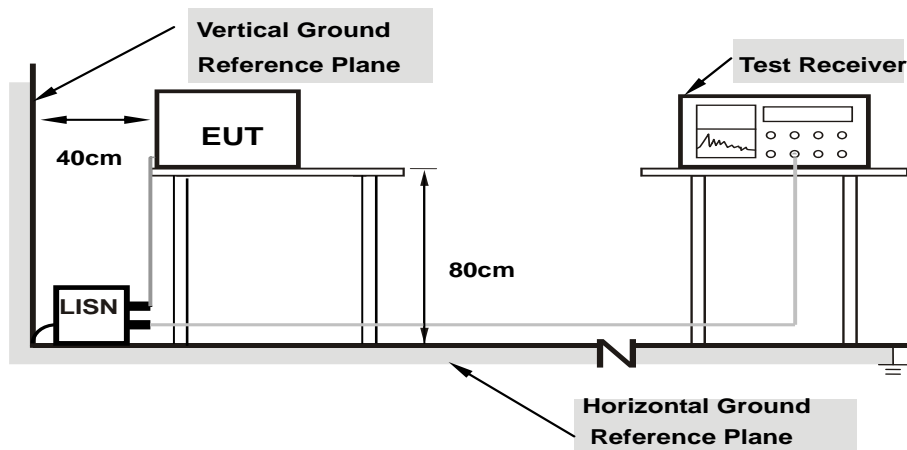

Note: 1.Support units were connected to second LISN.

For the actual test configuration, please refer to the attached file (Test Setup Photo).

4.2.6 EUT Operating Condition

Same as 4.1.6.

4.2.7 Test Results

Phase	Line (L)	Detector Function	Quasi-Peak (QP) / Average (AV)
-------	----------	-------------------	--------------------------------

No	Freq.	Corr.	Reading Value		Emission Level		Limit		Margin	
	[MHz]	Factor	[dB (uV)]		[dB (uV)]		[dB (uV)]		(dB)	
		(dB)	Q.P.	AV.	Q.P.	AV.	Q.P.	AV.	Q.P.	AV.
1	0.46641	10.00	31.83	24.97	41.83	34.97	56.58	46.58	-14.75	-11.61
2	0.61484	10.01	41.53	32.97	51.54	42.98	56.00	46.00	-4.46	-3.02
3	0.72422	10.02	31.95	24.99	41.97	35.01	56.00	46.00	-14.03	-10.99
4	0.97031	10.05	25.51	15.94	35.56	25.99	56.00	46.00	-20.44	-20.01
5	1.64844	10.06	28.26	18.25	38.32	28.31	56.00	46.00	-17.68	-17.69
6	1.94922	10.06	28.87	20.21	38.93	30.27	56.00	46.00	-17.07	-15.73

REMARKS:

1. Q.P. and AV. are abbreviations of quasi-peak and average individually.
2. The emission levels of other frequencies were very low against the limit.
3. Margin value = Emission level - Limit value
4. Correction factor = Insertion loss + Cable loss
5. Emission Level = Correction Factor + Reading Value.

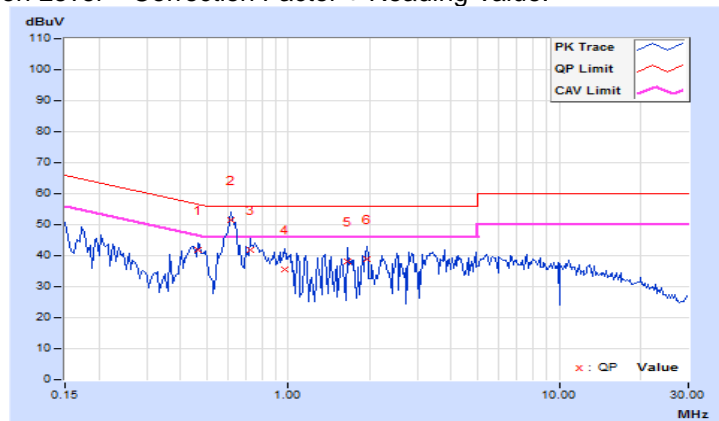

Phase	Neutral (N)	Detector Function	Quasi-Peak (QP) / Average (AV)
-------	-------------	-------------------	--------------------------------

No	Freq.	Corr.	Reading Value		Emission Level		Limit		Margin	
	[MHz]	Factor	[dB (uV)]		[dB (uV)]		[dB (uV)]		(dB)	
		(dB)	Q.P.	AV.	Q.P.	AV.	Q.P.	AV.	Q.P.	AV.
1	0.20469	9.99	29.72	23.07	39.71	33.06	63.42	53.42	-23.71	-20.36
2	0.46641	10.02	27.67	19.85	37.69	29.87	56.58	46.58	-18.89	-16.71
3	0.61484	10.03	38.32	31.03	48.35	41.06	56.00	46.00	-7.65	-4.94
4	0.69688	10.03	26.51	18.37	36.54	28.40	56.00	46.00	-19.46	-17.60
5	1.66797	10.07	25.72	14.26	35.79	24.33	56.00	46.00	-20.21	-21.67
6	2.78516	10.13	24.11	12.98	34.24	23.11	56.00	46.00	-21.76	-22.89

REMARKS:

1. Q.P. and AV. are abbreviations of quasi-peak and average individually.
2. The emission levels of other frequencies were very low against the limit.
3. Margin value = Emission level - Limit value
4. Correction factor = Insertion loss + Cable loss
5. Emission Level = Correction Factor + Reading Value.

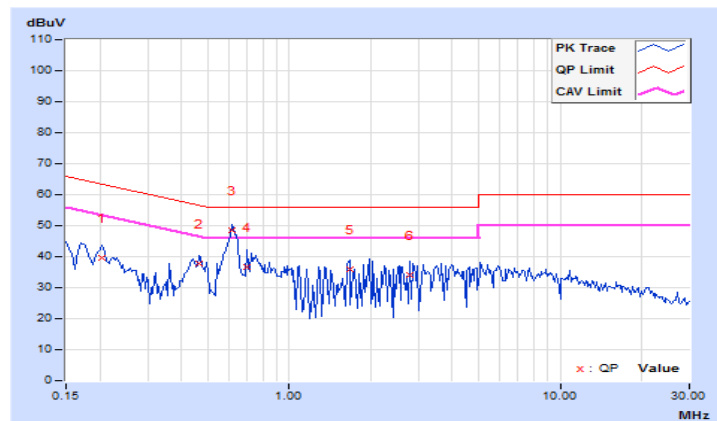

4.3 Transmit Power Measurement

4.3.1 Limits of Transmit Power Measurement

Operation Band	EUT Category		Limit
U-NII-1		Outdoor Access Point	1 Watt (30 dBm) (Max. e.i.r.p \leq 125mW(21 dBm) at any elevation angle above 30 degrees as measured from the horizon)
		Fixed point-to-point Access Point	1 Watt (30 dBm)
	√	Indoor Access Point	1 Watt (30 dBm)
		Client device	250mW (24 dBm)
U-NII-2A	---		250mW (24 dBm) or 11 dBm+10 log B*
U-NII-2C	---		250mW (24 dBm) or 11 dBm+10 log B*
U-NII-3	√		1 Watt (30 dBm)

*B is the 26 dB emission bandwidth in megahertz

Per KDB 662911 Method of conducted output power measurement on IEEE 802.11 devices,

Array Gain = 0 dB (i.e., no array gain) for $N_{ANT} \leq 4$;

Array Gain = 0 dB (i.e., no array gain) for channel widths ≥ 40 MHz for any N_{ANT} ;

Array Gain = $5 \log(N_{ANT}/N_{SS})$ dB or 3 dB, whichever is less for 20-MHz channel widths with $N_{ANT} \geq 5$.

For power measurements on all other devices: Array Gain = $10 \log(N_{ANT}/N_{SS})$ dB.

4.3.2 Test Setup

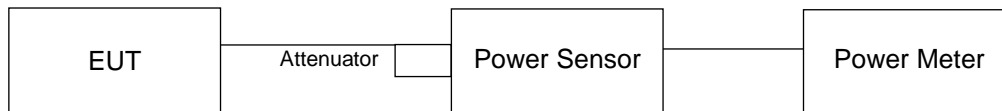

4.3.3 Test Instruments

Refer to section 4.1.2 to get information of above instrument.

4.3.4 Test Procedure

Method PM is used to perform output power measurement, trigger and gating function of wide band power meter is enabled to measure max output power of TX on burst. Duty factor is not added to measured value.

4.3.5 Deviation from Test Standard

No deviation.

4.3.6 EUT Operating Condition

The software provided by client to enable the EUT under transmission condition continuously at lowest, middle and highest channel frequencies individually.

4.3.7 Test Result

CDD Mode

802.11a

Chan.	Chan. Freq. (MHz)	Maximum Conducted Power (dBm)		Total Power (mW)	Total Power (dBm)	Limit (dBm)	Pass / Fail
		Chain 0	Chain 1				
36	5180	19.35	19.75	180.505	22.56	30.00	Pass
40	5200	22.45	22.78	365.463	25.63	30.00	Pass
48	5240	21.78	22.11	313.216	24.96	30.00	Pass
149	5745	22.51	22.62	361.048	25.58	30.00	Pass
157	5785	22.06	22.24	328.188	25.16	30.00	Pass
165	5825	21.25	21.79	284.36	24.54	30.00	Pass

802.11ac (VHT20)

Chan.	Chan. Freq. (MHz)	Maximum Conducted Power (dBm)		Total Power (mW)	Total Power (dBm)	Limit (dBm)	Pass / Fail
		Chain 0	Chain 1				
36	5180	21.02	21.42	265.15	24.23	30.00	Pass
40	5200	22.94	23.15	403.327	26.06	30.00	Pass
48	5240	21.68	22.03	306.819	24.87	30.00	Pass
149	5745	23.78	24.02	491.129	26.91	30.00	Pass
157	5785	23.89	24.08	500.765	27.00	30.00	Pass
165	5825	23.85	24.12	500.887	27.00	30.00	Pass

802.11ac (VHT40)

Chan.	Chan. Freq. (MHz)	Maximum Conducted Power (dBm)		Total Power (mW)	Total Power (dBm)	Limit (dBm)	Pass / Fail
		Chain 0	Chain 1				
38	5190	17.45	17.96	118.107	20.72	30.00	Pass
46	5230	20.78	21.02	246.148	23.91	30.00	Pass
151	5755	21.48	21.75	290.229	24.63	30.00	Pass
159	5795	23.84	24.45	520.715	27.17	30.00	Pass

802.11ac (VHT80)

Chan.	Chan. Freq. (MHz)	Maximum Conducted Power (dBm)		Total Power (mW)	Total Power (dBm)	Limit (dBm)	Pass / Fail
		Chain 0	Chain 1				
42	5210	17.45	17.76	115.294	20.62	30.00	Pass
155	5775	19.23	19.64	175.798	22.45	30.00	Pass

Beamforming Mode

802.11ac (VHT20)

Chan.	Chan. Freq. (MHz)	Maximum Conducted Power (dBm)		Total Power (mW)	Total Power (dBm)	Limit (dBm)	Pass / Fail
		Chain 0	Chain 1				
36	5180	21.02	21.42	265.15	24.23	29.46	Pass
40	5200	22.94	23.15	403.327	26.06	29.46	Pass
48	5240	21.68	22.03	306.819	24.87	29.46	Pass
149	5745	23.78	24.02	491.129	26.91	29.46	Pass
157	5785	23.89	24.08	500.765	27.00	29.46	Pass
165	5825	23.85	24.12	500.887	27.00	29.46	Pass

Note: 1. Directional gain = $10 \log[(10^{G0/20} + 10^{G1/20})^2 / 2] = 6.54\text{dBi} > 6\text{dBi}$, so the power limit shall be reduced to $30 - (6.54 - 6) = 29.46\text{dBm}$.

802.11ac (VHT40)

Chan.	Chan. Freq. (MHz)	Maximum Conducted Power (dBm)		Total Power (mW)	Total Power (dBm)	Limit (dBm)	Pass / Fail
		Chain 0	Chain 1				
38	5190	17.45	17.96	118.107	20.72	29.46	Pass
46	5230	20.78	21.02	246.148	23.91	29.46	Pass
151	5755	21.48	21.75	290.229	24.63	29.46	Pass
159	5795	23.84	24.45	520.715	27.17	29.46	Pass

Note: 1. Directional gain = $10 \log[(10^{G0/20} + 10^{G1/20})^2 / 2] = 6.54\text{dBi} > 6\text{dBi}$, so the power limit shall be reduced to $30 - (6.54 - 6) = 29.46\text{dBm}$.

802.11ac (VHT80)

Chan.	Chan. Freq. (MHz)	Maximum Conducted Power (dBm)		Total Power (mW)	Total Power (dBm)	Limit (dBm)	Pass / Fail
		Chain 0	Chain 1				
42	5210	17.45	17.76	115.294	20.62	29.46	Pass
155	5775	19.23	19.64	175.798	22.45	29.46	Pass

Note: 1. Directional gain = $10 \log[(10^{G0/20} + 10^{G1/20})^2 / 2] = 6.54\text{dBi} > 6\text{dBi}$, so the power limit shall be reduced to $30 - (6.54 - 6) = 29.46\text{dBm}$.

4.4 Occupied Bandwidth Measurement

4.4.1 Test Setup



4.4.2 Test Instruments

Refer to section 4.1.2 to get information of above instrument.

4.4.3 Test Procedure

The transmitter output was connected to the spectrum analyzer through an attenuator. The bandwidth of the fundamental frequency was measured by spectrum analyzer with resolution bandwidth in the range of 1% to 5% of the anticipated emission bandwidth, and a video bandwidth at least 3x the resolution bandwidth and set the detector to SAMPLE. The width of a frequency band such that, below the lower and above the upper frequency limits, the mean powers emitted are each equal to a specified percentage 0.5 %of the total mean power of a given emission.

4.4.4 Test Results

802.11a

Channel	Channel Frequency (MHz)	Occupied Bandwidth (MHz)	
		Chain 0	Chain 1
36	5180	16.68	17.28
40	5200	20.52	23.04
48	5240	16.92	18.96
149	5745	19.68	17.04
157	5785	19.44	16.92
165	5825	18.12	17.04

802.11ac (VHT20)

Channel	Channel Frequency (MHz)	Occupied Bandwidth (MHz)	
		Chain 0	Chain 1
36	5180	18.00	18.24
40	5200	24.36	24.36
48	5240	18.24	18.96
149	5745	30.96	25.32
157	5785	31.32	27.60
165	5825	31.20	27.24

802.11ac (VHT40)

Channel	Channel Frequency (MHz)	Occupied Bandwidth (MHz)	
		Chain 0	Chain 1
38	5190	36.24	36.24
46	5230	36.72	36.72
151	5755	36.72	36.72
159	5795	60.00	61.68

802.11ac (VHT80)

Channel	Channel Frequency (MHz)	Occupied Bandwidth (MHz)	
		Chain 0	Chain 1
42	5210	76.32	75.84
155	5775	76.32	76.32

Spectrum Plot of Worst Value

802.11a_Chain 1 / CH40

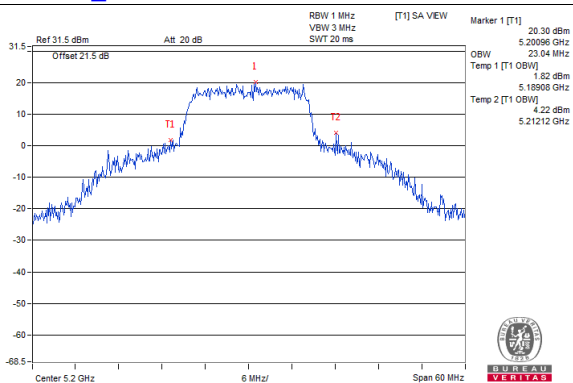

802.11ac (VHT20)_Chain 0 / CH157

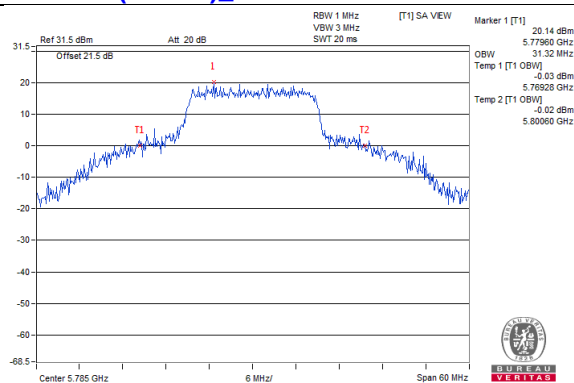

802.11ac (VHT40)_Chain 1 / CH159

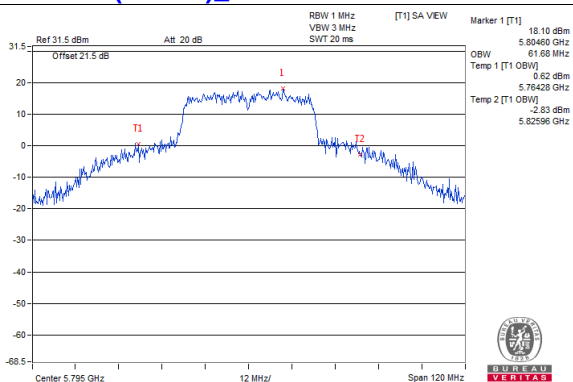

802.11ac (VHT80)_Chain 0 / CH42

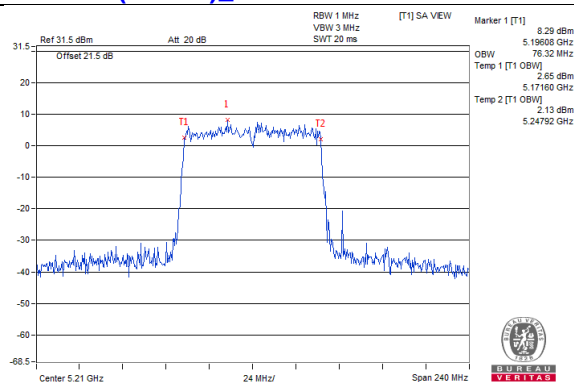

**Spectrum Plot for near by DFS band
(DFS is required, if 99% OCP straddle into U-NII-2A band)**

802.11a_Chain0 / CH48

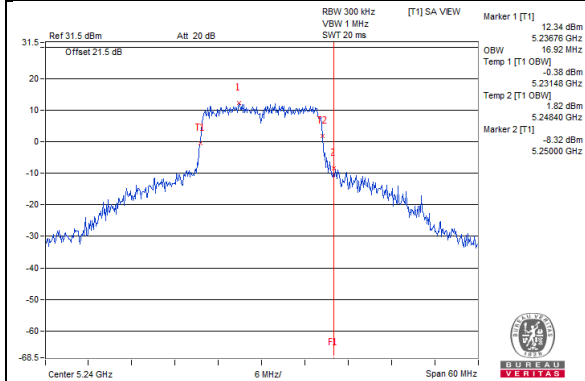

802.11a_Chain1 / CH48

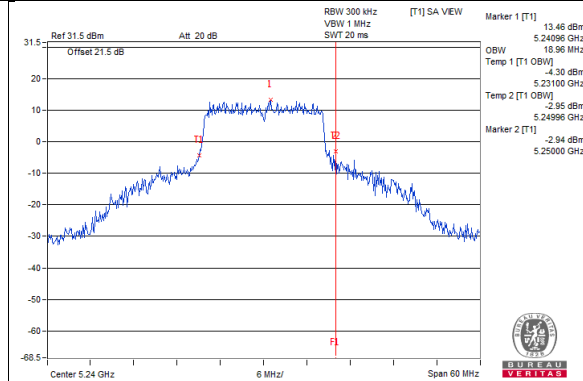

802.11ac(VHT20)_Chain0 / CH48

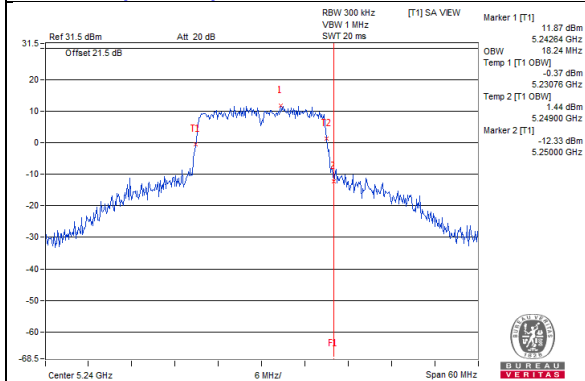

802.11ac(VHT20)_Chain1 / CH48

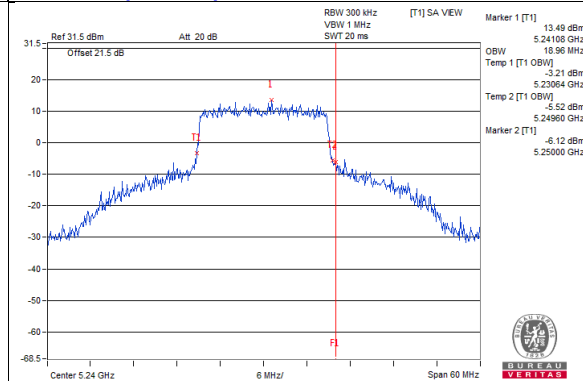

802.11ac(VHT40)_Chain0 / CH46

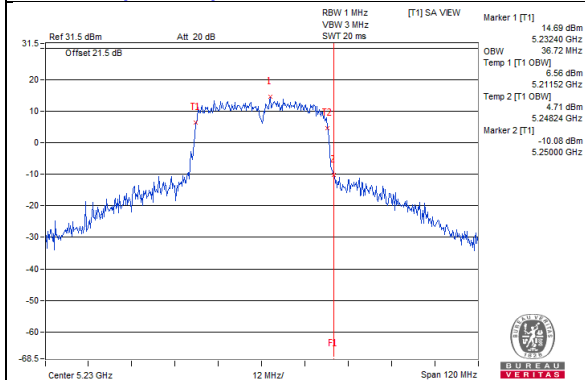

802.11ac(VHT40)_Chain1 / CH46

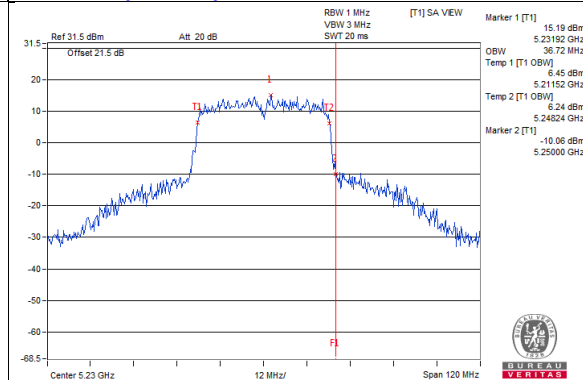

802.11ac(VHT80)_Chain0 / CH42

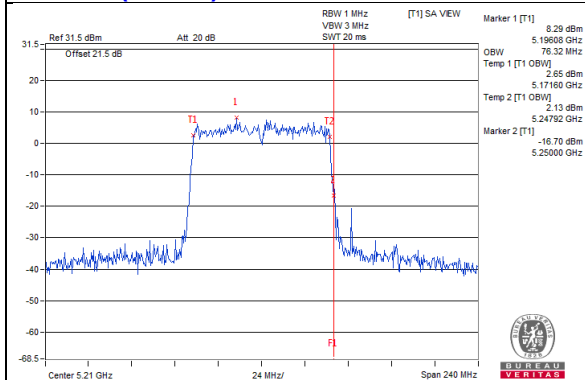

802.11ac(VHT80)_Chain1 / CH42

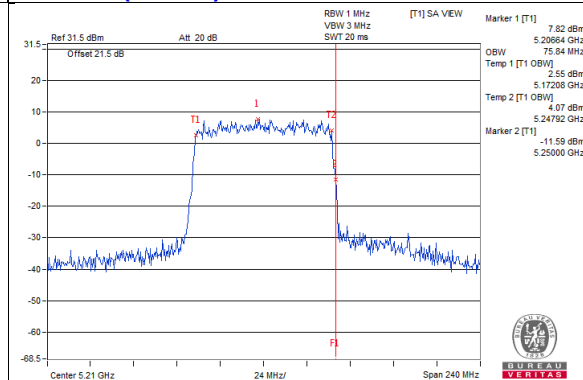

Spectrum Plot for near by DFS band (DFS is required, if 99% OCP straddle into U-NII-2C band)

802.11a_Chain0 / CH149

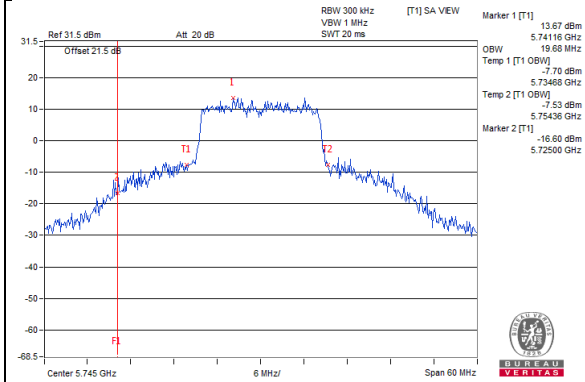

802.11a_Chain1 / CH149

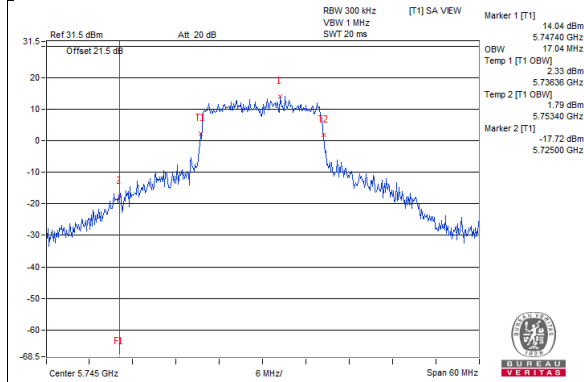

802.11ac(VHT20)_Chain0 / CH149

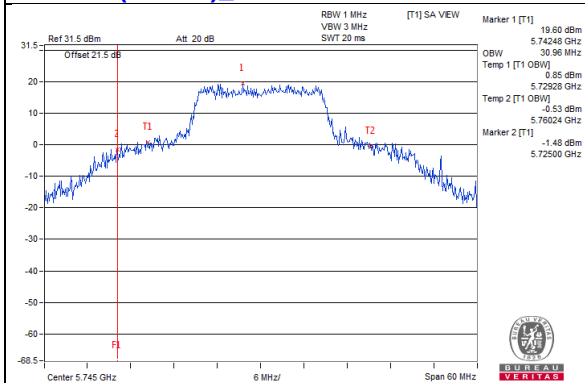

802.11ac(VHT20)_Chain1 / CH149

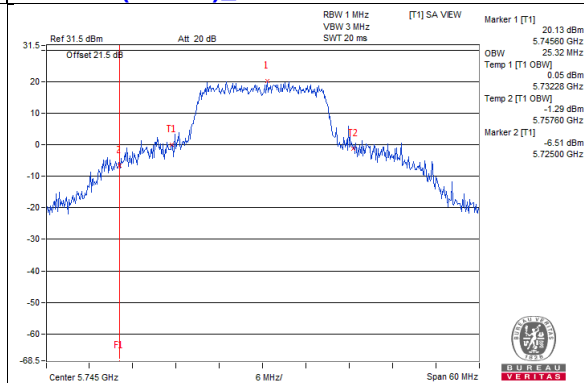

802.11ac(VHT40)_Chain0 / CH151

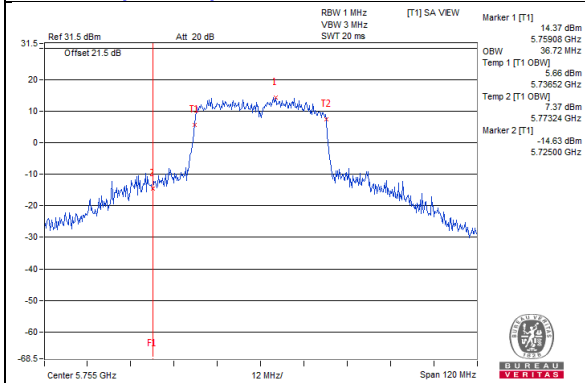

802.11ac(VHT40)_Chain1 / CH151

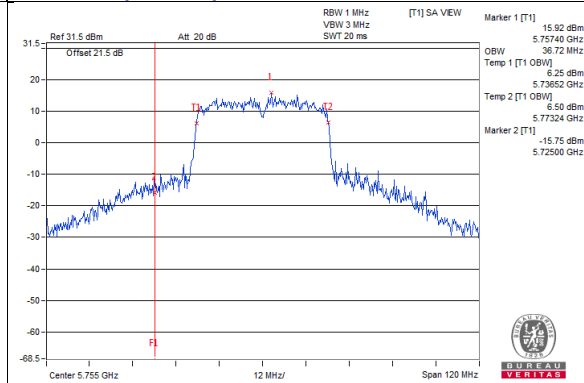

802.11ac(VHT80)_Chain0 / CH155

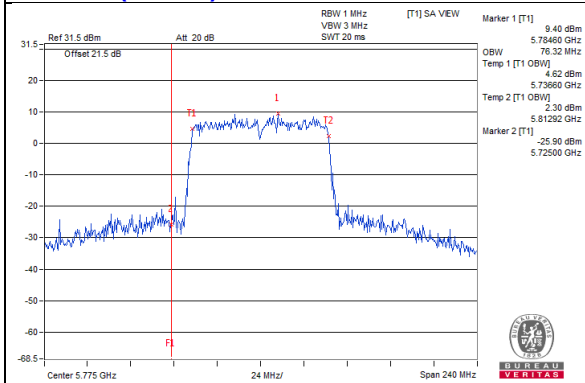

802.11ac(VHT80)_Chain1 / CH155

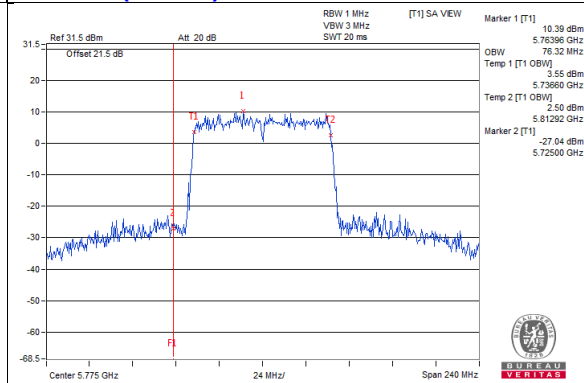

4.5 Peak Power Spectral Density Measurement

4.5.1 Limits of Peak Power Spectral Density Measurement

Operation Band	EUT Category		Limit
U-NII-1		Outdoor Access Point	17dBm/ MHz
		Fixed point-to-point Access Point	
	√	Indoor Access Point	
		Client device	
U-NII-2A	---		11dBm/ MHz
U-NII-2C	---		11dBm/ MHz
U-NII-3	√		30dBm/ 500kHz

4.5.2 Test Setup

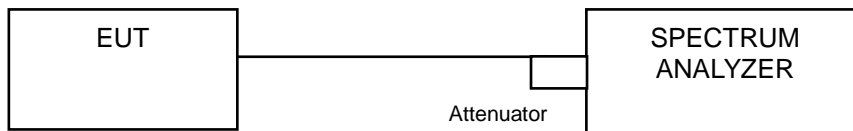

4.5.3 Test Instruments

Refer to section 4.1.2 to get information of above instrument.

4.5.4 Test Procedure

802.11ac (VHT20)

For U-NII-1:

Using method SA-1

1. Set span to encompass the entire emission bandwidth (EBW) of the signal.
2. Set RBW = 1 MHz, Set VBW \geq 3 MHz, Detector = RMS
3. Sweep time = auto, trigger set to "free run".
4. Trace average at least 100 traces in power averaging mode.
5. Record the max value

For U-NII-3:

1. Set span to encompass the entire emission bandwidth (EBW) of the signal.
2. Set RBW = 300 kHz, Set VBW \geq 1 MHz, Detector = RMS
3. Use the peak marker function to determine the maximum power level in any 300 kHz band segment within the fundamental EBW.
4. Scale the observed power level to an equivalent value in 500 kHz by adjusting (reducing) the measured power by a bandwidth correction factor (BWCF) where $BWCF = 10\log(500 \text{ kHz}/300\text{kHz})$
5. Sweep time = auto, trigger set to "free run".
6. Trace average at least 100 traces in power averaging mode.
7. Record the max value

802.11a, 802.11ac (VHT40), 802.11ac (VHT80)

For U-NII-1:

Using method SA-2

1. Set span to encompass the entire emission bandwidth (EBW) of the signal.
2. Set RBW = 1 MHz, Set VBW \geq 3 MHz, Detector = RMS
3. Sweep time = auto, trigger set to "free run".
4. Trace average at least 100 traces in power averaging mode.
5. Record the max value and add $10 \log (1/\text{duty cycle})$

For U-NII-3:

1. Set span to encompass the entire emission bandwidth (EBW) of the signal.
2. Set RBW = 300 kHz, Set VBW \geq 1 MHz, Detector = RMS
3. Use the peak marker function to determine the maximum power level in any 300 kHz band segment within the fundamental EBW.
4. Scale the observed power level to an equivalent value in 500 kHz by adjusting (reducing) the measured power by a bandwidth correction factor (BWCF) where $BWCF = 10\log(500 \text{ kHz}/300\text{kHz})$
5. Sweep time = auto, trigger set to "free run".
6. Trace average at least 100 traces in power averaging mode.
7. Record the max value and add $10 \log (1/\text{duty cycle})$

4.5.5 Deviation from Test Standard

No deviation.

4.5.6 EUT Operating Condition

Same as Item 4.3.6.

4.5.7 Test Results

For U-NII-1:

802.11a

Chan.	Chan. Freq. (MHz)	PSD W/O Duty Factor (dBm/MHz)		Duty Factor (dB)	Total PSD With Duty Factor (dBm/MHz)	MAX. Limit (dBm/MHz)	Pass / Fail
		Chain 0	Chain 1				
36	5180	5.85	6.07	0.16	9.13	16.46	Pass
40	5200	8.34	9.26	0.16	12.00	16.46	Pass
48	5240	8.23	8.36	0.16	11.47	16.46	Pass

- Note:**
- Method a) of power density measurement of KDB 662911 is using for calculating total power density. Total power density is summing entire spectra across corresponding frequency bins on the various outputs by computer.
 - Directional gain = $10 \log[(10^{G_0/20} + 10^{G_1/20})^2 / 2] = 6.54\text{dBi} > 6\text{dBi}$, so the power density limit shall be reduced to $17 - (6.54 - 6) = 16.46\text{dBm}$.
 - Refer to section 3.3 for duty cycle spectrum plot.

802.11ac (VHT20)

Chan.	Chan. Freq. (MHz)	PSD (dBm/MHz)		Total Power Density (dBm/MHz)	MAX. Limit (dBm/MHz)	Pass / Fail
		Chain 0	Chain 1			
36	5180	7.37	7.75	10.57	16.46	Pass
40	5200	9.08	9.11	12.11	16.46	Pass
48	5240	7.89	8.43	11.18	16.46	Pass

- Note:**
- Method a) of power density measurement of KDB 662911 is using for calculating total power density. Total power density is summing entire spectra across corresponding frequency bins on the various outputs by computer.
 - Directional gain = $10 \log[(10^{G_0/20} + 10^{G_1/20})^2 / 2] = 6.54\text{dBi} > 6\text{dBi}$, so the power density limit shall be reduced to $17 - (6.54 - 6) = 16.46\text{dBm}$.

802.11ac (VHT40)

Chan.	Chan. Freq. (MHz)	PSD W/O Duty Factor (dBm/MHz)		Duty Factor (dB)	Total PSD With Duty Factor (dBm/MHz)	MAX. Limit (dBm/MHz)	Pass / Fail
		Chain 0	Chain 1				
38	5190	0.97	1.66	0.15	4.49	16.46	Pass
46	5230	4.14	4.16	0.15	7.31	16.46	Pass

- Note:**
- Method a) of power density measurement of KDB 662911 is using for calculating total power density. Total power density is summing entire spectra across corresponding frequency bins on the various outputs by computer.
 - Directional gain = $10 \log[(10^{G0/20} + 10^{G1/20})^2 / 2] = 6.54\text{dBi} > 6\text{dBi}$, so the power density limit shall be reduced to $17 - (6.54 - 6) = 16.46\text{dBm}$.
 - Refer to section 3.3 for duty cycle spectrum plot.

802.11ac (VHT80)

Chan.	Chan. Freq. (MHz)	PSD W/O Duty Factor (dBm/MHz)		Duty Factor (dB)	Total PSD With Duty Factor (dBm/MHz)	MAX. Limit (dBm/MHz)	Pass / Fail
		Chain 0	Chain 1				
42	5210	-3.22	-2.53	0.30	0.45	16.46	Pass

- Note:**
- Method a) of power density measurement of KDB 662911 is using for calculating total power density. Total power density is summing entire spectra across corresponding frequency bins on the various outputs by computer.
 - Directional gain = $10 \log[(10^{G0/20} + 10^{G1/20})^2 / 2] = 6.54\text{dBi} > 6\text{dBi}$, so the power density limit shall be reduced to $17 - (6.54 - 6) = 16.46\text{dBm}$.
 - Refer to section 3.3 for duty cycle spectrum plot.

Spectrum Plot of Worst Value

802.11a_Chain 1 / CH40

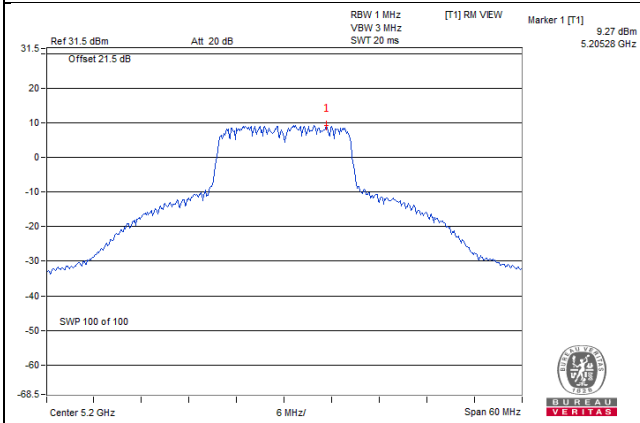

802.11ac (VHT20)_Chain 1 / CH40

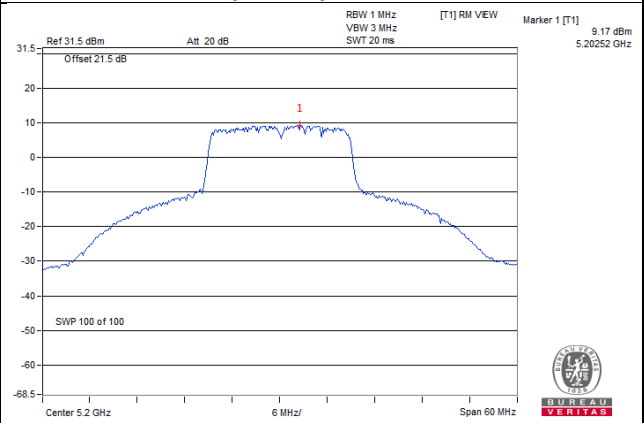

802.11ac (VHT40)_Chain 1 / CH46

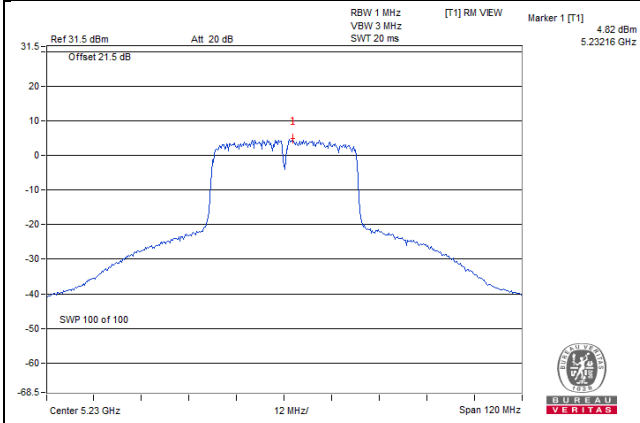

802.11ac (VHT80)_Chain 1 / CH42

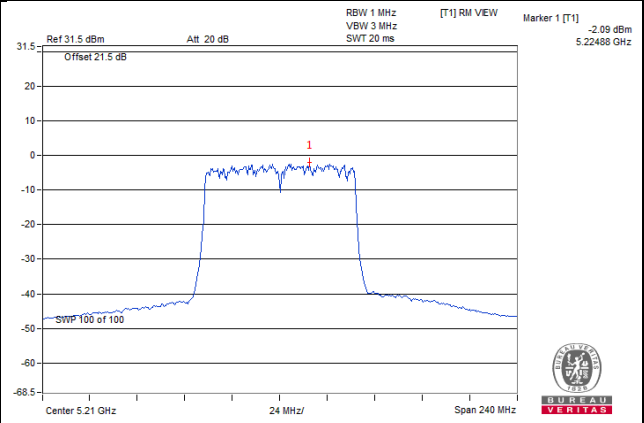

For U-NII-3:
802.11a

TX chain	Chan.	Chan. Freq. (MHz)	PSD W/O Duty Factor		10 log (N=2) dB	Duty Factor (dB)	Total PSD With Duty Factor (dBm/500kHz)	Limit (dBm/500kHz)	Pass /Fail
			(dBm/300kHz)	(dBm/500kHz)					
0	149	5745	0.36	2.58	3.01	0.16	5.75	29.46	Pass
	157	5785	0.33	2.55	3.01	0.16	5.72	29.46	Pass
	165	5825	-0.19	2.03	3.01	0.16	5.20	29.46	Pass
1	149	5745	0.69	2.91	3.01	0.16	6.08	29.46	Pass
	157	5785	0.58	2.80	3.01	0.16	5.97	29.46	Pass
	165	5825	0.41	2.63	3.01	0.16	5.80	29.46	Pass

Note: 1. Directional gain = $10 \log[(10^{G0/20} + 10^{G1/20})^2 / 2] = 6.54\text{dBi} > 6\text{dBi}$, so the power density limit shall be reduced to $30-(6.57-6) = 29.46\text{dBm}$.

2. Refer to section 3.3 for duty cycle spectrum plot.

802.11ac (VHT20)

TX chain	Channel	Freq. (MHz)	PSD (dBm/300kHz)	PSD (dBm/500kHz)	10 log (N=2) dB	Total PSD (dBm/500kHz)	Limit (dBm/500kHz)	Pass /Fail
0	149	5745	1.78	4.00	3.01	7.01	29.46	Pass
	157	5785	1.42	3.64	3.01	6.65	29.46	Pass
	165	5825	0.91	3.13	3.01	6.14	29.46	Pass
1	149	5745	2.03	4.25	3.01	7.26	29.46	Pass
	157	5785	1.93	4.15	3.01	7.16	29.46	Pass
	165	5825	1.87	4.09	3.01	7.10	29.46	Pass

Note: 1. Directional gain = $10 \log[(10^{G0/20} + 10^{G1/20})^2 / 2] = 6.54\text{dBi} > 6\text{dBi}$, so the power density limit shall be reduced to $30-(6.57-6) = 29.46\text{dBm}$.

802.11ac (VHT40)

TX chain	Chan.	Chan. Freq. (MHz)	PSD W/O Duty Factor		10 log (N=2) dB	Duty Factor (dB)	Total PSD With Duty Factor (dBm/500kHz)	Limit (dBm/500kHz)	Pass /Fail
			(dBm/300kHz)	(dBm/500kHz)					
0	151	5755	-3.95	-1.73	3.01	0.15	1.43	29.46	Pass
	159	5795	-2.06	0.16	3.01	0.15	3.32	29.46	Pass
1	151	5755	-3.20	-0.98	3.01	0.15	2.18	29.46	Pass
	159	5795	-0.60	1.62	3.01	0.15	4.78	29.46	Pass

Note: 1. Directional gain = $10 \log[(10^{G0/20} + 10^{G1/20})^2 / 2] = 6.54\text{dBi} > 6\text{dBi}$, so the power density limit shall be reduced to $30-(6.57-6) = 29.46\text{dBm}$.

2. Refer to section 3.3 for duty cycle spectrum plot.

802.11ac (VHT80)

TX chain	Chan.	Chan. Freq. (MHz)	PSD W/O Duty Factor		10 log (N=2) dB	Duty Factor (dB)	Total PSD With Duty Factor (dBm/500kHz)	Limit (dBm/500kHz)	Pass /Fail
			(dBm/300kHz)	(dBm/500kHz)					
0	155	5775	-9.41	-7.19	3.01	0.30	-3.88	29.46	Pass
1	155	5775	-9.15	-6.93	3.01	0.30	-3.62	29.46	Pass

Note: 1. Directional gain = $10 \log[(10^{G0/20} + 10^{G1/20})^2 / 2] = 6.54\text{dBi} > 6\text{dBi}$, so the power density limit shall be reduced to $30 - (6.57 - 6) = 29.46\text{dBm}$.

2. Refer to section 3.3 for duty cycle spectrum plot.

Spectrum Plot of Worst Value

802.11a – Chain 1: CH 149

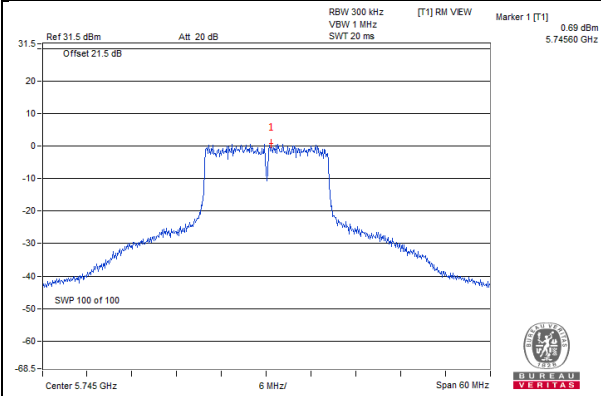

802.11ac (VHT20) – Chain 1: CH 149

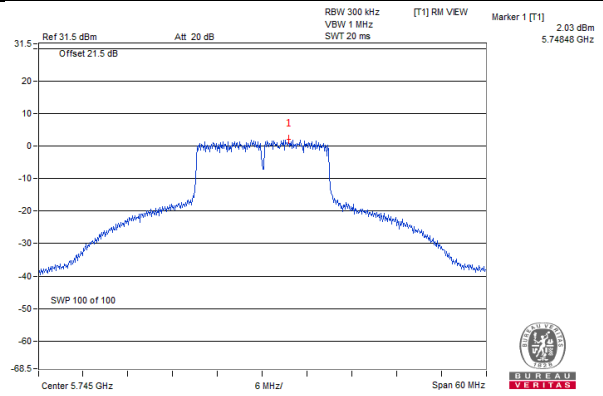

802.11ac (VHT40) – Chain 1: CH 159

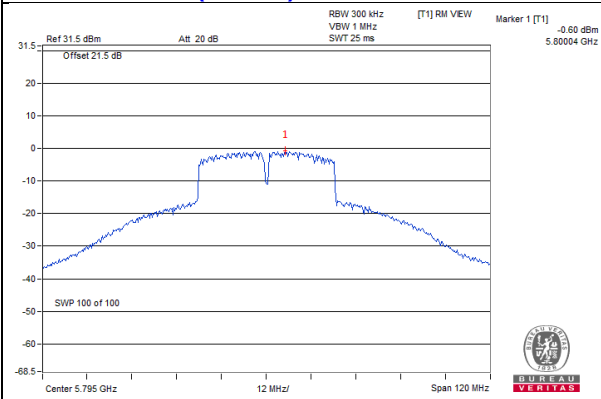

802.11ac (VHT80) – Chain 1: CH 155

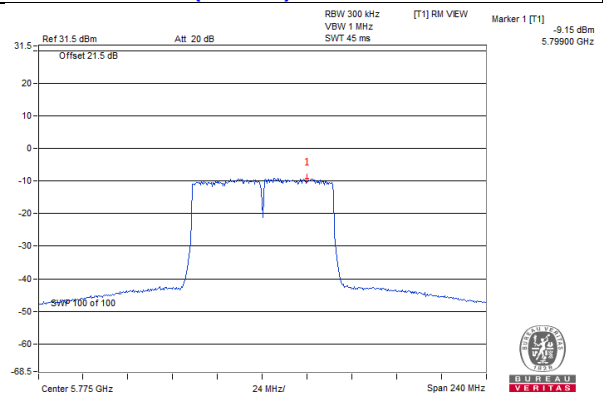

4.6 Frequency Stability Measurement

4.6.1 Limits of Frequency Stability Measurement

The frequency of the carrier signal shall be maintained within band of operation

4.6.2 Test Setup

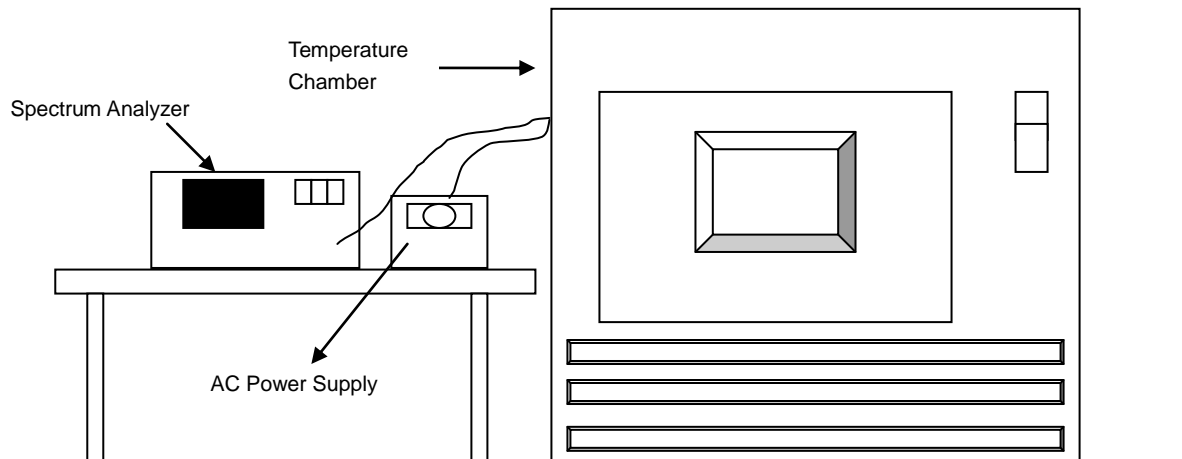

4.6.3 Test Instruments

Refer to section 4.1.2 to get information of above instrument.

4.6.4 Test Procedure

- The EUT was placed inside the environmental test chamber and powered by nominal AC voltage.
- Turn the EUT on and couple its output to a spectrum analyzer.
- Turn the EUT off and set the chamber to the highest temperature specified.
- Allow sufficient time (approximately 30 min) for the temperature of the chamber to stabilize, turn the EUT on and measure the operating frequency after 2, 5, and 10 Minutes.
- Repeat step 2 and 3 with the temperature chamber set to the lowest temperature.
- The test chamber was allowed to stabilize at +20 degree C for a minimum of 30 Minutes. The supply voltage was then adjusted on the EUT from 85% to 115% and the frequency record.

4.6.5 Deviation from Test Standard

No deviation.

4.6.6 EUT Operating Condition

Set the EUT transmit at un-modulation mode to test frequency stability.

4.6.7 Test Results

Frequency Stability Versus Temp.									
Operating Frequency: 5180 MHz									
TEMP. (°C)	Power Supply (Vac)	0 Minute		2 Minutes		5 Minutes		10 Minutes	
		Measured Frequency (MHz)	Pass/Fail	Measured Frequency (MHz)	Pass/Fail	Measured Frequency (MHz)	Pass/Fail	Measured Frequency (MHz)	Pass/Fail
50	120	5179.9772	Pass	5179.9775	Pass	5179.9823	Pass	5179.9803	Pass
40	120	5180.0021	Pass	5180.0025	Pass	5179.9988	Pass	5180.0013	Pass
30	120	5179.9949	Pass	5179.9966	Pass	5179.994	Pass	5179.9948	Pass
20	120	5180.0069	Pass	5180.0096	Pass	5180.0102	Pass	5180.0103	Pass
10	120	5179.9988	Pass	5179.9972	Pass	5180	Pass	5179.9957	Pass
0	120	5179.9876	Pass	5179.986	Pass	5179.9852	Pass	5179.9883	Pass
-10	120	5180.0244	Pass	5180.0243	Pass	5180.0243	Pass	5180.0261	Pass
-20	120	5179.9855	Pass	5179.9894	Pass	5179.9901	Pass	5179.9896	Pass
-30	120	5180.0142	Pass	5180.012	Pass	5180.0115	Pass	5180.0121	Pass

Frequency Stability Versus Voltage									
Operating Frequency: 5180 MHz									
TEMP. (°C)	Power Supply (Vac)	0 Minute		2 Minutes		5 Minutes		10 Minutes	
		Measured Frequency (MHz)	Pass/Fail	Measured Frequency (MHz)	Pass/Fail	Measured Frequency (MHz)	Pass/Fail	Measured Frequency (MHz)	Pass/Fail
20	138	5180.0068	Pass	5180.0095	Pass	5180.0099	Pass	5180.0108	Pass
	120	5180.0069	Pass	5180.0096	Pass	5180.0102	Pass	5180.0103	Pass
	102	5180.0078	Pass	5180.0101	Pass	5180.0097	Pass	5180.0108	Pass

4.7 6dB Bandwidth Measurement

4.7.1 Limits of 6dB Bandwidth Measurement

The minimum of 6dB Bandwidth Measurement is 0.5MHz.

4.7.2 Test Setup

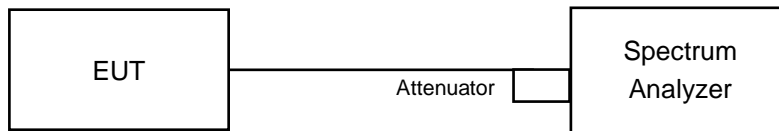

4.7.3 Test Instruments

Refer to section 4.1.2 to get information of above instrument.

4.7.4 Test Procedure

MEASUREMENT PROCEDURE REF

- a. Set resolution bandwidth (RBW) = 100kHz
- b. Set the video bandwidth (VBW) $\geq 3 \times$ RBW, Detector = Peak.
- c. Trace mode = max hold.
- d. Sweep = auto couple.
- e. Measure the maximum width of the emission that is constrained by the frequencies associated with the two amplitude points (upper and lower) that are attenuated by 6 dB relative to the maximum level measured in the fundamental emission

4.7.5 Deviation from Test Standard

No deviation.

4.7.6 EUT Operating Condition

The software provided by client to enable the EUT under transmission condition continuously at lowest, middle and highest channel frequencies individually.

4.7.7 Test Results

802.11a

Channel	Frequency (MHz)	6dB Bandwidth (MHz)		Minimum Limit (MHz)	Pass / Fail
		Chain 0	Chain 1		
149	5745	16.37	16.41	0.5	PASS
157	5785	16.39	16.41	0.5	PASS
165	5825	16.39	16.38	0.5	PASS

802.11ac (VHT20)

Channel	Frequency (MHz)	6dB Bandwidth (MHz)		Minimum Limit (MHz)	Pass / Fail
		Chain 0	Chain 1		
149	5745	17.63	17.63	0.5	PASS
157	5785	17.67	17.65	0.5	PASS
165	5825	17.67	17.64	0.5	PASS

802.11ac (VHT40)

Channel	Frequency (MHz)	6dB Bandwidth (MHz)		Minimum Limit (MHz)	Pass / Fail
		Chain 0	Chain 1		
151	5755	35.46	35.11	0.5	PASS
159	5795	35.13	35.16	0.5	PASS

802.11ac (VHT80)

Channel	Frequency (MHz)	6dB Bandwidth (MHz)		Minimum Limit (MHz)	Pass / Fail
		Chain 0	Chain 1		
155	5775	76.00	75.55	0.5	PASS

Spectrum Plot of Worst Value

802.11a_Chain 0 / CH149

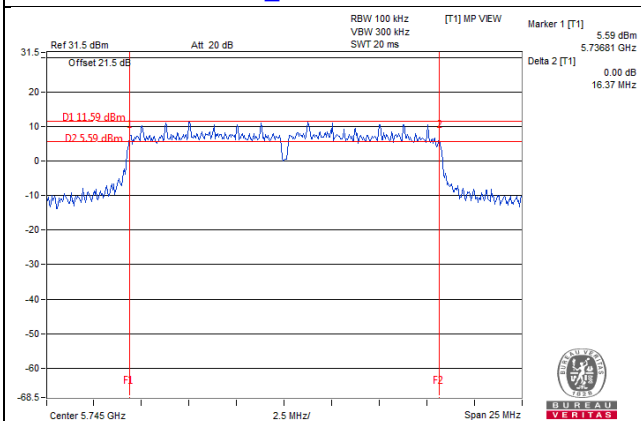

802.11ac (VHT20)_Chain 0 / CH149

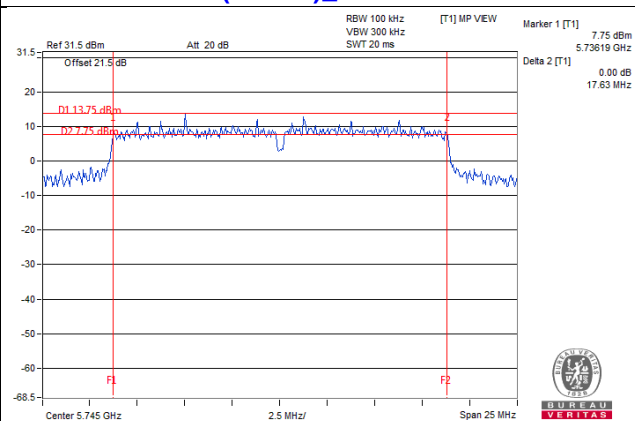

802.11ac (VHT40)_Chain 1 / CH151

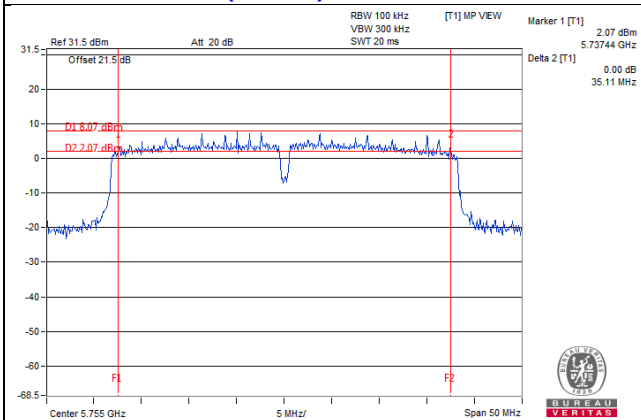

802.11ac (VHT80)_Chain 1 / CH155

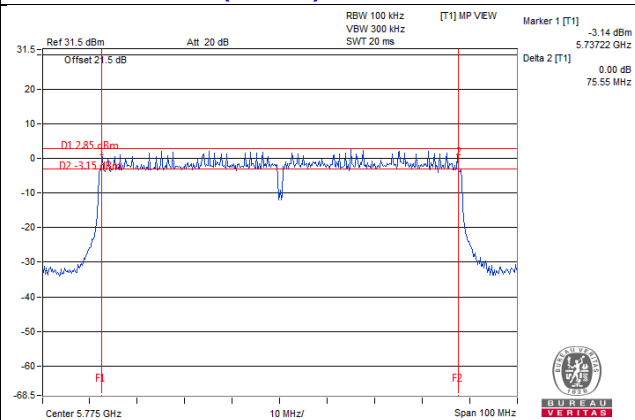

5 Pictures of Test Arrangements

Please refer to the attached file (Test Setup Photo).

Annex A- Radiated Out of Band Emission (OOBE) Measurement (For U-NII-3 band)

802.11a

CH 149 5745 MHz

Horizontal

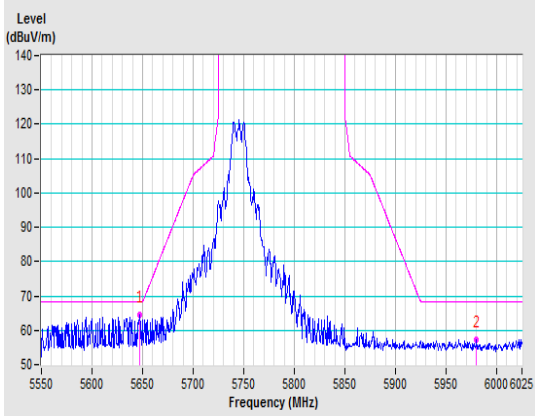

Vertical

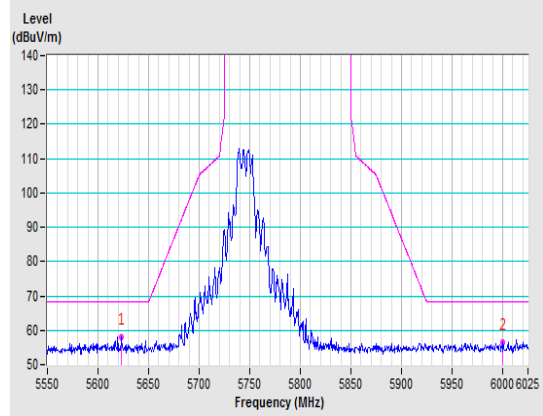

CH 157 5785 MHz

Horizontal

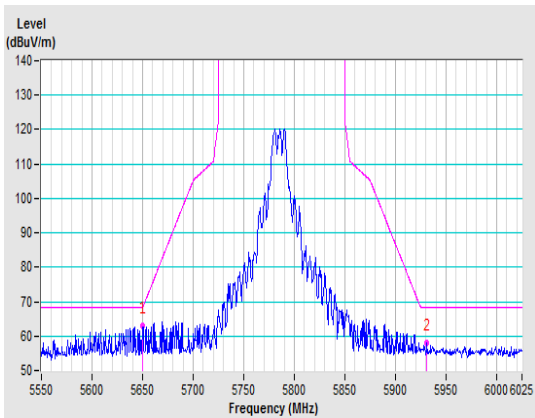

Vertical

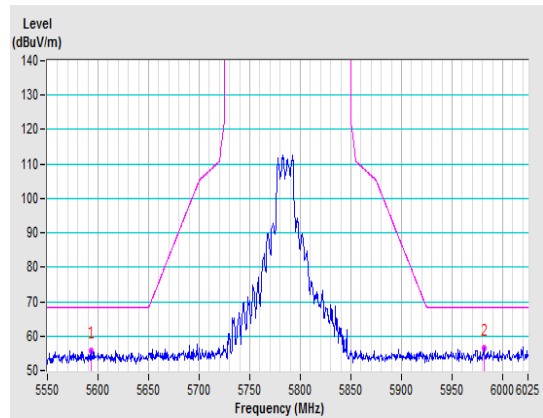

CH 165 5825 MHz

Horizontal

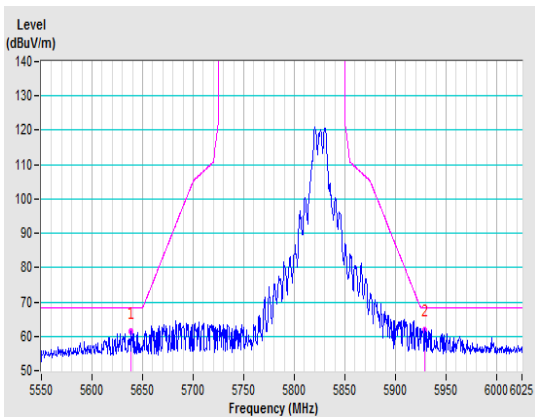

Vertical

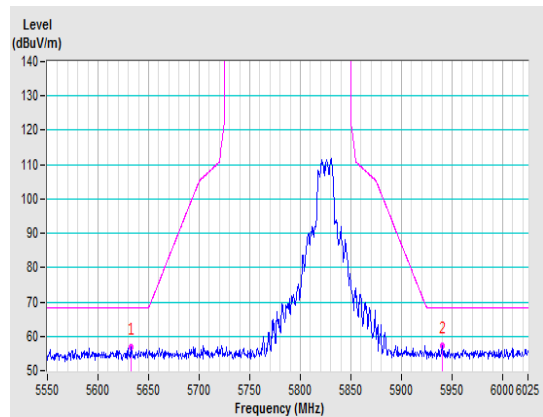

802.11ac (VHT20)

CH 149 5745 MHz

Horizontal

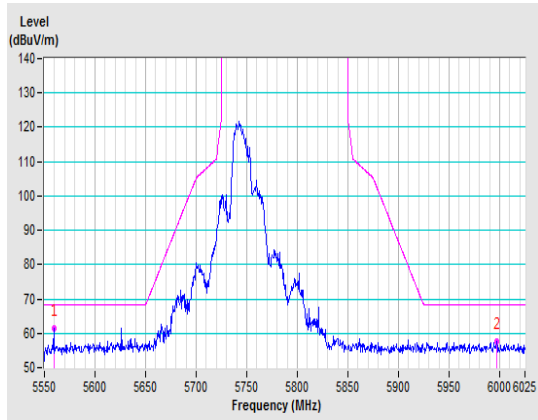

Vertical

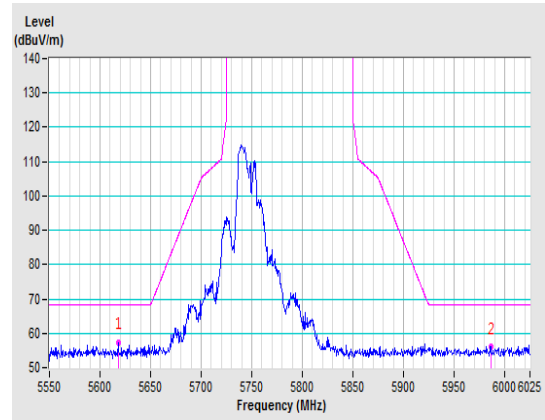

CH 157 5785 MHz

Horizontal

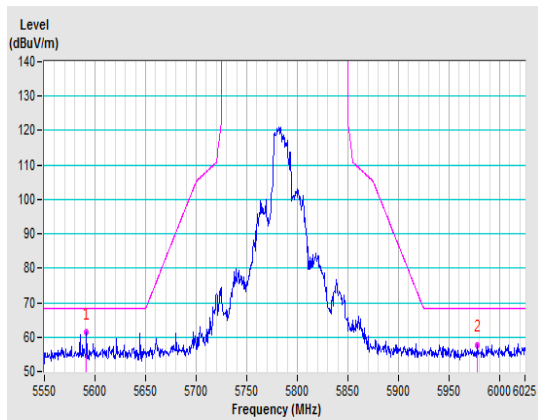

Vertical

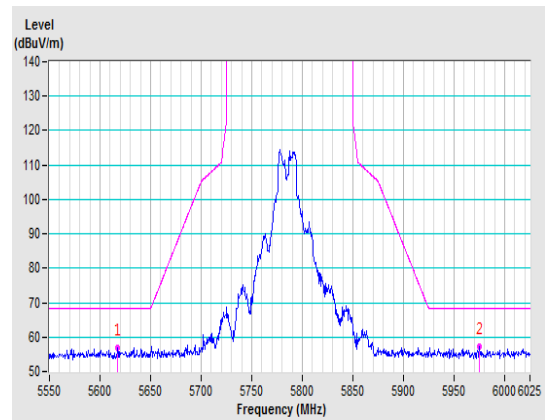

CH 165 5825 MHz

Horizontal

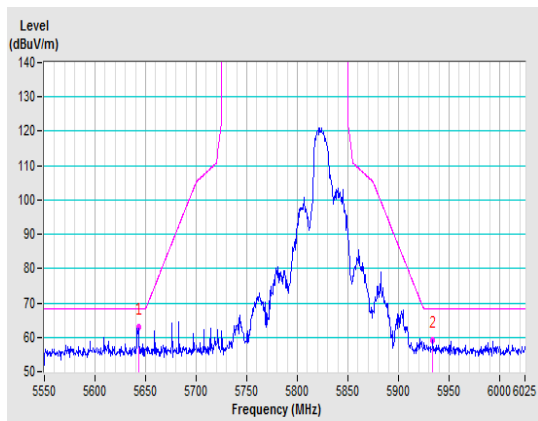

Vertical

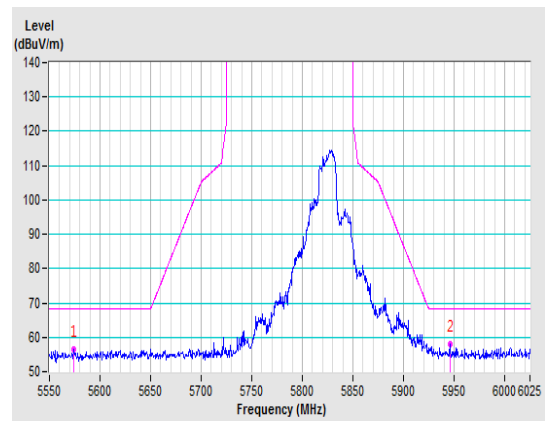

802.11ac (VHT40)

CH 151 5755 MHz

Horizontal

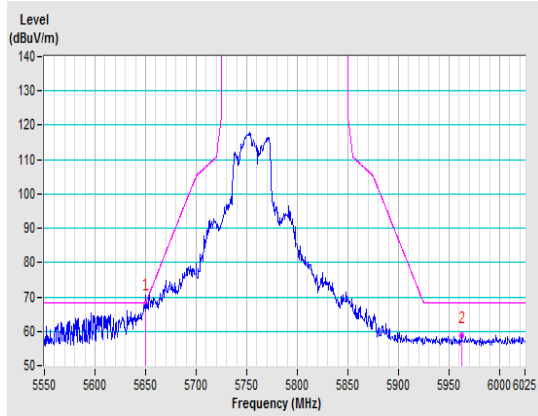

Vertical

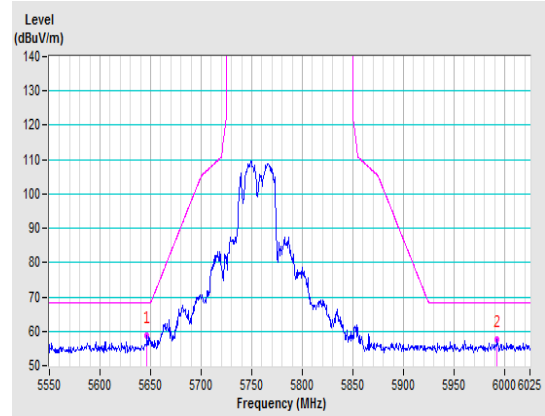

CH 159 5795 MHz

Horizontal

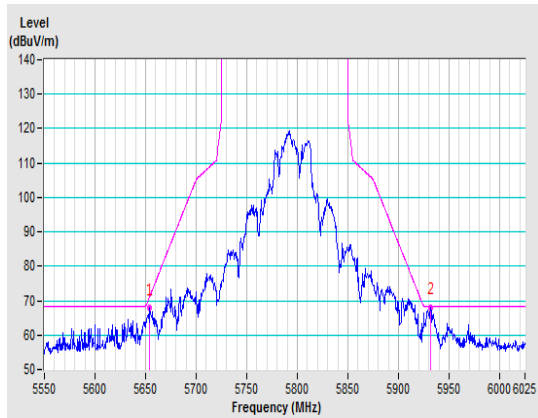

Vertical

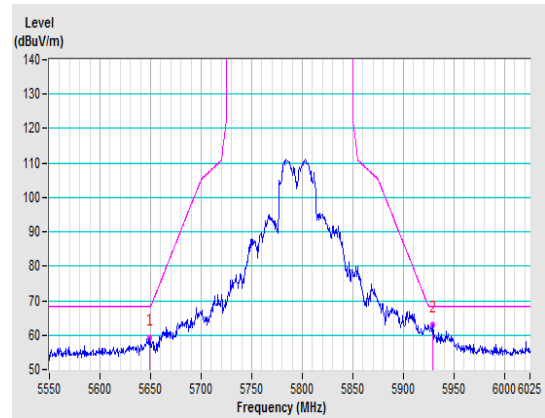

802.11ac (VHT80)

CH 155 5775 MHz

Horizontal

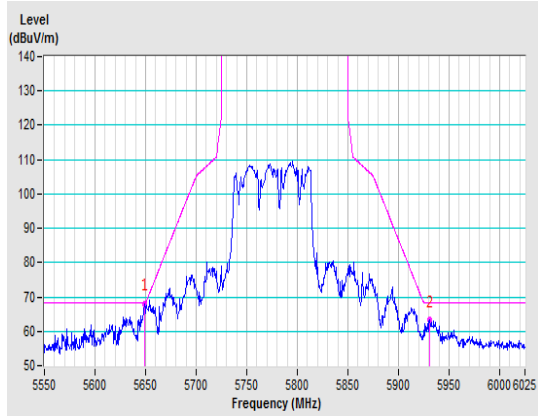

Vertical

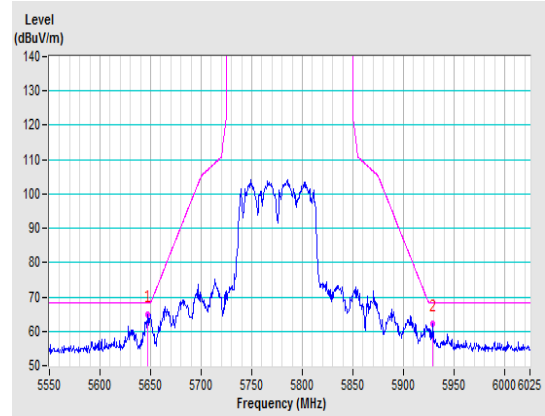

Appendix – Information on the Testing Laboratories

We, Bureau Veritas Consumer Products Services (H.K.) Ltd., Taoyuan Branch, were founded in 1988 to provide our best service in EMC, Radio, Telecom and Safety consultation. Our laboratories are FCC recognized accredited test firms and accredited according to ISO/IEC 17025.

If you have any comments, please feel free to contact us at the following:

Linkou EMC/RF Lab

Tel: 886-2-26052180

Fax: 886-2-26051924

Hsin Chu EMC/RF/Telecom Lab

Tel: 886-3-6668565

Fax: 886-3-6668323

Hwa Ya EMC/RF/Safety Lab

Tel: 886-3-3183232

Fax: 886-3-3270892

Email: service.adt@tw.bureauveritas.com

Web Site: www.bureauveritas-adt.com

The address and road map of all our labs can be found in our web site also.

--- END ---