



Spectrum Research & Testing Lab., Inc.
No. 101-10, Ling 8,
Shan-Tong Li, Chung-Li
City, Taoyuan, Taiwan

TEST REPORT

Reference No.: A07062903
Report No.: FCCA07062903
FCC ID: Q7Z-BV300R1
Page: 1 of 103
Date: Jul. 27, 2007

Product Name: Voii Mini
Model Number: BV-300
Applicant: MOBILE ACTION TECHNOLOGY INC.
5F, No.205-3, Sec.3, Beishin Rd., Shindian City,
Taipei, Taiwan
Date of Receipt: Jun. 29, 2007
Finished date of Test: Jul. 25, 2007
Applicable Standards: 47 CFR Part 15, Subpart C
ANSI C63.4: 2003

We, **Spectrum Research & Testing Laboratory Inc.**, hereby certify that one sample of the above was tested in our laboratory with positive results according to the above-mentioned standards. The records in the report are an accurate account of the results. Details of the results are given in the subsequent pages of this report.

Tested By: Jeff Yu, Date: Jul 27 / 2007
(Jeff Yu)

Approved By: Johnson Ho, Date: 7/27/2007
(Johnson Ho, Director)



TABLE OF CONTENTS

1. DOCUMENT POLICY AND TEST STATEMENT.....	4
1.1 DOCUMENT POLICY	4
1.2 TEST STATEMENT	4
1.3 EUT MODIFICATION.....	4
2. DESCRIPTION OF EUT AND TEST MODE	5
2.1 GENERAL DESCRIPTION OF EUT	5
2.2 DESCRIPTION OF SUPPORT UNIT.....	5
2.3 DESCRIPTION OF TEST MODE	6
3. DESCRIPTION OF APPLIED STANDARDS.....	6
4. TECHNICAL CHARACTERISTICS TEST	7
4.1 CONDUCTED EMISSION	7
4.1.1 LIMIT	7
4.1.2 TEST EQUIPMENT	7
4.1.3 TEST SETUP	8
4.1.4 TEST PROCEDURE	8
4.1.5 EUT OPERATING CONDITION.....	9
4.1.6 TEST RESULT.....	10
4.2 RADIATED EMISSION TEST	16
4.2.1 LIMIT	16
4.2.2 TEST EQUIPMENT	17
4.2.3 TEST SET-UP.....	18
4.2.4 TEST PROCEDURE.....	19
4.2.5 EUT OPERATING CONDITION.....	19
4.2.6 RADIATED EMISSION TEST RESULT	20
4.3 CHANNEL SEPARATION TEST.....	48
4.3.1 LIMIT	48
4.3.2 TEST EQUIPMENT	48
4.3.3 TEST SET-UP.....	48
4.3.4 TEST PROCEDURE.....	48
4.3.5 EUT OPERATING CONDITION.....	48
4.3.6 TEST RESULT.....	49
4.4 QUANTITY OF HOPPING CHANNEL TEST	57
4.4.1 LIMIT	57
4.4.2 TEST EQUIPMENT	57
4.4.3 TEST SET-UP.....	57
4.4.4 TEST PROCEDURE.....	57
4.4.5 EUT OPERATING CONDITION.....	57
4.4.6 TEST RESULT.....	58
4.5 AVERAGE TIME OF OCCUPANCY TEST(Dwell Time).....	60
4.5.1 LIMIT	60
4.5.2 TEST EQUIPMENT	60
4.5.3 TEST SET-UP.....	60



TEST REPORT

4.5.4	TEST PROCEDURE.....	60
4.5.5	EUT OPERATING CONDITION.....	60
4.5.6	TEST RESULT.....	61
4.6	MAXIMUM PEAK POWER TEST	69
4.6.1	LIMIT	69
4.6.2	TEST EQUIPMENT	69
4.6.3	TEST SET-UP.....	70
4.6.4	TEST PROCEDURE.....	70
4.6.5	EUT OPERATING CONDITION.....	70
4.6.6	TEST RESULT.....	70
4.7	BAND EDGE TEST	78
4.7.1	LIMIT	78
4.7.2	TEST EQUIPMENT	79
4.7.3	TEST SET-UP.....	80
4.7.4	TEST PROCEDURE.....	81
4.7.5	EUT OPERATING CONDITION.....	81
4.7.6	TEST RESULT.....	81
4.8	20DB BANDWIDTH.....	87
4.8.1	LIMIT	87
4.8.2	TEST EQUIPMENT	87
4.8.3	TEST SET-UP.....	87
4.8.4	TEST PROCEDURE.....	87
4.8.5	EUT OPERATING CONDITION.....	87
4.8.6	TEST RESULT.....	88
5.	ANTENNA APPLICATION	96
5.1	ANTENNA REQUIREMENT	96
5.2	RESULT.....	96
6.	PHOTOS OF TESTING	97
7.	TERMS OF ABRIVATION	103



**Spectrum Research &
Testing Lab., Inc.**
No. 101-10, Ling 8,
Shan-Tong Li, Chung-Li
City, Taoyuan, Taiwan

TEST REPORT

Reference No.: A07062903
Report No.: FCCA07062903
FCC ID: Q7Z-BV300R1
Page: 4 of 103
Date: Jul. 27, 2007

1. DOCUMENT POLICY AND TEST STATEMENT

1.1 DOCUMENT POLICY

- The report shall not be reproduced except in full, without the written approval of SRT Lab, Inc.

1.2 TEST STATEMENT

- The test results in the report apply only to the unit tested by SRT Lab.
- There was no deviation from the requirements of test standards during the test.
- AC power source, 120 VAC/60 Hz, was used during the test.

1.3 EUT MODIFICATION

- No modification in SRT Lab.



2. DESCRIPTION OF EUT AND TEST MODE

2.1 GENERAL DESCRIPTION OF EUT

PRODUCT	Vois Mini
MODEL NO.	BV-300
BUILD-IN BATTERY	Li-ion 3.7V, 750mAH
CHARGE POWER	DC 5.0V, 500mA
FREQUENCY BAND	2.402GHz~2.480GHz
CARRIER FREQUENCY	FHSS(Frequency Hopping Spread Spectrum)
NUMBER OF CHANNEL	79
CHANNEL SPACING	1 MHz
RATED RF OUTPUT POWER	+1.9 dBm
MODE OF OPERATION	duplex
MODULATION TYPE	GFSK(1Mbps)
BIT RATE OF TRANSMISSION	Bluetooth V1.2(1Mbps)
ANTENNA TYPE	Mono Pole
ANTENNA GAIN	0dBi
OPERATING TEMPERATURE	0~45°C
CHANNEL BANDWIDTH	1MHz

NOTE :

For more detailed information, please refer to the EUT's specification or user's manual provided by manufacturer.

2.2 DESCRIPTION OF SUPPORT UNIT

The transmitter part of EUT was tested with a PC system and configured by the requirement of ANSI C63.4. All interface ports were connected to the appropriate support units via specific cables. The support units and cables are listed below.

NO	DEVICE	BRAND	MODEL #	FCC ID/DOC	CABLE
1	NOTEBOOK	COMPAQ	Presario 2100	DOC	2.0m unshielded power cord

NOTE : For the actual test configuration, please refer to the photos of testing.



2.3 DESCRIPTION OF TEST MODE

79 channels are provided by EUT. The 3 channels of lower, medium and higher were chosen for test.

Channel	Frequency(MHz)
0	2402
39	2441
78	2480

EUT Configure Mode	Description
Mode1	TX
Mode2	Link
Mode3	RX

NOTE :

1. Below 1 GHz, the channel 0, 39 and 78 were chosen for conducted and radiated emission test.
2. Above 1 GHz, the channel 0, 39 and 78 were tested individually.

3. DESCRIPTION OF APPLIED STANDARDS

The EUT is a kind of wireless product and to be connected with a PC system for normal use. According to the specifications provided by the applicant, it must comply with the requirements of the following standards:

47 CFR Part 15, Subpart C

ANSI C63.4: 2003

All tests have been performed and recorded as the above standards.



Spectrum Research & Testing Lab., Inc.
 No. 101-10, Ling 8,
 Shan-Tong Li, Chung-Li
 City, Taoyuan, Taiwan

TEST REPORT

Reference No.: A07062903
 Report No.: FCCA07062903
 FCC ID: Q7Z-BV300R1
 Page: 7 of 103
 Date: Jul. 27, 2007

4. TECHNICAL CHARACTERISTICS TEST

4.1 CONDUCTED EMISSION

4.1.1 LIMIT

FREQUENCY (MHz)	Class A (dB μ V)		Class B (dB μ V)	
	Quasi-peak	Average	Quasi-peak	Average
0.15 - 0.5	79	66	66 - 56	56 - 46
0.5 - 5.0	73	60	56	46
5.0 - 30.0	73	60	60	50

NOTE:

1. The lower limit shall apply at the transition frequencies.
2. The limit decreases in line with the logarithm of the frequency in the range of 0.15 to 0.50 MHz.

4.1.2 TEST EQUIPMENT

The following test equipment was used for the test:

EQUIPMENT/ FACILITIES	SPECIFICATIONS	MANUFACTURER	MODEL#/ SERIAL#	DUE DATE OF CAL. & CAL. CENTER
EMI TEST RECEIVER	9 KHZ TO 30 MHZ	ROHDE & SCHWARZ	ESHS30/ 826003/008	OCT. 2007 ETC
LISN (for EUT)	50 μ H, 50 ohm	FCC	FCC-LISN-50-25-2/ 01017	OCT. 2007 ETC
LISN (for Peripheral)	50 μ H, 50 ohm	FCC	FCC-LISN-50-25-2/ 01018	NOV. 2007 ETC
50 ohm TERMINATOR	50 ohm	HP	11593A/ 2	OCT. 2007 ETC
COAXIAL CABLE	5m	SUNCITY	CABLE 05/ #5-5M	NOV. 2007 SRT
ISOLATION TRANSFORMER	N/A	APC	AFC-11015/ F102040016	N/A
FILTER	2 LINE, 30A	FIL.COIL	FC-943/ 771	N/A
GROUND PLANE	2.3M (H) x 2.4M (W)	SRT	N/A	N/A
GROUND PLANE	2.4M (H) x 2.4M (W)	SRT	N/A	N/A

NOTE: The calibration interval of the above test equipment is one year and the calibrations are traceable to NML/ROC and NIST/USA.



4.1.3 TEST SETUP

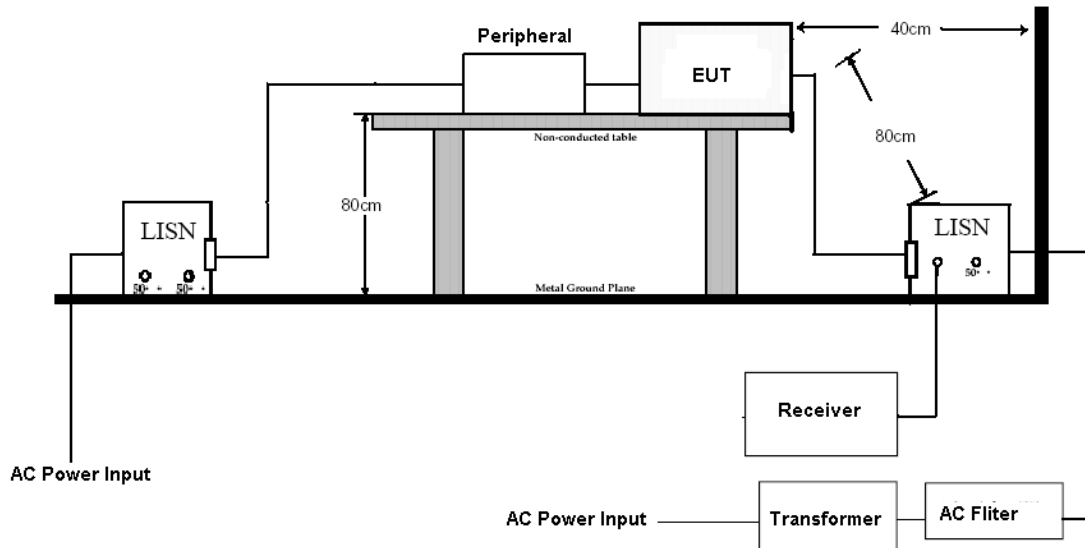

NOTE:

1. The EUT was put on a wooden table with 0.8m height above ground plane, and 0.4m away from reference ground plane (> 2mx2m).
2. For the actual test configuration, please refer to the photos of testing.
3. The serial no. of the LISN connected to EUT is 951318.
4. The serial no. of the LISN connected to support units is 924839.

4.1.4 TEST PROCEDURE

The EUT was tested according to the requirement of ANSI C63.4: 2003 and CISRP22:2006. The frequency spectrum from 0.15 MHz to 30 MHz was investigated. The LISN used was 50 ohm/50 μ H as specified. All readings were quasi-peak and average values with 10 kHz resolution bandwidth of the test receiver. The EUT system was operated in all typical methods by users. Both lines of the power mains of EUT were measured and the cables connected to EUT and support units were moved to find the maximum emission levels for each frequency.



**Spectrum Research &
Testing Lab., Inc.**
No. 101-10, Ling 8,
Shan-Tong Li, Chung-Li
City, Taoyuan, Taiwan

TEST REPORT

Reference No.: A07062903
Report No.: FCCA07062903
FCC ID: Q7Z-BV300R1
Page:9 of 103
Date: Jul. 27, 2007

4.1.5 EUT OPERATING CONDITION

1. Set the EUT under transmission condition continuously at a specific channel frequency.

2. PC sent "H" pattern signal and detect following peripherals directly or via EUT:
 - Color Monitor
 - Keyboard
 - Mouse



4.1.6 TEST RESULT

Temperature:	<u>25°C</u>	Humidity:	<u>62%RH</u>
Frequency Range:	<u>0.15 – 30 MHz</u>	Tested Mode:	<u>BV-300, CH0</u>
Receiver Detector:	<u>Q.P. and AV.</u>	Tested By:	<u>Jeff Yu</u>
		Tested Date:	<u>Jul. 23, 2007</u>

Power Line Measured : Line

Freq. (MHz)	Correct. Factor (dB)	Reading Value (dB μ V)		Emission Level (dB μ V)		Limit (dB μ V)		Margin (dB)	
		Q.P.	AV.	Q.P.	AV.	Q.P.	AV.	Q.P.	AV.
0.156	0.30	41.04	22.18	41.34	22.48	65.83	55.83	-24.79	-33.65
0.204	0.28	47.22	40.01	47.50	40.29	64.46	54.46	-17.24	-14.45
0.951	0.17	32.72	28.72	32.89	28.89	56.00	46.00	-23.28	-17.28
3.19	0.18	34.08	28.40	34.26	28.58	56.00	46.00	-21.92	-17.60
14.257	0.25	32.10	24.97	32.35	25.22	60.00	50.00	-27.90	-25.03
16.138	0.28	36.92	29.53	37.20	29.81	60.00	50.00	-23.08	-20.47

Power Line Measured : Neutral

Freq. (MHz)	Correct. Factor (dB)	Reading Value (dB μ V)		Emission Level (dB μ V)		Limit (dB μ V)		Margin (dB)	
		Q.P.	AV.	Q.P.	AV.	Q.P.	AV.	Q.P.	AV.
0.156	0.30	40.66	22.31	40.96	22.61	65.83	55.83	-25.17	-33.52
0.159	0.30	39.98	18.81	40.28	19.11	65.74	55.74	-25.76	-36.94
0.610	0.22	33.54	30.43	33.76	30.65	56.00	46.00	-22.46	-15.57
3.051	0.18	34.18	29.42	34.36	29.60	56.00	46.00	-21.82	-16.58
14.094	0.25	37.04	30.82	37.29	31.07	60.00	50.00	-22.96	-19.18
17.245	0.27	37.92	30.65	38.19	30.92	60.00	50.00	-22.08	-19.35

NOTE :

1. Measurement uncertainty is +/-2dB
2. Emission level = Reading value + Correction factor
3. Correction Factor = Cable loss + Insertion loss of LISN
4. Margin value = Emission level - Limit
5. The emission of other frequencies was very low against the limit.
6. "-": The Quasi-peak reading value also meets average limit and measurement with the average detector is unnecessary.



Spectrum Research & Testing Lab., Inc.
No. 101-10, Ling 8,
Shan-Tong Li, Chung-Li
City, Taoyuan, Taiwan

TEST REPORT

Reference No.: A07062903
Report No.: FCCA07062903
FCC ID: Q7Z-BV300R1
Page: 11 of 103
Date: Jul. 27, 2007

Temperature:	<u>25°C</u>	Humidity:	<u>62%RH</u>
Frequency Range:	<u>0.15 – 30 MHz</u>	Tested Mode:	<u>BV-300, CH39</u>
Receiver Detector:	<u>Q.P. and AV.</u>	Tested By:	<u>Jeff Yu</u>
		Tested Date:	<u>Jul. 23, 2007</u>

Power Line Measured : Line

Freq. (MHz)	Correct. Factor (dB)	Reading Value (dB μ V)		Emission Level (dB μ V)		Limit (dB μ V)		Margin (dB)	
		Q.P.	AV.	Q.P.	AV.	Q.P.	AV.	Q.P.	AV.
0.15	0.30	41.68	22.77	41.98	23.07	66.00	56.00	-24.32	-33.23
0.156	0.30	40.18	22.33	40.48	22.63	65.83	55.83	-25.65	-33.50
0.61	0.22	33.38	30.11	33.60	30.33	56.00	46.00	-22.62	-15.89
3.378	0.19	34.96	29.72	35.15	29.91	56.00	46.00	-21.04	-16.28
14.906	0.25	27.14	19.84	27.39	20.09	60.00	50.00	-32.86	-30.16
17.081	0.31	39.88	32.87	40.19	33.18	60.00	50.00	-20.12	-17.13

Power Line Measured : Neutral

Freq. (MHz)	Correct. Factor (dB)	Reading Value (dB μ V)		Emission Level (dB μ V)		Limit (dB μ V)		Margin (dB)	
		Q.P.	AV.	Q.P.	AV.	Q.P.	AV.	Q.P.	AV.
0.162	0.30	39.34	19.26	39.64	19.56	65.66	55.66	-26.32	-36.40
0.204	0.28	45.68	39.29	45.96	39.57	64.46	54.46	-18.78	-15.17
0.543	0.24	33.38	30.13	33.62	30.37	56.00	46.00	-22.62	-15.87
2.774	0.17	32.78	27.94	32.95	28.11	56.00	46.00	-23.22	-18.06
13.607	0.24	38.90	29.55	39.14	29.79	60.00	50.00	-21.10	-20.45
16.333	0.27	41.48	32.11	41.75	32.38	60.00	50.00	-18.52	-17.89

NOTE :

1. Measurement uncertainty is +/-2dB
2. Emission level = Reading value + Correction factor
3. Correction Factor = Cable loss + Insertion loss of LISN
4. Margin value = Emission level - Limit
5. The emission of other frequencies was very low against the limit.
6. "-": The Quasi-peak reading value also meets average limit and measurement with the average detector is unnecessary.



Spectrum Research & Testing Lab., Inc.
No. 101-10, Ling 8,
Shan-Tong Li, Chung-Li
City, Taoyuan, Taiwan

TEST REPORT

Reference No.: A07062903
Report No.: FCCA07062903
FCC ID: Q7Z-BV300R1
Page: 12 of 103
Date: Jul. 27, 2007

Temperature:	<u>25°C</u>	Humidity:	<u>62%RH</u>
Frequency Range:	<u>0.15 – 30 MHz</u>	Tested Mode:	<u>BV-300, CH78</u>
Receiver Detector:	<u>Q.P. and AV.</u>	Tested By:	<u>Jeff Yu</u>
		Tested Date:	<u>Jul. 23, 2007</u>

Power Line Measured : Line

Freq. (MHz)	Correct. Factor (dB)	Reading Value (dB μ V)		Emission Level (dB μ V)		Limit (dB μ V)		Margin (dB)	
		Q.P.	AV.	Q.P.	AV.	Q.P.	AV.	Q.P.	AV.
0.162	0.30	39.68	16.94	39.98	17.24	65.66	55.66	-25.98	-38.72
0.204	0.28	45.18	39.20	45.46	39.48	64.46	54.46	-19.28	-15.25
0.543	0.24	32.52	29.47	32.76	29.71	56.00	46.00	-23.48	-16.53
3.18	0.18	26.74	16.32	26.92	16.50	56.00	46.00	-29.26	-29.68
14.054	0.25	29.72	20.75	29.97	21.00	60.00	50.00	-30.28	-29.25
17.019	0.31	41.00	33.19	41.31	33.50	60.00	50.00	-19.00	-16.81

Power Line Measured : Neutral

Freq. (MHz)	Correct. Factor (dB)	Reading Value (dB μ V)		Emission Level (dB μ V)		Limit (dB μ V)		Margin (dB)	
		Q.P.	AV.	Q.P.	AV.	Q.P.	AV.	Q.P.	AV.
0.153	0.30	41.04	21.45	41.34	21.75	65.91	55.91	-24.87	-34.46
0.204	0.28	45.58	38.43	45.86	38.71	64.46	54.46	-18.88	-16.02
1.081	0.14	33.68	32.04	33.82	32.18	56.00	46.00	-22.32	-13.96
3.239	0.18	32.40	25.16	32.58	25.34	56.00	46.00	-23.60	-20.84
13.861	0.25	41.74	34.60	41.99	34.85	60.00	50.00	-18.26	-15.40
16.773	0.28	42.24	33.56	42.52	33.84	60.00	50.00	-17.76	-16.44

NOTE :

1. Measurement uncertainty is +/-2dB
2. Emission level = Reading value + Correction factor
3. Correction Factor = Cable loss + Insertion loss of LISN
4. Margin value = Emission level - Limit
5. The emission of other frequencies was very low against the limit.
6. "-": The Quasi-peak reading value also meets average limit and measurement with the average detector is unnecessary.



TEST REPORT

Temperature:	<u>25°C</u>	Humidity:	<u>62%RH</u>
Frequency Range:	<u>0.15 – 30 MHz</u>	Tested Mode:	<u>Dongle, CH0</u>
Receiver Detector:	<u>Q.P. and AV.</u>	Tested By:	<u>Jeff Yu</u>
		Tested Date:	<u>Jul. 20, 2007</u>

Power Line Measured : Line

Freq. (MHz)	Correct. Factor (dB)	Reading Value (dB μ V)		Emission Level (dB μ V)		Limit (dB μ V)		Margin (dB)	
		Q.P.	AV.	Q.P.	AV.	Q.P.	AV.	Q.P.	AV.
0.198	0.30	44.64	35.64	44.94	35.94	64.63	54.63	-19.99	-18.99
0.204	0.28	44.36	31.64	44.64	31.92	64.46	54.46	-20.10	-22.82
0.528	0.24	34.18	29.99	34.42	30.23	56.00	46.00	-21.82	-16.01
3.041	0.18	30.76	20.92	30.94	21.10	56.00	46.00	-25.24	-25.08
14.511	0.25	25.34	17.33	25.59	17.58	60.00	50.00	-34.66	-32.67
15.205	0.26	29.60	24.27	29.86	24.53	60.00	50.00	-30.40	-25.73

Power Line Measured : Neutral

Freq. (MHz)	Correct. Factor (dB)	Reading Value (dB μ V)		Emission Level (dB μ V)		Limit (dB μ V)		Margin (dB)	
		Q.P.	AV.	Q.P.	AV.	Q.P.	AV.	Q.P.	AV.
0.150	0.30	39.62	18.50	39.92	18.80	56.00	-26.38	-26.38	-37.50
0.201	0.28	44.82	37.26	45.10	37.54	54.54	-19.72	-19.72	-17.28
0.538	0.24	35.38	31.02	35.62	31.26	56.00	-20.62	-20.62	-14.98
3.170	0.18	30.16	18.92	30.34	19.10	56.00	-25.84	-25.84	-27.08
13.851	0.25	24.42	23.79	24.67	24.04	60.00	-35.58	-35.58	-26.21
16.158	0.26	30.06	19.81	30.32	20.07	60.00	-29.94	-29.94	-30.19

NOTE :

1. Measurement uncertainty is +/-2dB
2. Emission level = Reading value + Correction factor
3. Correction Factor = Cable loss + Insertion loss of LISN
4. Margin value = Emission level - Limit
5. The emission of other frequencies was very low against the limit.
6. "-": The Quasi-peak reading value also meets average limit and measurement with the average detector is unnecessary.



TEST REPORT

Temperature: 25°C Humidity: 62%RH
Frequency Range: 0.15 – 30 MHz Tested Mode: Dongle, CH39
Receiver Detector: Q.P. and AV. Tested By: Jeff Yu
Tested Date: Jul. 20, 2007

Power Line Measured : Line

Freq. (MHz)	Correct. Factor (dB)	Reading Value (dB μ V)		Emission Level (dB μ V)		Limit (dB μ V)		Margin (dB)	
		Q.P.	AV.	Q.P.	AV.	Q.P.	AV.	Q.P.	AV.
0.201	0.28	43.98	35.44	44.26	35.72	64.54	54.54	-20.56	-19.10
0.204	0.28	44.60	37.23	44.88	37.51	64.46	54.46	-19.86	-17.22
0.538	0.24	34.56	30.22	34.80	30.46	56.00	46.00	-21.44	-15.78
3.259	0.18	30.18	13.39	30.36	13.57	56.00	46.00	-25.82	-32.61
14.47	0.25	25.48	18.42	25.73	18.67	60.00	50.00	-34.52	-31.58
16.691	0.29	30.74	20.68	31.03	20.97	60.00	50.00	-29.26	-29.32

Power Line Measured : Neutral

Freq. (MHz)	Correct. Factor (dB)	Reading Value (dB μ V)		Emission Level (dB μ V)		Limit (dB μ V)		Margin (dB)	
		Q.P.	AV.	Q.P.	AV.	Q.P.	AV.	Q.P.	AV.
0.198	0.30	44.12	36.37	44.42	36.67	64.63	54.63	-20.51	-18.26
0.201	0.28	43.12	35.86	43.40	36.14	64.54	54.54	-21.42	-18.68
0.543	0.24	33.40	17.61	33.64	17.85	56.00	46.00	-22.60	-28.39
1.447	0.15	30.20	23.33	30.35	23.48	56.00	46.00	-25.80	-22.67
14.957	0.25	31.16	22.60	31.41	22.85	60.00	50.00	-28.84	-27.40
16.681	0.27	30.44	22.22	30.71	22.49	60.00	50.00	-29.56	-27.78

NOTE :

1. Measurement uncertainty is +/-2dB
2. Emission level = Reading value + Correction factor
3. Correction Factor = Cable loss + Insertion loss of LISN
4. Margin value = Emission level - Limit
5. The emission of other frequencies was very low against the limit.
6. "-": The Quasi-peak reading value also meets average limit and measurement with the average detector is unnecessary.



Spectrum Research & Testing Lab., Inc.
No. 101-10, Ling 8,
Shan-Tong Li, Chung-Li
City, Taoyuan, Taiwan

TEST REPORT

Reference No.: A07062903
Report No.: FCCA07062903
FCC ID: Q7Z-BV300R1
Page: 15 of 103
Date: Jul. 27, 2007

Temperature:	<u>25°C</u>	Humidity:	<u>62%RH</u>
Frequency Range:	<u>0.15 – 30 MHz</u>	Tested Mode:	<u>Dongle, CH78</u>
Receiver Detector:	<u>Q.P. and AV.</u>	Tested By:	<u>Jeff Yu</u>
		Tested Date:	<u>Jul. 20, 2007</u>

Power Line Measured : Line

Freq. (MHz)	Correct. Factor (dB)	Reading Value (dB μ V)		Emission Level (dB μ V)		Limit (dB μ V)		Margin (dB)	
		Q.P.	AV.	Q.P.	AV.	Q.P.	AV.	Q.P.	AV.
0.198	0.30	44.06	34.80	44.36	35.10	64.63	54.63	-20.57	-19.83
0.204	0.28	43.74	32.70	44.02	32.98	64.46	54.46	-20.72	-21.75
0.528	0.24	33.46	21.66	33.70	21.90	56.00	46.00	-22.54	-24.34
2.774	0.17	30.60	13.40	30.77	13.57	56.00	46.00	-25.40	-32.60
14.724	0.25	30.92	24.06	31.17	24.31	60.00	50.00	-29.08	-25.94
16.784	0.30	29.90	22.14	30.20	22.44	60.00	50.00	-30.10	-27.86

Power Line Measured : Neutral

Freq. (MHz)	Correct. Factor (dB)	Reading Value (dB μ V)		Emission Level (dB μ V)		Limit (dB μ V)		Margin (dB)	
		Q.P.	AV.	Q.P.	AV.	Q.P.	AV.	Q.P.	AV.
0.153	0.30	38.12	18.09	38.42	18.39	65.91	55.91	-27.79	-37.83
0.204	0.28	44.50	35.77	44.78	36.05	64.46	54.46	-19.96	-18.69
0.543	0.24	34.34	28.74	34.58	28.98	56.00	46.00	-21.66	-17.26
2.655	0.17	31.56	23.82	31.73	23.99	56.00	46.00	-24.44	-22.18
14.734	0.25	30.82	23.28	31.07	23.53	60.00	50.00	-29.18	-26.72
17.778	0.29	41.74	42.37	42.03	42.66	60.00	50.00	-18.26	-7.63

NOTE :

1. Measurement uncertainty is +/-2dB
2. Emission level = Reading value + Correction factor
3. Correction Factor = Cable loss + Insertion loss of LISN
4. Margin value = Emission level - Limit
5. The emission of other frequencies was very low against the limit.
6. "-": The Quasi-peak reading value also meets average limit and measurement with the average detector is unnecessary.



4.2 RADIATED EMISSION TEST

4.2.1 LIMIT

FCC Part 15, Subpart C Section 15.209 limit of radiated emission measurement for frequency below 1000 MHz. The emissions from an intentional radiator shall not exceed the field strength levels specified in the following table:

FREQUENCY (MHz)	DISTANCE(m)	FIELD STRENGTH (dB μ V/m)
30 – 88	3	40.0
88 - 216	3	43.5
216 - 960	3	46.0
ABOVE 960	3	54.0

NOTE:

1. In the emission tables above, the tighter limit applies at the band edges.
2. Distance refers to the distance between measuring instrument, antenna, and the closest point of any part of the device or system.

FCC Part 15, Subpart 15.35(b) limit of radiated emission for frequency above 1000MHz

FREQUENCY (MHz)	Class A (dB μ V/m) (at 3m)		Class B (dB μ V/m) (at 3m)	
	PK.	AV.	PK.	AV.
Above 1000	80.0	60.0	74.0	54.0

FCC Part 15, Subpart C Section 15.249. The field strength of emissions from intentional radiators operated within these frequency bands shall comply with the following:

FUNDAMENTAL FREQUENCY (MHz)	FIELD STRENGTH OF FUNDAMENTAL (dB μ V/m) (at 3m)		FIELD STRENGTH OF HARMONICS (dB μ V/m) (at 3m)	
	PK.	AV.	PK.	AV.
902-928	114	94	74.0	54.0
2400-2483.5	114	94	74.0	54.0
5725-5875	114	94	74.0	54.0
24000-24250	128	108	88	68



Spectrum Research & Testing Lab., Inc.
No. 101-10, Ling 8,
Shan-Tong Li, Chung-Li
City, Taoyuan, Taiwan

TEST REPORT

Reference No.: A07062903
Report No.: FCCA07062903
FCC ID: Q7Z-BV300R1
Page: 17 of 103
Date: Jul. 27, 2007

4.2.2 TEST EQUIPMENT

The following test equipment was used during the radiated emission test:

EQUIPMENT/ FACILITIES	SPECIFICATIONS	MANUFACTURER	MODEL#/ SERIAL#	DUE DATE OF CAL. & CAL. CENTER
EMI TEST RECEIVER	9kHz TO 2.75 GHz	ROHDE & SCHWARZ	ESCS30/ 830245/012	OCT. 2007 ETC
BI-LOG ANTENNA	25 MHz TO 2 GHz	EMCO	3143/ 9509-1152	JUN. 2008 SRT
PRE-AMPLIFIER	1 GHz TO 26.5 GHz	HP	8449B/ 3008A01019	AUG. 2007 ETC
HORN ANTENNA	1 GHz TO 18 GHz	EMCO	3115/ 9602-4681	DEC. 2007 ETC
OATS	3 – 10 M MEASUREMENT	SRT	SRT-1	DEC. 2007 SRT
COAXIAL CABLE	25M	SUNCITY	J400-25M-2NP/ #153-25M	JUN. 2008 SRT
FILTER	2 LINE, 30A	FIL.COIL	FC-943/ 869	N/A
FREQUENCY CONVERTER	N/A	APC	AFC-2KBB/ F100030031	AUG. 2007 SRT

NOTE:

1. The calibration interval of the above test equipment is one year and the calibrations are traceable to NML/ROC and NIST/USA.
2. The Open Area Test Site (SRT-1) is registered by FCC with No. 90957 and VCCI with No. R-1081.
3. The Open Area Test Site (SRT-2) is registered by FCC with No. 98458 and VCCI with No. R-1168.



4.2.3 TEST SET-UP

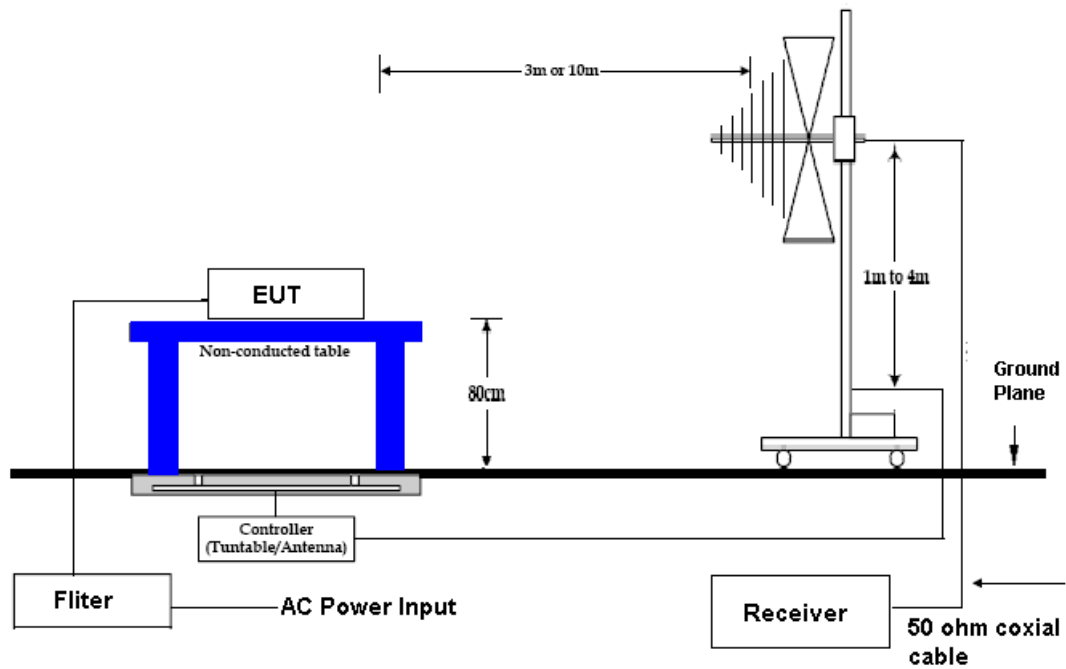

NOTE :

1. The EUT system was put on a wooden table with 0.8m heights above a ground plane.
2. For the actual test configuration, please refer to the photos of testing.



**Spectrum Research &
Testing Lab., Inc.**
No. 101-10, Ling 8,
Shan-Tong Li, Chung-Li
City, Taoyuan, Taiwan

TEST REPORT

Reference No.: A07062903
Report No.: FCCA07062903
FCC ID: Q7Z-BV300R1
Page: 19 of 103
Date: Jul. 27, 2007

4.2.4 TEST PROCEDURE

The EUT was tested according to the requirement of ANSI C63.4:2003 and CISPR 22:2006. The measurements were made at an open area test site with 10 meter measurement distance under 1 GHz and with 3m distance above 1GHz. The frequency spectrum measured started from 30 MHz. Under 1 GHz, all readings were quasi-peak values with 120 kHz resolution bandwidth of the test receiver. Above 1 GHz, the measurements were made at an open area test site with 3 meter measurement distance and all readings were peak or average values with 1 MHz resolution bandwidth of the test receiver. The EUT system was operated in all typical methods by users. The cables connected to EUT and support units were moved to find the maximum emission levels for each frequency.

First, Find the margin or higher points at least 6 points by software, then use manual to find the maximum data. The procedure is referred on the test procedure of SRT LAB.

4.2.5 EUT OPERATING CONDITION

Same as section 4.1.5 of this report.



4.2.6 RADIATED EMISSION TEST RESULT

Temperature:	23°C	Humidity:	65%RH
Frequency Range:	30 – 1000 MHz	Measured Distance:	3m
Receiver Detector:	Q.P. or AV.	Tested Mode:	BV-300, CH0-TX
Tested By:	Jeff Yu	Tested Date:	Jul. 18, 2007

Antenna Polarization: Horizontal

Frequency (MHz)	Cable Loss (dB)	Antenna Factor (dB/m)	Reading Data (dBμV)	Emission Level (dBμV/m)	Limit (dBμV/m)	Margin (dB)
133.8465	2.06	8.66	20.2	30.9	43.5	-12.6
298.1890	3.01	13.60	14.8	31.4	46.0	-14.6
388.4620	3.52	15.40	16.1	35.0	46.0	-11.0
455.2130	3.90	17.80	12.5	34.2	46.0	-11.8
520.4893	4.22	18.60	10.1	32.9	46.0	-13.1
673.9150	4.88	20.69	9.5	35.1	46.0	-10.9

Antenna Polarization: Vertical

Frequency (MHz)	Cable Loss (dB)	Antenna Factor (dB/m)	Reading Data (dBμV)	Emission Level (dBμV/m)	Limit (dBμV/m)	Margin (dB)
133.8465	2.06	8.66	20.8	31.5	43.5	-12.0
298.1890	3.01	13.60	13.5	30.1	46.0	-15.9
388.4620	3.52	15.40	11.8	30.7	46.0	-15.3
455.2130	3.90	17.80	10.7	32.4	46.0	-13.6
520.4893	4.22	18.60	8.9	31.7	46.0	-14.3
673.9150	4.88	20.69	8.2	33.8	46.0	-12.2

NOTE :

1. Measurement uncertainty is +/-2dB.
2. "*": Measurement does not apply for this frequency.
3. Emission Level = Reading Value + Ant. Factor + Cable Loss.
4. The field strength of other emission frequencies were very low against the limit.



TEST REPORT

Temperature:	23°C	Humidity:	65%RH
Frequency Range:	30 – 1000 MHz	Measured Distance:	3m
Receiver Detector:	Q.P. or AV.	Tested Mode:	BV-300, CH0-Link
Tested By:	Jeff Yu	Tested Date:	Jul. 18, 2007

Antenna Polarization: Horizontal

Frequency (MHz)	Cable Loss (dB)	Antenna Factor (dB/m)	Reading Data (dB μ V)	Emission Level (dB μ V/m)	Limit (dB μ V/m)	Margin (dB)
133.8465	2.06	8.48	23.4	33.9	43.5	-9.6
298.1890	3.01	13.61	15.7	32.3	46.0	-13.7
388.4620	3.52	15.64	16.5	35.7	46.0	-10.3
455.2130	3.90	16.01	11.5	31.4	46.0	-14.6
520.4893	4.22	16.36	10.1	30.7	46.0	-15.3
673.9150	4.88	20.03	9.5	34.4	46.0	-11.6

Antenna Polarization: Vertical

Frequency (MHz)	Cable Loss (dB)	Antenna Factor (dB/m)	Reading Data (dB μ V)	Emission Level (dB μ V/m)	Limit (dB μ V/m)	Margin (dB)
133.8465	2.06	8.48	24.8	35.3	43.5	-8.2
298.1890	3.01	13.61	12.3	28.9	46.0	-17.1
388.4620	3.52	15.64	11.0	30.2	46.0	-15.8
455.2130	3.90	16.01	9.5	29.4	46.0	-16.6
520.4893	4.22	16.36	8.9	29.5	46.0	-16.5
673.9150	4.88	20.03	7.5	32.4	46.0	-13.6

NOTE :

1. Measurement uncertainty is +/-2dB.
2. "**": Measurement does not apply for this frequency.
3. Emission Level = Reading Value + Ant. Factor + Cable Loss.
4. The field strength of other emission frequencies were very low against the limit.



Spectrum Research & Testing Lab., Inc.
No. 101-10, Ling 8,
Shan-Tong Li, Chung-Li
City, Taoyuan, Taiwan

TEST REPORT

Reference No.: A07062903
Report No.: FCCA07062903
FCC ID: Q7Z-BV300R1
Page: 22 of 103
Date: Jul. 27, 2007

Temperature:	23°C	Humidity:	65%RH
Frequency Range:	30 – 1000 MHz	Measured Distance:	3m
Receiver Detector:	Q.P. or AV.	Tested Mode:	BV-300, CH0-RX
Tested By:	Jeff Yu	Tested Date:	Jul. 18, 2007

Antenna Polarization: Horizontal

Frequency (MHz)	Cable Loss (dB)	Antenna Factor (dB/m)	Reading Data (dB μ V)	Emission Level (dB μ V/m)	Limit (dB μ V/m)	Margin (dB)
133.8465	2.06	8.66	21.5	32.2	43.5	-11.3
298.1890	3.01	13.60	14.2	30.8	46.0	-15.2
388.4620	3.52	15.40	12.3	31.2	46.0	-14.8
455.2130	3.90	17.80	10.6	32.3	46.0	-13.7
520.4893	4.22	18.60	9.7	32.5	46.0	-13.5
673.9150	4.88	20.69	9.1	34.7	46.0	-11.3

Antenna Polarization: Vertical

Frequency (MHz)	Cable Loss (dB)	Antenna Factor (dB/m)	Reading Data (dB μ V)	Emission Level (dB μ V/m)	Limit (dB μ V/m)	Margin (dB)
133.8465	2.06	8.66	21.2	31.9	43.5	-11.6
298.1890	3.01	13.60	12.8	29.4	46.0	-16.6
388.4620	3.52	15.40	10.5	29.4	46.0	-16.6
455.2130	3.90	17.80	9.3	31.0	46.0	-15.0
520.4893	4.22	18.60	8.7	31.5	46.0	-14.5
673.9150	4.88	20.69	8.2	33.8	46.0	-12.2

NOTE :

1. Measurement uncertainty is +/-2dB.
2. "**": Measurement does not apply for this frequency.
3. Emission Level = Reading Value + Ant. Factor + Cable Loss.
4. The field strength of other emission frequencies were very low against the limit.



Spectrum Research & Testing Lab., Inc.
No. 101-10, Ling 8,
Shan-Tong Li, Chung-Li
City, Taoyuan, Taiwan

TEST REPORT

Reference No.: A07062903
Report No.: FCCA07062903
FCC ID: Q7Z-BV300R1
Page: 23 of 103
Date: Jul. 27, 2007

Temperature:	23°C	Humidity:	65%RH
Frequency Range:	30 – 1000 MHz	Measured Distance:	3m
Receiver Detector:	Q.P. or AV.	Tested Mode:	BV-300, CH39-TX
Tested By:	Jeff Yu	Tested Date:	Jul. 18, 2007

Antenna Polarization: Horizontal

Frequency (MHz)	Cable Loss (dB)	Antenna Factor (dB/m)	Reading Data (dBμV)	Emission Level (dBμV/m)	Limit (dBμV/m)	Margin (dB)
186.8460	2.41	10.34	21.6	34.3	43.5	-9.2
242.3890	2.73	11.20	15.7	29.6	46.0	-16.4
367.1935	3.38	15.30	13.5	32.2	46.0	-13.8
457.3680	3.91	17.80	12.8	34.5	46.0	-11.5
526.9820	4.25	18.78	10.6	33.6	46.0	-12.4
662.9350	4.82	20.44	10.2	35.5	46.0	-10.5

Antenna Polarization: Vertical

Frequency (MHz)	Cable Loss (dB)	Antenna Factor (dB/m)	Reading Data (dBμV)	Emission Level (dBμV/m)	Limit (dBμV/m)	Margin (dB)
186.8460	2.41	10.34	22.3	35.0	43.5	-8.5
242.3890	2.73	11.20	14.0	27.9	46.0	-18.1
367.1935	3.38	15.30	11.8	30.5	46.0	-15.5
457.3680	3.91	17.80	11.3	33.0	46.0	-13.0
526.9820	4.25	18.78	9.2	32.2	46.0	-13.8
662.9350	4.82	20.44	8.4	33.7	46.0	-12.3

NOTE :

1. Measurement uncertainty is +/-2dB.
2. "*": Measurement does not apply for this frequency.
3. Emission Level = Reading Value + Ant. Factor + Cable Loss.
4. The field strength of other emission frequencies were very low against the limit.



Spectrum Research & Testing Lab., Inc.
 No. 101-10, Ling 8,
 Shan-Tong Li, Chung-Li
 City, Taoyuan, Taiwan

TEST REPORT

Reference No.: A07062903
 Report No.: FCCA07062903
 FCC ID: Q7Z-BV300R1
 Page: 24 of 103
 Date: Jul. 27, 2007

Temperature:	23°C	Humidity:	65%RH
Frequency Range:	30 – 1000 MHz	Measured Distance:	3m
Receiver Detector:	Q.P. or AV.	Tested Mode:	BV-300, CH39-Link
Tested By:	Jeff Yu	Tested Date:	Jul. 18, 2007

Antenna Polarization: Horizontal

Frequency (MHz)	Cable Loss (dB)	Antenna Factor (dB/m)	Reading Data (dBμV)	Emission Level (dBμV/m)	Limit (dBμV/m)	Margin (dB)
186.8460	2.41	10.34	21.9	34.6	43.5	-8.9
242.3890	2.73	11.20	15.5	29.4	46.0	-16.6
367.1935	3.38	15.30	14.8	33.5	46.0	-12.5
457.3680	3.91	17.80	11.8	33.5	46.0	-12.5
526.9820	4.25	18.78	10.4	33.4	46.0	-12.6
662.9350	4.82	20.44	9.2	34.5	46.0	-11.5

Antenna Polarization: Vertical

Frequency (MHz)	Cable Loss (dB)	Antenna Factor (dB/m)	Reading Data (dBμV)	Emission Level (dBμV/m)	Limit (dBμV/m)	Margin (dB)
186.8460	2.41	10.34	24.3	37.0	43.5	-6.5
242.3890	2.73	11.20	13.1	27.0	46.0	-19.0
367.1935	3.38	15.30	12.2	30.9	46.0	-15.1
457.3680	3.91	17.80	10.6	32.3	46.0	-13.7
526.9820	4.25	18.78	9.8	32.8	46.0	-13.2
662.9350	4.82	20.44	7.8	33.1	46.0	-12.9

NOTE :

1. Measurement uncertainty is +/-2dB.
2. "**": Measurement does not apply for this frequency.
3. Emission Level = Reading Value + Ant. Factor + Cable Loss.
4. The field strength of other emission frequencies were very low against the limit.



Spectrum Research & Testing Lab., Inc.
No. 101-10, Ling 8,
Shan-Tong Li, Chung-Li
City, Taoyuan, Taiwan

TEST REPORT

Reference No.: A07062903
Report No.: FCCA07062903
FCC ID: Q7Z-BV300R1
Page: 25 of 103
Date: Jul. 27, 2007

Temperature:	23°C	Humidity:	65%RH
Frequency Range:	30 – 1000 MHz	Measured Distance:	3m
Receiver Detector:	Q.P. or AV.	Tested Mode:	BV-300, CH78-TX
Tested By:	Jeff Yu	Tested Date:	Jul. 18, 2007

Antenna Polarization: Horizontal

Frequency (MHz)	Cable Loss (dB)	Antenna Factor (dB/m)	Reading Data (dBμV)	Emission Level (dBμV/m)	Limit (dBμV/m)	Margin (dB)
112.0480	1.84	6.14	22.2	30.2	43.5	-13.3
289.4320	2.97	12.77	16.5	32.2	46.0	-13.8
336.1850	3.20	14.82	15.8	33.8	46.0	-12.2
433.5450	3.78	16.95	12.6	33.3	46.0	-12.7
577.8460	4.49	19.30	9.8	33.6	46.0	-12.4
671.2570	4.87	20.63	8.4	33.9	46.0	-12.1

Antenna Polarization: Vertical

Frequency (MHz)	Cable Loss (dB)	Antenna Factor (dB/m)	Reading Data (dBμV)	Emission Level (dBμV/m)	Limit (dBμV/m)	Margin (dB)
112.0480	1.84	6.14	23.4	31.4	43.5	-12.1
289.4320	2.97	12.77	14.3	30.0	46.0	-16.0
336.1850	3.20	14.82	12.7	30.7	46.0	-15.3
433.5450	3.78	16.95	10.5	31.2	46.0	-14.8
577.8460	4.49	19.30	8.0	31.8	46.0	-14.2
671.2570	4.87	20.63	7.1	32.6	46.0	-13.4

NOTE :

1. Measurement uncertainty is +/-2dB.
2. "**": Measurement does not apply for this frequency.
3. Emission Level = Reading Value + Ant. Factor + Cable Loss.
4. The field strength of other emission frequencies were very low against the limit.



Spectrum Research & Testing Lab., Inc.
No. 101-10, Ling 8,
Shan-Tong Li, Chung-Li
City, Taoyuan, Taiwan

TEST REPORT

Reference No.: A07062903
Report No.: FCCA07062903
FCC ID: Q7Z-BV300R1
Page: 26 of 103
Date: Jul. 27, 2007

Temperature:	23°C	Humidity:	65%RH
Frequency Range:	30 – 1000 MHz	Measured Distance:	3m
Receiver Detector:	Q.P. or AV.	Tested Mode:	BV-300, CH78-Link
Tested By:	Jeff Yu	Tested Date:	Jul. 18, 2007

Antenna Polarization: Horizontal

Frequency (MHz)	Cable Loss (dB)	Antenna Factor (dB/m)	Reading Data (dB μ V)	Emission Level (dB μ V/m)	Limit (dB μ V/m)	Margin (dB)
112.0480	1.84	6.14	22.6	30.6	43.5	-12.9
289.4320	2.97	12.77	14.9	30.6	46.0	-15.4
336.1850	3.20	14.82	15.7	33.7	46.0	-12.3
433.5450	3.78	16.95	11.4	32.1	46.0	-13.9
577.8460	4.49	19.30	10.3	34.1	46.0	-11.9
671.2570	4.87	20.63	8.9	34.4	46.0	-11.6

Antenna Polarization: Vertical

Frequency (MHz)	Cable Loss (dB)	Antenna Factor (dB/m)	Reading Data (dB μ V)	Emission Level (dB μ V/m)	Limit (dB μ V/m)	Margin (dB)
112.0480	1.84	6.14	23.2	31.2	43.5	-12.3
289.4320	2.97	12.77	13.2	28.9	46.0	-17.1
336.1850	3.20	14.82	12.7	30.7	46.0	-15.3
433.5450	3.78	16.95	9.8	30.5	46.0	-15.5
577.8460	4.49	19.30	9.5	33.3	46.0	-12.7
671.2570	4.87	20.63	8.1	33.6	46.0	-12.4

NOTE :

1. Measurement uncertainty is +/-2dB.
2. "*": Measurement does not apply for this frequency.
3. Emission Level = Reading Value + Ant. Factor + Cable Loss.
4. The field strength of other emission frequencies were very low against the limit.



Spectrum Research & Testing Lab., Inc.
No. 101-10, Ling 8,
Shan-Tong Li, Chung-Li
City, Taoyuan, Taiwan

TEST REPORT

Reference No.: A07062903
Report No.: FCCA07062903
FCC ID: Q7Z-BV300R1
Page: 27 of 103
Date: Jul. 27, 2007

Temperature:	23°C	Humidity:	65%RH
Frequency Range:	30 – 1000 MHz	Measured Distance:	3m
Receiver Detector:	Q.P. or AV.	Tested Mode:	Dongle, CH0-TX
Tested By:	Jeff Yu	Tested Date:	Jul. 19, 2007

Antenna Polarization: Horizontal

Frequency (MHz)	Cable Loss (dB)	Antenna Factor (dB/m)	Reading Data (dB μ V)	Emission Level (dB μ V/m)	Limit (dB μ V/m)	Margin (dB)
195.6680	2.47	10.35	21.6	34.4	43.5	-9.1
294.3100	2.99	13.20	15.3	31.5	46.0	-14.5
393.6810	3.55	15.40	16.2	35.2	46.0	-10.8
432.5920	3.77	16.90	12.8	33.5	46.0	-12.5
536.9020	4.30	19.02	10.8	34.1	46.0	-11.9
677.2480	4.91	20.81	8.3	34.0	46.0	-12.0

Antenna Polarization: Vertical

Frequency (MHz)	Cable Loss (dB)	Antenna Factor (dB/m)	Reading Data (dB μ V)	Emission Level (dB μ V/m)	Limit (dB μ V/m)	Margin (dB)
195.6680	2.47	10.35	22.8	35.6	43.5	-7.9
294.3100	2.99	13.20	13.2	29.4	46.0	-16.6
393.6810	3.55	15.40	12.4	31.4	46.0	-14.6
432.5920	3.77	16.90	10.5	31.2	46.0	-14.8
536.9020	4.30	19.02	9.1	32.4	46.0	-13.6
677.2480	4.91	20.81	7.4	33.1	46.0	-12.9

NOTE :

1. Measurement uncertainty is +/-2dB.
2. "*": Measurement does not apply for this frequency.
3. Emission Level = Reading Value + Ant. Factor + Cable Loss.
4. The field strength of other emission frequencies were very low against the limit.



Spectrum Research & Testing Lab., Inc.
No. 101-10, Ling 8,
Shan-Tong Li, Chung-Li
City, Taoyuan, Taiwan

TEST REPORT

Reference No.: A07062903
Report No.: FCCA07062903
FCC ID: Q7Z-BV300R1
Page: 28 of 103
Date: Jul. 27, 2007

Temperature:	23°C	Humidity:	65%RH
Frequency Range:	30 – 1000 MHz	Measured Distance:	3m
Receiver Detector:	Q.P. or AV.	Tested Mode:	Dongle, CH0-Link
Tested By:	Jeff Yu	Tested Date:	Jul. 19, 2007

Antenna Polarization: Horizontal

Frequency (MHz)	Cable Loss (dB)	Antenna Factor (dB/m)	Reading Data (dBμV)	Emission Level (dBμV/m)	Limit (dBμV/m)	Margin (dB)
195.6680	2.47	10.30	22.5	35.3	43.5	-8.2
294.3100	2.99	13.44	16.8	33.2	46.0	-12.8
393.6810	3.55	15.75	16.0	35.3	46.0	-10.7
432.5920	3.77	15.96	14.5	34.2	46.0	-11.8
536.9020	4.30	16.57	12.7	33.6	46.0	-12.4
677.2480	4.91	20.17	11.3	36.4	46.0	-9.6

Antenna Polarization: Vertical

Frequency (MHz)	Cable Loss (dB)	Antenna Factor (dB/m)	Reading Data (dBμV)	Emission Level (dBμV/m)	Limit (dBμV/m)	Margin (dB)
195.6680	2.47	10.30	24.6	37.4	43.5	-6.1
294.3100	2.99	13.44	15.2	31.6	46.0	-14.4
393.6810	3.55	15.75	14.2	33.5	46.0	-12.5
432.5920	3.77	15.96	11.3	31.0	46.0	-15.0
536.9020	4.30	16.57	10.8	31.7	46.0	-14.3
677.2480	4.91	20.17	9.6	34.7	46.0	-11.3

NOTE :

1. Measurement uncertainty is +/-2dB.
2. "**": Measurement does not apply for this frequency.
3. Emission Level = Reading Value + Ant. Factor + Cable Loss.
4. The field strength of other emission frequencies were very low against the limit.



Temperature:	23°C	Humidity:	65%RH
Frequency Range:	30 – 1000 MHz	Measured Distance:	3m
Receiver Detector:	Q.P. or AV.	Tested Mode:	Dongle, CH0-RX
Tested By:	Jeff Yu	Tested Date:	Jul. 19, 2007

Antenna Polarization: Horizontal

Frequency (MHz)	Cable Loss (dB)	Antenna Factor (dB/m)	Reading Data (dB μ V)	Emission Level (dB μ V/m)	Limit (dB μ V/m)	Margin (dB)
195.6680	2.47	10.35	20.1	32.9	43.5	-10.6
294.3100	2.99	13.20	14.3	30.5	46.0	-15.5
393.6810	3.55	15.40	12.3	31.3	46.0	-14.7
432.5920	3.77	16.90	9.8	30.5	46.0	-15.5
536.9020	4.30	19.02	9.3	32.6	46.0	-13.4
677.2480	4.91	20.81	7.8	33.5	46.0	-12.5

Antenna Polarization: Vertical

Frequency (MHz)	Cable Loss (dB)	Antenna Factor (dB/m)	Reading Data (dB μ V)	Emission Level (dB μ V/m)	Limit (dB μ V/m)	Margin (dB)
195.6680	2.47	10.35	21.6	34.4	43.5	-9.1
294.3100	2.99	13.20	12.8	29.0	46.0	-17.0
393.6810	3.55	15.40	10.2	29.2	46.0	-16.8
432.5920	3.77	16.90	9.5	30.2	46.0	-15.8
536.9020	4.30	19.02	8.6	31.9	46.0	-14.1
677.2480	4.91	20.81	7.2	32.9	46.0	-13.1

NOTE :

1. Measurement uncertainty is +/-2dB.
2. "*": Measurement does not apply for this frequency.
3. Emission Level = Reading Value + Ant. Factor + Cable Loss.
4. The field strength of other emission frequencies were very low against the limit.



Spectrum Research & Testing Lab., Inc.
No. 101-10, Ling 8,
Shan-Tong Li, Chung-Li
City, Taoyuan, Taiwan

TEST REPORT

Reference No.: A07062903
Report No.: FCCA07062903
FCC ID: Q7Z-BV300R1
Page:30 of 103
Date: Jul. 27, 2007

Temperature:	23°C	Humidity:	65%RH
Frequency Range:	30 – 1000 MHz	Measured Distance:	3m
Receiver Detector:	Q.P. or AV.	Tested Mode:	Dongle, CH39-TX
Tested By:	Jeff Yu	Tested Date:	Jul. 19, 2007

Antenna Polarization: Horizontal

Frequency (MHz)	Cable Loss (dB)	Antenna Factor (dB/m)	Reading Data (dBμV)	Emission Level (dBμV/m)	Limit (dBμV/m)	Margin (dB)
183.5250	2.37	10.07	21.7	34.1	43.5	-9.4
252.8625	2.80	12.04	16.3	31.1	46.0	-14.9
390.3580	3.53	15.40	15.2	34.1	46.0	-11.9
481.2680	4.03	17.91	11.7	33.6	46.0	-12.4
587.6290	4.54	19.23	10.3	34.1	46.0	-11.9
720.6480	5.09	22.20	8.9	36.2	46.0	-9.8

Antenna Polarization: Vertical

Frequency (MHz)	Cable Loss (dB)	Antenna Factor (dB/m)	Reading Data (dBμV)	Emission Level (dBμV/m)	Limit (dBμV/m)	Margin (dB)
183.5250	2.37	10.07	22.8	35.2	43.5	-8.3
252.8625	2.80	12.04	12.4	27.2	46.0	-18.8
390.3580	3.53	15.40	11.2	30.1	46.0	-15.9
481.2680	4.03	17.91	9.8	31.7	46.0	-14.3
587.6290	4.54	19.23	8.2	32.0	46.0	-14.0
720.6480	5.09	22.20	7.6	34.9	46.0	-11.1

NOTE :

1. Measurement uncertainty is +/-2dB.
2. "**": Measurement does not apply for this frequency.
3. Emission Level = Reading Value + Ant. Factor + Cable Loss.
4. The field strength of other emission frequencies were very low against the limit.



TEST REPORT

Temperature:	23°C	Humidity:	65%RH
Frequency Range:	30 – 1000 MHz	Measured Distance:	3m
Receiver Detector:	Q.P. or AV.	Tested Mode:	Dongle, CH39-Link
Tested By:	Jeff Yu	Tested Date:	Jul. 19, 2007

Antenna Polarization: Horizontal

Frequency (MHz)	Cable Loss (dB)	Antenna Factor (dB/m)	Reading Data (dB μ V)	Emission Level (dB μ V/m)	Limit (dB μ V/m)	Margin (dB)
183.5250	2.37	10.07	21.8	34.2	43.5	-9.3
252.8625	2.80	12.04	15.8	30.6	46.0	-15.4
390.3580	3.53	15.40	13.6	32.5	46.0	-13.5
481.2680	4.03	17.91	12.5	34.4	46.0	-11.6
587.6290	4.54	19.23	10.7	34.5	46.0	-11.5
720.6480	5.09	22.20	8.3	35.6	46.0	-10.4

Antenna Polarization: Vertical

Frequency (MHz)	Cable Loss (dB)	Antenna Factor (dB/m)	Reading Data (dB μ V)	Emission Level (dB μ V/m)	Limit (dB μ V/m)	Margin (dB)
183.5250	2.37	10.07	23.6	36.0	43.5	-7.5
252.8625	2.80	12.04	11.9	26.7	46.0	-19.3
390.3580	3.53	15.40	12.3	31.2	46.0	-14.8
481.2680	4.03	17.91	10.5	32.4	46.0	-13.6
587.6290	4.54	19.23	9.4	33.2	46.0	-12.8
720.6480	5.09	22.20	7.6	34.9	46.0	-11.1

NOTE :

1. Measurement uncertainty is +/-2dB.
2. "*": Measurement does not apply for this frequency.
3. Emission Level = Reading Value + Ant. Factor + Cable Loss.
4. The field strength of other emission frequencies were very low against the limit.



Spectrum Research & Testing Lab., Inc.
 No. 101-10, Ling 8,
 Shan-Tong Li, Chung-Li
 City, Taoyuan, Taiwan

TEST REPORT

Reference No.: A07062903
 Report No.: FCCA07062903
 FCC ID: Q7Z-BV300R1
 Page: 32 of 103
 Date: Jul. 27, 2007

Temperature:	23°C	Humidity:	65%RH
Frequency Range:	30 – 1000 MHz	Measured Distance:	3m
Receiver Detector:	Q.P. or AV.	Tested Mode:	Dongle, CH78-TX
Tested By:	Jeff Yu	Tested Date:	Jul. 19, 2007

Antenna Polarization: Horizontal

Frequency (MHz)	Cable Loss (dB)	Antenna Factor (dB/m)	Reading Data (dBμV)	Emission Level (dBμV/m)	Limit (dBμV/m)	Margin (dB)
156.3150	2.20	10.02	22.8	35.0	43.5	-8.5
239.6520	2.71	10.99	16.3	30.0	46.0	-16.0
366.9810	3.38	15.30	14.5	33.2	46.0	-12.8
496.1295	4.10	18.00	12.8	34.9	46.0	-11.1
434.3250	3.78	17.00	10.3	31.1	46.0	-14.9
676.2930	4.90	20.78	8.5	34.2	46.0	-11.8

Antenna Polarization: Vertical

Frequency (MHz)	Cable Loss (dB)	Antenna Factor (dB/m)	Reading Data (dBμV)	Emission Level (dBμV/m)	Limit (dBμV/m)	Margin (dB)
156.3150	2.20	10.02	23.4	35.6	43.5	-7.9
239.6520	2.71	10.99	14.8	28.5	46.0	-17.5
366.9810	3.38	15.30	12.4	31.1	46.0	-14.9
496.1295	4.10	18.00	11.6	33.7	46.0	-12.3
434.3250	3.78	17.00	9.1	29.9	46.0	-16.1
676.2930	4.90	20.78	7.7	33.4	46.0	-12.6

NOTE :

1. Measurement uncertainty is +/-2dB.
2. "**": Measurement does not apply for this frequency.
3. Emission Level = Reading Value + Ant. Factor + Cable Loss.
4. The field strength of other emission frequencies were very low against the limit.



Spectrum Research & Testing Lab., Inc.
 No. 101-10, Ling 8,
 Shan-Tong Li, Chung-Li
 City, Taoyuan, Taiwan

TEST REPORT

Reference No.: A07062903
 Report No.: FCCA07062903
 FCC ID: Q7Z-BV300R1
 Page:33 of 103
 Date: Jul. 27, 2007

Temperature:	23°C	Humidity:	65%RH
Frequency Range:	30 – 1000 MHz	Measured Distance:	3m
Receiver Detector:	Q.P. or AV.	Tested Mode:	Dongle, CH78-Link
Tested By:	Jeff Yu	Tested Date:	Jul. 19, 2007

Antenna Polarization: Horizontal

Frequency (MHz)	Cable Loss (dB)	Antenna Factor (dB/m)	Reading Data (dBμV)	Emission Level (dBμV/m)	Limit (dBμV/m)	Margin (dB)
156.3150	2.20	10.02	34.7	34.7	43.5	-8.8
239.6520	2.71	10.99	30.0	30.0	46.0	-16.0
366.9810	3.38	15.30	34.3	34.3	46.0	-11.7
496.1295	4.10	18.00	34.9	34.9	46.0	-11.1
434.3250	3.78	17.00	31.7	31.7	46.0	-14.3
676.2930	4.90	20.78	35.5	35.5	46.0	-10.5

Antenna Polarization: Vertical

Frequency (MHz)	Cable Loss (dB)	Antenna Factor (dB/m)	Reading Data (dBμV)	Emission Level (dBμV/m)	Limit (dBμV/m)	Margin (dB)
156.3150	2.20	10.02	24.8	37.0	43.5	-6.5
239.6520	2.71	10.99	12.8	26.5	46.0	-19.5
366.9810	3.38	15.30	11.4	30.1	46.0	-15.9
496.1295	4.10	18.00	10.3	32.4	46.0	-13.6
434.3250	3.78	17.00	9.7	30.5	46.0	-15.5
676.2930	4.90	20.78	7.8	33.5	46.0	-12.5

NOTE :

1. Measurement uncertainty is +/-2dB.
2. "*": Measurement does not apply for this frequency.
3. Emission Level = Reading Value + Ant. Factor + Cable Loss.
4. The field strength of other emission frequencies were very low against the limit.



TEST REPORT

Temperature:	23°C	Humidity:	65%RH
Frequency Range:	1 – 12.5 GHz	Measured Distance:	3m
Receiver Detector:	Q.P. or AV.	Tested Mode:	BV-300, CH0-TX
Tested By:	Jeff Yu	Tested Date:	Jul. 18, 2007

Antenna Polarization: Horizontal

Frequency (MHz)	Corret Factor (dB)	Antenna Factor (dB/m)	Reading (dBμV)		Emission (dBμV/m)		Limit (dBμV/m)		Margin (dB)	
			PK	AV	PK	AV	PK	AV	PK	AV
2402	-32.16	28.54	81.3	61.7	77.7	58.1	N/A	N/A	N/A	N/A
2130.853	-32.33	27.46	30.8	*	25.9	*	74.0	54.0	-48.1	*
2755.293	-31.88	29.63	26.2	*	23.9	*	74.0	54.0	-50.1	*
4574.759	-30.42	33.46	33.2	*	36.2	*	74.0	54.0	-37.8	*
4804	-30.47	33.64	28.1	*	31.3	*	74.0	54.0	-42.7	*
8049.32	-29.06	37.14	33.2	*	41.3	*	74.0	54.0	-32.7	*

Antenna Polarization: Vertical

Frequency (MHz)	Corret Factor (dB)	Antenna Factor (dB/m)	Reading (dBμV)		Emission (dBμV/m)		Limit (dBμV/m)		Margin (dB)	
			PK	AV	PK	AV	PK	AV	PK	AV
2402	-32.16	28.00	82.8	62.6	78.6	58.4	N/A	N/A	N/A	N/A
2130.853	-32.33	27.46	33.1	*	28.2	*	74.0	54.0	-45.8	*
2755.293	-31.88	29.63	31.4	*	29.1	*	74.0	54.0	-44.9	*
4574.759	-30.42	33.46	35.3	*	38.3	*	74.0	54.0	-35.7	*
4804	-30.47	33.64	29.4	*	32.6	*	74.0	54.0	-41.4	*
8049.32	-29.06	37.14	37.4	*	45.5	*	74.0	54.0	-28.5	*

NOTE :

1. Measurement uncertainty is +/-2dB.
2. "*": Measurement does not apply for this frequency.
3. Emission Level = Reading Value + Ant. Factor + Cable Loss.
4. The field strength of other emission frequencies were very low against the limit.



Spectrum Research & Testing Lab., Inc.
No. 101-10, Ling 8,
Shan-Tong Li, Chung-Li
City, Taoyuan, Taiwan

TEST REPORT

Reference No.: A07062903
Report No.: FCCA07062903
FCC ID: Q7Z-BV300R1
Page:35 of 103
Date: Jul. 27, 2007

Temperature:	23°C	Humidity:	65%RH
Frequency Range:	1-12.5GHz	Measured Distance:	3m
Receiver Detector:	PK. or AV.	Tested Mode:	BV-300, CH0-Link
Tested By:	Jeff Yu	Tested Date:	Jul. 18, 2007

Antenna Polarization: Horizontal

Frequency (MHz)	Corret Factor (dB)	Antenna Factor (dB/m)	Reading (dB μ V)		Emission (dB μ V/m)		Limit (dB μ V/m)		Margin (dB)	
			PK	AV	PK	AV	PK	AV	PK	AV
2402	-32.16	28.54	86.3	62.2	82.7	58.6	N/A	N/A	N/A	N/A
2130.853	-32.33	27.46	35.2	*	30.3	*	74.0	54.0	-43.7	*
2755.293	-31.88	29.63	31.4	*	29.1	*	74.0	54.0	-44.9	*
4574.759	-30.42	33.46	29.8	*	32.8	*	74.0	54.0	-41.2	*
4804	-30.47	33.64	30.5	*	33.7	*	74.0	54.0	-40.3	*
8049.32	-29.06	37.14	32.6	*	40.7	*	74.0	54.0	-33.3	*

Antenna Polarization: Vertical

Frequency (MHz)	Corret Factor (dB)	Antenna Factor (dB/m)	Reading (dB μ V)		Emission (dB μ V/m)		Limit (dB μ V/m)		Margin (dB)	
			PK	AV	PK	AV	PK	AV	PK	AV
2402	-32.16	28.00	83.4	63.8	79.2	59.6	N/A	N/A	N/A	N/A
2130.853	-32.33	27.46	36.5	*	31.6	*	74.0	54.0	-42.4	*
2755.293	-31.88	29.63	34.2	*	31.9	*	74.0	54.0	-42.1	*
4574.759	-30.42	33.46	32.8	*	35.8	*	74.0	54.0	-38.2	*
4804	-30.47	33.64	32.3	*	35.5	*	74.0	54.0	-38.5	*
8049.32	-29.06	37.14	43.2	*	51.3	*	74.0	54.0	-22.7	*

NOTE :

1. Measurement uncertainty is +/-2dB.
2. "*": Measurement does not apply for this frequency.
3. Emission Level = Reading Value + Ant. Factor + Cable Loss.
4. The field strength of other emission frequencies were very low against the limit.



TEST REPORT

Temperature:	23°C	Humidity:	65%RH
Frequency Range:	1-12.5GHz	Measured Distance:	3m
Receiver Detector:	PK. or AV.	Tested Mode:	BV-300, CH0-RX
Tested By:	Jeff Yu	Tested Date:	Jul. 18, 2007

Antenna Polarization: Horizontal

Frequency (MHz)	Corret Factor (dB)	Antenna Factor (dB/m)	Reading (dBμV)		Emission (dBμV/m)		Limit (dBμV/m)		Margin (dB)	
			PK	AV	PK	AV	PK	AV	PK	AV
2402	-32.16	28.54	80.3	58.3	76.7	54.7	N/A	N/A	N/A	N/A
2130.853	-32.33	27.46	24.5	*	19.6	*	74.0	54.0	-54.4	*
2755.293	-31.88	29.63	22.6	*	20.3	*	74.0	54.0	-53.7	*
4574.759	-30.42	33.46	24.1	*	27.1	*	74.0	54.0	-46.9	*
4804	-30.47	33.64	23.6	*	26.8	*	74.0	54.0	-47.2	*
8049.32	-29.06	37.14	22.1	*	30.2	*	74.0	54.0	-43.8	*

Antenna Polarization: Vertical

Frequency (MHz)	Corret Factor (dB)	Antenna Factor (dB/m)	Reading (dBμV)		Emission (dBμV/m)		Limit (dBμV/m)		Margin (dB)	
			PK	AV	PK	AV	PK	AV	PK	AV
2402	-32.16	28.00	81.9	60.2	77.7	56.0	N/A	N/A	N/A	N/A
2130.853	-32.33	27.46	26.3	*	21.4	*	74.0	54.0	-52.6	*
2755.293	-31.88	29.63	25.3	*	23.0	*	74.0	54.0	-51.0	*
4574.759	-30.42	33.46	26.7	*	29.7	*	74.0	54.0	-44.3	*
4804	-30.47	33.64	24.2	*	27.4	*	74.0	54.0	-46.6	*
8049.32	-29.06	37.14	25	*	33.1	*	74.0	54.0	-40.9	*

NOTE :

1. Measurement uncertainty is +/-2dB.
2. "*": Measurement does not apply for this frequency.
3. Emission Level = Reading Value + Ant. Factor + Cable Loss.
4. The field strength of other emission frequencies were very low against the limit.



Spectrum Research & Testing Lab., Inc.
 No. 101-10, Ling 8,
 Shan-Tong Li, Chung-Li
 City, Taoyuan, Taiwan

TEST REPORT

Reference No.: A07062903
 Report No.: FCCA07062903
 FCC ID: Q7Z-BV300R1
 Page: 37 of 103
 Date: Jul. 27, 2007

Temperature:	23°C	Humidity:	65%RH
Frequency Range:	1 – 12.5 GHz	Measured Distance:	3m
Receiver Detector:	Q.P. or AV.	Tested Mode:	BV-300, CH39-TX
Tested By:	Jeff Yu	Tested Date:	Jul. 18, 2007

Antenna Polarization: Horizontal

Frequency (MHz)	Corret Factor (dB)	Antenna Factor (dB/m)	Reading (dBμV)		Emission (dBμV/m)		Limit (dBμV/m)		Margin (dB)	
			PK	AV	PK	AV	PK	AV	PK	AV
2441	-32.23	28.62	83.6	62.7	80.0	59.1	N/A	N/A	N/A	N/A
1854.568	-33.02	26.65	32.1	*	25.7	*	74.0	54.0	-48.3	*
2379.65	-32.24	27.96	35.2	*	30.9	*	74.0	54.0	-43.1	*
5486.362	-29.39	33.99	32.4	*	37.0	*	74.0	54.0	-37.0	*
4882	-30.26	33.71	30.5	*	33.9	*	74.0	54.0	-40.1	*
7228.972	-28.96	36.28	34.8	*	42.1	*	74.0	54.0	-31.9	*

Antenna Polarization: Vertical

Frequency (MHz)	Corret Factor (dB)	Antenna Factor (dB/m)	Reading (dBμV)		Emission (dBμV/m)		Limit (dBμV/m)		Margin (dB)	
			PK	AV	PK	AV	PK	AV	PK	AV
2441	-32.23	28.08	85.1	58.5	81.0	54.4	N/A	N/A	N/A	N/A
1854.568	-33.02	26.65	35.5	*	29.1	*	74.0	54.0	-44.9	*
2379.65	-32.24	27.96	34.7	*	30.4	*	74.0	54.0	-43.6	*
5486.362	-29.39	33.99	34.3	*	38.9	*	74.0	54.0	-35.1	*
4882	-30.26	33.71	32.2	*	35.6	*	74.0	54.0	-38.4	*
7228.972	-28.96	36.28	37.6	*	44.9	*	74.0	54.0	-29.1	*

NOTE :

1. Measurement uncertainty is +/-2dB.
2. "*": Measurement does not apply for this frequency.
3. Emission Level = Reading Value + Ant. Factor + Cable Loss.
4. The field strength of other emission frequencies were very low against the limit.



TEST REPORT

Temperature:	23°C	Humidity:	65%RH
Frequency Range:	1-12.5GHz	Measured Distance:	3m
Receiver Detector:	PK. or AV.	Tested Mode:	BV-300, CH39-Link
Tested By:	Jeff Yu	Tested Date:	Jul. 18, 2007

Antenna Polarization: Horizontal

Frequency (MHz)	Corret Factor (dB)	Antenna Factor (dB/m)	Reading (dBμV)		Emission (dBμV/m)		Limit (dBμV/m)		Margin (dB)	
			PK	AV	PK	AV	PK	AV	PK	AV
2441	-32.23	28.62	83.5	63.4	79.9	59.8	N/A	N/A	N/A	N/A
1854.568	-33.02	26.65	34.2	*	27.8	*	74.0	54.0	-46.2	*
2379.65	-32.24	27.96	32.9	*	28.6	*	74.0	54.0	-45.4	*
5486.362	-29.39	33.99	34.8	*	39.4	*	74.0	54.0	-34.6	*
4882	-30.26	33.71	32.8	*	36.2	*	74.0	54.0	-37.8	*
7228.972	-28.96	36.28	34.2	*	41.5	*	74.0	54.0	-32.5	*

Antenna Polarization: Vertical

Frequency (MHz)	Corret Factor (dB)	Antenna Factor (dB/m)	Reading (dBμV)		Emission (dBμV/m)		Limit (dBμV/m)		Margin (dB)	
			PK	AV	PK	AV	PK	AV	PK	AV
2441	-32.23	28.08	85.1	57.6	81.0	53.5	N/A	N/A	N/A	N/A
1854.568	-33.02	26.65	36.2	*	29.8	*	74.0	54.0	-44.2	*
2379.65	-32.24	27.96	33.7	*	29.4	*	74.0	54.0	-44.6	*
5486.362	-29.39	33.99	35.1	*	39.7	*	74.0	54.0	-34.3	*
4882	-30.26	33.71	34.5	*	37.9	*	74.0	54.0	-36.1	*
7228.972	-28.96	36.28	39.5	*	46.8	*	74.0	54.0	-27.2	*

NOTE :

1. Measurement uncertainty is +/-2dB.
2. "*": Measurement does not apply for this frequency.
3. Emission Level = Reading Value + Ant. Factor + Cable Loss.
4. The field strength of other emission frequencies were very low against the limit.



TEST REPORT

Temperature:	23°C	Humidity:	65%RH
Frequency Range:	1-12.5GHz	Measured Distance:	3m
Receiver Detector:	PK. or AV.	Tested Mode:	BV-300, CH78-TX
Tested By:	Jeff Yu	Tested Date:	Jul. 18, 2007

Antenna Polarization: Horizontal

Frequency (MHz)	Corret Factor (dB)	Antenna Factor (dB/m)	Reading (dBμV)		Emission (dBμV/m)		Limit (dBμV/m)		Margin (dB)	
			PK	AV	PK	AV	PK	AV	PK	AV
2480	-32.19	28.73	85.8	63.6	82.3	60.1	N/A	N/A	N/A	N/A
1795.046	-33.05	26.42	32.6	*	26.0	*	74.0	54.0	-48.0	*
2129.853	-32.33	27.46	34.2	*	29.3	*	74.0	54.0	-44.7	*
2928.125	-31.76	30.60	34.8	*	33.6	*	74.0	54.0	-40.4	*
4960	-30.26	33.77	35.2	*	38.7	*	74.0	54.0	-35.3	*
7946.17	-28.97	37.04	33.7	*	41.8	*	74.0	54.0	-32.2	*

Antenna Polarization: Vertical

Frequency (MHz)	Corret Factor (dB)	Antenna Factor (dB/m)	Reading (dBμV)		Emission (dBμV/m)		Limit (dBμV/m)		Margin (dB)	
			PK	AV	PK	AV	PK	AV	PK	AV
2480	-32.19	28.16	83.2	55.2	79.2	51.2	N/A	N/A	N/A	N/A
1795.046	-33.05	26.42	35.3	*	28.7	*	74.0	54.0	-45.3	*
2129.853	-32.33	27.46	36.5	*	31.6	*	74.0	54.0	-42.4	*
2928.125	-31.76	30.60	37.7	*	36.5	*	74.0	54.0	-37.5	*
4960	-30.26	33.77	36.3	*	39.8	*	74.0	54.0	-34.2	*
7946.17	-28.97	37.04	34.9	*	43.0	*	74.0	54.0	-31.0	*

NOTE :

1. Measurement uncertainty is +/-2dB.
2. "*": Measurement does not apply for this frequency.
3. Emission Level = Reading Value + Ant. Factor + Cable Loss.
4. The field strength of other emission frequencies were very low against the limit.



TEST REPORT

Temperature:	23°C	Humidity:	65%RH
Frequency Range:	1 – 12.5 GHz	Measured Distance:	3m
Receiver Detector:	Q.P. or AV.	Tested Mode:	BV-300, CH78-Link
Tested By:	Jeff Yu	Tested Date:	Jul. 18, 2007

Antenna Polarization: Horizontal

Frequency (MHz)	Corret Factor (dB)	Antenna Factor (dB/m)	Reading (dBμV)		Emission (dBμV/m)		Limit (dBμV/m)		Margin (dB)	
			PK	AV	PK	AV	PK	AV	PK	AV
2480	-32.19	28.73	85.3	62.1	81.8	58.6	N/A	N/A	N/A	N/A
1795.046	-33.05	26.42	33.6	*	27.0	*	74.0	54.0	-47.0	*
2129.853	-32.33	27.46	33.8	*	28.9	*	74.0	54.0	-45.1	*
2928.125	-31.76	30.60	34.1	*	32.9	*	74.0	54.0	-41.1	*
4960	-30.26	33.77	35.4	*	38.9	*	74.0	54.0	-35.1	*
7946.17	-28.97	37.04	33.2	*	41.3	*	74.0	54.0	-32.7	*

Antenna Polarization: Vertical

Frequency (MHz)	Corret Factor (dB)	Antenna Factor (dB/m)	Reading (dBμV)		Emission (dBμV/m)		Limit (dBμV/m)		Margin (dB)	
			PK	AV	PK	AV	PK	AV	PK	AV
2480	-32.19	28.16	86.1	56.5	82.1	52.5	N/A	N/A	N/A	N/A
1795.046	-33.05	26.42	35.7	*	29.1	*	74.0	54.0	-44.9	*
2129.853	-32.33	27.46	37.2	*	32.3	*	74.0	54.0	-41.7	*
2928.125	-31.76	30.60	35.9	*	34.7	*	74.0	54.0	-39.3	*
4960	-30.26	33.77	37.3	*	40.8	*	74.0	54.0	-33.2	*
7946.17	-28.97	37.04	35.8	*	43.9	*	74.0	54.0	-30.1	*

NOTE :

1. Measurement uncertainty is +/-2dB.
2. "*": Measurement does not apply for this frequency.
3. Emission Level = Reading Value + Ant. Factor + Cable Loss.
4. The field strength of other emission frequencies were very low against the limit.



TEST REPORT

Temperature:	23°C	Humidity:	65%RH
Frequency Range:	1 – 12.5 GHz	Measured Distance:	3m
Receiver Detector:	Q.P. or AV.	Tested Mode:	Dongle, CH0-TX
Tested By:	Jeff Yu	Tested Date:	Jul. 18, 2007

Antenna Polarization: Horizontal

Frequency (MHz)	Corret Factor (dB)	Antenna Factor (dB/m)	Reading (dBμV)		Emission (dBμV/m)		Limit (dBμV/m)		Margin (dB)	
			PK	AV	PK	AV	PK	AV	PK	AV
2402	-32.16	28.54	82.6	60.8	79.0	57.2	N/A	N/A	N/A	N/A
2466.93	-32.21	28.13	30.5	*	26.4	*	74.0	54.0	-47.6	*
4925.05	-30.24	33.74	27.6	*	31.1	*	74.0	54.0	-42.9	*
5488.274	-29.39	34.00	33.1	*	37.7	*	74.0	54.0	-36.3	*
4804	-30.47	33.64	28.4	*	31.6	*	74.0	54.0	-42.4	*
7998.52	-28.91	37.10	34.2	*	42.4	*	74.0	54.0	-31.6	*

Antenna Polarization: Vertical

Frequency (MHz)	Corret Factor (dB)	Antenna Factor (dB/m)	Reading (dBμV)		Emission (dBμV/m)		Limit (dBμV/m)		Margin (dB)	
			PK	AV	PK	AV	PK	AV	PK	AV
2402	-32.16	28.00	85.3	63.4	81.1	59.2	N/A	N/A	N/A	N/A
2466.93	-32.21	28.13	33.2	*	29.1	*	74.0	54.0	-44.9	*
4925.05	-30.24	33.74	31.7	*	35.2	*	74.0	54.0	-38.8	*
5488.274	-29.39	34.00	36.1	*	40.7	*	74.0	54.0	-33.3	*
4804	-30.47	33.64	31.2	*	34.4	*	74.0	54.0	-39.6	*
7998.52	-28.91	37.10	38.6	*	46.8	*	74.0	54.0	-27.2	*

NOTE :

1. Measurement uncertainty is +/-2dB.
2. "*": Measurement does not apply for this frequency.
3. Emission Level = Reading Value + Ant. Factor + Cable Loss.
4. The field strength of other emission frequencies were very low against the limit.



Spectrum Research & Testing Lab., Inc.
No. 101-10, Ling 8,
Shan-Tong Li, Chung-Li
City, Taoyuan, Taiwan

TEST REPORT

Reference No.: A07062903
Report No.: FCCA07062903
FCC ID: Q7Z-BV300R1
Page: 42 of 103
Date: Jul. 27, 2007

Temperature:	23°C	Humidity:	65%RH
Frequency Range:	1-12.5GHz	Measured Distance:	3m
Receiver Detector:	PK. or AV.	Tested Mode:	Dongle, CH0-Link
Tested By:	Jeff Yu	Tested Date:	Jul. 18, 2007

Antenna Polarization: Horizontal

Frequency (MHz)	Corret Factor (dB)	Antenna Factor (dB/m)	Reading (dB μ V)		Emission (dB μ V/m)		Limit (dB μ V/m)		Margin (dB)	
			PK	AV	PK	AV	PK	AV	PK	AV
2402	-32.16	28.54	84.3	61.3	80.7	57.7	N/A	N/A	N/A	N/A
2466.93	-32.21	28.13	35.1	*	31.0	*	74.0	54.0	-43.0	*
4925.05	-30.24	33.74	32.4	*	35.9	*	74.0	54.0	-38.1	*
5488.274	-29.39	34.00	30.4	*	35.0	*	74.0	54.0	-39.0	*
4804	-30.47	33.64	31.8	*	35.0	*	74.0	54.0	-39.0	*
7998.52	-28.91	37.10	33.6	*	41.8	*	74.0	54.0	-32.2	*

Antenna Polarization: Vertical

Frequency (MHz)	Corret Factor (dB)	Antenna Factor (dB/m)	Reading (dB μ V)		Emission (dB μ V/m)		Limit (dB μ V/m)		Margin (dB)	
			PK	AV	PK	AV	PK	AV	PK	AV
2402	-32.16	28.00	86.7	62.8	82.5	58.6	N/A	N/A	N/A	N/A
2466.93	-32.21	28.13	36.5	*	32.4	*	74.0	54.0	-41.6	*
4925.05	-30.24	33.74	35.2	*	38.7	*	74.0	54.0	-35.3	*
5488.274	-29.39	34.00	34.3	*	38.9	*	74.0	54.0	-35.1	*
4804	-30.47	33.64	33.6	*	36.8	*	74.0	54.0	-37.2	*
7998.52	-28.91	37.10	40.5	*	48.7	*	74.0	54.0	-25.3	*

NOTE :

1. Measurement uncertainty is +/-2dB.
2. "*": Measurement does not apply for this frequency.
3. Emission Level = Reading Value + Ant. Factor + Cable Loss.
4. The field strength of other emission frequencies were very low against the limit.



TEST REPORT

Temperature:	23°C	Humidity:	65%RH
Frequency Range:	1-12.5GHz	Measured Distance:	3m
Receiver Detector:	PK. or AV.	Tested Mode:	Dongle, CH0-RX
Tested By:	Jeff Yu	Tested Date:	Jul. 18, 2007

Antenna Polarization: Horizontal

Frequency (MHz)	Corret Factor (dB)	Antenna Factor (dB/m)	Reading (dBμV)		Emission (dBμV/m)		Limit (dBμV/m)		Margin (dB)	
			PK	AV	PK	AV	PK	AV	PK	AV
2402	-32.16	28.54	80.3	60.3	76.7	56.7	N/A	N/A	N/A	N/A
2466.93	-32.21	28.13	26.3	*	22.2	*	74.0	54.0	-51.8	*
4925.05	-30.24	33.74	25.4	*	28.9	*	74.0	54.0	-45.1	*
5488.274	-29.39	34.00	27.1	*	31.7	*	74.0	54.0	-42.3	*
4804	-30.47	33.64	22.6	*	25.8	*	74.0	54.0	-48.2	*
7998.52	-28.91	37.10	25.3	*	33.5	*	74.0	54.0	-40.5	*

Antenna Polarization: Vertical

Frequency (MHz)	Corret Factor (dB)	Antenna Factor (dB/m)	Reading (dBμV)		Emission (dBμV/m)		Limit (dBμV/m)		Margin (dB)	
			PK	AV	PK	AV	PK	AV	PK	AV
2402	-32.16	28.00	84.5	62.9	80.3	58.7	N/A	N/A	N/A	N/A
2466.93	-32.21	28.13	28.3	*	24.2	*	74.0	54.0	-49.8	*
4925.05	-30.24	33.74	27.1	*	30.6	*	74.0	54.0	-43.4	*
5488.274	-29.39	34.00	27.9	*	32.5	*	74.0	54.0	-41.5	*
4804	-30.47	33.64	24.5	*	27.7	*	74.0	54.0	-46.3	*
7998.52	-28.91	37.10	28.7	*	36.9	*	74.0	54.0	-37.1	*

NOTE :

1. Measurement uncertainty is +/-2dB.
2. "*": Measurement does not apply for this frequency.
3. Emission Level = Reading Value + Ant. Factor + Cable Loss.
4. The field strength of other emission frequencies were very low against the limit.



TEST REPORT

Temperature:	23°C	Humidity:	65%RH
Frequency Range:	1 – 12.5 GHz	Measured Distance:	3m
Receiver Detector:	Q.P. or AV.	Tested Mode:	Dongle, CH39-TX
Tested By:	Jeff Yu	Tested Date:	Jul. 18, 2007

Antenna Polarization: Horizontal

Frequency (MHz)	Corret Factor (dB)	Antenna Factor (dB/m)	Reading (dBμV)		Emission (dBμV/m)		Limit (dBμV/m)		Margin (dB)	
			PK	AV	PK	AV	PK	AV	PK	AV
2441	-32.23	28.62	85.1	63.7	81.5	60.1	N/A	N/A	N/A	N/A
1362.176	-32.53	25.00	31.6	*	24.1	*	74.0	54.0	-49.9	*
2129.495	-32.33	27.46	33.7	*	28.8	*	74.0	54.0	-45.2	*
5596.391	-29.49	34.02	35.3	*	39.8	*	74.0	54.0	-34.2	*
4882	-30.26	33.71	30.1	*	33.5	*	74.0	54.0	-40.5	*
7328.33	-29.03	36.36	34.6	*	41.9	*	74.0	54.0	-32.1	*

Antenna Polarization: Vertical

Frequency (MHz)	Corret Factor (dB)	Antenna Factor (dB/m)	Reading (dBμV)		Emission (dBμV/m)		Limit (dBμV/m)		Margin (dB)	
			PK	AV	PK	AV	PK	AV	PK	AV
2441	-32.23	28.08	87.2	58.3	83.1	54.2	N/A	N/A	N/A	N/A
1362.176	-32.53	25.00	34.5	*	27.0	*	74.0	54.0	-47.0	*
2129.495	-32.33	27.46	35.9	*	31.0	*	74.0	54.0	-43.0	*
5596.391	-29.49	34.02	37.3	*	41.8	*	74.0	54.0	-32.2	*
4882	-30.26	33.71	33.8	*	37.2	*	74.0	54.0	-36.8	*
7328.33	-29.03	36.36	38.6	*	45.9	*	74.0	54.0	-28.1	*

NOTE :

1. Measurement uncertainty is +/-2dB.
2. "*": Measurement does not apply for this frequency.
3. Emission Level = Reading Value + Ant. Factor + Cable Loss.
4. The field strength of other emission frequencies were very low against the limit.



Spectrum Research & Testing Lab., Inc.
No. 101-10, Ling 8,
Shan-Tong Li, Chung-Li
City, Taoyuan, Taiwan

TEST REPORT

Reference No.: A07062903
Report No.: FCCA07062903
FCC ID: Q7Z-BV300R1
Page: 45 of 103
Date: Jul. 27, 2007

Temperature:	23°C	Humidity:	65%RH
Frequency Range:	1-12.5GHz	Measured Distance:	3m
Receiver Detector:	PK. or AV.	Tested Mode:	Dongle, CH39-Link
Tested By:	Jeff Yu	Tested Date:	Jul. 18, 2007

Antenna Polarization: Horizontal

Frequency (MHz)	Corret Factor (dB)	Antenna Factor (dB/m)	Reading (dBμV)		Emission (dBμV/m)		Limit (dBμV/m)		Margin (dB)	
			PK	AV	PK	AV	PK	AV	PK	AV
2441	-32.23	28.62	82.1	62.9	78.5	59.3	N/A	N/A	N/A	N/A
1362.176	-32.53	25.00	33.6	*	26.1	*	74.0	54.0	-47.9	*
2129.495	-32.33	27.46	35.4	*	30.5	*	74.0	54.0	-43.5	*
5596.391	-29.49	34.02	34.3	*	38.8	*	74.0	54.0	-35.2	*
4882	-30.26	33.71	33.2	*	36.6	*	74.0	54.0	-37.4	*
7328.33	-29.03	36.36	34.9	*	42.2	*	74.0	54.0	-31.8	*

Antenna Polarization: Vertical

Frequency (MHz)	Corret Factor (dB)	Antenna Factor (dB/m)	Reading (dBμV)		Emission (dBμV/m)		Limit (dBμV/m)		Margin (dB)	
			PK	AV	PK	AV	PK	AV	PK	AV
2441	-32.23	28.08	85.7	60.4	81.6	56.3	N/A	N/A	N/A	N/A
1362.176	-32.53	25.00	36.4	*	28.9	*	74.0	54.0	-45.1	*
2129.495	-32.33	27.46	37.8	*	32.9	*	74.0	54.0	-41.1	*
5596.391	-29.49	34.02	35.6	*	40.1	*	74.0	54.0	-33.9	*
4882	-30.26	33.71	36.3	*	39.7	*	74.0	54.0	-34.3	*
7328.33	-29.03	36.36	38.1	*	45.4	*	74.0	54.0	-28.6	*

NOTE :

1. Measurement uncertainty is +/-2dB.
2. "*": Measurement does not apply for this frequency.
3. Emission Level = Reading Value + Ant. Factor + Cable Loss.
4. The field strength of other emission frequencies were very low against the limit.



Temperature:	23°C	Humidity:	65%RH
Frequency Range:	1-12.5GHz	Measured Distance:	3m
Receiver Detector:	PK. or AV.	Tested Mode:	Dongle, CH78-TX
Tested By:	Jeff Yu	Tested Date:	Jul. 18, 2007

Antenna Polarization: Horizontal

Frequency (MHz)	Corret Factor (dB)	Antenna Factor (dB/m)	Reading (dBμV)		Emission (dBμV/m)		Limit (dBμV/m)		Margin (dB)	
			PK	AV	PK	AV	PK	AV	PK	AV
2480	-32.19	28.73	86.7	62.3	83.2	58.8	N/A	N/A	N/A	N/A
1710.325	-32.95	26.10	33.6	*	26.7	*	74.0	54.0	-47.3	*
2753.934	-31.89	29.62	34.2	*	31.9	*	74.0	54.0	-42.1	*
5490.13	-29.38	34.00	35.6	*	40.2	*	74.0	54.0	-33.8	*
4960	-30.26	33.77	35.8	*	39.3	*	74.0	54.0	-34.7	*
7362.03	-28.97	36.39	34.5	*	41.9	*	74.0	54.0	-32.1	*

Antenna Polarization: Vertical

Frequency (MHz)	Corret Factor (dB)	Antenna Factor (dB/m)	Reading (dBμV)		Emission (dBμV/m)		Limit (dBμV/m)		Margin (dB)	
			PK	AV	PK	AV	PK	AV	PK	AV
2480	-32.19	28.16	88.9	60.5	84.9	56.5	N/A	N/A	N/A	N/A
1710.325	-32.95	26.10	34.5	*	27.6	*	74.0	54.0	-46.4	*
2753.934	-31.89	29.62	36.3	*	34.0	*	74.0	54.0	-40.0	*
5490.13	-29.38	34.00	36.8	*	41.4	*	74.0	54.0	-32.6	*
4960	-30.26	33.77	37.3	*	40.8	*	74.0	54.0	-33.2	*
7362.03	-28.97	36.39	35.5	*	42.9	*	74.0	54.0	-31.1	*

NOTE :

1. Measurement uncertainty is +/-2dB.
2. "*": Measurement does not apply for this frequency.
3. Emission Level = Reading Value + Ant. Factor + Cable Loss.
4. The field strength of other emission frequencies were very low against the limit.



TEST REPORT

Temperature:	23°C	Humidity:	65%RH
Frequency Range:	1 – 12.5 GHz	Measured Distance:	3m
Receiver Detector:	Q.P. or AV.	Tested Mode:	Dongle, CH78-Link
Tested By:	Jeff Yu	Tested Date:	Jul. 18, 2007

Antenna Polarization: Horizontal

Frequency (MHz)	Corret Factor (dB)	Antenna Factor (dB/m)	Reading (dBμV)		Emission (dBμV/m)		Limit (dBμV/m)		Margin (dB)	
			PK	AV	PK	AV	PK	AV	PK	AV
2480	-32.19	28.73	85.3	63.2	81.8	59.7	N/A	N/A	N/A	N/A
1710.325	-32.95	26.10	33.4	*	26.5	*	74.0	54.0	-47.5	*
2753.934	-31.89	29.62	34.8	*	32.5	*	74.0	54.0	-41.5	*
5490.13	-29.38	34.00	35.6	*	40.2	*	74.0	54.0	-33.8	*
4960	-30.26	33.77	34.5	*	38.0	*	74.0	54.0	-36.0	*
7362.03	-28.97	36.39	35.9	*	43.3	*	74.0	54.0	-30.7	*

Antenna Polarization: Vertical

Frequency (MHz)	Corret Factor (dB)	Antenna Factor (dB/m)	Reading (dBμV)		Emission (dBμV/m)		Limit (dBμV/m)		Margin (dB)	
			PK	AV	PK	AV	PK	AV	PK	AV
2480	-32.19	28.16	87.9	53.3	83.9	49.3	N/A	N/A	N/A	N/A
1710.325	-32.95	26.10	35.8	*	28.9	*	74.0	54.0	-45.1	*
2753.934	-31.89	29.62	36.7	*	34.4	*	74.0	54.0	-39.6	*
5490.13	-29.38	34.00	37.1	*	41.7	*	74.0	54.0	-32.3	*
4960	-30.26	33.77	36.2	*	39.7	*	74.0	54.0	-34.3	*
7362.03	-28.97	36.39	38.1	*	45.5	*	74.0	54.0	-28.5	*

NOTE :

1. Measurement uncertainty is +/-2dB.
2. "*": Measurement does not apply for this frequency.
3. Emission Level = Reading Value + Ant. Factor + Cable Loss.
4. The field strength of other emission frequencies were very low against the limit.



4.3 CHANNEL SEPARATION TEST

4.3.1 LIMIT

FCC Part15, Subpart C Section 15.247(a)(1). Frequency hopping systems shall have hopping channel carrier frequencies separated by a minimum of 25 kHz or the 20 dB bandwidth of the hopping channel, whichever is greater.

FREQUENCY RANGE (MHz)	Limit(kHz)
902-928	>25kHz
2400-2483.5	>25kHz
5725-5850	>25kHz

4.3.2 TEST EQUIPMENT

The following test equipment was used during the radiated emission test :

EQUIPMENT/ FACILITIES	SPECIFICATIONS	MANUFACTURER	MODEL#/ SERIAL#	DUE DATE OF CAL. & CAL. CENTER
SPECTRUM	9kHz-7GHz	ROHDE & SCHWARZ	FSP7/ 839511/010	APR. 2008 R&S

NOTE: The calibration interval of the above test equipment is one year and the calibrations are traceable to NML/ROC and NIST/USA.

4.3.3 TEST SET-UP

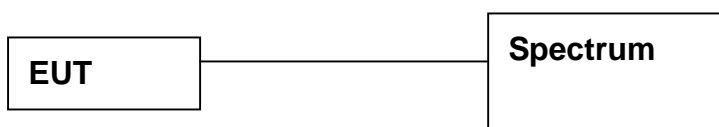

The EUT was connected to a spectrum through a 50Ω RF cable.

4.3.4 TEST PROCEDURE

The EUT was operating in hopping mode or could be controlled its channel. Printed out the test result from the spectrum by hard copy function.

4.3.5 EUT OPERATING CONDITION

Same as section 4.1.5 of this report.



Spectrum Research & Testing Lab., Inc.
No. 101-10, Ling 8,
Shan-Tong Li, Chung-Li
City, Taoyuan, Taiwan

TEST REPORT

Reference No.: A07062903
Report No.: FCCA07062903
FCC ID: Q7Z-BV300R1
Page: 49 of 103
Date: Jul. 27, 2007

4.3.6 TEST RESULT

Temperature:	<u>22°C</u>	Humidity:	<u>56%RH</u>
Spectrum Detector:	<u>PK</u>	Tested by:	<u>Jeff Yu</u>
Tested Mode:	<u>BV-300</u>	Tested Date:	<u>Jul. 12, 2007</u>
Test Result:	<u>PASS</u>		

CHANNEL FREQUENCY (MHz)	SEPARATION READ VALUE (kHz)	SEPARATION LIMIT (kHz)
2402-2403	1004.000	>25kHz
2440-2441	996.000	>25kHz
2479-2480	992.000	>25kHz



Spectrum Research & Testing Lab., Inc.
 No. 101-10, Ling 8,
 Shan-Tong Li, Chung-Li
 City, Taoyuan, Taiwan

TEST REPORT

Reference No.: A07062903
 Report No.: FCCA07062903
 FCC ID: Q7Z-BV300R1
 Page: 50 of 103
 Date: Jul. 27, 2007

2402-2403:

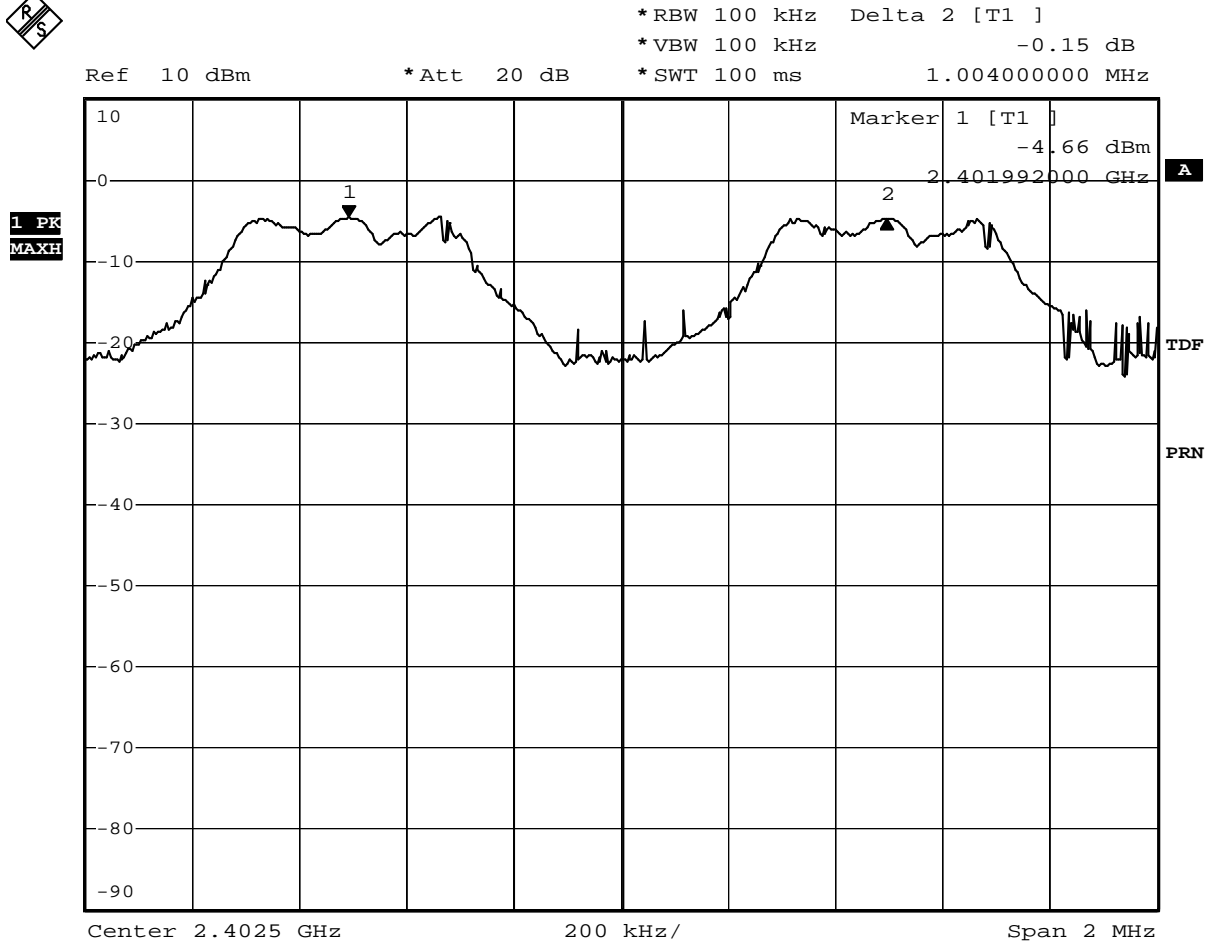

Date: 19.JUL.2007 10:28:22



Spectrum Research & Testing Lab., Inc.
 No. 101-10, Ling 8,
 Shan-Tong Li, Chung-Li
 City, Taoyuan, Taiwan

TEST REPORT

Reference No.: A07062903
 Report No.: FCCA07062903
 FCC ID: Q7Z-BV300R1
 Page: 51 of 103
 Date: Jul. 27, 2007

2440-2441:



*RBW 100 kHz Delta 2 [T1]
 *VBW 100 kHz -0.04 dB
 *SWT 100 ms 996.000000000 kHz

Ref 10 dBm

*Att 20 dB

1 PK
 MAXH

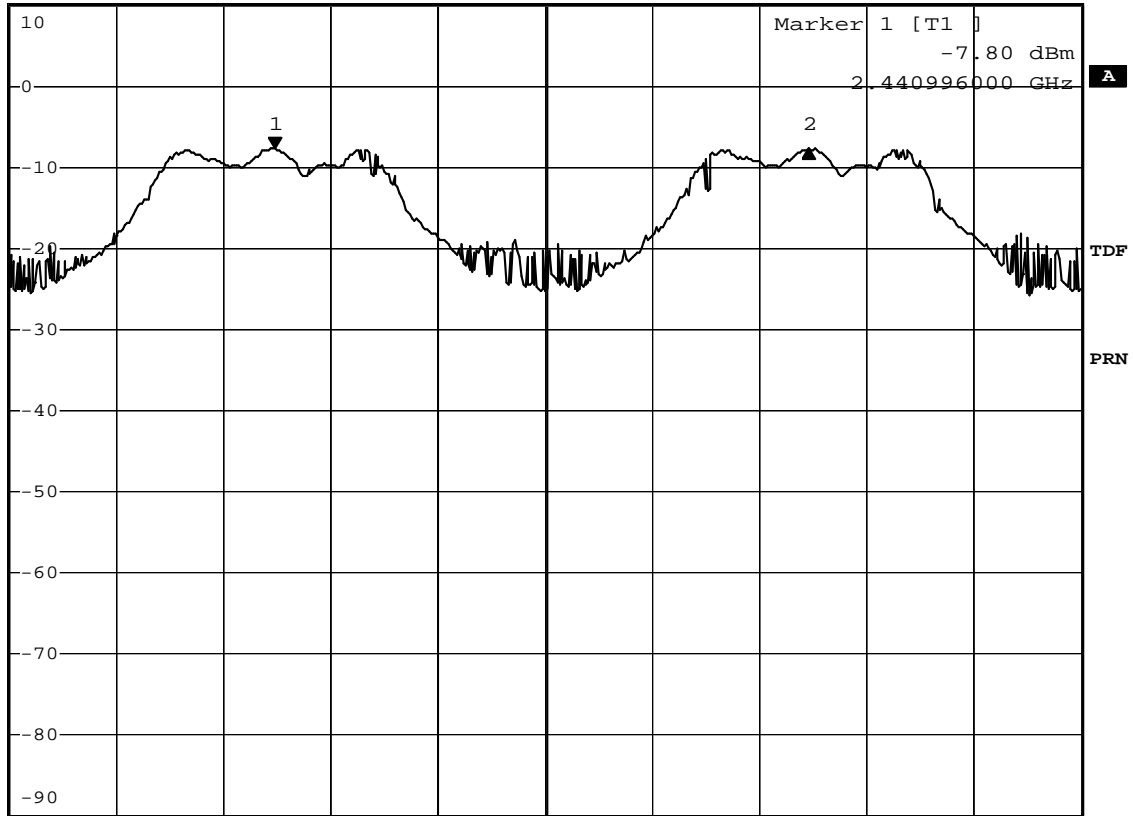

Center 2.4415 GHz

200 kHz/

Span 2 MHz

Date: 19.JUL.2007 10:39:27



Spectrum Research & Testing Lab., Inc.
 No. 101-10, Ling 8,
 Shan-Tong Li, Chung-Li
 City, Taoyuan, Taiwan

TEST REPORT

Reference No.: A07062903
 Report No.: FCCA07062903
 FCC ID: Q7Z-BV300R1
 Page: 52 of 103
 Date: Jul. 27, 2007

2479-2480:



*RBW 100 kHz Delta 2 [T1]
 *VBW 100 kHz -0.11 dB
 *SWT 100 ms 992.00000000 kHz

Ref 10 dBm

*Att 20 dB

*SWT 100 ms

992.00000000 kHz

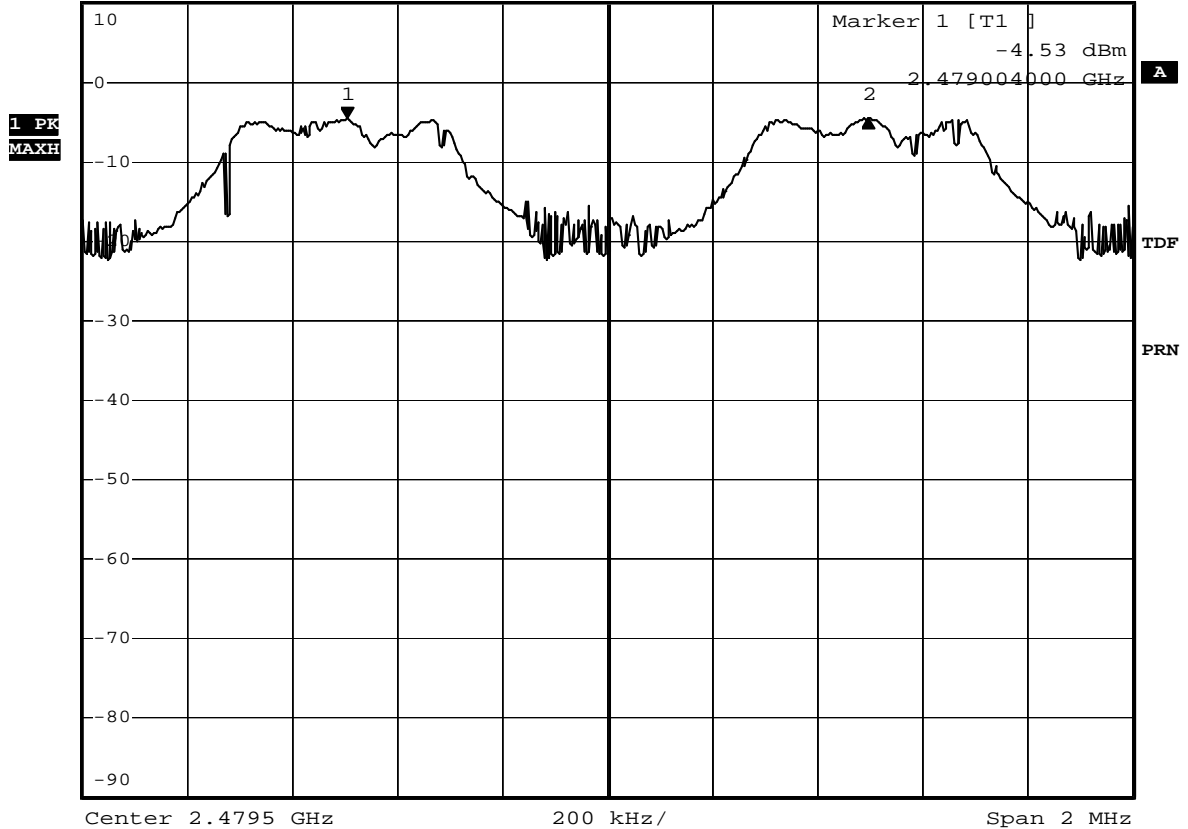

Date: 19.JUL.2007 10:55:38



Spectrum Research & Testing Lab., Inc.
No. 101-10, Ling 8,
Shan-Tong Li, Chung-Li
City, Taoyuan, Taiwan

TEST REPORT

Reference No.: A07062903
Report No.: FCCA07062903
FCC ID: Q7Z-BV300R1
Page: 53 of 103
Date: Jul. 27, 2007

Temperature:	<u>22°C</u>	Humidity:	<u>56%RH</u>
Spectrum Detector:	<u>PK</u>	Tested by:	<u>Jeff Yu</u>
Tested Mode:	<u>Dongle</u>	Tested Date:	<u>Jul. 12, 2007</u>
Test Result:	<u>PASS</u>		

CHANNEL FREQUENCY (MHz)	SEPARATION READ VALUE (kHz)	SEPARATION LIMIT (kHz)
2402-2403	996.000	>25kHz
2440-2441	1004.000	>25kHz
2479-2480	1008.000	>25kHz



Spectrum Research & Testing Lab., Inc.
 No. 101-10, Ling 8,
 Shan-Tong Li, Chung-Li
 City, Taoyuan, Taiwan

TEST REPORT

Reference No.: A07062903
 Report No.: FCCA07062903
 FCC ID: Q7Z-BV300R1
 Page: 54 of 103
 Date: Jul. 27, 2007

2402-2403:

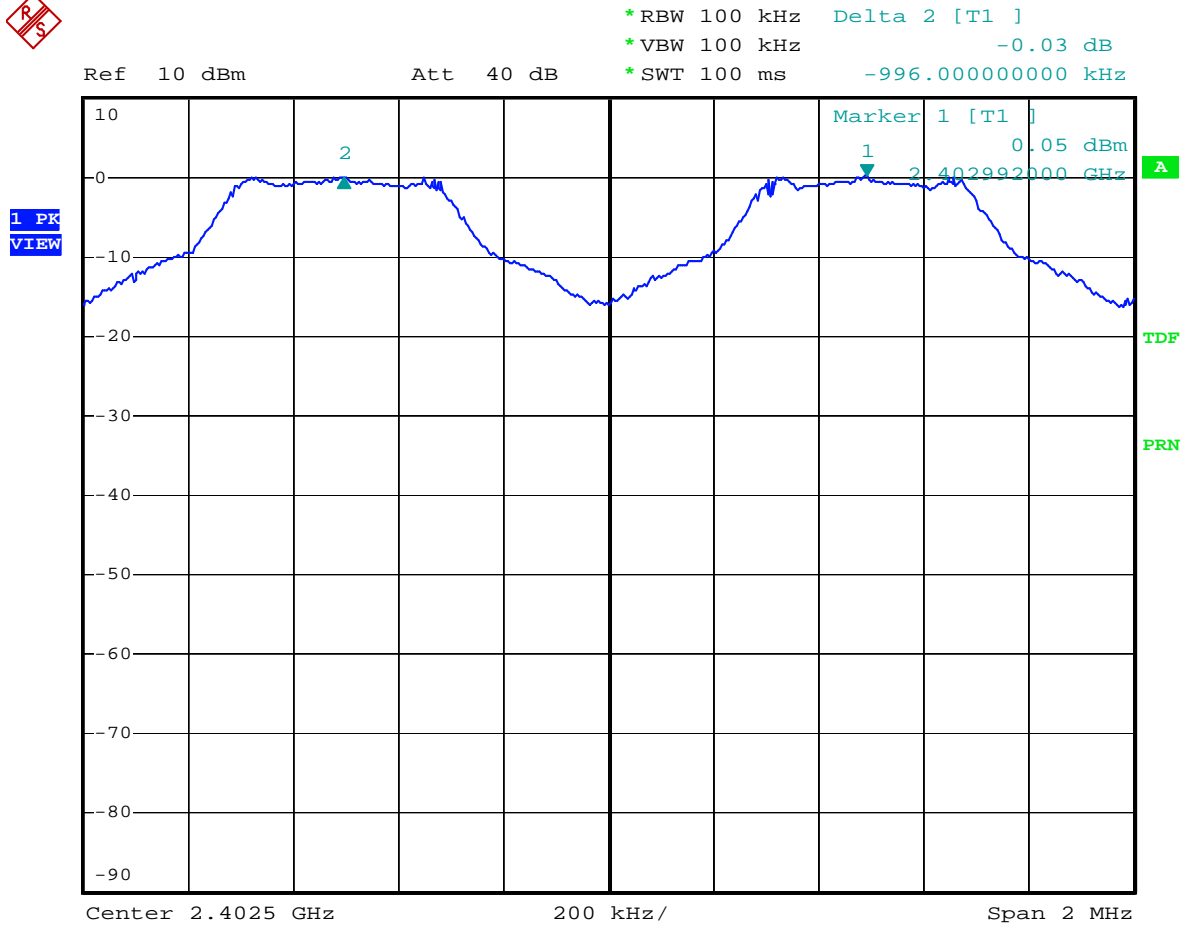

Date: 18.JUL.2007 09:58:24



Spectrum Research & Testing Lab., Inc.
No. 101-10, Ling 8,
Shan-Tong Li, Chung-Li
City, Taoyuan, Taiwan

TEST REPORT

Reference No.: A07062903
Report No.: FCCA07062903
FCC ID: Q7Z-BV300R1
Page:55 of 103
Date: Jul. 27, 2007

2440-2441:

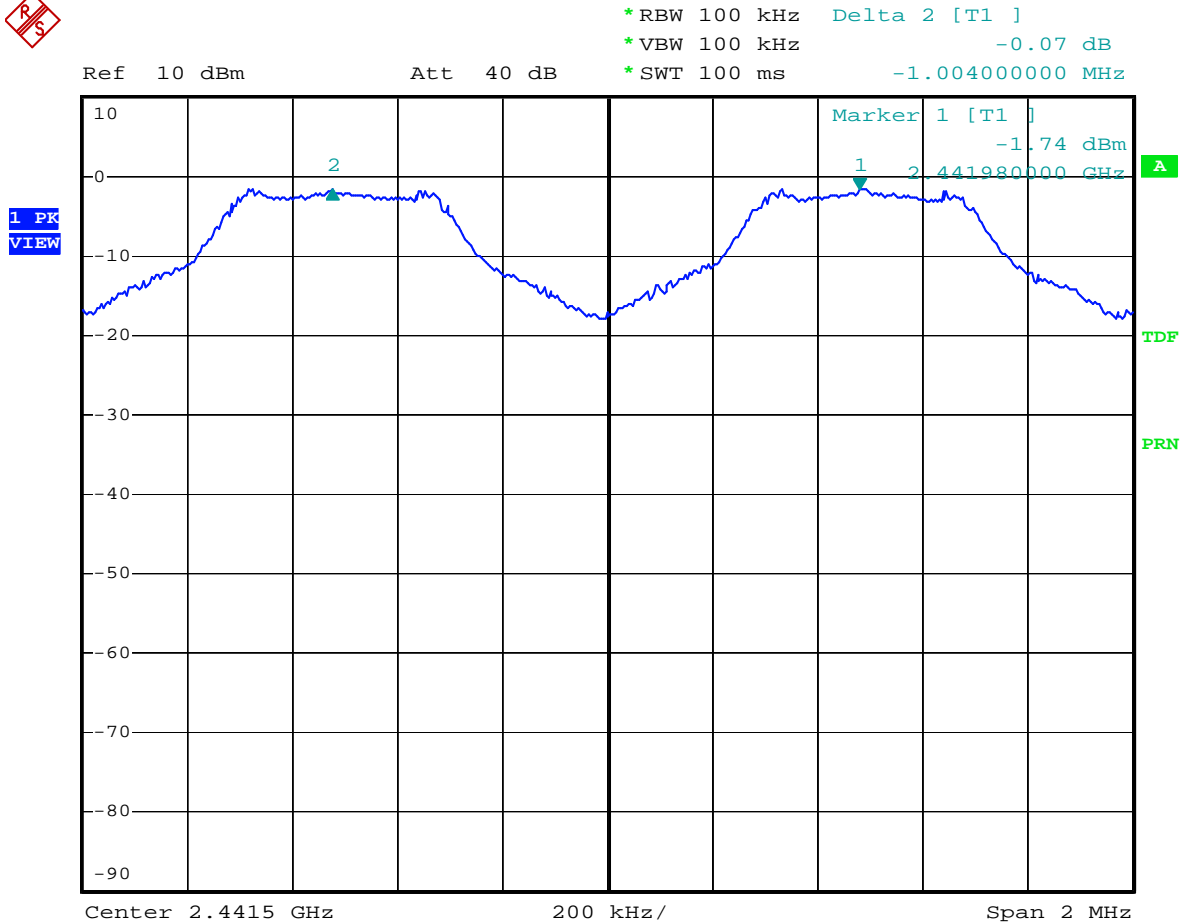

Date: 18.JUL.2007 10:03:51



Spectrum Research & Testing Lab., Inc.
 No. 101-10, Ling 8,
 Shan-Tong Li, Chung-Li
 City, Taoyuan, Taiwan

TEST REPORT

Reference No.: A07062903
 Report No.: FCCA07062903
 FCC ID: Q7Z-BV300R1
 Page: 56 of 103
 Date: Jul. 27, 2007

2479-2480:



Ref 10 dBm Att 40 dB *RBW 100 kHz Delta 2 [T1]
 *VBW 100 kHz -0.15 dB
 *SWT 100 ms 1.008000000 MHz

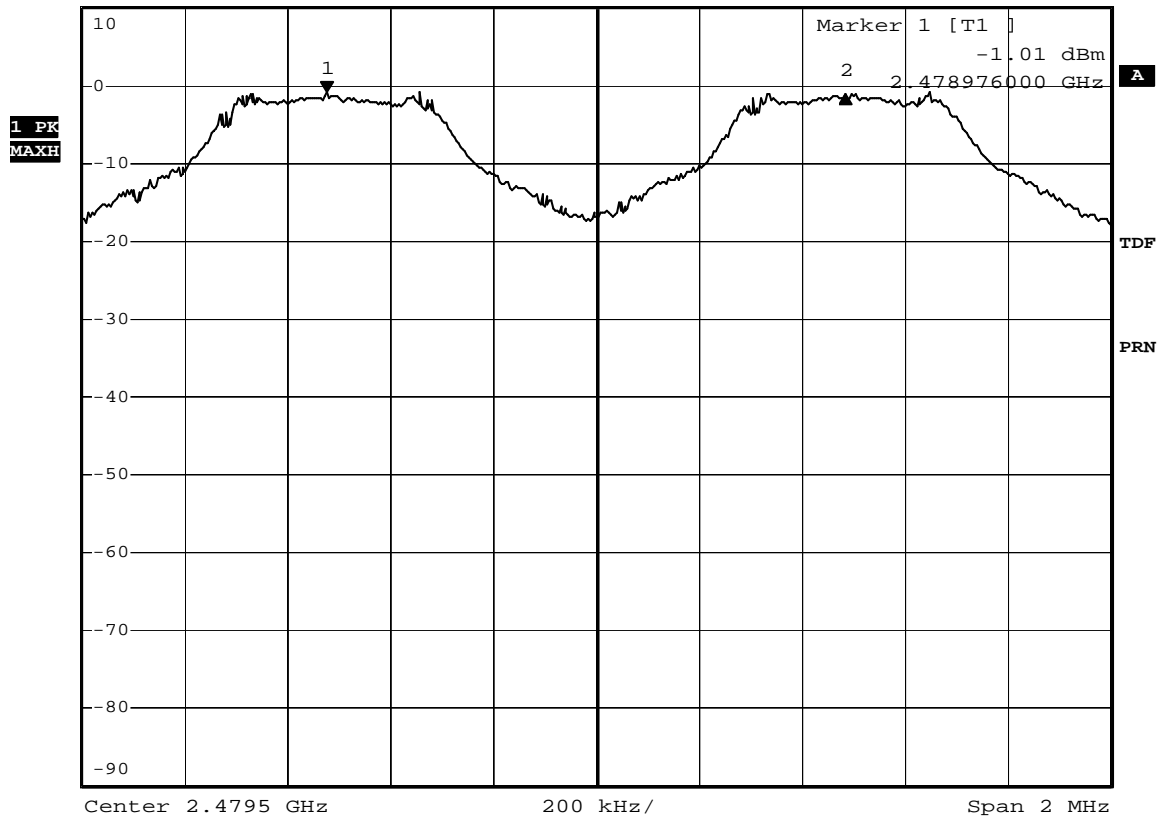

Date: 18.JUL.2007 10:58:16



4.4 QUANTITY OF HOPPING CHANNEL TEST

4.4.1 LIMIT

FCC Part15, Subpart C Section 15.247.

FREQUENCY RANGE (MHz)	Limit (Quantity of Hopping Channel)			
	20dB bandwidth <250kHz	20dB bandwidth >250kHz	20dB bandwidth <1MHz	20dB bandwidth >1MHz
902-928	50	25	N/A	N/A
2400-2483.5	N/A	N/A	75	15
5725-5850	N/A	N/A	75	N/A

4.4.2 TEST EQUIPMENT

The following test equipment was used during the test:

EQUIPMENT/FACILITIES	SPECIFICATIONS	MANUFACTURER	MODEL#/SERIAL#	DUE DATE OF CAL. & CAL. CENTER
SPECTRUM	9kHz-7GHz	ROHDE & SCHWARZ	FSP7/ 839511/010	APR. 2008 R&S

NOTE: The calibration interval of the above test equipment is one year and the calibrations are traceable to NML/ROC and NIST/USA.

4.4.3 TEST SET-UP

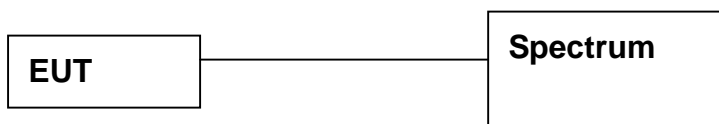

The EUT was connected to a spectrum through a 50Ω RF cable.

4.4.4 TEST PROCEDURE

The EUT was operating in hopping mode or could be controlled its channel. Printed out the test result from the spectrum by hard copy function.

4.4.5 EUT OPERATING CONDITION

Same as section 4.1.5 of this report.



Spectrum Research & Testing Lab., Inc.
 No. 101-10, Ling 8,
 Shan-Tong Li, Chung-Li
 City, Taoyuan, Taiwan

TEST REPORT

Reference No.: A07062903
 Report No.: FCCA07062903
 FCC ID: Q7Z-BV300R1
 Page: 58 of 103
 Date: Jul. 27, 2007

4.4.6 TEST RESULT

Temperature:	<u>27°C</u>	Humidity:	<u>59%RH</u>
Spectrum Detector:	<u>PK</u>	Tested by:	<u>Jeff Yu</u>
Test Mode:	<u>BV-300</u>	Tested Date:	<u>Jul. 11, 2007</u>
Test Result:	<u>PASS</u>		

HOPPING CHANNEL FREQUENCY RANGE	QUANTITY OF HOPPING CHANNEL READ VALUE	QUANTITY OF HOPPING CHANNEL LIMIT
2402~2480	79	75

CH0-CH78

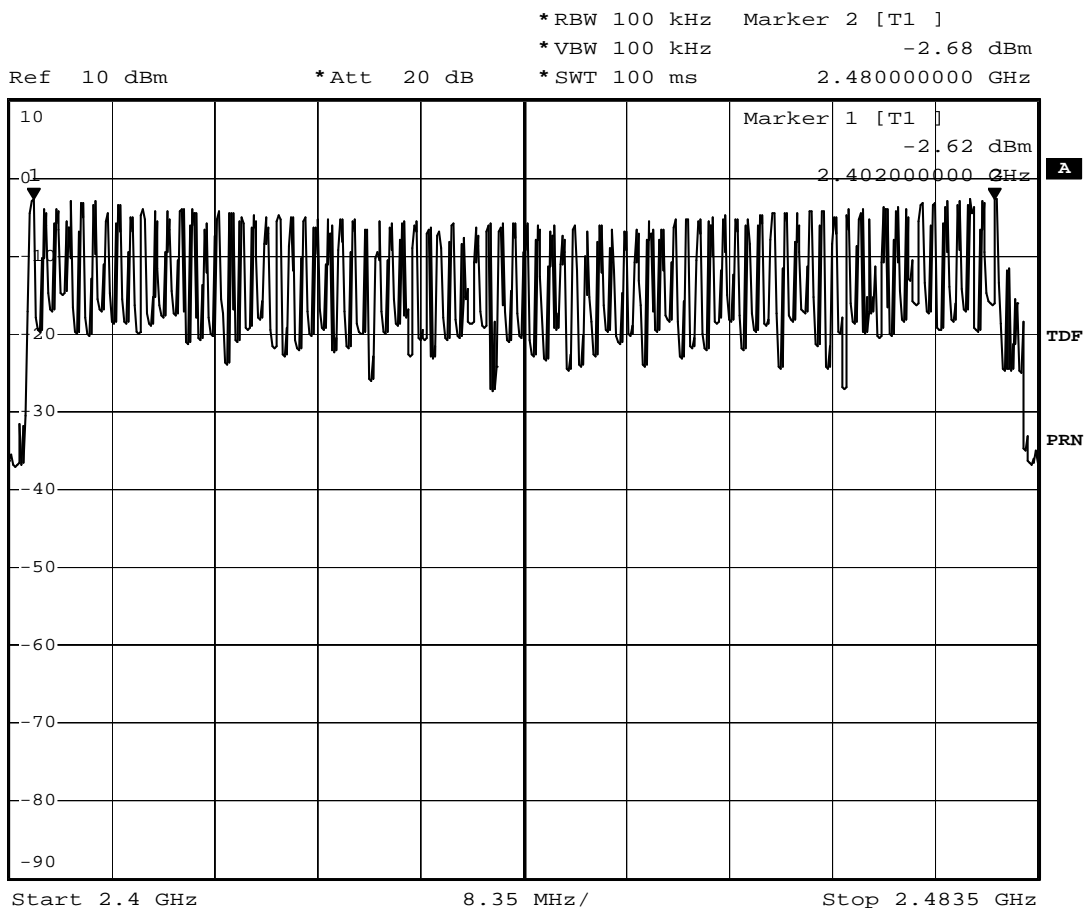

Date: 19.JUL.2007 11:43:33



Spectrum Research & Testing Lab., Inc.
 No. 101-10, Ling 8,
 Shan-Tong Li, Chung-Li
 City, Taoyuan, Taiwan

TEST REPORT

Reference No.: A07062903
 Report No.: FCCA07062903
 FCC ID: Q7Z-BV300R1
 Page: 59 of 103
 Date: Jul. 27, 2007

Temperature:	<u>27°C</u>	Humidity:	<u>59%RH</u>
Spectrum Detector:	<u>PK</u>	Tested by:	<u>Jeff Yu</u>
Test Mode:	<u>Dongle</u>	Tested Date:	<u>Jul. 11, 2007</u>
Test Result:	<u>PASS</u>		

HOPPING CHANNEL FREQUENCY RANGE	QUANTITY OF HOPPING CHANNEL READ VALUE	QUANTITY OF HOPPING CHANNEL LIMIT
2402~2480	79	75

CH0-CH78

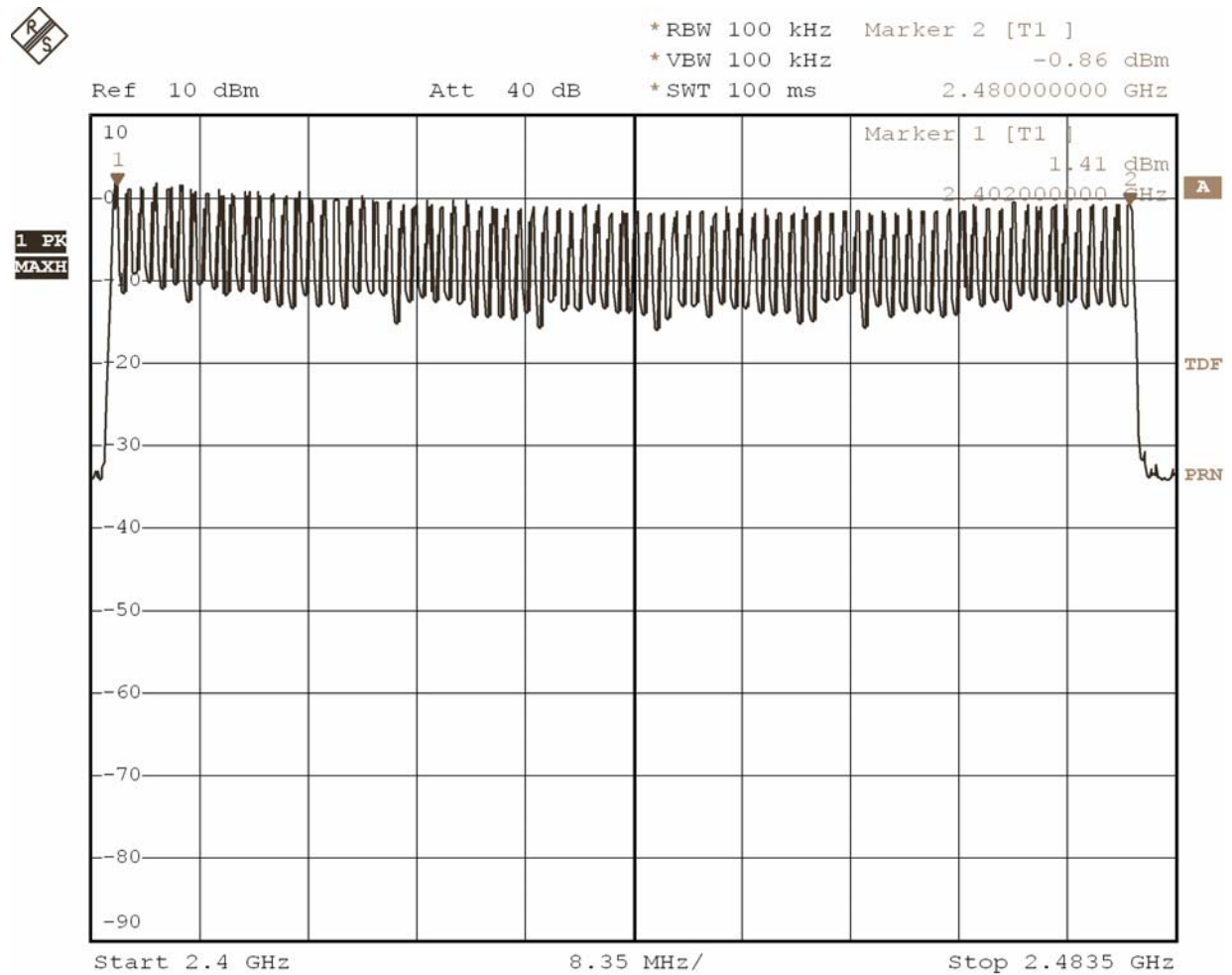

Date: 17.JUL.2007 15:20:21



Spectrum Research & Testing Lab., Inc.
 No. 101-10, Ling 8,
 Shan-Tong Li, Chung-Li
 City, Taoyuan, Taiwan

TEST REPORT

Reference No.: A07062903
 Report No.: FCCA07062903
 FCC ID: Q7Z-BV300R1
 Page:60 of 103
 Date: Jul. 27, 2007

4.5 AVERAGE TIME OF OCCUPANCY TEST(Dwell Time)

4.5.1 LIMIT

FCC Part15, Subpart C Section 15.247.

FREQUENCY RANGE (MHz)	LIMIT (ms)		
	20dB bandwidth <250kHz(50Channel)	20dB bandwidth >250kHz(25Channel)	20dB bandwidth <1MHz(75Channel)
902-928	400(20s)	400(10s)	NA
2400-2483.5	NA	NA	400(30s)
5725-5850	NA	NA	400(30s)

NOTE: The “()” is all channel’s average time of occupancy.

4.5.2 TEST EQUIPMENT

The following test equipment was used during the test:

EQUIPMENT/ FACILITIES	SPECIFICATIONS	MANUFACTURER	MODEL#/ SERIAL#	DUE DATE OF CAL. & CAL. CENTER
SPECTRUM	9kHz-7GHz	ROHDE & SCHWARZ	FSP7/ 839511/010	APR. 2008 R&S

NOTE: The calibration interval of the above test equipment is one year and the calibrations are traceable to NML/ROC and NIST/USA.

4.5.3 TEST SET-UP

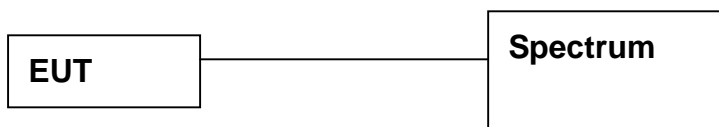

The EUT was connected to a spectrum through a 50Ω RF cable.

4.5.4 TEST PROCEDURE

The EUT was operating in hopping mode or could be controlled its channel. Printed out the test result from the spectrum by hard copy function.

4.5.5 EUT OPERATING CONDITION

Same as section 4.1.5 of this report.



Spectrum Research & Testing Lab., Inc.
No. 101-10, Ling 8,
Shan-Tong Li, Chung-Li
City, Taoyuan, Taiwan

TEST REPORT

Reference No.: A07062903
Report No.: FCCA07062903
FCC ID: Q7Z-BV300R1
Page: 61 of 103
Date: Jul. 27, 2007

4.5.6 TEST RESULT

Temperature:	<u>24°C</u>	Humidity:	<u>63%RH</u>
Spectrum Detector:	<u>PK</u>	Tested by:	<u>Jeff Yu</u>
Test Mode:	<u>BV-300</u>	Tested Date:	<u>Jul. 12, 2007</u>
Test Result:	<u>PASS</u>		

CHANNEL NUMBER	CHANNEL FREQUENCY (MHz)	Pulse Time (μ s)	Burts (in 1 sec.)	Time of occupancy (Dwell Time) (ms)	Average time of occupancy LIMIT (ms)
0	2402.00	178	10	56.2	400
39	2441.00	178	10	56.2	400
78	2480.00	180	10	56.9	400



Spectrum Research & Testing Lab., Inc.
 No. 101-10, Ling 8,
 Shan-Tong Li, Chung-Li
 City, Taoyuan, Taiwan

TEST REPORT

Reference No.: A07062903
 Report No.: FCCA07062903
 FCC ID: Q7Z-BV300R1
 Page: 62 of 103
 Date: Jul. 27, 2007

CH0:

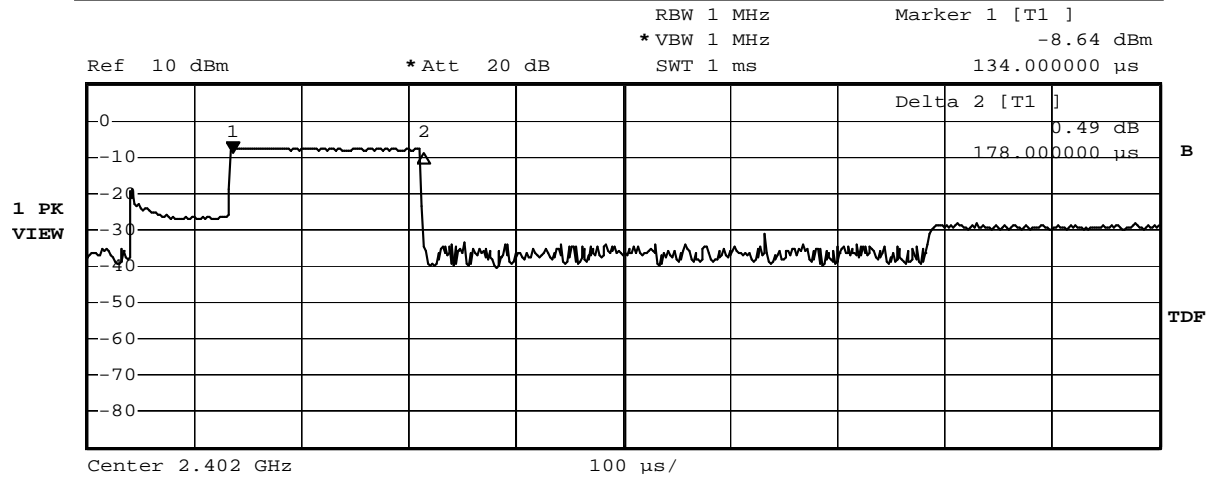
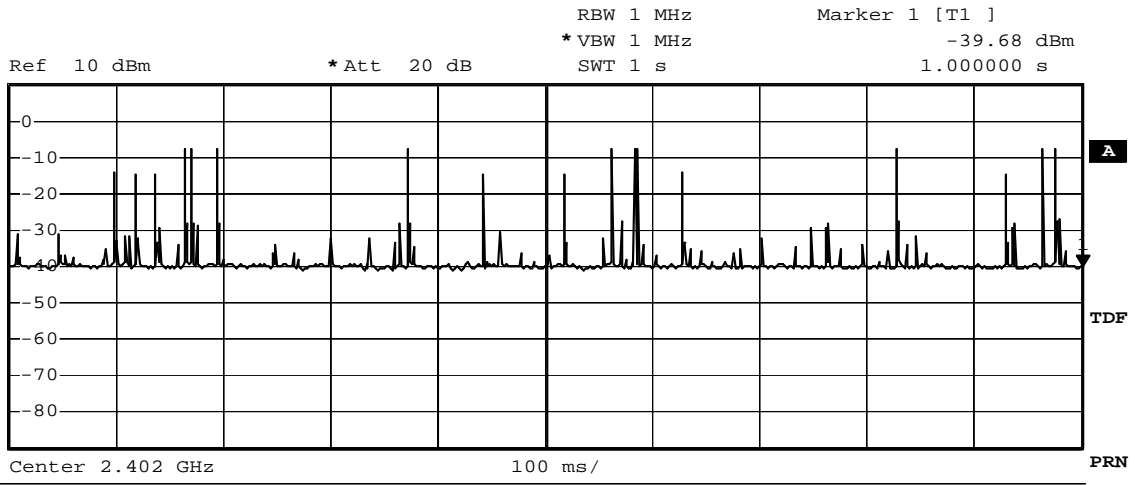

Date: 18.JUL.2007 16:38:37



Ch39:

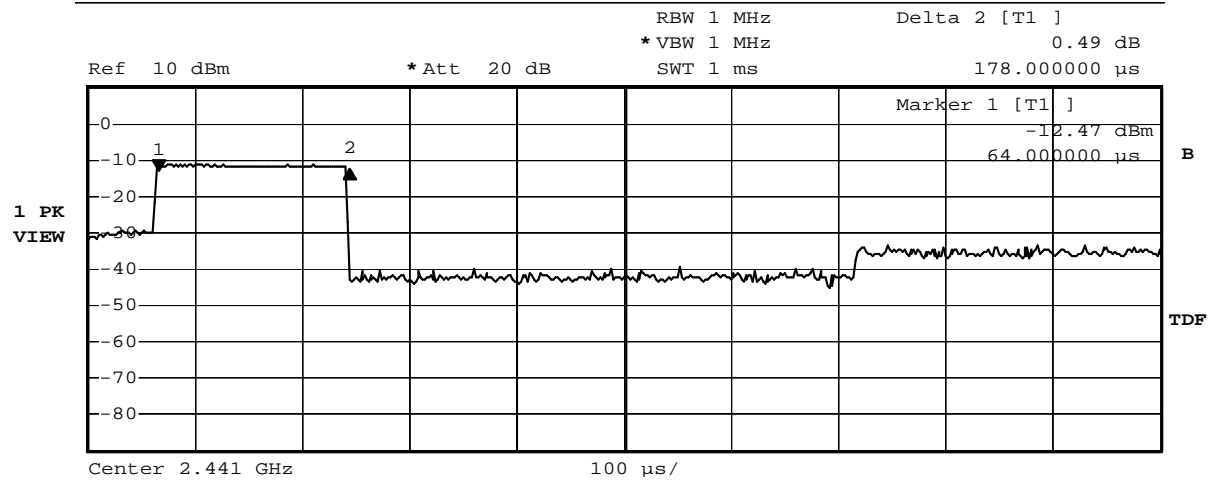
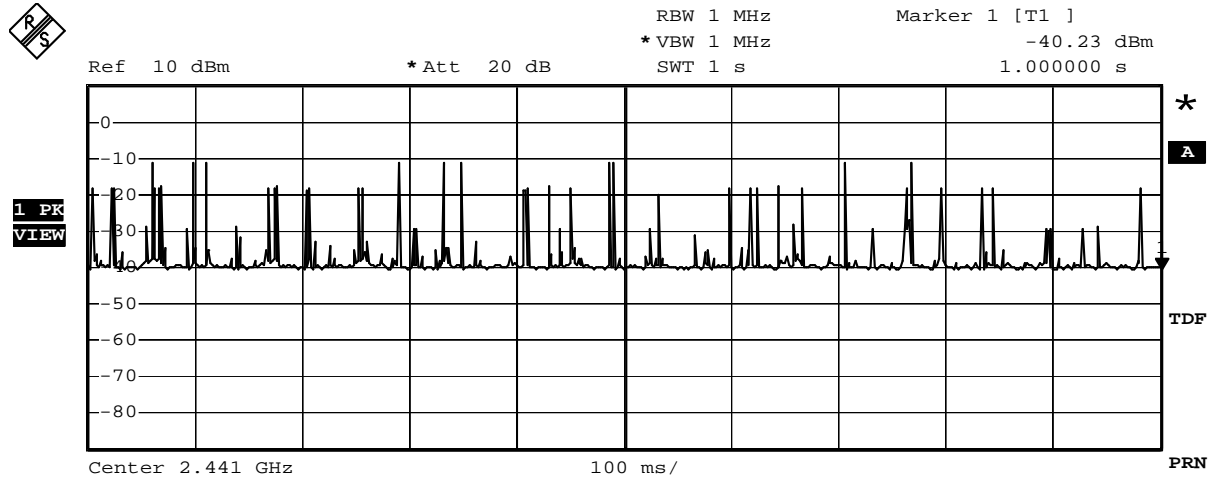

Date: 18.JUL.2007 16:41:41



Spectrum Research & Testing Lab., Inc.
 No. 101-10, Ling 8,
 Shan-Tong Li, Chung-Li
 City, Taoyuan, Taiwan

TEST REPORT

Reference No.: A07062903
 Report No.: FCCA07062903
 FCC ID: Q7Z-BV300R1
 Page: 64 of 103
 Date: Jul. 27, 2007

CH78:

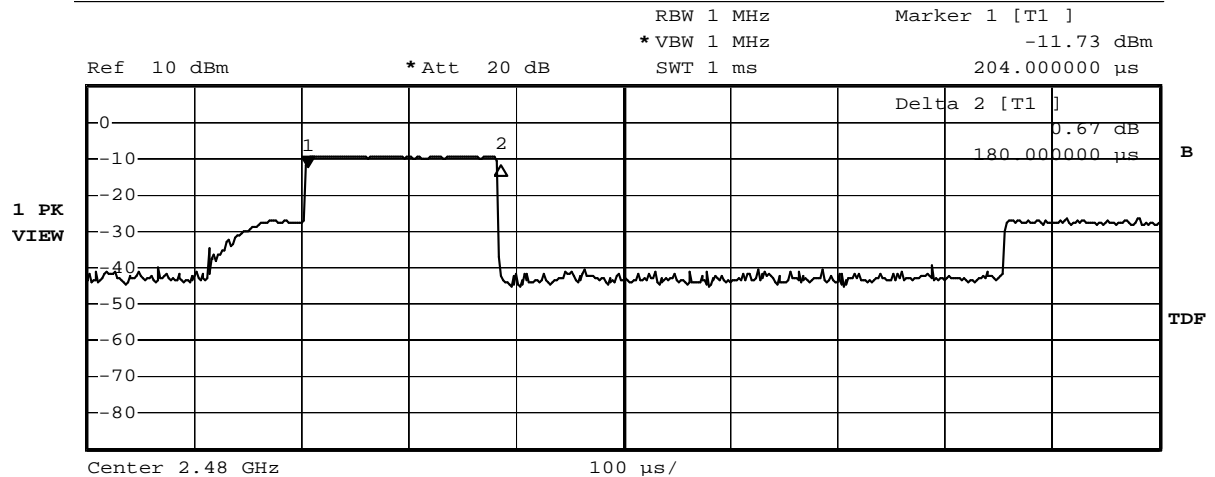
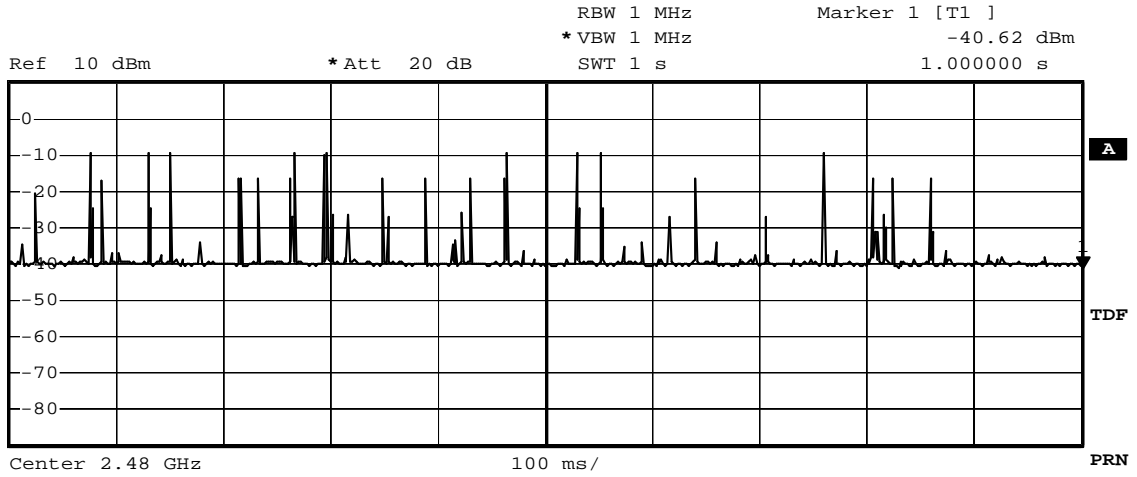

Date: 18.JUL.2007 16:45:46



Spectrum Research & Testing Lab., Inc.
No. 101-10, Ling 8,
Shan-Tong Li, Chung-Li
City, Taoyuan, Taiwan

TEST REPORT

Reference No.: A07062903
Report No.: FCCA07062903
FCC ID: Q7Z-BV300R1
Page:65 of 103
Date: Jul. 27, 2007

Temperature: 24°C Humidity: 63%RH
Spectrum Detector: PK Tested by: Jeff Yu
Test Mode: Dongle Tested Date: Jul. 12, 2007
Test Result: PASS

CHANNEL NUMBER	CHANNEL FREQUENCY (MHz)	Pulse Time (µs)	Burts (in 1 sec.)	Time of occupancy (Dwell Time) (ms)	Average time of occupancy LIMIT (ms)
0	2402.00	2.88	3	273	400
39	2441.00	3.00	3	284.4	400
78	2480.00	2.98	3	282.5	400



Spectrum Research & Testing Lab., Inc.
 No. 101-10, Ling 8,
 Shan-Tong Li, Chung-Li
 City, Taoyuan, Taiwan

TEST REPORT

Reference No.: A07062903
 Report No.: FCCA07062903
 FCC ID: Q7Z-BV300R1
 Page: 66 of 103
 Date: Jul. 27, 2007

CH0:

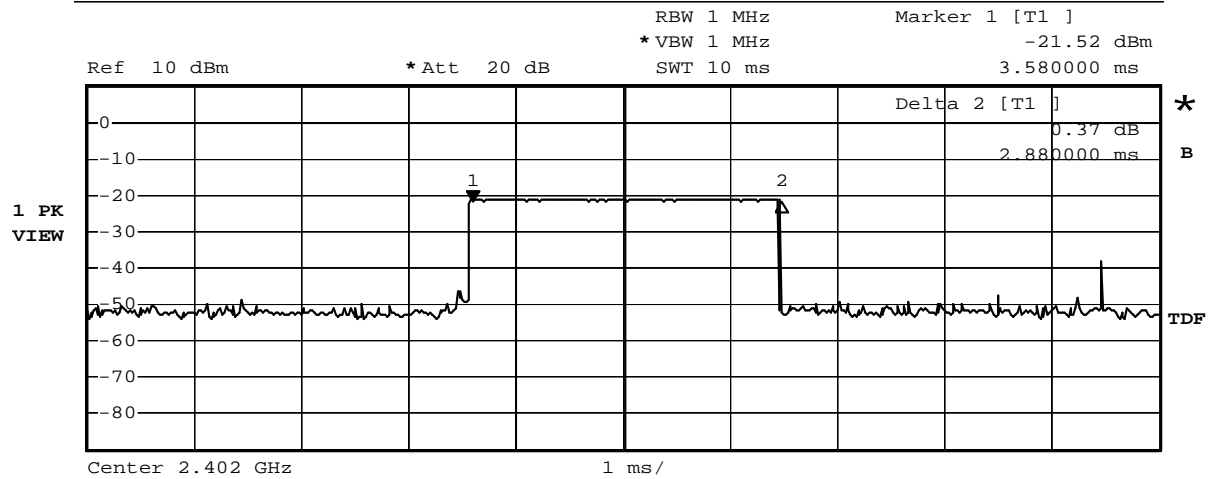
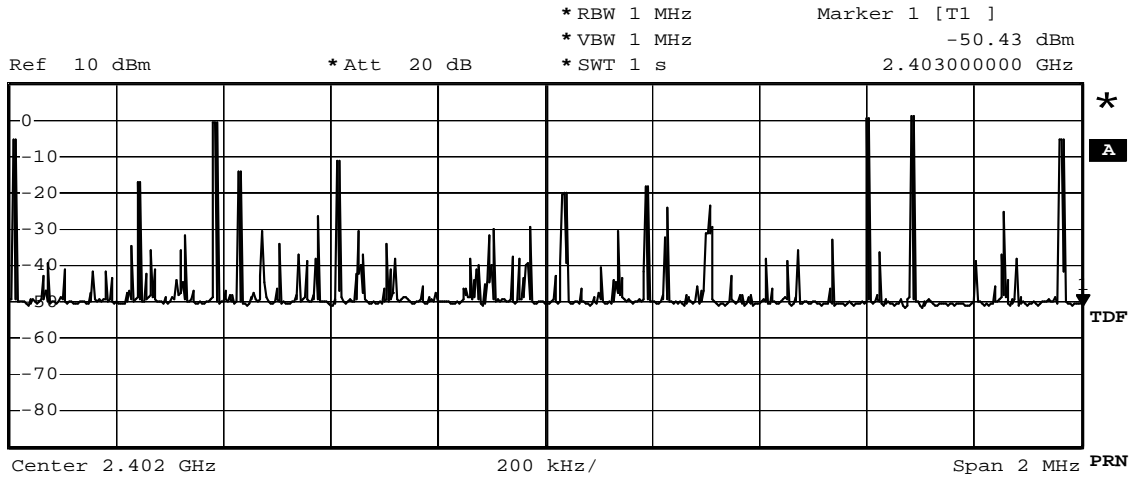

Date: 18.JUL.2007 14:57:47



Spectrum Research & Testing Lab., Inc.
 No. 101-10, Ling 8,
 Shan-Tong Li, Chung-Li
 City, Taoyuan, Taiwan

TEST REPORT

Reference No.: A07062903
 Report No.: FCCA07062903
 FCC ID: Q7Z-BV300R1
 Page: 67 of 103
 Date: Jul. 27, 2007

Ch39:

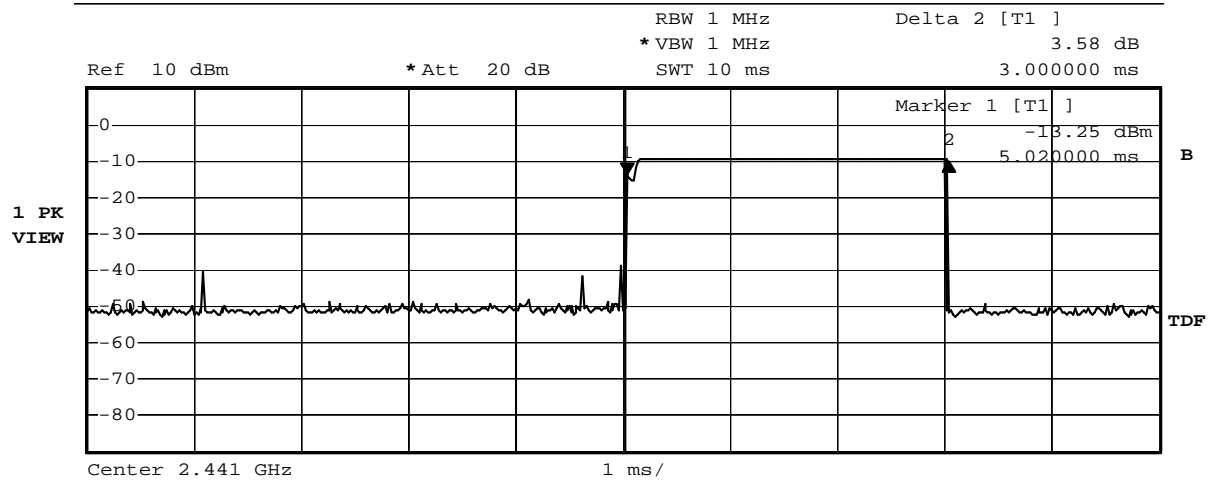
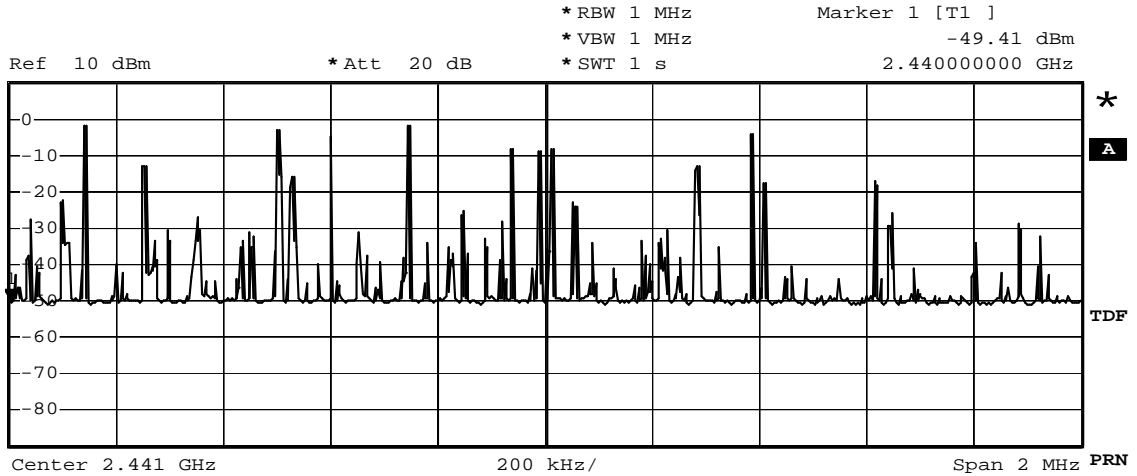

Date: 18.JUL.2007 15:01:01



Spectrum Research & Testing Lab., Inc.
 No. 101-10, Ling 8,
 Shan-Tong Li, Chung-Li
 City, Taoyuan, Taiwan

TEST REPORT

Reference No.: A07062903
 Report No.: FCCA07062903
 FCC ID: Q7Z-BV300R1
 Page: 68 of 103
 Date: Jul. 27, 2007

CH78:

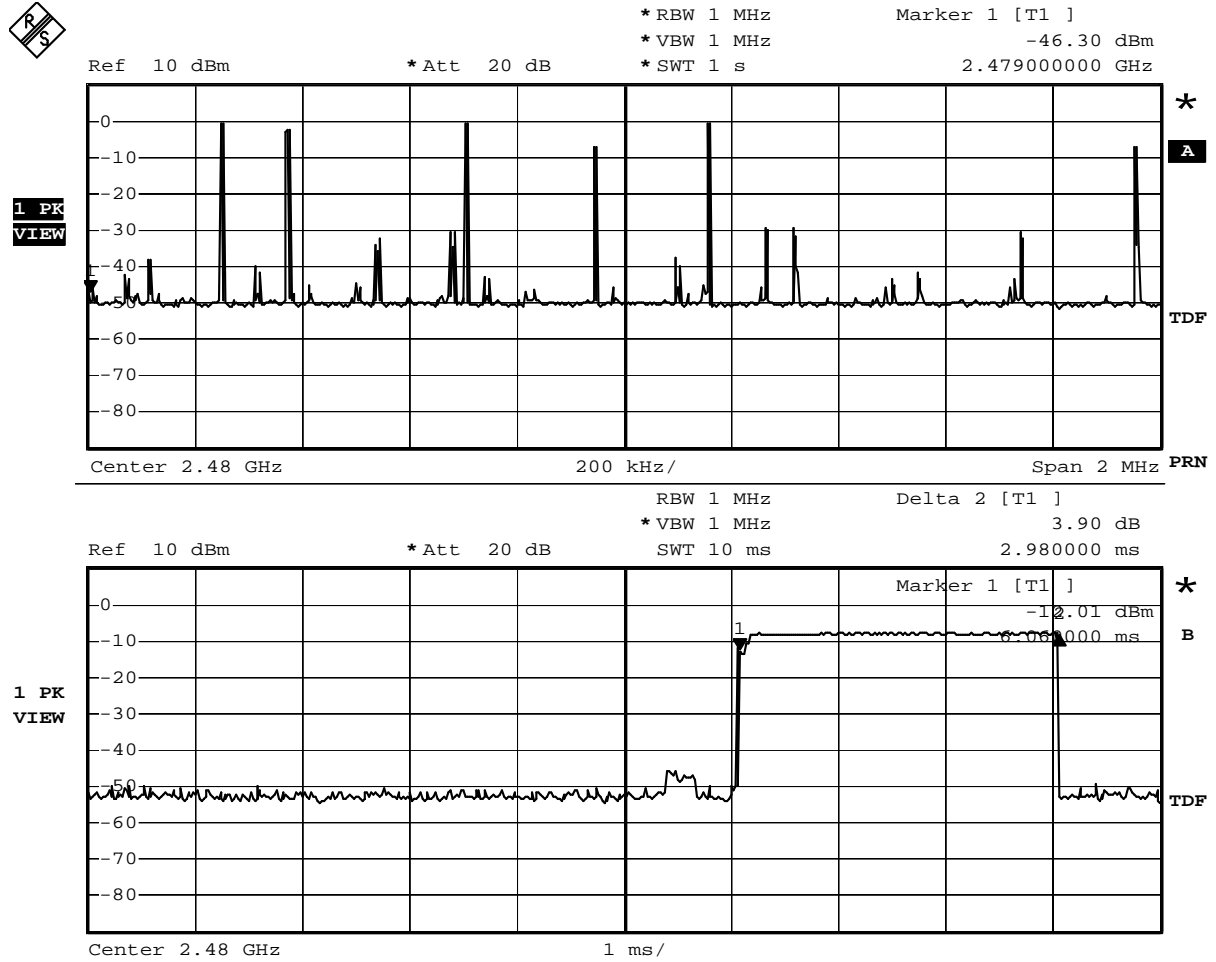

Date: 18.JUL.2007 15:03:00



Spectrum Research & Testing Lab., Inc.
 No. 101-10, Ling 8,
 Shan-Tong Li, Chung-Li
 City, Taoyuan, Taiwan

TEST REPORT

Reference No.: A07062903
 Report No.: FCCA07062903
 FCC ID: Q7Z-BV300R1
 Page: 69 of 103
 Date: Jul. 27, 2007

4.6 MAXIMUM PEAK POWER TEST

4.6.1 LIMIT

FCC Part15, Subpart C Section 15.247.

FREQUENCY RANGE (MHz)	LIMIT (W)				
	Quantity of Hopping Channel	50	25	15	75
902-928	1(30dBm)	0.125(21dBm)	NA	NA	NA
2400-2483.5	NA	NA	0.125(21dBm)	1(30dBm)	1(30dBm)
5725-5850	NA	NA	NA	NA	1(30dBm)

4.6.2 TEST EQUIPMENT

The following test equipment was used during the test :

EQUIPMENT/FACILITIES	SPECIFICATIONS	MANUFACTURER	MODEL#/SERIAL#	DUE DATE OF CAL. & CAL. CENTER
SPECTRUM	9kHz-7GHz	ROHDE & SCHWARZ	FSP7/ 839511/010	APR. 2008 R&S
POWER METER	N/A	BOONTON	4232A/ 29001	MAY 2008 ETC
POWER SENSOR	DC-18GHz 0.3 μ W-100mW 50 Ω	BOONTON	51011-EMC/ 31184	JUN. 2008 ETC

NOTE: The calibration interval of the above test equipment is one year and the calibrations are traceable to NML/ROC and NIST/USA.



4.6.3 TEST SET-UP

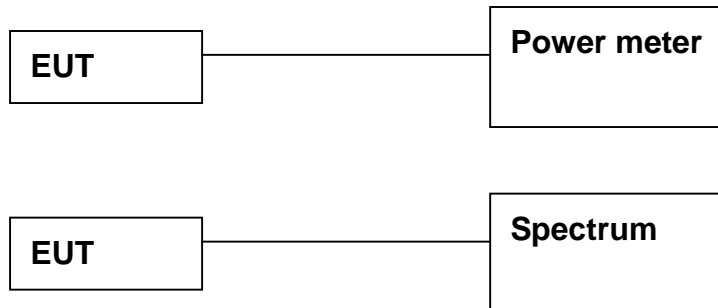

The EUT was connected to a spectrum through a 50Ω RF cable.

4.6.4 TEST PROCEDURE

The EUT was operating in hopping mode or could control its channel.
 Printed out the test result from the spectrum by hard copy function.
 Recorded the read value of the power meter.

4.6.5 EUT OPERATING CONDITION

Same as section 4.1.5 of this report.

4.6.6 TEST RESULT

Temperature:	<u>24°C</u>	Humidity:	<u>60%RH</u>
Spectrum Detector:	<u>PK</u>	Tested by:	<u>Jeff Yu</u>
Test Mode:	<u>BV-300</u>	Tested Date:	<u>Jul. 20, 2007</u>
Test Result:	<u>PASS</u>		

CHANNEL NUMBER	CHANNEL FREQUENCY (MHz)	PEAK POWER OUTPUT (dBm)	PEAK POWER LIMIT (dBm)
0	2402.0000	-2.66	30
39	2441.0000	-5.84	30
78	2480.0000	-2.44	30



Spectrum Research & Testing Lab., Inc.
No. 101-10, Ling 8,
Shan-Tong Li, Chung-Li
City, Taoyuan, Taiwan

TEST REPORT

Reference No.: A07062903
Report No.: FCCA07062903
FCC ID: Q7Z-BV300R1
Page: 71 of 103
Date: Jul. 27, 2007

CH0:



Ref 10 dBm *Att 20 dB *RBW 1 MHz Marker 1 [T1]
*VBW 1 MHz -2.66 dBm
*SWT 100 ms 2.402000000 GHz

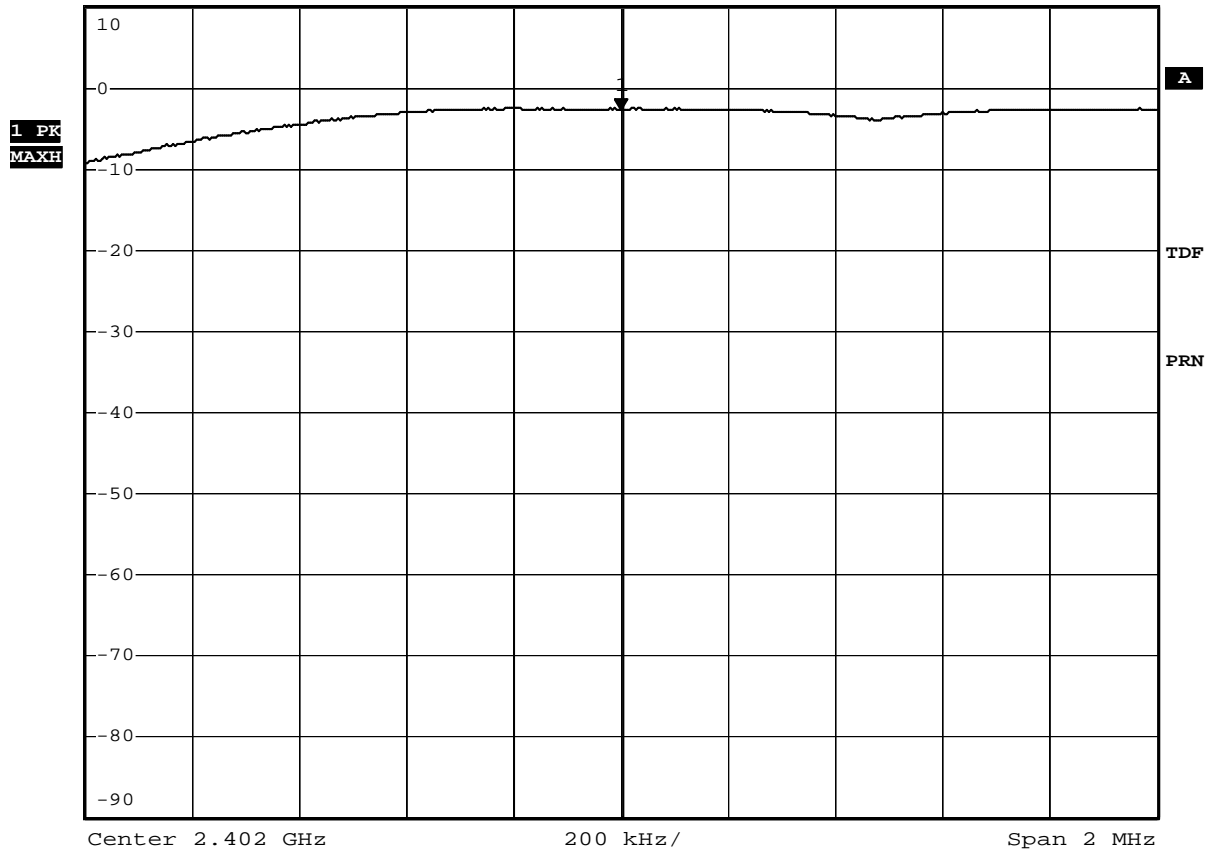

Date: 19.JUL.2007 11:19:22



Spectrum Research & Testing Lab., Inc.
 No. 101-10, Ling 8,
 Shan-Tong Li, Chung-Li
 City, Taoyuan, Taiwan

TEST REPORT

Reference No.: A07062903
 Report No.: FCCA07062903
 FCC ID: Q7Z-BV300R1
 Page: 72 of 103
 Date: Jul. 27, 2007

CH39:



Ref 10 dBm *Att 20 dB *RBW 1 MHz Marker 1 [T1]
 *VBW 1 MHz -5.84 dBm
 *SWT 100 ms 2.441000000 GHz

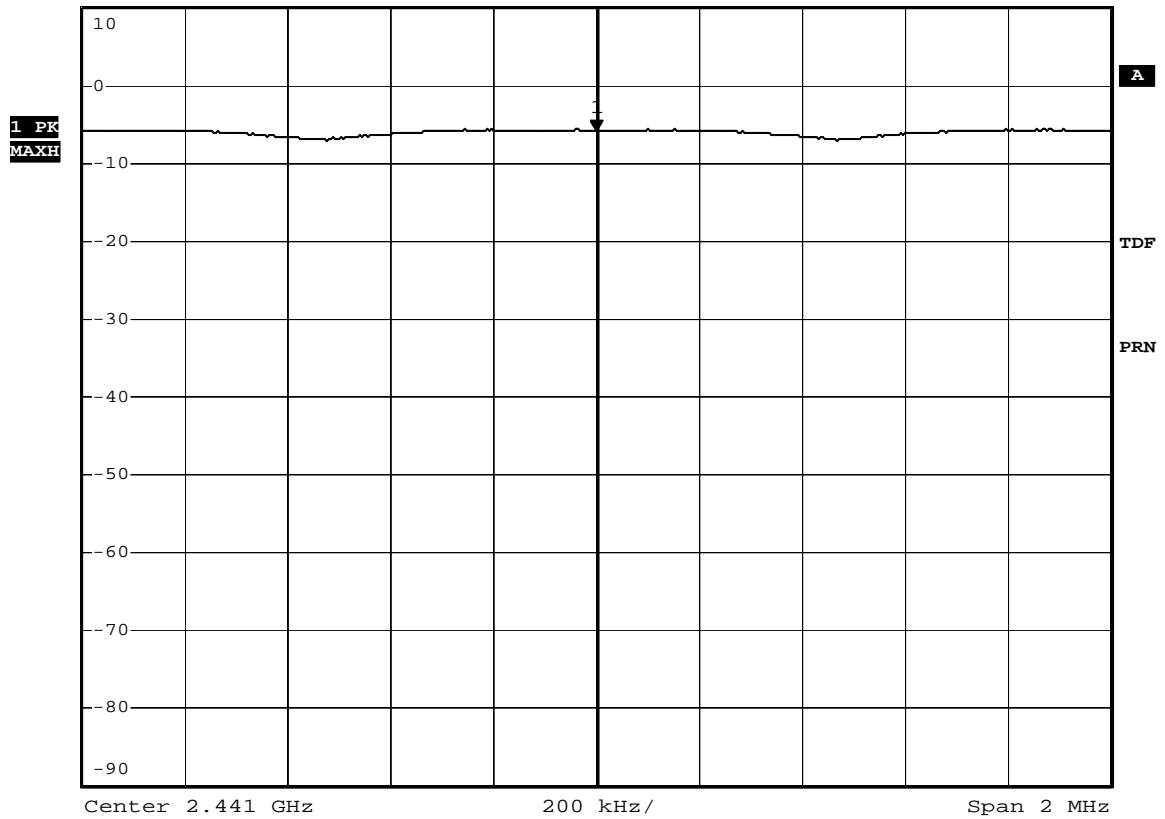

Date: 19.JUL.2007 11:26:58



Spectrum Research & Testing Lab., Inc.
 No. 101-10, Ling 8,
 Shan-Tong Li, Chung-Li
 City, Taoyuan, Taiwan

TEST REPORT

Reference No.: A07062903
 Report No.: FCCA07062903
 FCC ID: Q7Z-BV300R1
 Page: 73 of 103
 Date: Jul. 27, 2007

CH78:

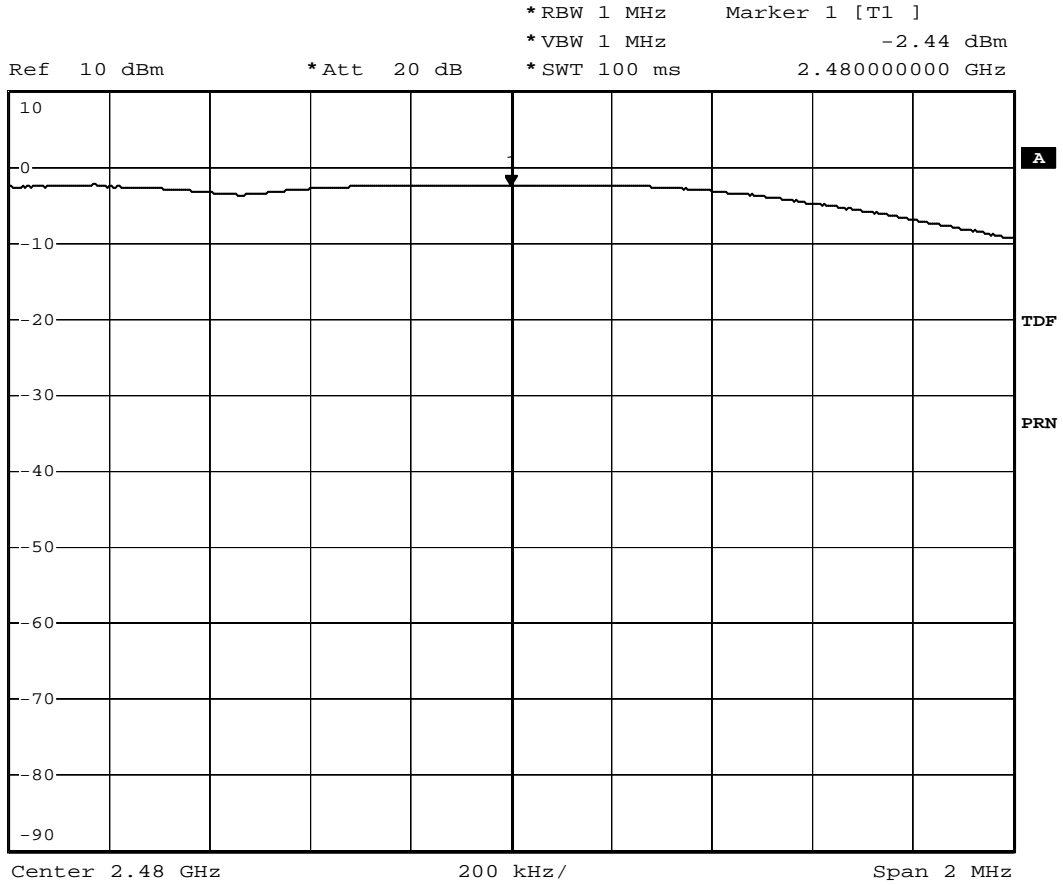

Date: 19.JUL.2007 11:37:26



Spectrum Research & Testing Lab., Inc.
No. 101-10, Ling 8,
Shan-Tong Li, Chung-Li
City, Taoyuan, Taiwan

TEST REPORT

Reference No.: A07062903
Report No.: FCCA07062903
FCC ID: Q7Z-BV300R1
Page:74 of 103
Date: Jul. 27, 2007

Temperature:	<u>24°C</u>	Humidity:	<u>60%RH</u>
Spectrum Detector:	<u>PK</u>	Tested by:	<u>Jeff Yu</u>
Test Mode:	<u>Dongle</u>	Tested Date:	<u>Jul. 20, 2007</u>
Test Result:	<u>PASS</u>		

CHANNEL NUMBER	CHANNEL FREQUENCY (MHz)	PEAK POWER OUTPUT (dBm)	PEAK POWER LIMIT (dBm)
0	2402.0000	0.89	30
39	2441.0000	-2.38	30
78	2480.0000	-0.64	30



Spectrum Research & Testing Lab., Inc.
 No. 101-10, Ling 8,
 Shan-Tong Li, Chung-Li
 City, Taoyuan, Taiwan

TEST REPORT

Reference No.: A07062903
 Report No.: FCCA07062903
 FCC ID: Q7Z-BV300R1
 Page: 75 of 103
 Date: Jul. 27, 2007

CH0:

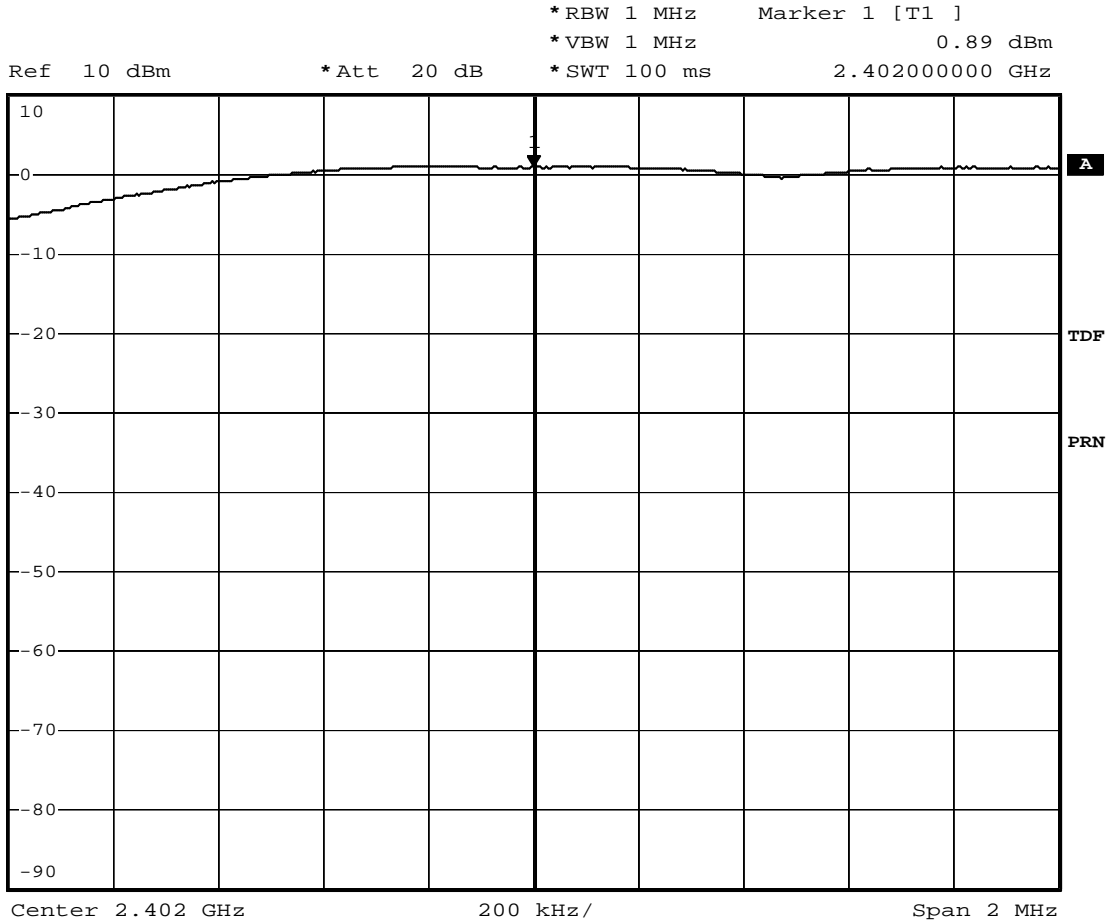

Date: 18.JUL.2007 15:12:44



Spectrum Research & Testing Lab., Inc.
No. 101-10, Ling 8,
Shan-Tong Li, Chung-Li
City, Taoyuan, Taiwan

TEST REPORT

Reference No.: A07062903
Report No.: FCCA07062903
FCC ID: Q7Z-BV300R1
Page: 77 of 103
Date: Jul. 27, 2007

CH78:

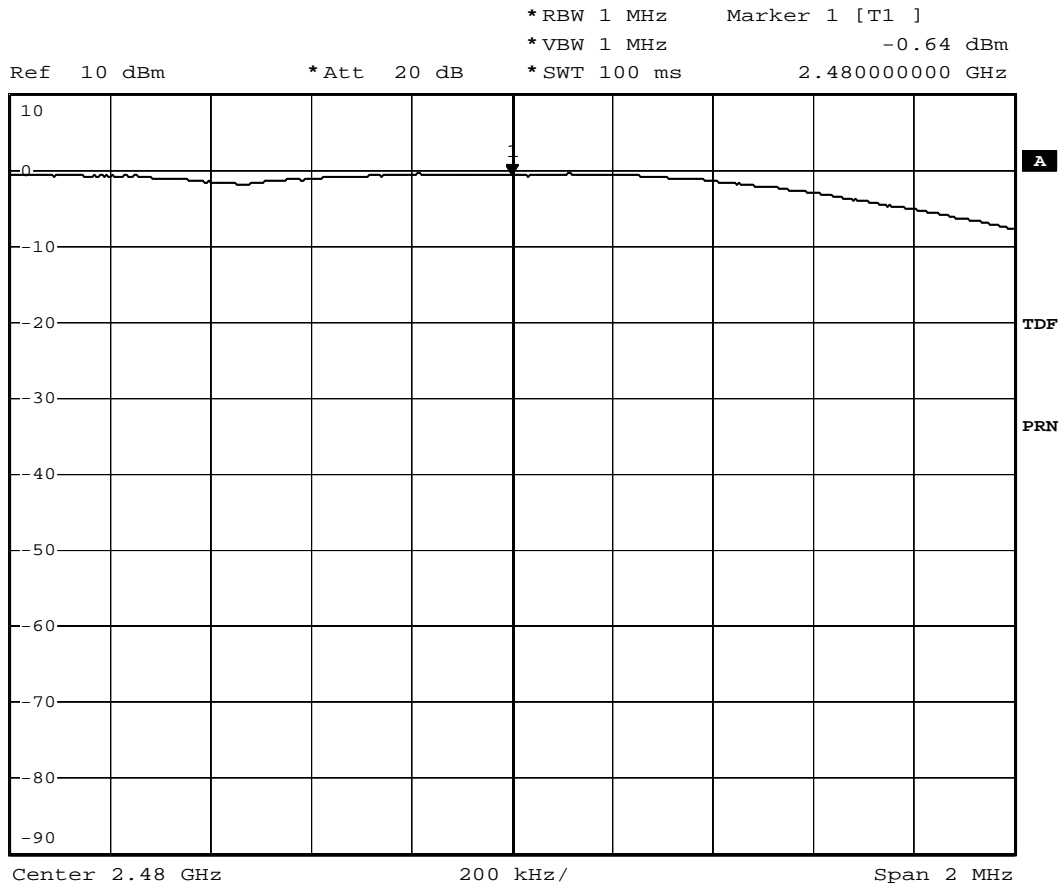

Date: 18.JUL.2007 15:05:06



4.7 BAND EDGE TEST

4.7.1 LIMIT

FCC Part15, Subpart C Section 15.247. In any 100 kHz bandwidth outside the frequency band in which the spread spectrum intentional radiator is operating, the radio frequency power that is produced by the intentional radiator shall be at least 20 dB below that in the 100 kHz bandwidth within the band that contains the highest level of the desired power, based on either an RF conducted or a radiated measurement. Attenuation below the general limits specified in Section 15.209(a) is not required. In addition, radiated emissions which fall in the restricted bands, as defined in Section 15.205(a), must also comply with the radiated emission limits specified in Section 15.209(a) (see Section 15.205(c)).

OPERATING FREQUENCY RANGE (MHz)	SPURIOUS EMISSION FREQUENCY (MHz)	LIMIT	
		Peak power ration to emission(dBc)	Emission level(dBuV/m)
902-928	<902	>20	NA
	>928	>20	NA
	960-1240	NA	54
2400-2483.5	<2400	>20	NA
	>2483.5-2500	NA	54
5725-5850	<5350-5460	NA	54
	<5725	>20	NA
	>5850	>20	NA



Spectrum Research & Testing Lab., Inc.
No. 101-10, Ling 8,
Shan-Tong Li, Chung-Li
City, Taoyuan, Taiwan

TEST REPORT

Reference No.: A07062903
Report No.: FCCA07062903
FCC ID: Q7Z-BV300R1
Page: 79 of 103
Date: Jul. 27, 2007

4.7.2 TEST EQUIPMENT

The following test equipment was used during the test :

EQUIPMENT/ FACILITIES	SPECIFICATIONS	MANUFACTURER	MODEL#/ SERIAL#	DUE DATE OF CAL. & CAL. CENTER
SPECTRUM	9kHz-7GHz	ROHDE & SCHWARZ	FSP7/ 839511/010	APR. 2008 R&S
EMI TEST RECEIVER	9 kHz TO 2750 MHz	ROHDE & SCHWARZ	ESCS30/ 830245/012	AUG. 2007 R&S
SPECTRUM	9KHz-26.5GHz	HP	8593E/ 3710A03220	MAY 2008 ETC
PRE-AMPLIFIER	1GHz-26.5GHz Gain:30dB	HP	8449B/ 3008A01019	NOV. 2008 ETC
BI-LOG ANTENNA	25 MHz TO 2 GHz	EMCO	3142/ 9701-1124	FEB. 2008 SRT
HORN ANTENNA	1GHz to 18GHz	EMCO	3115/ 9602-4681	DEC. 2007 ETC
OATS	3 - 10 M measurement	SRT	SRT-1	APR. 2008 SRT

NOTE: The calibration interval of the above test equipment is one year and the calibrations are traceable to NML/ROC and NIST/USA.

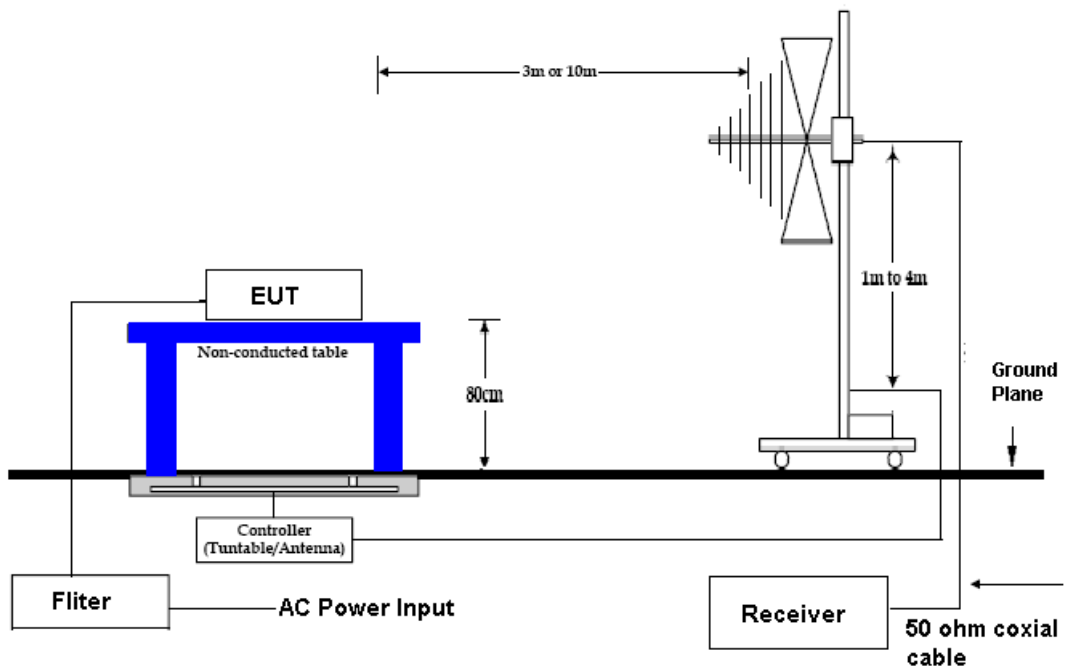
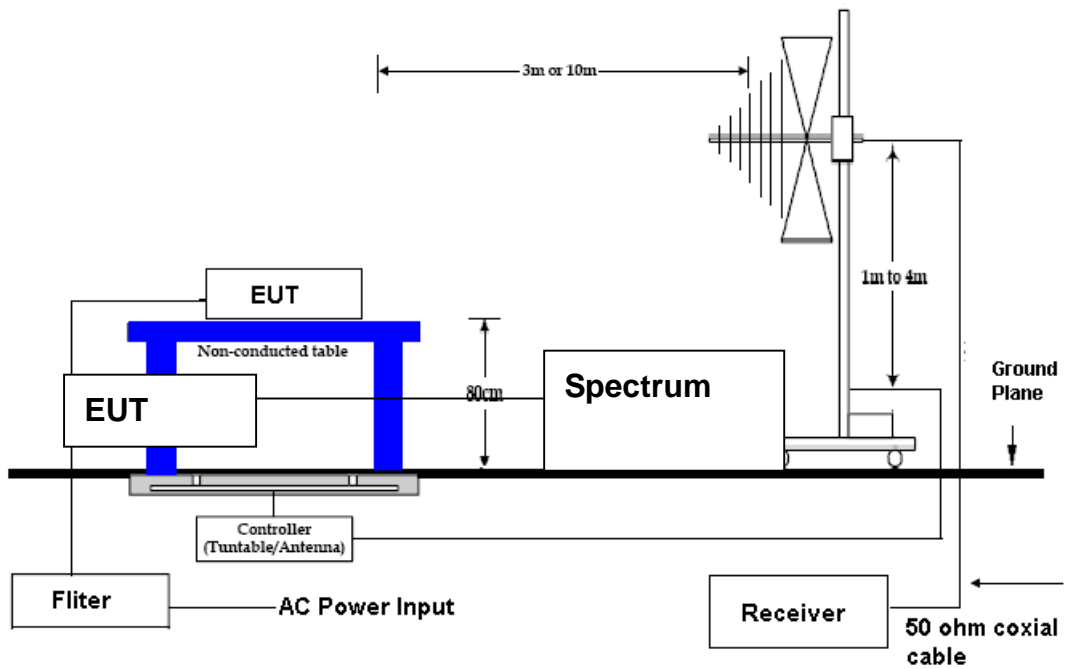

NOTE :

1. The EUT system was put on a wooden table with 0.8m heights above a ground plane.
2. For the actual test configuration, please refer to the photos of testing.



4.7.4 TEST PROCEDURE

- The EUT was operating in hopping mode or could be controlled its channel.
Printed out the test result from the spectrum by hard copy function.
- The EUT was tested according to the requirement of ANSI C63.4 and CISPR 22.
The measurements were made at an open area test site with 10 meter measurement distance under 1 GHz and with 3m distance above 1GHz. The frequency spectrum measured started from 30 MHz. Under 1 GHz. All readings were quasi-peak values with 120 kHz resolution bandwidth of the test receiver. Above 1 GHz, the measurements were made at an open area test site with 3 meter measurement distance and all readings were peak and average values with 1 MHz resolution bandwidth of the test receiver. The EUT system was operated in all typical methods by users. The cables connected to EUT and support units were moved to find the maximum emission levels for each frequency.

4.7.5 EUT OPERATING CONDITION

Same as section 4.1.5 of this report.

4.7.6 TEST RESULT

Temperature:	<u>24°C</u>	Humidity:	<u>60%RH</u>
Spectrum Detector:	<u>PK & AV</u>	Tested by:	<u>Jeff Yu</u>
Test Mode:	<u>BV-300</u>	Tested Date:	<u>Jul. 23, 2007</u>
Test Result:	<u>PASS</u>		

1. Conducted test

Frequency (MHz)	PEAK POWER OUTPUT (dBm)	Emission read Value(dBm)	Result of Band edge (dBc)	Band edge LIMIT (dBc)
<2400	-2.66	-38.9	-36.24	>20dBc
>2500	-2.44	-36.54	-34.1	>20dBc

2. Radiated emission test

Frequency (MHz)	Antenna polarization (H/V)	PEAK POWER OUTPUT (dBm)		Emission read Value(dBuV/m)		Band edge Limit (dBuV/m)	
		PK	AV	PK	AV	PK	AV
<2400	V	42.1	*	60.18	*	74.0	54.0
>2500	V	39.5	*	58.3	*	74.0	54.0



Spectrum Research & Testing Lab., Inc.
 No. 101-10, Ling 8,
 Shan-Tong Li, Chung-Li
 City, Taoyuan, Taiwan

TEST REPORT

Reference No.: A07062903
 Report No.: FCCA07062903
 FCC ID: Q7Z-BV300R1
 Page: 82 of 103
 Date: Jul. 27, 2007

<2400MHz:

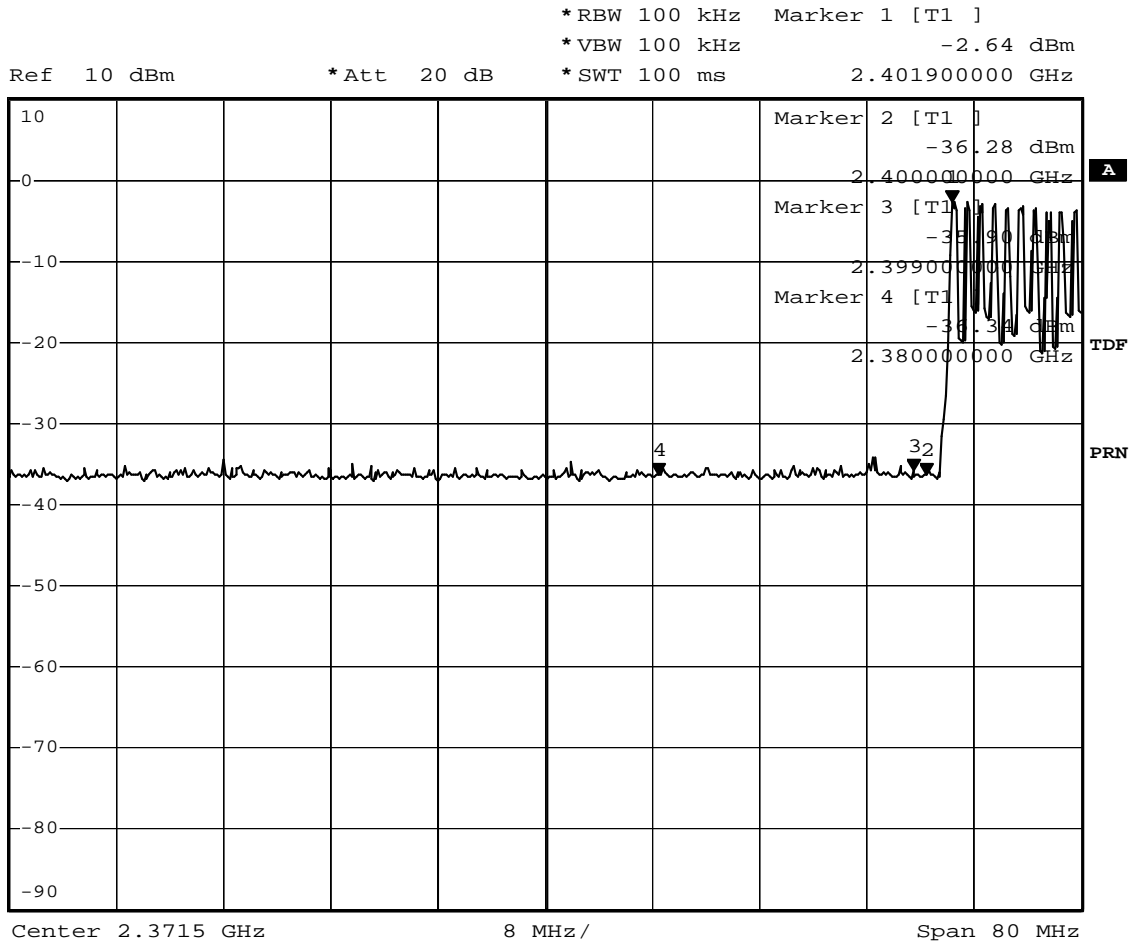

Date: 19.JUL.2007 11:53:41



Spectrum Research & Testing Lab., Inc.
 No. 101-10, Ling 8,
 Shan-Tong Li, Chung-Li
 City, Taoyuan, Taiwan

TEST REPORT

Reference No.: A07062903
 Report No.: FCCA07062903
 FCC ID: Q7Z-BV300R1
 Page: 83 of 103
 Date: Jul. 27, 2007

>2500MHz

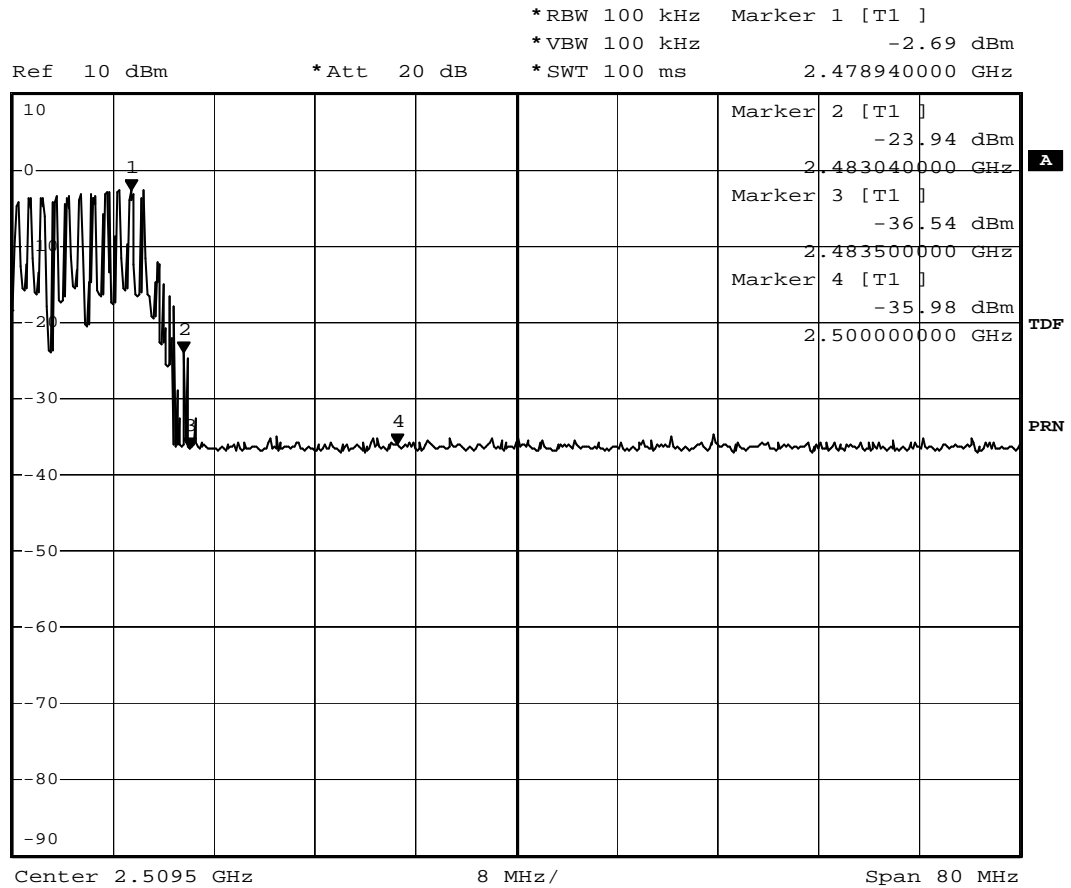

Date: 19.JUL.2007 12:04:44



Spectrum Research & Testing Lab., Inc.
 No. 101-10, Ling 8,
 Shan-Tong Li, Chung-Li
 City, Taoyuan, Taiwan

TEST REPORT

Reference No.: A07062903
 Report No.: FCCA07062903
 FCC ID: Q7Z-BV300R1
 Page:84 of 103
 Date: Jul. 27, 2007

Temperature:	<u>24°C</u>	Humidity:	<u>60%RH</u>
Spectrum Detector:	<u>PK & AV</u>	Tested by:	<u>Jeff Yu</u>
Test Mode:	<u>Dongle</u>	Tested Date:	<u>Jul. 23, 2007</u>
Test Result:	<u>PASS</u>		

1. Conducted test

Frequency (MHz)	PEAK POWER OUTPUT (dBm)	Emission read Value(dBm)	Result of Band edge (dBc)	Band edge LIMIT (dBc)
<2400	0.89	-44.00	-44.89	>20dBc
>2500	-0.64	-39.47	-38.83	>20dBc

2. Radiated emission test

Frequency (MHz)	Antenna polarization (H/V)	PEAK POWER OUTPUT (dBm)		Emission read Value(dBuV/m)		Band edge Limit (dBuV/m)	
		PK	AV	PK	AV	PK	AV
<2400	V	49.1	*	62.31	*	74.0	54.0
>2500	V	47.6	*	63.4	*	74.0	54.0



4.8 20dB Bandwidth

4.8.1 LIMIT

Frequency Range (MHz)	Quantity of Hopping Channel	Limit(kHz)			
		50	25	15	75
902-928		<250	>250	NA	NA
2400-2483.5		NA	NA	>1000	<1000

4.8.2 TEST EQUIPMENT

The following test equipment was used during the test:

EQUIPMENT/FACILITIES	SPECIFICATIONS	MANUFACTURER	MODEL#/SERIAL#	DUE DATE OF CAL. & CAL. CENTER
SPECTRUM	9kHz-7GHz	ROHDE & SCHWARZ	FSP7/ 839511/010	APR. 2008 R&S

NOTE: The calibration interval of the above test equipment is one year and the calibrations are traceable to NML/ROC and NIST/USA.

4.8.3 TEST SET-UP



The EUT was connected to a spectrum through a 50Ω RF cable.

4.8.4 TEST PROCEDURE

The EUT was operating in hopping mode or could be controlled its channel. Printed out the test result from the spectrum by hard copy function.

4.8.5 EUT OPERATING CONDITION

Same as section 4.1.5 of this report.



Spectrum Research & Testing Lab., Inc.
No. 101-10, Ling 8,
Shan-Tong Li, Chung-Li
City, Taoyuan, Taiwan

TEST REPORT

Reference No.: A07062903
Report No.: FCCA07062903
FCC ID: Q7Z-BV300R1
Page:88 of 103
Date: Jul. 27, 2007

4.8.6 TEST RESULT

Temperature:	<u>24°C</u>	Humidity:	<u>60%RH</u>
Spectrum Detector:	<u>PK</u>	Tested by:	<u>Jeff Yu</u>
Test Mode:	<u>BV-300</u>	Tested Date:	<u>Jul. 23, 2007</u>
Test Result:	<u>PASS</u>		

CHANNEL NUMBER	CHANNEL FREQUENCY (MHz)	20dB DOWN BW (kHz)
0	2402	778
39	2441	696
78	2480	684



Spectrum Research & Testing Lab., Inc.
 No. 101-10, Ling 8,
 Shan-Tong Li, Chung-Li
 City, Taoyuan, Taiwan

TEST REPORT

Reference No.: A07062903
 Report No.: FCCA07062903
 FCC ID: Q7Z-BV300R1
 Page: 89 of 103
 Date: Jul. 27, 2007

CH0:



Ref 10 dBm *Att 20 dB *RBW 30 kHz Marker 1 [T1]
 *VBW 100 kHz -2.70 dBm
 *SWT 100 ms 2.401996000 GHz

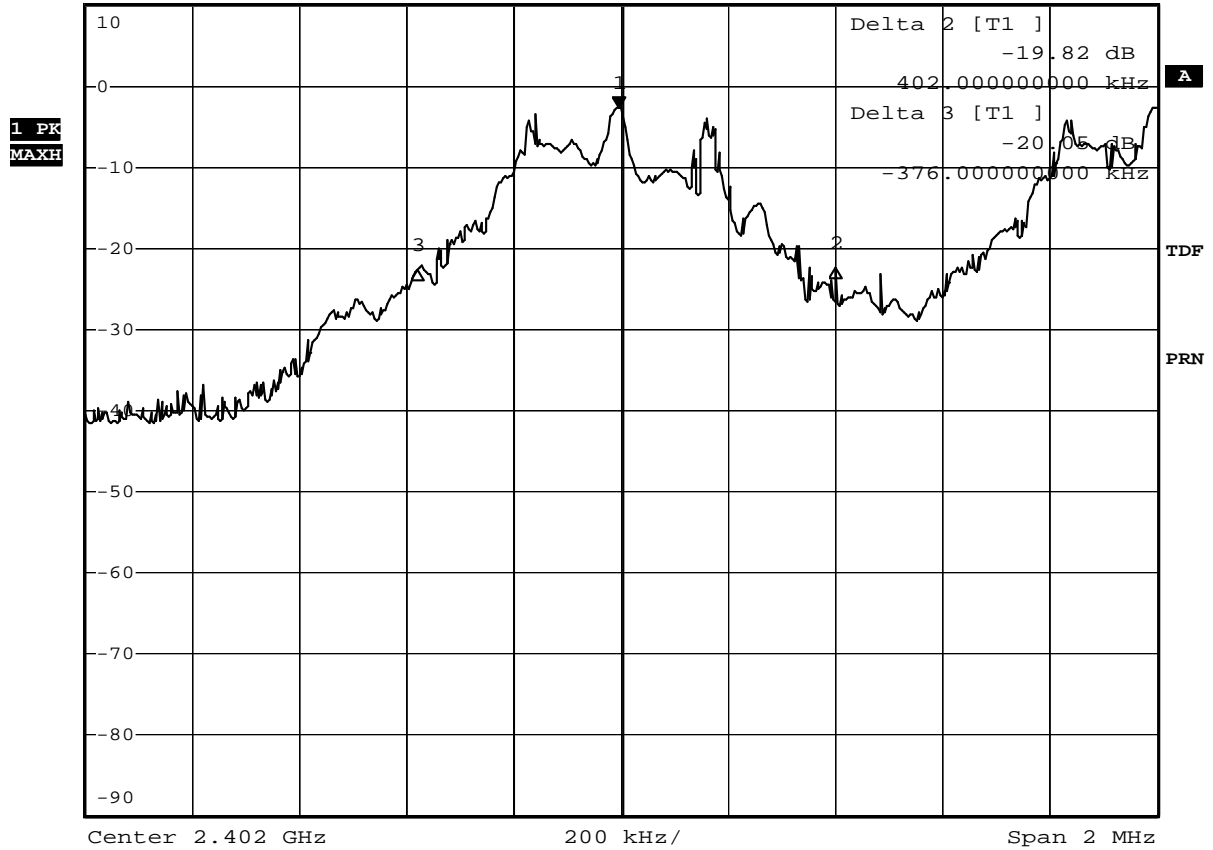

Date: 19.JUL.2007 12:18:38



Spectrum Research & Testing Lab., Inc.
 No. 101-10, Ling 8,
 Shan-Tong Li, Chung-Li
 City, Taoyuan, Taiwan

TEST REPORT

Reference No.: A07062903
 Report No.: FCCA07062903
 FCC ID: Q7Z-BV300R1
 Page: 90 of 103
 Date: Jul. 27, 2007

Ch39:



Ref 10 dBm *Att 20 dB *RBW 30 kHz Marker 1 [T1]
 *VBW 100 kHz -4.98 dBm
 *SWT 100 ms 2.440996000 GHz

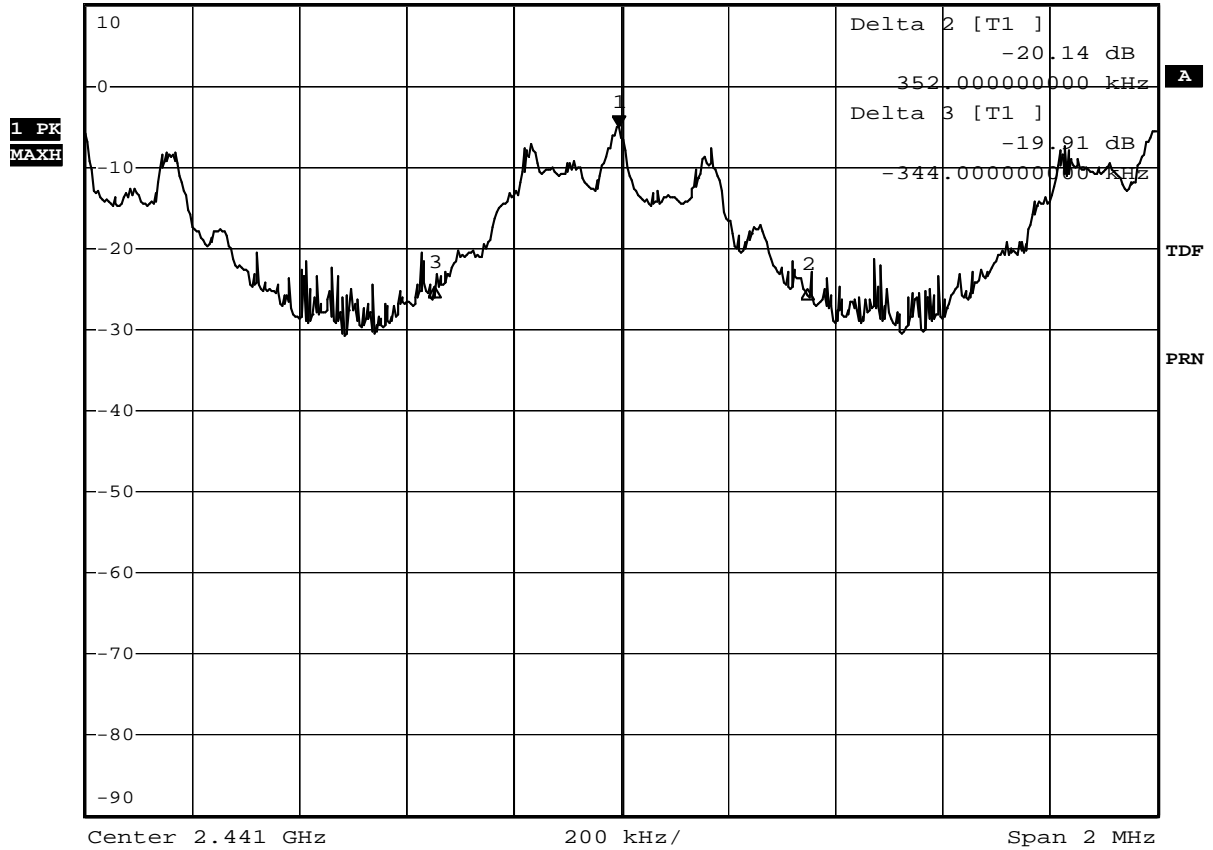

Date: 19.JUL.2007 12:41:30



Spectrum Research & Testing Lab., Inc.
No. 101-10, Ling 8,
Shan-Tong Li, Chung-Li
City, Taoyuan, Taiwan

TEST REPORT

Reference No.: A07062903
Report No.: FCCA07062903
FCC ID: Q7Z-BV300R1
Page: 92 of 103
Date: Jul. 27, 2007

Temperature:	<u>24°C</u>	Humidity:	<u>60%RH</u>
Spectrum Detector:	<u>PK</u>	Tested by:	<u>Jeff Yu</u>
Test Mode:	<u>Dongle</u>	Tested Date:	<u>Jul. 23, 2007</u>
Test Result:	<u>PASS</u>		

CHANNEL NUMBER	CHANNEL FREQUENCY (MHz)	20dB DOWN BW (kHz)
0	2402	960
39	2441	956
78	2480	958



Spectrum Research & Testing Lab., Inc.
 No. 101-10, Ling 8,
 Shan-Tong Li, Chung-Li
 City, Taoyuan, Taiwan

TEST REPORT

Reference No.: A07062903
 Report No.: FCCA07062903
 FCC ID: Q7Z-BV300R1
 Page: 95 of 103
 Date: Jul. 27, 2007

CH78:

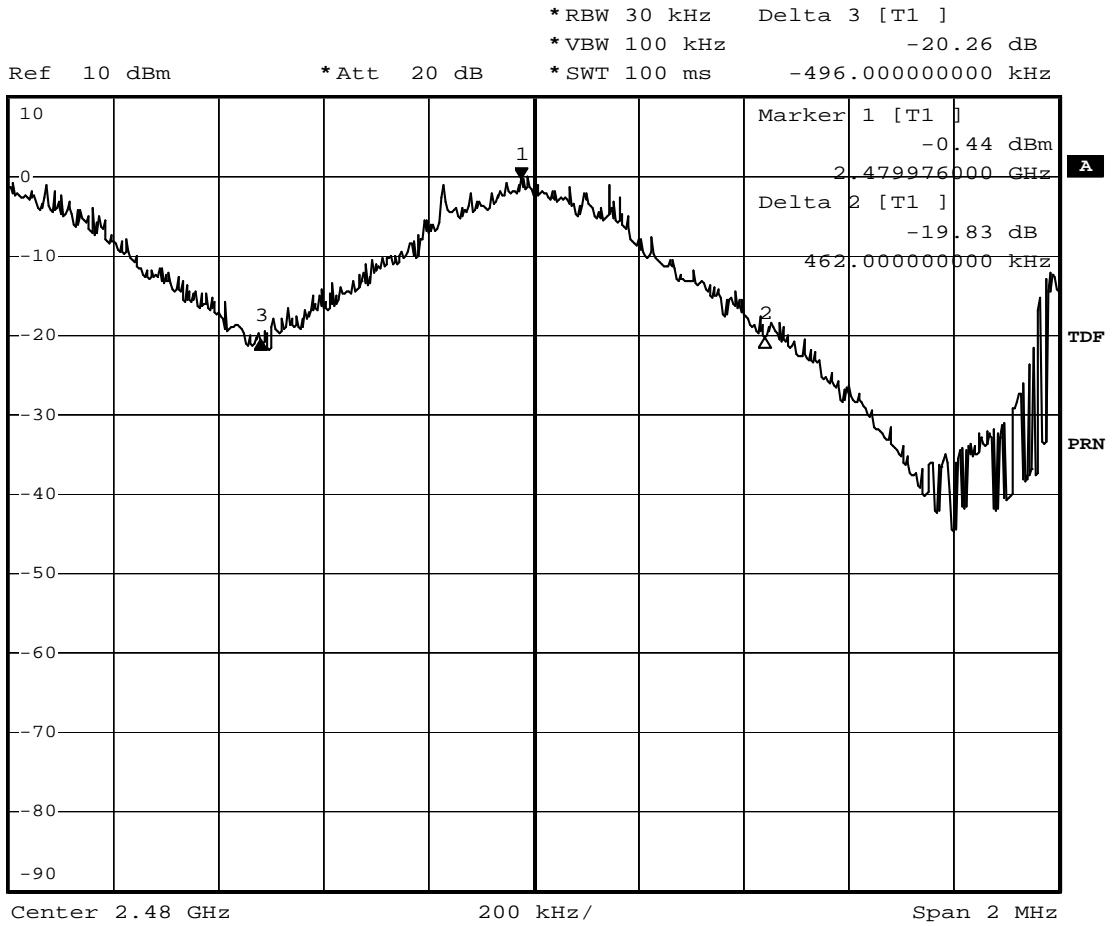

Date: 18.JUL.2007 15:50:07



**Spectrum Research &
Testing Lab., Inc.**
No. 101-10, Ling 8,
Shan-Tong Li, Chung-Li
City, Taoyuan, Taiwan

TEST REPORT

Reference No.: A07062903
Report No.: FCCA07062903
FCC ID: Q7Z-BV300R1
Page: 96 of 103
Date: Jul. 27, 2007

5. Antenna application

5.1 Antenna requirement

The EUT's antenna is met the requirement of FCC part15C section15.203 and 15.204.

FCC part15C section15.247 requirement:

Systems operating in the 2400-2483.5 MHz band that are used exclusively for fixed, point-to-point operations may employ transmitting antennas with directional gain greater than 6 dBi provided the maximum peak output power of the intentional radiator is reduced by 1 dB for every 3 dB that the directional gain of the antenna exceeds 6 dBi.

5.2 Result

The EUT's antenna used a dipole antenna on PCB. The antenna's gain is 0dBi and meets the requirement.



Spectrum Research & Testing Lab., Inc.
No. 101-10, Ling 8,
Shan-Tong Li, Chung-Li
City, Taoyuan, Taiwan

TEST REPORT

Reference No.: A07062903
Report No.: FCCA07062903
FCC ID: Q7Z-BV300R1
Page: 103 of 103
Date: Jul. 27, 2007

7. TERMS OF ABRIVATION

AV.	Average detection
AZ(°)	Turn table azimuth
Correct.	Correction
EL(m)	Antenna height (meter)
EUT	Equipment Under Test
Horiz.	Horizontal direction
LISN	Line Impedance Stabilization Network
NSA	Normalized Site Attenuation
Q.P.	Quasi-peak detection
SRT Lab	Spectrum Research & Testing Laboratory, Inc.
Vert.	Vertical direction