

AFAR COMMUNICATIONS, INC

PULSAR WIRELESS ETHERNET BRIDGE

Model: AR-9010E



01/08/2010

Report No.: SL09121701-AFA-001
(This report supersedes NONE)



Modifications made to the product : None

This Test Report is Issued Under the Authority of:

	
David Zhang Compliance Engineer	Leslie Bai Director of Certification

This test report may be reproduced in full only.
All Test Data Presented in this report is only applicable to presented Test sample.

EMC Test Report

To: FCC Part 15.247: 2009 & RSS 210 Issue 7: 2007

SIEMIC, INC.
Accessing global markets



Laboratory Introduction

SIEMIC, headquartered in the heart of Silicon Valley, with superior facilities in US and Asia, is one of the leading independent testing and certification facilities providing customers with one-stop shop services for Compliance Testing and Global Certifications.



In addition to [testing](#) and [certification](#), SIEMIC provides initial design reviews and [compliance management](#) through out a project. Our extensive experience with [China](#), [Asia Pacific](#), [North America](#), [European](#), and [international](#) compliance requirements, assures the fastest, most cost effective way to attain regulatory compliance for the [global markets](#).

Accreditations for Conformity Assessment

Country/Region	Accreditation Body	Scope
USA	FCC, A2LA	EMC , RF/Wireless , Telecom
Canada	IC, A2LA, NIST	EMC, RF/Wireless , Telecom
Taiwan	BSMI , NCC , NIST	EMC, RF, Telecom , Safety
Hong Kong	OFTA , NIST	RF/Wireless ,Telecom
Australia	NATA, NIST	EMC, RF, Telecom , Safety
Korea	KCC/RRA, NIST	EMI, EMS, RF , Telecom, Safety
Japan	VCCI, JATE, TELEC, RFT	EMI, RF/Wireless, Telecom
Mexico	NOM, COFETEL, Caniety	Safety, EMC , RF/Wireless, Telecom
Europe	A2LA, NIST	EMC, RF, Telecom , Safety

Accreditations for Product Certifications

Country	Accreditation Body	Scope
USA	FCC TCB, NIST	EMC , RF , Telecom
Canada	IC FCB, NIST	EMC , RF , Telecom
Singapore	iDA, NIST	EMC , RF , Telecom



SIEMIC, INC.

Accessing global markets

Title: RF Test Report of AFAR Communications, Inc
Model : AR-9010E
To FCC 15.247:2009 & RSS-210 Issue 7 : 2007

Serial# SL09121701-AFA-001
Issue Date 01/08/2010
Page 3 of 64
www.siemic.com

This page has been left blank intentionally.



CONTENTS

1	EXECUTIVE SUMMARY & EUT INFORMATION	6
2	TECHNICAL DETAILS.....	7
3	MODIFICATION.....	8
4	TEST SUMMARY.....	9
5	MEASUREMENTS, EXAMINATION AND DERIVED RESULTS	10
	ANNEX A. TEST INSTRUMENT & METHOD	39
	ANNEX B EUT AND TEST SETUP PHOTOGRAPHS.....	43
	ANNEX C. TEST SETUP AND SUPPORTING EQUIPMENT.....	43
	ANNEX D USER MANUAL, BLOCK DIAGRAM, CIRCUIT DIAGRAM.....	47
	ANNEX E. SIEMIC ACCREDITATION CERTIFICATES	48



SIEMIC, INC.

Accessing global markets

Title: RF Test Report of AFAR Communications, Inc
Model : AR-9010E
To FCC 15.247:2009 & RSS-210 Issue 7 : 2007

Serial# SL09121701-AFA-001
Issue Date 01/08/2010
Page 5 of 64
www.siemic.com

This page has been left blank intentionally.



SIEMIC, INC.

Accessing global markets

Title: RF Test Report of AFAR Communications, Inc
Model : AR-9010E
To FCC 15.247:2009 & RSS-210 Issue 7 : 2007

Serial# SL09121701-AFA-001
Issue Date 01/08/2010
Page 6 of 64
www.siemic.com

1 Executive Summary & EUT information

The purpose of this test programmed was to demonstrate compliance of the AFAR Communications, Inc Model: AR-9010E against the current Stipulated Standards. The PulsAR Wireless Ethernet Bridge have demonstrated compliance with the FCC 15.247:2009 & RSS-210 Issue 7 : 2007.

The test has demonstrated that this unit complies with stipulated standards.

EUT Information

EUT Description : The family of pulsAR Wireless Ethernet Bridges consist of license free radios that can be used to bridge Ethernet LANs (Local Area Networks) across distances ranging from a few hundred feet to 50 miles (80 km) and beyond. You can deploy them in a variety of topologies from a simple point-to-point link to a general mesh "tree" topology where any subscriber node can also be used as an access point to nodes further downstream. For mobile applications you can configure subscriber nodes to autonomously roam between multiple access points, keeping the mobile nodes connected to the network at all times.

All radios use Direct Sequence Spread Spectrum and operate in the "Industrial Scientific and Medical" (ISM) bands, either at 900 MHz or 2.4 GHz.

Model No : AR-9010E

Serial No : AF030004

Input Power : Power over Ethernet compatible (+48VDC)
Or +10 to +58 VDC or
110 to 220VAC (with external supply)

Classification Per Stipulated Test Standard : Spread Spectrum System / Device

**SIEMIC, INC.**

Accessing global markets

Title: RF Test Report of AFAR Communications, Inc
To: Model : AR-9010E
FCC 15.247:2009 & RSS-210 Issue 7 : 2007Serial# SL09121701-AFA-001
Issue Date 01/08/2010
Page 7 of 64
www.siemic.com

2 TECHNICAL DETAILS

Purpose	Compliance testing of PulsAR Wireless Ethernet Bridge model AR-9010E with stipulated standard
Applicant / Client	AFAR Communications, Inc
Manufacturer	AFAR Communications, Inc 81 David Love Place Santa Barbara , CA 93117
Laboratory performing the tests	SIEMIC Laboratories
Test report reference number	SL09121701-AFA-001
Date EUT received	December 23 rd 2009
Standard applied	See Page 9
Dates of test (from – to)	December 23-31 2009
No of Units:	1
Equipment Category:	DTS
Trade Name:	AFAR Communications, Inc
Model Name:	AR-9010E
RF Operating Frequency (ies)	903MHz - 927MHz
Number of Channels:	25
Modulation:	DSSS
FCC ID:	Q7N-9010E
IC ID:	4733A-9010E



SIEMIC, INC.
Accessing global markets

Title: RF Test Report of AFAR Communications, Inc
Model : AR-9010E
To: FCC 15.247:2009 & RSS-210 Issue 7 : 2007

Serial# SL09121701-AFA-001
Issue Date 01/08/2010
Page 8 of 64
www.siemc.com

3 MODIFICATION

NONE

4 TEST SUMMARY

The product was tested in accordance with the following specifications. All testing has been performed according to below product classification:

Spread Spectrum System / Device

Test Results Summary

Test Standard		Description	Pass / Fail
CFR 47 Part 15.247: 2009	RSS 210 Issue 7: 2007		
15.203		Antenna Requirement	Pass
15.205	RSS210(A8.5)	Restricted Band of Operation	Pass
15.207(a)	RSSGen(7.2.2)	Conducted Emissions Voltage	Pass
15.247(a)(1)	RSS210(A8.1)	Channel Separation	N/A
15.247(a)(1)	RSS210(A8.1)	Occupied Bandwidth	N/A
15.247(a)(2)	RSS210 (A8.2)	6 dB Bandwidth	Pass
15.247(a)(1)	RSS210(A8.1)	Number of Hopping Channels	N/A
15.247(a)(1)	RSS210(A8.1)	Time of Occupancy	N/A
15.247(b)	RSS210(A8.4)	Output Power	Pass
15.247(c)	RSS210(A8.4)	Antenna Gain > 6 dBi	Pass
15.247(d)	RSS210(A8.5)	Conducted Spurious Emissions	Pass
15.209; 15.247(d)	RSS210(A8.5)	Radiated Spurious Emissions	Pass
15.247(e)	RSS210(A8.3)	Power Spectral Density	Pass
15.247(f)	RSS210(A8.3)	Hybrid System Requirement	N/A
15.247(g)	RSS210(A8.1)	Hopping Capability	N/A
15.247(h)	RSS210(A8.1)	Hopping Coordination Requirement	N/A
15.247(i)	RSSGen(5.5)	RF Exposure requirement	Pass
	RSSGen(4.8)	Receiver Spurious Emissions	N/A

ANSI C63.4: 2003/ RSS-Gen Issue 2: 2007

PS: All measurement uncertainties are not taken into consideration for all presented test result.

5 MEASUREMENTS, EXAMINATION AND DERIVED RESULTS

5.1 Antenna Requirement

Requirement(s): 47 CFR §15.203

An intentional radiator shall be designed to ensure that no antenna other than that furnished by the responsible party shall be used with the device.

Antenna requirement must meet at least one of the following:

- a) Antenna must be permanently attached to the device.
- b) Antenna must use a unique type of connector to attach to the device.
- c) Device must be professionally installed. Installer shall be responsible for ensuring that the correct antenna is employed with the device.

AR-9010E can work with 2 different types of antenna , of which antenna gain are 5dBi and 15dBi . The antenna connector is N type and the maximum gain is 15dBi for 903MHz – 927MHz band.

This is subject to professional installation. For detail, please see user manual.

Results: PASS

5.2 Conducted Emissions Voltage

Requirement:

Frequency of emission (MHz)	Conducted limit (dB μ V)	
	Quasi-peak	Average
0.15–0.5	66 to 56*	56 to 46*
0.5–5	56	46
5–30	60	50

*Decreases with the logarithm of the frequency.

Procedures:

- All possible modes of operation were investigated. Only the 6 worst case emissions measured, using the correct CISPR and Average detectors, are reported. All other emissions were relatively insignificant.
- A "-ve" margin indicates a PASS as it refers to the margin present below the limit line at the particular frequency.
- Conducted Emissions Measurement Uncertainty
All test measurements carried out are traceable to national standards. The uncertainty of the measurement at a confidence level of approximately 95% (in the case where distributions are normal), with a coverage factor of 2, in the range 9kHz – 30MHz (Average & Quasi-peak) is ± 3.86 dB.
- Environmental Conditions

Temperature	23°C
Relative Humidity	50%
Atmospheric Pressure	1019mbar

Test Date : December 19 to 31 2009
Tested By :David Zhang

Results: Pass

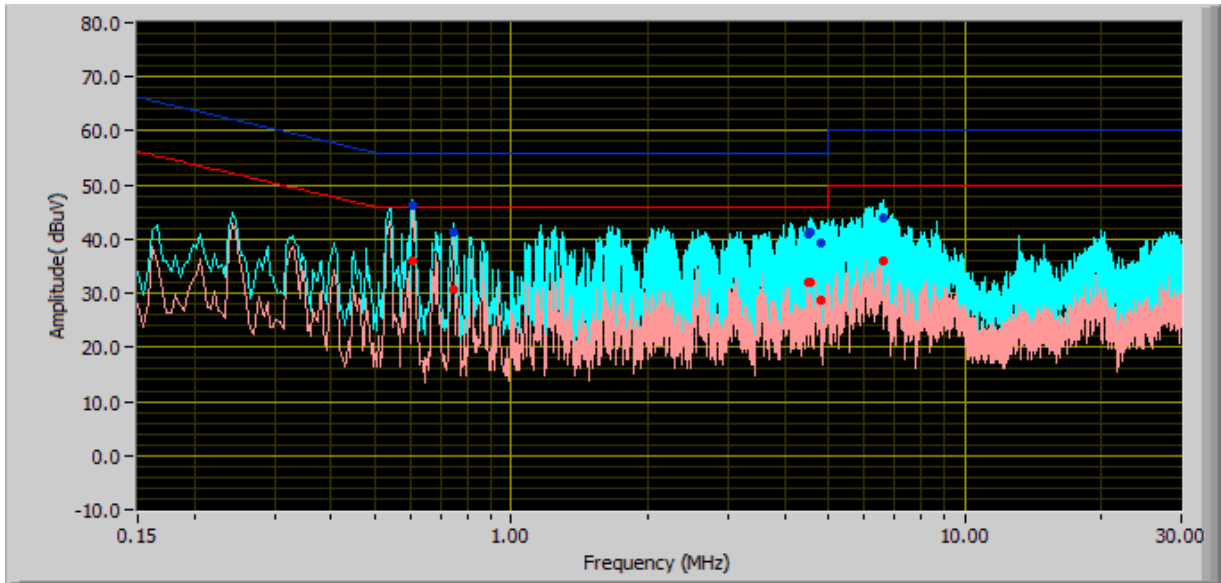

Quasi-Peak Limit

Average Limit

Phase Line Plot at 120Vac, 60Hz

Frequency (MHz)	QP Value (dBµV)	Class B Limit (dB)	Pass / Fail	Margin (dB)	Avg Value (dBµV)	Class B Limit (dB)	Pass / Fail	Margin (dB)	Line
0.61	46.18	56.00	PASS	-9.82	36.13	46.00	PASS	-9.87	Phase
0.74	41.38	56.00	PASS	-14.62	30.58	46.00	PASS	-15.42	Phase
4.54	40.89	56.00	PASS	-15.11	32.13	46.00	PASS	-13.87	Phase
4.58	41.26	56.00	PASS	-14.74	31.98	46.00	PASS	-14.02	Phase
4.81	39.39	56.00	PASS	-16.61	28.67	46.00	PASS	-17.33	Phase
6.59	43.94	60.00	PASS	-16.06	36.12	50.00	PASS	-13.88	Phase

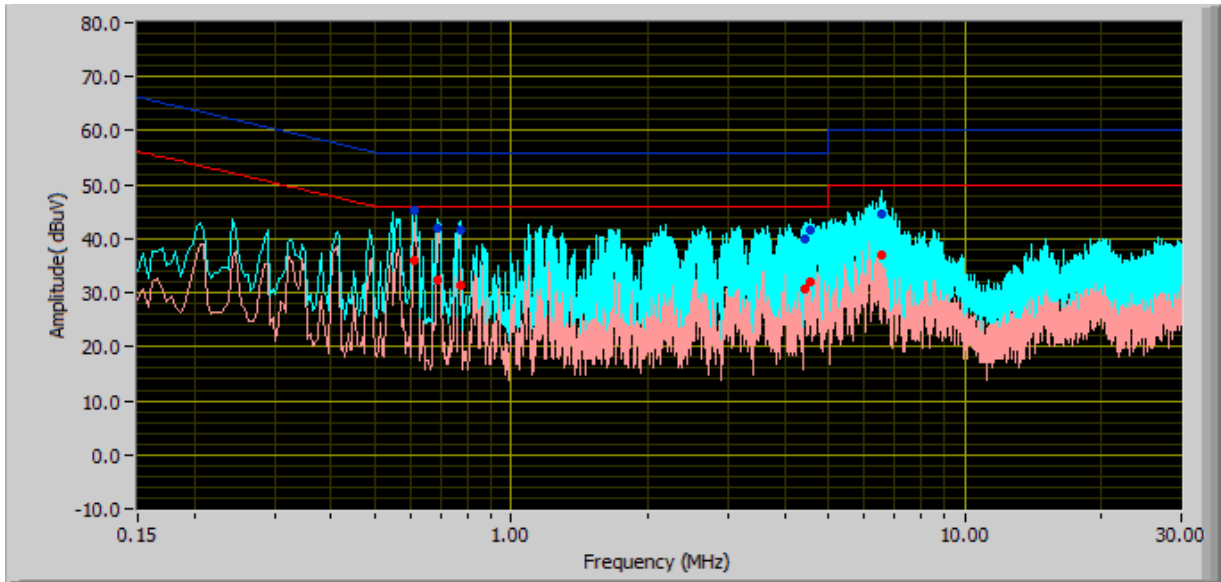

Quasi-Peak Limit

Average Limit

Neutral Line Plot at 120Vac, 60Hz

Frequency (MHz)	QP Value (dB μ V)	Class B Limit (dB)	Pass / Fail	Margin (dB)	Avg Value (dB μ V)	Class B Limit (dB)	Pass / Fail	Margin (dB)	Line
0.61	45.10	56.00	PASS	-10.90	36.04	46.00	PASS	-9.96	Neutral
0.69	41.80	56.00	PASS	-14.20	32.31	46.00	PASS	-13.69	Neutral
0.77	41.50	56.00	PASS	-14.50	31.27	46.00	PASS	-14.73	Neutral
4.46	40.09	56.00	PASS	-15.91	30.85	46.00	PASS	-15.15	Neutral
4.58	41.47	56.00	PASS	-14.53	31.98	46.00	PASS	-14.02	Neutral
6.53	44.61	60.00	PASS	-15.39	37.10	50.00	PASS	-12.90	Neutral

5.3 6dB & 99% Occupied Bandwidth

1. Conducted Measurement

EUT was set for low , mid, high channel with modulated mode and highest RF output power. The spectrum analyzer was connected to the antenna terminal.

2	Environmental Conditions	Temperature	23°C
		Relative Humidity	50%
		Atmospheric Pressure	1019mbar

3 Conducted Emissions Measurement Uncertainty

All test measurements carried out are traceable to national standards. The uncertainty of the measurement at a confidence level of approximately 95% (in the case where distributions are normal), with a coverage factor of 2, in the range 30MHz – 40GHz is ± 1.5 dB.

4 Test Date : December 19 to 31 2009
Tested By :David Zhang

Requirement(s): 47 CFR §15.247(a)(1)

Procedures: The 6dB bandwidths were measured conducted using a spectrum analyzer at low, mid, and hi channels. 6 dB Bandwidth Limit: > 500 kHz.

Results: Pass

Channel	Channel Frequency (MHz)	6 dB Channel Bandwidth (MHz)	99% Channel Bandwidth (MHz)	6 dB Occupied Bandwidth Limit (MHz)
Low	903	1.35	1.59	0.5
Mid	915	1.33	1.59	0.5
High	927	1.35	1.59	0.5

Refer to the attached plots.



SIEMIC, INC.

Accessing global markets

Title: RF Test Report of AFAR Communications, Inc
Model : AR-9010E
To: FCC 15.247:2009 & RSS-210 Issue 7 : 2007

Serial# SL09121701-AFA-001
Issue Date 01/08/2010
Page 15 of 64
www.siemec.com

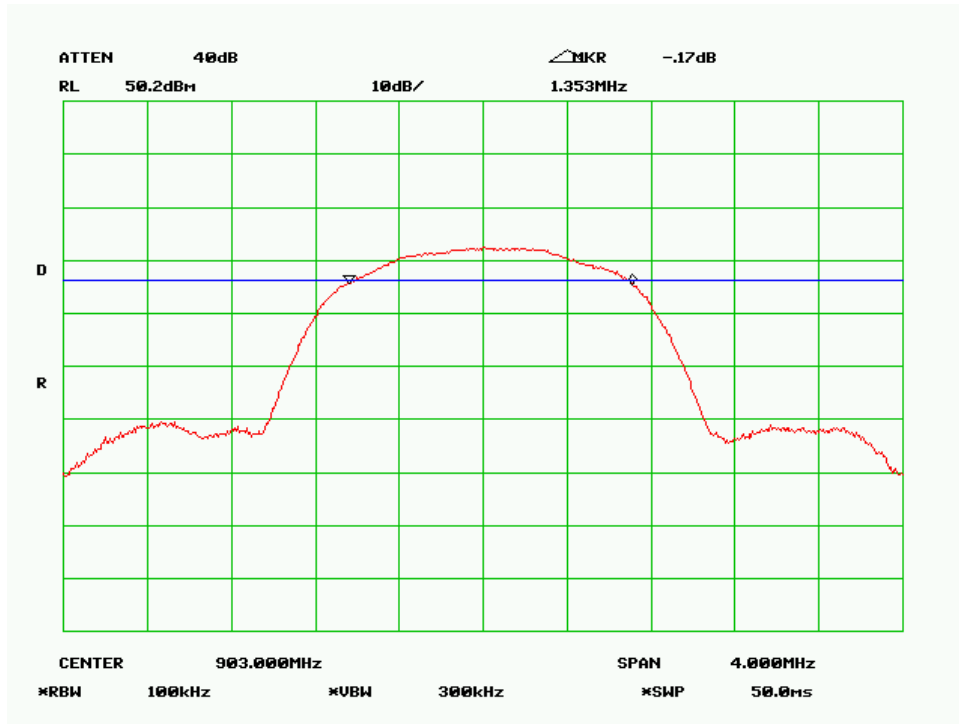

6 dB Bandwidth - Low Channel

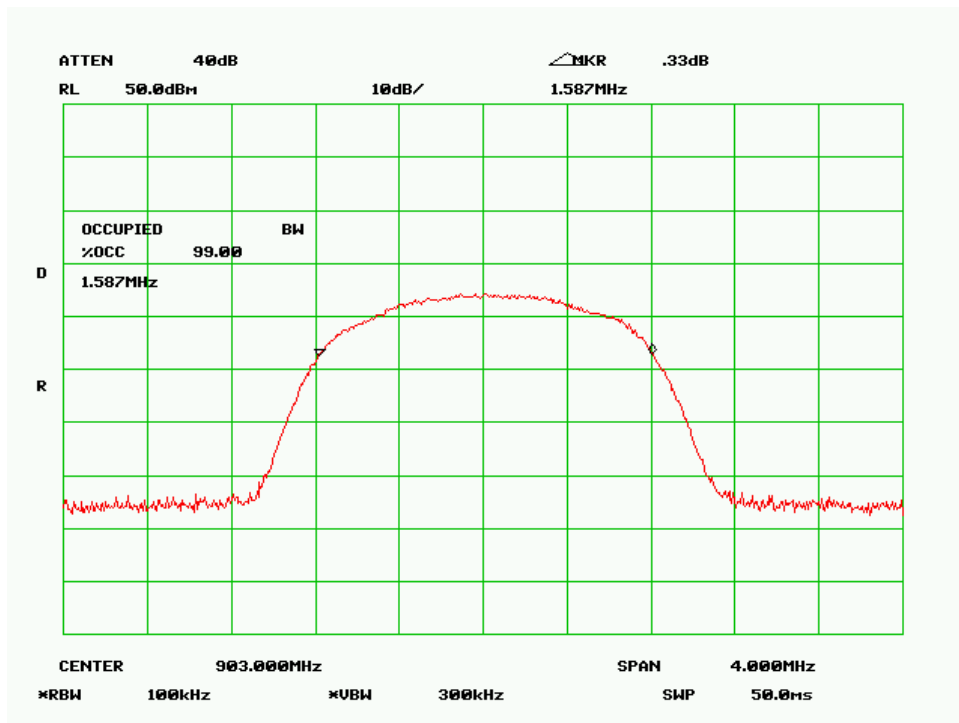

99% dB Bandwidth - Low Channel



SIEMIC, INC.

Accessing global markets

Title: RF Test Report of AFAR Communications, Inc
Model : AR-9010E
To: FCC 15.247-2009 & RSS-210 Issue 7 : 2007

Serial# SL09121701-AFA-001
Issue Date 01/08/2010
Page 16 of 64
www.sieminc.com

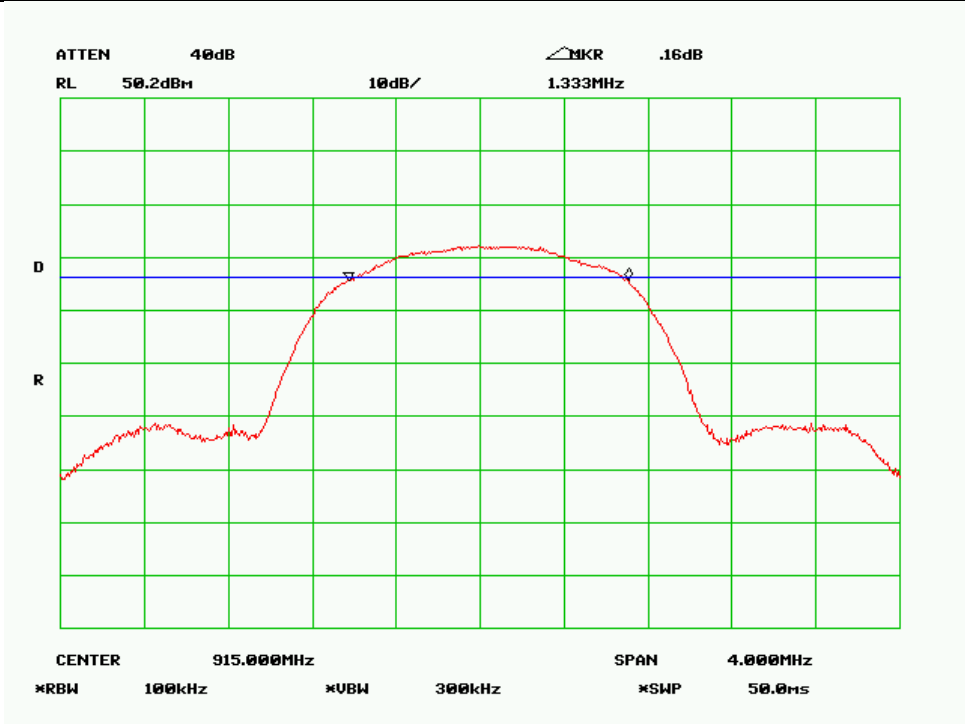

6 dB Bandwidth - Middle Channel

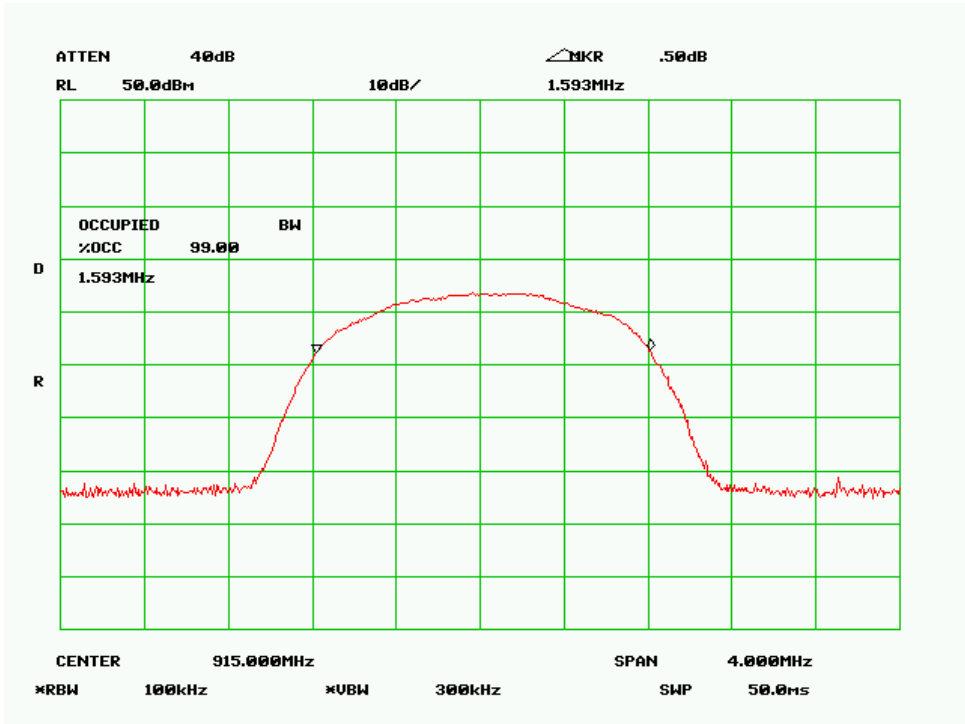

99% dB Bandwidth - Mid Channel



SIEMIC, INC.

Accessing global markets

Title: RF Test Report of AFAR Communications, Inc
Model : AR-9010E
To: FCC 15.247:2009 & RSS-210 Issue 7 : 2007

Serial# SL09121701-AFA-001
Issue Date 01/08/2010
Page 17 of 64
www.siemec.com

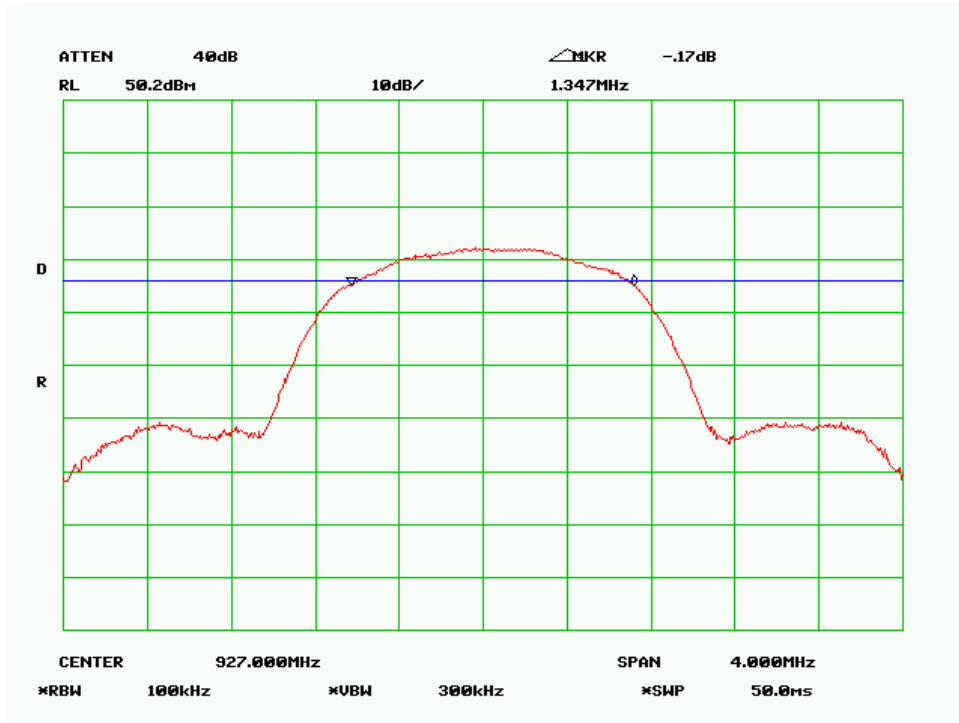

6 dB Bandwidth – High Channel

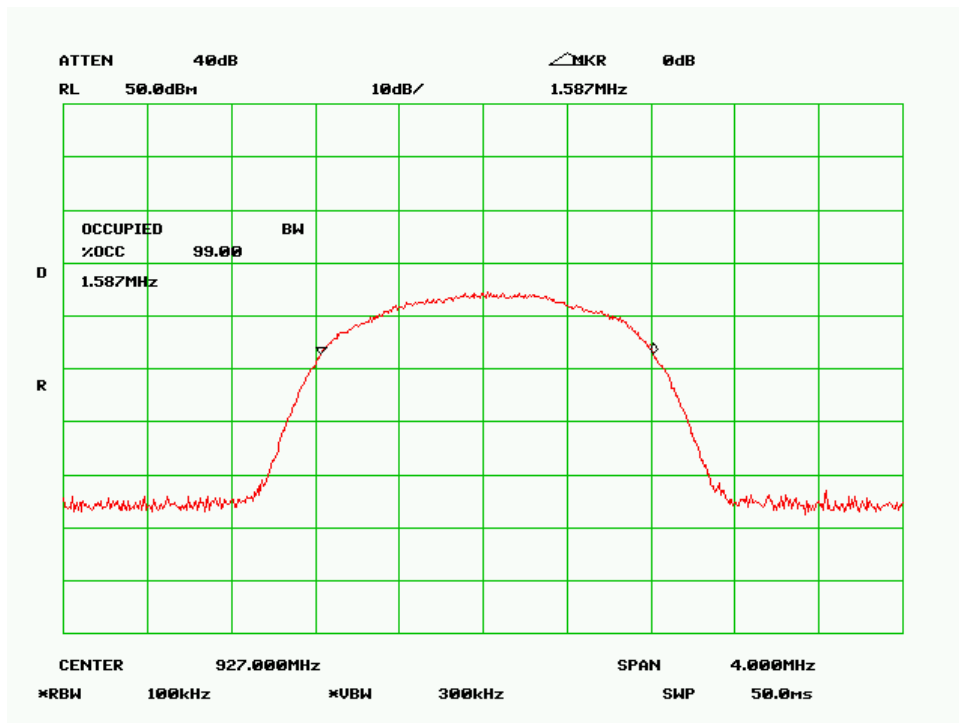

99% dB Bandwidth - High Channel

5.4 Peak Spectral Density

1. Conducted Measurement
EUT was set for low , mid, high channel with modulated mode and highest RF output power.
The spectrum analyzer was connected to the antenna terminal.
2. Conducted Emissions Measurement Uncertainty
All test measurements carried out are traceable to national standards. The uncertainty of the measurement at a confidence level of approximately 95% (in the case where distributions are normal), with a coverage factor of 2, in the range 30MHz – 40GHz is ± 1.5 dB.
3. Environmental Conditions

Temperature	23°C
Relative Humidity	50%
Atmospheric Pressure	1019mbar
4. Test Date : December 19 to 31 2009
Tested By :David Zhang

Standard Requirement: 47 CFR §15.247(e)

For digitally modulated systems, the power spectral density conducted from the intentional radiator to the antenna shall not be greater than 8 dBm in any 3 kHz band during any time interval of continuous transmission

Procedures: The Peak Spectral density measurement was taken conducted using a spectrum analyzer.

RBW=3KHz, VBW > RBW, Sweep time to SPAN/RBW (sec)

Test Result: Pass

Channel	Channel Frequency (MHz)	Peak Spectral Density Limit (dBm/3KHz)	Peak Spectral Density (dBm/3KHz)
Low	903	8	5.03
Mid	915	8	4.37
High	927	8	4.53

Refer to the attached plots.



SIEMIC, INC.

Accessing global markets

Title: RF Test Report of AFAR Communications, Inc
Model : AR-9010E
To: FCC 15.247:2009 & RSS-210 Issue 7 : 2007

Serial# SL09121701-AFA-001
Issue Date 01/08/2010
Page 19 of 64
www.sieminc.com

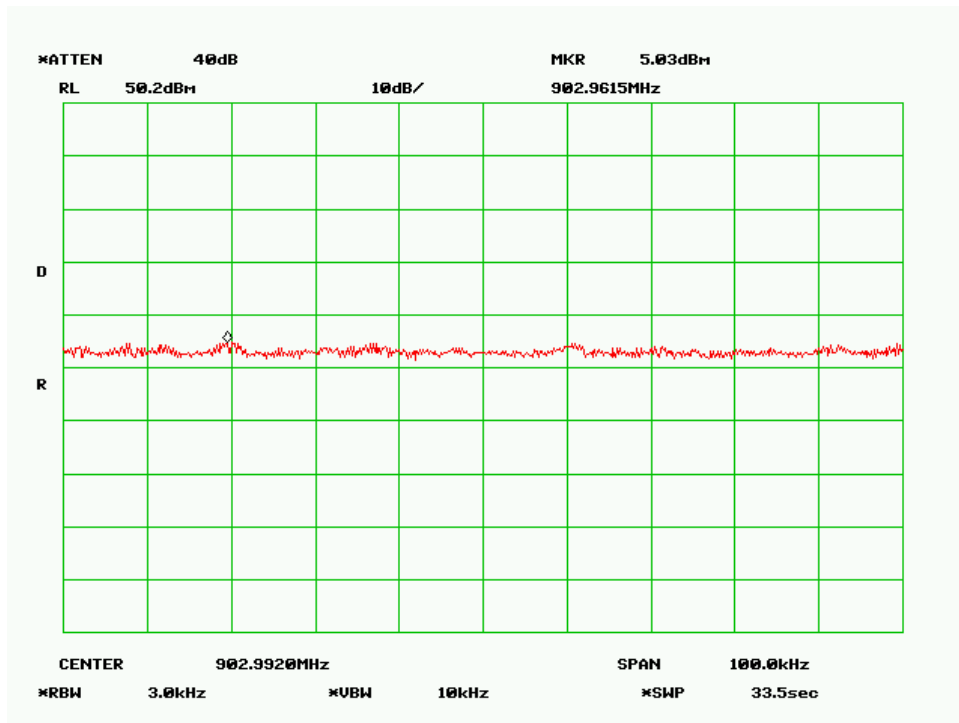
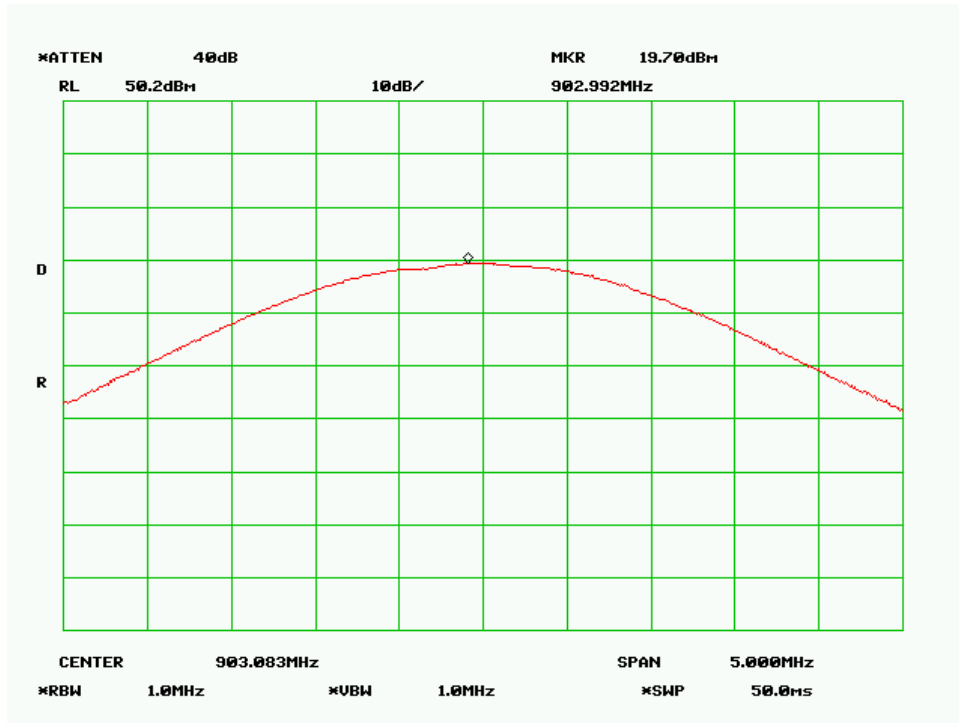

PSD Low Channel



SIEMIC, INC.

Accessing global markets

Title: RF Test Report of AFAR Communications, Inc
Model : AR-9010E
To: FCC 15.247:2009 & RSS-210 Issue 7 : 2007

Serial# SL09121701-AFA-001
Issue Date 01/08/2010
Page 20 of 64
www.sieminc.com

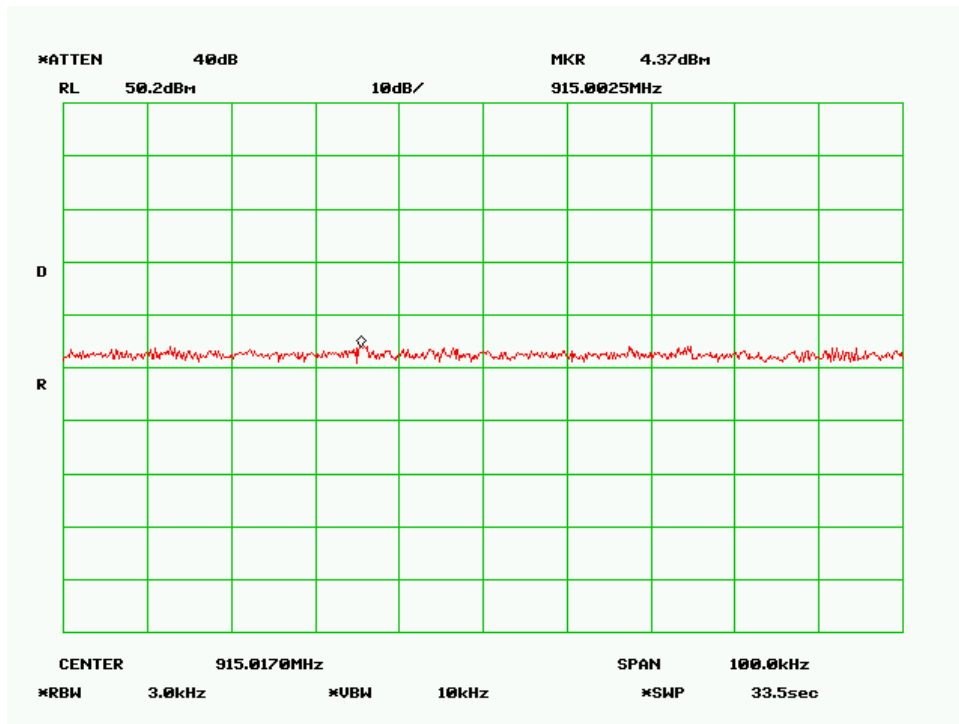
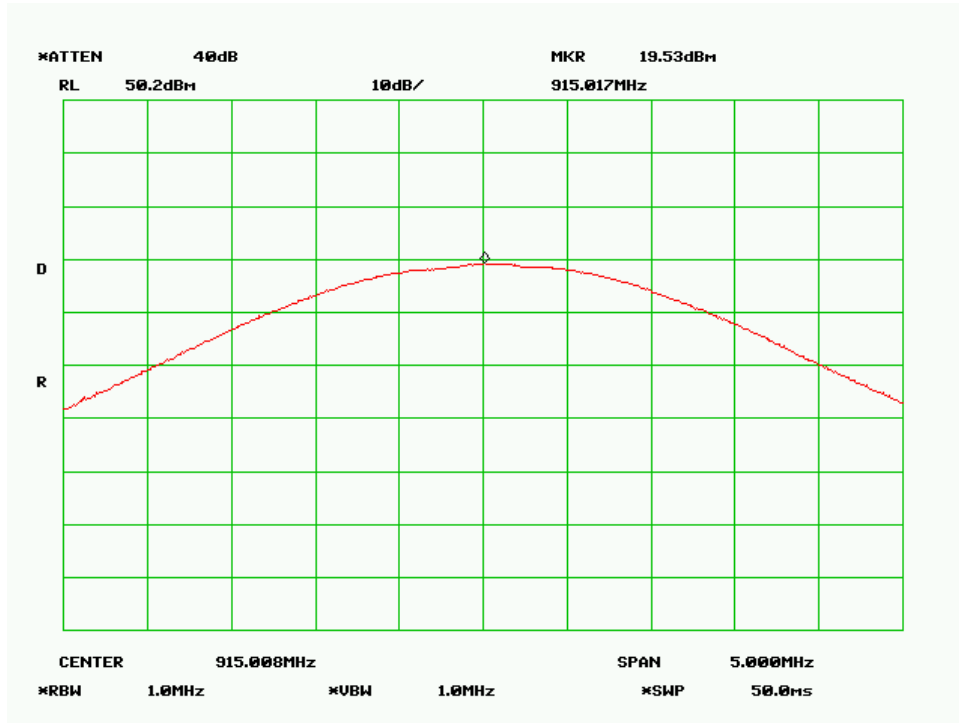

PSD Mid Channel



SIEMIC, INC.

Accessing global markets

Title: RF Test Report of AFAR Communications, Inc
Model : AR-9010E
To: FCC 15.247:2009 & RSS-210 Issue 7 : 2007

Serial# SL09121701-AFA-001
Issue Date 01/08/2010
Page 21 of 64
www.sieminc.com

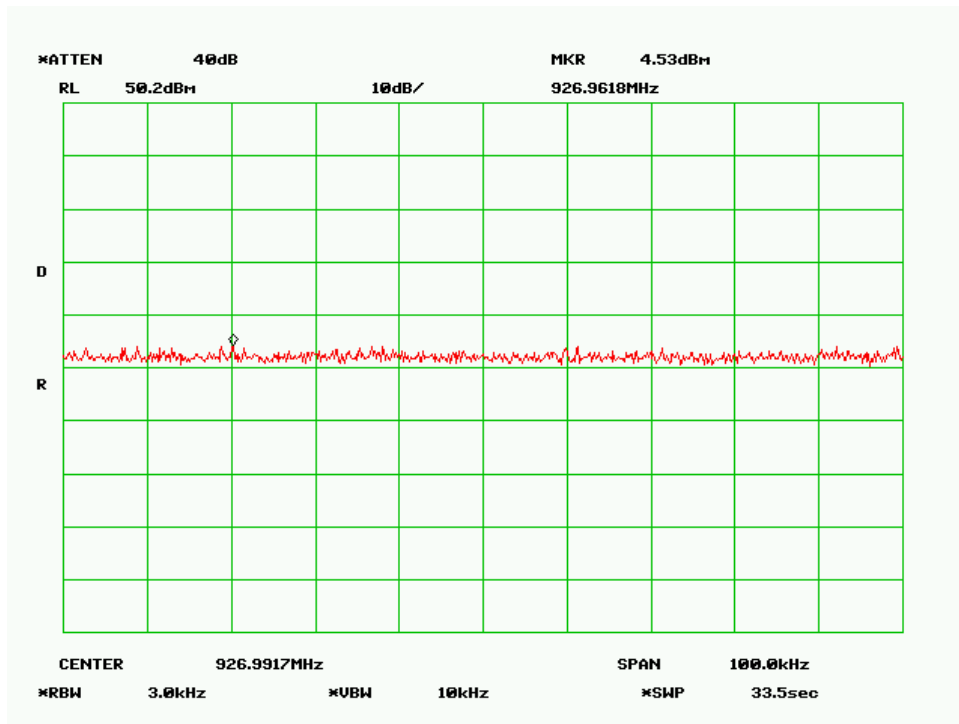
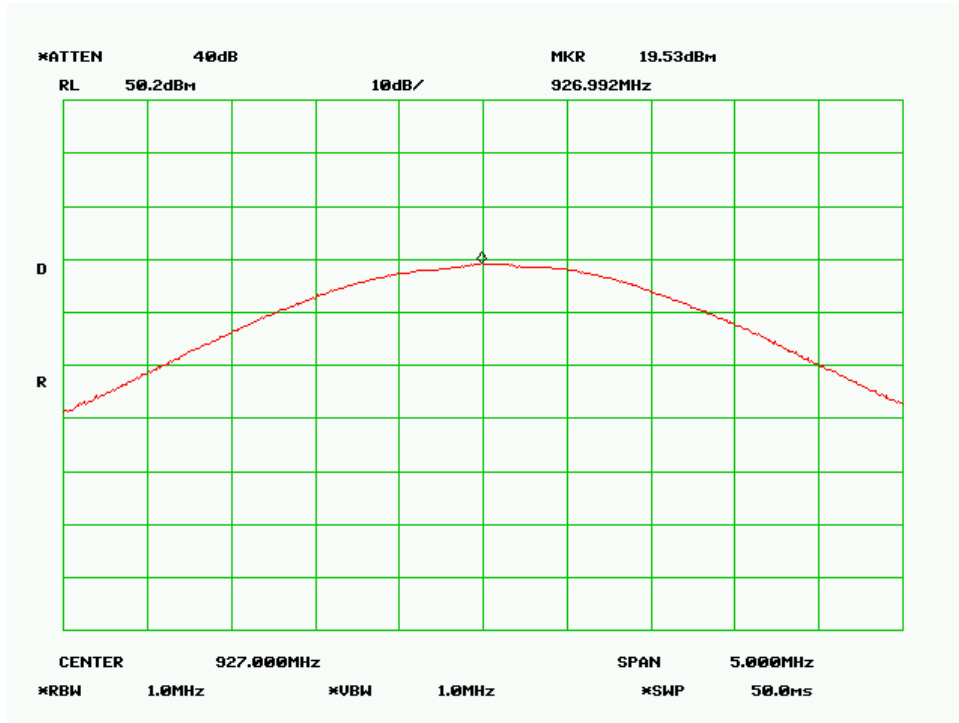

PSD High Channel

5.10 Peak Output Power

1. Conducted Measurement
EUT was set for low , mid, high channel with modulated mode and highest RF output power. The spectrum analyzer was connected to the antenna terminal.
2. Conducted Emissions Measurement Uncertainty
All test measurements carried out are traceable to national standards. The uncertainty of the measurement at a confidence level of approximately 95% (in the case where distributions are normal), with a coverage factor of 2, in the range 30MHz – 40GHz is ± 1.5 dB.
3. Environmental Conditions

Temperature	23°C
Relative Humidity	50%
Atmospheric Pressure	1019mbar
4. Test Date : December 19 to 31 2009
Tested By :David Zhang

Standard Requirement: 47 CFR §15.247(b)

Procedures: The peak output power was measured conducted using a spectrum analyzer at low, mid, and hi channels. Peak detector was set to measure the power output. The power is converted from watt to dBm, therefore, 1 watt = 30 dBm. The highest antenna gain that will be used is 15 dBi.

Test Result: Pass

Antenna Gain	Channel	Channel Frequency (MHz)	Peak Output Power Limit (dBm)	Measured Output Power(dBm)
5dBi	Low	903	30	26.37
5dBi	Mid	915	30	26.03
5dBi	High	927	30	25.83
15dBi	Low	903	21	19.87
15dBi	Mid	915	21	20.03
15dBi	High	927	21	19.53



SIEMIC, INC.

Accessing global markets

Title: RF Test Report of AFAR Communications, Inc
Model : AR-9010E
To: FCC 15.247:2009 & RSS-210 Issue 7 : 2007

Serial# SL09121701-AFA-001
Issue Date 01/08/2010
Page 23 of 64
www.siemec.com



Output Power Low Channel (Antenna Gain 5dBi)

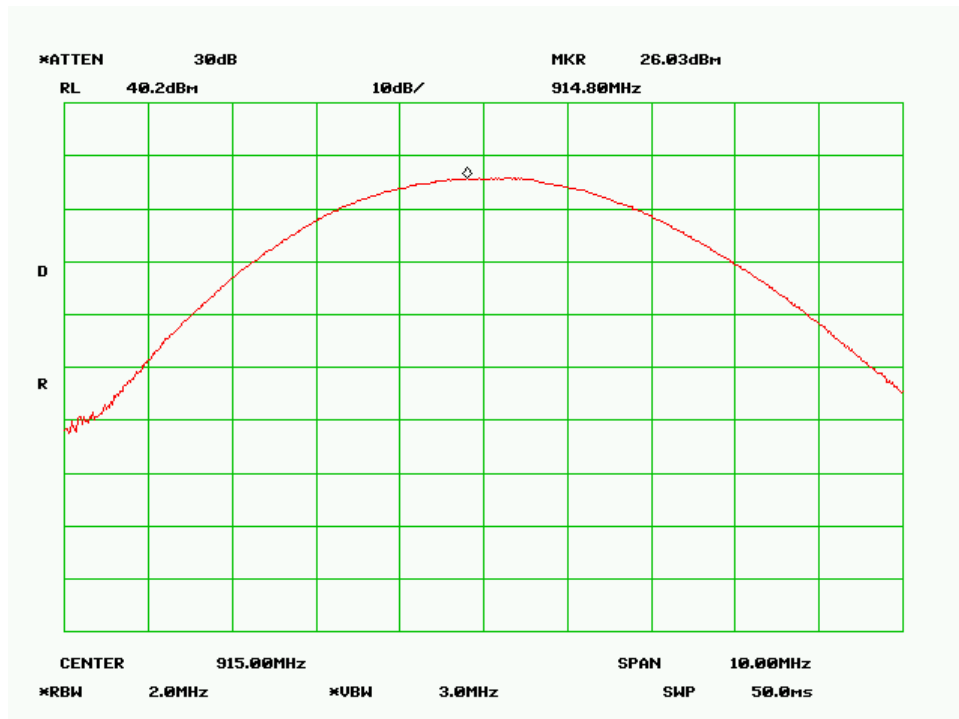

Output Power Middle Channel (Antenna Gain 5dBi)



SIEMIC, INC.

Accessing global markets

Title: RF Test Report of AFAR Communications, Inc
To: Model : AR-9010E
FCC 15.247:2009 & RSS-210 Issue 7 : 2007

Serial# SL09121701-AFA-001
Issue Date 01/08/2010
Page 24 of 64
www.sieminc.com

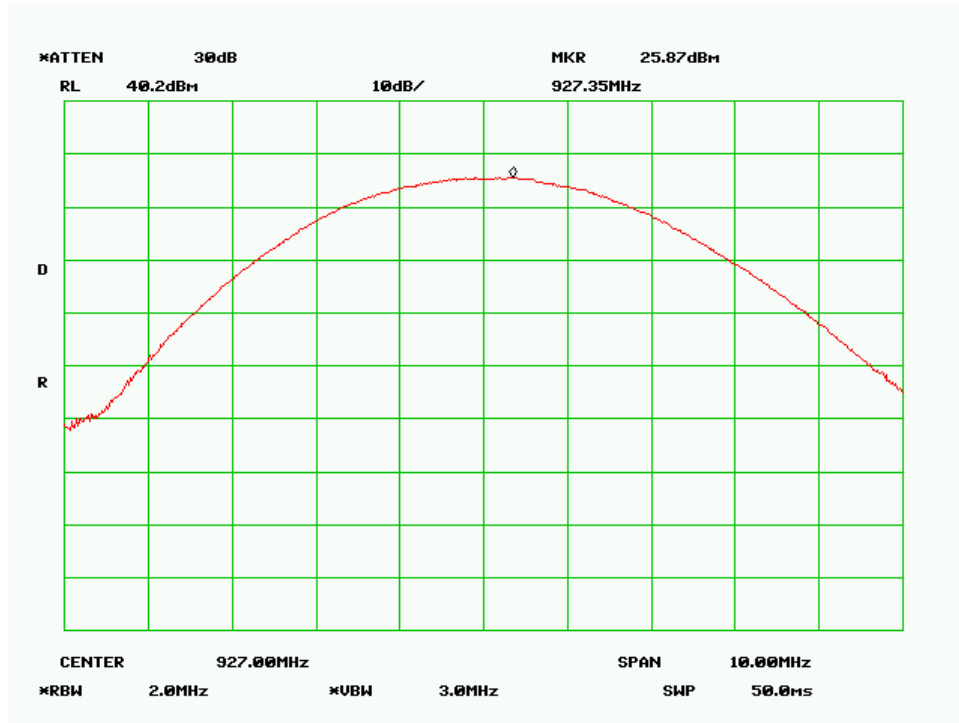

Output Power High Channel (Antenna Gain 5dBi)



Output Power Low Channel (Antenna Gain 15dBi)



SIEMIC, INC.
Accessing global markets

Title: RF Test Report of AFAR Communications, Inc
Model : AR-9010E
To: FCC 15.247-2009 & RSS-210 Issue 7 : 2007

Serial# SL09121701-AFA-001
Issue Date 01/08/2010
Page 25 of 64
www.sieminc.com

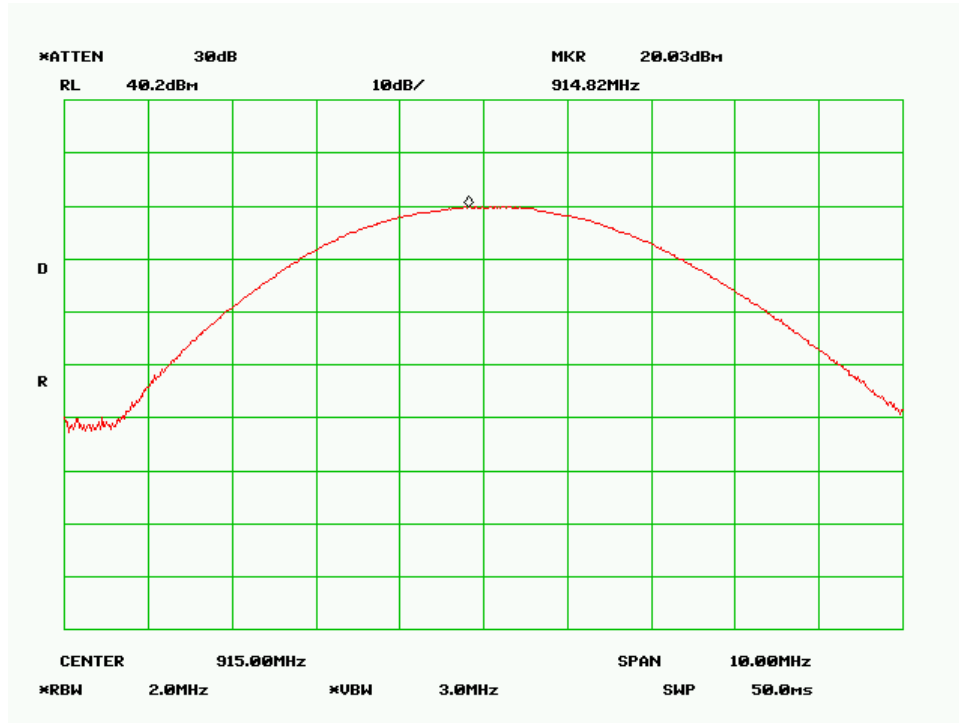

Output Power Middle Channel (Antenna Gain 15dBi)

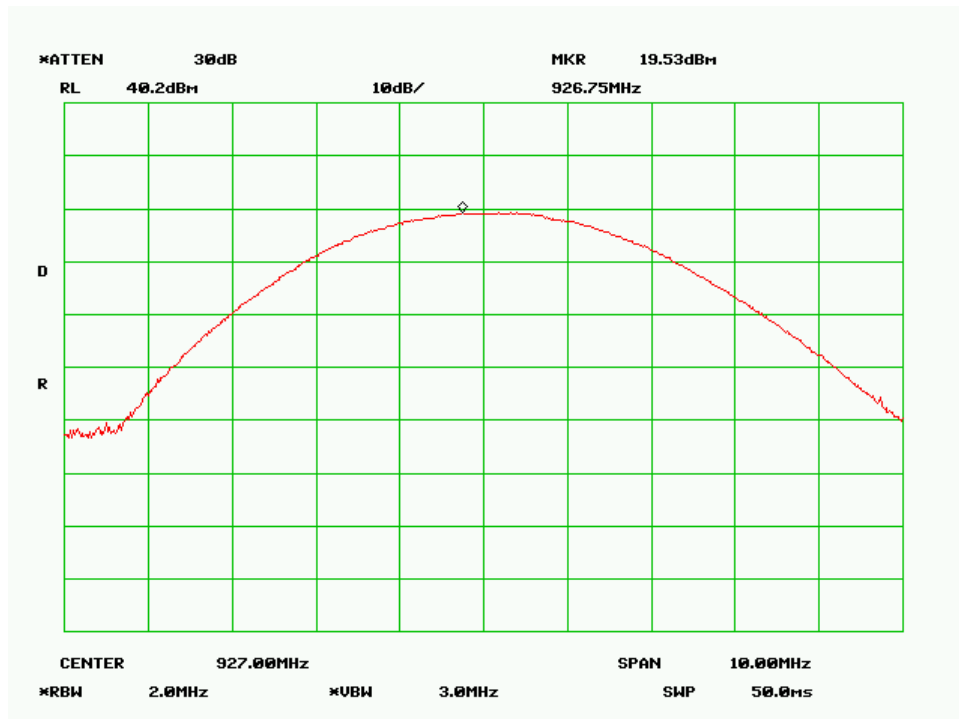

Output Power High Channel (Antenna Gain 15dBi)

5.10 Antenna Port Emission

1. Conducted Measurement
EUT was set for low , mid, high channel with modulated mode and highest RF output power.
The spectrum analyzer was connected to the antenna terminal.
2. Conducted Emissions Measurement Uncertainty
All test measurements carried out are traceable to national standards. The uncertainty of the measurement at a confidence level of approximately 95% (in the case where distributions are normal), with a coverage factor of 2, in the range 30MHz – 40GHz is $\pm 1.5\text{dB}$.
3. Environmental Conditions
Temperature 23°C
Relative Humidity 50%
Atmospheric Pressure 1019mbar
4. Test Date : December 19 to 31 2009
Tested By :David Zhang

Standard Requirement: 47 CFR §15.247(d)

Procedures: The conducted spurious emissions were measured conducted using a spectrum analyzer at low, mid, and hi channels. The limit was determined by attenuating 20 dB of the RF peak power output

Test Result: Pass



SIEMIC, INC.

Accessing global markets

Title: RF Test Report of AFAR Communications, Inc
Model : AR-9010E
To: FCC 15.247:2009 & RSS-210 Issue 7 : 2007

Serial# SL09121701-AFA-001
Issue Date 01/08/2010
Page 27 of 64
www.sieminc.com

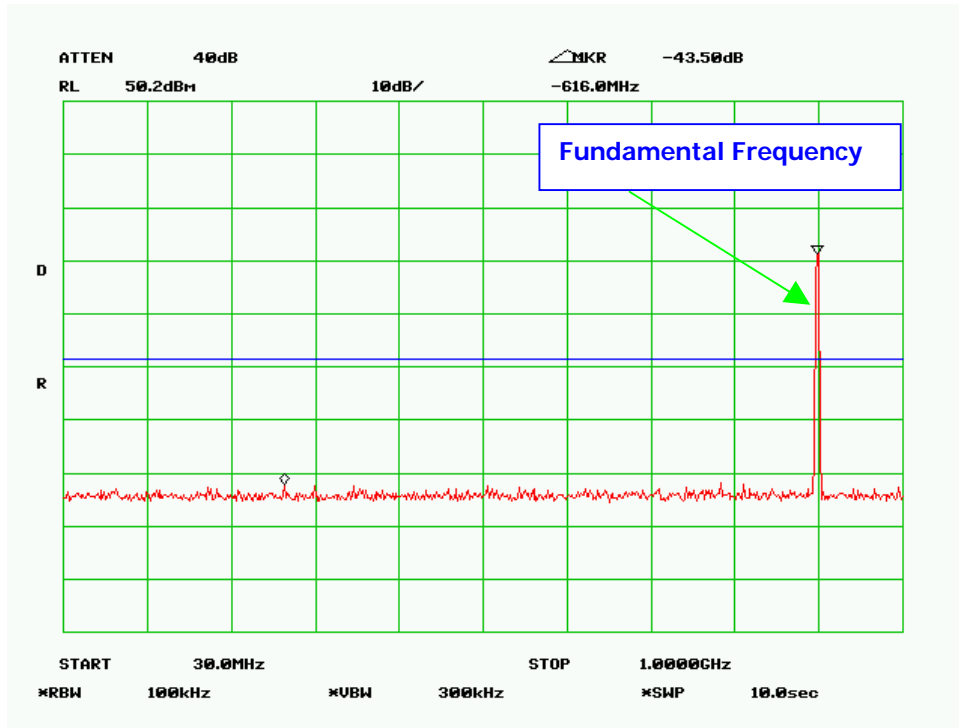

Low Channel -1

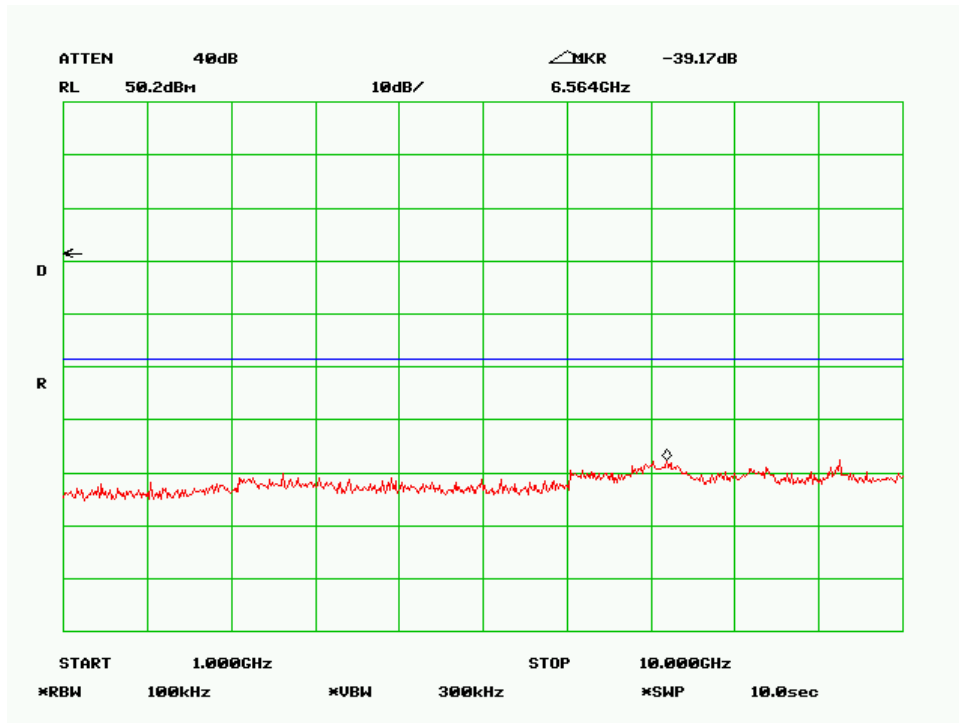

Low Channel -2

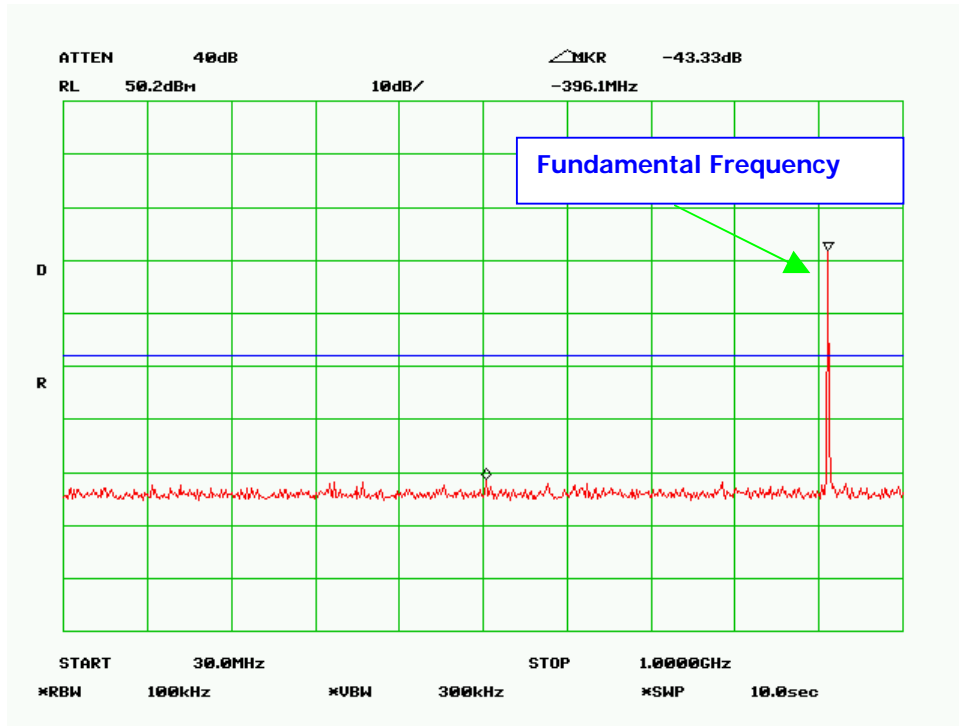

Mid Channel -1

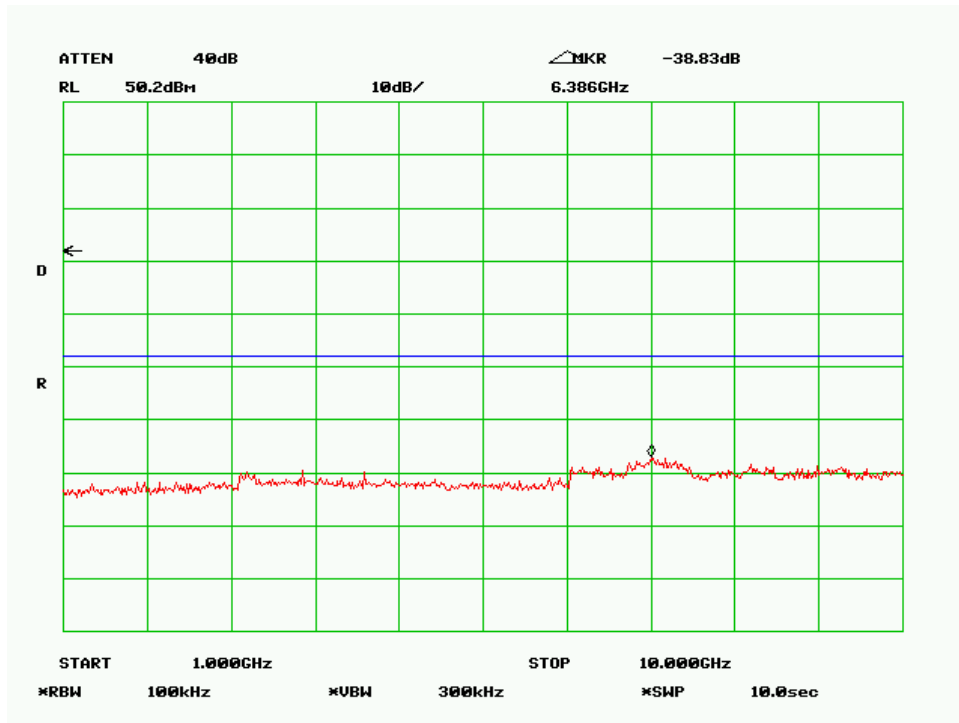

Mid Channel -2



SIEMIC, INC.
Accessing global markets

Title: RF Test Report of AFAR Communications, Inc
Model : AR-9010E
To: FCC 15.247:2009 & RSS-210 Issue 7 : 2007

Serial# SL09121701-AFA-001
Issue Date 01/08/2010
Page 29 of 64
www.sieminc.com

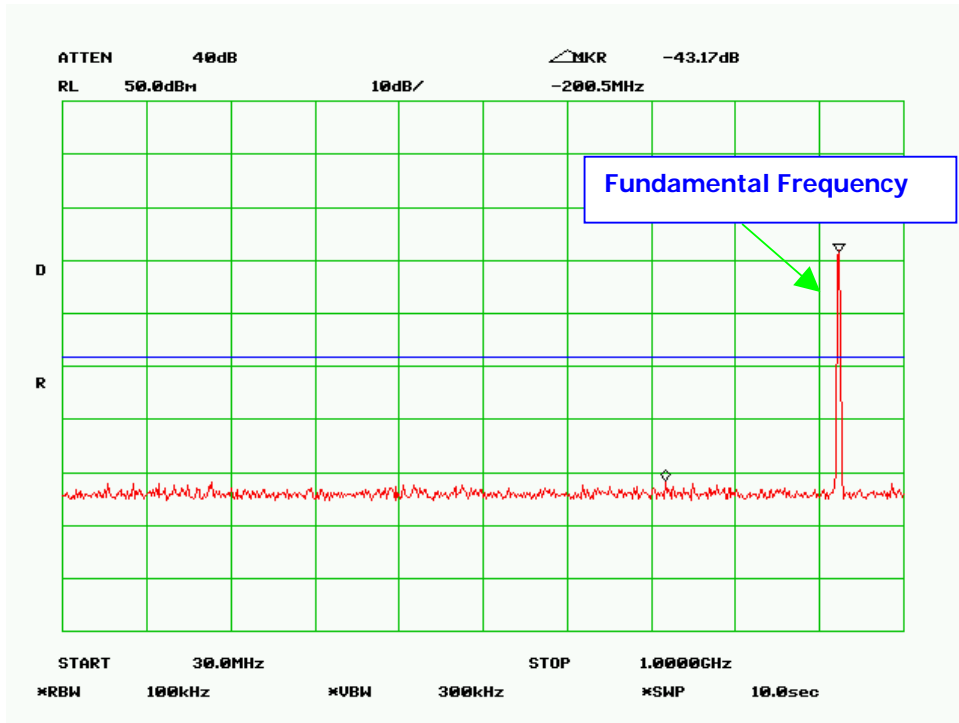

High Channel -1

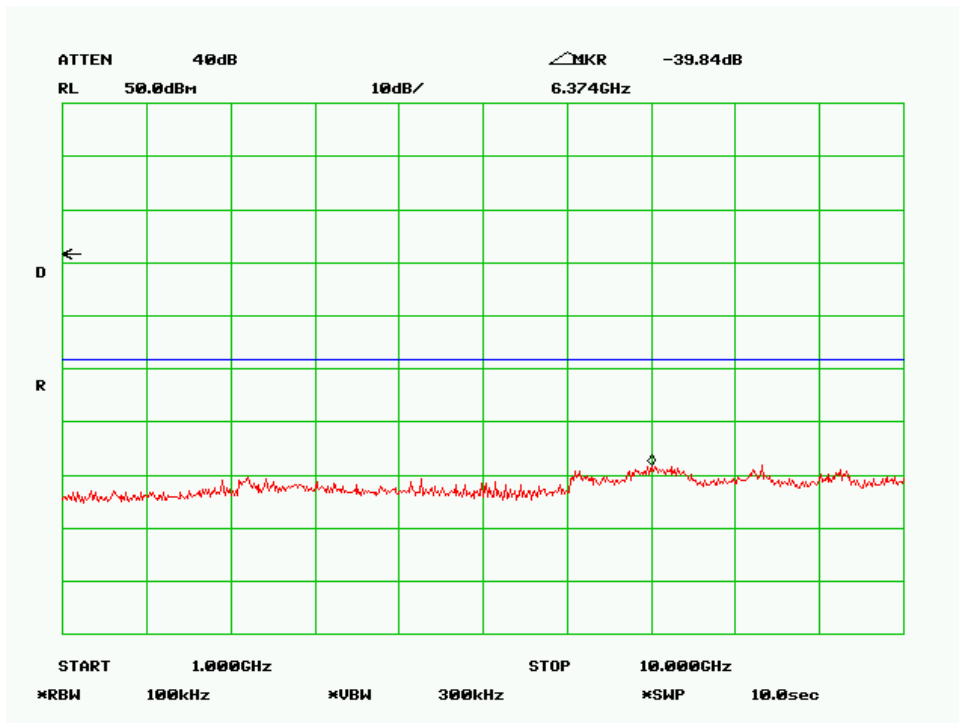

High Channel -2

5.10 Radiated Spurious Emission < 1GHz

1. All possible modes of operation were investigated. Only the 6 worst case emissions measured, using the correct CISPR detectors, are reported. All other emissions were relatively insignificant.
2. A "-ve" margin indicates a PASS as it refers to the margin present below the limit line at the particular frequency.
3. Radiated Emissions Measurement Uncertainty
All test measurements carried out are traceable to national standards. The uncertainty of the measurement at a confidence level of approximately 95% (in the case where distributions are normal), with a coverage factor of 2, in the range 30MHz – 1GHz (QP only @ 3m & 10m) is +6.0dB (for EUTs < 0.5m X 0.5m X 0.5m).

4	Environmental Conditions	Temperature	23°C
		Relative Humidity	50%
		Atmospheric Pressure	1019mbar

Test Date : December 19 to 31 2009

Tested By :David Zhang

Standard Requirement: 47 CFR §15.247(d)

Procedures: Radiated emissions were measured according to ANSI C63.4. The EUT was set to transmit at the highest output power. The EUT was set to transmit at mid channel. Note that setting the channel other than middle, the spurious emissions are the same.

The limit is converted from microvolts/meter to decibel microvolts/meter.

Sample Calculation: Corrected Amplitude = Raw Amplitude (dBμV/m) + ACF (dB) + Cable Loss (dB)

Test Result: Pass

Radiated Emission Plot – Antenna 5dBi

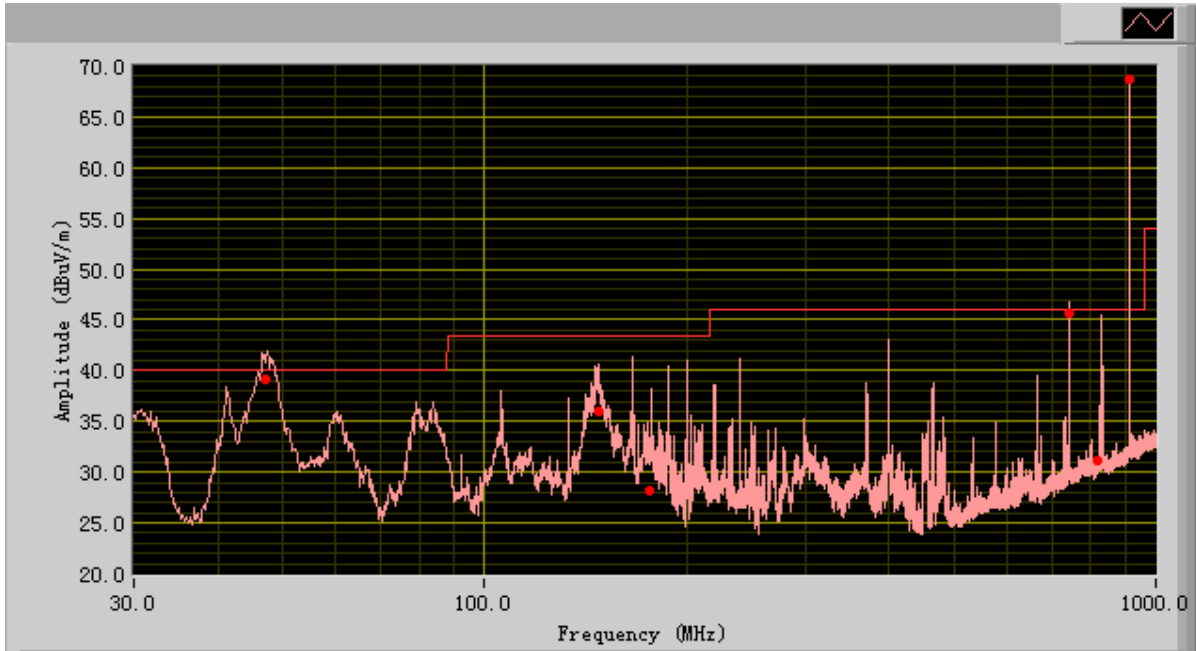

Limit

30MHz ~1000MHz

Frequency (MHz)	Quasi-Peak (dB μ V/m)	Antenna height (cm)	Polarity	Turntable position (deg)	Limit (dB μ V/m)	Margin (dB)
47.51	39.17	358	V	111	40	-0.83
147.96	27.50	233	H	176	43.5	-16.00
176.73	28.39	119	H	174	43.5	-15.11
47.50	38.91	359	V	139	40	-1.09
742.00	45.74	115	V	257	46	-0.26
824.72	30.99	33	V	108	46	-15.01

Note:

Emission at 915MHz is normal fundamental signal

Radiated Emission Plot – Antenna 15dBi

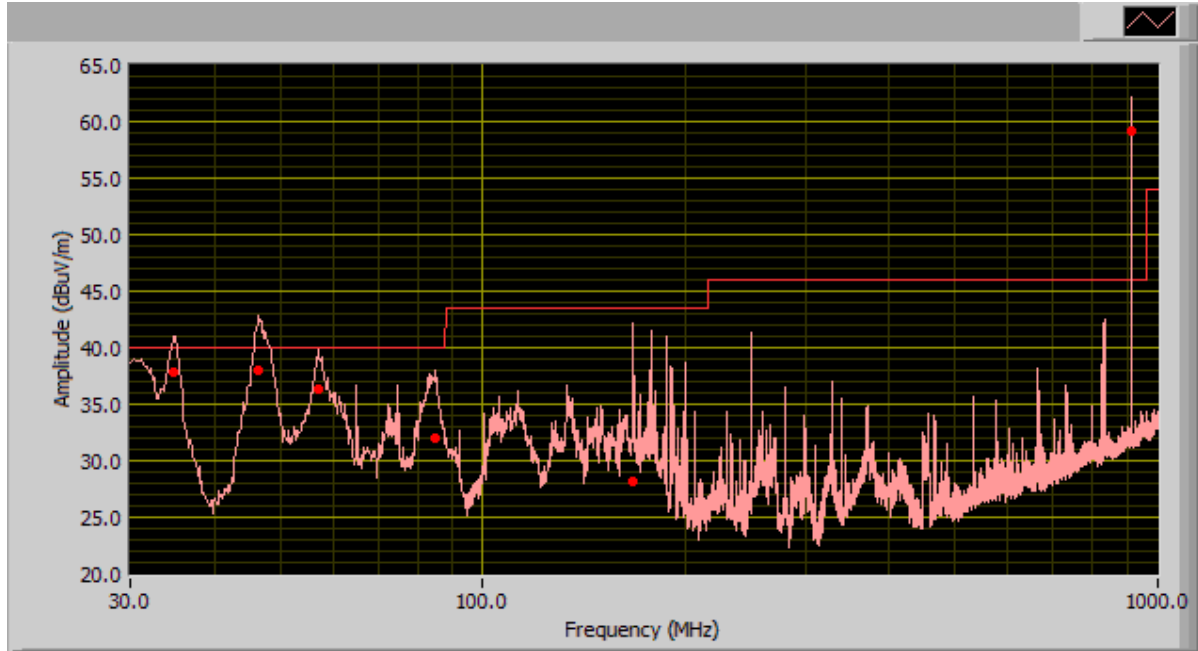

Limit

30MHz ~1000MHz

Frequency (MHz)	Quasi-Peak (dB μ V/m)	Antenna height (cm)	Polarity	Turntable position (deg)	Limit (dB μ V/m)	Margin (dB)
34.94	37.90	171	V	100	40	-2.10
46.50	37.99	359	V	108	40	-2.01
56.99	36.27	264	V	105	40	-3.73
84.99	31.94	240	V	99	40	-8.06
167.27	28.15	262	H	123	43.5	-15.35
914.94	59.17	131	V	134	46	13.17

Note:

Emission at 915MHz is normal fundamental signal

5.10 Radiated Spurious Emissions > 1GHz & Band Edge

1. All possible modes of operation were investigated. Only the 6 worst case emissions measured, using the correct CISPR detectors, are reported. All other emissions were relatively insignificant.
2. A "-ve" margin indicates a PASS as it refers to the margin present below the limit line at the particular frequency.
3. Radiated Emissions Measurement Uncertainty
All test measurements carried out are traceable to national standards. The uncertainty of the measurement at a confidence level of approximately 95% (in the case where distributions are normal), with a coverage factor of 2, in the range 1GHz – 40GH is +6.0dB (for EUTs < 0.5m X 0.5m X 0.5m).
4.

Environmental Conditions	Temperature	23°C
	Relative Humidity	50%
	Atmospheric Pressure	1019mbar

Test Date : December 19 to 31 2009
 Tested By :David Zhang

Standard Requirement: 47 CFR §15.247(d)

Procedures: Equipment was setup in a semi-anechoic chamber. For measurements above 1 GHz an average measurement was taken with a 10Hz video bandwidth. The EUT was tested at low, mid and high with the highest output power. An emission was scan up to 10th harmonic of the operating frequency.

Sample Calculation:

EUT Field Strength = Raw Amplitude (dBμV/m) – Amplifier Gain (dB) + Antenna Factor (dB) + Cable Loss (dB) + Filter Attenuation (dB, if used)

Test Result: Pass

Antenna Gain 5dBi

Low Channel @ 903MHz @ 3 Meter

Frequency (GHz)	Reading (dBuV/m)	Direction (degree)	Height (m)	Polarity (H/V)	Antenna Loss (dB)	Cable Loss (dB)	Amplifier (dB)	Corrected Reading (dBuV/m)	15.247/15.209 Limit @ 3m (dBuV/m)	Margin (dBuV/m)	Detector (pk/avg)
1.806	56.23	142	126	V	25.7	2.16	31.98	52.11	74	-21.89	Peak
1.806	36.48	308	100	H	25.7	2.16	31.98	32.36	74	-41.64	Peak
1.806	55.54	142	126	V	25.7	2.16	31.98	51.42	54	-2.58	Ave
1.806	37.17	207	100	H	25.7	2.16	31.98	33.05	54	-20.95	Ave
2.709	46.08	226	141	V	28.8	2.72	32.08	45.52	74	-28.48	Peak
2.709	44.01	88	100	H	28.8	2.72	32.08	43.45	74	-30.55	Peak
2.709	47.46	180	100	V	28.8	2.72	32.08	46.9	54	-7.1	Ave
2.709	42.09	88	100	H	28.8	2.72	32.08	41.53	54	-12.47	Ave
3.612	28.09	14	100	V	31.2	3.435	32.37	30.355	74	-43.65	Peak
3.612	31.59	242	100	H	31.2	3.435	32.37	33.855	74	-40.15	Peak
3.612	36.26	14	100	V	31.2	3.435	32.37	38.525	54	-15.48	Ave
3.612	30.24	242	100	H	31.2	3.435	32.37	32.505	54	-21.5	Ave
4.515	34.02	202	100	V	32.2	4.125	32.49	37.855	74	-36.15	Peak
4.515	32.08	118	100	H	32.2	4.125	32.49	35.915	74	-38.09	Peak
4.515	33.63	202	100	V	32.2	4.125	32.49	37.465	54	-16.54	Ave
4.515	32.1	118	100	H	32.2	4.125	32.49	35.935	54	-18.07	Ave

Note: Emission was scanned up to 10GHz; no emissions were detected above the noise floor which was at least 20dB below the specification limit

Mid Channel @ 915MHz @ 3 Meter

Frequency (GHz)	Reading (dBuV/m)	Direction (degree)	Height (m)	Polarity (H/V)	Antenna Loss (dB)	Cable Loss (dB)	Amplifier (dB)	Corrected Reading (dBuV/m)	15.247/15.209 Limit @ 3m (dBuV/m)	Margin (dBuV/m)	Detector (pk/avg)
1.830	47.80	204	100	V	25.7	2.16	31.98	43.68	74	-30.32	Peak
1.830	40.55	240	100	H	25.7	2.16	31.98	36.43	74	-37.57	Peak
1.830	47.08	207	100	V	25.7	2.16	31.98	42.96	54	-11.04	Ave
1.830	40.89	240	100	H	25.7	2.16	31.98	36.77	54	-17.23	Ave
2.745	48.68	170	100	V	28.8	2.72	32.08	48.12	74	-25.88	Peak
2.745	46.98	180	100	H	28.8	2.72	32.08	46.42	74	-27.58	Peak
2.745	46.30	170	100	V	28.8	2.72	32.08	45.74	54	-8.26	Ave
2.745	47.60	180	100	H	28.8	2.72	32.08	47.04	54	-6.96	Ave
3.660	47.75	222	100	V	31.2	3.435	32.37	50.015	74	-23.99	Peak
3.660	49.00	193	100	H	31.2	3.435	32.37	51.265	74	-22.74	Peak
3.660	48.10	222	100	V	31.2	3.435	32.37	50.365	54	-3.64	Ave
3.660	49.16	192	100	H	31.2	3.435	32.37	51.425	54	-2.58	Ave
4.575	26.48	184	100	V	32.2	4.125	32.49	30.315	74	-43.69	Peak
4.575	26.95	131	100	H	32.2	4.125	32.49	30.785	74	-43.22	Peak
4.575	30.42	131	100	V	32.2	4.125	32.49	34.255	54	-19.75	Ave
4.574	30.23	184	100	H	32.2	4.125	32.49	34.065	54	-19.94	Ave

Note: Emission was scanned up to 10GHz; no emissions were detected above the noise floor which was at least 20dB below the specification limit

**SIEMIC, INC.**

Accessing global markets

Title: RF Test Report of AFAR Communications, Inc
 To: Model : AR-9010E
 FCC 15.247:2009 & RSS-210 Issue 7 : 2007

Serial# SL09121701-AFA-001
 Issue Date 01/08/2010
 Page 35 of 64
 www.sieminc.com

High Channel @ 927MHz @ 3 Meter

Frequency (GHz)	Reading (dBuV/m)	Direction (degree)	Height (m)	Polarity (H/V)	Antenna Loss (dB)	Cable Loss (dB)	Amplifier (dB)	Corrected Reading (dBuV/m)	15.247/15.209 Limit @ 3m (dBuV/m)	Margin (dBuV/m)	Detector (pk/avg)
1.854	52.46	182	124	V	25.7	2.16	31.98	48.34	74	-25.66	Peak
1.854	37.92	143	120	H	25.7	2.16	31.98	33.8	74	-40.2	Peak
1.854	53.13	182	124	V	25.7	2.16	31.98	49.01	54	-4.99	Ave
1.854	38.88	143	120	H	25.7	2.16	31.98	34.76	54	-19.24	Ave
2.781	40.94	285	119	V	28.8	2.72	32.08	40.38	74	-33.62	Peak
2.781	38.21	214	120	H	28.8	2.72	32.08	37.65	74	-36.35	Peak
2.781	42.18	285	119	V	28.8	2.72	32.08	41.62	54	-12.38	Ave
2.781	39.32	214	120	H	28.8	2.72	32.08	38.76	54	-15.24	Ave
3.708	33.63	184	175	V	31.2	3.435	32.37	35.895	74	-38.11	Peak
3.708	29.23	309	100	H	31.2	3.435	32.37	31.495	74	-42.51	Peak
3.708	34.70	184	175	V	31.2	3.435	32.37	36.965	54	-17.04	Ave
3.708	29.60	309	100	H	31.2	3.435	32.37	31.865	54	-22.14	Ave
4.635	25.93	218	100	V	32.2	4.125	32.49	29.765	74	-44.24	Peak
4.635	26.04	196	100	H	32.2	4.125	32.49	29.875	74	-44.13	Peak
4.635	27.34	218	100	V	32.2	4.125	32.49	31.175	54	-22.83	Ave
4.635	27.50	196	100	H	32.2	4.125	32.49	31.335	54	-22.67	Ave

Note: Emission was scanned up to 10GHz; no emissions were detected above the noise floor which was at least 20dB below the specification limit

Antenna Gain 15dBi

Low Channel @ 903MHz @ 3 Meter

Frequency (GHz)	Reading (dBuV/m)	Direction (degree)	Height (m)	Polarity (H/V)	Antenna Loss (dB)	Cable Loss (dB)	Amplifier (dB)	Corrected Reading (dBuV/m)	15.247/15.209 Limit @ 3m (dBuV/m)	Margin (dBuV/m)	Detector (pk/avg)
1.806	45.37	178	144	V	25.7	2.16	31.98	41.25	74	-32.75	Peak
1.806	29.00	100	100	H	25.7	2.16	31.98	24.88	74	-49.12	Peak
1.806	46.14	178	144	V	25.7	2.16	31.98	42.02	54	-11.98	Ave
1.806	29.60	100	100	H	25.7	2.16	31.98	25.48	54	-28.52	Ave
2.709	30.10	213	100	V	28.8	2.72	32.08	29.54	74	-44.46	Peak
2.709	27.75	359	100	H	28.8	2.72	32.08	27.19	74	-46.81	Peak
2.709	29.36	213	100	V	28.8	2.72	32.08	28.8	54	-25.2	Ave
2.709	29.23	359	100	H	28.8	2.72	32.08	28.67	54	-25.33	Ave
3.612	27.38	100	100	V	31.2	3.435	32.37	29.645	74	-44.36	Peak
3.612	27.33	275	100	H	31.2	3.435	32.37	29.595	74	-44.41	Peak
3.612	28.78	200	100	V	31.2	3.435	32.37	31.045	54	-22.96	Ave
3.612	28.91	275	100	H	31.2	3.435	32.37	31.175	54	-22.83	Ave
4.515	25.71	0	100	V	32.2	4.125	32.49	29.545	74	-44.46	Peak
4.515	25.74	50	100	H	32.2	4.125	32.49	29.575	74	-44.43	Peak
4.515	27.26	0	100	V	32.2	4.125	32.49	31.095	54	-22.91	Ave
4.515	27.18	50	100	H	32.2	4.125	32.49	31.015	54	-22.99	Ave

Note: Emission was scanned up to 10GHz; no emissions were detected above the noise floor which was at least 20dB below the specification limit

Mid Channel @ 915MHz @ 3 Meter

Frequency (GHz)	Reading (dBuV/m)	Direction (degree)	Height (m)	Polarity (H/V)	Antenna Loss (dB)	Cable Loss (dB)	Amplifier (dB)	Corrected Reading (dBuV/m)	15.247/15.209 Limit @ 3m (dBuV/m)	Margin (dBuV/m)	Detector (pk/avg)
1.830	34.09	37	100	V	25.7	2.16	31.98	29.97	74	-44.03	Peak
1.830	32.19	341	100	H	25.7	2.16	31.98	28.07	74	-45.93	Peak
1.830	35.08	37	100	V	25.7	2.16	31.98	30.96	54	-23.04	Ave
1.830	33.69	341	100	H	25.7	2.16	31.98	29.57	54	-24.43	Ave
2.745	27.82	215	100	V	28.8	2.72	32.08	27.26	74	-46.74	Peak
2.745	27.84	154	100	H	28.8	2.72	32.08	27.28	74	-46.72	Peak
2.745	29.06	215	100	V	28.8	2.72	32.08	28.5	54	-25.5	Ave
2.745	29.06	154	100	H	28.8	2.72	32.08	28.5	54	-25.5	Ave
3.660	28.39	145	100	V	31.2	3.435	32.37	30.655	74	-43.35	Peak
3.660	27.19	233	100	H	31.2	3.435	32.37	29.455	74	-44.55	Peak
3.660	27.09	145	100	V	31.2	3.435	32.37	29.355	54	-24.65	Ave
3.660	28.39	233	100	H	31.2	3.435	32.37	30.655	54	-23.35	Ave
4.575	26.11	169	100	V	32.2	4.125	32.49	29.945	74	-44.06	Peak
4.575	26.01	260	100	H	32.2	4.125	32.49	29.845	74	-44.16	Peak
4.575	27.28	260	100	V	32.2	4.125	32.49	31.115	54	-22.89	Ave
4.574	27.28	169	100	H	32.2	4.125	32.49	31.115	54	-22.89	Ave

Note: Emission was scanned up to 10GHz; no emissions were detected above the noise floor which was at least 20dB below the specification limit



SIEMIC, INC.

Accessing global markets

Title: RF Test Report of AFAR Communications, Inc
To: Model : AR-9010E
FCC 15.247:2009 & RSS-210 Issue 7 : 2007

Serial# SL09121701-AFA-001
Issue Date 01/08/2010
Page 37 of 64
www.sieminc.com

High Channel @ 927MHz @ 3 Meter

Frequency (GHz)	Reading (dBuV/m)	Direction (degree)	Height (m)	Polarity (H/V)	Antenna Loss (dB)	Cable Loss (dB)	Amplifier (dB)	Corrected Reading (dBuV/m)	15.247/15.209 Limit @ 3m (dBuV/m)	Margin (dBuV/m)	Detector (pk/avg)
1.854	36.18	32	179	V	25.7	2.16	31.98	32.06	74	-41.94	Peak
1.854	31.57	45	126	H	25.7	2.16	31.98	27.45	74	-46.55	Peak
1.854	37.32	32	179	V	25.7	2.16	31.98	33.2	54	-20.80	Ave
1.854	32.88	45	126	H	25.7	2.16	31.98	28.76	54	-25.24	Ave
2.781	29.04	140	126	V	28.8	2.72	32.08	28.48	74	-45.52	Peak
2.781	27.00	360	100	H	28.8	2.72	32.08	26.44	74	-47.56	Peak
2.781	28.51	140	126	V	28.8	2.72	32.08	27.95	54	-26.05	Ave
2.781	28.44	360	100	H	28.8	2.72	32.08	27.88	54	-26.12	Ave
3.708	26.74	255	100	V	31.2	3.435	32.37	29.005	74	-45.00	Peak
3.708	26.58	242	100	H	31.2	3.435	32.37	28.845	74	-45.16	Peak
3.708	28.16	255	100	V	31.2	3.435	32.37	30.425	54	-23.58	Ave
3.708	28.37	242	100	H	31.2	3.435	32.37	30.635	54	-23.37	Ave
4.635	25.85	300	100	V	32.2	4.125	32.49	29.685	74	-44.32	Peak
4.635	25.99	82	100	H	32.2	4.125	32.49	29.825	74	-44.18	Peak
4.635	27.34	300	100	V	32.2	4.125	32.49	31.175	54	-22.83	Ave
4.635	27.42	82	100	H	32.2	4.125	32.49	31.255	54	-22.75	Ave

Note: Emission was scanned up to 10GHz; no emissions were detected above the noise floor which was at least 20dB below the specification limit

Band Edge Plots

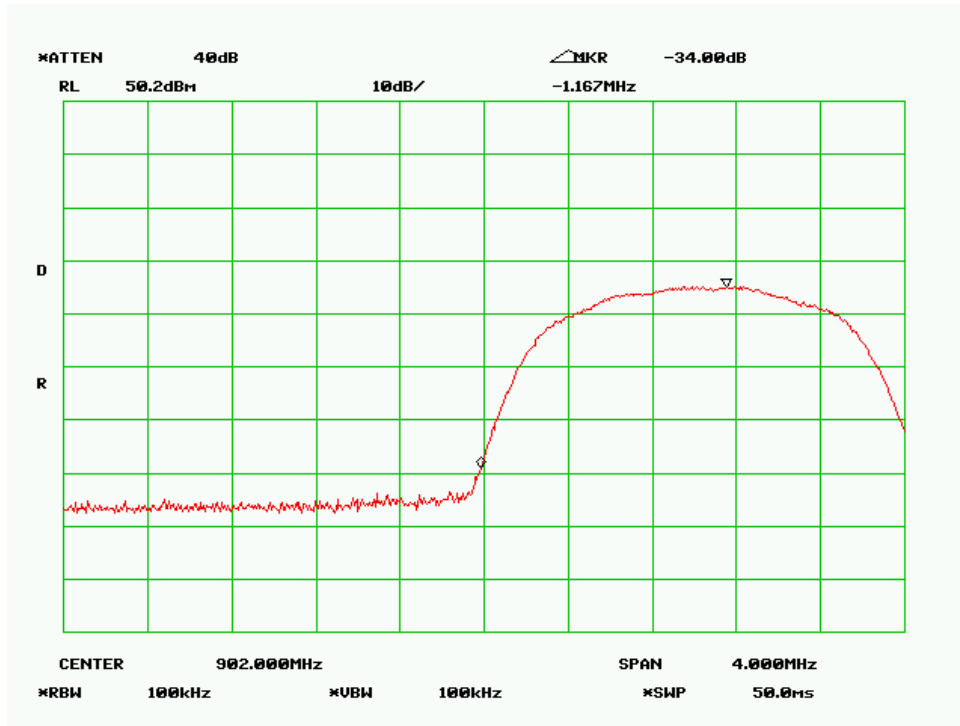

Low Channel

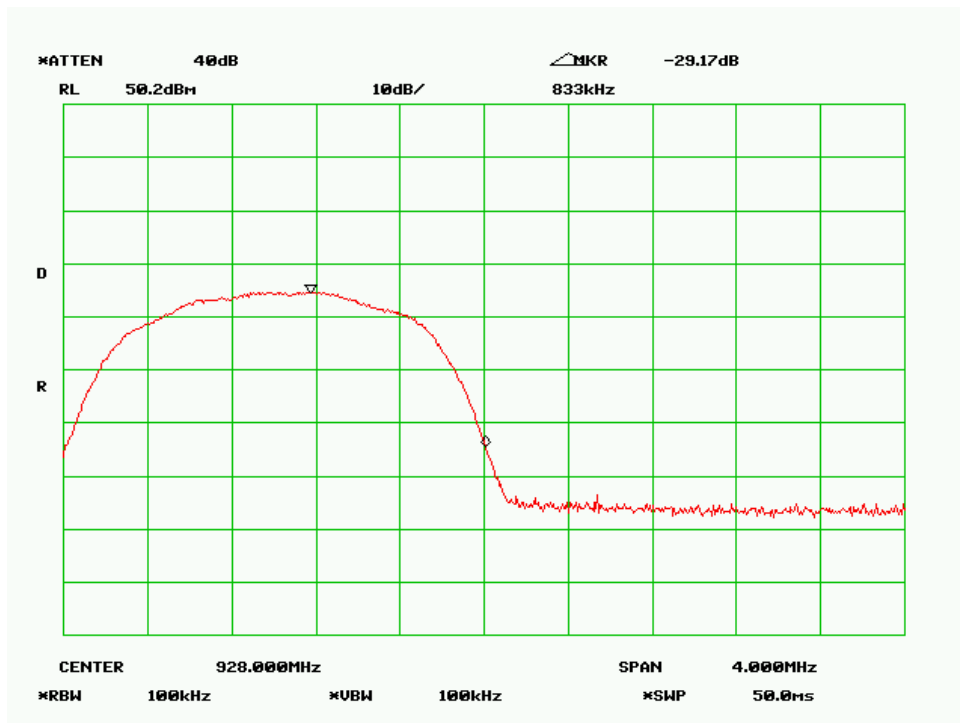

High Channel

Annex A. TEST INSTRUMENT & METHOD

Annex A.i. TEST INSTRUMENTATION & GENERAL PROCEDURES

Instrument	Model	Calibration Due
AC Conducted Emissions		
R&S EMI Test Receiver	ESIB40	04/25/2010
R&S LISN	ESH2-Z5	04/24/2010
CHASE LISN	MN2050B	04/24/2010
Radiated Emissions		
Spectrum Analyzer	8564E	04/26/2010
EMI Receiver	ESIB 40	04/25/2010
R&S LISN	ESH2-Z5	04/24/2010
CHASE LISN	MN2050B	04/24/2010
Antenna(1 ~18GHz)	3115	01/04/2011
Antenna (30MHz~2GHz)	JB1	01/04/2011
Chamber	3m	04/18/2010
Pre-Amplifier(1 ~ 26GHz)	8449	04/24/2010
Horn Antenna (18~40GHz)	AH-840	03/19/2010
Microwave Pre-Amp (18~40GHz)	PA-840	03/19/2010*

Note: Functional Verification

Annex A.ii. CONDUCTED EMISSIONS TEST DESCRIPTION

Test Set-up

1. The EUT and supporting equipment were set up in accordance with the requirements of the standard on top of a 1.5m x 1m x 0.8m high, non-metallic table, as shown in Annex B.
2. The power supply for the EUT was fed through a 50Ω/50μH EUT LISN, connected to filtered mains.
3. The RF OUT of the EUT LISN was connected to the EMI test receiver via a low-loss coaxial cable.
4. All other supporting equipments were powered separately from another main supply.

Test Method

1. The EUT was switched on and allowed to warm up to its normal operating condition.
2. A scan was made on the NEUTRAL line (for AC mains) or Earth line (for DC power) over the required frequency range using an EMI test receiver.
3. High peaks, relative to the limit line, were then selected.
4. The EMI test receiver was then tuned to the selected frequencies and the necessary measurements made with a receiver bandwidth setting of 10 KHz. For FCC tests, only Quasi-peak measurements were made; while for CISPR/EN tests, both Quasi-peak and Average measurements were made.
5. Steps 2 to 4 were then repeated for the LIVE line (for AC mains) or DC line (for DC power).

Sample Calculation Example

At 20 MHz	limit = 250 μV = 47.96 dBμV
Transducer factor of LISN, pulse limiter & cable loss at 20 MHz = 11.20 dB	
Q-P reading obtained directly from EMI Receiver = 40.00 dBμV (Calibrated for system losses)	
Therefore, Q-P margin = 47.96 – 40.00 = 7.96	i.e. 7.96 dB below limit

Annex A. iii RADIATED EMISSIONS TEST DESCRIPTION

EUT Characterisation

EUT characterisation, over the frequency range from 30MHz to 1GHz (for FCC tests, until the 5th harmonic for operating frequencies \geq 108MHz), was done in order to minimise radiated emissions testing time while still maintaining high confidence in the test results.

The EUT was placed in the chamber, at a height of about 0.8m on a turntable. Its radiated emissions frequency profile was observed, using a spectrum analyzer /receiver with the appropriate broadband antenna placed 3m away from the EUT. Radiated emissions from the EUT were maximised by rotating the turntable manually, changing the antenna polarisation and manipulating the EUT cables while observing the frequency profile on the spectrum analyzer / receiver. Frequency points at which maximum emissions occurred, clock frequencies and operating frequencies were then noted for the formal radiated emissions test at the Open Area Test Site (OATS).

Test Set-up

1. The EUT and supporting equipment were set up in accordance with the requirements of the standard on top of a 1.5m X 1.0m X 0.8m high, non-metallic table as shown in Annex B.
2. The filtered power supply for the EUT and supporting equipment were tapped from the appropriate power sockets located on the turntable.
3. The relevant broadband antenna was set at the required test distance away from the EUT and supporting equipment boundary.

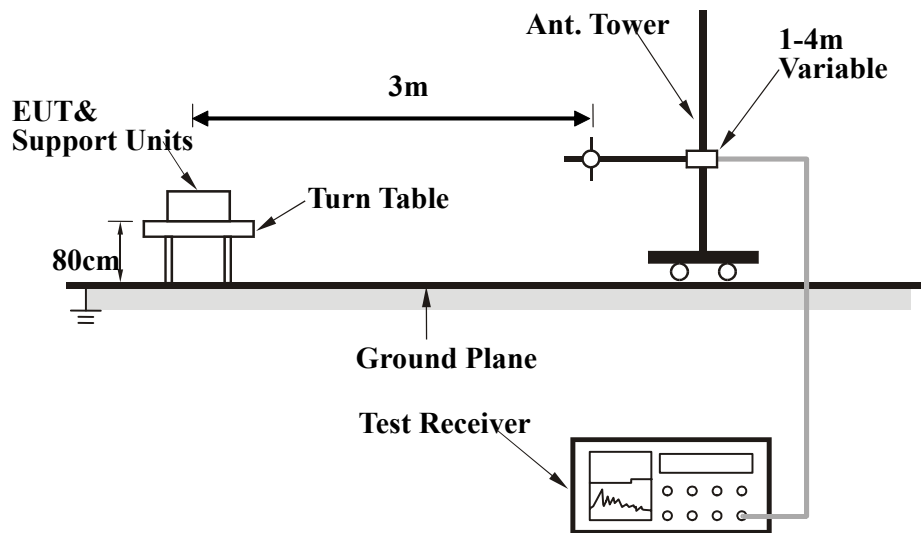

Test Method

The following procedure was performed to determine the maximum emission axis of EUT:

1. With the receiving antenna is H polarization, rotate the EUT in turns with three orthogonal axes to determine the axis of maximum emission.
2. With the receiving antenna is V polarization, rotate the EUT in turns with three orthogonal axes to determine the axis of maximum emission.
3. Compare the results derived from above two steps. So, the axis of maximum emission from EUT was determined and the configuration was used to perform the final measurement.

Final Radiated Emission Measurement

1. Setup the configuration according to figure 1. Turn on EUT and make sure that it is in normal function.
2. For emission frequencies measured below 1 GHz, a pre-scan is performed in a shielded chamber to determine the accurate frequencies of higher emissions will be checked on a open test site. As the same purpose, for emission frequencies measured above 1 GHz, a pre-scan also be performed with a 1 meter measuring distance before final test.
3. For emission frequencies measured below and above 1 GHz, set the spectrum analyzer on a 100 kHz and 1 MHz resolution bandwidth respectively for each frequency measured in step 2.
4. The search antenna is to be raised and lowered over a range from 1 to 4 meters in horizontally polarized orientation. Position the highness when the highest value is indicated on spectrum analyzer, then change the orientation of EUT on test table over a range from 0 ° to 360 ° with a speed as slow as possible, and keep the azimuth that highest emission is indicated on the spectrum analyzer. Vary the antenna position again and record the highest value as a final reading.
5. Repeat step 4 until all frequencies need to be measured were complete.
6. Repeat step 5 with search antenna in vertical polarized orientations.

During the radiated emission test, the Spectrum Analyzer was set with the following configurations:

Frequency Band (MHz)	Function	Resolution bandwidth	Video Bandwidth
30 to 1000	Peak	100 kHz	100 kHz
Above 1000	Peak	1 MHz	1 MHz
	Average	1 MHz	10 Hz

Sample Calculation Example

The field strength is calculated by adding the Antenna Factor and Cable Factor, and subtracting the Amplifier Gain (if any) from the measured reading. For the limit is employed average value, therefore the peak value can be transferred to average value by subtracting the duty factor. The basic equation with a sample calculation is as follows:

$$\text{Peak} = \text{Reading} + \text{Corrected Factor}$$

Where:

Corr. Factor = Antenna Factor + Cable Factor - Amplifier Gain (if any)

And the average value is

$$\text{Average} = \text{Peak Value} + \text{Duty Factor or}$$

$$\text{Set RBW} = 1\text{MHz, VBW} = 10\text{Hz.}$$

Note:

If the measured frequencies are fall in the restricted frequency band, the limit employed must be quasi peak value when frequencies are below or equal to 1 GHz. And the measuring instrument is set to quasi peak detector function.

Annex B EUT AND TEST SETUP PHOTOGRAPHS

Please see the attachment

Annex C. TEST SETUP AND SUPPORTING EQUIPMENT

EUT TEST CONDITIONS

Annex C. i. SUPPORTING EQUIPMENT DESCRIPTION

The following is a description of supporting equipment and details of cables used with the EUT.

Equipment Description (Including Brand Name)	Model & Serial Number	Cable Description (List Length, Type & Purpose)
PC Laptop / DELL	Latitude D600	Shielded RJ45 Cable < 1 meter (From PC to EUT)

Block Configuration Diagram for Radiated Emission

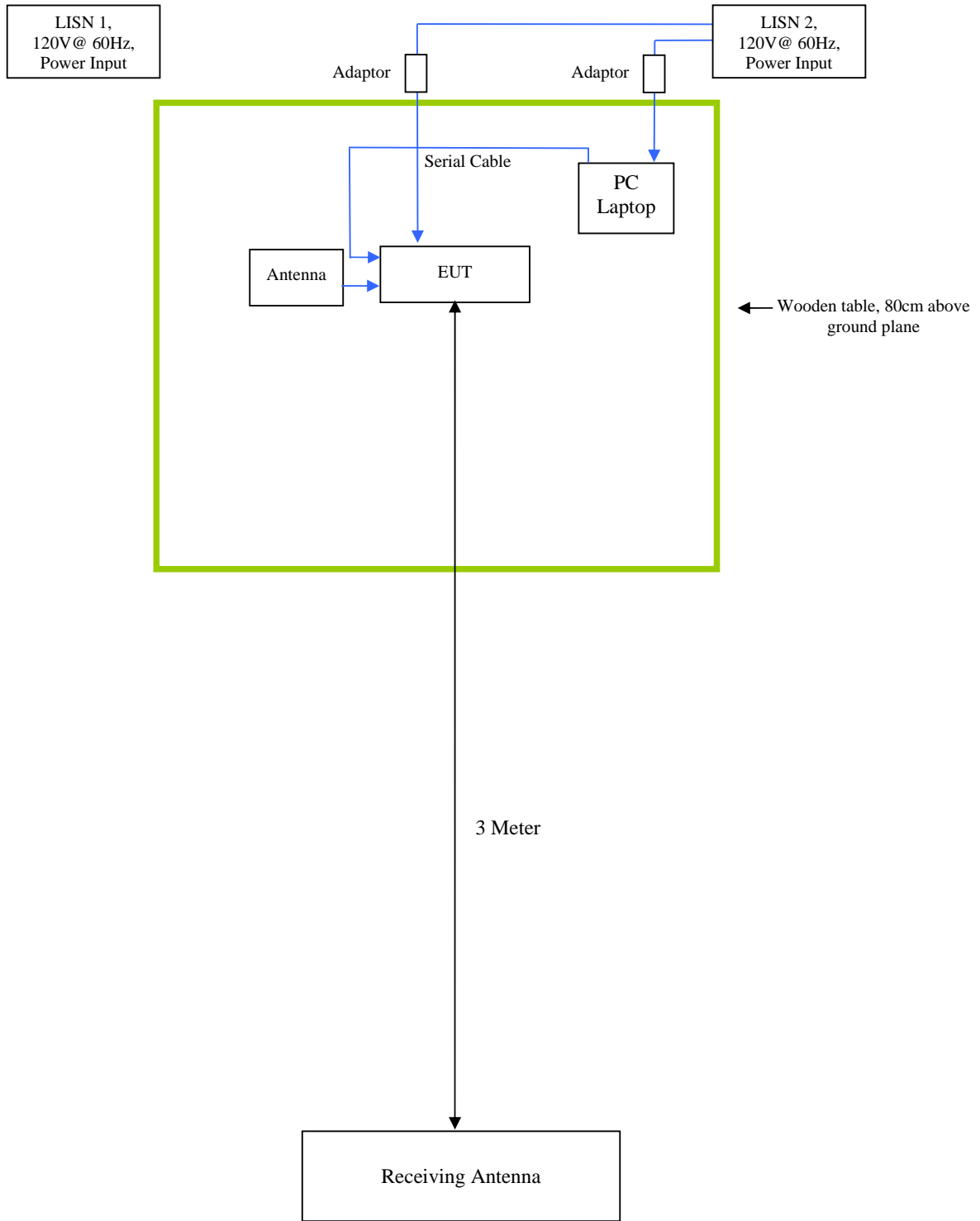

Block Configuration Diagram for Conducted Emission

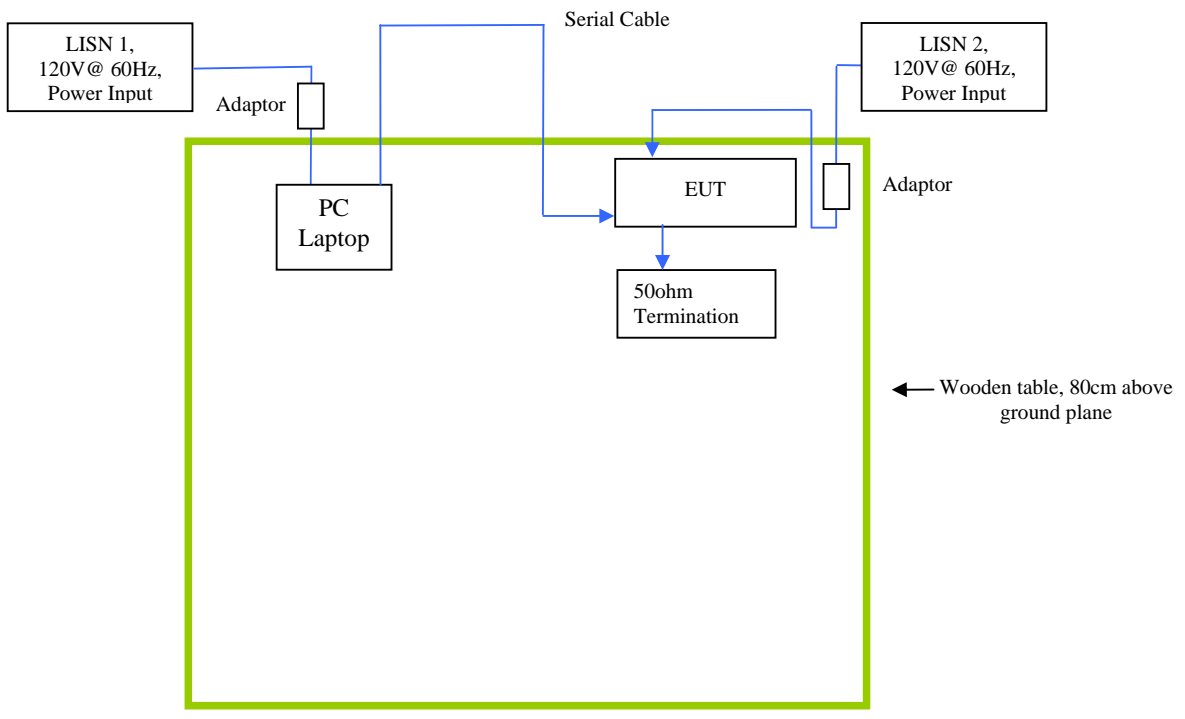

Note:
 A 50ohm termination is used to replace external antenna to simulate normal system function which will not impact the Conducted Emission test.

Annex C.ii. EUT OPERATING CONDITIONS

The following is the description of how the EUT is exercised during testing.

Test	Description Of Operation
Emissions Testing	The EUT was continuously transmitting controlled via serial connection to PC Laptop using Hyper Terminal commands
Others Testing	The EUT was continuously transmitting controlled via serial connection to PC Laptop using Hyper Terminal commands



SIEMIC, INC.
Accessing global markets

Title: RF Test Report of AFAR Communications, Inc
Model : AR-9010E
To FCC 15.247:2009 & RSS-210 Issue 7 : 2007

Serial# SL09121701-AFA-001
Issue Date 01/08/2010
Page 47 of 64
www.siemc.com

Annex D User Manual, Block Diagram, Circuit Diagram

Please see attachment

Annex E. SIEMIC ACCREDITATION CERTIFICATES

SIEMIC ACCREDITATION DETAILS: A2LA Certificate Number: 2742.01

		THE AMERICAN ASSOCIATION FOR LABORATORY ACCREDITATION
ACCREDITED LABORATORY		
A2LA has accredited SIEMIC LABORATORIES San Jose, CA for technical competence in the field of Electrical Testing		
<small>This laboratory is accredited in accordance with the recognized International Standard ISO/IEC 17025:2005 <i>General Requirements for the Competence of Testing and Calibration Laboratories</i>. This accreditation demonstrates technical competence for a defined scope and the operation of a laboratory quality management system (refer to joint ISO-ILAC-IAF Communiqué dated 18 June 2005).</small>		
	Presented this 11th day of July 2008.  President For the Accreditation Council Certificate Number 2742.01 Valid to September 30, 2010	
<small>For the tests or types of tests to which this accreditation applies, please refer to the laboratory's Electrical Scope of Accreditation.</small>		

	THE AMERICAN ASSOCIATION FOR LABORATORY ACCREDITATION
ACCREDITED PRODUCT CERTIFICATION BODY	
A2LA has accredited SIEMIC INC. San Jose, CA for technical competence as a Product Certification Body	
<small>This product certification body is accredited in accordance with the recognized International Standard ISO/IEC Guide 65:1996 <i>General requirements for bodies operating product certification systems</i>. This accreditation demonstrates technical competence for a defined scope and the operation of a quality management system for a Telecommunications Certification Body (TCB) meeting FCC (U.S.), IDA (Singapore) and IC (Canada) requirements.</small>	
	Presented this 9 th day of January 2009.  President For the Accreditation Council Certificate Number: 2742.02 Valid to: September 30, 2010
<small>For the product certification schemes to which this accreditation applies, please refer to the certification body's Scope of Accreditation.</small>	

SCOPE OF ACCREDITATION TO ISO/IEC GUIDE 65:1996

SIEMIC INC.
2206 Ringwood Ave.
San Jose, CA 95131
Mr. Snell Leong (Authorized Representative) Phone: 408 526 1188
www.siemic.com

PRODUCT CERTIFICATION CONFORMITY ASSESSMENT BODY (CAB)

Valid to: September 30, 2010

Certificate Number: 2742.02

In recognition of the successful completion of the A2LA Certification Body Accreditation Program evaluation, including the US Federal Communications Commission (FCC), Industry Canada (IC) and Singapore (IDA) requirements for the indicated types of product certifications, accreditation is granted to this organization to perform the following product certification schemes:

Economy

Scope

Federal Communication Commission - (FCC)

Unlicensed Radio Frequency Devices	A1, A2, A3, A4
Licensed Radio Frequency Devices	B1, B2, B3, B4
Telephone Terminal Equipment	C

**Please refer to FCC TCB Program Roles and Responsibilities, v04, released February 14, 2008 detailing scopes, roles and responsibilities. <http://www.fcc.gov/oet/ea/FCC-Overview-TCB-Program.pdf>*

Industry Canada - (IC)

Radio	All Radio Standards Specifications (RSS) in Category I Equipment Standards List Radio
-------	---

**Please refer to Industry Canada (IC) website at: http://www.ic.gc.ca/epic/site/smt-gst.nsf/en/n_sf01342e.html*

IDA – Singapore

Line Terminal Equipment	All Technical Specifications for Line Terminal Equipment – Table 1 of IDA MRA Recognition Scheme: 2008, Annex 2
Radio-Communication Equipment	All Technical Specifications for Radio-Communication Equipment – Table 2 of IDA MRA Recognition Scheme: 2008, Annex 2

**Please refer to Info-Communication Development Authority (IDA) Singapore website at: http://www.ida.gov.sg/doc/Policies%20and%20Regulation/Policies_and_Regulation_Level2/20060609145118/MRARecScheme.pdf*

SIEMIC ACCREDITATION DETAILS: FCC Test Site Registration No. 783147

FEDERAL COMMUNICATIONS COMMISSION

**Laboratory Division
7435 Oakland Mills Road
Columbia, MD 21046**

December 20, 2007

Registration Number: 783147

SIEMIC Laboratories
2206 Ringwood Avenue,
San Jose, CA 95131

Attention: Leslie Bai

Re: Measurement facility located at San Jose
3 & 10 meter site
Date of Renewal: December 20, 2007

Dear Sir or Madam:

Your request for renewal of the registration of the subject measurement facility has been received. The information submitted has been placed in your file and the registration has been renewed. The name of your organization will remain on the list of facilities whose measurement data will be accepted in conjunction with applications for Certification under Parts 15 or 18 of the Commission's Rules. Please note that the file must be updated for any changes made to the facility and the registration must be renewed at least every three years.

Measurement facilities that have indicated that they are available to the public to perform measurement services on a fee basis may be found on the FCC website www.fcc.gov under E-Filing, OET Equipment Authorization Electronic Filing, Test Firms.

Sincerely,

Phyllis Parrish
Industry Analyst

SIEMIC ACCREDITATION DETAILS: Industry of Canada CAB ID : US0160



UNITED STATES DEPARTMENT OF COMMERCE
National Institute of Standards and Technology
Gaithersburg, Maryland 20899-

March 4, 2009

Mr. Leslie Bai
SIEMIC, Inc.
2206 Ringwood Avenue
San Jose, CA 95131

Dear Mr. Bai:

NIST is pleased to inform you that your laboratory has been recognized by Industry Canada (IC), under the Asia Pacific Economic Cooperation for Telecommunications Equipment Mutual Recognition Arrangement (APEC Tel MRA). Your laboratory is now designated to act as a Conformity Assessment Body (CAB) under Appendix B, **Phase I** Procedures, of the APEC Tel MRA. The pertinent information about your laboratory's designation is as follows:

CAB Name: SIEMIC, Inc.
Physical Location: 2206 Ringwood Avenue, San Jose, CA 95131 USA
Identification No.: US0160
Recognized Scope: CS-03 Part I, II, V, VI, VII and VIII

You may submit test data to IC to verify that the equipment to be imported into Canada satisfies the applicable requirements. The designation of your organization will remain in force as long as its accreditation for the designated scope remains valid and comply with the designation requirements.

Recognized CABs are listed on the NIST website at <http://ts.nist.gov/mra>. Please contact Ms. Ramona Saar at (301) 975-5521 or ramona.saar@nist.gov if you have any questions.

Sincerely,

David F. Alderman
Group Leader, Standards Coordination and Conformity Group
Standards Services Division

Enclosure

cc: CAB Program Manager

NIST

SIEMIC ACCREDITATION DETAILS: Industry of Canada Test Site Registration No. 4842-1

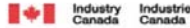

May 23rd, 2008

OUR FILE: 46405-4842
Submission No: 126429

Siemic Inc.
2206 Ringwood Ave.
San Jose CA 95131
USA

Attention: Leslie Bai

Dear Sir/Madame:

The Bureau has received your application for the registration / renewal of a 3/10m OATS. Be advised that the information received was satisfactory to Industry Canada. The following number(s) is now associated to the site(s) for which registration / renewal was sought (**4842A-1**). Please reference the appropriate site number in the body of test reports containing measurements performed on the site. In addition, please be informed that the Bureau is now utilizing a **new site numbering scheme** in order to simplify the electronic filing process. Our goal is to reduce the number of secondary codes associated to one particular company. The following changes have been made to your record.

- Your primary code is: **4842**
- The company number associated to the site(s) located at the above address is: **4842A**
- The table below is a summary of the changes made to the unique site registration number(s):

New Site Number	Obsolete Site Number	Description of Site	Expiry Date (YYYY-MM-DD)
4842A-1	4842-1	3m Chamber	2010-05-23

Furthermore, to obtain or renew a unique site number, the applicant shall demonstrate that the site has been accredited to ANSI C63.4-2003 or later. A scope of accreditation indicating the accreditation by a recognized accreditation body to ANSI C63.4-2003 shall be accepted. Please indicate in a letter the previous assigned site number if applicable and the type of site (example: 3 meter OATS or 3 meter chamber). If the test facility is not accredited to ANSI C63.4-2003 or later, the test facility shall submit test data demonstrating full compliance with the ANSI standard. The Bureau will evaluate the filing to determine if recognition shall be granted.

The frequency for re-validation of the test site and the information that is required to be filed or retained by the testing party shall comply with the requirements established by the accrediting organization. However, in all cases, test site re-validation shall occur on an interval not to exceed two years. There is no fee or form associated with an OATS filing. OATS submissions are encouraged to be submitted electronically to the Bureau using the following URL:
http://strategis.ic.gc.ca/epic/internet/inceb-bhst.nsf/en/h_tt00052e.html.

If you have any questions, you may contact the Bureau by e-mail at certification.bureau@ic.gc.ca. Please reference our file and submission number above for all correspondence.

Yours sincerely,



S. Proulx
Test & Measurement Specialist
Certification and Engineering Bureau
3701 Carling Ave., Building 94
Ottawa, Ontario K2H 8S2



SIEMIC, INC.

Accessing global markets

Title: RF Test Report of AFAR Communications, Inc
Model : AR-9010E
To FCC 15.247:2009 & RSS-210 Issue 7 : 2007

Serial# SL09121701-AFA-001
Issue Date 01/08/2010
Page 53 of 64
www.sieminc.com

SIEMIC ACCREDITATION DETAILS: FCC DOC CAB Recognition : US1109

FEDERAL COMMUNICATIONS COMMISSION

**Laboratory Division
7435 Oakland Mills Road
Columbia, MD 21046**

August 28, 2008

Siemic Laboratories
2206 Ringwood Ave.,
San Jose, CA 95131

Attention: Leslie Bai

Re: Accreditation of Siemic Laboratories
Designation Number: US1109
Test Firm Registration #: 540430

Dear Sir or Madam:

We have been notified by American Association for Laboratory Accreditation that Siemic Laboratories has been accredited as a Conformity Assessment Body (CAB).

At this time Siemic Laboratories is hereby designated to perform compliance testing on equipment subject to Declaration Of Conformity (DOC) and Certification under Parts 15 and 18 of the Commission's Rules.

This designation will expire upon expiration of the accreditation or notification of withdrawal of designation.

Sincerely,

George Tannahill
Electronics Engineer

SIEMIC ACCREDITATION DETAILS: Australia CAB ID : US0160



UNITED STATES DEPARTMENT OF COMMERCE
National Institute of Standards and Technology
Gaithersburg, Maryland 20899

November 20, 2008

Mr. Leslie Bai
SIEMIC, Inc.
2206 Ringwood Avenue
San Jose, CA 95131

Dear Mr. Bai:

NIST is pleased to inform you that your laboratory has been recognized by the Australian Communications and Media Authority (ACMA) under the Asia Pacific Economic Cooperation for Telecommunications Equipment Mutual Recognition Arrangement (APEC Tel MRA). Your laboratory is now designated to act as a Conformity Assessment Body (CAB) under Appendix B, **Phase I** Procedures, of the APEC Tel MRA. The pertinent information about your laboratory's designation is as follows:

CAB Name: Siemic, Inc.
Physical Location: 2206 Ringwood Avenue, San Jose, CA 95131
Identification No.: US0160
Recognized Scope: EMC: AS/NZS 4251.1 (until 5/31/2009), AS/NZS 4251.2 (until 5/31/2009), AS/NZS CISPR 11, AS/NZS CISPR 14.1, AS/NZS CISPR 22, AS/NZS 61000.6.3, AS/NZS 61000.6.4
Radiocommunications: AS/NZS 4281, AS/NZS 4268, AS/NZS 4280.1, AS/NZS 4280.2, AS/NZS 4295, AS/NZS 4582, AS/NZS 4583, AS/NZS 4769.1, AS/NZS 4769.2, AS/NZS 4770, AS/NZS 4771
Telecommunications: AS/ACIF S002:05, AS/ACIF S003:06, AS/ACIF S004:06, AS/ACIF S006:01, AS/ACIF S016:01, AS/ACIF S031:01, AS/ACIF S038:01, AS/ACIF S040:01, AS/ACIF S041:05, AS/ACIF S043.2:06, AS/NZS 60950.1

You may submit test data to ACMA to verify that the equipment to be imported into Australia satisfies the applicable requirements. The designation of your organization will remain in force as long as its accreditation for the designated scope remains valid and comply with the designation requirements. Recognized CABs are listed on the NIST website at <http://ts.nist.gov/mra>. Please contact Ms. Ramona Saar, at (301) 975-5521 or ramona.saar@nist.gov if you have questions.

Sincerely,

David F. Alderman
Group Leader, Standards Coordination and Conformity Group
Standards Services Division

Enclosure

cc: Snell Leong, Siemic, Inc.; Ramona Saar, NIST

SIEMIC ACCREDITATION DETAILS: Korea CAB ID: US0160



UNITED STATES DEPARTMENT OF COMMERCE
National Institute of Standards and Technology
Gaithersburg, Maryland 20899.

October 1, 2008

Mr. Leslie Bai
SIEMIC, Inc.
2206 Ringwood Avenue
San Jose, CA 95131

Dear Mr. Bai:

NIST is pleased to inform you that your laboratory has been recognized by the Radio Research Agency (RRA) Korea Communications Commission (KCC) under the Asia Pacific Economic Cooperation for Telecommunications Equipment Mutual Recognition Arrangement (APEC Tel MRA). Your laboratory is now designated to act as a Conformity Assessment Body (CAB) under Appendix B, **Phase I** Procedures, of the APEC Tel MRA. The pertinent information about your laboratory's designation is as follows:

CAB Name: SIEMIC, Inc.
Physical Location: 2206 Ringwood Avenue, San Jose, CA 95131
Identification No.: US0160
Recognized Scope: **EMI:** KCC Notice 2008-39, RRL Notice 2008-3: CA Procedures for EMI
KN22: Test Method for EMI
EMS: KCC Notice 2008-38, RRL Notice 2008-4: CA Procedures for EMS
KN24, KN-61000-4-2, -4-3, -4-4, -4-5, -4-6, -4-8, -4-11: Test Method for EMS
Wireless: RRL Notice 2008-26, RRL Notice 2008-2, RRL Notice 2008-10,
RRL Notice 2007-49, RRL Notice 2007-20, RRL Notice 2007-21,
RRL Notice 2007-80, RRL Notice 2004-68
Wired: President Notice 20664, RRL Notice 2007-30,
RRL Notice 2008-7 with attachments 1, 3, 5, 6
President Notice 20664, RRL Notice 2008-7 with attachment 4

You may submit test data to RRA/KCC to verify that the equipment to be imported into Korea satisfies the applicable requirements. The designation of your organization will remain in force as long as its accreditation for the designated scope remains valid and comply with the designation requirements.

Recognized CABs are listed on the NIST website at <http://ts.nist.gov/mra>. If you have any questions please contact Ramona Saar at (301) 975-5521 or ramona.saar@nist.gov.

Sincerely,

David F. Alderman
Group Leader, Standards Coordination and Conformity Group
Standards Services Division

Enclosure

cc: Ramona Saar

NIST



SIEMIC, INC.

Accessing global markets

Title: RF Test Report of AFAR Communications, Inc
Model : AR-9010E
To: FCC 15.247:2009 & RSS-210 Issue 7 : 2007

Serial# SL09121701-AFA-001
Issue Date 01/08/2010
Page 56 of 64
www.siemec.com

SIEMIC ACCREDITATION DETAILS: Taiwan BSMI Accreditation No. SL2-IN-E-1130R



UNITED STATES DEPARTMENT OF COMMERCE
National Institute of Standards and Technology
Gaithersburg, Maryland 20899

May 3, 2006

Mr. Leslie Bai
SIEMIC Laboratories
2206 Ringwood Avenue
San Jose, CA 95131

Dear Mr. Bai:

I am pleased to inform you that your laboratory has been recognized by the Chinese Taipei's Bureau of Standards, Metrology, and Inspection (BSMI) under the Asia Pacific Economic Cooperation (APEC) Mutual Recognition Arrangement (MRA). Your laboratory is now designated to act as a Conformity Assessment Body (CAB) under Appendix B, **Phase I** Procedures, of the APEC Tel MRA. You may submit test data to BSMI to verify that the equipment to be imported into Chinese Taipei satisfies the applicable requirements. The designation of your organization will remain in force as long as its accreditation for the designated scope remains valid and comply with the designation requirements. The pertinent designation information is as follows:

- BSMI number: **SL2-IN-E-1130R** (Must be applied to the test reports)
- U.S. Identification No: **US0160**
- Scope of Designation: **CNS 13438**
- Authorized signatory: **Mr. Leslie Bai**

The names of all recognized CABs will be posted on the NIST website at <http://ts.nist.gov/mra>. If you have any questions, please contact Mr. Dhillon at 301-975-5521. We appreciate your continued interest in our international conformity assessment activities.

Sincerely,

David F. Alderman
Group Leader, Standards Coordination and Conformity Group

cc: Jogindar Dhillon

NIST

SIEMIC ACCREDITATION DETAILS: Taiwan NCC CAB ID: US0160



UNITED STATES DEPARTMENT OF COMMERCE
National Institute of Standards and Technology
Gaithersburg, Maryland 20899

November 25, 2008

Mr. Leslie Bai
SIEMIC, Inc.
2206 Ringwood Avenue
San Jose, CA 95131

Dear Mr. Bai:

NIST is pleased to inform you that your laboratory has been recognized by the National Communications Commission (NCC) for the requested scope expansion under the Asia Pacific Economic Cooperation for Telecommunications Equipment Mutual Recognition Arrangement (APEC Tel MRA). Your laboratory is designated to act as a Conformity Assessment Body (CAB) under Appendix B, **Phase I** Procedures, of the APEC Tel MRA. The pertinent information about your laboratory's designation is as follows:

CAB Name: SIEMIC, Inc.
Physical Location: 2206 Ringwood Avenue, San Jose, CA 95131
Identification No.: US0160
Current Scope: LP0002
Additional Scope: PSTN01, ADSL01, ID0002, IS6100 and CNS 14336

You may submit test data to NCC to verify that the equipment to be imported into China satisfies the applicable requirements. The designation of your organization will remain in force as long as its accreditation for the designated scope remains valid and comply with the designation requirements.

Recognized CABs are listed on the NIST website at <http://ts.nist.gov/mra>. If you have any questions please contact Ramona Saar at (301) 975-5521 or ramona.saar@nist.gov.

Sincerely,

David F. Alderman
Group Leader, Standards Coordination and Conformity Group
Standards Services Division

Enclosure

cc: Ramona Saar

NIST



SIEMIC, INC.

Accessing global markets

Title: RF Test Report of AFAR Communications, Inc
Model : AR-9010E
To: FCC 15.247:2009 & RSS-210 Issue 7 : 2007

Serial# SL09121701-AFA-001
Issue Date 01/08/2010
Page 58 of 64
www.siemic.com

SIEMIC ACCREDITATION DETAILS: Mexico NOM Recognition



CAMARA NACIONAL
DE LA INDUSTRIA
ELECTRONICA, DE
TELECOMUNICACIONES
E INFORMATICA

Laboratorio Valentín V. Rivero

México D.F. a 16 de octubre de 2006.

**LESLIE BAI
DIRECTOR OF CERTIFICATION
SIEMIC LABORATORIES, INC.
ACCESSING GLOBAL MARKETS
P R E S E N T E**

En contestación a su escrito de fecha 5 de septiembre del año en curso, le comento que estamos muy interesados en su intención de firmar un Acuerdo de Reconocimiento Mutuo, para lo cual adjunto a este escrito encontrara el Acuerdo en idioma inglés y español prellenado de los cuales le pido sea revisado y en su caso corregido, para que si esta de acuerdo poder firmarlo para mandarlo con las autoridades Mexicanas para su visto bueno y así poder ejercer dicho acuerdo.

Aprovecho este escrito para mencionarle que nuestro intermediario gestor será la empresa Isabel de México, S. A. de C. V., empresa que ha colaborado durante mucho tiempo con nosotros en lo relacionado a la evaluación de la conformidad y que cuenta con amplia experiencia en la gestión de la certificación de cumplimiento con Normas Oficiales Mexicanas de producto en México.

Me despido de usted enviándole un cordial saludo y esperando sus comentarios al Acuerdo que nos ocupa.

Atentamente:

**Ing. Faustino Gómez González
Gerente Técnico del Laboratorio de
CANIETI.**

Callejón 71
Hidrovia Comfesa
06100 Méxco. D.F.
Tel. 5264 6036 con 12 líneas
Fax 5264 6498
www.canieti.org

SIEMIC ACCREDITATION DETAILS: Hong Kong OFTA CAB ID : US0160



UNITED STATES DEPARTMENT OF COMMERCE
National Institute of Standards and Technology
Gaithersburg, Maryland 20899

December 8, 2008

Mr. Leslie Bai
SIEMIC, Inc.
2206 Ringwood Avenue
San Jose, CA 95131

Dear Mr. Bai:

NIST is pleased to inform you that your laboratory has been recognized by the Office of the Telecommunications Authority (OFTA) under the Asia Pacific Economic Cooperation for Telecommunications Equipment Mutual Recognition Arrangement (APEC Tel MRA). Your laboratory is now designated to act as a Conformity Assessment Body (CAB) under Appendix B, **Phase I** Procedures, of the APEC Tel MRA. The pertinent information about your laboratory's designation is as follows:

CAB Name: SIEMIC, Inc.
Physical Location: 2206 Ringwood Avenue, San Jose, California 95131 USA
Identification No.: US0160
Recognized Scope: **Radio:** HKTA 1002, 1007, 1008, 1010, 1015, 1016, 1020, 1022, 1026, 1027, 1029, 1030, 1031, 1032, 1033, 1034, 1035, 1036, 1037, 1039, 1041, 1042, 1043, 1044, 1046, 1047, 1048, 1049, 1051
Telecom: HKTA 2011, 2012, 2013, 2014, 2017, 2018, 2022, 2024, 2026, 2027, 2028, 2029, 2030, 2031, 2032, 2033

You may submit test data to OFTA to verify that the equipment to be imported into Hong Kong satisfies the applicable requirements. The designation of your organization will remain in force as long as its accreditation for the designated scope remains valid and comply with the designation requirements.

Recognized CABs are listed on the NIST website at <http://ts.nist.gov/mra>. If you have any questions please contact Ramona Saar at (301) 975-5521 or ramona.saar@nist.gov.

Sincerely,

David F. Alderman
Group Leader, Standards Coordination and Conformity Group
Standards Services Division

Enclosure

cc: Ramona Saar

NIST

SIEMIC ACCREDITATION DETAILS: Australia ACMA CAB ID: US0160



UNITED STATES DEPARTMENT OF COMMERCE
National Institute of Standards and Technology
Gaithersburg, Maryland 20899

November 20, 2008

Mr. Leslie Bai
SIEMIC, Inc.
2206 Ringwood Avenue
San Jose, CA 95131

Dear Mr. Bai:

NIST is pleased to inform you that your laboratory has been recognized by the Australian Communications and Media Authority (ACMA) under the Asia Pacific Economic Cooperation for Telecommunications Equipment Mutual Recognition Arrangement (APEC Tel MRA). Your laboratory is now designated to act as a Conformity Assessment Body (CAB) under Appendix B, **Phase I** Procedures, of the APEC Tel MRA. The pertinent information about your laboratory's designation is as follows:

CAB Name: Siemic, Inc.
Physical Location: 2206 Ringwood Avenue, San Jose, CA 95131
Identification No.: US0160
Recognized Scope: EMC: AS/NZS 4251.1 (until 5/31/2009), AS/NZS 4251.2 (until 5/31/2009), AS/NZS CISPR 11, AS/NZS CISPR 14.1, AS/NZS CISPR 22, AS/NZS 61000.6.3, AS/NZS 61000.6.4
Radiocommunications: AS/NZS 4281, AS/NZS 4268, AS/NZS 4280.1, AS/NZS 4280.2, AS/NZS 4295, AS/NZS 4582, AS/NZS 4583, AS/NZS 4769.1, AS/NZS 4769.2, AS/NZS 4770, AS/NZS 4771
Telecommunications: AS/ACIF S002:05, AS/ACIF S003:06, AS/ACIF S004:06, AS/ACIF S006:01, AS/ACIF S016:01, AS/ACIF S031:01, AS/ACIF S038:01, AS/ACIF S040:01, AS/ACIF S041:05, AS/ACIF S043.2:06, AS/NZS 60950.1

You may submit test data to ACMA to verify that the equipment to be imported into Australia satisfies the applicable requirements. The designation of your organization will remain in force as long as its accreditation for the designated scope remains valid and comply with the designation requirements. Recognized CABs are listed on the NIST website at <http://ts.nist.gov/mra>. Please contact Ms. Ramona Saar, at (301) 975-5521 or ramona.saar@nist.gov if you have questions.

Sincerely,

David F. Alderman
Group Leader, Standards Coordination and Conformity Group
Standards Services Division

Enclosure

cc: Snell Leong, Siemic, Inc.; Ramona Saar, NIST

NIST

SIEMIC ACCREDITATION DETAILS: Australia NATA Recognition



Leslie Bai
SIEMIC, Inc.
2206 Ringwood Avenue
San Jose, CA 95131

November 4, 2008

Under Australian government legislation, the Australian Communications and Media Authority (ACMA) has determined the National Association of Testing Authorities, Australia (NATA) as an accreditation body as per Section 409(1) of the Telecommunications Act 1997 (Cth). Pursuant to Section 409(2) of the Telecommunications Act 1997 (Cth), I am pleased to advise that your laboratory has been determined as a Recognised Testing Authority (RTA).

This determination has been made on the basis of your accreditation by A2LA accreditation no. 2742.01 and the Mutual Recognition Agreement between NATA and A2LA. It is effective from 11 July 2008. RTA status applies only to the following standards and is contingent upon their continued inclusion in your laboratory's scope of accreditation.

**AS/ACIF S002, AS/ACIF S003, AS/ACIF S004,
AS/ACIF S006, AS/ACIF S016, AS/ACIF S031,
AS/ACIF S038, AS/ACIF S041 and
AS/ACIF S043.2**

As an RTA, your laboratory has the following obligations:

1. the laboratory shall continue to meet all of the accreditation criteria of A2LA;
2. the authorised representative of the laboratory shall notify NATA of changes to the staff or operations of the laboratory which would affect the performance of the tests for which the laboratory has been determined;
3. compliance of equipment shall be reported on test reports bearing the A2LA logo/endorsement.

Current information on the Australian Communications and Media Authority and regulatory requirements for telecommunications products within Australia can be obtained from the ACMA's web-site at "<http://www.acma.gov.au>". Further information about NATA may be gained by visiting "<http://www.nata.asn.au>".

Please note that AS/ACIF S040 and New Zealand standards do not form part of the RTA scheme.

Your RTA listing will appear on the NATA website shortly.

Kind Regards

Chris Norton,
Senior Scientific Officer
Measurement Science and Technology
National Association of Testing Authorities (NATA)
71-73 Flemington Road
North Melbourne Vic 3051
Australia
Ph: +61 3 9329 1633 Fx: +61 3 9326 5148
E-Mail: Christopher.Norton@nata.asn.au
Internet: www.nata.asn.au



SIEMIC, INC.

Accessing global markets

Title: RF Test Report of AFAR Communications, Inc
Model : AR-9010E
To: FCC 15.247:2009 & RSS-210 Issue 7 : 2007

Serial# SL09121701-AFA-001
Issue Date 01/08/2010
Page 62 of 64
www.sieminc.com

SIEMIC ACCREDITATION DETAILS: VCCI Radiated Test Site Registration No. R-3083



VCCI Council

CERTIFICATE

Company: SIEMIC Inc.

<Member No. 3081 >

Facility: SIEMIC Inc.

(Radiation 3 meter site)

Location of Facility:

2206 Ringwood Avenue, San Jose, CA 95131 USA

*This is to certify that the following measuring facility
has been registered in accordance with the Rules
for Voluntary Control Measures*

Registration No.: R-3083

Date of Registration: June 12, 2009

This Certificate is valid until September 30, 2010

VCCI Council



SIEMIC ACCREDITATION DETAILS: VCCI Conducted (Main Port) Test Site Registration No. C-3421



VCCI Council

CERTIFICATE

Company: SIEMIC Inc.

<Member No. 3081 >

Facility: SIEMIC Inc.

(Main Ports Conducted Interference Measurement)

Location of Facility:

2206 Ringwood Avenue, San Jose, CA 95131 USA

*This is to certify that the following measuring facility
has been registered in accordance with the Rules
for Voluntary Control Measures*

Registration No.: C-3421

Date of Registration: June 12 , 2009

This Certificate is valid until September 30 , 2010

VCCI Council



SIEMIC ACCREDITATION DETAILS: VCCI Conducted (Telecom Port) Test Site Registration No. T-1597



VCCI Council

CERTIFICATE

Company: SIEMIC Inc.

<Member No. 3081 >

Facility: SIEMIC Inc.

(Telecommunication Ports Conducted Interference Measurement)

Location of Facility:

2206 Ringwood Avenue, San Jose, CA 95131 USA

*This is to certify that the following measuring facility
has been registered in accordance with the Rules
for Voluntary Control Measures*

Registration No.: T-1597

Date of Registration: June 12 , 2009

This Certificate is valid until September 30 , 2010

VCCI Council

