

Cabled I/O Extension

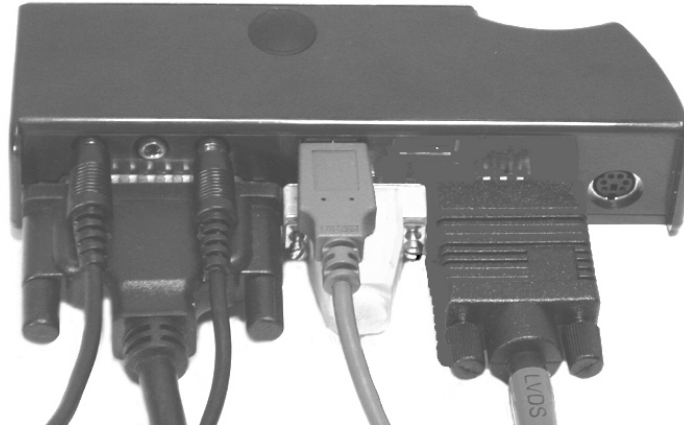

In-Vehicle Mount

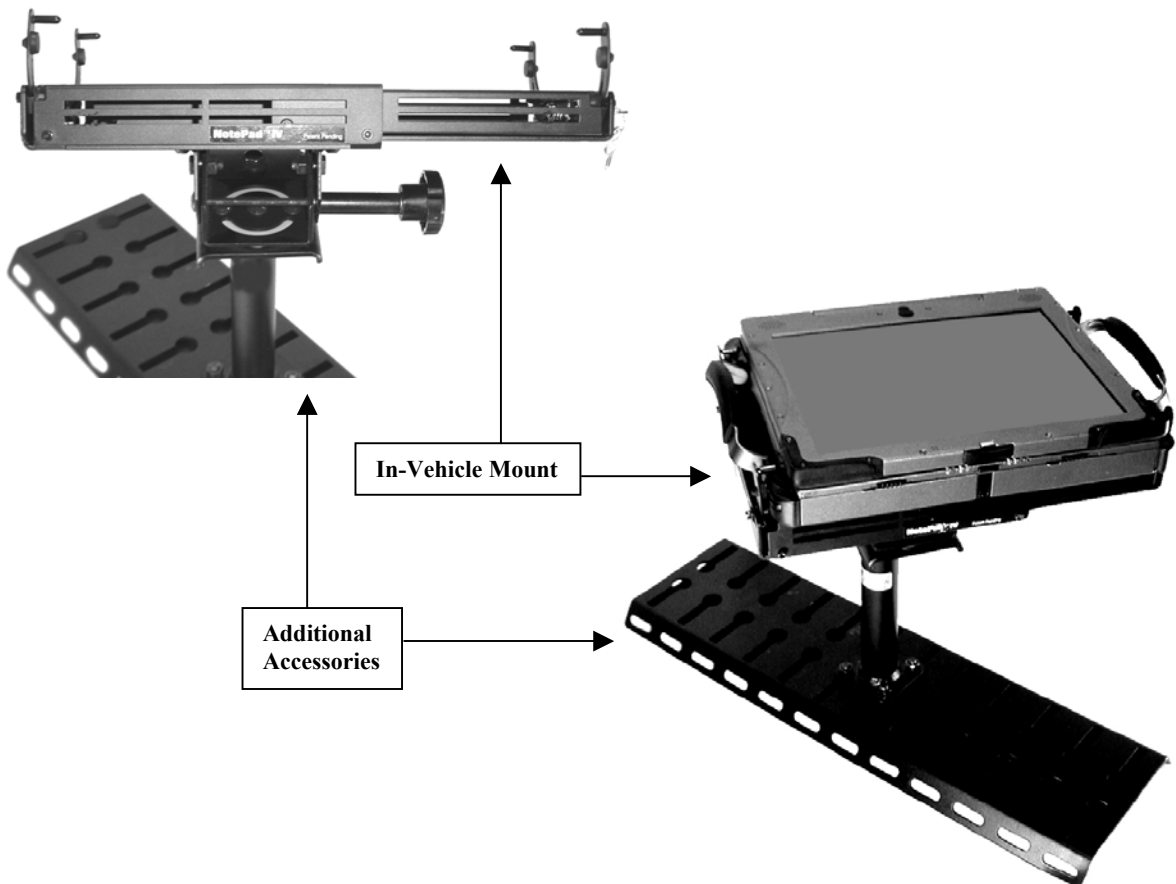

Other mounting solutions are also available. Contact your Kontron Mobile Computing sales representative for more information.

This page was intentionally left blank.

Getting Started

This section describes first-time or typical start-up operations of the ReVolution system:

- Connecting to Power
- Power On and Power Off
- Battery Power
- Converting from Laptop to Tablet and Back
- Windows End-User Experience
- Accessing this *ReVolution User Manual*

Connecting to Power

The ReVolution is shipped in the “off” condition. Depending on your required range of use, you can connect the ReVolution to AC (via an AC/DC adapter) or DC power supply.

This section will detail the proper cabling requirements for your ReVolution system.



- ***Before using your system, become familiar with the components and check that everything is connected properly.***
- ***Following a proper cabling procedure will prevent a false “power on” condition, which could result in unit operational failure.***
- ***Attach the power cable last!***



- ***The plug on the AC power cable supplied corresponds to the requirements of the country in which you purchased your ReVolution system.***
- ***To avoid accidentally disconnecting your computer, plug the AC power cable into a nearby outlet.***
- ***Allow at least 200 mm (approximately 8”) between the ReVolution and the AC/DC adapter.***
- ***The AC/DC adapter must be uncovered and stand freely with at least 100 mm (approximately 4”) free space around it and the ReVolution.***
- ***Do not place the AC/DC adapter on a heat-sensitive surface.***

Connecting the AC/DC Adapter

When AC is available, connect the ReVolution to the AC power supply with an AC/DC adapter, as described below.



Connect the locking DC power cord to the DC voltage socket of the ReVolution. The other end of the DC power cord connects into available DC power connector i.e. cigarette lighter.



The AC voltage socket is on the left side of the Interface panel.

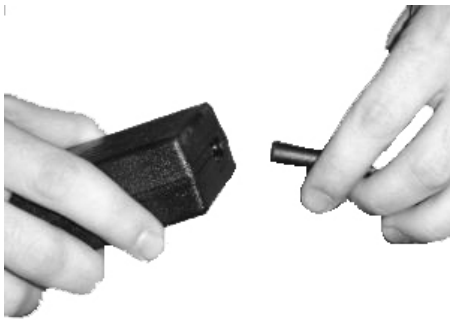

Connect the female end of the AC power cord into the AC power adapter.



Plug the male end of the AC power adapter into an available wall socket.



Power On/Off Button

When pressed for ~1/2 second continuously, the system will:

- From Off: Check for valid temperature and then turn on.
- From Suspend: Check for valid temperature and then turn on.
- From On: Initiate power off sequence.

When pressed for > 4 seconds continuously, the system: begins an override function according to the ACPI specification.

The Override Function is useful if the system becomes unresponsive. It will perform a "hard" shut down.

Power On and Power Off

The **Power On/Off** button is the lower of the two buttons located in the bottom-center of the display panel.

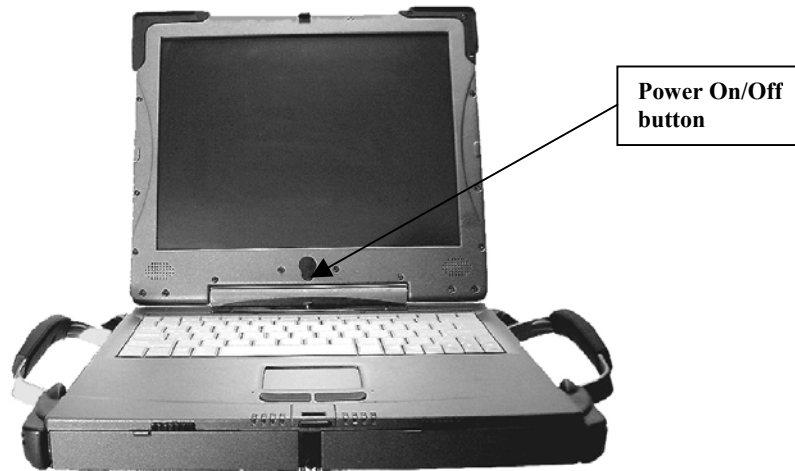

Turning on the System



Do not operate the ReVolution in areas sensitive to radio interference, such as airplanes and hospitals.

There is no means to shut off the Bluetooth and WLAN radios installed in the system.

Press the **Power On/Off** button for approximately 1/2 second. The computer will check for valid temperature, then turn on.

As the computer powers up, the LEDs will blink and the screen will indicate that the computer is installing BIOS and checking memory. This is the Power-On Self Test (POST). When finished with POST, a System Configuration screen shows briefly how the system BIOS is configured. To examine the configuration at length, press the **Pause/Break** key as soon as the System Configuration comes up on the display. Press **Enter** to continue. The system then loads the operating system.

The **Power Indicator LED** is the fourth light left of center. It is visible when the display is open or closed. The following table lists the various power states as indicated by the combination of flashes of the Power and Battery Indicator LEDs:

Power State	Power LED	Battery Indicator LED
OFF	OFF	OFF
On, Charging	ON	Slow Blink
Low Battery	OFF	Fast Blink
Running on battery	OFF	ON
Running on AC not charging	ON	OFF
Battery Malfunction	Fast Blink	Fast Blink
Sleep mode battery	Slow Blink	OFF
Sleep mode AC	OFF	Slow Blink



To awaken the ReVolution from sleep mode, press the Power button.

Slow blink is defined as - 0.5 Hz, 50% duty cycle, i.e. ON for one second, OFF for one second

Fast blink is defined as - 1 Hz, 50 % duty cycle, i.e. On for 500 ms, OFF for 500 ms



Never operate this computer in AC mode while standing in water.
You can operate it in DC or battery mode.

If you should encounter a problem in powering up:

1. Verify all connectors are properly connected.
2. Verify your boot drive.
3. Boot your system with only the power cord connected to the computer. This is the minimum required to see if the system is working.
4. If your system still does not start after steps 1-3, contact your nearest Technical Support department for assistance. See the "Technical Support" section of this manual for contact information.

Turning off the System



Kontron recommends that you close all applications before shutting down or powering off the ReVolution.

1. Follow the shut down procedures specified in the operating system manual provided with your unit.

OR

2. Press the **Power On/Off** button and hold it down for approximately 1/2 second.

Battery Power

If an AC/DC power source is not available, you can operate your ReVolution from one or two battery packs. The LED indicator for battery power is the third LED left of center.

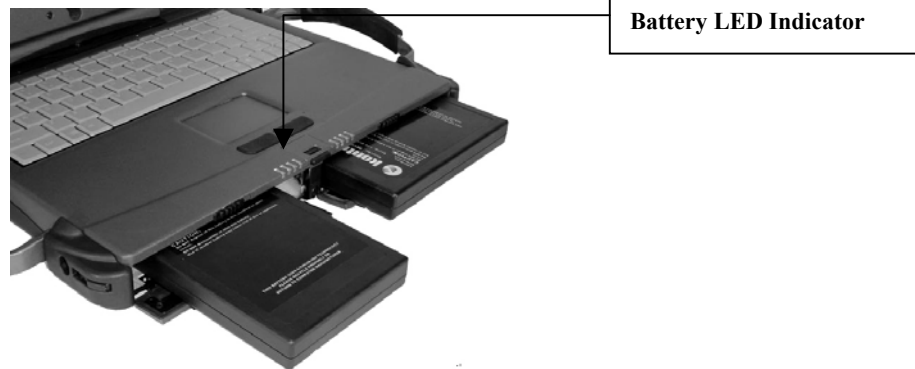

A lithium ion battery pack is the only component that can be installed in the right front bay. It will provide approximately 3.5 hours operating time under power management.

You can insert an additional lithium ion battery pack into the left front bay to extend your computer's operating time. Together, the two batteries will provide approximately 7 hours under power management. Refer to the "Modifying the System" section for instructions on removing and inserting a battery pack, and power management information.

The **Battery Indicator LED** is the second light from the right, as displayed above. It is visible when the display is open or closed. The following table lists the various power states as indicated by the combination of flashes of the Battery and Power Indicator LEDs:

Power State	Power LED	Battery Indicator LED
OFF	OFF	OFF
On, Charging	ON	Slow Blink
Low Battery	OFF	Fast Blink
Running on battery	OFF	ON
Running on AC not charging	ON	OFF
Battery Malfunction	Fast Blink	Fast Blink
Sleep mode battery	Slow Blink	OFF
Sleep mode AC	OFF	Slow Blink

Slow blink is defined as - 0.5 Hz, 50% duty cycle, i.e. ON for one second, OFF for one second
Fast blink is defined as - 1 Hz, 50 % duty cycle, i.e. On for 500 ms, OFF for 500 ms

Converting from Laptop to Tablet and Back



Open to Laptop Position

1. Pivot both **locking handles** out and down, to free the display.
2. Press the **open display latch** while lifting the display.
3. Lift the display to vertical position for laptop mode.

Convert from Laptop to Tablet

1. Open the display to a vertical position as described above.
2.  Rotate the display in **CLOCKWISE** direction 180 until the display stop-peg clicks into the receiver on the base chassis.
3. Close the display, making sure it rests between the alignment guides on the nylon corner mounts.
4. Press the **locking display latch** until it engages the latch catch.
5. Pivot the **locking handles** up and in until they engage the locking tab on the display.

Convert from Tablet to Laptop

1. Pivot both **locking handles** out and down, to free the display.
2. Press the **open display latch** while lifting the display.
3. Open the display to a vertical position.
4. Rotate the display in counter-clockwise direction 180 until the display stop-clicks into the receiver on the base chassis.
5. Adjust screen to desired viewing angle.

Close from Laptop Position

1. Pull display down toward the keyboard.
2. Hold in position.
3. Press **locking display latch**.
4. Release pressure on display.
5. Pivot both **locking handles** up and inward until they engage the locking tab on the display.

Windows Set-up

The first time you power on your ReVolution, a series of screens will inform you of operating system setup options and prompt you for personal preferences. Simply follow the onscreen instructions to finish the setup of your operating environment.

Accessing the User Manual

To view or obtain additional copies of this *ReVolution User Manual*, you may:

1. Insert the ReVolution Utility CD that came with the original shipment of your ReVolution computer. This CD contains an electronic copy of the manual.
2. Go to www.kontronmobile.com. Select the following path: Technical Support → Technical Search → Manual.
3. Call or write the Kontron Technical Support department to order additional hard copies. Contact information is located on the Technical Support page.

This page was intentionally left blank.

Modifying the System

This section describes how to use and adjust the components and devices of the ReVolution. You will find instructions for removing and inserting the following components:

- Alternative Display
- Battery Pack
- Hard Disk Drive-Master
- Left Bay Modules (CD-ROM, Floppy Disk Drive, etc.)
- PCMCIA Cards
- Shoulder Straps

You will find information about the following devices in this section:

- Audio
- Chipset
- LAN
- Modem
- Touchscreen
- Touch Pad
- USB 2.0
- Video
- Wireless 802.11b
- Wireless Bluetooth
- CD-ROM
- DVD
- Power Management Modes
- Volume Level

You can find device drivers for operating systems such as Microsoft Windows on the ReVolution Utilities CD shipped with the unit. Occasionally there will be special instructions on how to properly install a device driver. These instructions are stored in the directory of the device driver in a text file for your reference.

Drivers on the ReVolution Utilities CD include:

- Audio
- Chipset
- LAN
- Modem
- Touchscreen
- Touch Pad
- USB 2.0
- Video
- Speed Step
- Wireless 802.11b
- Wireless Bluetooth

Alternative Display

For some applications, you may want to use an additional SVGA monitor. To connect an SVGA display to your ReVolution, you must use an optional I/O extension stick (port replicator).

Battery Packs

The right front bay only accepts a lithium ion battery pack that will provide approximately 3.5 hours of operating time. This bay contains the main or primary battery source. This section describes how to remove a battery pack from, and insert one into, the right front bay. Refer to the “**Left Bay Modules**” section for information on removing and inserting an additional or secondary battery pack into the left bay. Refer to the “**Power Management Modes**” section for more information on battery operations.



- *The photograph above shows the angles at which you insert a battery into the right bay and left bay.*
- *Insert a battery into the right bay sideways, with battery label facing up and a set of the battery contact points facing away from you and positioned in the front LEFT portion of the battery pack.*
- *Insert a battery into the left bay length-wise, with battery label up and a set of battery contact point facing away from you and positioned in the front RIGHT portion of the battery pack .*
- *If two batteries are inserted and both are charged, the computer can be on when you remove or insert one or the other of the batteries.*
- *If two batteries are used during operation, the system is designed to deplete the “secondary” or Left Bay battery first.*

Removing Battery from Right Bay



- Open door of right front bay.
- Turn unit over.



- Push ejector latch forward.
- The battery pack ejects.

Inserting Battery into Right Bay

To insert a battery into the right front bay:

- Open the right bay door.
- Insert a battery into the right bay sideways, with battery label facing up. A set of the battery contact points facing away from you and positioned in the front LEFT portion of the battery pack.
- Align the latch post at the bottom of the battery with the receiving slot on the bottom of the bay.
- Carefully slide the battery into the bay until it locks into place.
- Close and lock the door.



- ❑ ***The system will notify you when the main power source has been lost, and the unit is running on battery power. When the system is running on battery power, the computer will sustain approximately 3.5 hours of operating time.***
- ❑ ***The system will monitor the presence of external input voltage and the battery pack voltage. It will begin to charge whenever it detects a low battery voltage condition and stop charging when one or both batteries are fully charged.***
- ❑ ***The system charges one battery at a time, charging the left battery fully, then the right battery.***
- ❑ ***Charge time with system power off takes up to 3.5 hours per battery. With system power on, charge time takes up to 7 hours per battery.***
- ❑ ***For faster battery charging, Kontron recommends the optional external battery charger listed in the “Base Unit and Optional Parts” section of this manual.***

Hard Disk Drive - Master

The ReVolution comes standard with a master removable hard disk drive, located inside the bottom panel. An upgrade to 60GB is available. The following two series of photographs demonstrate how to remove and insert a hard disk drive module.



- **Turn off the computer before removing or inserting the hard disk drive module.**

Removing a Hard Disk Drive (HDD)



- Make sure all module doors are closed.
- Lay unit on its top.
- Push slide latch to right
- Remove door.



- Lift handle on HDD module to 90° angle.



- Slide module back until it disengages from connector.
- Lift module straight up.

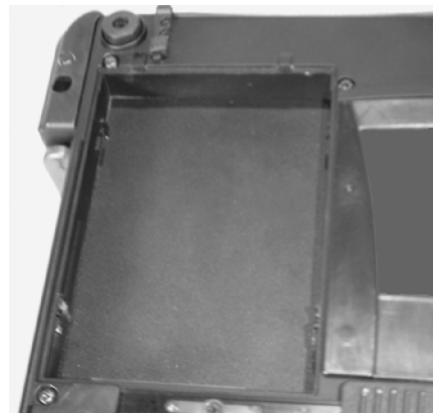

- Remove module from bay.

Inserting a Hard Disk Drive (HDD)

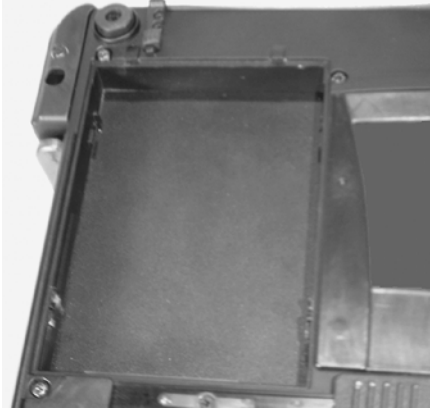

- Close top display so only metal is exposed.
- Lay unit on its top.
- Push slide latch to right.
- Remove HDD door.



- Lift handle on HDD module up to 90° angle.
- Align posts on sides of module with receiving slots in HDD bay.



- Push module down until it reaches bottom of the bay.
- Pull forward until it fully engages HDD connector.
- Press handle back down. The module must be fully engaged with the connector for the handle to fit down.



- Replace HDD module door.



- Move slide latch left until it reaches stop point.

Left Bay Modules

The left front bay of the ReVolution accepts the following modules:

- CD-ROM
- CD-RW (read-write)
- Floppy Disk Drive
- DVD
- DVD/CD-RW Combo
- Slave Hard Disk Drive
- Battery Pack

All these modules can be inserted and removed from the left bay in the same manner, as demonstrated below. The computer can be on when performing these functions. However, if the modules are not in the bay when the system is started, the system will not recognize them if added or swapped while the system is running. You will have to reboot for the system to detect the module.

CD-ROM, CD-RW, DVD and DVD/CD-RW Modules



- *Use of controls, adjustments or performance of procedures other than those specified herein may result in hazardous laser radiation exposure.*



- *The laser beam used in any laser equipped drive unit can be harmful to the eyes. Never look directly at the laser read head while changing discs.*



- *Use discs that bear the COMPACT DISC logo.*
- *Handle discs by their edges.*
- *Store discs in their cases to minimize dust, contamination, scratches, bending or other damage.*
- *Periodically wipe each disc with a soft, dry cloth, gently rubbing outward from the center.*



DO NOT:

- *Expose computer to a sudden impact or excessive vibration.*
- *Touch the bottom surface of the disc.*
- *Bend a disc.*
- *Write on a disc with a hard object, such as a ballpoint pen or pencil.*
- *Affix any label directly on a disc.*
- *Expose discs to direct sunlight.*
- *Store discs in areas subject to high temperatures or humidity.*
- *Use fluids such as Benzene, record cleaning fluid, or anti-static fluid, that can damage the drive mechanism or lens.*

Removing any Left Bay Module



- Push ejector latch forward.
- The module ejects.
- Remove module carefully and place it in a safe, clean location.

Inserting any Left Bay Module

To insert any of the modules listed above:

- Place the computer right-side up.
- Open the door of the left front bay.
- Align the latch post at the bottom of the module with the receiving slot on the bottom of the bay.
- Carefully slide the module into the bay until it locks into place.



- ***Align the groove on the battery bottom with the guide in the bay to insert properly.***

PCMCIA Cards

Two PCMCIA slots on the back interface panel accept two Type II PC Cards or one Type III PC Card. You can insert and remove the cards while the computer is on.

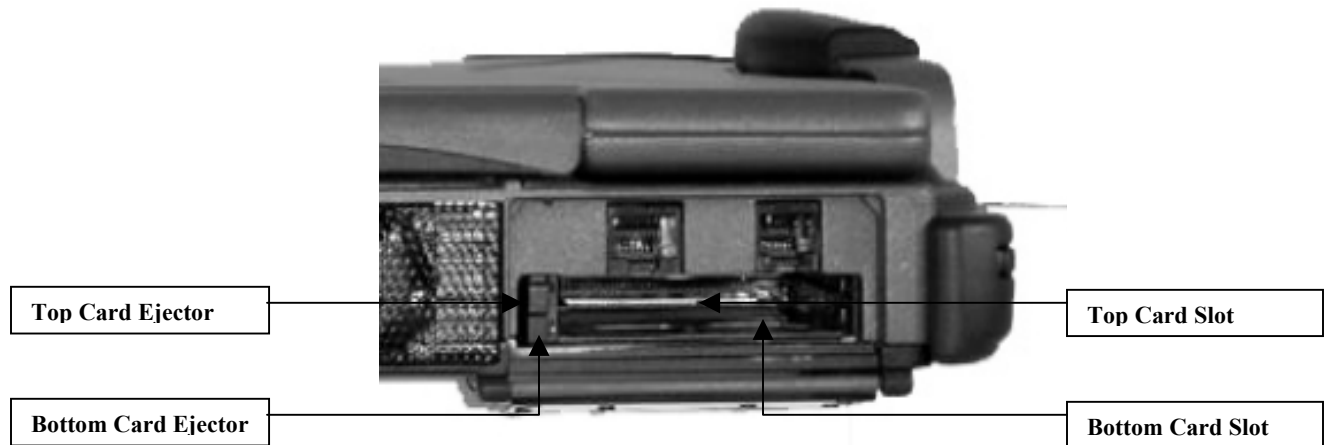

To insert a PC card, carefully slide the card right-side up into one of the card slots until the card clicks.



To remove a card from the top card slot, press the top card ejector button.
To remove a card from the bottom card slot, press the bottom card ejector.



- *The peak power consumption of each of the PCMCIA slots may not exceed 3.3 Watts Peak (600 mA at +5 V).*
- *Follow the card manufacturer's instructions in the PC Card documentation.*
- *Do not force a PC Card into or out of the slot.*
- *Prevent external debris from entering the slot.*
- *Make sure that the PC cards all have the legally prescribed approvals (e.g. IEC/EN 60950).*
- *The ReVolution has an extended temperature range. This might be not the case with your PC Card. Please note that the operating temperature range could be decreased for the whole system depending on the manufacturer's recommended temperature range for the PC card that you want to use.*

Shoulder Straps

All four corners of the ReVolution have a catch on which to attach a shoulder strap. Choose the two corners most comfortable for you. The following photographs display how to attach the two ends of the strap to the computer.

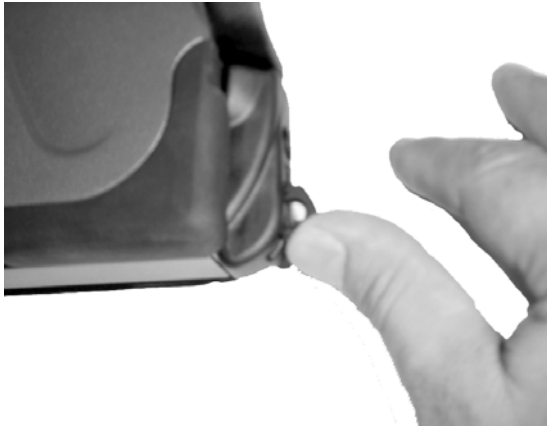

- Extract the recessed catch from the corner.



- Attach the hook end of the shoulder strap to the catch.
- Repeat steps one and two with another corner.



The shoulder strap attaches to any two of the four corners.

Audio

The audio system is made up of an AD1881A, which meets the Audio Codec '97 2.0 and 2.1 Extensions. The main architectural features of the AD1881A are the high-quality analog mixer section, two channels of $\Sigma\Delta$ ADC conversion, two channels of $\Sigma\Delta$ DAC conversion with Data Direct Scrambling (D²S) rate generators.

The audio system has three 3.5 mm diameter jacks: a microphone input, speaker output and line in.

- The **Microphone Jack** allows you to receive monophonic input from an external microphone.
- The **Speaker Output Jack** allows you to directly drive external speakers at 1W.
- The **Line-In Jack** allows you to receive stereo line-level audio input from an external source.

This audio system enables you to enjoy various multimedia audio features. This audio chip provides the following features and more:

- Recording and playing back of PCM and WAV files in 8-bit or 16-bit format.
- Sampling of various rates from 8 KHz to 48 KHz for the WAV file.
- Playback of MIDI files through an FM synthesizer.
- Recording from various sound sources, such as an integrated microphone, an external microphone, or an audio device attached to the line-in jack.

Volume Level

The ReVolution will adjust the speaker output level when you change the **volume slider** on the Windows task bar or press the **volume up/down** function keys.

CD-ROM, CD-RW, DVD and DVD/CD-RW Combo Module Drives



- *All these modules can be inserted and removed from the left bay in the same manner. The computer can be on when performing these functions. However, if the modules are not in the bay when the system is started, the system will not recognize them if added or swapped while the system is running. You will have to reboot for the system to detect the module.*

Software Installation- CD writer

With the CD-RW drive module installed in the ReVolution, you can record using CD-R(CD-Recordable) or CD-RW (CD-ReWritable) discs. Types of files you can record are backup files, pictures and movies, or your own creation of audio files. Easy to use CD recording software is included with the CD-RW drive.

For more information, refer to the CD-RW software provided with the drive package.

Software Installation - DVD player

With the DVD drive installed in the ReVolution, you can play DVD movies. Easy to use DVD software is included with the DVD drive.

For more information, refer to the DVD software provided with the drive package.

Chipset

The ReVolution uses the Intel 830M and ICH3 chipset. This chipset incorporates the Video, IDE, USB, and AC97 sub-systems. Specialized operating system drivers are located on the utilities CD shipped with your ReVolution and must be installed to maximize the performance of this chipset. If you ordered your ReVolution with an operating system pre-installed you will not need to install these drivers, these drivers are installed for you at the factory.

Driver Installation: Chipset

The Intel chipset driver is installed at the factory for your ReVolution. If special instructions are available for driver installation for the chipset, you will find these instructions in the directory that contains the driver.

Driver Installation: Application Accelerator

The Intel Application Accelerator software is designed to improve hard drive interface performance. Review the documents in the application accelerator directory on the CD or on Intel's web site to learn more about the details of this software.

LAN - Embedded

The built-in network feature allows you to connect your computer to an Ethernet-based (10/100) Mbps) network via the RJ-45 jack. To use the network feature, connect an Ethernet cable from the network jack on the rear of the computer to a network jack or hub on your network.

Modem

Via the RJ-11 on the back interface panel, you have access to a PCI V.90/K56flex modem. This modem design is based on Lucent Technologies L56xMF (Mars II) PCI bus host-based modem controller chip set. This chip set has a high level of integration with the advantage of letting the DSP perform MIPS-intensive operations, such as V.90 and K56flex, while consuming the host with less MIPS-intensive functions, such as V.42bis.

This modem includes data, fax and TAM (telephone answering machine) functions. It complies fully with Microsoft's PC98 and PC99 requirements, and supports both APM and ACPI power management.

The DAA of this modem is designed to comply with the regulations of the following countries:

- -America: US, Canada
- -Asia: Japan, Malaysia, Singapore, Hong Kong, Australia, New Zealand
- -Europe: CTR21 - 18 European Countries:
Austria, Belgium, Denmark, Finland, France, Germany, Greece, Iceland, Ireland, Italy, Luxembourg, Norway, Portugal, Spain, Sweden, Switzerland, Netherlands and UK.

You can use the built-in modem only on a public-switched telephone network (PSTN). You cannot use a private branch exchange (PBX) or some other type of digital telephone extension line. If you connect the built-in modem to a line other than PSTN, an error message appears, preventing you from using the line. If you are not sure which kind of phone line you are using, contact your telephone company.

Power Management Modes

Windows

Your ReVolution will manage power consumption while running the Windows operating system, based on the settings in Windows Control Panel power options. To maximize battery run-time, be aware of the settings affecting power consumption. In addition to Control Panel power options, the following items can influence battery run time:

- LCD backlight level
- Intel Speed Step mode
- Wireless network settings

Set the power management properties for your application in Windows Power Options.

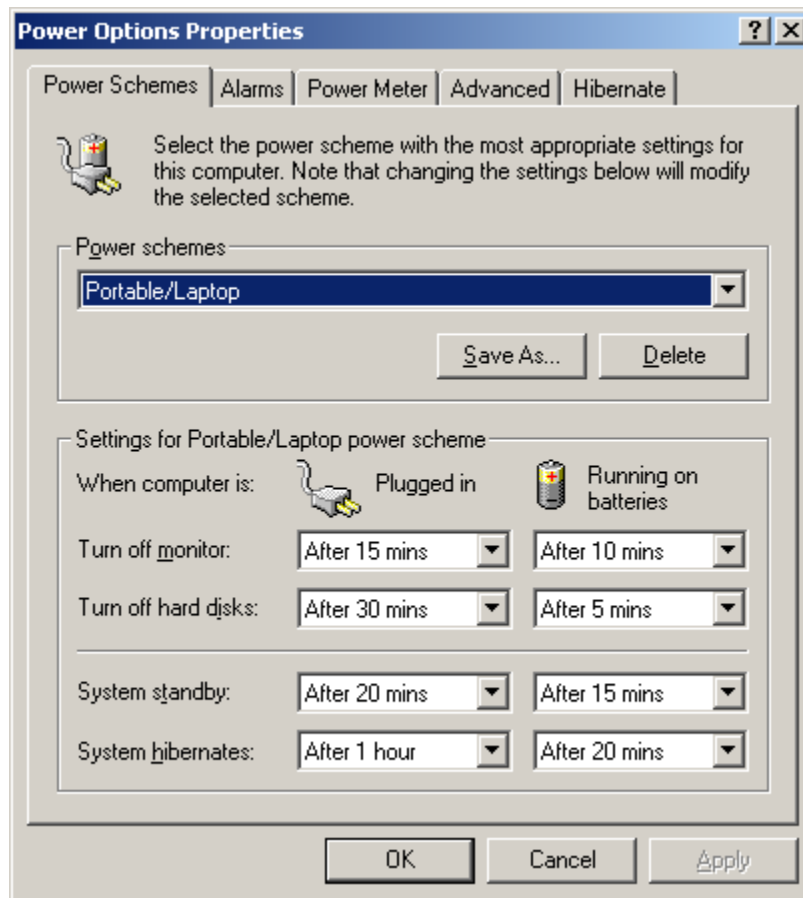

If you are running an operating system that does not fully support power management (APM or ACPI), such as Legacy, you can set basic power management features in BIOS setup. Refer to the "**Phoenix BIOS Setup**" section in this document for these settings.