



**CFR 47 FCC PART 15 SUBPART E
CERTIFICATION TEST REPORT**

For

Home Gateway

MODEL NUMBER: ZXHH H196Q

FCC ID: Q78-ZXHH196Q

REPORT NUMBER:4789807220-3

ISSUE DATE: March 31, 2021

Prepared for

ZTE CORPORATION

**ZTE Plaza, Keji Road South, Hi-Tech, Industrial Park, Nanshan District, Shenzhen,
Guangdong, P.R.China**

Prepared by

UL Verification Services (Guangzhou) Co., Ltd, Song Shan Lake Branch

**Building 10, Innovation Technology Park, No. 1, Li Bin Road, Song Shan Lake Hi-
Tech Development Zone Dongguan, 523808, People's Republic of China**

Tel: +86 769 22038881

Fax: +86 769 33244054

Website: www.ul.com



Revision History

<u>Rev.</u>	<u>Issue Date</u>	<u>Revisions</u>	<u>Revised By</u>
V0	04/01/2021	Initial Issue	



Summary of Test Results			
Clause	Test Items	FCC Rules	Test Results
1	6dB/26dB Bandwidth	FCC 15.407 (a)&(e)	PASS
2	99% Occupied Bandwidth	RSS-Gen Clause 6.6	PASS
3	Conducted Output Power	FCC 15.407 (a)	PASS
4	Power Spectral Density	FCC 15.407 (a)	PASS
5	Radiated Bandedge and Spurious Emission	FCC 15.407 (b) FCC 15.209 FCC 15.205	PASS
6	Conducted Emission Test for AC Power Port	FCC 15.207	PASS
7	Frequency Stability	FCC 15.407 (g)	PASS
8	Antenna Requirement	FCC 15.203	PASS
Note: 1. This test report is only published to and used by the applicant, and it is not for evidence purpose in China. 2. The measurement result for the sample received is <Pass> according to < CFR 47 FCC PART 15 SUBPART C >when <Accuracy Method> decision rule is applied.			



TABLE OF CONTENTS

1. ATTESTATION OF TEST RESULTS	7
2. TEST METHODOLOGY	8
3. FACILITIES AND ACCREDITATION	8
4. CALIBRATION AND UNCERTAINTY	9
4.1. <i>MEASURING INSTRUMENT CALIBRATION</i>	9
4.2. <i>MEASUREMENT UNCERTAINTY</i>	9
5. EQUIPMENT UNDER TEST	10
5.1. <i>DESCRIPTION OF EUT</i>	10
5.2. <i>MAXIMUM OUTPUT POWER</i>	11
5.3. <i>CHANNEL LIST</i>	12
5.4. <i>DESCRIPTION OF AVAILABLE ANTENNAS</i>	13
5.5. <i>THE WORSE CASE POWER SETTING PARAMETER</i>	14
5.6. <i>THE WORSE CASE CONFIGURATIONS</i>	16
5.7. <i>DESCRIPTION OF TEST SETUP</i>	17
6. MEASURING INSTRUMENT AND SOFTWARE USED	18
7. ANTENNA PORT TEST RESULTS	20
7.1. <i>ON TIME AND DUTY CYCLE</i>	20
7.2. <i>6/26 dB EMISSION BANDWIDTH AND 99 % OCCUPIED BANDWIDTH</i>	21
7.3. <i>CONDUCTED OUTPUT POWER</i>	23
7.4. <i>POWER SPECTRAL DENSITY</i>	26
8. RADIATED TEST RESULTS	28
8.1. <i>RESTRICTED BANDEDGE</i>	34
8.1.1. <i>802.11a CDD 4TX MODE</i>	34
UNII-1 BAND	34
UNII-2A BAND	36
UNII-2C BAND.....	38
UNII-3 BAND	41
8.1.2. <i>802.11ac VHT20 CDD 4TX MODE</i>	43
UNII-1 BAND	43
UNII-2A BAND	45
UNII-2C BAND.....	47
UNII-3 BAND	50
8.1.3. <i>802.11ac VHT40 CDD 4TX MODE</i>	52
UNII-1 BAND	52
UNII-2A BAND	54
UNII-2C BAND.....	56



UNII-3 BAND	59
8.1.4. 802.11ac VHT80 CDD 4TX MODE	61
UNII-1 BAND	61
UNII-2A BAND	63
UNII-2C BAND	65
UNII-3 BAND	68
8.2. SPURIOUS EMISSIONS (1 GHz ~ 7 GHz)	69
8.2.1. 802.11a CDD 4TX MODE	69
UNII-1 BAND	69
UNII-2A BAND	75
UNII-2C BAND	81
UNII-3 BAND	87
8.3. SPURIOUS EMISSIONS (7 GHz ~ 18 GHz)	93
8.3.1. 802.11a CDD 4TX MODE	93
UNII-1 BAND	93
UNII-2A BAND	99
UNII-2C BAND	105
UNII-3 BAND	111
8.3.2. 802.11ac VHT20 CDD 4TX MODE	117
UNII-1 BAND	117
UNII-2A BAND	123
UNII-2C BAND	129
UNII-3 BAND	135
8.3.3. 802.11ac VHT40 CDD 4TX MODE	141
UNII-1 BAND	141
UNII-2A BAND	145
UNII-2C BAND	149
UNII-3 BAND	155
8.3.4. 802.11ac VHT80 CDD 4TX MODE	159
UNII-1 BAND	159
UNII-2A BAND	161
UNII-2C BAND	163
UNII-3 BAND	167
8.4. SPURIOUS EMISSIONS (18 GHz ~ 26 GHz)	169
8.4.1. 802.11ac VHT20 CDD 4TX MODE	169
8.5. SPURIOUS EMISSIONS (26 GHz ~ 40 GHz)	171
8.5.1. 802.11ac VHT20 CDD 4TX MODE	171
8.6. SPURIOUS EMISSIONS (30 MHz ~ 1 GHz)	173
8.6.1. 802.11ac VHT20 CDD 4TX MODE	173
8.7. SPURIOUS EMISSIONS BELOW 30 MHz	175
8.7.1. 802.11ac VHT20 CDD 4TX MODE	175
8.8. SPURIOUS EMISSIONS FOR SIMULTANEOUS TRANSMISSION	178
8.8.1. UNII-2A 802.11a 4TX MODE AND 802.11b MODE	178
9. AC POWER LINE CONDUCTED EMISSIONS	182
9.1. 802.11ac VHT20 CDD 4TX MODE	183
10. FREQUENCY STABILITY	185



11. ANTENNA REQUIREMENTS..... 187

Appendix A1: 26dB Emission Bandwidth 188

 Test Result..... 188

 Test Graphs 189

Appendix A2: 99% Occupied channel bandwidth.....202

 Test Result.....202

 Test Graphs203

Appendix A3: 6dB Emission bandwidth.....216

 Test Result.....216

 Test Graphs217

Appendix B: Maximum AVG conducted output power220

 Test Result.....220

Appendix C: Maximum power spectral density224

 Test Result.....224

 Test Graphs228

Appendix D: Duty Cycle279

 Test Result.....279

 Test Graphs280

Appendix E: Frequency Stability282

 Test Result.....282



1. ATTESTATION OF TEST RESULTS

Applicant Information

Company Name: ZTE CORPORATION
Address: ZTE Plaza, Keji Road South, Hi-Tech, Industrial Park, Nanshan District, Shenzhen, Guangdong, P.R.China

Manufacturer Information

Company Name: ZTE CORPORATION
Address: ZTE Plaza, Keji Road South, Hi-Tech, Industrial Park, Nanshan District, Shenzhen, Guangdong, P.R.China

EUT Information

EUT Name: Home Gateway
Model: ZXHH H196Q
Sample Received Date: February 4, 2021
Sample Status: Normal
Sample ID: 3615510
Date of Tested: February 4 ~ March 31, 2021

APPLICABLE STANDARDS	
STANDARD	TEST RESULTS
CFR 47 FCC PART 15 SUBPART E	PASS

Prepared By:

Kebo Zhang
Project Engineer

Check By:

Shawn Wen
Laboratory Leader

Approved By:

Stephen Guo
Laboratory Manager



2. TEST METHODOLOGY

The tests documented in this report were performed in accordance with ANSI C63.10-2013, CFR 47 FCC Part 2, CFR 47 FCC Part 15, KDB 789033 D02 v02r01, KDB414788 D01 Radiated Test Site v01 and KDB 662911 D01 Multiple Transmitter Output v02r01.

3. FACILITIES AND ACCREDITATION

Accreditation Certificate	<p>A2LA (Certificate No.: 4102.01) UL Verification Services (Guangzhou) Co., Ltd. Song Shan Lake Branch. has been assessed and proved to be in compliance with A2LA.</p> <p>FCC (FCC Designation No.: CN1187) UL Verification Services (Guangzhou) Co., Ltd. Song Shan Lake Branch. Has been recognized to perform compliance testing on equipment subject to the Commission's Declaration of Conformity (DoC) and Certification rules</p> <p>ISED (Company No.: 21320) UL Verification Services (Guangzhou) Co., Ltd. Song Shan Lake Branch. has been registered and fully described in a report filed with ISED. The Company Number is 21320 and the test lab Conformity Assessment Body Identifier (CABID) is CN0046.</p> <p>VCCI (Registration No.: G-20019, R-20004, C-20012 and T-20011) UL Verification Services (Guangzhou) Co., Ltd. Song Shan Lake Branch. has been assessed and proved to be in compliance with VCCI, the Membership No. is 3793. Facility Name: Chamber D, the VCCI registration No. is G-20019 and R-20004 Shielding Room B, the VCCI registration No. is C-20012 and T-20011</p>
---------------------------	--

Note 1: All tests measurement facilities use to collect the measurement data are located at Building 10, Innovation Technology Park, Song Shan Lake Hi tech Development Zone, Dongguan, 523808, China

Note 2: The test anechoic chamber in UL Verification Services (Guangzhou) Co., Ltd. Song Shan Lake Branch had been calibrated and compared to the open field sites and the test anechoic chamber is shown to be equivalent to or worst case from the open field site.

Note 3: For below 30 MHz, lab had performed measurements at test anechoic chamber and comparing to measurements obtained on an open field site. And these measurements below 30 MHz had been correlated to measurements performed on an OFS.



4. CALIBRATION AND UNCERTAINTY

4.1. MEASURING INSTRUMENT CALIBRATION

The measuring equipment utilized to perform the tests documented in this report has been calibrated in accordance with the manufacturer's recommendations and is traceable to recognize national standards.

4.2. MEASUREMENT UNCERTAINTY

Where relevant, the following measurement uncertainty levels have been estimated for tests performed on the apparatus:

Test Item	Uncertainty
Conduction emission	3.62 dB
Radiated Emission (Included Fundamental Emission) (9 kHz ~ 30 MHz)	2.2 dB
Radiated Emission (Included Fundamental Emission) (30 MHz ~ 1 GHz)	4.00 dB
Radiated Emission (Included Fundamental Emission) (1 GHz to 26 GHz)	5.78 dB (1 GHz ~ 18 GHz)
	5.23 dB (18 GHz ~ 26 GHz)
Duty Cycle	±0.028%
Emission Bandwidth and 99% Occupied Bandwidth	±0.0196%
Maximum Conducted Output Power	±0.766 dB
Maximum Power Spectral Density Level	±1.22 dB
Frequency Stability	±2.76%
Conducted Band-edge Compliance	±1.328 dB
Conducted Unwanted Emissions In Non-restricted Frequency Bands	±0.746 dB (9 kHz ~ 1 GHz)
	±1.328dB (1 GHz ~ 26 GHz)
Note: This uncertainty represents an expanded uncertainty expressed at approximately the 95% confidence level using a coverage factor of k=2.	



5. EQUIPMENT UNDER TEST

5.1. DESCRIPTION OF EUT

EUT Name	Home Gateway
Model	ZXHH H196Q
Radio Technology	IEEE802.11a IEEE802.11n HT20/n HT40 IEEE802.11ac VHT20/VHT40/VHT80
Operation frequency	UNII-1/UNII-2A/UNII-2C/UNII-3
Modulation	OFDM (BPSK,QPSK,16QAM,64QAM,256QAM only in ac mode)
Supply Voltage	AC 120V,60Hz

**5.2. MAXIMUM OUTPUT POWER****UNII-1 BAND**

IEEE Std. 802.11	Frequency (MHz)	Maximum Average Conducted Power (dBm)	Max Average EIRP (dBm)
a 20 4TX CDD	5150 ~ 5250	8.89	14.19
HT20 4TX CDD		Covered by 802.11ac VHT20 4TX CDD	
HT40 4TX CDD		Covered by 802.11ac VHT40 4TX CDD	
ac VHT20 4TX CD		8.98	14.28
ac VHT40 4TX CDD		10.26	15.56
ac VHT80 4TX CDD		11.28	16.58

UNII-2A BAND

IEEE Std. 802.11	Frequency (MHz)	Maximum Average Conducted Power (dBm)
a 20 4TX CDD	5250 ~ 5350	14.06
HT20 4TX CDD		Covered by 802.11ac VHT20 4TX CDD
HT40 4TX CDD		Covered by 802.11ac VHT40 4TX CDD
ac VHT20 4TX CD		14.24
ac VHT40 4TX CDD		14.50
ac VHT80 4TX CDD		11.72

UNII-2C BAND

IEEE Std. 802.11	Frequency (MHz)	Max Power (dBm)
a 20 4TX CDD	5470 ~ 5725	15.04
HT20 4TX CDD		Covered by 802.11ac VHT20 4TX CDD
HT40 4TX CDD		Covered by 802.11ac VHT40 4TX CDD
ac VHT20 4TX CD		15.15
ac VHT40 4TX CDD		15.33
ac VHT80 4TX CDD		12.89

UNII-3 BAND

IEEE Std. 802.11	Frequency (MHz)	Max Power (dBm)
a 20 4TX CDD	5725 ~ 5850	16.87
HT20 4TX CDD		Covered by 802.11ac VHT20 4TX CDD
HT40 4TX CDD		Covered by 802.11ac VHT40 4TX CDD
ac VHT20 4TX CD		17.19
ac VHT40 4TX CDD		16.76
ac VHT80 4TX CDD		17.00

5.3. CHANNEL LIST

UNII-1 (For Bandwidth = 20 MHz)		UNII-1 (For Bandwidth = 40 MHz)		UNII-1 (For Bandwidth = 80 MHz)	
Channel	Frequency (MHz)	Channel	Frequency (MHz)	Channel	Frequency (MHz)
36	5180	38	5190	42	5210
40	5200	46	5230		
44	5220				
48	5240				

UNII-2A (For Bandwidth = 20 MHz)		UNII-2A (For Bandwidth = 40 MHz)		UNII-2A (For Bandwidth = 80 MHz)	
Channel	Frequency (MHz)	Channel	Frequency (MHz)	Channel	Frequency (MHz)
52	5260	54	5270	58	5290
56	5280	62	5310		
60	5300				
64	5320				

UNII-2C (For Bandwidth = 20 MHz)		UNII-2C (For Bandwidth = 40 MHz)		UNII-2C (For Bandwidth = 80 MHz)	
Channel	Frequency (MHz)	Channel	Frequency (MHz)	Channel	Frequency (MHz)
100	5500	102	5510	106	5530
104	5520	110	5550	122	5610
108	5540	118	5590	/	/
112	5560	126	5630		
116	5580	134	5670		
120	5600	/	/		
124	5620				
128	5640				
132	5660				
136	5680				
140	5700				
/	/				

UNII-3 (For Bandwidth = 20 MHz)		UNII-3 (For Bandwidth = 40 MHz)		UNII-3 (For Bandwidth = 80 MHz)	
Channel	Frequency (MHz)	Channel	Frequency (MHz)	Channel	Frequency (MHz)
149	5745	151	5755	155	5775
153	5765	159	5795		
157	5785				
161	5805				
165	5825				

5.4. DESCRIPTION OF AVAILABLE ANTENNAS

Antenna No.	Frequency (MHz)	P/N	Antenna Type	Max Antenna Gain (dBi)
1	5180~5825	RFPCA630715IM5B301	PCB antenna	5.09
2	5180~5825	RFPCA630710IM5B301	PCB antenna	5.30
3	5180~5825	RFPCA453310IMLB301	PCB antenna	4.70
4	5180~5825	RFPCA470910IMLB302	PCB antenna	4.59

The EUT support Cyclic Shift Diversity(CDD) mode.

MIMO output power port and MIMO PSD port summing was performed in accordance with KDB 662911 D01. For the CDD results the Directional Gain was calculated in accordance with the following method.

For output power measurements:

Directional gain= $G_{ANT} + \text{Array Gain} = 5.3 \text{ dBi}$

G_{ANT} : equal to the gain of the antenna having the highest gain

Array Gain = 0 dB (i.e., no array gain) for $N_{ANT} \leq 4$

For power spectral density (PSD) measurements:

Directional gain= $G_{ANT} + \text{Array Gain} = 11.32 \text{ dBi}$

Array Gain = $10 \log(N_{ANT}/N_{SS}) \text{ dB}$.

N_{ANT} : number of transmit antennas

N_{SS} : number of spatial streams, The worst case directional gain will occur when $N_{SS} = 1$

Note : The value of the antenna gain was declared by customer.

IEE Std. 802.11	Transmit and Receive Mode	Description
802.11a	☒4TX, 4RX	ANT 1, 2, 3, 4 can be used as transmitting/receiving antenna.
802.11n HT20	☒4TX, 4RX	ANT 1, 2, 3, 4 can be used as transmitting/receiving antenna.
802.11n HT40	☒4TX, 4RX	ANT 1, 2, 3, 4 can be used as transmitting/receiving antenna.
802.11ac VHT20	☒4TX, 4RX	ANT 1, 2, 3, 4 can be used as transmitting/receiving antenna.
802.11ac VHT40	☒4TX, 4RX	ANT 1, 2, 3, 4 can be used as transmitting/receiving antenna.
802.11ac VHT80	☒4TX, 4RX	ANT 1, 2, 3, 4 can be used as transmitting/receiving antenna.

**5.5. THE WORSE CASE POWER SETTING PARAMETER**

The Worse Case Power Setting Parameter	
Test Software	QA tool

UNII-1

Mode	Rate	Channel	Soft set value
			4 TX
11a	6M	36	03
		40	03
		48	03
11ac VHT20	MCS0	36	03
		40	02
		48	02
11ac VHT40	MCS0	38	05
		46	05
11ac VHT80	MCS0	42	06

UNII-2A

Mode	Rate	Channel	Soft set value
			4 TX
11a	6M	52	0C
		60	0C
		64	0C
11ac VHT20	MCS0	52	0C
		60	0C
		64	0C
11ac VHT40	MCS0	54	0D
		62	0D
11ac VHT80	MCS0	58	08



UNII-2C

Mode	Rate	Channel	Soft set value
			4 TX
11a	6M	100	0D
		120	0D
		140	0D
11ac VHT20	MCS0	100	0D
		120	0D
		140	0D
11ac VHT40	MCS0	102	0E
		118	0E
		134	0E
11ac VHT80	MCS0	106	08
		122	08

UNII-3

Mode	Rate	Channel	Soft set value
			4 TX
11a	6M	149	12
		157	12
		165	12
11ac VHT20	MCS0	149	12
		157	12
		165	12
11ac VHT40	MCS0	151	12
		159	12
11ac VHT80	MCS0	155	12

5.6. THE WORSE CASE CONFIGURATIONS

The EUT was tested in the following configuration(s):

Controlled in test mode using a software application on the EUT supplied by customer. The application was used to enable a continuous transmission and to select the mode, test channels, bandwidth, data rates as required.

Test channels referring to section 5.4.

Maximum power setting referring to section 5.6.

Worst case Data Rates declared by the customer:

802.11a 20 mode: 6 Mbps

802.11n HT20 mode: MCS0

802.11n HT40 mode: MCS0

802.11ac VHT20 mode: MCS0

802.11ac VHT40 mode: MCS0

802.11ac VHT80 mode: MCS0

802.11ac VHT20 and VHT40 mode are different from 802.11nHT20 and HT40 only in control messages, so for these 4 modes, only 802.11n HT20 and 802.11n HT40 worst case power modes test data are recorded in the report .

The EUT has 4 separate antennas which correspond to 4 separate antenna ports. Core 1, Core 2, Core 3 and Core 4 correspond to antenna 1, antenna 2, antenna 3, and antenna 4 respectively.

The measured additional path loss was included in any path loss calculations for all RF cable used during tested.

The EUT support Cyclic Shift Diversity(CDD), They use the same conducted power per chain in any given mode, so we only chose the worst-case mode CDD 4TX for final testing.

5.7. DESCRIPTION OF TEST SETUP

SUPPORT EQUIPMENT

Item	Equipment	Brand Name	Model Name	Remarks
1	Laptop	Lenovo	ThinkPad E480	/
2	Power Adapter	N/A	RD1201500-C55-153MG	Input: 100-240 V ~ 50/60 Hz, 0.6 A Output: 12 V --- 1.5 A
3	USB Disk	Kingston	DataTraveler 100 G3	USB 3.0, 32 GB
4	RJ45 Terminal load	Adafruit	485-4511	/

I/O CABLES

Cable No	Port	Connector Type	Cable Type	Cable Length(m)	Remarks
1	RJ 45 Cable	Unshielded	NO	1.0 m	/
2	RJ 45 Cable	Unshielded	NO	1.0 m	/
3	RJ 45 Cable	Unshielded	NO	1.0 m	/

ACCESSORIES

Item	Accessory	Brand Name	Model Name	Description
/	/	/	/	/

TEST SETUP

The EUT can work in engineering mode with a software.

SETUP DIAGRAM FOR TESTS

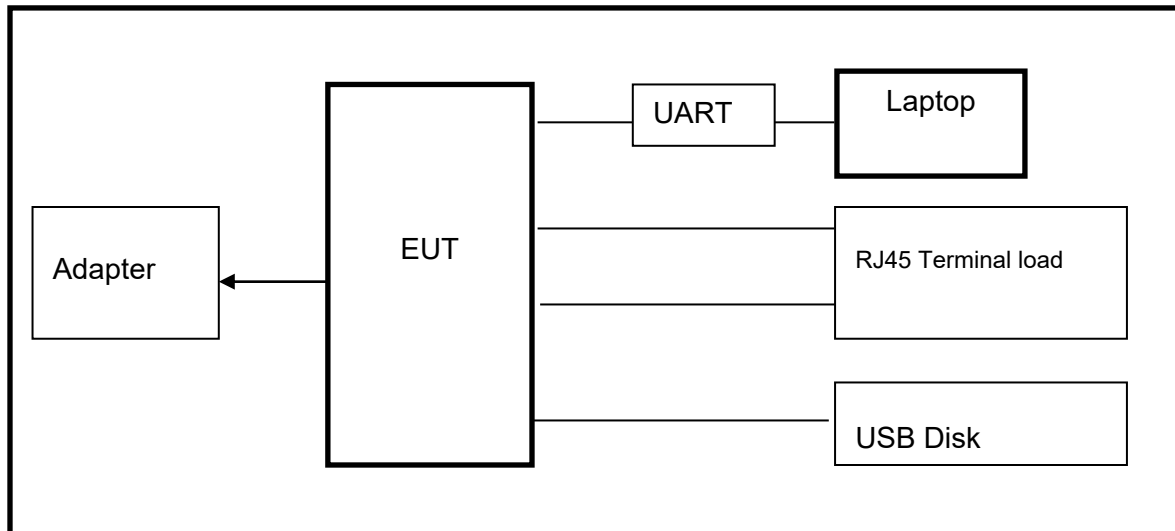

**6. MEASURING INSTRUMENT AND SOFTWARE USED**

Conducted Emissions					
Equipment	Manufacturer	Model No.	Serial No.	Last Cal.	Due Date
EMI Test Receiver	R&S	ESR3	101961	Nov. 12, 2020	Nov. 11, 2021
Two-Line V-Network	R&S	ENV216	101983	Nov. 12, 2020	Nov. 11, 2021
Software					
Description			Manufacturer	Name	Version
Test Software for Conducted Emissions			Farad	EZ-EMC	Ver. UL-3A1
Radiated Emissions					
Equipment	Manufacturer	Model No.	Serial No.	Last Cal.	Due Date
MXE EMI Receiver	KESIGHT	N9038A	MY56400036	Nov. 12, 2020	Nov. 11, 2021
Hybrid Log Periodic Antenna	TDK	HLP-3003C	130960	Aug. 11, 2018	Aug. 10, 2021
Preamplifier	HP	8447D	2944A09099	Nov. 12, 2020	Nov. 11, 2021
EMI Measurement Receiver	R&S	ESR26	101377	Nov. 12, 2020	Nov. 11, 2021
Horn Antenna	TDK	HRN-0118	130939	Sept. 17, 2018	Sept. 17, 2021
Preamplifier	TDK	PA-02-0118	TRS-305-00067	Nov. 20, 2020	Nov. 19, 2021
Horn Antenna	Schwarzbeck	BBHA9170	#691	Aug. 11, 2018	Aug. 11, 2021
Preamplifier	TDK	PA-02-2	TRS-307-00003	Nov. 12, 2020	Nov. 11, 2021
Preamplifier	TDK	PA-02-3	TRS-308-00002	Nov. 12, 2020	Nov. 11, 2021
Loop antenna	Schwarzbeck	1519B	00008	Jan.17, 2019	Jan.17,2022
Preamplifier	TDK	PA-02-001-3000	TRS-302-00050	Nov. 12, 2020	Nov. 11, 2021
Preamplifier	Mini-Circuits	ZX60-83LN-S+	SUP01201941	Nov. 20, 2020	Nov. 19, 2021
Band Reject Filter	Wainwright	WRCJV8-2350-2400-2483.5-2533.5-40SS	4	Nov. 12, 2020	Nov. 11, 2021
Highpass Filter	Wainwright	WHKX10-5850-6500-1800-40SS	4	Nov. 12, 2020	Nov. 11, 2021
Band Reject Filter	Wainwright	WRCJV12-5695-5725-5850-5880-40SS	4	Nov. 12, 2020	Nov. 11, 2021



Band Reject Filter	Wainwright	WRCJV20-5120-5150-5350-5380-60SS	2	Nov. 12, 2020	Nov. 11, 2021
Band Reject Filter	Wainwright	WRCJV20-5440-5470-5725-5755-60SS	1	Nov. 12, 2020	Nov. 11, 2021
Software					
Description		Manufacturer	Name	Version	
Test Software for Radiated Emissions		Farad	EZ-EMC	Ver. UL-3A1	

Tonsend RF Test System					
Equipment	Manufacturer	Model No.	Serial No.	Last Cal.	Due. Date
Wideband Radio Communication Tester	R&S	CMW500	155523	Nov.20,2020	Nov.19,2021
PXA Signal Analyzer	Keysight	N9030A	MY55410512	Nov.20,2020	Nov.19,2021
MXG Vector Signal Generator	Keysight	N5182B	MY56200284	Nov.20,2020	Nov.19,2021
MXG Vector Signal Generator	Keysight	N5172B	MY56200301	Nov.20,2020	Nov.19,2021
DC power supply	Keysight	E3642A	MY55159130	Nov.24,2020	Nov.23,2021
Temperature & Humidity Chamber	SANMOOD	SG-80-CC-2	2088	Nov.20,2020	Nov.19,2021
Software					
Description	Manufacturer	Name		Version	
Tonsend SRD Test System	Tonsend	JS1120-3 RF Test System		2.6.77.0518	

Other Instruments					
Equipment	Manufacturer	Model No.	Serial No.	Last Cal.	Next Cal.
Dual Channel Power Meter	Keysight	N1912A	MY55416024	Nov. 20, 2020	Nov. 19, 2021
Power Sensor	Keysight	USB Wideband Power Sensor	MY5100022	Nov. 20, 2020	Nov. 19, 2021

7. ANTENNA PORT TEST RESULTS

7.1. ON TIME AND DUTY CYCLE

LIMITS

None; for reporting purposes only.

PROCEDURE

Refer to KDB 789033 D02 General U-NII Test Procedures New Rules v02r01 section II.B.

The zero-span mode on a spectrum analyzer or EMI receiver, if the response time and spacing between bins on the sweep are sufficient to permit accurate measurements of the on and off times of the transmitted signal. Set the center frequency of the instrument to the center frequency of the transmission. Set $RBW \geq EBW$ if possible; otherwise, set RBW to the largest available value. Set $VBW \geq RBW$. Set detector = peak or average. The zero-span measurement method shall not be used unless both RBW and VBW are $> 50/T$, where T is defined in II.B.1.a), and the number of sweep points across duration T exceeds 100. (For example, if VBW and/or RBW are limited to 3 MHz, then the zero-span method of measuring duty cycle shall not be used if $T \leq 16.7$ microseconds.)

TEST SETUP

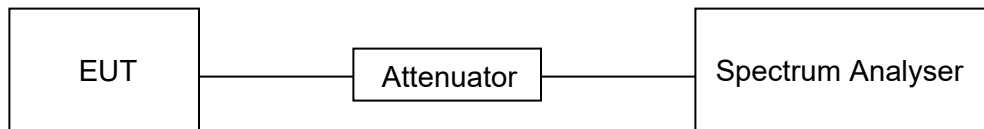

TEST ENVIRONMENT

Temperature	25.5 °C	Relative Humidity	59 %
Atmosphere Pressure	101 kPa	Test Voltage	AC120V,60Hz

RESULTS

Please refer to appendix D.

7.2. 6/26 dB EMISSION BANDWIDTH AND 99 % OCCUPIED BANDWIDTH

LIMITS

CFR 47 FCC Part15, Subpart E		
Test Item	Limit	Frequency Range (MHz)
26 dB Emission Bandwidth	For reporting purposes only.	5150 ~ 5250
26 dB Emission Bandwidth	For reporting purposes only.	5250 ~ 5350
26 dB Emission Bandwidth	For reporting purposes only.	5470 ~ 5725
6 dB Emission Bandwidth	The minimum 6 dB emission bandwidth shall be 500 kHz.	5725 ~ 5850
99 % Occupied Bandwidth	For reporting purposes only.	5150 ~ 5825

TEST PROCEDURE

Refer to KDB 789033 D02 General U-NII Test Procedures New Rules v02r01 section II.C1. for 26 dB Emission Bandwidth; section II.C2. for 6 dB Emission Bandwidth; section II.D. for 99 % Occupied Bandwidth.

Connect the EUT to the spectrum analyser and use the following settings:

Center Frequency	The center frequency of the channel under test
Detector	Peak
RBW	For 6 dB Emission Bandwidth: RBW=100 kHz For 26 dB Emission bandwidth: approximately 1 % of the EBW. For 99 % Occupied Bandwidth: approximately 1 % ~ 5 % of the OBW.
VBW	For 6 dB Bandwidth: $\geq 3 \times \text{RBW}$ For 26 dB Bandwidth: $> \text{RBW}$ For 99 % Bandwidth: $> 3 \times \text{RBW}$
Trace	Max hold
Sweep	Auto couple

- a) Use the 99 % power bandwidth function of the instrument, allow the trace to stabilize and report the measured bandwidth.
- b) Allow the trace to stabilize and measure the maximum width of the emission that is constrained by the frequencies associated with the two outermost amplitude points (upper and lower frequencies) that are attenuated by 6/26 dB relative to the maximum level measured in the fundamental emission.

Calculation for 99 % Bandwidth of UNII-2C and UNII-3 Straddle Channel:

For Example: Fundamental Frequency: 5720 MHz

99 % OBW: 21.00 MHz

Turning Frequency: 5725 MHz

99 % Bandwidth of UNII-2C Band Portion = $(5725-(5720-(21.00/2))) = 15.50$ MHz

99 % Bandwidth of UNII-3 Band Portion = $(5720+(21.00/2)-5725) = 5.50$ MHz

Calculation for 26 dB Bandwidth of UNII-2C Straddle Channel:

For Example: Fundamental frequency: 5720 MHz

26 dB BW: 20.00 MHz

FL: 5710.16 MHz

FH: 5730.16 MHz

Turning Frequency: 5725 MHz

26 dB Bandwidth of UNII-2C Band Portion = $5725-5710.16=14.84$ MHz

Calculation for 6dB Bandwidth of UNII-3 Straddle Channel:

For Example: Fundamental frequency: 5720 MHz

6 dB BW: 16.44 MHz

FL: 5711.76 MHz

FH: 5728.2 MHz

Turning Frequency: 5725 MHz

6 dB Bandwidth of UNII-3 band Portion = $5728.2-5725=3.2$ MHz

TEST SETUP

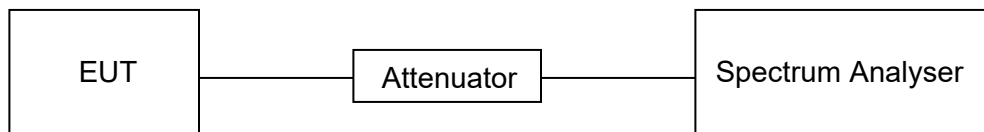

TEST ENVIRONMENT

Temperature	25.5 °C	Relative Humidity	59 %
Atmosphere Pressure	101 kPa	Test Voltage	AC120V,60Hz

RESULTS

Please refer to Appendix A1&A2&A3.



7.3. CONDUCTED OUTPUT POWER

LIMITS

CFR 47 FCC Part15, Subpart E		
Test Item	Limit	Frequency Range (MHz)
Conducted Output Power	<input type="checkbox"/> Outdoor Access Point: 1 W (30 dBm) <input checked="" type="checkbox"/> Indoor Access Point: 1 W (30 dBm) <input type="checkbox"/> Fixed Point-To-Point Access Points: 1 W (30 dBm) <input type="checkbox"/> Client Devices: 250 mW (24 dBm)	5150 ~ 5250
	Shall not exceed the lesser of 250 mW (24dBm) or 11 dBm + 10 log B, where B is the 26 dB emission bandwidth in megahertz.	5250 ~ 5350 5470 ~ 5725
	Shall not exceed 1 Watt (30 dBm).	5725 ~ 5850

Note:

The above limits are based upon the maximum antenna gain does not exceed 6 dBi. If transmitting antennas of directional gain greater than 6 dBi are used, the maximum conducted output power shall be reduced by the amount in dB that the directional gain of the antenna exceeds 6 dBi.

TEST PROCEDURE

Refer to KDB 789033 D02 General U-NII Test Procedures New Rules v02r01 section II.E.

Method SA-1 (trace averaging with the EUT transmitting at full power throughout each sweep):

- (i) Set span to encompass the entire emission bandwidth (EBW) (or, alternatively, the entire 99% occupied bandwidth) of the signal.
- (ii) Set RBW = 1 MHz.
- (iii) Set VBW \geq 3 MHz.
- (iv) Number of points in sweep $\geq 2 \times$ span / RBW. (This ensures that bin-to-bin spacing is \leq RBW/2, so that narrowband signals are not lost between frequency bins.)
- (v) Sweep time = auto.
- (vi) Detector = power averaging (rms), if available. Otherwise, use sample detector mode.
- (vii) If transmit duty cycle $<$ 98 %, use a video trigger with the trigger level set to enable triggering only on full power pulses. Transmitter must operate at maximum power control level for the entire duration of every sweep. If the EUT transmits continuously (i.e., with no off intervals) or at duty cycle \geq 98 %, and if each transmission is entirely at the maximum power control level, then the trigger shall be set to “free run.”
- (viii) Trace average at least 100 traces in power averaging (rms) mode.
- (ix) Compute power by integrating the spectrum across the EBW (or, alternatively, the entire 99% occupied bandwidth) of the signal using the instrument’s band power measurement function with band limits set equal to the EBW (or occupied bandwidth) band edges. If the instrument does not have a band power function, sum the spectrum levels (in power units) at 1 MHz intervals extending across the EBW (or, alternatively, the entire 99% occupied bandwidth) of the spectrum.

Method PM (Measurement using an RF average power meter):

- (i) Measurements may be performed using a wideband RF power meter with a thermocouple detector or equivalent if all of the following conditions are satisfied:
 - a. The EUT is configured to transmit continuously or to transmit with a constant duty cycle.
 - b. At all times when the EUT is transmitting, it must be transmitting at its maximum power control level.
 - c. The integration period of the power meter exceeds the repetition period of the transmitted signal by at least a factor of five.
- (ii) If the transmitter does not transmit continuously, measure the duty cycle, x , of the transmitter output signal as described in II.B.
- (iii) Measure the average power of the transmitter. This measurement is an average over both the on and off periods of the transmitter.
- (iv) Adjust the measurement in dBm by adding $10 \log (1/x)$ where x is the duty cycle (e.g., $10 \log (1/0.25)$ if the duty cycle is 25 %).

Method PM-G (Measurement using a gated RF average power meter):

Measurements may be performed using a wideband gated RF power meter provided that the gate parameters are adjusted such that the power is measured only when the EUT is transmitting at its maximum power control level. Since the measurement is made only during the ON time of the transmitter, no duty cycle correction factor is required.

Straddle channel power was measured using spectrum analyzer.



TEST SETUP

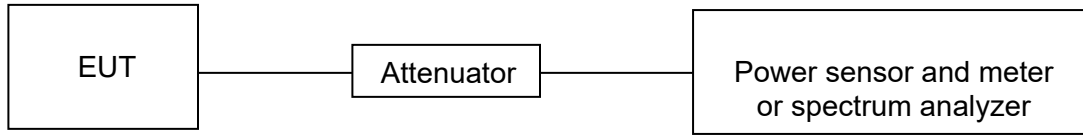

TEST ENVIRONMENT

Temperature	25.5 °C	Relative Humidity	59 %
Atmosphere Pressure	101 kPa	Test Voltage	AC120 V,60 Hz

RESULTS

Please refer to Appendix B.



7.4. POWER SPECTRAL DENSITY

LIMITS

CFR 47 FCC Part15, Subpart E		
Test Item	Limit	Frequency Range (MHz)
Power Spectral Density	<input type="checkbox"/> Outdoor Access Point: 17 dBm/MHz <input checked="" type="checkbox"/> Indoor Access Point: 17 dBm/MHz <input type="checkbox"/> Fixed Point-To-Point Access Points: 17 dBm/MHz <input type="checkbox"/> Client Devices: 11 dBm/MHz	5150 ~ 5250
	11 dBm/MHz	5250 ~ 5350 5470 ~ 5725
	30 dBm/500kHz	5725 ~ 5850

Note:

The above limits are based upon the maximum antenna gain does not exceed 6 dBi. If transmitting antennas of directional gain greater than 6 dBi are used, maximum power spectral density shall be reduced by the amount in dB that the directional gain of the antenna exceeds 6 dBi.

TEST PROCEDURE

Refer to KDB 789033 D02 General U-NII Test Procedures New Rules v02r01 section II.F.

Connect the EUT to the spectrum analyser and use the following settings:

For U-NII-1, U-NII-2A and U-NII-2C band:

Center Frequency	The center frequency of the channel under test
Detector	RMS
RBW	1 MHz
VBW	$\geq 3 \times \text{RBW}$
Span	Encompass the entire emissions bandwidth (EBW) of the signal
Trace	Max hold
Sweep time	Auto

For U-NII-3:

Center Frequency	The center frequency of the channel under test
Detector	RMS
RBW	500 kHz
VBW	$\geq 3 \times \text{RBW}$
Span	Encompass the entire emissions bandwidth (EBW) of the signal
Trace	Max hold
Sweep time	Auto

Allow trace to fully stabilize and Use the peak search function on the instrument to find the peak of the spectrum and record its value.

Add $10 \log(1/x)$, where x is the duty cycle, to the peak of the spectrum, the result is the Maximum PSD over 1 MHz / 500 kHz reference bandwidth.

TEST SETUP

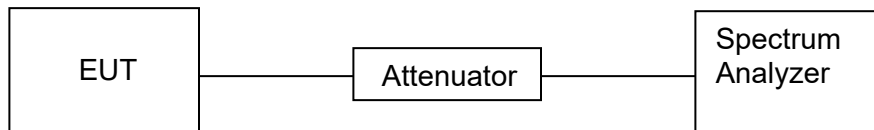

TEST ENVIRONMENT

Temperature	25.5 °C	Relative Humidity	59 %
Atmosphere Pressure	101 kPa	Test Voltage	AC120 V,60 Hz

RESULTS

Please refer to Appendix C.



8. RADIATED TEST RESULTS

LIMITS

Refer to CFR 47 FCC §15.205, §15.209 and §15.407 (b).

Radiation Disturbance Test Limit for FCC (Class B) (9 kHz ~ 1 GHz)

Emissions radiated outside of the specified frequency bands above 30 MHz			
Frequency Range (MHz)	Field Strength Limit (uV/m) at 3 m	Field Strength Limit (dBuV/m) at 3 m	
		Quasi-Peak	
30 - 88	100	40	
88 - 216	150	43.5	
216 - 960	200	46	
Above 960	500	54	
Above 1000	500	Peak	Average
		74	54

FCC Emissions radiated outside of the specified frequency bands below 30 MHz		
Frequency (MHz)	Field strength (microvolts/meter)	Measurement distance (meters)
0.009-0.490	2400/F(kHz)	300
0.490-1.705	24000/F(kHz)	30
1.705-30.0	30	30

FCC Restricted bands of operation refer to FCC §15.205 (a):

MHz	MHz	MHz	GHz
0.090-0.110	16.42-16.423	399.9-410	4.5-5.15
¹ 0.495-0.505	16.69475-16.69525	608-614	5.35-5.46
2.1735-2.1905	16.80425-16.80475	960-1240	7.25-7.75
4.125-4.128	25.5-25.67	1300-1427	8.025-8.5
4.17725-4.17775	37.5-38.25	1435-1626.5	9.0-9.2
4.20725-4.20775	73-74.6	1645.5-1646.5	9.3-9.5
6.215-6.218	74.8-75.2	1660-1710	10.6-12.7
6.26775-6.26825	108-121.94	1718.8-1722.2	13.25-13.4
6.31175-6.31225	123-138	2200-2300	14.47-14.5
8.291-8.294	149.9-150.05	2310-2390	15.35-16.2
8.362-8.366	156.52475-156.52525	2483.5-2500	17.7-21.4
8.37625-8.38675	156.7-156.9	2690-2900	22.01-23.12
8.41425-8.41475	162.0125-167.17	3260-3267	23.6-24.0
12.29-12.293	167.72-173.2	3332-3339	31.2-31.8
12.51975-12.52025	240-285	3345.8-3358	36.43-36.5
12.57675-12.57725	322-335.4	3600-4400	(²)
13.36-13.41			

Note: ¹Until February 1, 1999, this restricted band shall be 0.490-0.510 MHz.

²Above 38.6c

Limits of unwanted/undesirable emission out of the restricted bands refer to CFR 47 FCC §15.407 (b) and ISSED RSS-247 6.2.

LIMITS OF RADIATED EMISSION MEASUREMENT (Above 1GHz)		
Frequency Range (MHz)	EIRP Limit	Field Strength Limit (dBuV/m) at 3 m
5150~5250 MHz	PK: -27 (dBm/MHz)	PK:68.2(dBμV/m)
5250~5350 MHz		
5470~5725 MHz		
5725~5850 MHz	PK: -27 (dBm/MHz) *1 PK: 10 (dBm/MHz) *2 PK: 15.6 (dBm/MHz) *3 PK: 27 (dBm/MHz) *4	PK: 68.2(dBμV/m) *1 PK: 105.2 (dBμV/m) *2 PK: 110.8(dBμV/m) *3 PK: 122.2 (dBμV/m) *4

Note:

*1 beyond 75 MHz or more above of the band edge.

*2 below the band edge increasing linearly to 10 dBm/MHz at 25 MHz above.

*3 below the band edge increasing linearly to a level of 15.6 dBm/MHz at 5 MHz above.

*4 from 5 MHz above or below the band edge increasing linearly to a level of 27 dBm/MHz at the band edge.

TEST SETUP AND PROCEDURE

Below 30 MHz

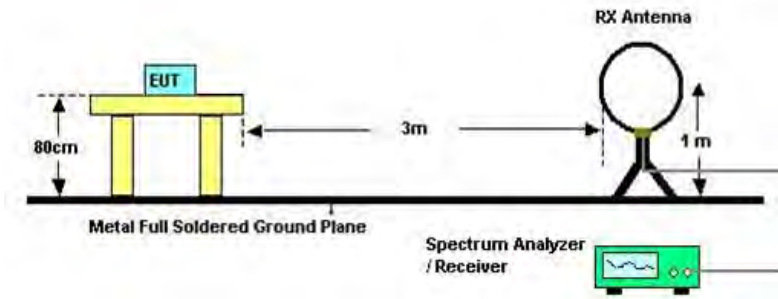

The setting of the spectrum analyser

RBW	200 Hz (From 9 kHz to 0.15 MHz) / 9 kHz (From 0.15 MHz to 30 MHz)
VBW	200 Hz (From 9 kHz to 0.15 MHz) / 9 kHz (From 0.15 MHz to 30 MHz)
Sweep	Auto
Trace	Max hold

- The testing follows the guidelines in ANSI C63.10-2013 clause 6.4.
- The EUT was arranged to its worst case and then turntable (from 0 degree to 360 degrees) to find the maximum reading. A pre-amp and a high pass filter are used for the test in order to get better signal level. Both Horizontal, Face-on and Face-off polarizations of the antenna are set to make the measurement.
- The EUT was placed on a turntable with 80 cm above ground.
- The EUT was set 3 meters from the interference receiving antenna, which was mounted on the top of a 1 m height antenna tower.
- The radiated emission limits are based on measurements employing a CISPR quasi-peak detector except for the frequency bands 9-90 kHz, 110-490 kHz and above 1000 MHz. Radiated emission limits in these three bands are based on measurements employing an average detector.
- For measurement below 1 GHz, the initial step in collecting conducted emission data is a spectrum analyzer peak detector mode pre-scanning the measurement frequency range. Significant peaks are then marked and then Quasi Peak and average detector mode re-measured. If the emission level of the EUT measured by the peak detector is 3 dB lower than the applicable limit, the peak emission level will be reported. Otherwise, the emission measurement will be repeated using the quasi-peak and average detector and reported.
- Although these tests were performed other than open field site, adequate comparison measurements were confirmed against 30 m open field site. Therefore sufficient tests were made to demonstrate that the alternative site produces results that correlate with the ones of tests made in an open field site based on KDB 414788.
- The limits in CFR 47, Part 15, Subpart C, paragraph 15.209 (a), are identical to those in RSS-GEN Section 8.9, Table 6, since the measurements are performed in terms of magnetic field strength and converted to electric field strength levels (as reported in the table) using the free space impedance of 377 Ω . For example, the measurement frequency X kHz resulted in a level of Y dBuV/m, which is equivalent to $Y-51.5 = Z$ dBuA/m, which has the same margin, W dB, to the corresponding RSS-GEN Table 6 limit as it has to be 15.209(a) limit.

Below 1 GHz and above 30 MHz

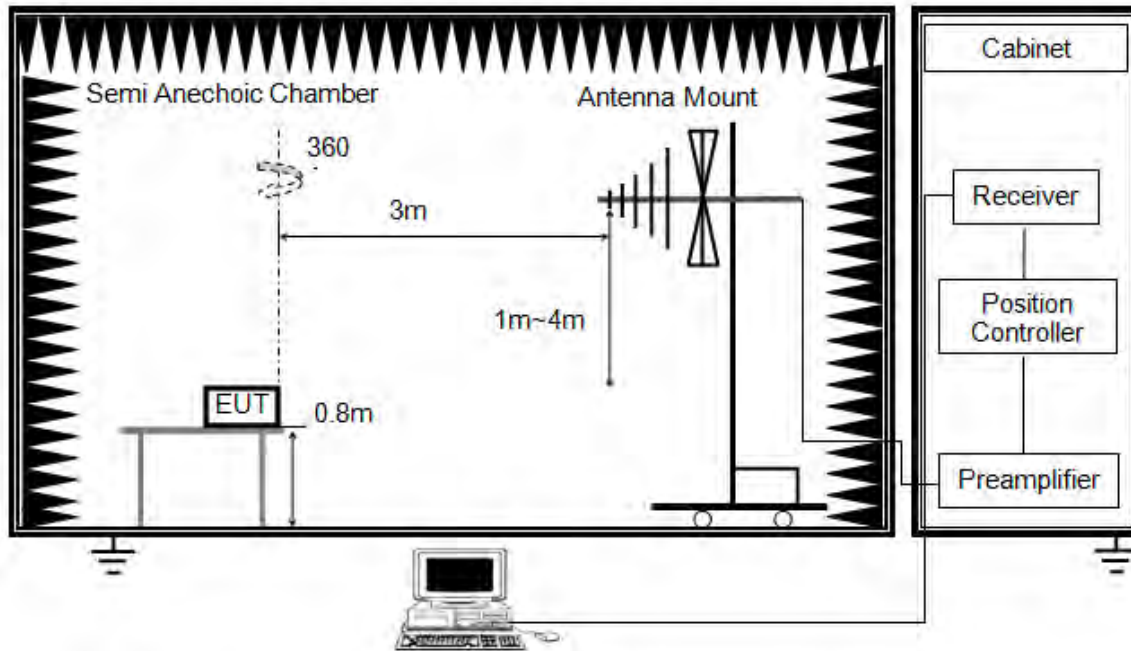

The setting of the spectrum analyser

RBW	120 kHz
VBW	300 kHz
Sweep	Auto
Detector	Peak/QP
Trace	Max hold

1. The testing follows the guidelines in ANSI C63.10-2013 clause 6.5.
2. The EUT was arranged to its worst case and then tune the antenna tower (from 1 m to 4 m) and turntable (from 0 degree to 360 degrees) to find the maximum reading. A pre-amp and a high pass filter are used for the test in order to get better signal level. Both horizontal and vertical polarizations of the antenna are set to make the measurement.
3. The EUT was placed on a turntable with 80 cm above ground.
4. The EUT was set 3 meters from the interference receiving antenna, which was mounted on the top of a variable height antenna tower.
5. For measurement below 1 GHz, the initial step in collecting conducted emission data is a spectrum analyzer peak detector mode pre-scanning the measurement frequency range. Significant peaks are then marked and then Quasi Peak detector mode re-measured. If the emission level of the EUT measured by the peak detector is 3 dB lower than the applicable limit, the peak emission level will be reported. Otherwise, the emission measurement will be repeated using the quasi-peak detector and reported.

Above 1 GHz

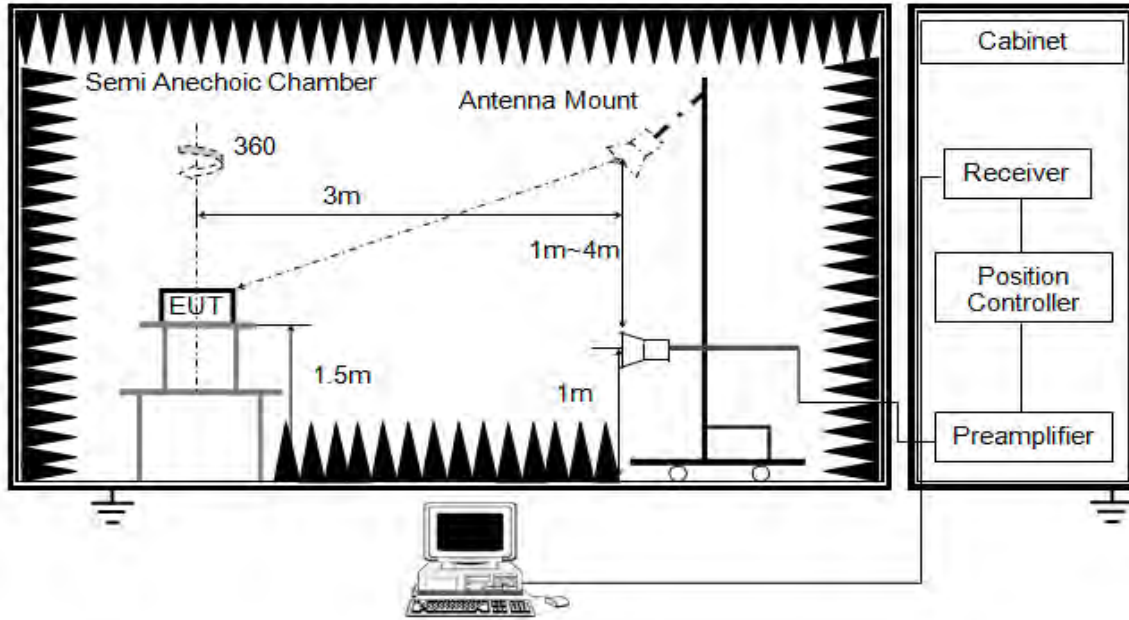

The setting of the spectrum analyser

RBW	1 MHz
VBW	PEAK: 3 MHz AVG: see note 6
Sweep	Auto
Detector	Peak
Trace	Max hold

1. The testing follows the guidelines in KDB 789033 D02 General U-NII Test Procedures New Rules v02r01 section II.G.3 ~ II.G.6.
2. The EUT was arranged to its worst case and then tune the antenna tower (from 1 m to 4 m) and turntable (from 0 degree to 360 degrees) to find the maximum reading. A pre-amp and a high pass filter are used for the test in order to get better signal level. Both horizontal and vertical polarizations of the antenna are set to make the measurement.
3. The EUT was placed on a turntable with 1.5 m above ground.
4. The EUT was set 3 meters from the interference receiving antenna, which was mounted on the top of a variable height antenna tower.
5. For measurement above 1 GHz, the emission measurement will be measured by the peak detector. This peak level, once corrected, must comply with the limit specified in Section 15.209.
6. For measurements above 1 GHz the resolution bandwidth is set to 1 MHz, then the video bandwidth is set to 3 MHz for peak measurements and 1 MHz resolution bandwidth with 1/T video bandwidth with peak detector for average measurements. For the Duty Cycle please refer to clause 7.1.ON TIME AND DUTY CYCLE.

X axis, Y axis, Z axis positions:

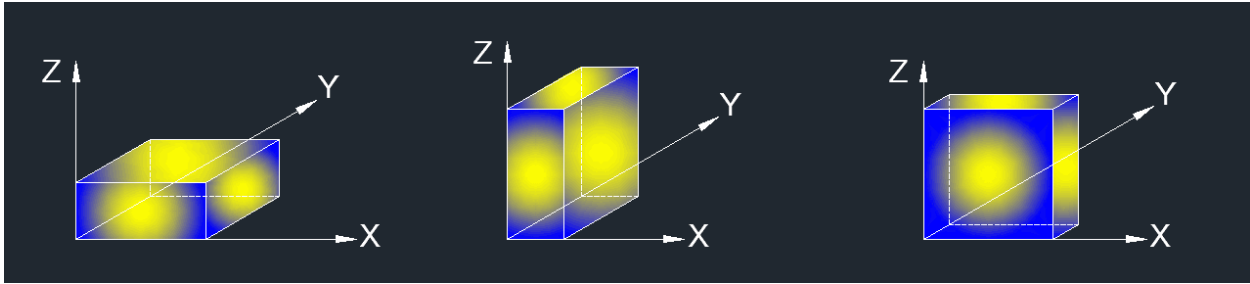

Note 1: For all radiated test, EUT in each of three orthogonal axis emissions had been tested, but only the worst case (X axis) data recorded in the report.

TEST ENVIRONMENT

Temperature	25.5 °C	Relative Humidity	59 %
Atmosphere Pressure	101 kPa	Test Voltage	AC120 V,60 Hz

RESULTS



8.1. RESTRICTED BANDEDGE

8.1.1. 802.11a CDD 4TX MODE

UNII-1 BAND

RESTRICTED BANDEDGE (LOW CHANNEL, HORIZONTAL)

PEAK

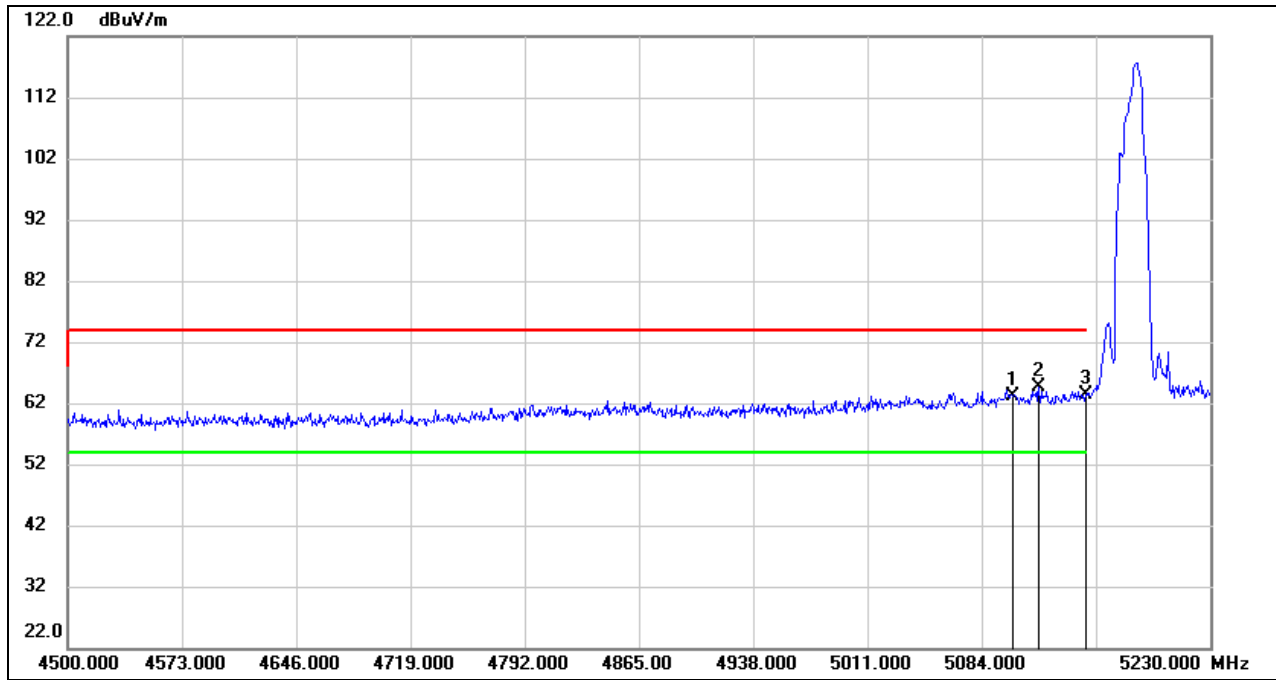

No.	Frequency (MHz)	Reading (dBuV)	Correct (dB/m)	Result (dBuV/m)	Limit (dBuV/m)	Margin (dB)	Remark
1	5103.710	22.39	40.78	63.17	74.00	-10.83	peak
2	5120.500	23.65	40.92	64.57	74.00	-9.43	peak
3	5150.000	22.17	41.19	63.36	74.00	-10.64	peak

Note: 1. Measurement = Reading Level + Correct Factor.
 2. If Peak Result complies with AV limit, AV Result is deemed to comply with AV limit.
 3. Peak: Peak detector.
 4. Only the worst data was recorded, if it complies with the limit, the other emissions deemed to comply with the limit.

AVG

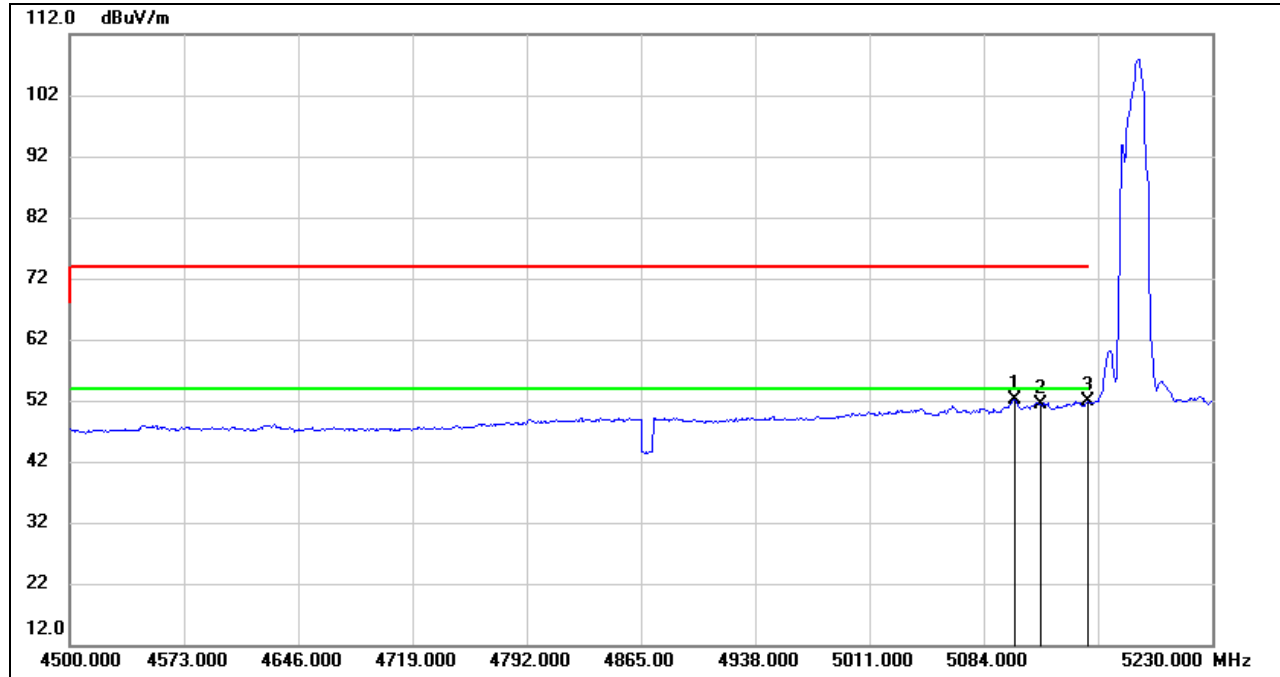

No.	Frequency (MHz)	Reading (dBuV)	Correct (dB/m)	Result (dBuV/m)	Limit (dBuV/m)	Margin (dB)	Remark
1	5103.710	11.40	40.78	52.18	54.00	-1.82	AVG
2	5120.500	10.37	40.92	51.29	54.00	-2.71	AVG
3	5150.000	10.58	41.19	51.77	54.00	-2.23	AVG

- Note:
1. Measurement = Reading Level + Correct Factor.
 2. If Peak Result complies with AV limit, AV Result is deemed to comply with AV limit.
 3. AVG: $VBW=1/T_{on}$, where: T_{on} is the transmitting duration.
 4. For the transmitting duration, please refer to clause 7.1.
 5. Only the worst data was recorded, if it complies with the limit, the other emissions deemed to comply with the limit.

UNII-2A BAND

RESTRICTED BANDEDGE (HIGH CHANNEL, HORIZONTAL)

PEAK

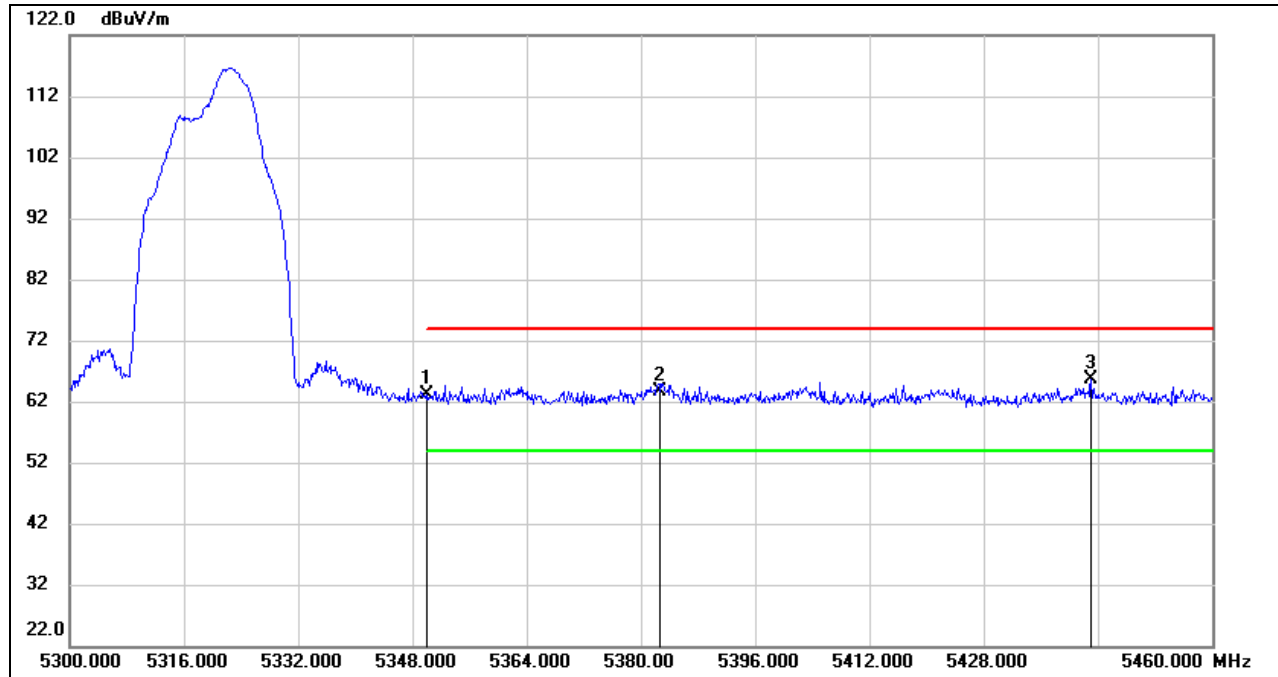

No.	Frequency (MHz)	Reading (dBuV)	Correct (dB/m)	Result (dBuV/m)	Limit (dBuV/m)	Margin (dB)	Remark
1	5350.000	22.01	41.20	63.21	74.00	-10.79	peak
2	5382.720	22.15	41.39	63.54	74.00	-10.46	peak
3	5443.040	23.86	41.72	65.58	74.00	-8.42	peak

Note: 1. Measurement = Reading Level + Correct Factor.
 2. If Peak Result complies with AV limit, AV Result is deemed to comply with AV limit.
 3. Peak: Peak detector.
 4. Only the worst data was recorded, if it complies with the limit, the other emissions deemed to comply with the limit.

AVG

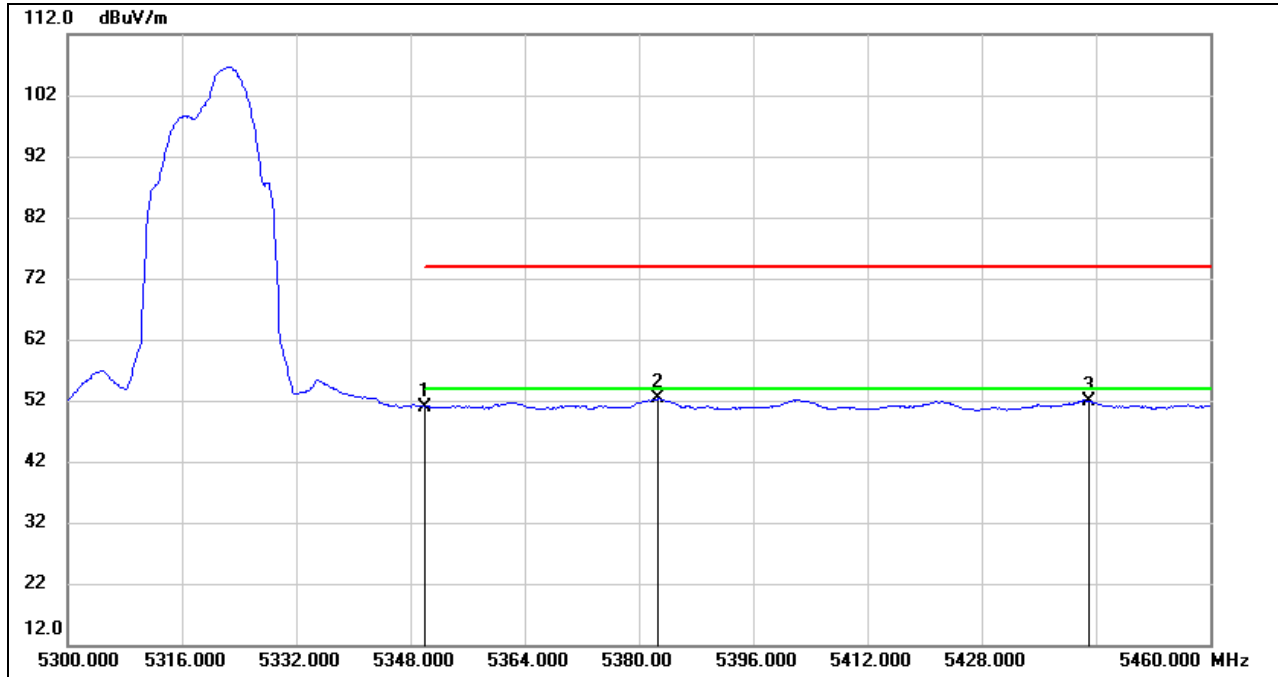

No.	Frequency (MHz)	Reading (dBuV)	Correct (dB/m)	Result (dBuV/m)	Limit (dBuV/m)	Margin (dB)	Remark
1	5350.000	9.79	41.20	50.99	54.00	-3.01	AVG
2	5382.720	10.91	41.39	52.30	54.00	-1.70	AVG
3	5443.040	10.27	41.72	51.99	54.00	-2.01	AVG

- Note:
1. Measurement = Reading Level + Correct Factor.
 2. If Peak Result complies with AV limit, AV Result is deemed to comply with AV limit.
 3. AVG: $VBW=1/T_{on}$, where: T_{on} is the transmitting duration.
 4. For the transmitting duration, please refer to clause 7.1.
 5. Only the worst data was recorded, if it complies with the limit, the other emissions deemed to comply with the limit.

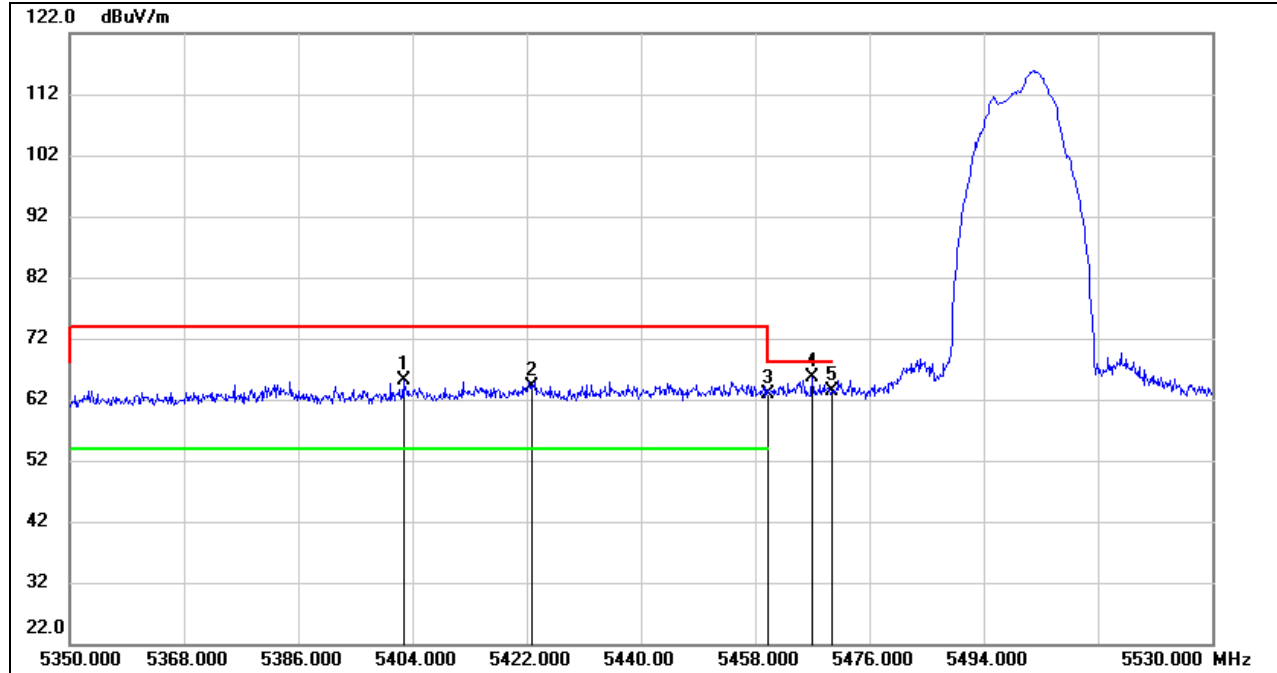
UNII-2C BAND
RESTRICTED BANDEGE (LOW CHANNEL, HORIZONTAL)
PEAK

No.	Frequency (MHz)	Reading (dBuV)	Correct (dB/m)	Result (dBuV/m)	Limit (dBuV/m)	Margin (dB)	Remark
1	5402.560	23.64	41.49	65.13	74.00	-8.87	peak
2	5422.900	22.58	41.61	64.19	74.00	-9.81	peak
3	5460.000	20.94	41.82	62.76	68.20	-5.44	peak
4	5467.000	23.71	41.86	65.57	68.20	-2.63	peak
5	5470.000	21.46	41.87	63.33	68.20	-4.87	peak

Note: 1. Measurement = Reading Level + Correct Factor.
 2. If Peak Result complies with AV limit, AV Result is deemed to comply with AV limit.
 3. Peak: Peak detector.
 4. Only the worst data was recorded, if it complies with the limit, the other emissions deemed to comply with the limit.

AVG

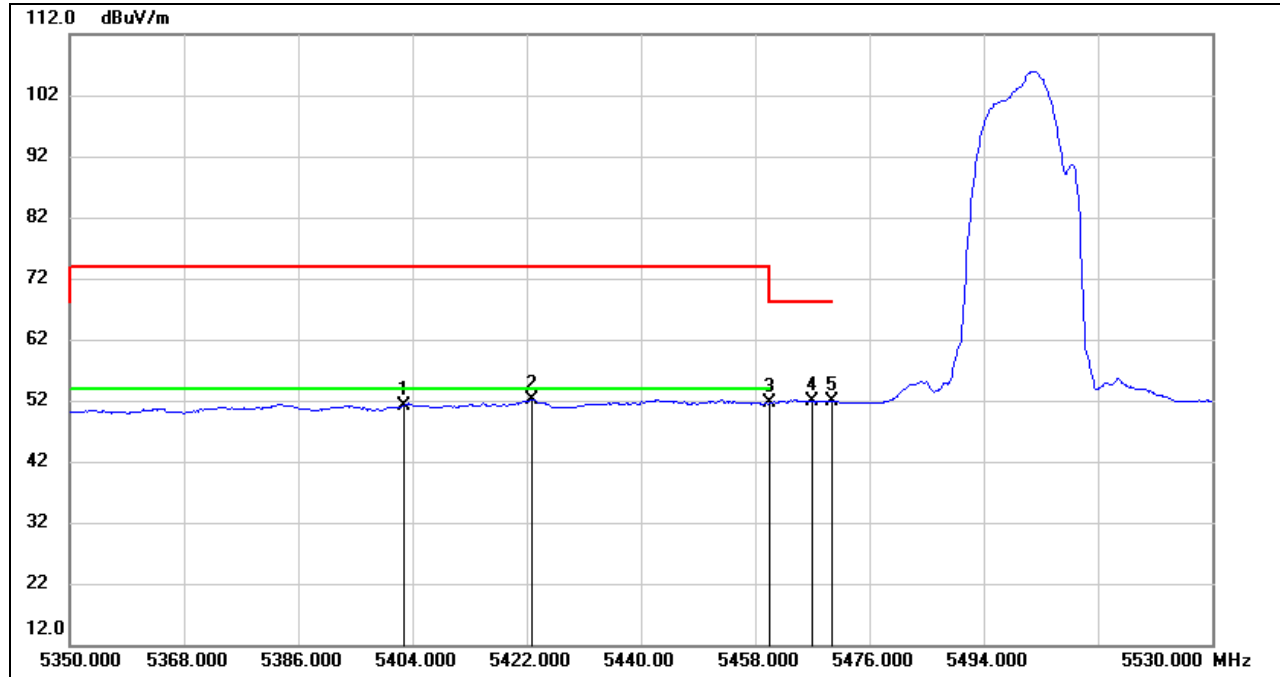

No.	Frequency (MHz)	Reading (dBuV)	Correct (dB/m)	Result (dBuV/m)	Limit (dBuV/m)	Margin (dB)	Remark
1	5402.560	9.52	41.49	51.01	54.00	-2.99	AVG
2	5422.900	10.58	41.61	52.19	54.00	-1.81	AVG
3	5460.000	9.71	41.82	51.53	54.00	-2.47	AVG
4	5467.000	9.97	41.86	51.83	68.20	-16.37	AVG
5	5470.000	10.10	41.87	51.97	68.20	-16.23	AVG

- Note: 1. Measurement = Reading Level + Correct Factor.
 2. If Peak Result complies with AV limit, AV Result is deemed to comply with AV limit.
 3. AVG: $VBW=1/Ton$, where: Ton is the transmitting duration.
 4. For the transmitting duration, please refer to clause 7.1.
 5. Only the worst data was recorded, if it complies with the limit, the other emissions deemed to comply with the limit.

RESTRICTED BANDEDGE (HIGH CHANNEL, HORIZONTAL)

PEAK

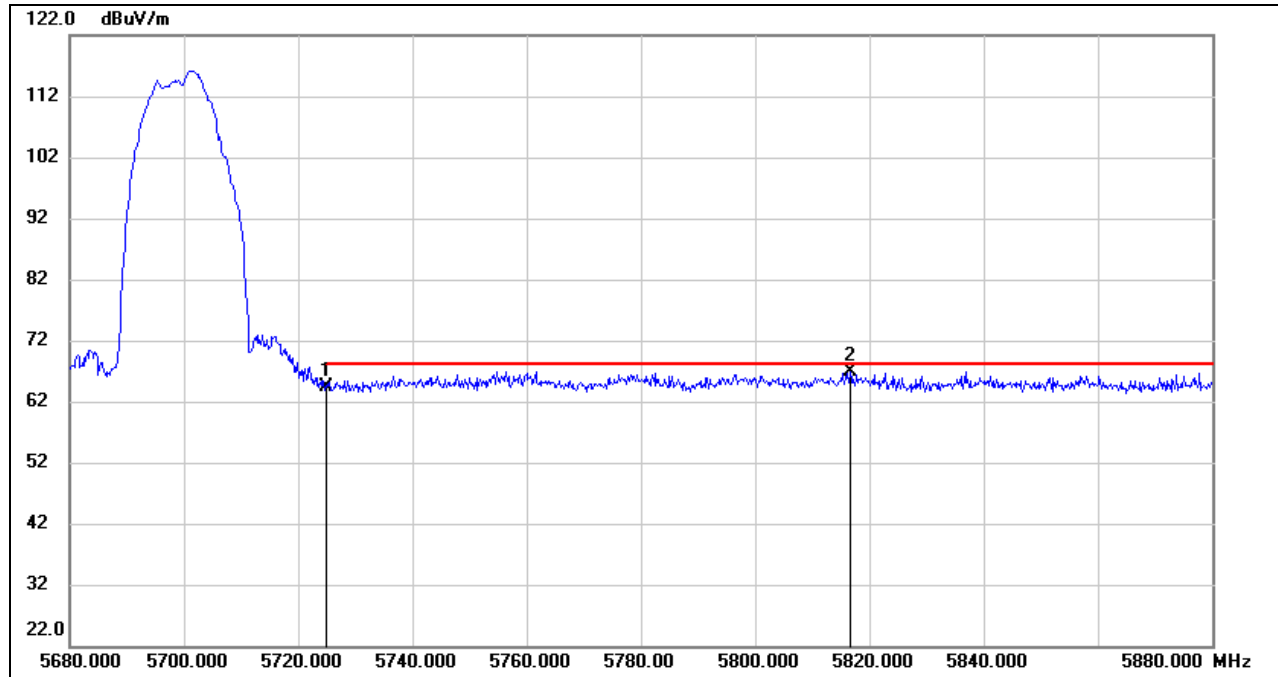

No.	Frequency (MHz)	Reading (dBuV)	Correct (dB/m)	Result (dBuV/m)	Limit (dBuV/m)	Margin (dB)	Remark
1	5725.000	22.66	41.67	64.33	68.20	-3.87	peak
2	5816.600	24.74	42.19	66.93	68.20	-1.27	peak

- Note: 1. Measurement = Reading Level + Correct Factor.
 2. If Peak Result complies with AV limit, AV Result is deemed to comply with AV limit.
 3. Peak: Peak detector.
 4. Only the worst data was recorded, if it complies with the limit, the other emissions deemed to comply with the limit.

UNII-3 BAND

RESTRICTED BANDEDGE (LOW CHANNEL, HORIZONTAL)

PEAK

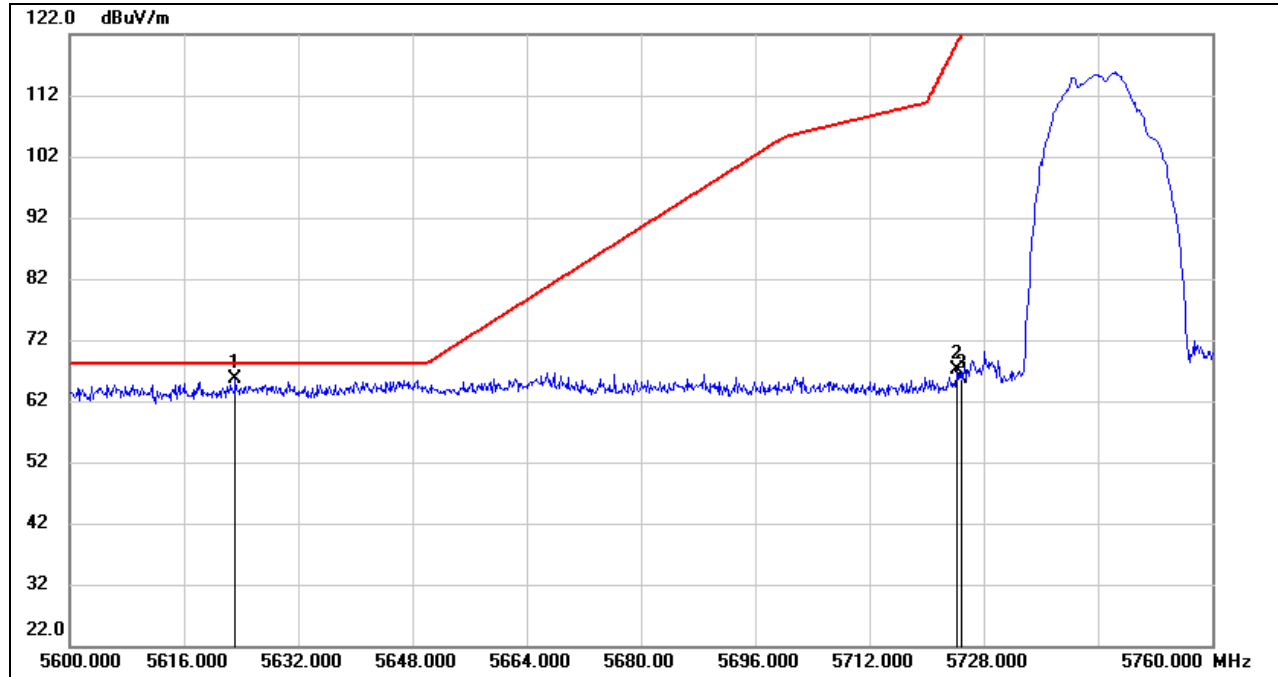

No.	Frequency (MHz)	Reading (dBuV)	Correct (dB/m)	Result (dBuV/m)	Limit (dBuV/m)	Margin (dB)	Remark
1	5623.200	24.04	41.69	65.73	68.20	-2.47	peak
2	5724.320	25.46	41.67	67.13	120.65	-53.52	peak
3	5725.000	23.88	41.67	65.55	122.20	-56.65	peak

- Note: 1. Measurement = Reading Level + Correct Factor.
 2. If Peak Result complies with AV limit, AV Result is deemed to comply with AV limit.
 3. Peak: Peak detector.
 4. Only the worst data was recorded, if it complies with the limit, the other emissions deemed to comply with the limit.

RESTRICTED BANDEDGE (HIGH CHANNEL, HORIZONTAL)

PEAK

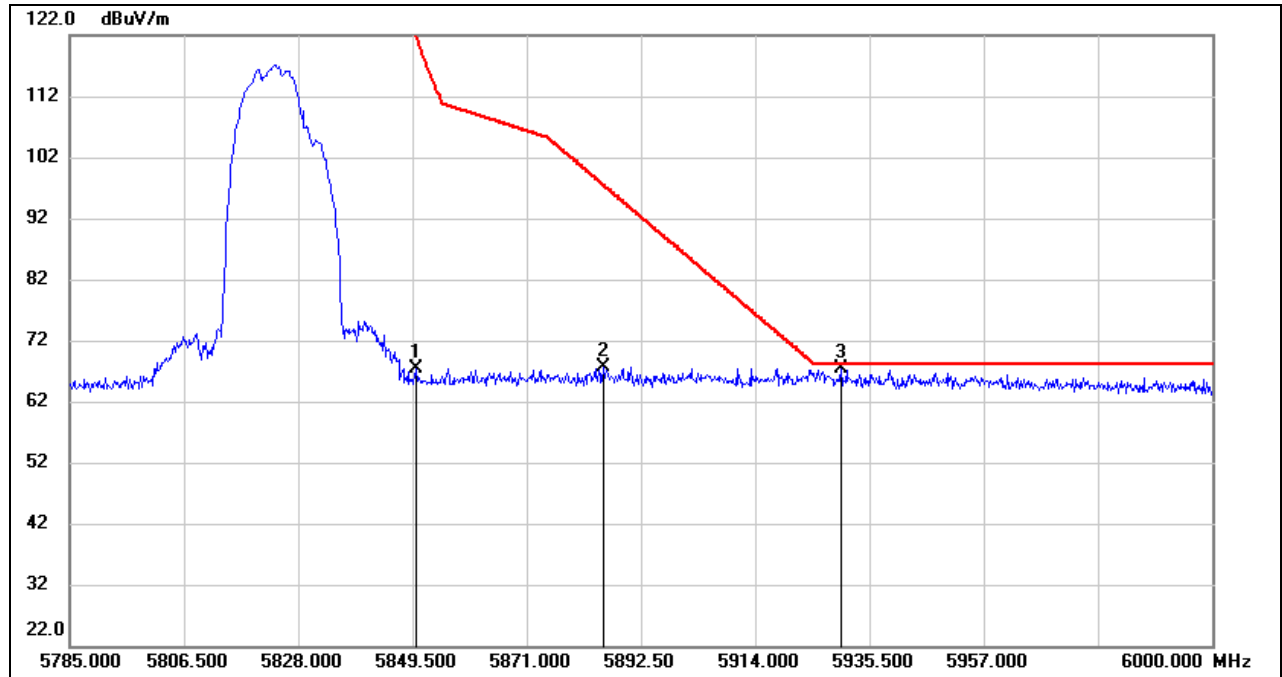

No.	Frequency (MHz)	Reading (dBuV)	Correct (dB/m)	Result (dBuV/m)	Limit (dBuV/m)	Margin (dB)	Remark
1	5850.000	24.88	42.52	67.40	122.20	-54.80	peak
2	5885.405	24.81	42.88	67.69	97.47	-29.78	peak
3	5930.125	24.54	42.89	67.43	68.20	-0.77	peak

Note: 1. Measurement = Reading Level + Correct Factor.
 2. If Peak Result complies with AV limit, AV Result is deemed to comply with AV limit.
 3. Peak: Peak detector.
 4. Only the worst data was recorded, if it complies with the limit, the other emissions deemed to comply with the limit.

Note: All the modes and antennas had been tested, but only the worst data was recorded in the report.

Note: Both horizontal and vertical had been tested, but only the worst data was recorded in the report.

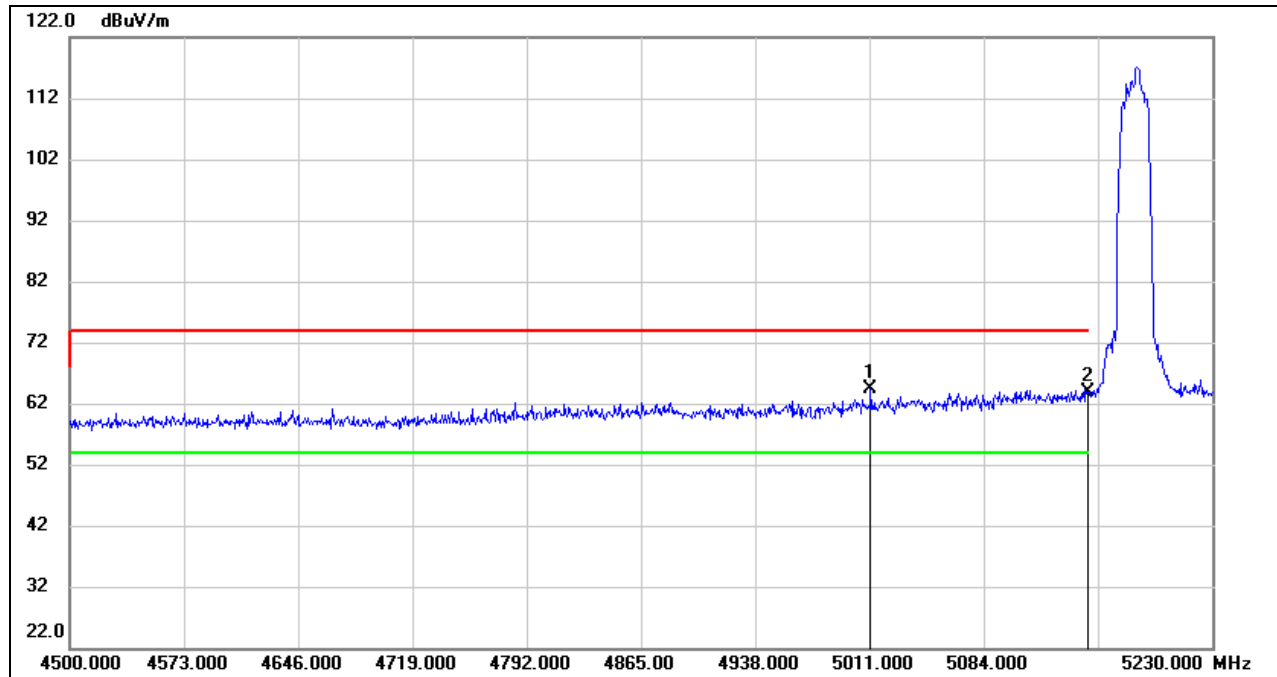
8.1.2. 802.11ac VHT20 CDD 4TX MODE
UNII-1 BAND
RESTRICTED BANDEDGE (LOW CHANNEL, HORIZONTAL)
PEAK

No.	Frequency (MHz)	Reading (dBuV)	Correct (dB/m)	Result (dBuV/m)	Limit (dBuV/m)	Margin (dB)	Remark
1	5011.730	23.47	40.98	64.45	74.00	-9.55	peak
2	5150.000	22.62	41.19	63.81	74.00	-10.19	peak

- Note:
1. Measurement = Reading Level + Correct Factor.
 2. If Peak Result complies with AV limit, AV Result is deemed to comply with AV limit.
 3. Peak: Peak detector.
 4. Only the worst data was recorded, if it complies with the limit, the other emissions deemed to comply with the limit.



AVG

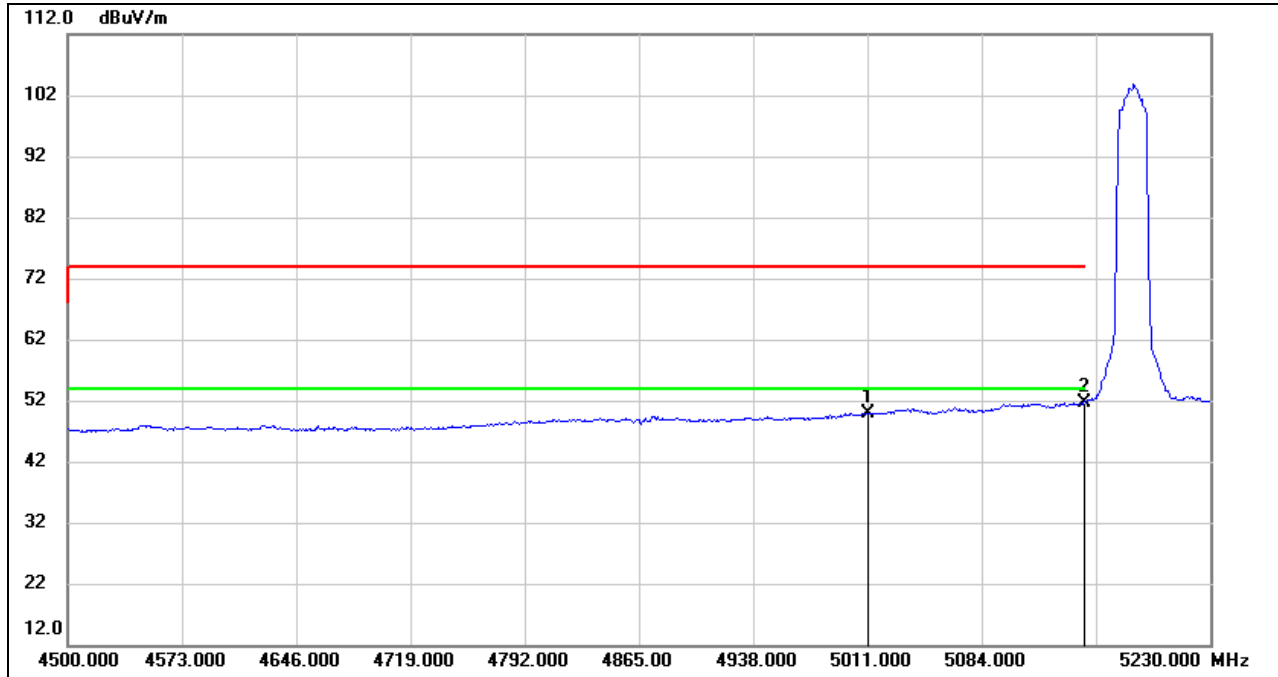

No.	Frequency (MHz)	Reading (dBuV)	Correct (dB/m)	Result (dBuV/m)	Limit (dBuV/m)	Margin (dB)	Remark
1	5011.730	8.83	40.98	49.81	54.00	-4.19	AVG
2	5150.000	10.53	41.19	51.72	54.00	-2.28	AVG

- Note:
1. Measurement = Reading Level + Correct Factor.
 2. If Peak Result complies with AV limit, AV Result is deemed to comply with AV limit.
 3. AVG: $VBW=1/Ton$, where: Ton is the transmitting duration.
 4. For the transmitting duration, please refer to clause 7.1.
 5. Only the worst data was recorded, if it complies with the limit, the other emissions deemed to comply with the limit.

UNII-2A BAND

RESTRICTED BANDEDGE (HIGH CHANNEL, HORIZONTAL)

PEAK

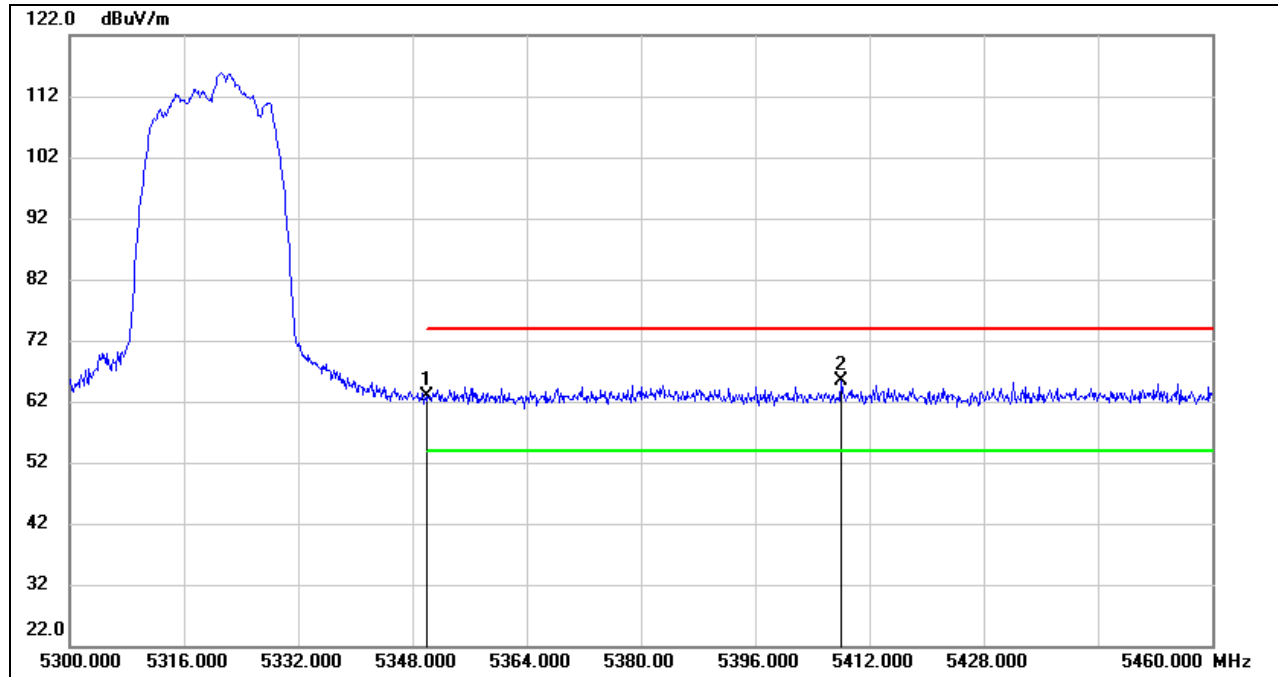

No.	Frequency (MHz)	Reading (dBuV)	Correct (dB/m)	Result (dBuV/m)	Limit (dBuV/m)	Margin (dB)	Remark
1	5350.000	21.77	41.20	62.97	74.00	-11.03	peak
2	5408.000	23.78	41.53	65.31	74.00	-8.69	peak

Note: 1. Measurement = Reading Level + Correct Factor.
 2. If Peak Result complies with AV limit, AV Result is deemed to comply with AV limit.
 3. Peak: Peak detector.
 4. Only the worst data was recorded, if it complies with the limit, the other emissions deemed to comply with the limit.

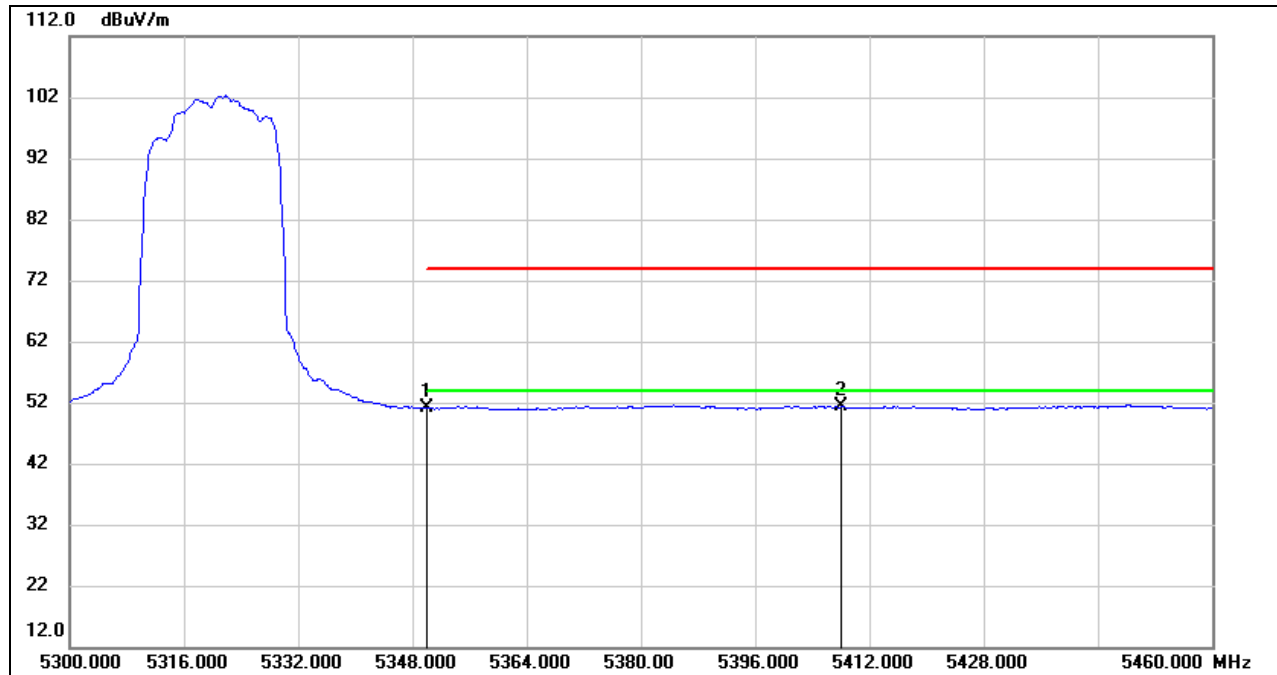
**AVG**

No.	Frequency (MHz)	Reading (dBuV)	Correct (dB/m)	Result (dBuV/m)	Limit (dBuV/m)	Margin (dB)	Remark
1	5350.000	9.86	41.20	51.06	54.00	-2.94	AVG
2	5408.000	9.75	41.53	51.28	54.00	-2.72	AVG

- Note:
1. Measurement = Reading Level + Correct Factor.
 2. If Peak Result complies with AV limit, AV Result is deemed to comply with AV limit.
 3. AVG: $VBW=1/Ton$, where: Ton is the transmitting duration.
 4. For the transmitting duration, please refer to clause 7.1.
 5. Only the worst data was recorded, if it complies with the limit, the other emissions deemed to comply with the limit.

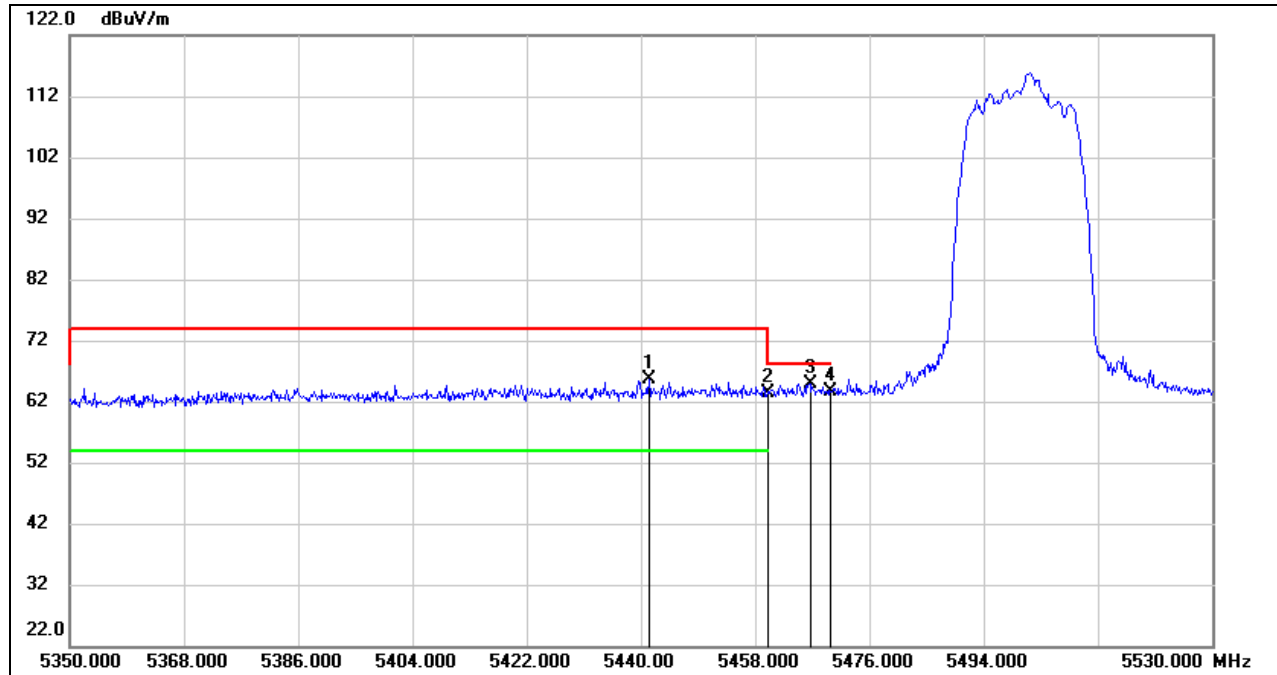
UNII-2C BAND
RESTRICTED BANDEDGE (LOW CHANNEL, HORIZONTAL)
PEAK

No.	Frequency (MHz)	Reading (dBuV)	Correct (dB/m)	Result (dBuV/m)	Limit (dBuV/m)	Margin (dB)	Remark
1	5441.260	23.83	41.72	65.55	74.00	-8.45	peak
2	5460.000	21.56	41.82	63.38	68.20	-4.82	peak
3	5466.640	23.01	41.86	64.87	68.20	-3.33	peak
4	5470.000	21.70	41.87	63.57	68.20	-4.63	peak

Note: 1. Measurement = Reading Level + Correct Factor.

2. If Peak Result complies with AV limit, AV Result is deemed to comply with AV limit.

3. Peak: Peak detector.

4. Only the worst data was recorded, if it complies with the limit, the other emissions deemed to comply with the limit.

AVG

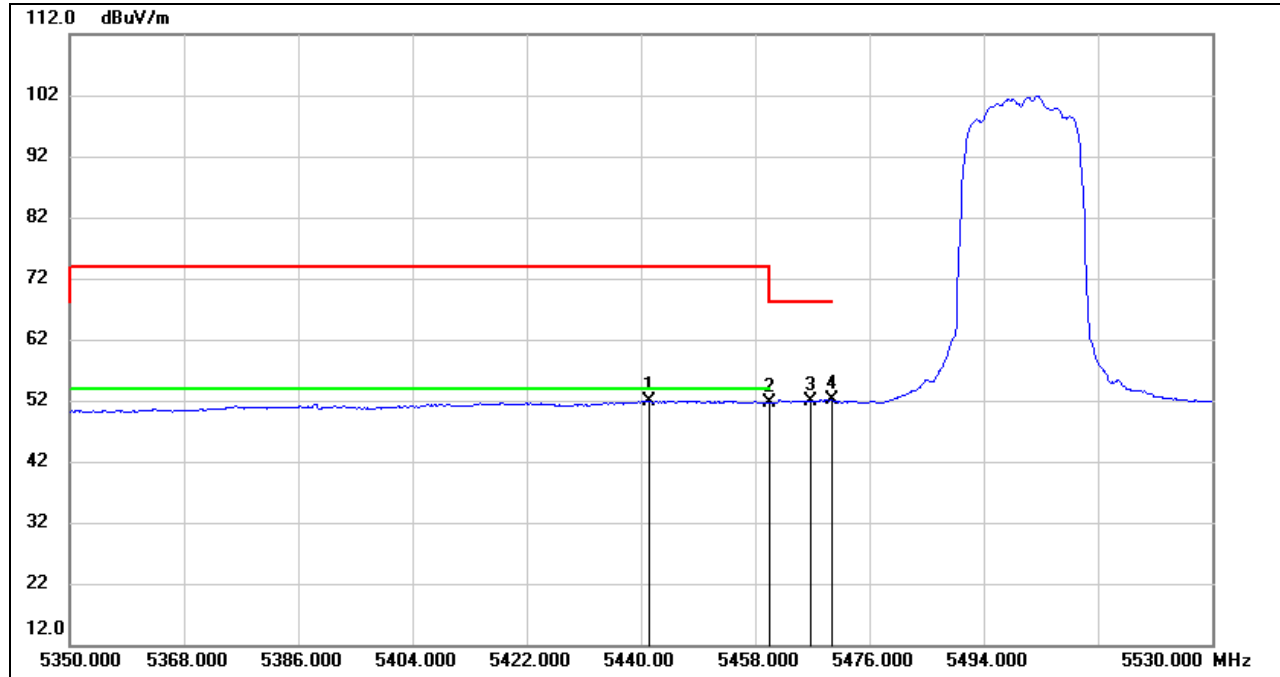

No.	Frequency (MHz)	Reading (dBuV)	Correct (dB/m)	Result (dBuV/m)	Limit (dBuV/m)	Margin (dB)	Remark
1	5441.260	10.13	41.72	51.85	54.00	-2.15	AVG
2	5460.000	9.75	41.82	51.57	54.00	-2.43	AVG
3	5466.640	10.06	41.86	51.92	68.20	-16.28	AVG
4	5470.000	10.14	41.87	52.01	68.20	-16.19	AVG

- Note:
1. Measurement = Reading Level + Correct Factor.
 2. If Peak Result complies with AV limit, AV Result is deemed to comply with AV limit.
 3. AVG: $VBW=1/T_{on}$, where: T_{on} is the transmitting duration.
 4. For the transmitting duration, please refer to clause 7.1.
 5. Only the worst data was recorded, if it complies with the limit, the other emissions deemed to comply with the limit.

RESTRICTED BANDEDGE (HIGH CHANNEL, HORIZONTAL)

PEAK

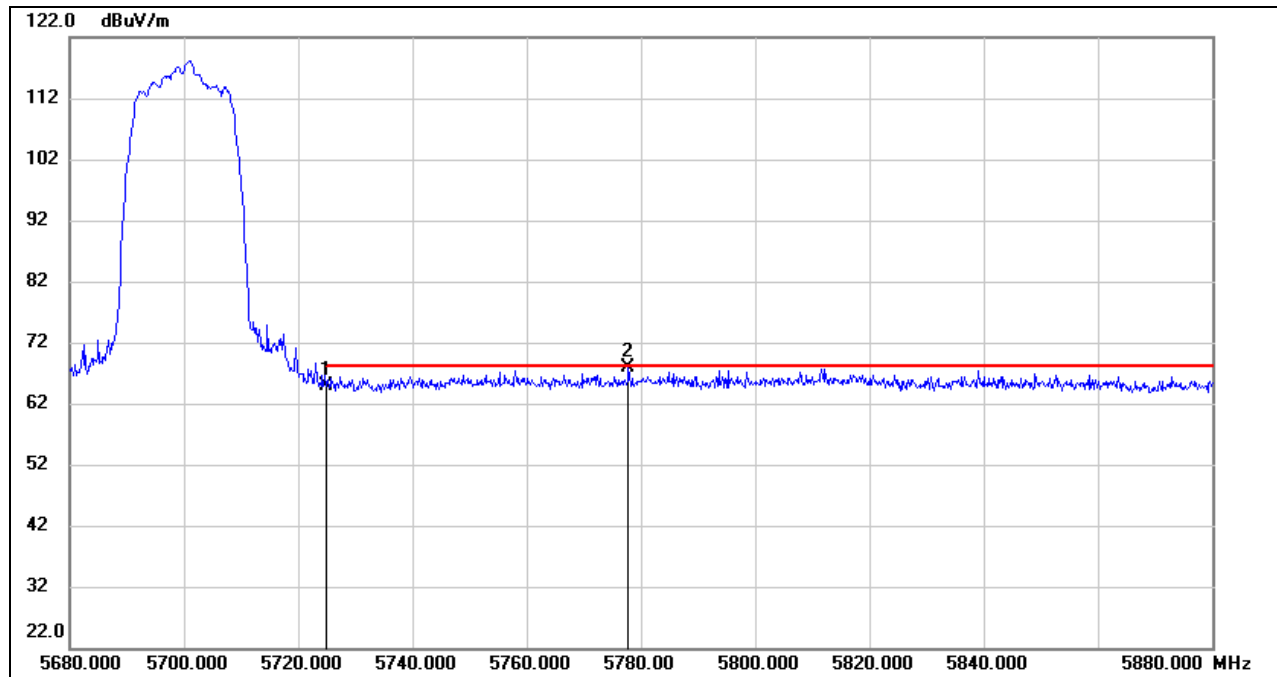

No.	Frequency (MHz)	Reading (dBuV)	Correct (dB/m)	Result (dBuV/m)	Limit (dBuV/m)	Margin (dB)	Remark
1	5725.000	23.30	41.67	64.97	68.20	-3.23	peak
2	5777.800	26.01	41.91	67.92	68.20	-0.28	peak

- Note: 1. Measurement = Reading Level + Correct Factor.
 2. If Peak Result complies with AV limit, AV Result is deemed to comply with AV limit.
 3. Peak: Peak detector.
 4. Only the worst data was recorded, if it complies with the limit, the other emissions deemed to comply with the limit.

UNII-3 BAND

RESTRICTED BANDEDGE (LOW CHANNEL, HORIZONTAL)

PEAK

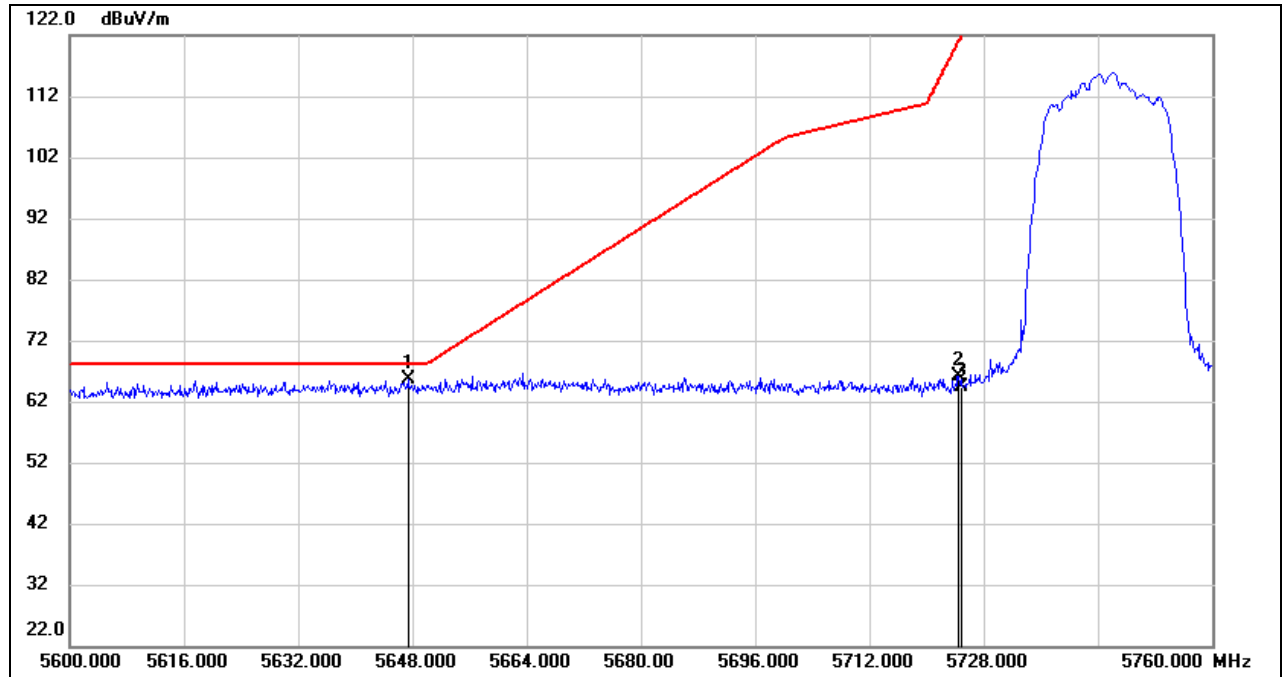

No.	Frequency (MHz)	Reading (dBuV)	Correct (dB/m)	Result (dBuV/m)	Limit (dBuV/m)	Margin (dB)	Remark
1	5647.360	24.02	41.65	65.67	68.20	-2.53	peak
2	5724.480	24.41	41.67	66.08	121.01	-54.93	peak
3	5725.000	22.75	41.67	64.42	122.20	-57.78	peak

Note: 1. Measurement = Reading Level + Correct Factor.
 2. If Peak Result complies with AV limit, AV Result is deemed to comply with AV limit.
 3. Peak: Peak detector.
 4. Only the worst data was recorded, if it complies with the limit, the other emissions deemed to comply with the limit.

RESTRICTED BANDEDGE (HIGH CHANNEL, HORIZONTAL)

PEAK

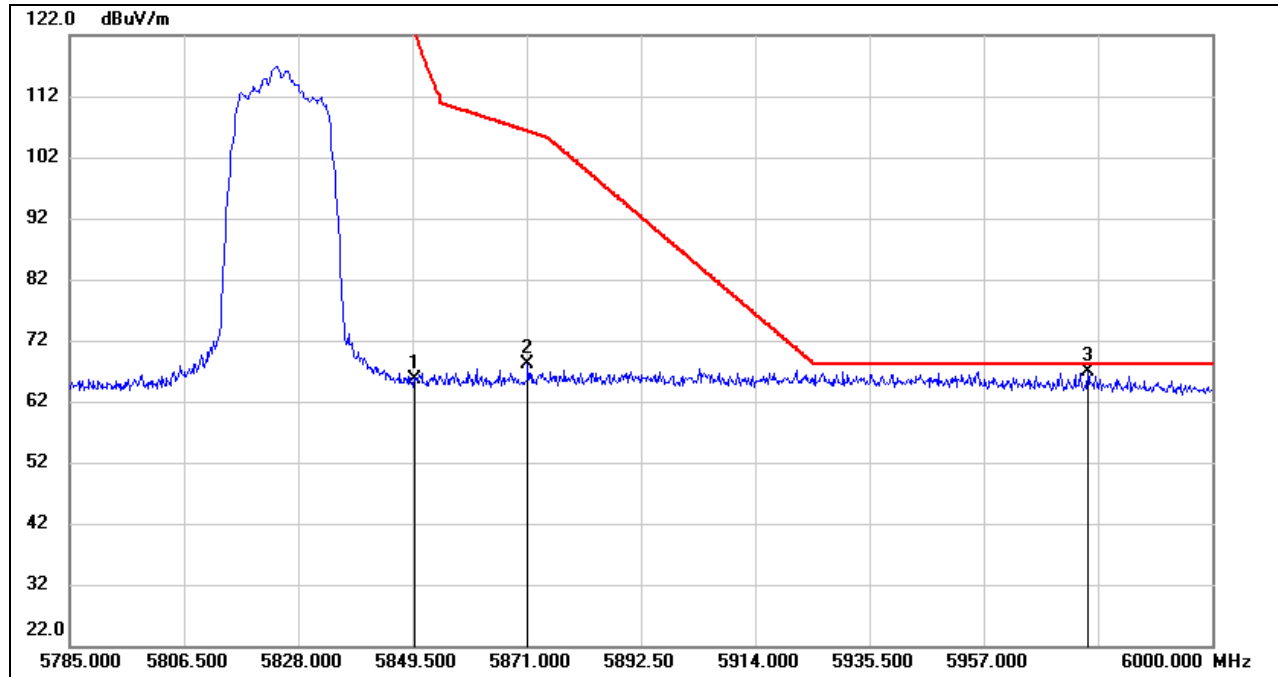

No.	Frequency (MHz)	Reading (dBuV)	Correct (dB/m)	Result (dBuV/m)	Limit (dBuV/m)	Margin (dB)	Remark
1	5850.000	23.00	42.52	65.52	122.20	-56.68	peak
2	5871.215	25.42	42.74	68.16	106.26	-38.10	peak
3	5976.565	24.25	42.67	66.92	68.20	-1.28	peak

- Note: 1. Measurement = Reading Level + Correct Factor.
 2. If Peak Result complies with AV limit, AV Result is deemed to comply with AV limit.
 3. Peak: Peak detector.
 4. Only the worst data was recorded, if it complies with the limit, the other emissions deemed to comply with the limit.

Note: All the modes and antennas had been tested, but only the worst data was recorded in the report.

Note: Both horizontal and vertical had been tested, but only the worst data was recorded in the report.

8.1.3. 802.11ac VHT40 CDD 4TX MODE

UNII-1 BAND

RESTRICTED BANDEDGE (LOW CHANNEL, HORIZONTAL)

PEAK

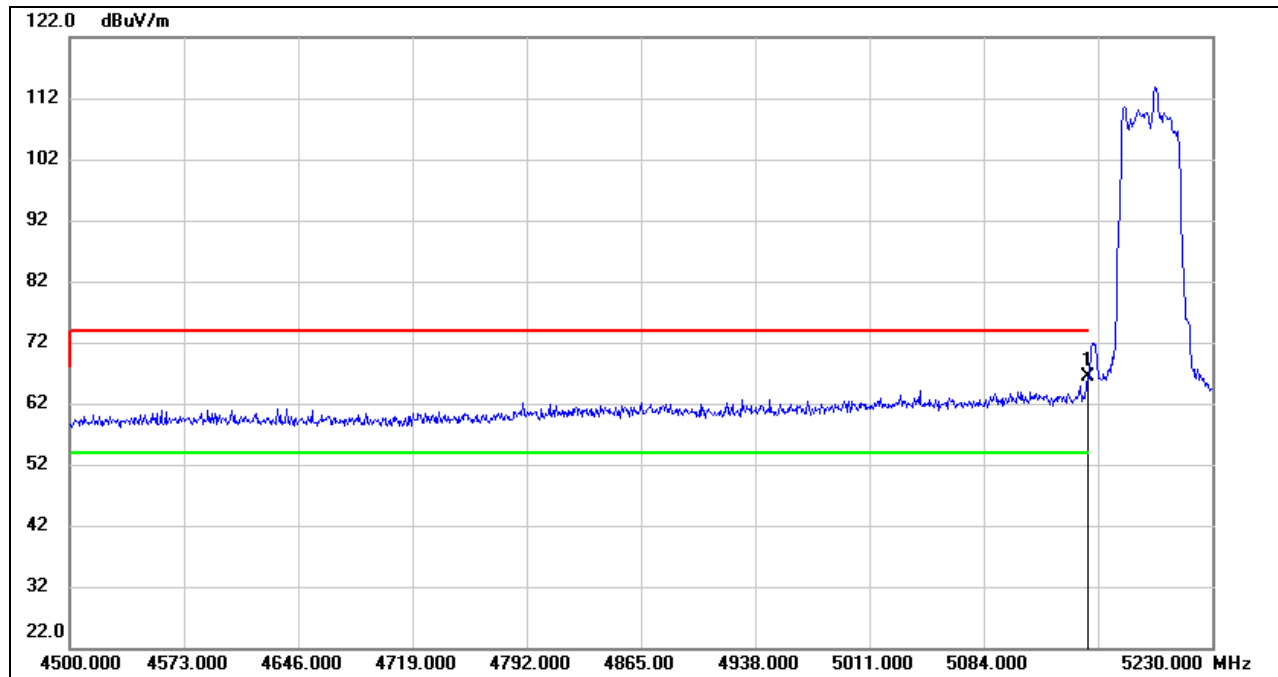

No.	Frequency (MHz)	Reading (dBuV)	Correct (dB/m)	Result (dBuV/m)	Limit (dBuV/m)	Margin (dB)	Remark
1	5150.000	25.07	41.19	66.26	74.00	-7.74	peak

- Note:
1. Measurement = Reading Level + Correct Factor.
 2. If Peak Result complies with AV limit, AV Result is deemed to comply with AV limit.
 3. Peak: Peak detector.
 4. Only the worst data was recorded, if it complies with the limit, the other emissions deemed to comply with the limit.



AVG

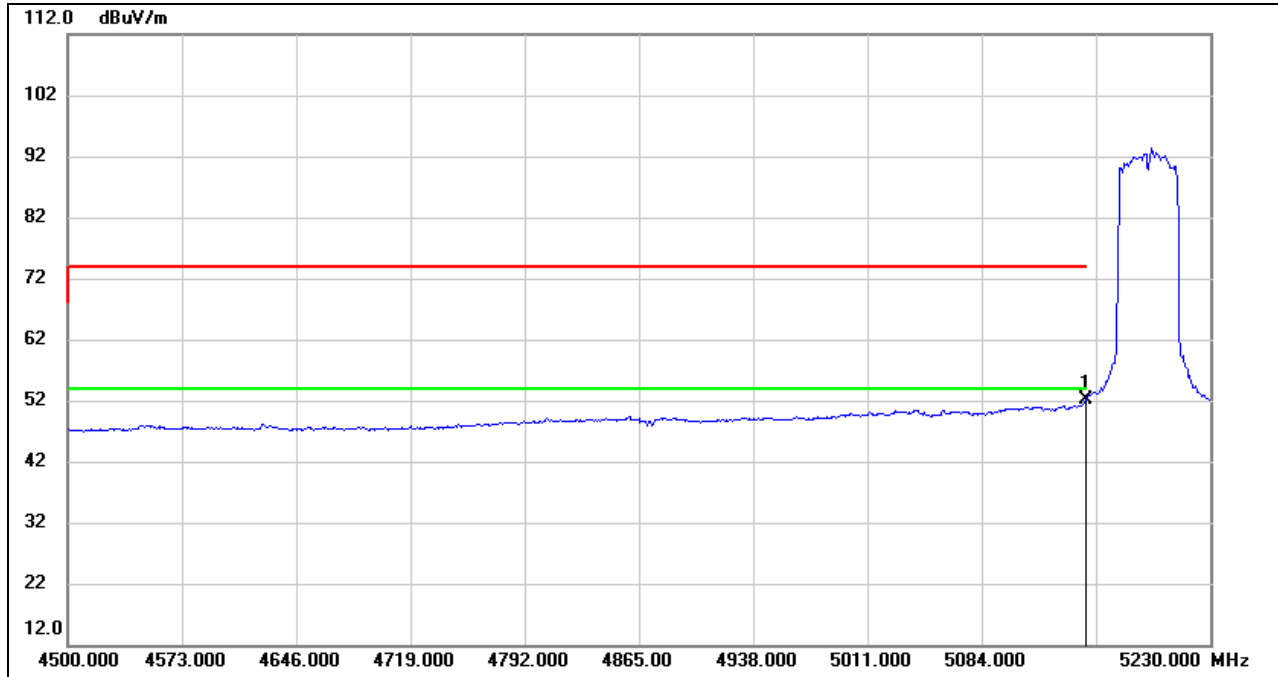

No.	Frequency (MHz)	Reading (dBuV)	Correct (dB/m)	Result (dBuV/m)	Limit (dBuV/m)	Margin (dB)	Remark
1	5150.000	10.93	41.19	52.12	54.00	-1.88	AVG

- Note:
1. Measurement = Reading Level + Correct Factor.
 2. If Peak Result complies with AV limit, AV Result is deemed to comply with AV limit.
 3. AVG: $VBW=1/T_{on}$, where: T_{on} is the transmitting duration.
 4. For the transmitting duration, please refer to clause 7.1.
 5. Only the worst data was recorded, if it complies with the limit, the other emissions deemed to comply with the limit.

UNII-2A BAND

RESTRICTED BANDEDGE (HIGH CHANNEL, HORIZONTAL)

PEAK

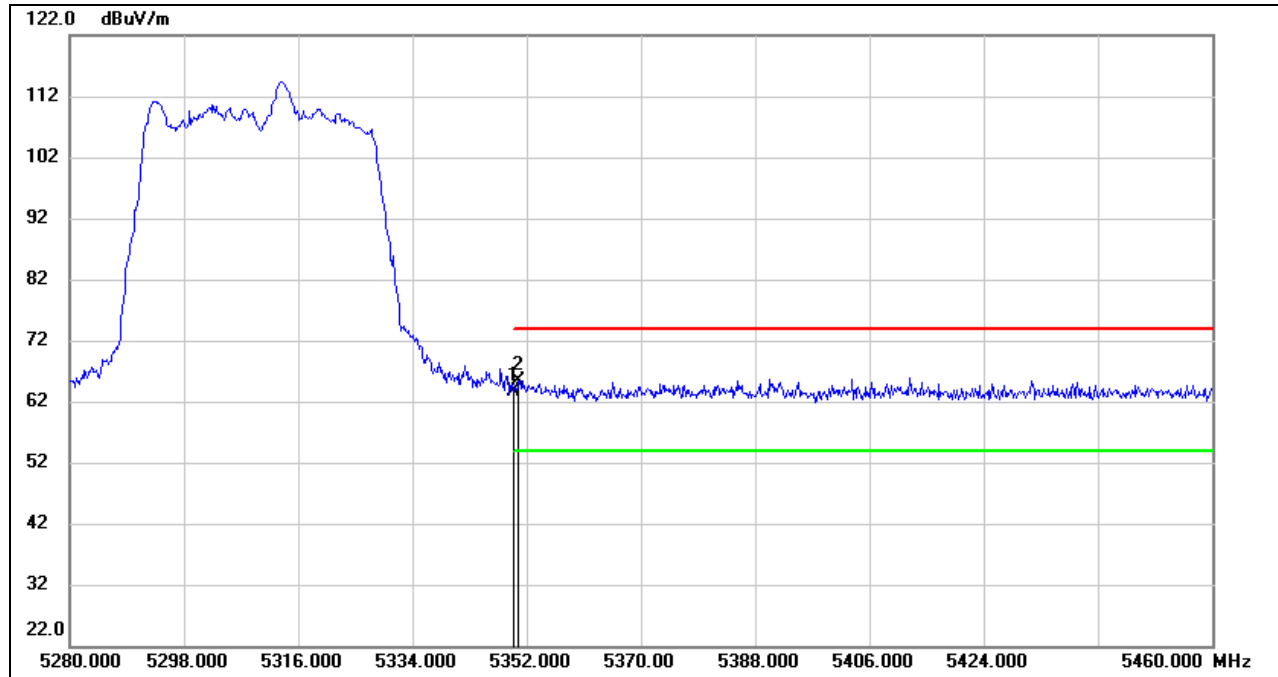

No.	Frequency (MHz)	Reading (dBuV)	Correct (dB/m)	Result (dBuV/m)	Limit (dBuV/m)	Margin (dB)	Remark
1	5350.000	22.33	41.20	63.53	74.00	-10.47	peak
2	5350.740	24.17	41.21	65.38	74.00	-8.62	peak

Note: 1. Measurement = Reading Level + Correct Factor.
 2. If Peak Result complies with AV limit, AV Result is deemed to comply with AV limit.
 3. Peak: Peak detector.
 4. Only the worst data was recorded, if it complies with the limit, the other emissions deemed to comply with the limit.

AVG

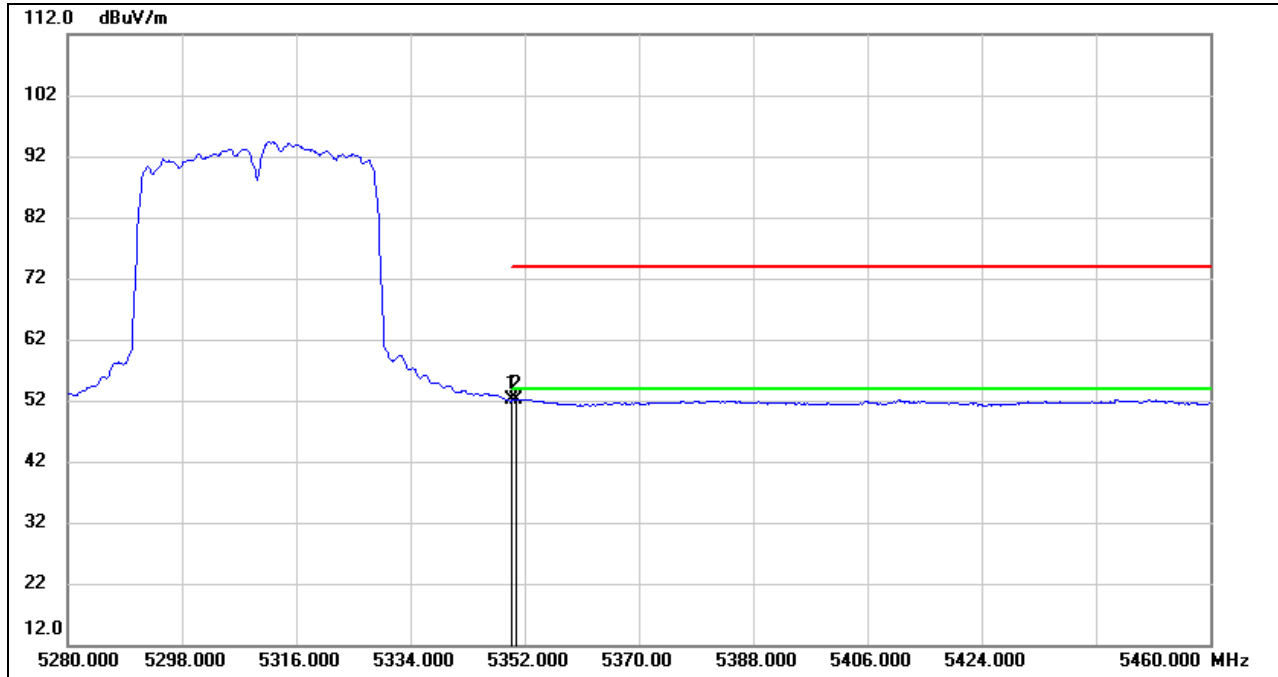

No.	Frequency (MHz)	Reading (dBuV)	Correct (dB/m)	Result (dBuV/m)	Limit (dBuV/m)	Margin (dB)	Remark
1	5350.000	10.82	41.20	52.02	54.00	-1.98	AVG
2	5350.740	10.82	41.21	52.03	54.00	-1.97	AVG

- Note:
1. Measurement = Reading Level + Correct Factor.
 2. If Peak Result complies with AV limit, AV Result is deemed to comply with AV limit.
 3. AVG: $VBW=1/T_{on}$, where: T_{on} is the transmitting duration.
 4. For the transmitting duration, please refer to clause 7.1.
 5. Only the worst data was recorded, if it complies with the limit, the other emissions deemed to comply with the limit.

UNII-2C BAND

RESTRICTED BANDEDGE (LOW CHANNEL, HORIZONTAL)

PEAK

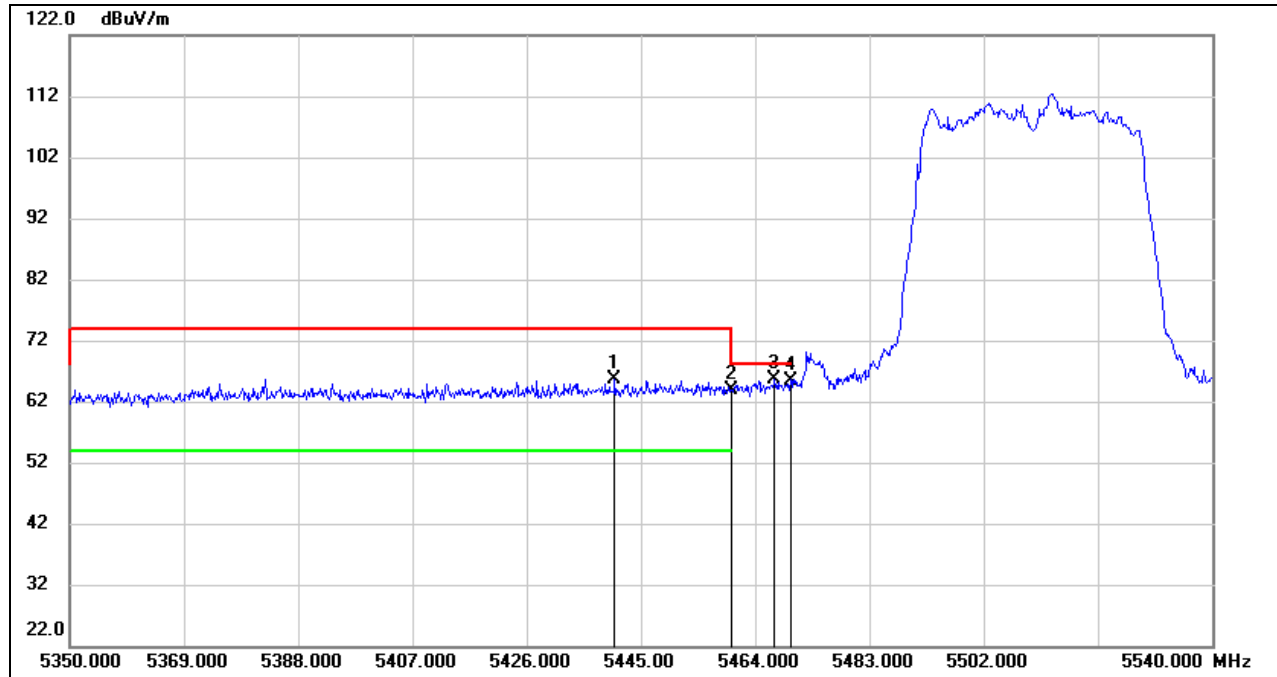

No.	Frequency (MHz)	Reading (dBuV)	Correct (dB/m)	Result (dBuV/m)	Limit (dBuV/m)	Margin (dB)	Remark
1	5440.630	24.04	41.71	65.75	74.00	-8.25	peak
2	5460.000	22.12	41.82	63.94	68.20	-4.26	peak
3	5467.230	23.82	41.86	65.68	68.20	-2.52	peak
4	5470.000	23.55	41.87	65.42	68.20	-2.78	peak

Note: 1. Measurement = Reading Level + Correct Factor.
 2. If Peak Result complies with AV limit, AV Result is deemed to comply with AV limit.
 3. Peak: Peak detector.
 4. Only the worst data was recorded, if it complies with the limit, the other emissions deemed to comply with the limit.



AVG

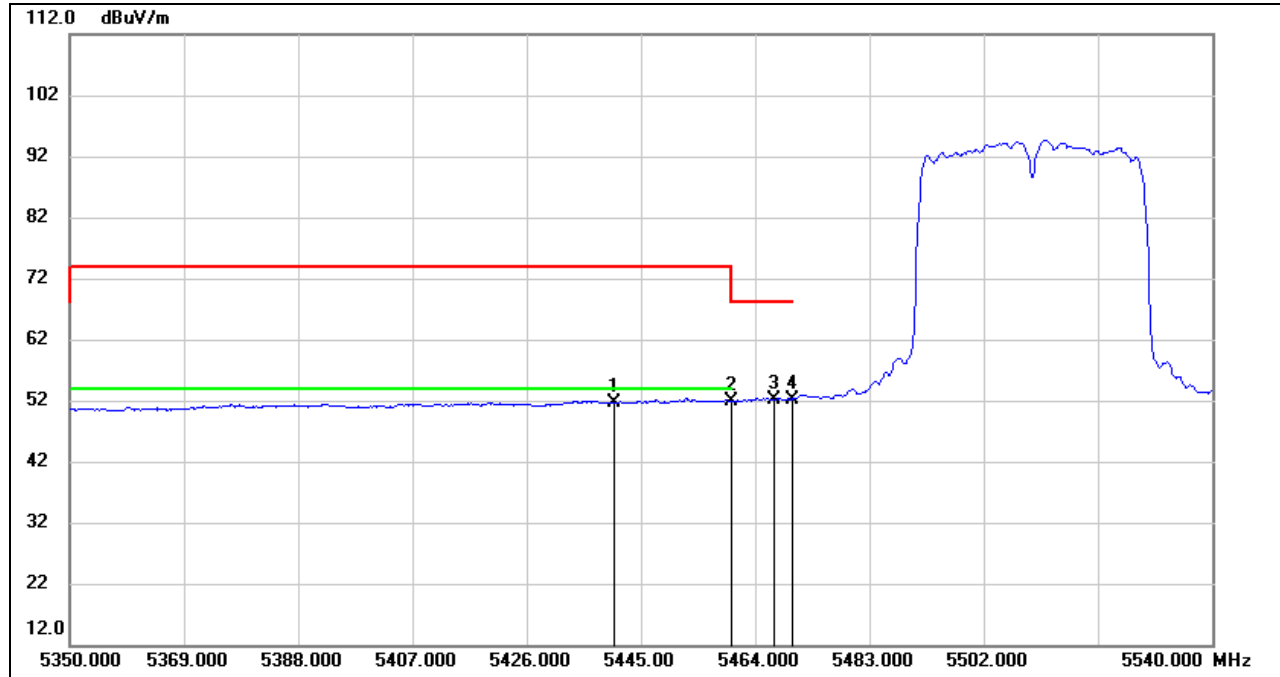

No.	Frequency (MHz)	Reading (dBuV)	Correct (dB/m)	Result (dBuV/m)	Limit (dBuV/m)	Margin (dB)	Remark
1	5440.630	9.94	41.71	51.65	54.00	-2.35	AVG
2	5460.000	10.03	41.82	51.85	54.00	-2.15	AVG
3	5467.230	10.22	41.86	52.08	68.20	-16.12	AVG
4	5470.000	10.37	41.87	52.24	68.20	-15.96	AVG

- Note:
1. Measurement = Reading Level + Correct Factor.
 2. If Peak Result complies with AV limit, AV Result is deemed to comply with AV limit.
 3. AVG: $VBW=1/T_{on}$, where: T_{on} is the transmitting duration.
 4. For the transmitting duration, please refer to clause 7.1.
 5. Only the worst data was recorded, if it complies with the limit, the other emissions deemed to comply with the limit.

RESTRICTED BANDEDGE (HIGH CHANNEL, HORIZONTAL)

PEAK

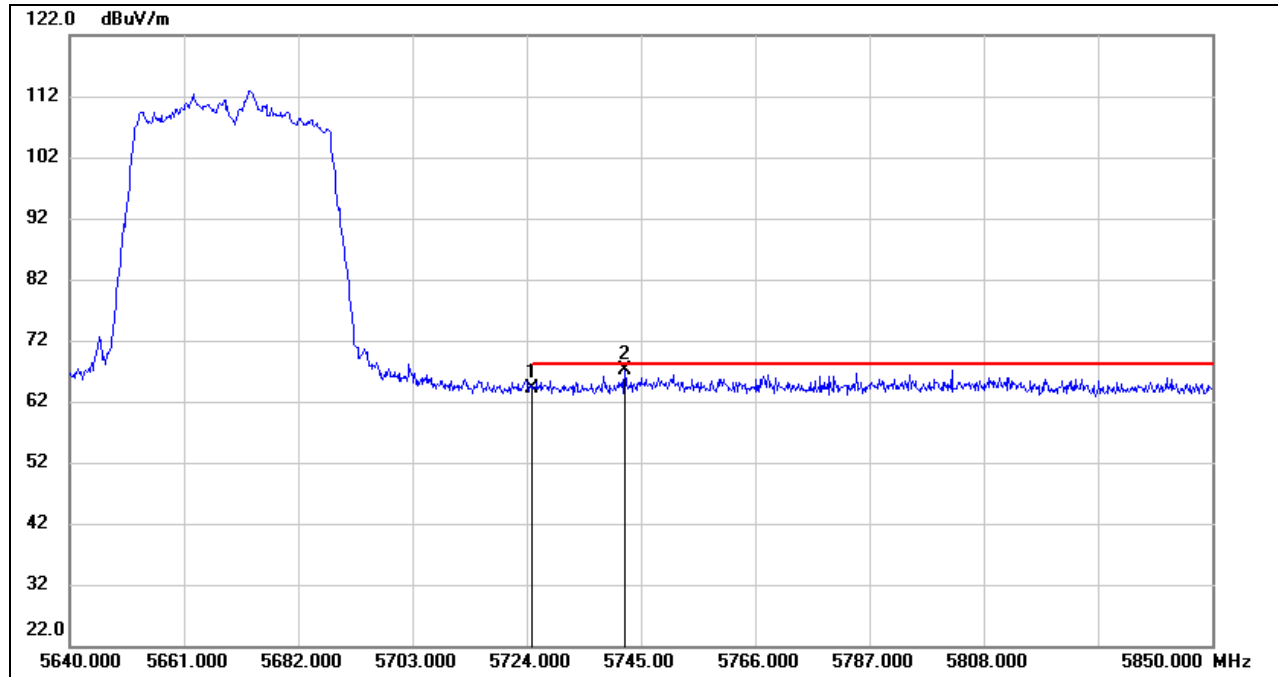

No.	Frequency (MHz)	Reading (dBuV)	Correct (dB/m)	Result (dBuV/m)	Limit (dBuV/m)	Margin (dB)	Remark
1	5725.000	22.48	41.67	64.15	68.20	-4.05	peak
2	5742.060	25.48	41.75	67.23	68.20	-0.97	peak

Note: 1. Measurement = Reading Level + Correct Factor.
 2. If Peak Result complies with AV limit, AV Result is deemed to comply with AV limit.
 3. Peak: Peak detector.
 4. Only the worst data was recorded, if it complies with the limit, the other emissions deemed to comply with the limit.



UNII-3 BAND

RESTRICTED BANDEDGE (LOW CHANNEL, HORIZONTAL)

PEAK

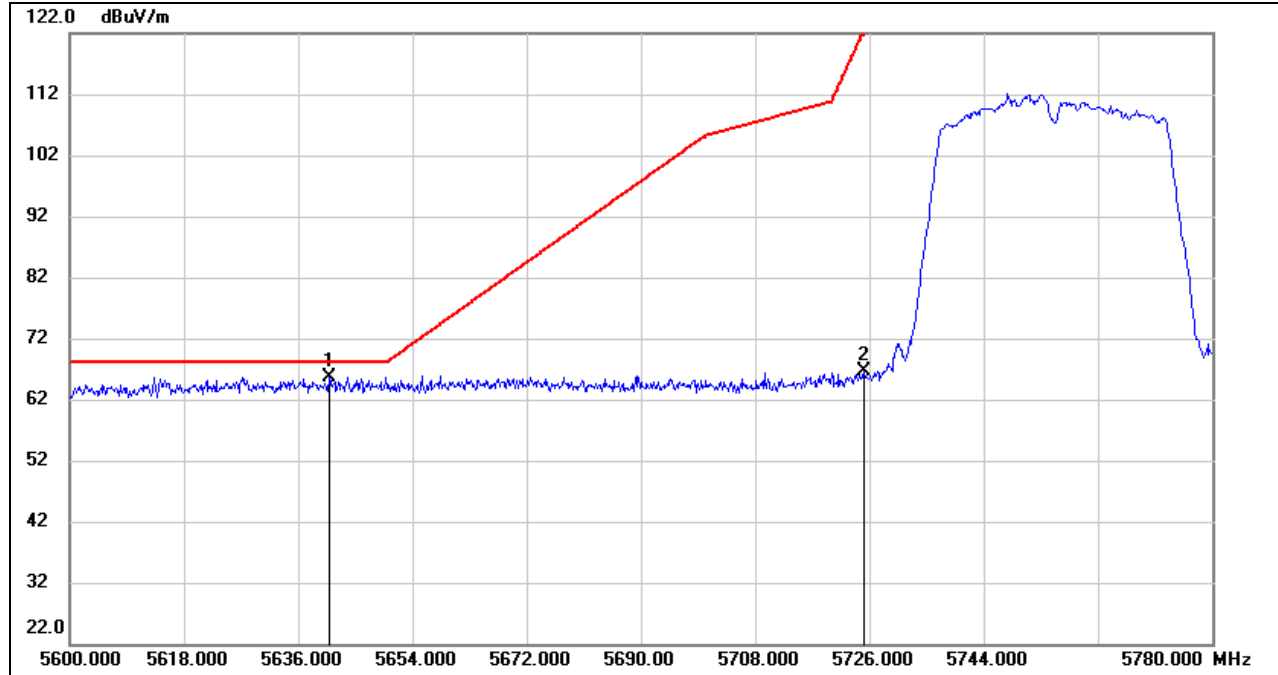

No.	Frequency (MHz)	Reading (dBuV)	Correct (dB/m)	Result (dBuV/m)	Limit (dBuV/m)	Margin (dB)	Remark
1	5640.860	24.08	41.66	65.74	68.20	-2.46	peak
2	5725.000	25.00	41.67	66.67	122.20	-55.53	peak

- Note: 1. Measurement = Reading Level + Correct Factor.
 2. If Peak Result complies with AV limit, AV Result is deemed to comply with AV limit.
 3. Peak: Peak detector.
 4. Only the worst data was recorded, if it complies with the limit, the other emissions deemed to comply with the limit.

RESTRICTED BANDEDGE (HIGH CHANNEL, HORIZONTAL)

PEAK

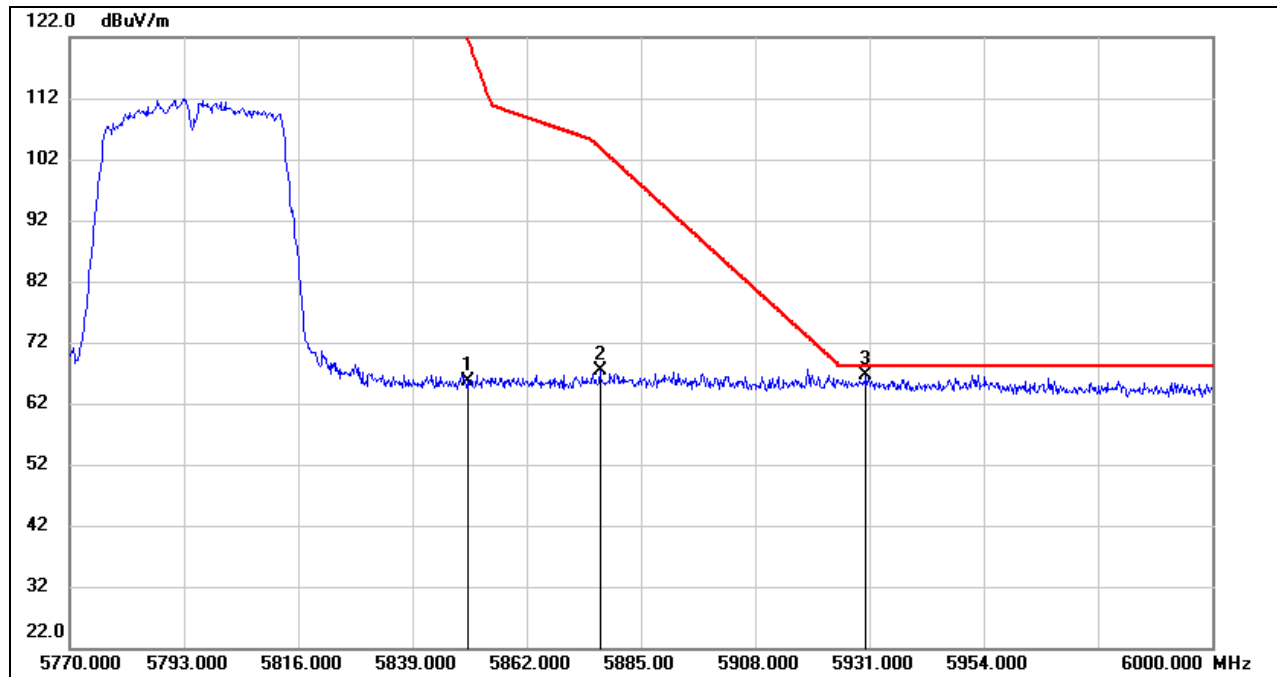

No.	Frequency (MHz)	Reading (dBuV)	Correct (dB/m)	Result (dBuV/m)	Limit (dBuV/m)	Margin (dB)	Remark
1	5850.000	23.15	42.52	65.67	122.20	-56.53	peak
2	5876.720	24.58	42.79	67.37	103.92	-36.55	peak
3	5930.310	23.79	42.89	66.68	68.20	-1.52	peak

Note: 1. Measurement = Reading Level + Correct Factor.
 2. If Peak Result complies with AV limit, AV Result is deemed to comply with AV limit.
 3. Peak: Peak detector.
 4. Only the worst data was recorded, if it complies with the limit, the other emissions deemed to comply with the limit.

Note: All the modes and antennas had been tested, but only the worst data was recorded in the report.

Note: Both horizontal and vertical had been tested, but only the worst data was recorded in the report.

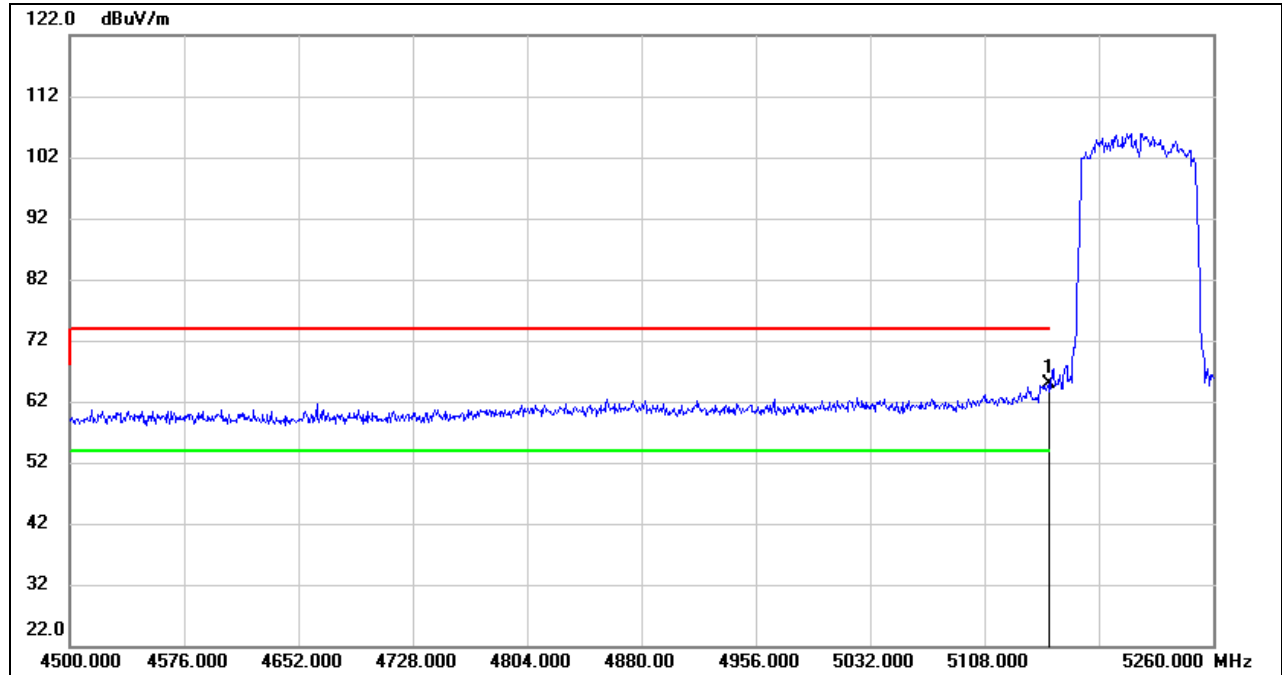
8.1.4. 802.11ac VHT80 CDD 4TX MODE
UNII-1 BAND
RESTRICTED BANDEDGE (LOW CHANNEL, HORIZONTAL)
PEAK

No.	Frequency (MHz)	Reading (dBuV)	Correct (dB/m)	Result (dBuV/m)	Limit (dBuV/m)	Margin (dB)	Remark
1	5150.000	23.74	41.19	64.93	74.00	-9.07	peak

- Note:
1. Measurement = Reading Level + Correct Factor.
 2. If Peak Result complies with AV limit, AV Result is deemed to comply with AV limit.
 3. Peak: Peak detector.
 4. Only the worst data was recorded, if it complies with the limit, the other emissions deemed to comply with the limit.

AVG

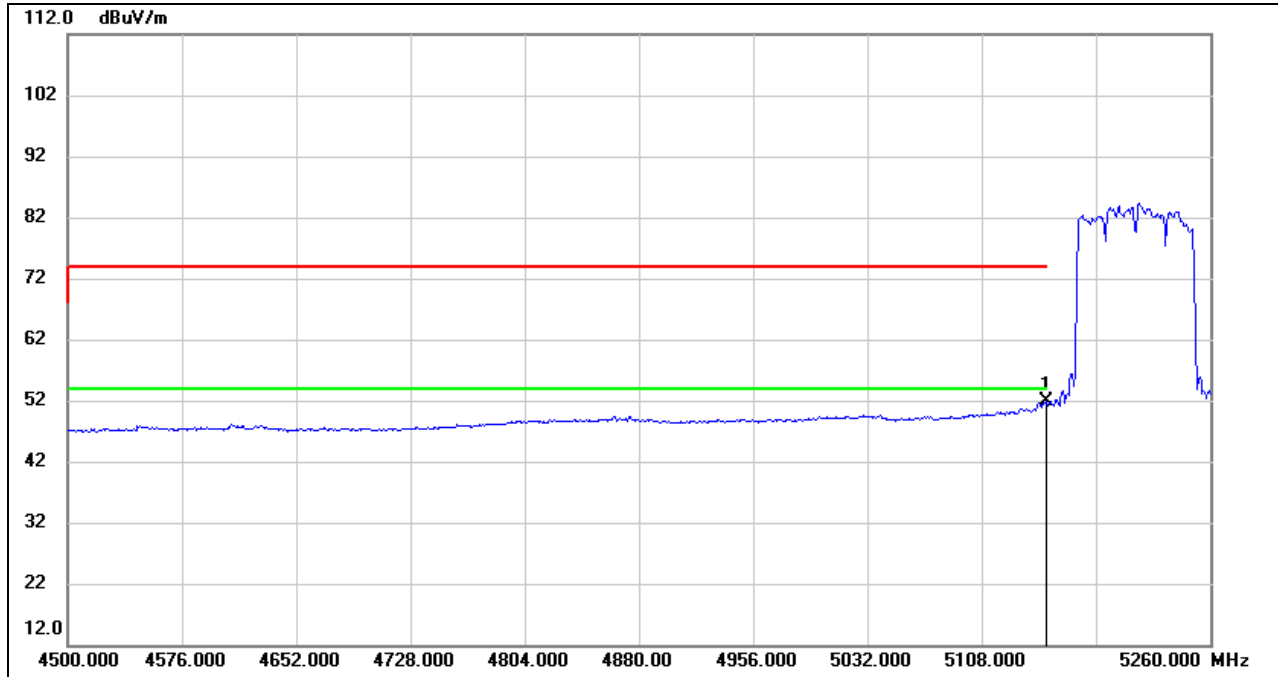

No.	Frequency (MHz)	Reading (dBuV)	Correct (dB/m)	Result (dBuV/m)	Limit (dBuV/m)	Margin (dB)	Remark
1	5150.000	10.61	41.19	51.80	54.00	-2.20	AVG

- Note:
1. Measurement = Reading Level + Correct Factor.
 2. If Peak Result complies with AV limit, AV Result is deemed to comply with AV limit.
 3. AVG: $VBW=1/T_{on}$, where: T_{on} is the transmitting duration.
 4. For the transmitting duration, please refer to clause 7.1.
 5. Only the worst data was recorded, if it complies with the limit, the other emissions deemed to comply with the limit.

UNII-2A BAND

RESTRICTED BANDEDGE (LOW CHANNEL, HORIZONTAL)

PEAK

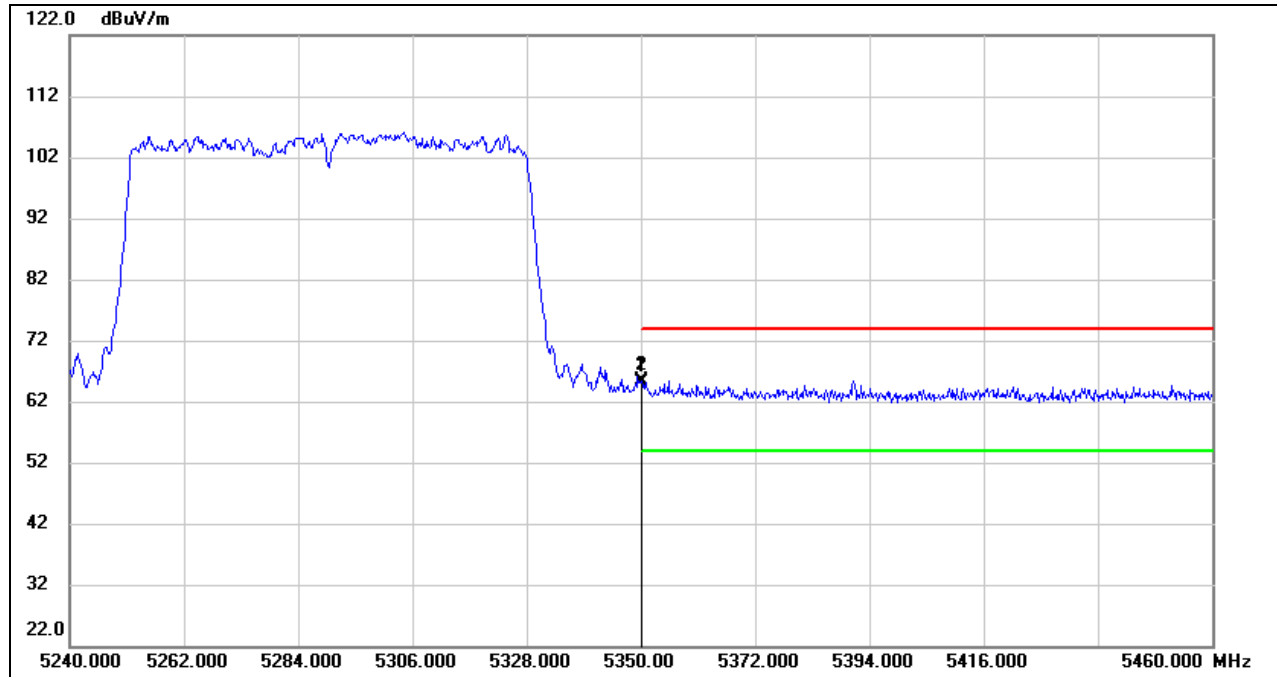

No.	Frequency (MHz)	Reading (dBuV)	Correct (dB/m)	Result (dBuV/m)	Limit (dBuV/m)	Margin (dB)	Remark
1	5350.000	23.96	41.20	65.16	74.00	-8.84	peak
2	5350.220	24.28	41.21	65.49	74.00	-8.51	peak

- Note: 1. Measurement = Reading Level + Correct Factor.
 2. If Peak Result complies with AV limit, AV Result is deemed to comply with AV limit.
 3. Peak: Peak detector.
 4. Only the worst data was recorded, if it complies with the limit, the other emissions deemed to comply with the limit.



AVG

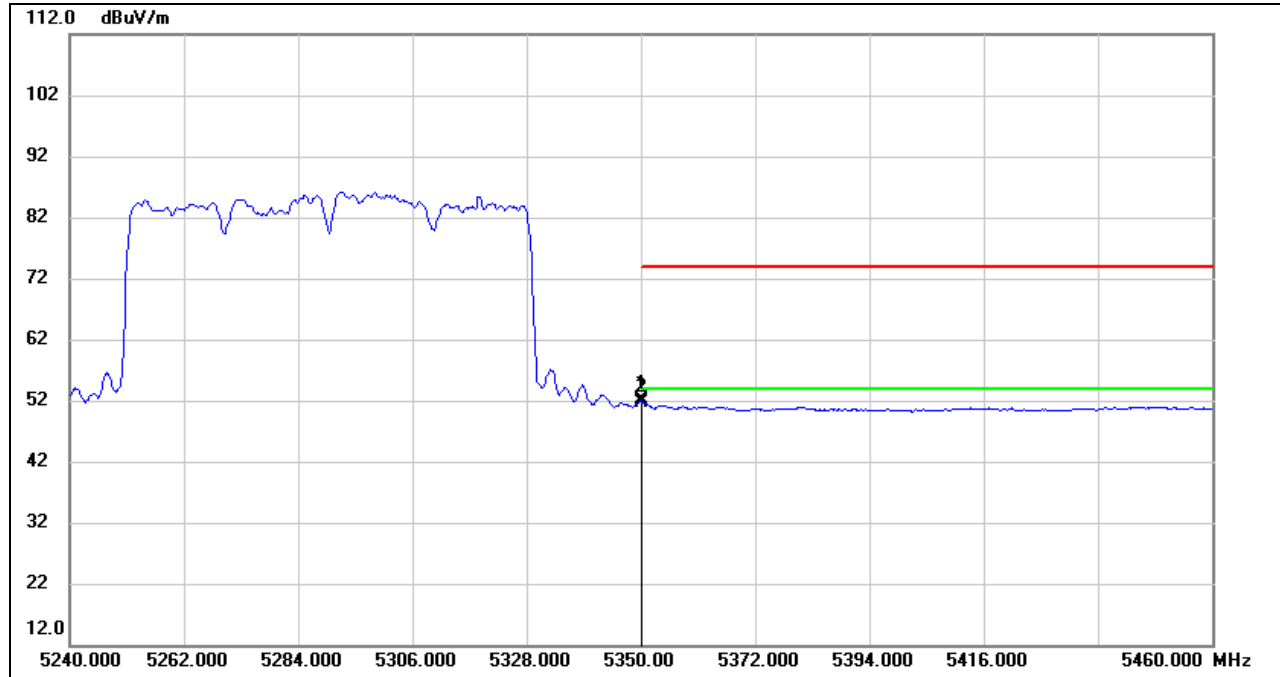

No.	Frequency (MHz)	Reading (dBuV)	Correct (dB/m)	Result (dBuV/m)	Limit (dBuV/m)	Margin (dB)	Remark
1	5350.000	10.82	41.20	52.02	54.00	-1.98	AVG
2	5350.220	10.50	41.21	51.71	54.00	-2.29	AVG

- Note:
1. Measurement = Reading Level + Correct Factor
 2. AVG: $VBW=1/Ton$ where: ton is transmit duration.
 3. For duty cycle, please refer to clause 7.1.
 4. Only the worst case emission will be recorder, if it complies with the limit, the other emissions deemed to comply with the limit.



UNII-2C BAND

RESTRICTED BANDEDGE (LOW CHANNEL, HORIZONTAL)

PEAK

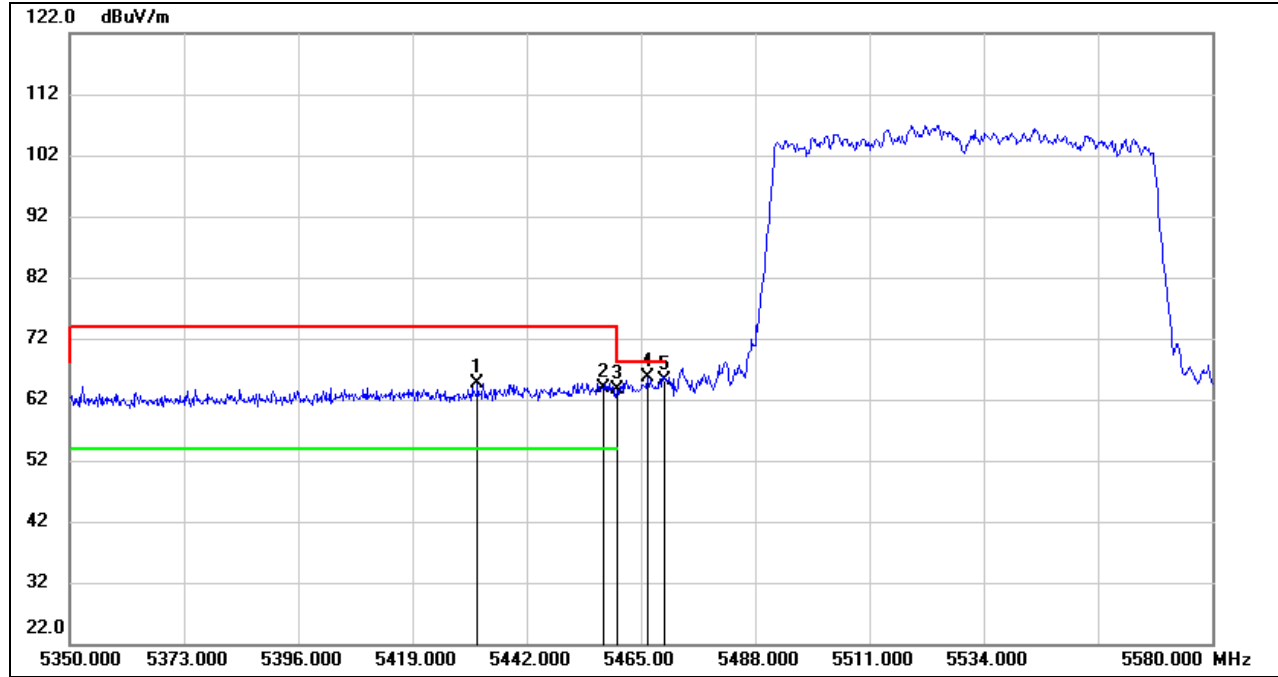

No.	Frequency (MHz)	Reading (dBuV)	Correct (dB/m)	Result (dBuV/m)	Limit (dBuV/m)	Margin (dB)	Remark
1	5432.110	23.07	41.66	64.73	74.00	-9.27	peak
2	5457.410	22.17	41.81	63.98	74.00	-10.02	peak
3	5460.000	21.73	41.82	63.55	68.20	-4.65	peak
4	5466.380	23.75	41.86	65.61	68.20	-2.59	peak
5	5470.000	23.14	41.87	65.01	68.20	-3.19	peak

Note: 1. Measurement = Reading Level + Correct Factor.
 2. If Peak Result complies with AV limit, AV Result is deemed to comply with AV limit.
 3. Peak: Peak detector.
 4. Only the worst data was recorded, if it complies with the limit, the other emissions deemed to comply with the limit.

AVG

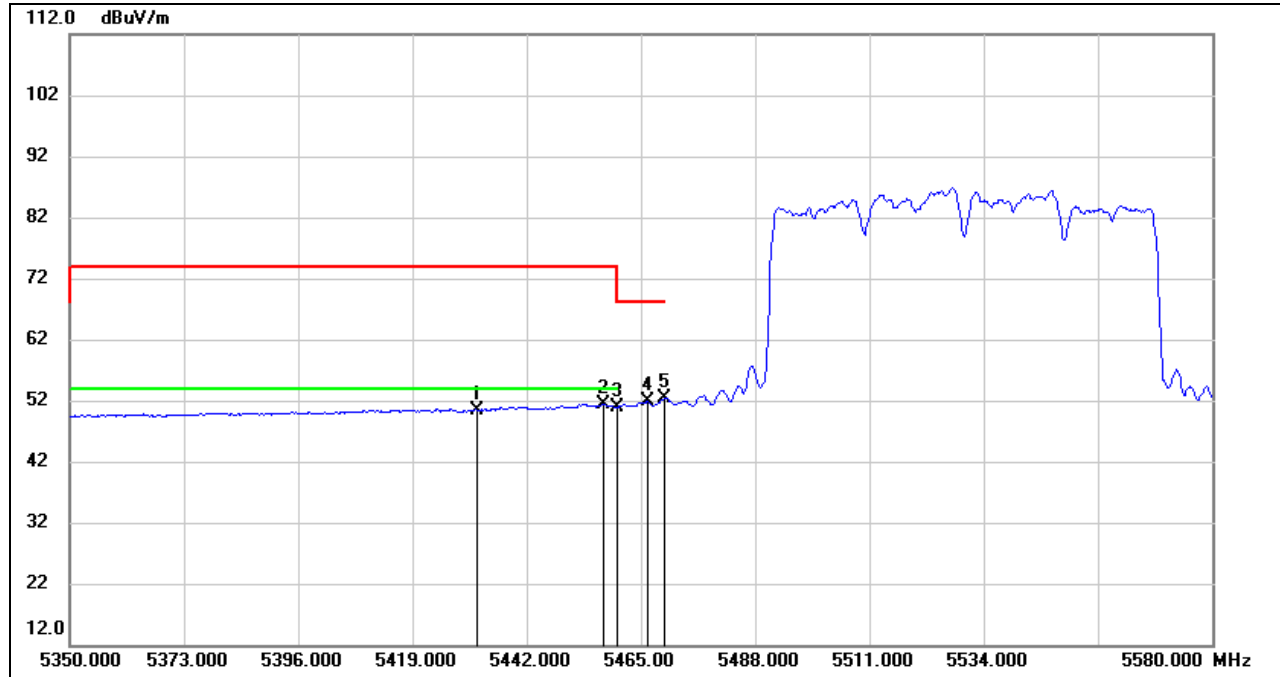

No.	Frequency (MHz)	Reading (dBuV)	Correct (dB/m)	Result (dBuV/m)	Limit (dBuV/m)	Margin (dB)	Remark
1	5432.110	8.83	41.66	50.49	54.00	-3.51	AVG
2	5457.410	9.55	41.81	51.36	54.00	-2.64	AVG
3	5460.000	9.06	41.82	50.88	54.00	-3.12	AVG
4	5466.380	9.94	41.86	51.80	68.20	-16.40	AVG
5	5470.000	10.49	41.87	52.36	68.20	-15.84	AVG

- Note:
1. Measurement = Reading Level + Correct Factor.
 2. If Peak Result complies with AV limit, AV Result is deemed to comply with AV limit.
 3. AVG: $VBW=1/T_{on}$, where: T_{on} is the transmitting duration.
 4. For the transmitting duration, please refer to clause 7.1.
 5. Only the worst data was recorded, if it complies with the limit, the other emissions deemed to comply with the limit.

RESTRICTED BANDEDGE (HIGH CHANNEL, HORIZONTAL)

PEAK

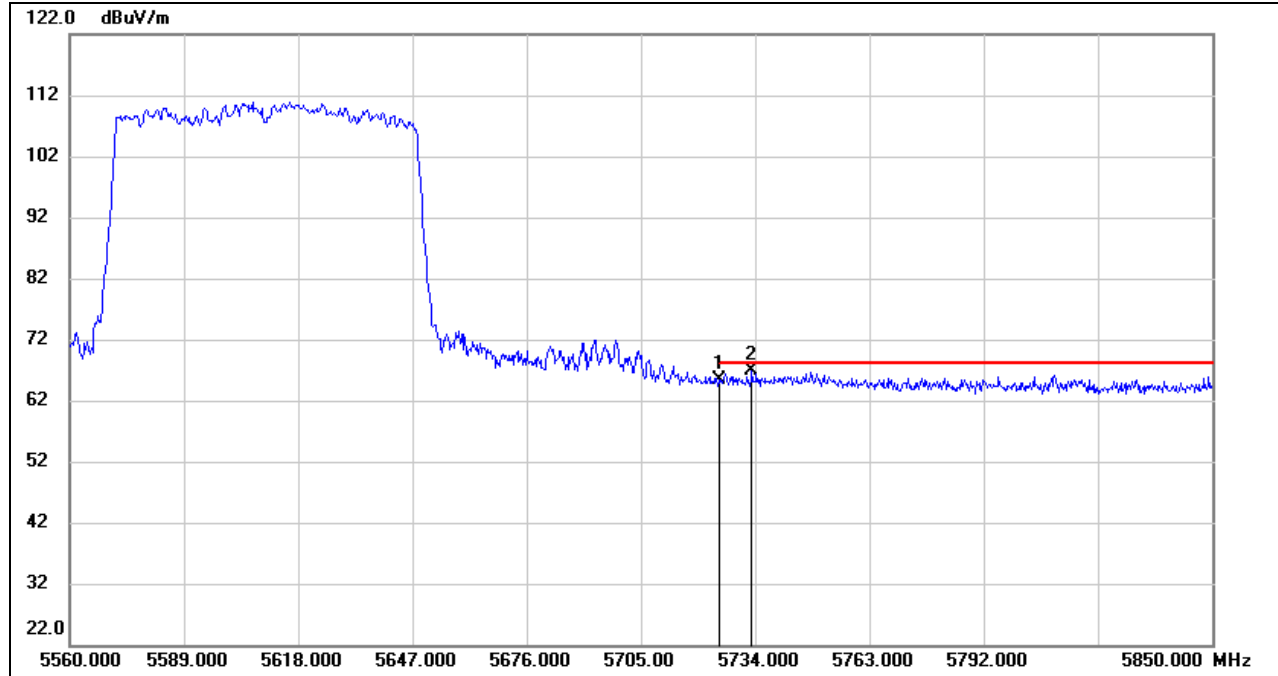

No.	Frequency (MHz)	Reading (dBuV)	Correct (dB/m)	Result (dBuV/m)	Limit (dBuV/m)	Margin (dB)	Remark
1	5725.000	23.66	41.67	65.33	68.20	-2.87	peak
2	5733.130	25.17	41.71	66.88	68.20	-1.32	peak

- Note: 1. Measurement = Reading Level + Correct Factor.
 2. If Peak Result complies with AV limit, AV Result is deemed to comply with AV limit.
 3. Peak: Peak detector.
 4. Only the worst data was recorded, if it complies with the limit, the other emissions deemed to comply with the limit.

UNII-3 BAND

RESTRICTED BANDEDGE (LOW CHANNEL, HORIZONTAL)

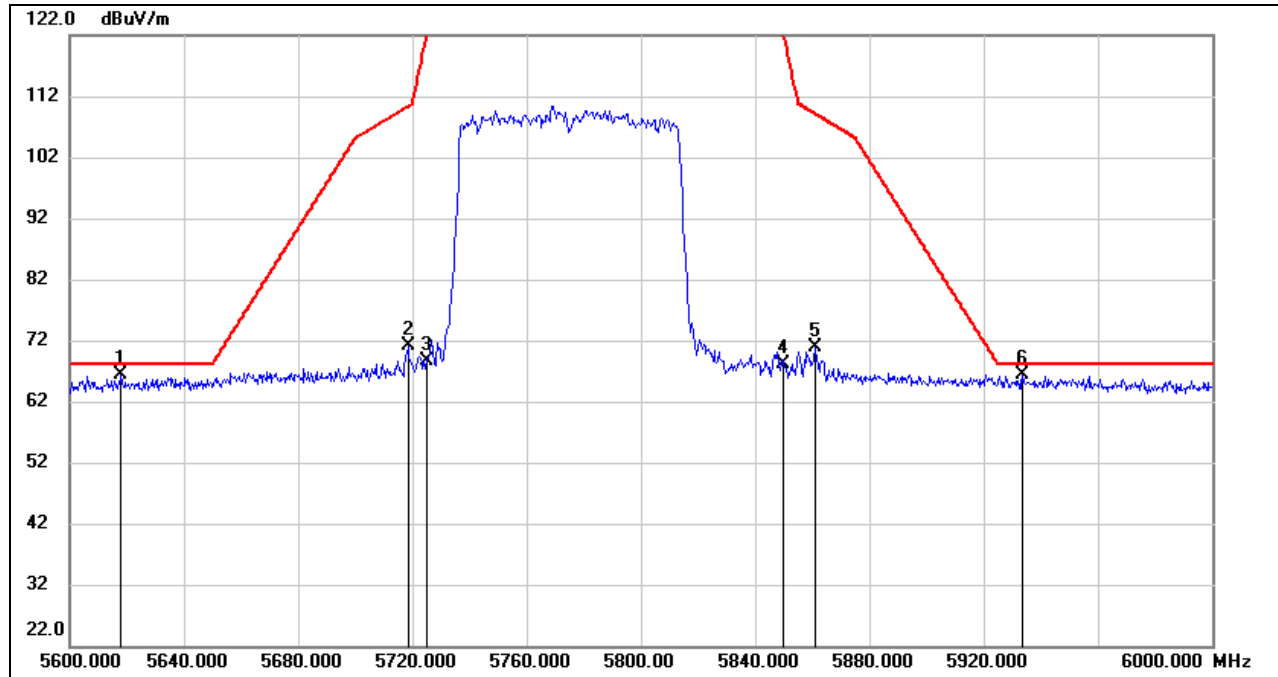

No.	Frequency (MHz)	Reading (dBuV)	Correct (dB/m)	Result (dBuV/m)	Limit (dBuV/m)	Margin (dB)	Remark
1	5618.000	24.77	41.70	66.47	68.20	-1.73	peak
2	5718.400	29.43	41.63	71.06	110.35	-39.29	peak
3	5725.000	26.89	41.67	68.56	122.20	-53.64	peak
4	5850.000	25.62	42.52	68.14	122.20	-54.06	peak
5	5860.800	28.27	42.63	70.90	109.17	-38.27	peak
6	5933.600	23.44	42.87	66.31	68.20	-1.89	peak

Note: 1. Measurement = Reading Level + Correct Factor.
 2. If Peak Result complies with AV limit, AV Result is deemed to comply with AV limit.
 3. Peak: Peak detector.
 4. Only the worst data was recorded, if it complies with the limit, the other emissions deemed to comply with the limit.

Note: All the modes and antennas had been tested, but only the worst data was recorded in the report.

Note: Both horizontal and vertical had been tested, but only the worst data was recorded in the report.

8.2. SPURIOUS EMISSIONS (1 GHz ~ 7 GHz)

8.2.1. 802.11a CDD 4TX MODE

UNII-1 BAND

HARMONICS AND SPURIOUS EMISSIONS (LOW CHANNEL, HORIZONTAL)

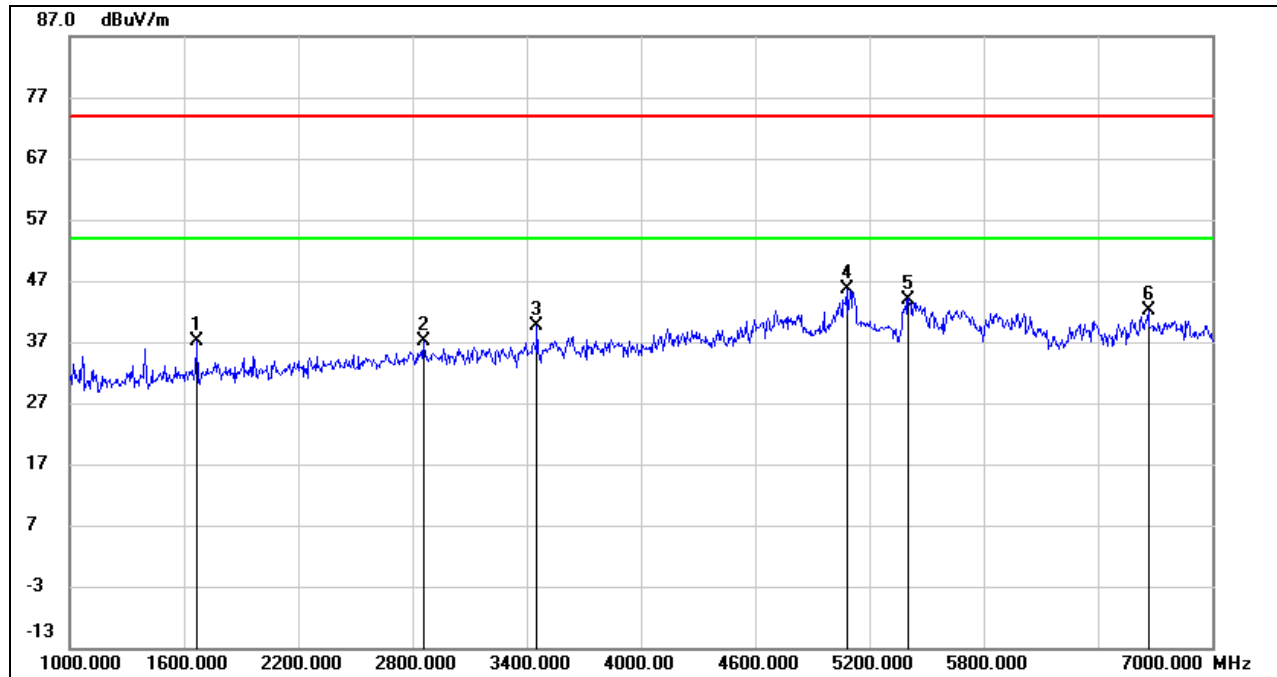

No.	Frequency (MHz)	Reading (dBuV)	Correct (dB/m)	Result (dBuV/m)	Limit (dBuV/m)	Margin (dB)	Remark
1	1666.000	48.20	-11.06	37.14	74.00	-36.86	peak
2	2860.000	43.43	-6.26	37.17	74.00	-36.83	peak
3	3454.000	44.52	-4.89	39.63	74.00	-34.37	peak
4	5080.000	44.36	1.38	45.74	74.00	-28.26	peak
5	5404.000	42.11	1.89	44.00	74.00	-30.00	peak
6	6664.000	36.49	5.53	42.02	74.00	-31.98	peak

- Note:
1. Measurement = Reading Level + Correct Factor.
 2. If Peak Result complies with AV limit, AV Result is deemed to comply with AV limit.
 3. Peak: Peak detector.
 4. AVG: $VBW=1/Ton$, where: Ton is the transmitting duration.
 5. For the transmitting duration, please refer to clause 7.1.
 6. Filter losses were only considered in the spurious frequency bands and the authorized band was not corrected for Band reject filter losses.
 7. Proper operation of the transmitter prior to adding the filter to the measurement chain.
 8. Since non-restricted band peak emissions are less than the average limit, they also comply with the -27dBm/MHz (68.2dBuV/m) limit.

HARMONICS AND SPURIOUS EMISSIONS (LOW CHANNEL, VERTICAL)

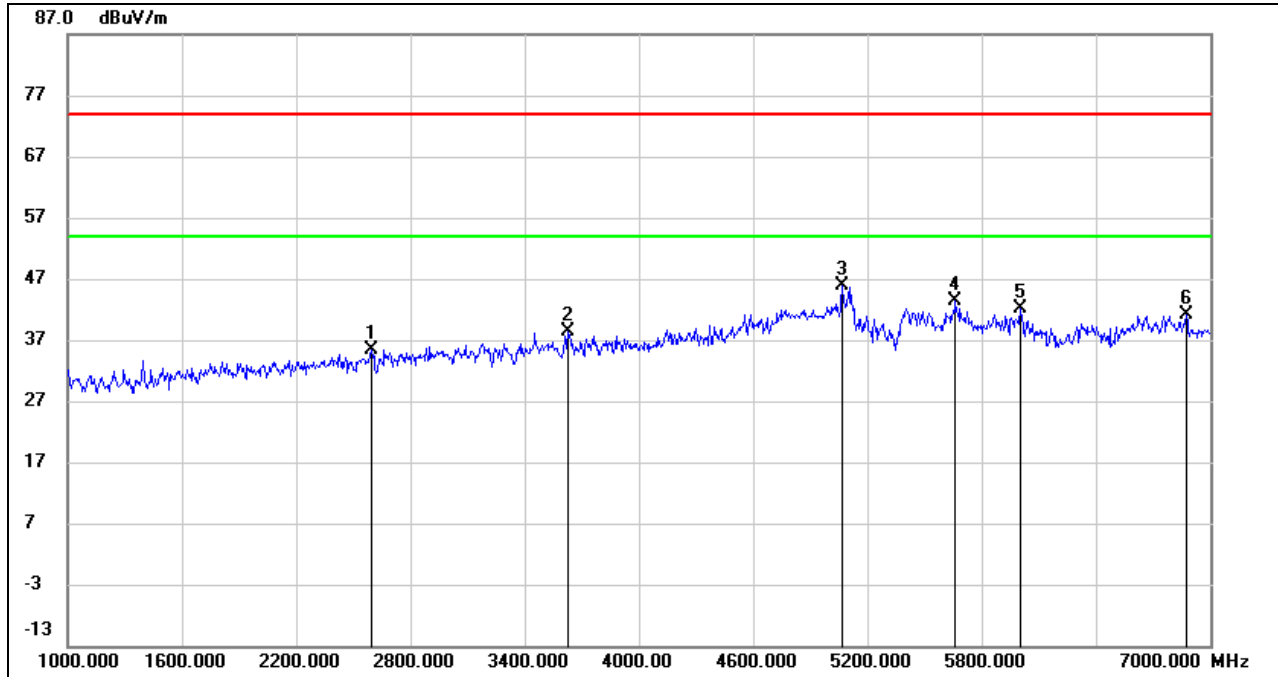

No.	Frequency (MHz)	Reading (dBuV)	Correct (dB/m)	Result (dBuV/m)	Limit (dBuV/m)	Margin (dB)	Remark
1	2596.000	43.23	-7.88	35.35	74.00	-38.65	peak
2	3628.000	42.38	-4.05	38.33	74.00	-35.67	peak
3	5068.000	44.61	1.31	45.92	74.00	-28.08	peak
4	5662.000	40.79	2.47	43.26	74.00	-30.74	peak
5	6004.000	38.72	3.30	42.02	74.00	-31.98	peak
6	6874.000	35.42	5.78	41.20	74.00	-32.80	peak

- Note:
1. Measurement = Reading Level + Correct Factor.
 2. If Peak Result complies with AV limit, AV Result is deemed to comply with AV limit.
 3. Peak: Peak detector.
 4. AVG: $VBW=1/Ton$, where: Ton is the transmitting duration.
 5. For the transmitting duration, please refer to clause 7.1.
 6. Filter losses were only considered in the spurious frequency bands and the authorized band was not corrected for Band reject filter losses.
 7. Proper operation of the transmitter prior to adding the filter to the measurement chain.
 8. Since non-restricted band peak emissions are less than the average limit, they also comply with the -27dBm/MHz (68.2dBuV/m) limit.

HARMONICS AND SPURIOUS EMISSIONS (MID CHANNEL, HORIZONTAL)

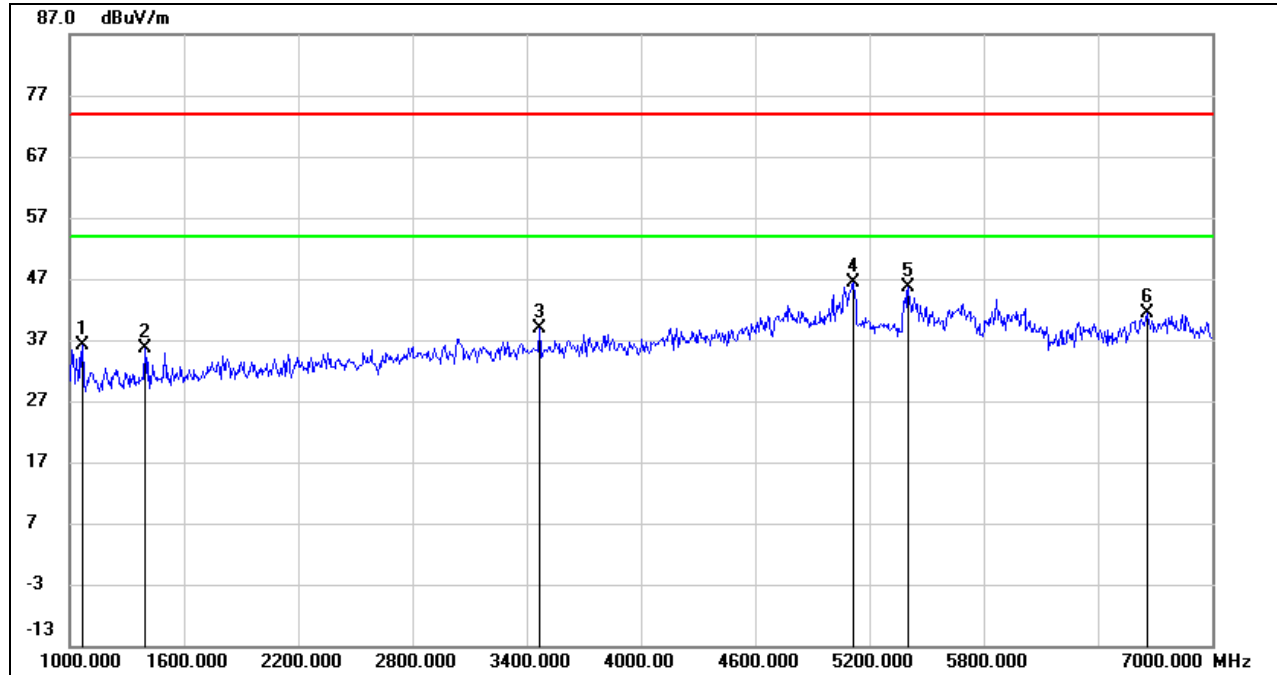

No.	Frequency (MHz)	Reading (dBuV)	Correct (dB/m)	Result (dBuV/m)	Limit (dBuV/m)	Margin (dB)	Remark
1	1066.000	49.85	-13.65	36.20	74.00	-37.80	peak
2	1396.000	48.34	-12.71	35.63	74.00	-38.37	peak
3	3466.000	43.75	-4.85	38.90	74.00	-35.10	peak
4	5116.000	44.81	1.60	46.41	74.00	-27.59	peak
5	5404.000	43.78	1.89	45.67	74.00	-28.33	peak
6	6658.000	35.77	5.51	41.28	74.00	-32.72	peak

Note: 1. Measurement = Reading Level + Correct Factor.

2. If Peak Result complies with AV limit, AV Result is deemed to comply with AV limit.

3. Peak: Peak detector.

4. AVG: $VBW=1/Ton$, where: Ton is the transmitting duration.

5. For the transmitting duration, please refer to clause 7.1.

6. Filter losses were only considered in the spurious frequency bands and the authorized band was not corrected for Band reject filter losses.

7. Proper operation of the transmitter prior to adding the filter to the measurement chain.

8. Since non-restricted band peak emissions are less than the average limit, they also comply with the -27dBm/MHz (68.2dBuV/m) limit.

HARMONICS AND SPURIOUS EMISSIONS (MID CHANNEL, VERTICAL)

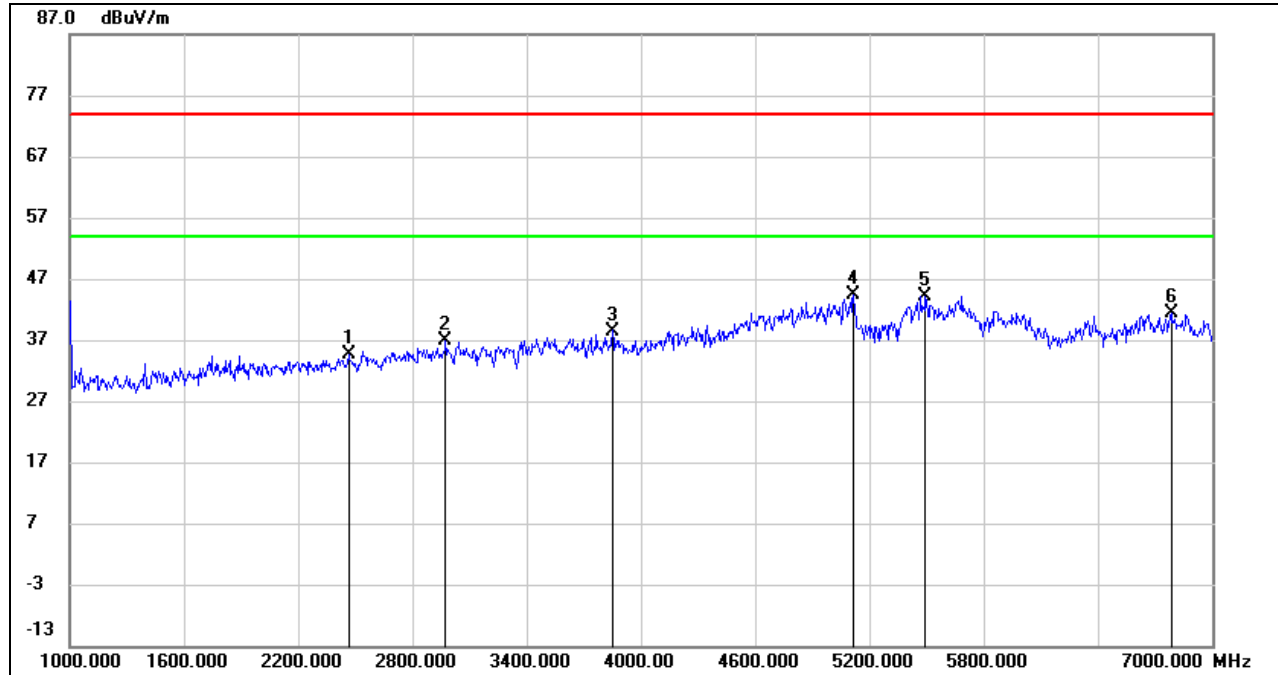

No.	Frequency (MHz)	Reading (dBuV)	Correct (dB/m)	Result (dBuV/m)	Limit (dBuV/m)	Margin (dB)	Remark
1	2464.000	42.87	-8.27	34.60	74.00	-39.40	peak
2	2974.000	42.69	-5.71	36.98	74.00	-37.02	peak
3	3850.000	41.85	-3.35	38.50	74.00	-35.50	peak
4	5116.000	42.69	1.60	44.29	74.00	-29.71	peak
5	5494.000	42.00	2.14	44.14	74.00	-29.86	peak
6	6784.000	35.90	5.56	41.46	74.00	-32.54	peak

- Note:
1. Measurement = Reading Level + Correct Factor.
 2. If Peak Result complies with AV limit, AV Result is deemed to comply with AV limit.
 3. Peak: Peak detector.
 4. AVG: $VBW=1/Ton$, where: Ton is the transmitting duration.
 5. For the transmitting duration, please refer to clause 7.1.
 6. Filter losses were only considered in the spurious frequency bands and the authorized band was not corrected for Band reject filter losses.
 7. Proper operation of the transmitter prior to adding the filter to the measurement chain.
 8. Since non-restricted band peak emissions are less than the average limit, they also comply with the -27dBm/MHz (68.2dBuV/m) limit.

HARMONICS AND SPURIOUS EMISSIONS (HIGH CHANNEL, HORIZONTAL)

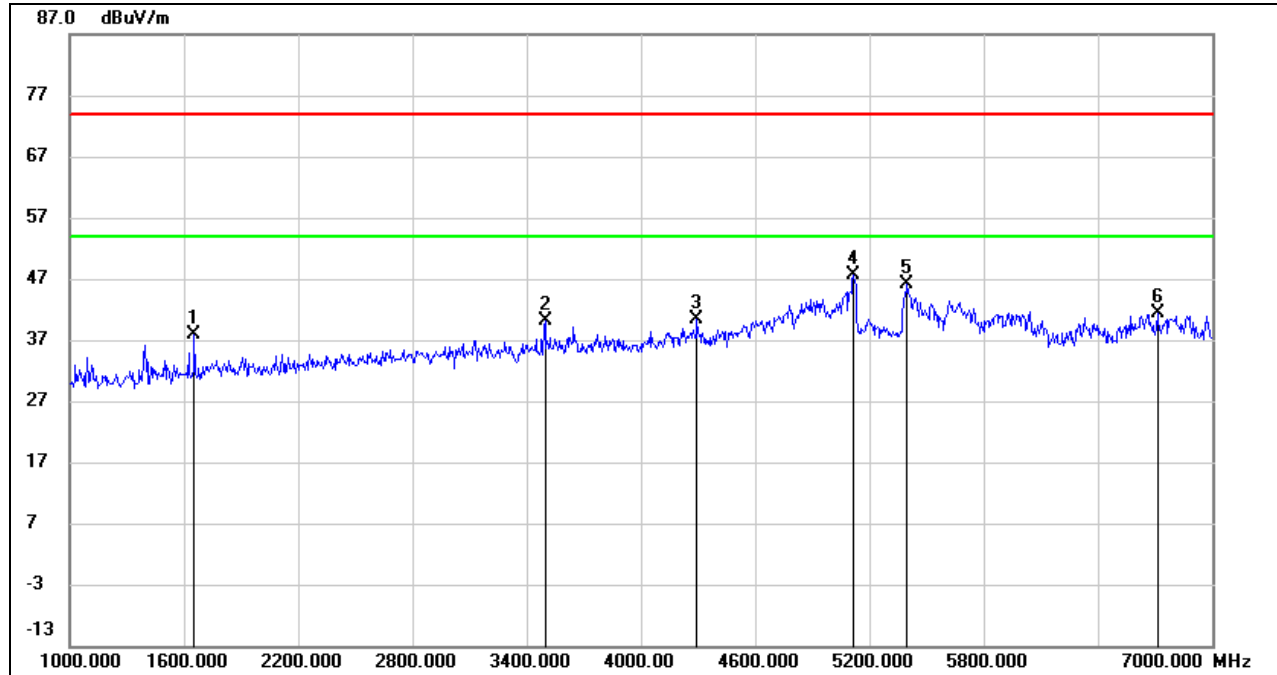

No.	Frequency (MHz)	Reading (dBuV)	Correct (dB/m)	Result (dBuV/m)	Limit (dBuV/m)	Margin (dB)	Remark
1	1654.000	49.00	-11.15	37.85	74.00	-36.15	peak
2	3496.000	44.73	-4.72	40.01	74.00	-33.99	peak
3	4294.000	42.04	-1.76	40.28	74.00	-33.72	peak
4	5116.000	45.92	1.60	47.52	74.00	-26.48	peak
5	5398.000	44.30	1.88	46.18	74.00	-27.82	peak
6	6712.000	35.73	5.54	41.27	74.00	-32.73	peak

Note: 1. Measurement = Reading Level + Correct Factor.

2. If Peak Result complies with AV limit, AV Result is deemed to comply with AV limit.

3. Peak: Peak detector.

4. AVG: $VBW=1/Ton$, where: Ton is the transmitting duration.

5. For the transmitting duration, please refer to clause 7.1.

6. Filter losses were only considered in the spurious frequency bands and the authorized band was not corrected for Band reject filter losses.

7. Proper operation of the transmitter prior to adding the filter to the measurement chain.

8. Since non-restricted band peak emissions are less than the average limit, they also comply with the -27dBm/MHz (68.2dBuV/m) limit.

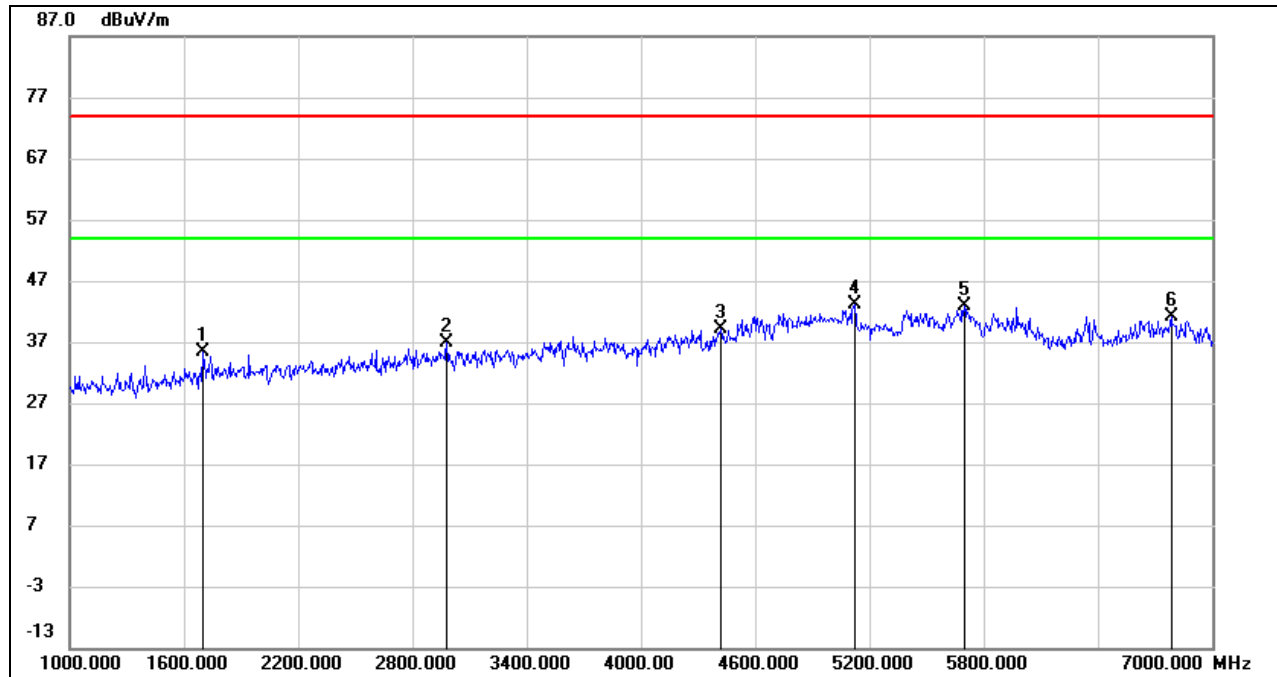
**HARMONICS AND SPURIOUS EMISSIONS (HIGH CHANNEL, VERTICAL)**

No.	Frequency (MHz)	Reading (dBuV)	Correct (dB/m)	Result (dBuV/m)	Limit (dBuV/m)	Margin (dB)	Remark
1	1696.000	46.10	-10.84	35.26	74.00	-38.74	peak
2	2980.000	42.58	-5.69	36.89	74.00	-37.11	peak
3	4420.000	40.89	-1.74	39.15	74.00	-34.85	peak
4	5122.000	41.39	1.64	43.03	74.00	-30.97	peak
5	5698.000	40.48	2.49	42.97	74.00	-31.03	peak
6	6784.000	35.68	5.56	41.24	74.00	-32.76	peak

- Note:
1. Measurement = Reading Level + Correct Factor.
 2. If Peak Result complies with AV limit, AV Result is deemed to comply with AV limit.
 3. Peak: Peak detector.
 4. AVG: $VBW=1/Ton$, where: Ton is the transmitting duration.
 5. For the transmitting duration, please refer to clause 7.1.
 6. Filter losses were only considered in the spurious frequency bands and the authorized band was not corrected for Band reject filter losses.
 7. Proper operation of the transmitter prior to adding the filter to the measurement chain.
 8. Since non-restricted band peak emissions are less than the average limit, they also comply with the -27dBm/MHz (68.2dBuV/m) limit.

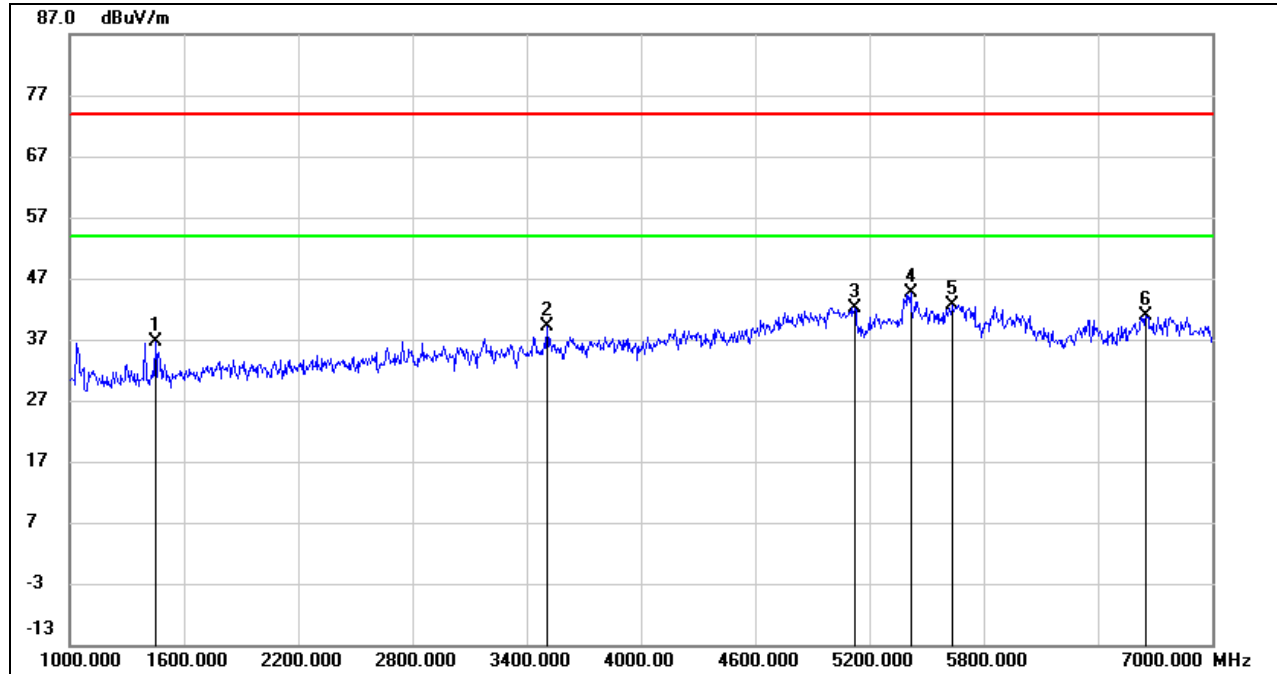
**UNII-2A BAND****TEST RESULTS (WORST CASE)****HARMONICS AND SPURIOUS EMISSIONS (LOW CHANNEL, HORIZONTAL)**

No.	Frequency (MHz)	Reading (dBuV)	Correct (dB/m)	Result (dBuV/m)	Limit (dBuV/m)	Margin (dB)	Remark
1	1450.000	49.17	-12.46	36.71	74.00	-37.29	peak
2	3508.000	43.78	-4.67	39.11	74.00	-34.89	peak
3	5122.000	40.61	1.64	42.25	74.00	-31.75	peak
4	5416.000	42.60	1.92	44.52	74.00	-29.48	peak
5	5638.000	40.18	2.47	42.65	74.00	-31.35	peak
6	6652.000	35.31	5.52	40.83	74.00	-33.17	peak

Note: 1. Measurement = Reading Level + Correct Factor.

2. If Peak Result complies with AV limit, AV Result is deemed to comply with AV limit.

3. Peak: Peak detector.

4. AVG: $VBW=1/Ton$, where: Ton is the transmitting duration.

5. For the transmitting duration, please refer to clause 7.1.

6. Filter losses were only considered in the spurious frequency bands and the authorized band was not corrected for Band reject filter losses.

7. Proper operation of the transmitter prior to adding the filter to the measurement chain.

8. Since non-restricted band peak emissions are less than the average limit, they also comply with the -27dBm/MHz (68.2dBuV/m) limit.

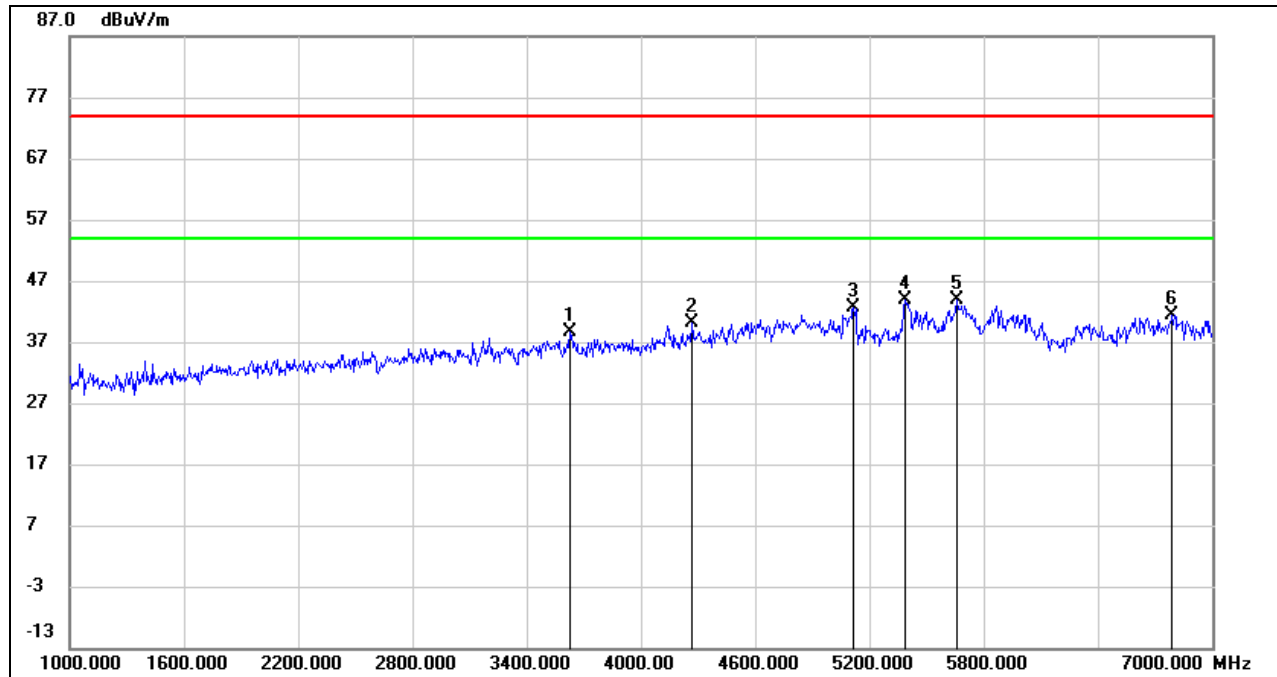
**HARMONICS AND SPURIOUS EMISSIONS (LOW CHANNEL, VERTICAL)**

No.	Frequency (MHz)	Reading (dBuV)	Correct (dB/m)	Result (dBuV/m)	Limit (dBuV/m)	Margin (dB)	Remark
1	3628.000	42.65	-4.05	38.60	74.00	-35.40	peak
2	4270.000	41.98	-1.73	40.25	74.00	-33.75	peak
3	5116.000	41.11	1.60	42.71	74.00	-31.29	peak
4	5386.000	41.92	1.89	43.81	74.00	-30.19	peak
5	5662.000	41.47	2.47	43.94	74.00	-30.06	peak
6	6790.000	35.83	5.57	41.40	74.00	-32.60	peak

- Note:
1. Measurement = Reading Level + Correct Factor.
 2. If Peak Result complies with AV limit, AV Result is deemed to comply with AV limit.
 3. Peak: Peak detector.
 4. AVG: $VBW=1/Ton$, where: Ton is the transmitting duration.
 5. For the transmitting duration, please refer to clause 7.1.
 6. Filter losses were only considered in the spurious frequency bands and the authorized band was not corrected for Band reject filter losses.
 7. Proper operation of the transmitter prior to adding the filter to the measurement chain.
 8. Since non-restricted band peak emissions are less than the average limit, they also comply with the -27dBm/MHz (68.2dBuV/m) limit.

HARMONICS AND SPURIOUS EMISSIONS (MID CHANNEL, HORIZONTAL)

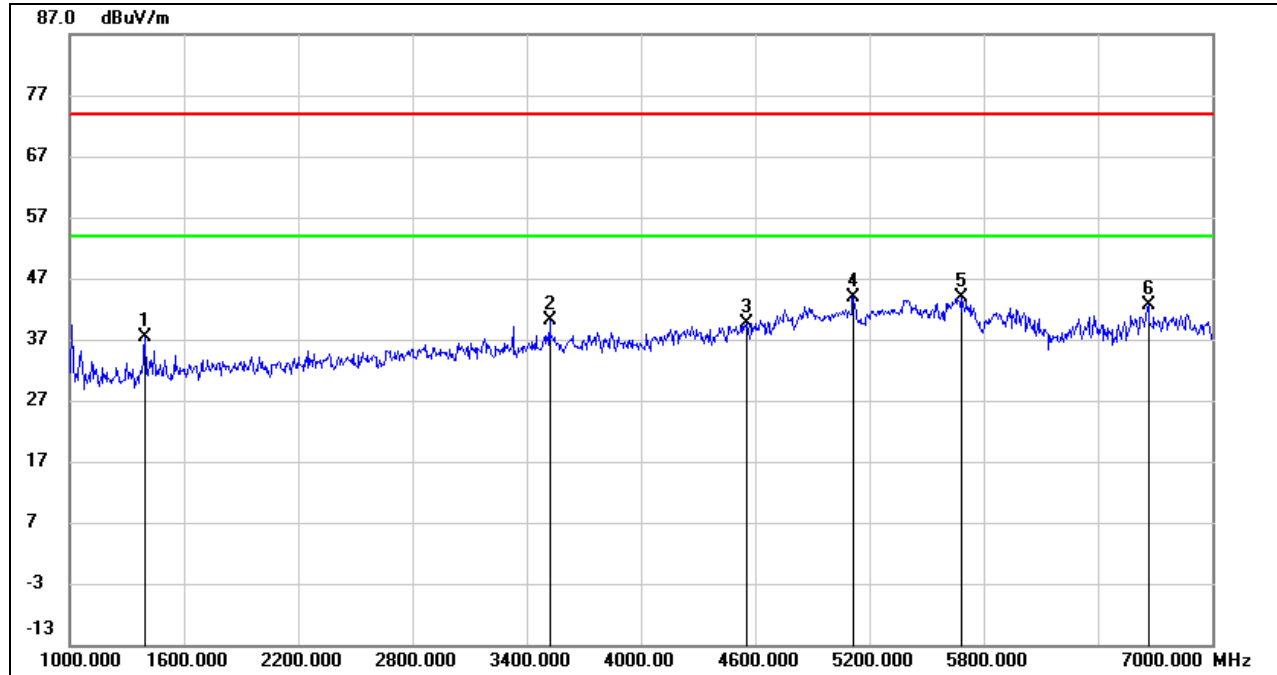

No.	Frequency (MHz)	Reading (dBuV)	Correct (dB/m)	Result (dBuV/m)	Limit (dBuV/m)	Margin (dB)	Remark
1	1396.000	50.12	-12.71	37.41	74.00	-36.59	peak
2	3520.000	44.82	-4.61	40.21	74.00	-33.79	peak
3	4558.000	40.57	-0.84	39.73	74.00	-34.27	peak
4	5116.000	42.22	1.60	43.82	74.00	-30.18	peak
5	5686.000	41.50	2.47	43.97	74.00	-30.03	peak
6	6664.000	37.06	5.53	42.59	74.00	-31.41	peak

Note: 1. Measurement = Reading Level + Correct Factor.

2. If Peak Result complies with AV limit, AV Result is deemed to comply with AV limit.

3. Peak: Peak detector.

4. AVG: $VBW=1/Ton$, where: Ton is the transmitting duration.

5. For the transmitting duration, please refer to clause 7.1.

6. Filter losses were only considered in the spurious frequency bands and the authorized band was not corrected for Band reject filter losses.

7. Proper operation of the transmitter prior to adding the filter to the measurement chain.

8. Since non-restricted band peak emissions are less than the average limit, they also comply with the -27dBm/MHz (68.2dBuV/m) limit.

HARMONICS AND SPURIOUS EMISSIONS (MID CHANNEL, VERTICAL)

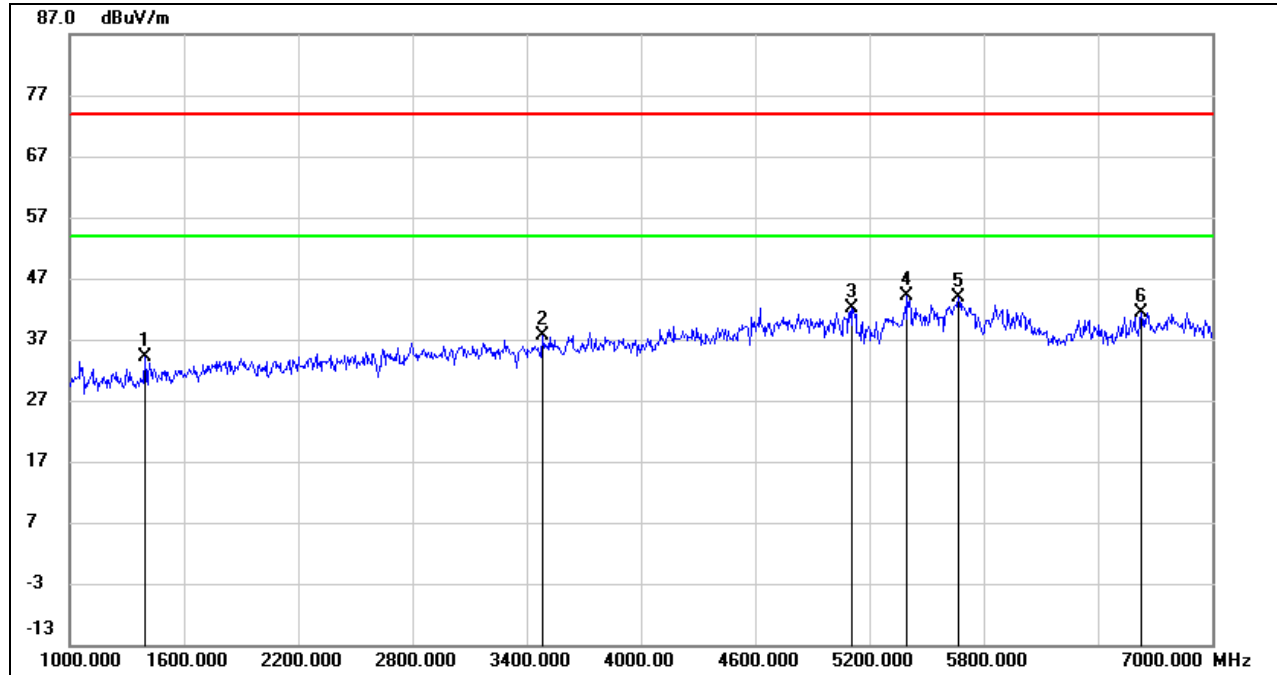

No.	Frequency (MHz)	Reading (dBuV)	Correct (dB/m)	Result (dBuV/m)	Limit (dBuV/m)	Margin (dB)	Remark
1	1396.000	46.78	-12.71	34.07	74.00	-39.93	peak
2	3484.000	42.47	-4.77	37.70	74.00	-36.30	peak
3	5110.000	40.59	1.55	42.14	74.00	-31.86	peak
4	5398.000	42.29	1.88	44.17	74.00	-29.83	peak
5	5668.000	41.40	2.47	43.87	74.00	-30.13	peak
6	6628.000	35.94	5.50	41.44	74.00	-32.56	peak

- Note:
1. Measurement = Reading Level + Correct Factor.
 2. If Peak Result complies with AV limit, AV Result is deemed to comply with AV limit.
 3. Peak: Peak detector.
 4. AVG: $VBW=1/Ton$, where: Ton is the transmitting duration.
 5. For the transmitting duration, please refer to clause 7.1.
 6. Filter losses were only considered in the spurious frequency bands and the authorized band was not corrected for Band reject filter losses.
 7. Proper operation of the transmitter prior to adding the filter to the measurement chain.
 8. Since non-restricted band peak emissions are less than the average limit, they also comply with the -27dBm/MHz (68.2dBuV/m) limit.

HARMONICS AND SPURIOUS EMISSIONS (HIGH CHANNEL, HORIZONTAL)

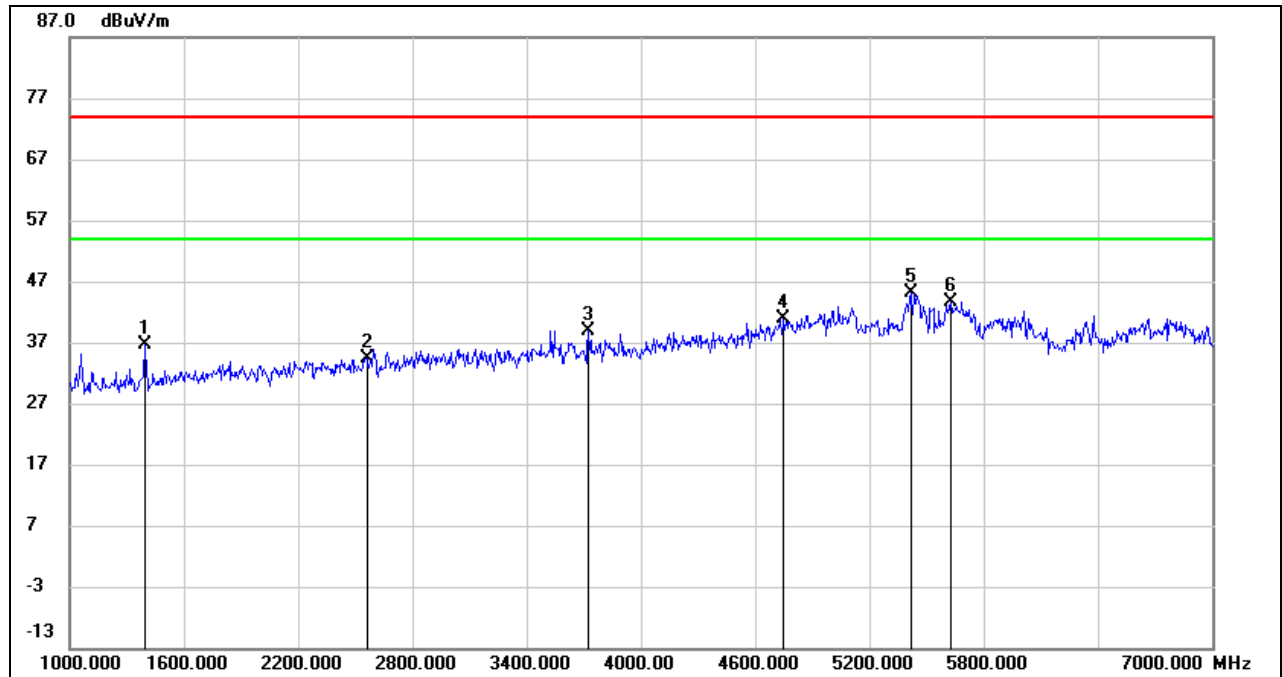

No.	Frequency (MHz)	Reading (dBuV)	Correct (dB/m)	Result (dBuV/m)	Limit (dBuV/m)	Margin (dB)	Remark
1	1396.000	49.26	-12.71	36.55	74.00	-37.45	peak
2	2560.000	42.44	-8.00	34.44	74.00	-39.56	peak
3	3724.000	42.51	-3.61	38.90	74.00	-35.10	peak
4	4750.000	40.65	0.30	40.95	74.00	-33.05	peak
5	5416.000	43.26	1.92	45.18	74.00	-28.82	peak
6	5626.000	41.28	2.46	43.74	74.00	-30.26	peak

- Note: 1. Measurement = Reading Level + Correct Factor.
 2. If Peak Result complies with AV limit, AV Result is deemed to comply with AV limit.
 3. Peak: Peak detector.
 4. AVG: $VBW=1/T_{on}$, where: T_{on} is the transmitting duration.
 5. For the transmitting duration, please refer to clause 7.1.
 6. Filter losses were only considered in the spurious frequency bands and the authorized band was not corrected for Band reject filter losses.
 7. Proper operation of the transmitter prior to adding the filter to the measurement chain.
 8. Since non-restricted band peak emissions are less than the average limit, they also comply with the -27dBm/MHz (68.2dBuV/m) limit.

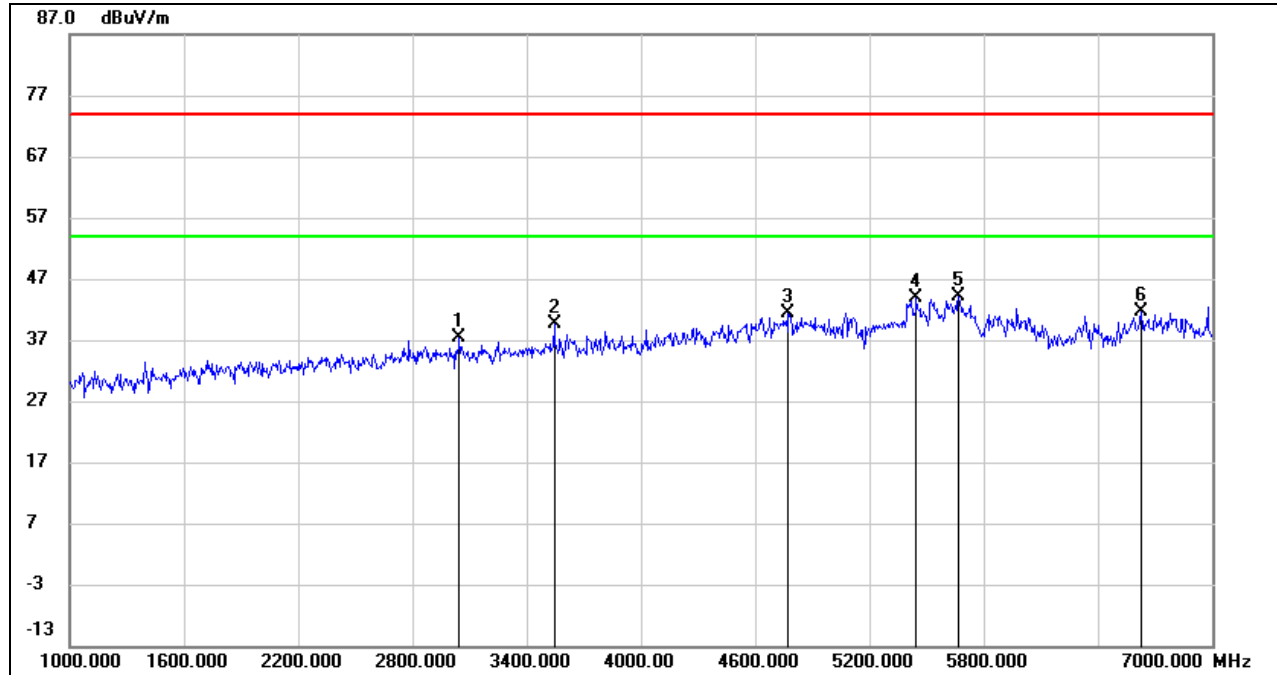
**HARMONICS AND SPURIOUS EMISSIONS (HIGH CHANNEL, VERTICAL)**

No.	Frequency (MHz)	Reading (dBuV)	Correct (dB/m)	Result (dBuV/m)	Limit (dBuV/m)	Margin (dB)	Remark
1	3046.000	42.90	-5.51	37.39	74.00	-36.61	peak
2	3544.000	44.11	-4.48	39.63	74.00	-34.37	peak
3	4774.000	40.99	0.43	41.42	74.00	-32.58	peak
4	5446.000	41.93	2.01	43.94	74.00	-30.06	peak
5	5668.000	41.69	2.47	44.16	74.00	-29.84	peak
6	6628.000	36.01	5.50	41.51	74.00	-32.49	peak

Note: 1. Measurement = Reading Level + Correct Factor.

2. If Peak Result complies with AV limit, AV Result is deemed to comply with AV limit.

3. Peak: Peak detector.

4. AVG: $VBW=1/Ton$, where: Ton is the transmitting duration.

5. For the transmitting duration, please refer to clause 7.1.

6. Filter losses were only considered in the spurious frequency bands and the authorized band was not corrected for Band reject filter losses.

7. Proper operation of the transmitter prior to adding the filter to the measurement chain.

8. Since non-restricted band peak emissions are less than the average limit, they also comply with the -27dBm/MHz (68.2dBuV/m) limit.

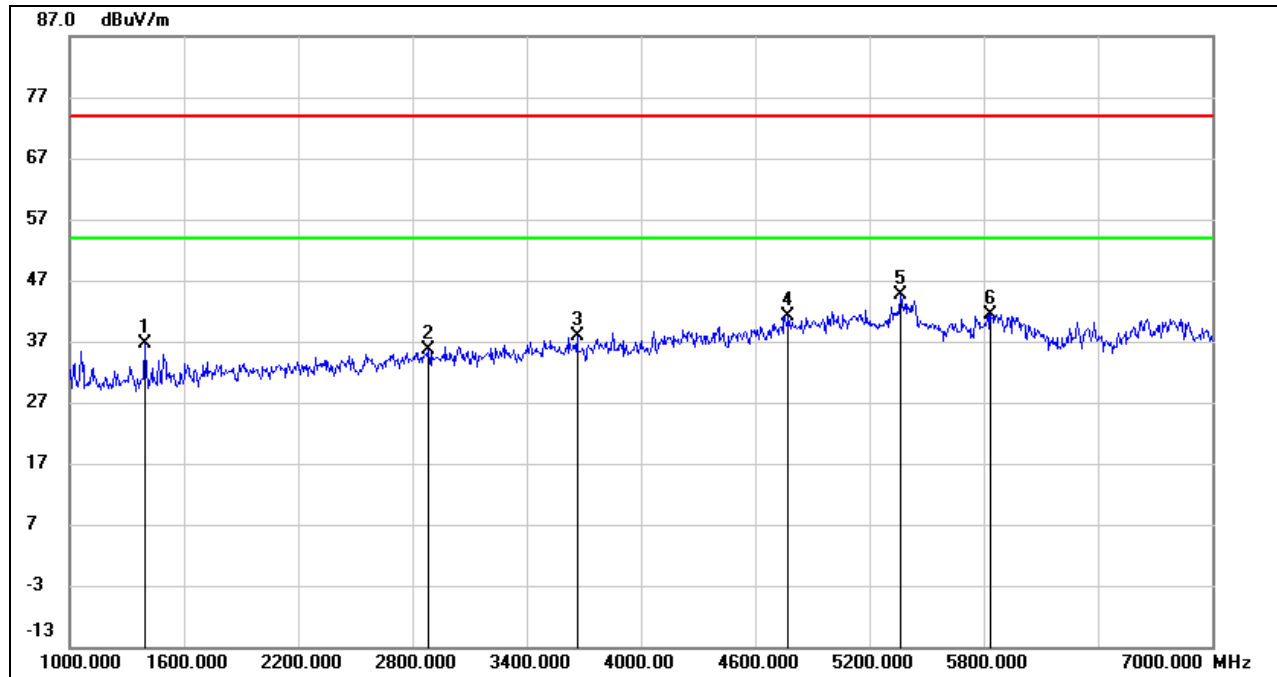
UNII-2C BAND
TEST RESULTS (WORST CASE)
HARMONICS AND SPURIOUS EMISSIONS (LOW CHANNEL, HORIZONTAL)

No.	Frequency (MHz)	Reading (dBuV)	Correct (dB/m)	Result (dBuV/m)	Limit (dBuV/m)	Margin (dB)	Remark
1	1396.000	49.41	-12.71	36.70	74.00	-37.30	peak
2	2884.000	41.78	-6.15	35.63	74.00	-38.37	peak
3	3664.000	41.66	-3.89	37.77	74.00	-36.23	peak
4	4774.000	40.75	0.43	41.18	74.00	-32.82	peak
5	5362.000	42.80	1.91	44.71	74.00	-29.29	peak
6	5836.000	38.84	2.65	41.49	74.00	-32.51	peak

- Note:
1. Measurement = Reading Level + Correct Factor.
 2. If Peak Result complies with AV limit, AV Result is deemed to comply with AV limit.
 3. Peak: Peak detector.
 4. AVG: $VBW=1/Ton$, where: Ton is the transmitting duration.
 5. For the transmitting duration, please refer to clause 7.1.
 6. Filter losses were only considered in the spurious frequency bands and the authorized band was not corrected for Band reject filter losses.
 7. Proper operation of the transmitter prior to adding the filter to the measurement chain.
 8. Since non-restricted band peak emissions are less than the average limit, they also comply with the -27dBm/MHz (68.2dBuV/m) limit.

HARMONICS AND SPURIOUS EMISSIONS (LOW CHANNEL, VERTICAL)

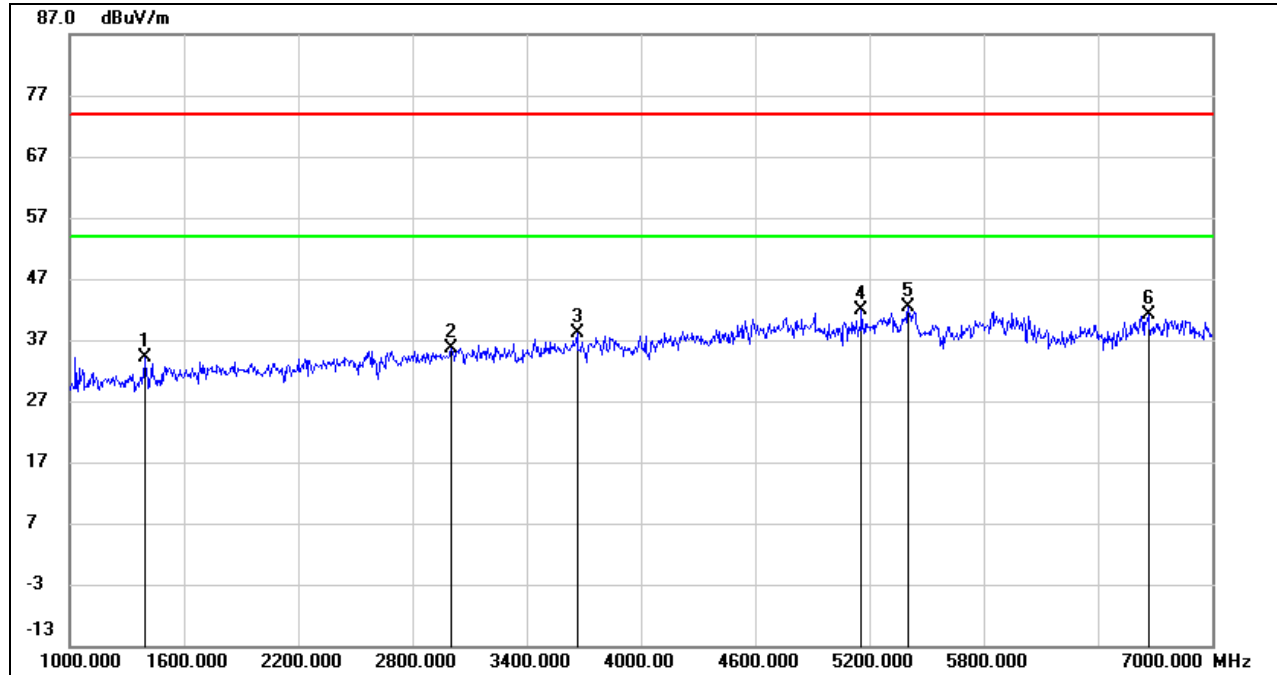

No.	Frequency (MHz)	Reading (dBuV)	Correct (dB/m)	Result (dBuV/m)	Limit (dBuV/m)	Margin (dB)	Remark
1	1396.000	46.74	-12.71	34.03	74.00	-39.97	peak
2	3004.000	41.23	-5.59	35.64	74.00	-38.36	peak
3	3664.000	42.08	-3.89	38.19	74.00	-35.81	peak
4	5158.000	39.91	1.85	41.76	74.00	-32.24	peak
5	5404.000	40.37	1.89	42.26	74.00	-31.74	peak
6	6664.000	35.59	5.53	41.12	74.00	-32.88	peak

Note: 1. Measurement = Reading Level + Correct Factor.

2. If Peak Result complies with AV limit, AV Result is deemed to comply with AV limit.

3. Peak: Peak detector.

4. AVG: $VBW=1/Ton$, where: Ton is the transmitting duration.

5. For the transmitting duration, please refer to clause 7.1.

6. Filter losses were only considered in the spurious frequency bands and the authorized band was not corrected for Band reject filter losses.

7. Proper operation of the transmitter prior to adding the filter to the measurement chain.

8. Since non-restricted band peak emissions are less than the average limit, they also comply with the -27dBm/MHz (68.2dBuV/m) limit.

HARMONICS AND SPURIOUS EMISSIONS (MID CHANNEL, HORIZONTAL)

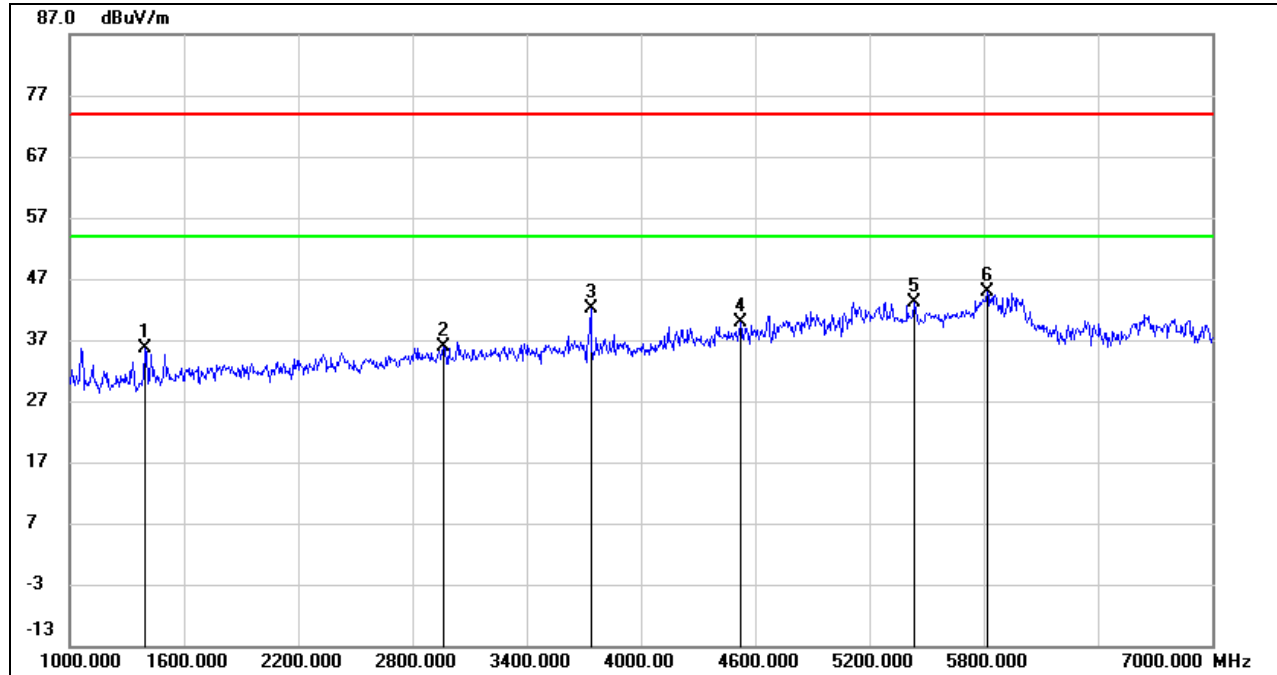

No.	Frequency (MHz)	Reading (dBuV)	Correct (dB/m)	Result (dBuV/m)	Limit (dBuV/m)	Margin (dB)	Remark
1	1396.000	48.41	-12.71	35.70	74.00	-38.30	peak
2	2962.000	41.72	-5.78	35.94	74.00	-38.06	peak
3	3736.000	45.57	-3.56	42.01	74.00	-31.99	peak
4	4522.000	41.01	-1.09	39.92	74.00	-34.08	peak
5	5434.000	41.23	1.97	43.20	74.00	-30.80	peak
6	5818.000	42.30	2.57	44.87	74.00	-29.13	peak

- Note:
1. Measurement = Reading Level + Correct Factor.
 2. If Peak Result complies with AV limit, AV Result is deemed to comply with AV limit.
 3. Peak: Peak detector.
 4. AVG: $VBW=1/Ton$, where: Ton is the transmitting duration.
 5. For the transmitting duration, please refer to clause 7.1.
 6. Filter losses were only considered in the spurious frequency bands and the authorized band was not corrected for Band reject filter losses.
 7. Proper operation of the transmitter prior to adding the filter to the measurement chain.
 8. Since non-restricted band peak emissions are less than the average limit, they also comply with the -27dBm/MHz (68.2dBuV/m) limit.

HARMONICS AND SPURIOUS EMISSIONS (MID CHANNEL, VERTICAL)

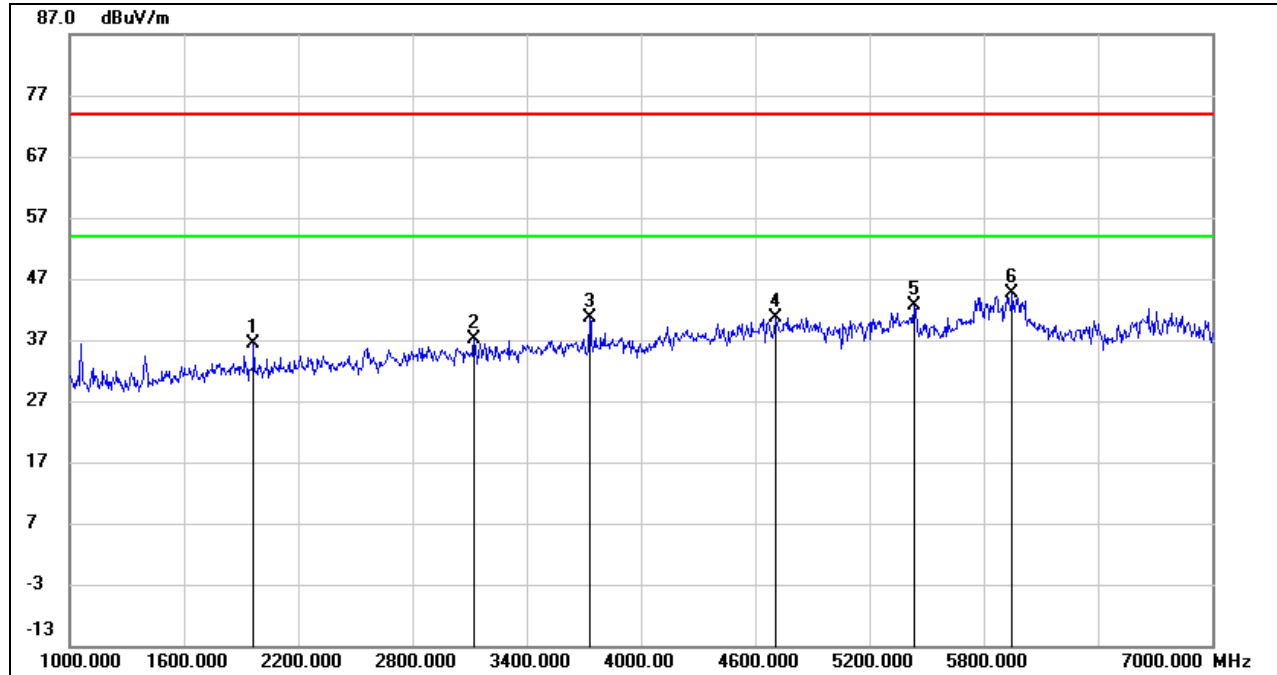

No.	Frequency (MHz)	Reading (dBuV)	Correct (dB/m)	Result (dBuV/m)	Limit (dBuV/m)	Margin (dB)	Remark
1	1966.000	46.47	-10.16	36.31	74.00	-37.69	peak
2	3124.000	42.40	-5.38	37.02	74.00	-36.98	peak
3	3730.000	44.20	-3.58	40.62	74.00	-33.38	peak
4	4708.000	40.61	0.06	40.67	74.00	-33.33	peak
5	5434.000	40.66	1.97	42.63	74.00	-31.37	peak
6	5950.000	41.51	3.10	44.61	74.00	-29.39	peak

Note: 1. Measurement = Reading Level + Correct Factor.

2. If Peak Result complies with AV limit, AV Result is deemed to comply with AV limit.

3. Peak: Peak detector.

4. AVG: $VBW=1/Ton$, where: Ton is the transmitting duration.

5. For the transmitting duration, please refer to clause 7.1.

6. Filter losses were only considered in the spurious frequency bands and the authorized band was not corrected for Band reject filter losses.

7. Proper operation of the transmitter prior to adding the filter to the measurement chain.

8. Since non-restricted band peak emissions are less than the average limit, they also comply with the -27dBm/MHz (68.2dBuV/m) limit.

HARMONICS AND SPURIOUS EMISSIONS (HIGH CHANNEL, HORIZONTAL)

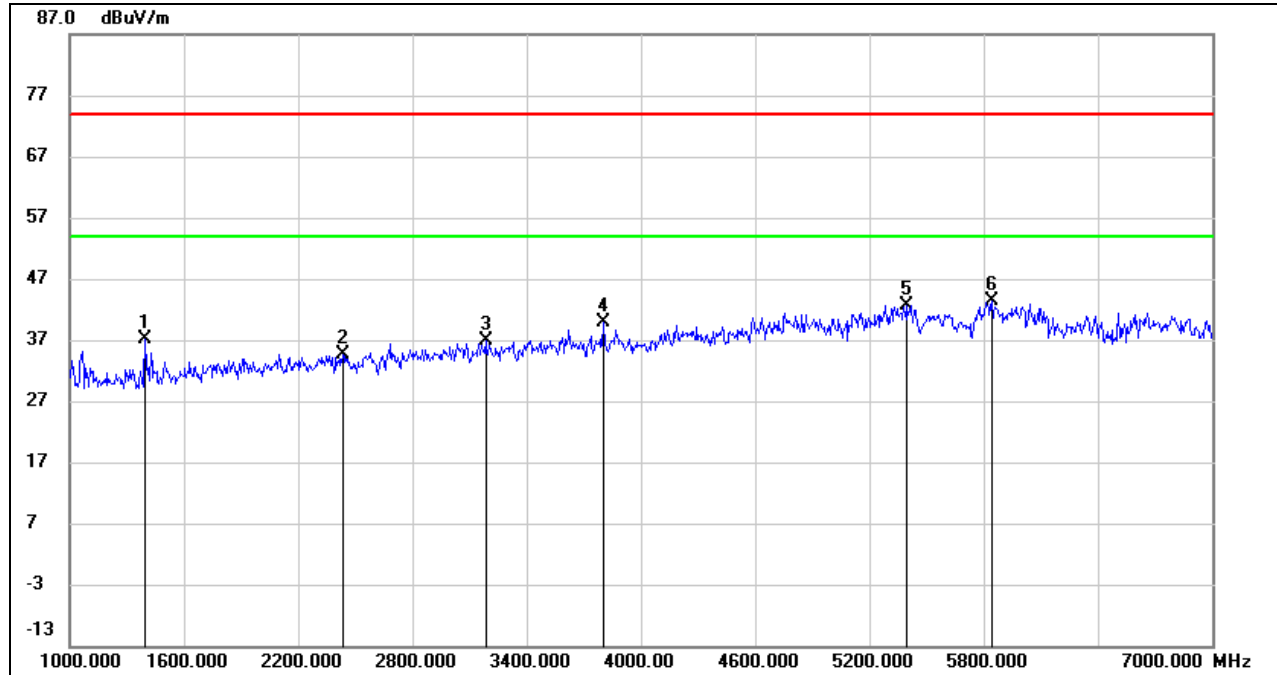

No.	Frequency (MHz)	Reading (dBuV)	Correct (dB/m)	Result (dBuV/m)	Limit (dBuV/m)	Margin (dB)	Remark
1	1396.000	49.79	-12.71	37.08	74.00	-36.92	peak
2	2434.000	43.02	-8.33	34.69	74.00	-39.31	peak
3	3184.000	42.13	-5.28	36.85	74.00	-37.15	peak
4	3802.000	43.26	-3.27	39.99	74.00	-34.01	peak
5	5398.000	40.86	1.88	42.74	74.00	-31.26	peak
6	5842.000	40.59	2.67	43.26	74.00	-30.74	peak

- Note:
1. Measurement = Reading Level + Correct Factor.
 2. If Peak Result complies with AV limit, AV Result is deemed to comply with AV limit.
 3. Peak: Peak detector.
 4. AVG: $VBW=1/Ton$, where: Ton is the transmitting duration.
 5. For the transmitting duration, please refer to clause 7.1.
 6. Filter losses were only considered in the spurious frequency bands and the authorized band was not corrected for Band reject filter losses.
 7. Proper operation of the transmitter prior to adding the filter to the measurement chain.
 8. Since non-restricted band peak emissions are less than the average limit, they also comply with the -27dBm/MHz (68.2dBuV/m) limit.

HARMONICS AND SPURIOUS EMISSIONS (HIGH CHANNEL, VERTICAL)

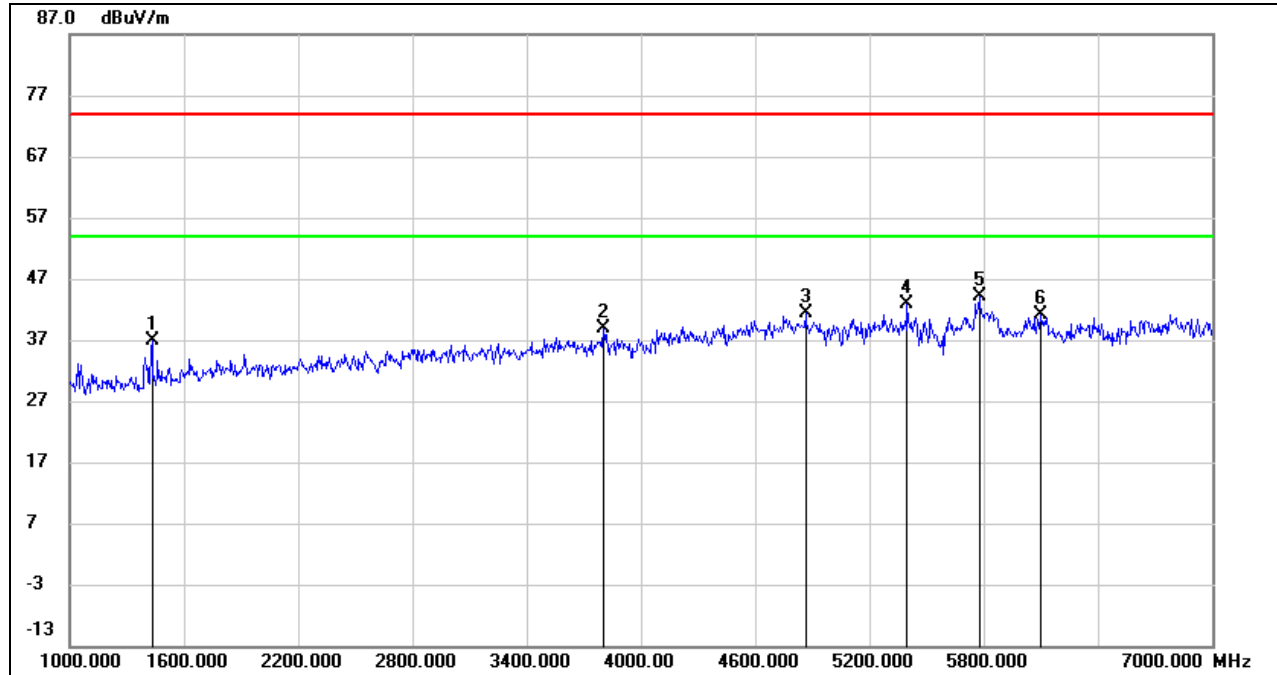

No.	Frequency (MHz)	Reading (dBuV)	Correct (dB/m)	Result (dBuV/m)	Limit (dBuV/m)	Margin (dB)	Remark
1	1432.000	49.39	-12.55	36.84	74.00	-37.16	peak
2	3802.000	42.09	-3.27	38.82	74.00	-35.18	peak
3	4864.000	40.68	0.69	41.37	74.00	-32.63	peak
4	5398.000	41.04	1.88	42.92	74.00	-31.08	peak
5	5776.000	41.61	2.50	44.11	74.00	-29.89	peak
6	6100.000	37.79	3.28	41.07	74.00	-32.93	peak

- Note:
1. Measurement = Reading Level + Correct Factor.
 2. If Peak Result complies with AV limit, AV Result is deemed to comply with AV limit.
 3. Peak: Peak detector.
 4. AVG: $VBW=1/Ton$, where: Ton is the transmitting duration.
 5. For the transmitting duration, please refer to clause 7.1.
 6. Filter losses were only considered in the spurious frequency bands and the authorized band was not corrected for Band reject filter losses.
 7. Proper operation of the transmitter prior to adding the filter to the measurement chain.
 8. Since non-restricted band peak emissions are less than the average limit, they also comply with the -27dBm/MHz (68.2dBuV/m) limit.

UNII-3 BAND

TEST RESULTS (WORST CASE)

HARMONICS AND SPURIOUS EMISSIONS (LOW CHANNEL, HORIZONTAL)

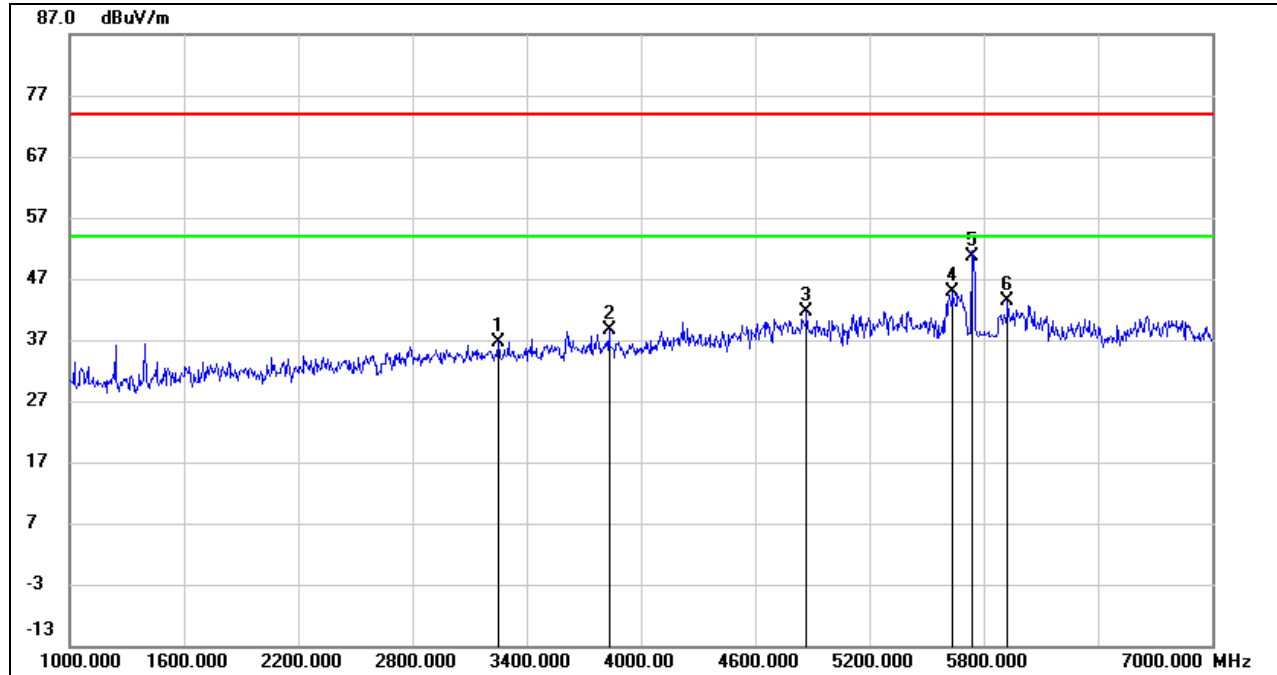

No.	Frequency (MHz)	Reading (dBuV)	Correct (dB/m)	Result (dBuV/m)	Limit (dBuV/m)	Margin (dB)	Remark
1	3250.000	41.84	-5.22	36.62	74.00	-37.38	peak
2	3832.000	41.95	-3.32	38.63	74.00	-35.37	peak
3	4870.000	40.87	0.69	41.56	74.00	-32.44	peak
4	5638.000	42.50	2.47	44.97	74.00	-29.03	peak
5	5745.000	48.21	2.49	50.70	74.00	-23.30	peak
6	5926.000	40.45	3.01	43.46	74.00	-30.54	peak

Note: 1. Measurement = Reading Level + Correct Factor.
 2. If Peak Result complies with AV limit, AV Result is deemed to comply with AV limit.
 3. Peak: Peak detector.
 4. AVG: $VBW=1/Ton$, where: Ton is the transmitting duration.
 5. For the transmitting duration, please refer to clause 7.1.
 6. Filter losses were only considered in the spurious frequency bands and the authorized band was not corrected for Band reject filter losses.
 7. Proper operation of the transmitter prior to adding the filter to the measurement chain.
 8. Since non-restricted band peak emissions are less than the average limit, they also comply with the -27dBm/MHz (68.2dBuV/m) limit.

HARMONICS AND SPURIOUS EMISSIONS (LOW CHANNEL, VERTICAL)

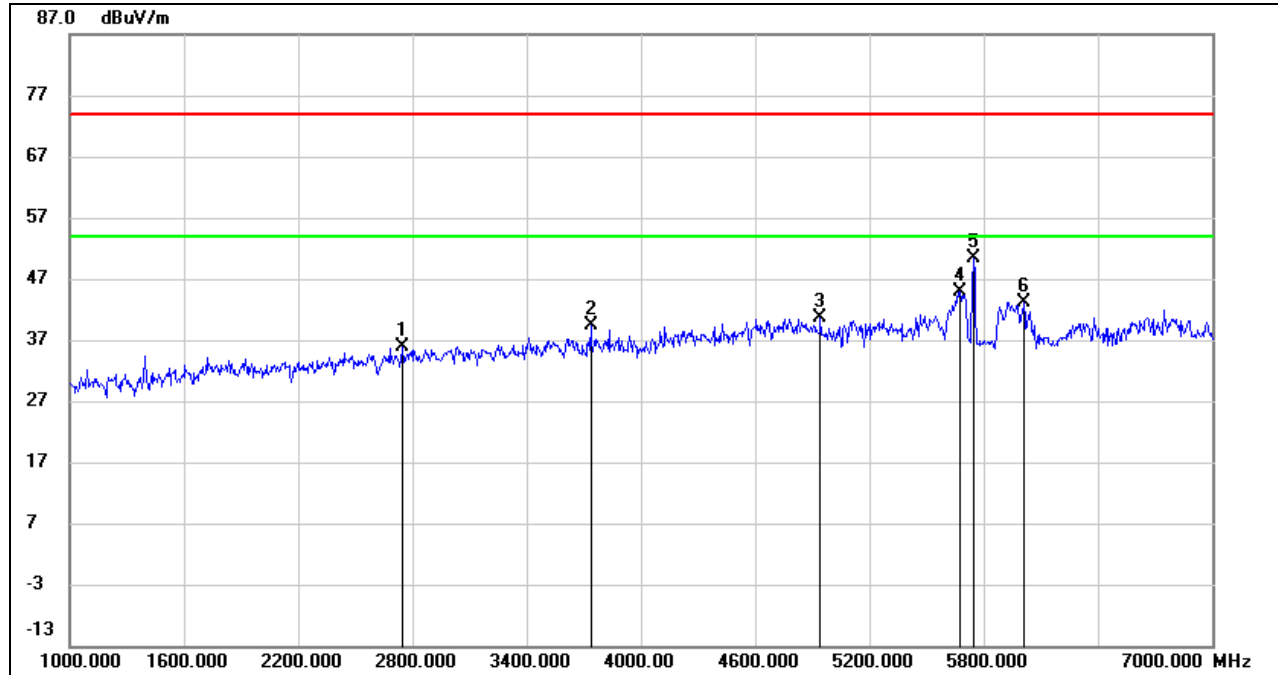

No.	Frequency (MHz)	Reading (dBuV)	Correct (dB/m)	Result (dBuV/m)	Limit (dBuV/m)	Margin (dB)	Remark
1	2746.000	42.76	-6.90	35.86	74.00	-38.14	peak
2	3736.000	42.94	-3.56	39.38	74.00	-34.62	peak
3	4942.000	39.73	0.81	40.54	74.00	-33.46	peak
4	5674.000	42.50	2.48	44.98	74.00	-29.02	peak
5	5745.000	47.91	2.49	50.40	74.00	-23.60	peak
6	6010.000	39.76	3.31	43.07	74.00	-30.93	peak

- Note: 1. Measurement = Reading Level + Correct Factor.
 2. If Peak Result complies with AV limit, AV Result is deemed to comply with AV limit.
 3. Peak: Peak detector.
 4. AVG: $VBW=1/Ton$, where: Ton is the transmitting duration.
 5. For the transmitting duration, please refer to clause 7.1.
 6. Filter losses were only considered in the spurious frequency bands and the authorized band was not corrected for Band reject filter losses.
 7. Proper operation of the transmitter prior to adding the filter to the measurement chain.
 8. Since non-restricted band peak emissions are less than the average limit, they also comply with the -27dBm/MHz (68.2dBuV/m) limit.

HARMONICS AND SPURIOUS EMISSIONS (MID CHANNEL, HORIZONTAL)

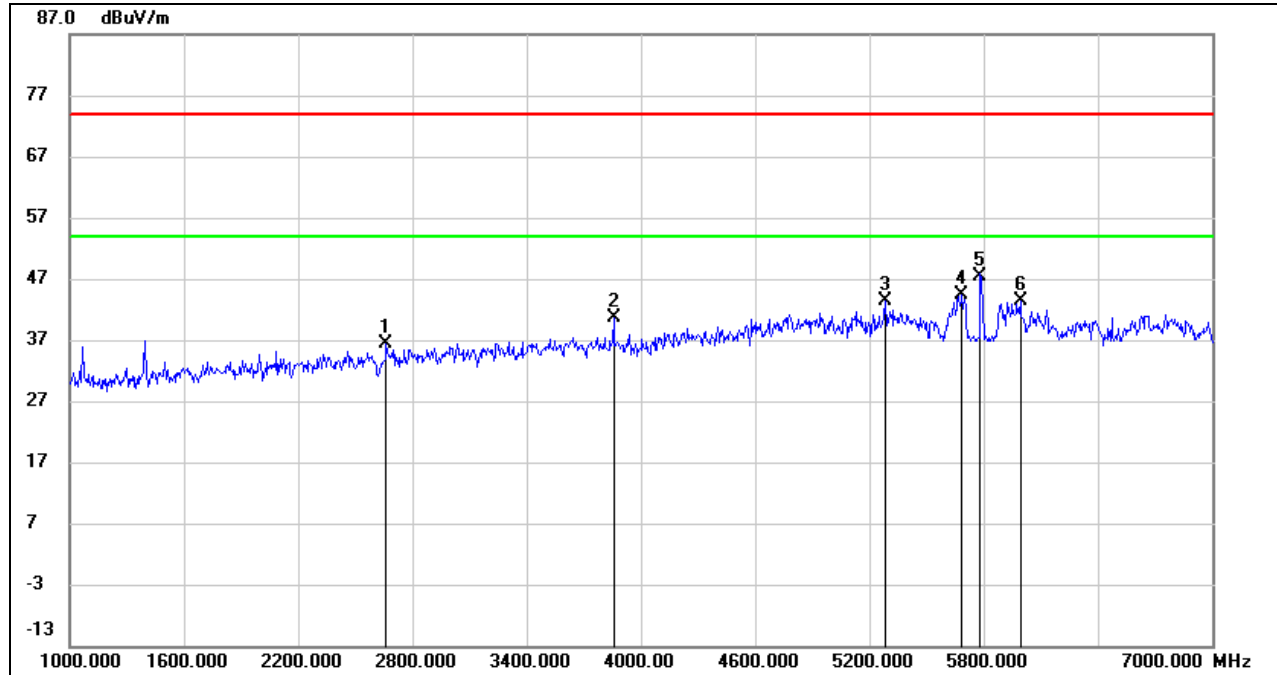

No.	Frequency (MHz)	Reading (dBuV)	Correct (dB/m)	Result (dBuV/m)	Limit (dBuV/m)	Margin (dB)	Remark
1	2662.000	43.79	-7.46	36.33	74.00	-37.67	peak
2	3856.000	44.08	-3.36	40.72	74.00	-33.28	peak
3	5284.000	41.30	2.01	43.31	74.00	-30.69	peak
4	5686.000	41.98	2.47	44.45	74.00	-29.55	peak
5	5785.000	44.91	2.50	47.41	74.00	-26.59	peak
6	5992.000	40.10	3.27	43.37	74.00	-30.63	peak

- Note:
1. Measurement = Reading Level + Correct Factor.
 2. If Peak Result complies with AV limit, AV Result is deemed to comply with AV limit.
 3. Peak: Peak detector.
 4. AVG: $VBW=1/Ton$, where: Ton is the transmitting duration.
 5. For the transmitting duration, please refer to clause 7.1.
 6. Filter losses were only considered in the spurious frequency bands and the authorized band was not corrected for Band reject filter losses.
 7. Proper operation of the transmitter prior to adding the filter to the measurement chain.
 8. Since non-restricted band peak emissions are less than the average limit, they also comply with the -27dBm/MHz (68.2dBuV/m) limit.

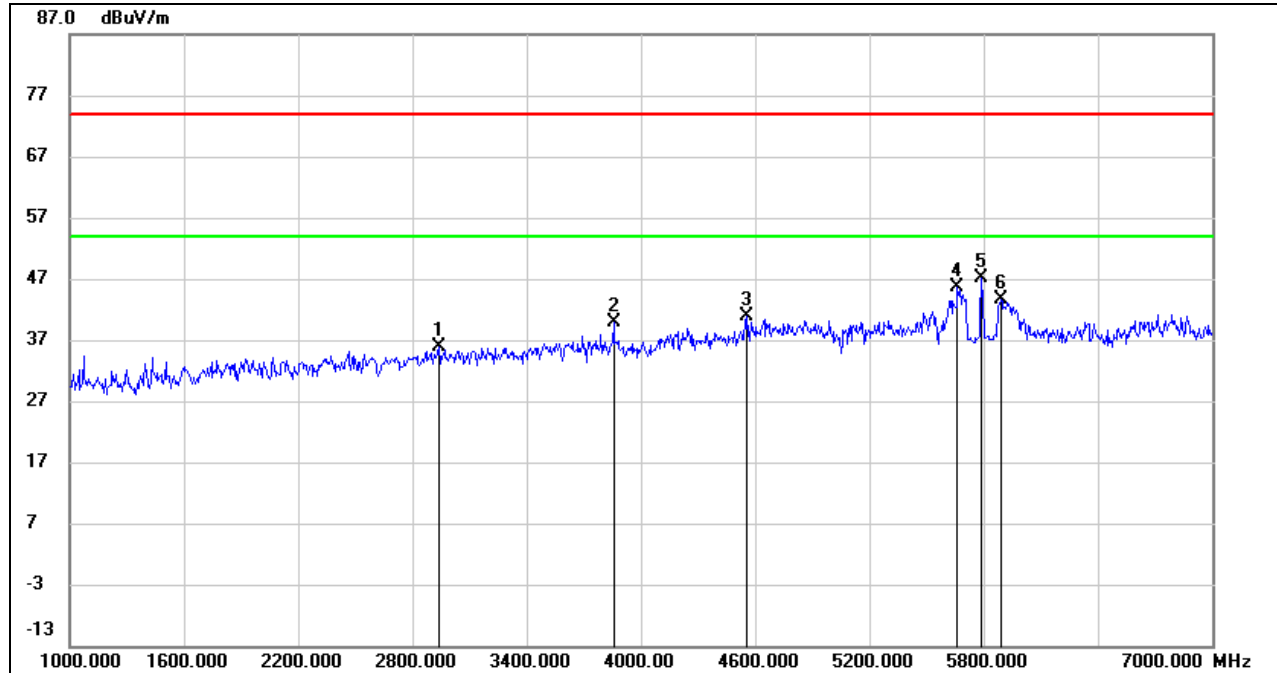
**HARMONICS AND SPURIOUS EMISSIONS (MID CHANNEL, VERTICAL)**

No.	Frequency (MHz)	Reading (dBuV)	Correct (dB/m)	Result (dBuV/m)	Limit (dBuV/m)	Margin (dB)	Remark
1	2938.000	41.73	-5.89	35.84	74.00	-38.16	peak
2	3856.000	43.30	-3.36	39.94	74.00	-34.06	peak
3	4558.000	41.65	-0.84	40.81	74.00	-33.19	peak
4	5662.000	43.19	2.47	45.66	74.00	-28.34	peak
5	5785.000	44.53	2.50	47.03	74.00	-26.97	peak
6	5890.000	40.77	2.87	43.64	74.00	-30.36	peak

Note: 1. Measurement = Reading Level + Correct Factor.

2. If Peak Result complies with AV limit, AV Result is deemed to comply with AV limit.

3. Peak: Peak detector.

4. AVG: $VBW=1/Ton$, where: Ton is the transmitting duration.

5. For the transmitting duration, please refer to clause 7.1.

6. Filter losses were only considered in the spurious frequency bands and the authorized band was not corrected for Band reject filter losses.

7. Proper operation of the transmitter prior to adding the filter to the measurement chain.

8. Since non-restricted band peak emissions are less than the average limit, they also comply with the -27dBm/MHz (68.2dBuV/m) limit.

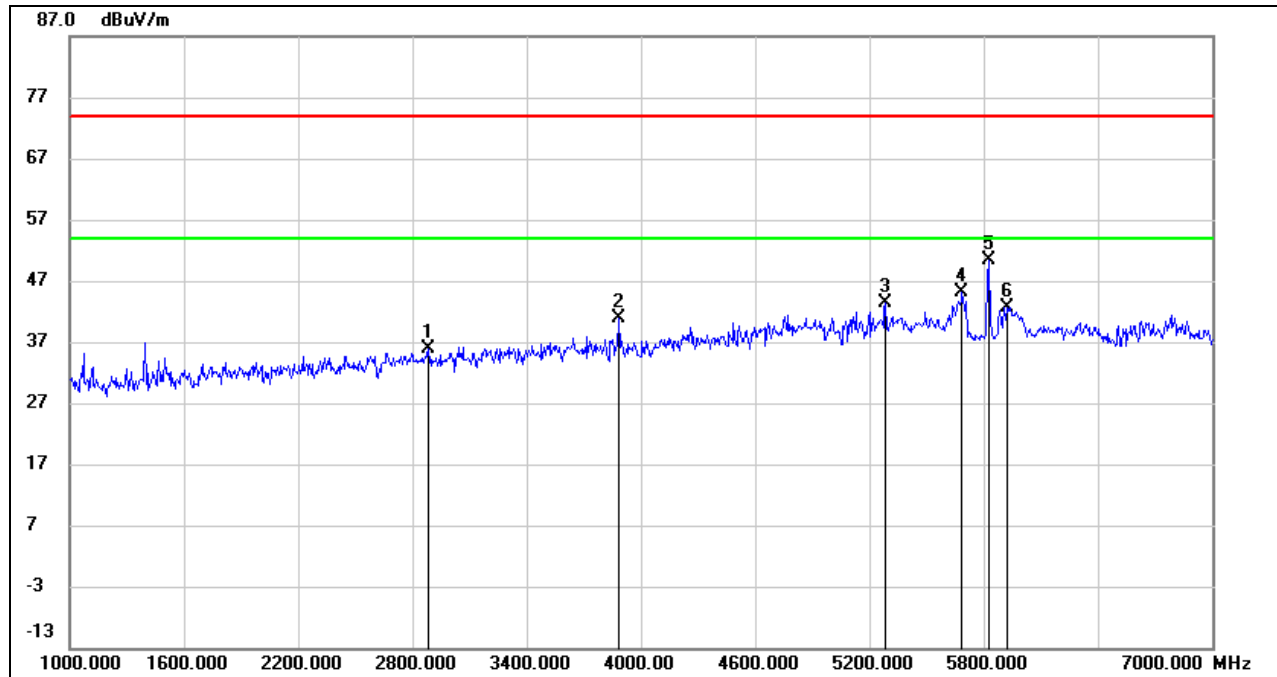
**HARMONICS AND SPURIOUS EMISSIONS (HIGH CHANNEL, HORIZONTAL)**

No.	Frequency (MHz)	Reading (dBuV)	Correct (dB/m)	Result (dBuV/m)	Limit (dBuV/m)	Margin (dB)	Remark
1	2884.000	41.96	-6.15	35.81	74.00	-38.19	peak
2	3886.000	44.39	-3.41	40.98	74.00	-33.02	peak
3	5284.000	41.43	2.01	43.44	74.00	-30.56	peak
4	5686.000	42.58	2.47	45.05	74.00	-28.95	peak
5	5825.000	47.74	2.61	50.35	74.00	-23.65	peak
6	5920.000	39.75	2.98	42.73	74.00	-31.27	peak

- Note:
1. Measurement = Reading Level + Correct Factor.
 2. If Peak Result complies with AV limit, AV Result is deemed to comply with AV limit.
 3. Peak: Peak detector.
 4. AVG: $VBW=1/Ton$, where: Ton is the transmitting duration.
 5. For the transmitting duration, please refer to clause 7.1.
 6. Filter losses were only considered in the spurious frequency bands and the authorized band was not corrected for Band reject filter losses.
 7. Proper operation of the transmitter prior to adding the filter to the measurement chain.
 8. Since non-restricted band peak emissions are less than the average limit, they also comply with the -27dBm/MHz (68.2dBuV/m) limit.

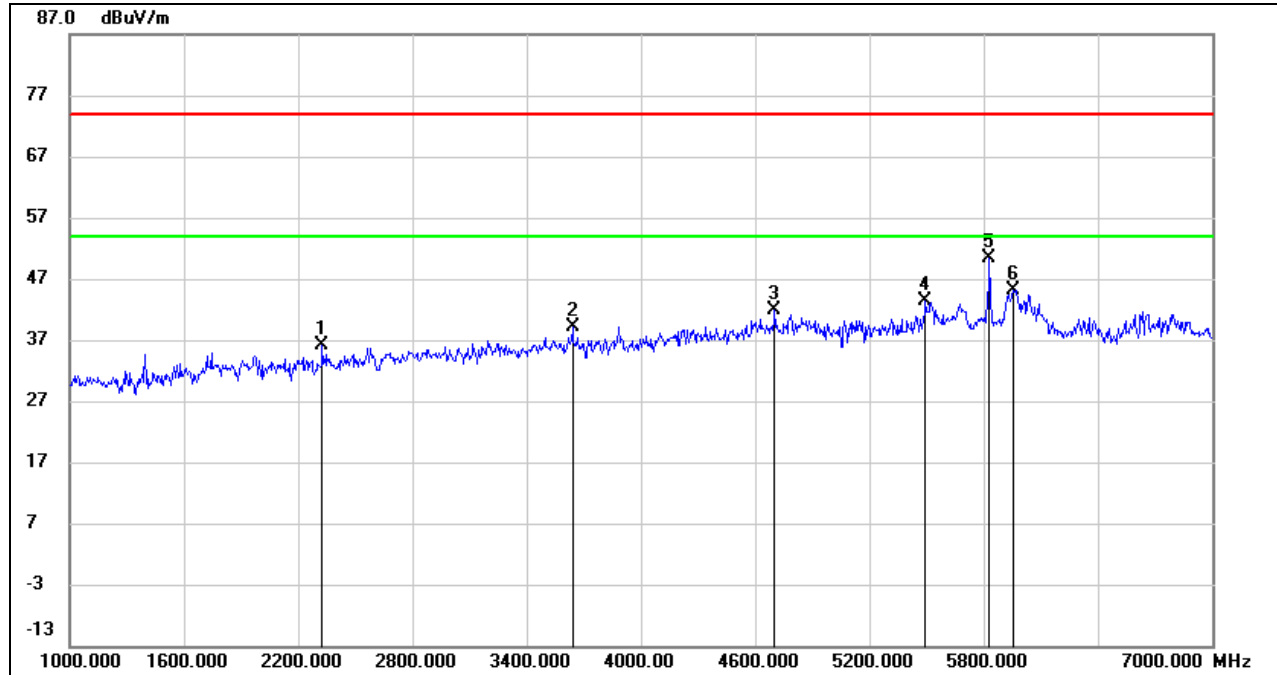
**HARMONICS AND SPURIOUS EMISSIONS (HIGH CHANNEL, VERTICAL)**

No.	Frequency (MHz)	Reading (dBuV)	Correct (dB/m)	Result (dBuV/m)	Limit (dBuV/m)	Margin (dB)	Remark
1	2326.000	44.82	-8.64	36.18	74.00	-37.82	peak
2	3640.000	43.11	-4.00	39.11	74.00	-34.89	peak
3	4702.000	41.87	0.01	41.88	74.00	-32.12	peak
4	5494.000	41.12	2.14	43.26	74.00	-30.74	peak
5	5825.000	47.80	2.61	50.41	74.00	-23.59	peak
6	5956.000	42.07	3.13	45.20	74.00	-28.80	peak

Note: 1. Measurement = Reading Level + Correct Factor.

2. If Peak Result complies with AV limit, AV Result is deemed to comply with AV limit.

3. Peak: Peak detector.

4. AVG: $VBW=1/Ton$, where: Ton is the transmitting duration.

5. For the transmitting duration, please refer to clause 7.1.

6. Filter losses were only considered in the spurious frequency bands and the authorized band was not corrected for Band reject filter losses.

7. Proper operation of the transmitter prior to adding the filter to the measurement chain.

8. Since non-restricted band peak emissions are less than the average limit, they also comply with the -27dBm/MHz (68.2dBuV/m) limit.



8.3. SPURIOUS EMISSIONS (7 GHz ~ 18 GHz)

8.3.1. 802.11a CDD 4TX MODE

UNII-1 BAND

HARMONICS AND SPURIOUS EMISSIONS (LOW CHANNEL, HORIZONTAL)

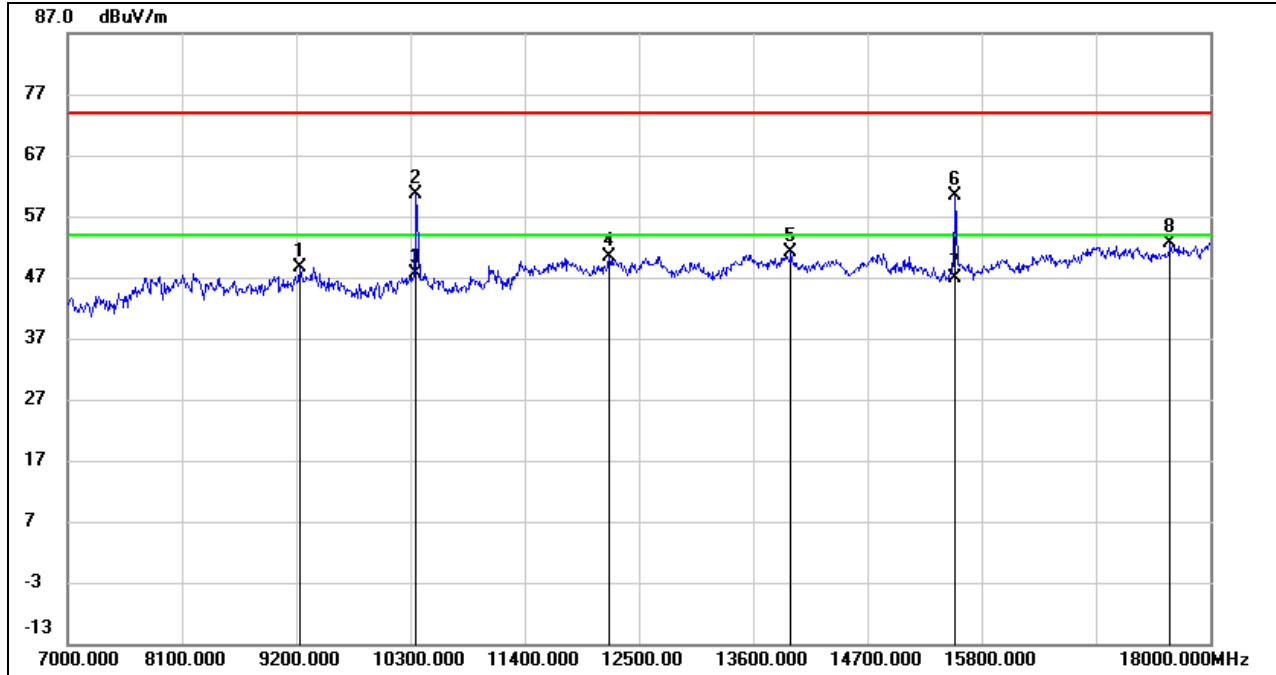

No.	Frequency (MHz)	Reading (dBuV)	Correct (dB/m)	Result (dBuV/m)	Limit (dBuV/m)	Margin (dB)	Remark
1	9233.000	38.57	10.08	48.65	74.00	-25.35	peak
2	10355.000	48.59	12.04	60.63	68.2	-7.57	peak
3	10355.000	35.66	12.04	47.70	/	/	AVG
4	12214.000	34.53	15.97	50.50	74.00	-23.50	peak
5	13963.000	33.42	17.61	51.03	74.00	-22.97	peak
6	15547.000	42.94	17.36	60.30	74.00	-13.70	peak
7	15547.000	29.60	17.36	46.96	54.00	-7.04	AVG
8	17615.000	29.68	22.84	52.52	74.00	-21.48	peak

- Note:
1. Measurement = Reading Level + Correct Factor.
 2. If Peak Result complies with AV limit, AV Result is deemed to comply with AV limit.
 3. Peak: Peak detector.
 4. AVG: VBW=1/Ton, where: Ton is the transmitting duration.
 5. For the transmitting duration, please refer to clause 7.1.
 6. Filter losses were only considered in the spurious frequency bands and the authorized band was not corrected for High Pass Filter losses.
 7. Proper operation of the transmitter prior to adding the filter to the measurement chain.
 8. Since non-restricted band peak emissions are less than the average limit, they also comply with the -27dBm/MHz (68.2dBuV/m) limit.

HARMONICS AND SPURIOUS EMISSIONS (LOW CHANNEL, VERTICAL)

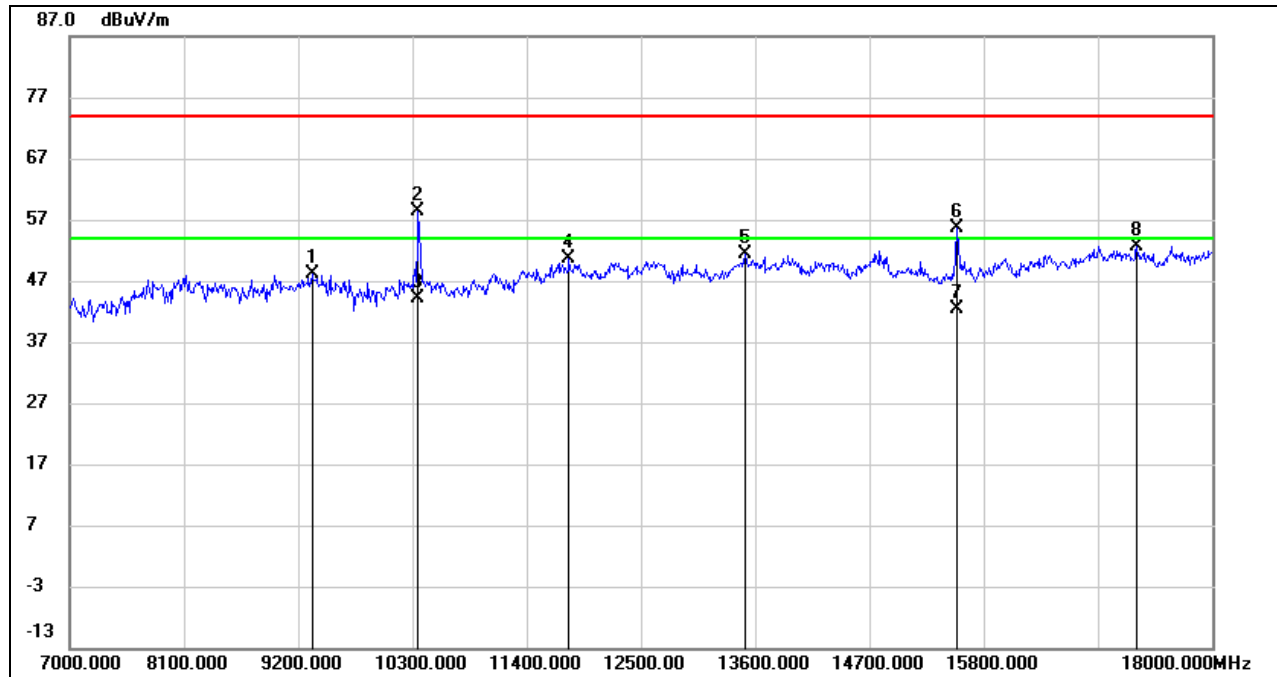

No.	Frequency (MHz)	Reading (dBuV)	Correct (dB/m)	Result (dBuV/m)	Limit (dBuV/m)	Margin (dB)	Remark
1	9332.000	37.46	10.59	48.05	74.00	-25.95	peak
2	10355.000	46.44	12.04	58.48	68.2	-9.72	peak
3	10355.000	32.11	12.04	44.15	/	/	AVG
4	11807.000	35.37	15.27	50.64	74.00	-23.36	peak
5	13501.000	34.20	17.22	51.42	74.00	-22.58	peak
6	15536.000	38.29	17.28	55.57	74.00	-18.43	peak
7	15536.000	25.02	17.28	42.30	54.00	-11.70	AVG
8	17274.000	30.28	22.45	52.73	74.00	-21.27	peak

Note: 1. Measurement = Reading Level + Correct Factor.

2. If Peak Result complies with AV limit, AV Result is deemed to comply with AV limit.

3. Peak: Peak detector.

4. AVG: $VBW=1/T_{on}$, where: T_{on} is the transmitting duration.

5. For the transmitting duration, please refer to clause 7.1.

6. Filter losses were only considered in the spurious frequency bands and the authorized band was not corrected for High Pass Filter losses.

7. Proper operation of the transmitter prior to adding the filter to the measurement chain.

8. Since non-restricted band peak emissions are less than the average limit, they also comply with the -27dBm/MHz (68.2dBuV/m) limit.

HARMONICS AND SPURIOUS EMISSIONS (MID CHANNEL, HORIZONTAL)

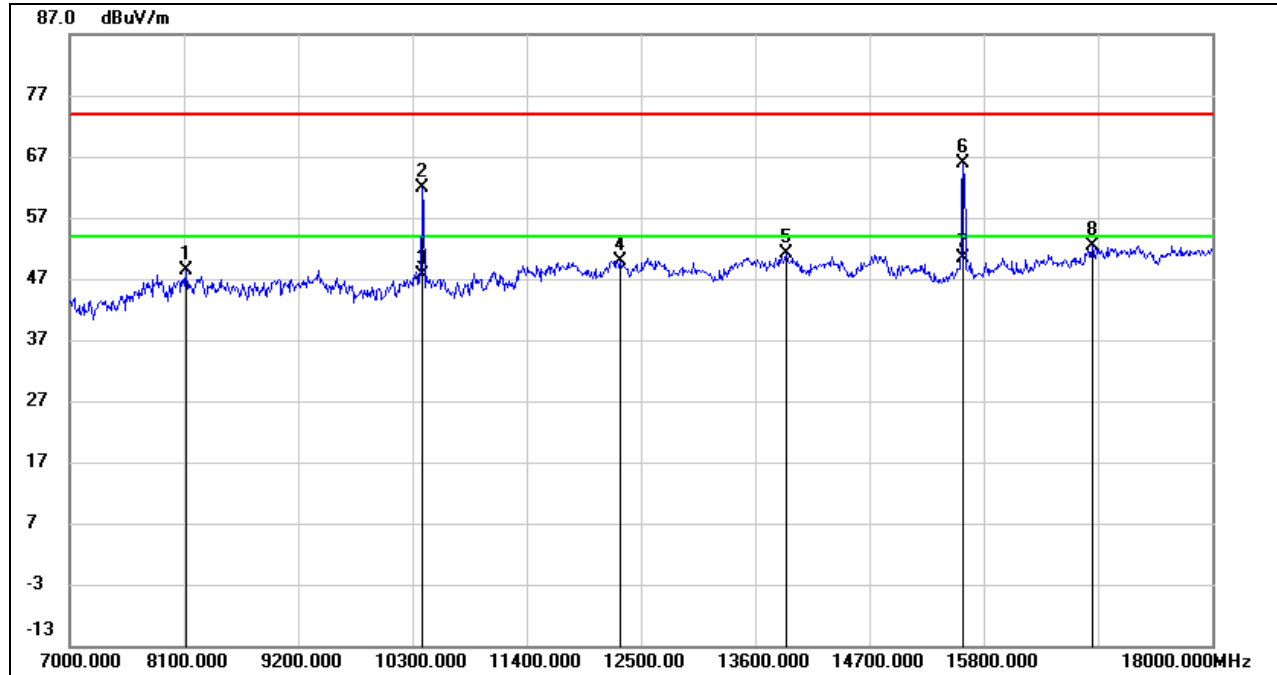

No.	Frequency (MHz)	Reading (dBuV)	Correct (dB/m)	Result (dBuV/m)	Limit (dBuV/m)	Margin (dB)	Remark
1	8122.000	38.39	10.10	48.49	74.00	-25.51	peak
2	10399.000	49.60	12.23	61.83	68.2	-6.37	peak
3	10399.000	35.43	12.23	47.66	/	/	AVG
4	12302.000	33.83	16.09	49.92	74.00	-24.08	peak
5	13897.000	33.56	17.52	51.08	74.00	-22.92	peak
6	15602.000	48.11	17.70	65.81	74.00	-8.19	peak
7	15602.000	32.56	17.70	50.26	54.00	-3.74	AVG
8	16845.000	31.30	21.10	52.40	74.00	-21.60	peak

- Note:
1. Measurement = Reading Level + Correct Factor.
 2. If Peak Result complies with AV limit, AV Result is deemed to comply with AV limit.
 3. Peak: Peak detector.
 4. AVG: $VBW=1/Ton$, where: Ton is the transmitting duration.
 5. For the transmitting duration, please refer to clause 7.1.
 6. Filter losses were only considered in the spurious frequency bands and the authorized band was not corrected for High Pass Filter losses.
 7. Proper operation of the transmitter prior to adding the filter to the measurement chain.
 8. Since non-restricted band peak emissions are less than the average limit, they also comply with the -27dBm/MHz (68.2dBuV/m) limit.

HARMONICS AND SPURIOUS EMISSIONS (MID CHANNEL, VERTICAL)

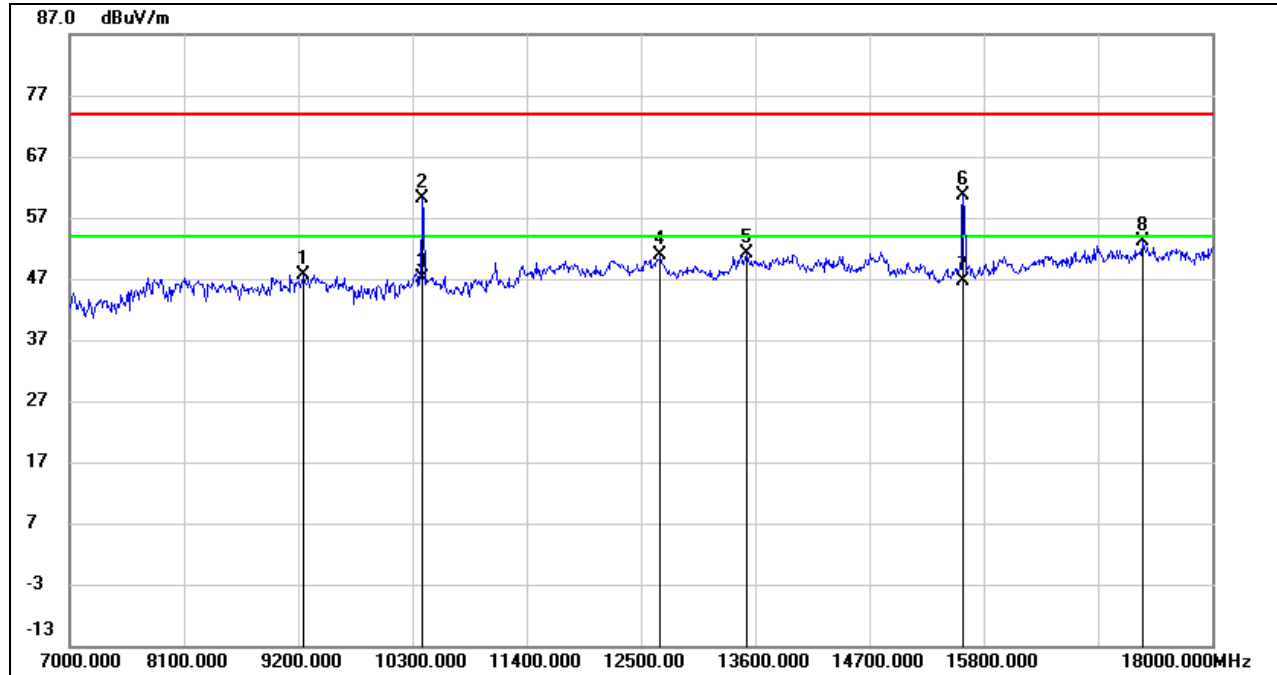

No.	Frequency (MHz)	Reading (dBuV)	Correct (dB/m)	Result (dBuV/m)	Limit (dBuV/m)	Margin (dB)	Remark
1	9255.000	37.50	10.17	47.67	74.00	-26.33	peak
2	10399.000	47.85	12.23	60.08	68.2	-8.12	peak
3	10399.000	34.80	12.23	47.03	/	/	AVG
4	12687.000	35.31	15.64	50.95	74.00	-23.05	peak
5	13512.000	33.84	17.20	51.04	74.00	-22.96	peak
6	15602.000	42.81	17.70	60.51	74.00	-13.49	peak
7	15602.000	28.89	17.70	46.59	54.00	-7.41	AVG
8	17329.000	30.80	22.39	53.19	74.00	-20.81	peak

- Note:
1. Measurement = Reading Level + Correct Factor.
 2. If Peak Result complies with AV limit, AV Result is deemed to comply with AV limit.
 3. Peak: Peak detector.
 4. AVG: VBW=1/Ton, where: Ton is the transmitting duration.
 5. For the transmitting duration, please refer to clause 7.1.
 6. Filter losses were only considered in the spurious frequency bands and the authorized band was not corrected for High Pass Filter losses.
 7. Proper operation of the transmitter prior to adding the filter to the measurement chain.
 8. Since non-restricted band peak emissions are less than the average limit, they also comply with the -27dBm/MHz (68.2dBuV/m) limit.

HARMONICS AND SPURIOUS EMISSIONS (HIGH CHANNEL, HORIZONTAL)

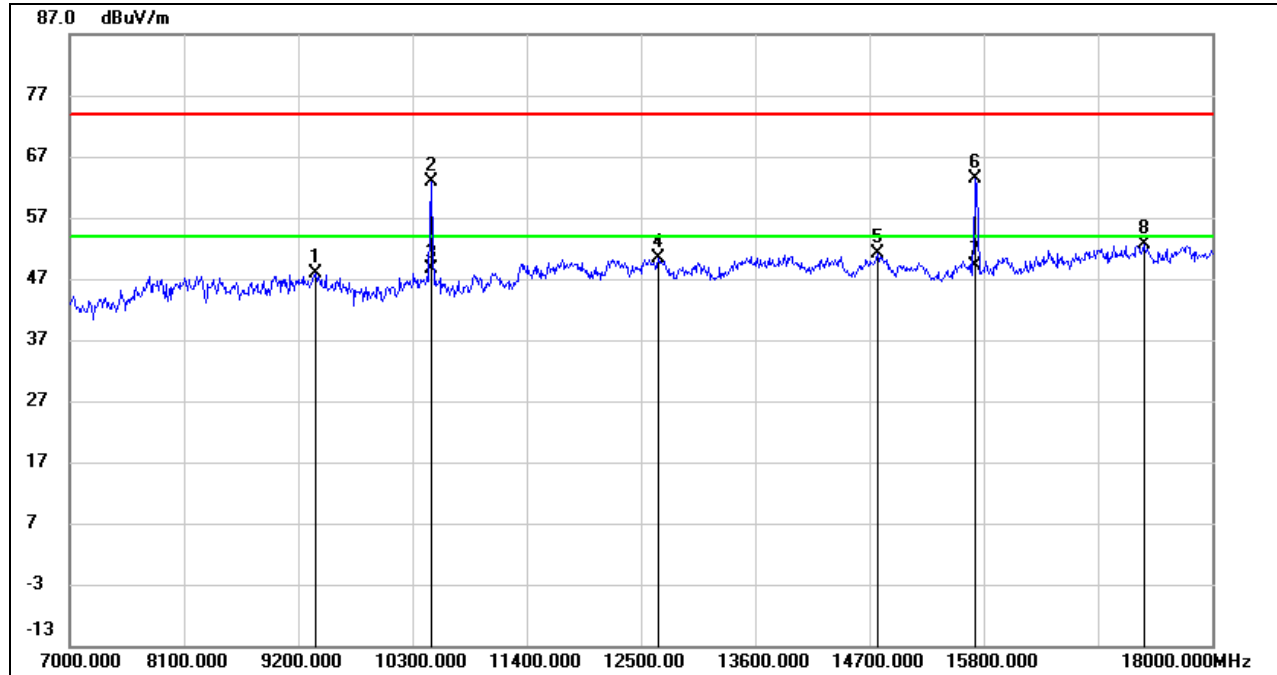

No.	Frequency (MHz)	Reading (dBuV)	Correct (dB/m)	Result (dBuV/m)	Limit (dBuV/m)	Margin (dB)	Remark
1	9365.000	37.18	10.77	47.95	74.00	-26.05	peak
2	10476.000	50.59	12.33	62.92	68.2	-5.28	peak
3	10476.000	36.36	12.33	48.69	/	/	AVG
4	12665.000	34.77	15.68	50.45	74.00	-23.55	peak
5	14777.000	33.27	17.96	51.23	74.00	-22.77	peak
6	15723.000	45.44	17.86	63.30	74.00	-10.70	peak
7	15723.000	31.17	17.86	49.03	54.00	-4.97	AVG
8	17340.000	30.26	22.31	52.57	74.00	-21.43	peak

- Note:
1. Measurement = Reading Level + Correct Factor.
 2. If Peak Result complies with AV limit, AV Result is deemed to comply with AV limit.
 3. Peak: Peak detector.
 4. AVG: VBW=1/Ton, where: Ton is the transmitting duration.
 5. For the transmitting duration, please refer to clause 7.1.
 6. Filter losses were only considered in the spurious frequency bands and the authorized band was not corrected for High Pass Filter losses.
 7. Proper operation of the transmitter prior to adding the filter to the measurement chain.
 8. Since non-restricted band peak emissions are less than the average limit, they also comply with the -27dBm/MHz (68.2dBuV/m) limit.

HARMONICS AND SPURIOUS EMISSIONS (HIGH CHANNEL, VERTICAL)

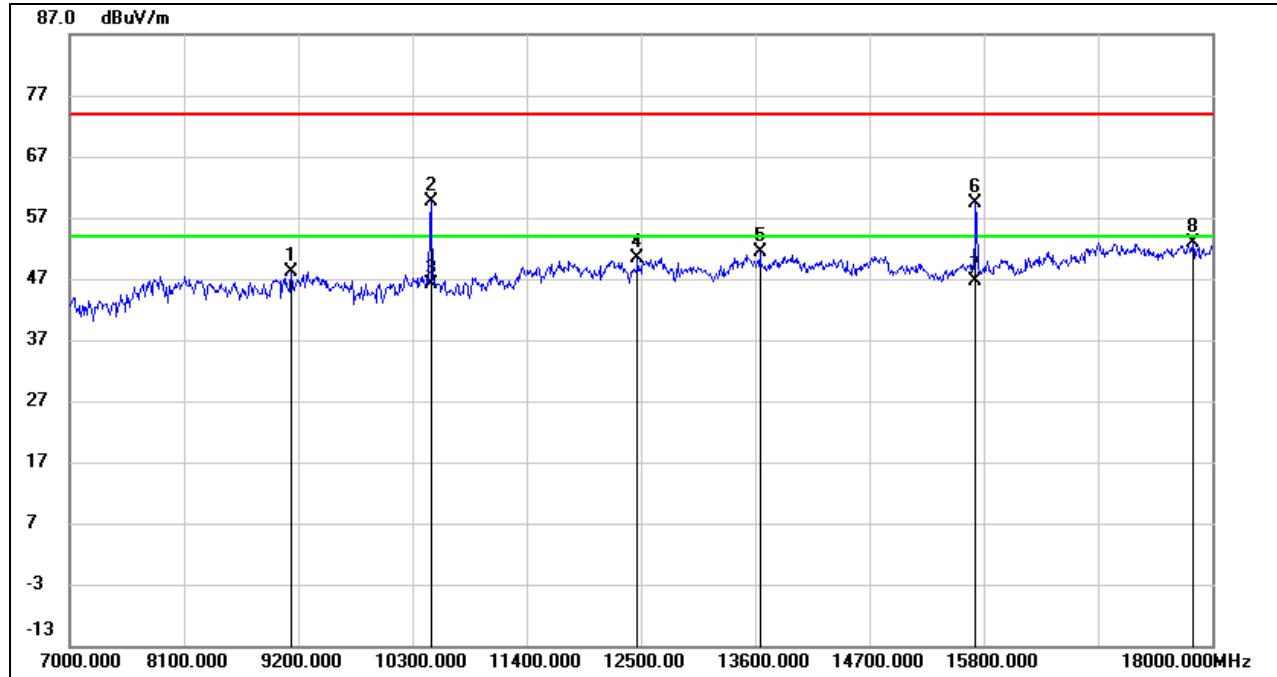

No.	Frequency (MHz)	Reading (dBuV)	Correct (dB/m)	Result (dBuV/m)	Limit (dBuV/m)	Margin (dB)	Remark
1	9134.000	38.13	10.06	48.19	74.00	-25.81	peak
2	10476.000	47.33	12.33	59.66	68.2	-8.54	peak
3	10476.000	33.83	12.33	46.16	/	/	AVG
4	12467.000	34.70	15.76	50.46	74.00	-23.54	peak
5	13644.000	34.04	17.33	51.37	74.00	-22.63	peak
6	15723.000	41.52	17.86	59.38	74.00	-14.62	peak
7	15723.000	28.80	17.86	46.66	54.00	-7.34	AVG
8	17813.000	28.88	24.03	52.91	74.00	-21.09	peak

- Note:
1. Measurement = Reading Level + Correct Factor.
 2. If Peak Result complies with AV limit, AV Result is deemed to comply with AV limit.
 3. Peak: Peak detector.
 4. AVG: VBW=1/Ton, where: Ton is the transmitting duration.
 5. For the transmitting duration, please refer to clause 7.1.
 6. Filter losses were only considered in the spurious frequency bands and the authorized band was not corrected for High Pass Filter losses.
 7. Proper operation of the transmitter prior to adding the filter to the measurement chain.
 8. Since non-restricted band peak emissions are less than the average limit, they also comply with the -27dBm/MHz (68.2dBuV/m) limit.

UNII-2A BAND

HARMONICS AND SPURIOUS EMISSIONS (LOW CHANNEL, HORIZONTAL)

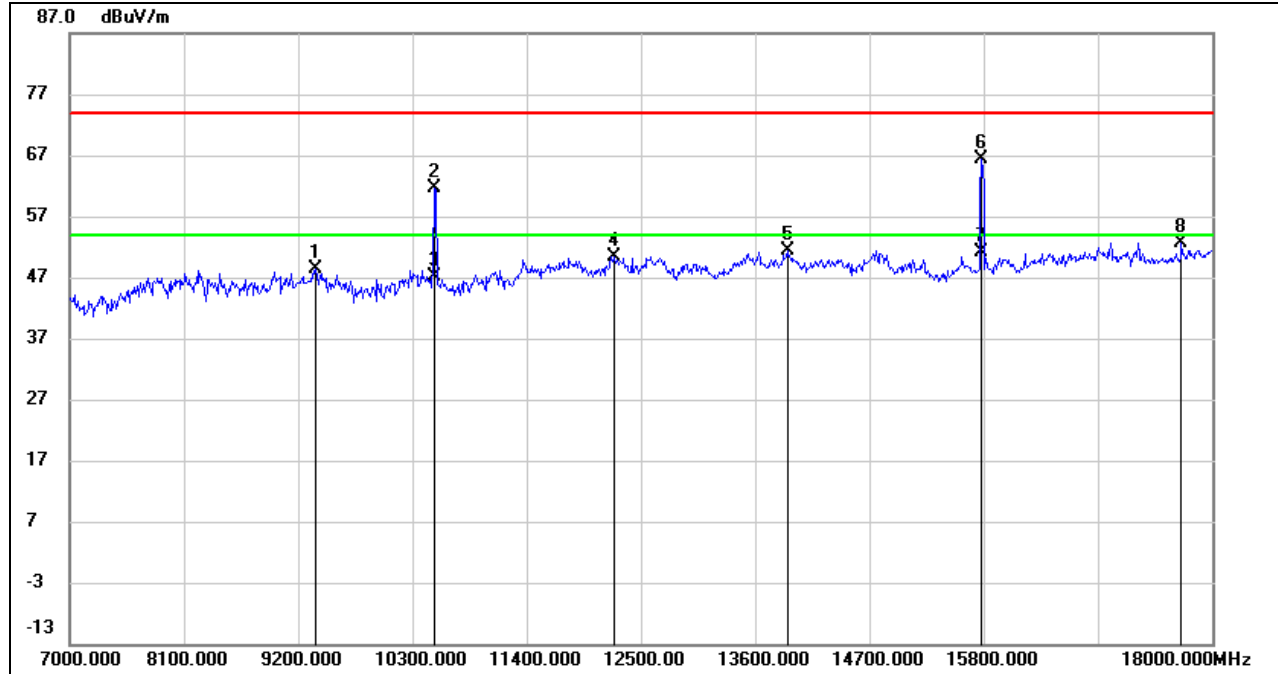

No.	Frequency (MHz)	Reading (dBuV)	Correct (dB/m)	Result (dBuV/m)	Limit (dBuV/m)	Margin (dB)	Remark
1	9365.000	37.53	10.77	48.30	74.00	-25.70	peak
2	10509.000	49.34	12.39	61.73	68.2	-6.47	peak
3	10509.000	34.71	12.39	47.10	/	/	AVG
4	12247.000	34.44	16.02	50.46	74.00	-23.54	peak
5	13908.000	33.72	17.54	51.26	74.00	-22.74	peak
6	15778.000	48.30	17.96	66.26	74.00	-7.74	peak
7	15778.000	33.06	17.96	51.02	54.00	-2.98	AVG
8	17703.000	29.14	23.49	52.63	74.00	-21.37	peak

- Note:
1. Measurement = Reading Level + Correct Factor.
 2. If Peak Result complies with AV limit, AV Result is deemed to comply with AV limit.
 3. Peak: Peak detector.
 4. AVG: $VBW=1/Ton$, where: Ton is the transmitting duration.
 5. For the transmitting duration, please refer to clause 7.1.
 6. Filter losses were only considered in the spurious frequency bands and the authorized band was not corrected for High Pass Filter losses.
 7. Proper operation of the transmitter prior to adding the filter to the measurement chain.
 8. Since non-restricted band peak emissions are less than the average limit, they also comply with the -27dBm/MHz (68.2dBuV/m) limit.

HARMONICS AND SPURIOUS EMISSIONS (LOW CHANNEL, VERTICAL)

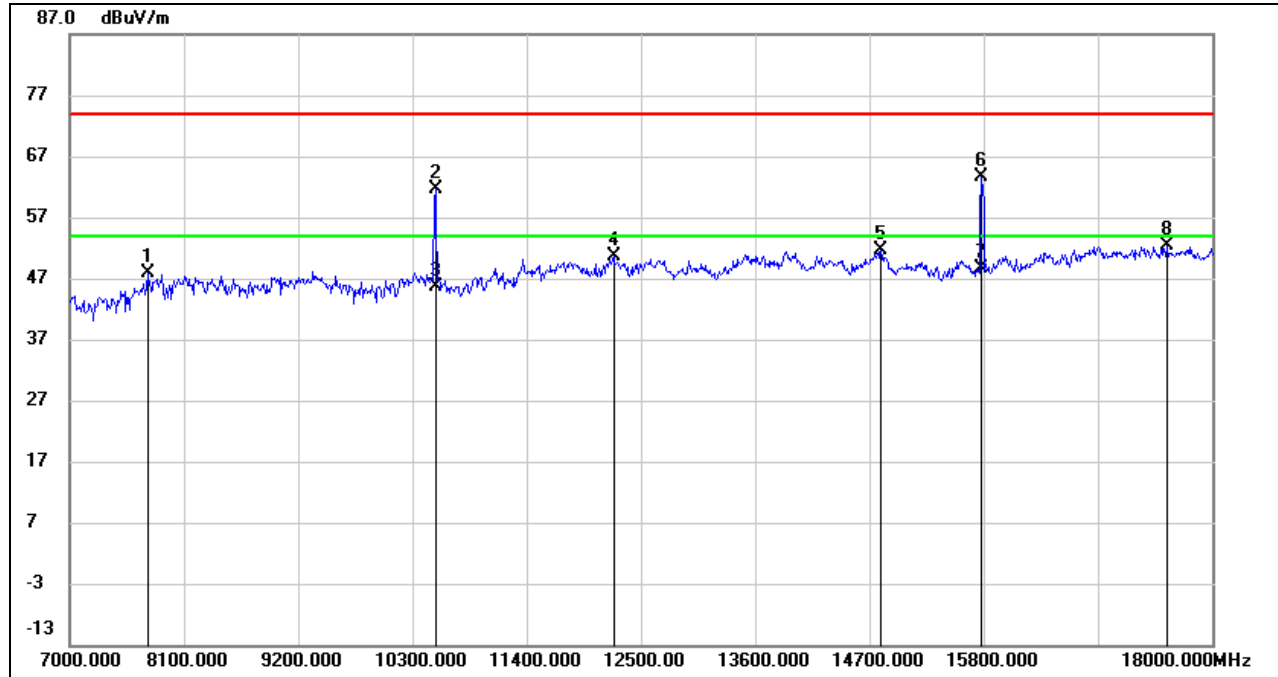

No.	Frequency (MHz)	Reading (dBuV)	Correct (dB/m)	Result (dBuV/m)	Limit (dBuV/m)	Margin (dB)	Remark
1	7748.000	39.08	8.88	47.96	74.00	-26.04	peak
2	10520.000	49.28	12.43	61.71	68.2	-6.49	peak
3	10520.000	33.13	12.43	45.56	/	/	AVG
4	12236.000	34.53	16.01	50.54	74.00	-23.46	peak
5	14810.000	33.59	17.97	51.56	74.00	-22.44	peak
6	15778.000	45.69	17.96	63.65	74.00	-10.35	peak
7	15778.000	30.68	17.96	48.64	54.00	-5.36	AVG
8	17560.000	29.82	22.45	52.27	74.00	-21.73	peak

Note: 1. Measurement = Reading Level + Correct Factor.
 2. If Peak Result complies with AV limit, AV Result is deemed to comply with AV limit.
 3. Peak: Peak detector.
 4. AVG: VBW=1/Ton, where: Ton is the transmitting duration.
 5. For the transmitting duration, please refer to clause 7.1.
 6. Filter losses were only considered in the spurious frequency bands and the authorized band was not corrected for High Pass Filter losses.
 7. Proper operation of the transmitter prior to adding the filter to the measurement chain.
 8. Since non-restricted band peak emissions are less than the average limit, they also comply with the -27dBm/MHz (68.2dBuV/m) limit.

HARMONICS AND SPURIOUS EMISSIONS (MID CHANNEL, HORIZONTAL)

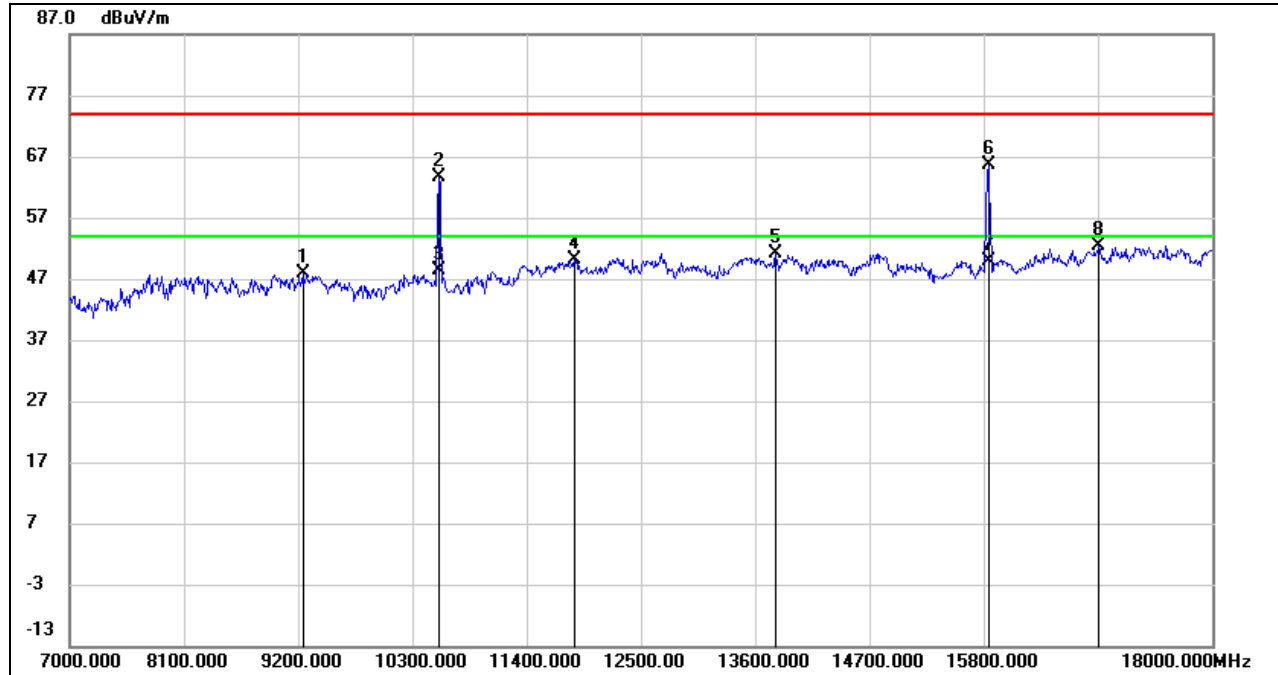

No.	Frequency (MHz)	Reading (dBuV)	Correct (dB/m)	Result (dBuV/m)	Limit (dBuV/m)	Margin (dB)	Remark
1	9244.000	37.84	10.12	47.96	74.00	-26.04	peak
2	10553.000	51.03	12.53	63.56	68.2	-4.64	peak
3	10553.000	35.97	12.53	48.50	/	/	AVG
4	11862.000	34.71	15.41	50.12	74.00	-23.88	peak
5	13798.000	33.53	17.61	51.14	74.00	-22.86	peak
6	15844.000	47.70	18.02	65.72	74.00	-8.28	peak
7	15844.000	31.87	18.02	49.89	54.00	-4.11	AVG
8	16911.000	30.95	21.54	52.49	74.00	-21.51	peak

- Note:
1. Measurement = Reading Level + Correct Factor.
 2. If Peak Result complies with AV limit, AV Result is deemed to comply with AV limit.
 3. Peak: Peak detector.
 4. AVG: VBW=1/Ton, where: Ton is the transmitting duration.
 5. For the transmitting duration, please refer to clause 7.1.
 6. Filter losses were only considered in the spurious frequency bands and the authorized band was not corrected for High Pass Filter losses.
 7. Proper operation of the transmitter prior to adding the filter to the measurement chain.
 8. Since non-restricted band peak emissions are less than the average limit, they also comply with the -27dBm/MHz (68.2dBuV/m) limit.

HARMONICS AND SPURIOUS EMISSIONS (MID CHANNEL, VERTICAL)

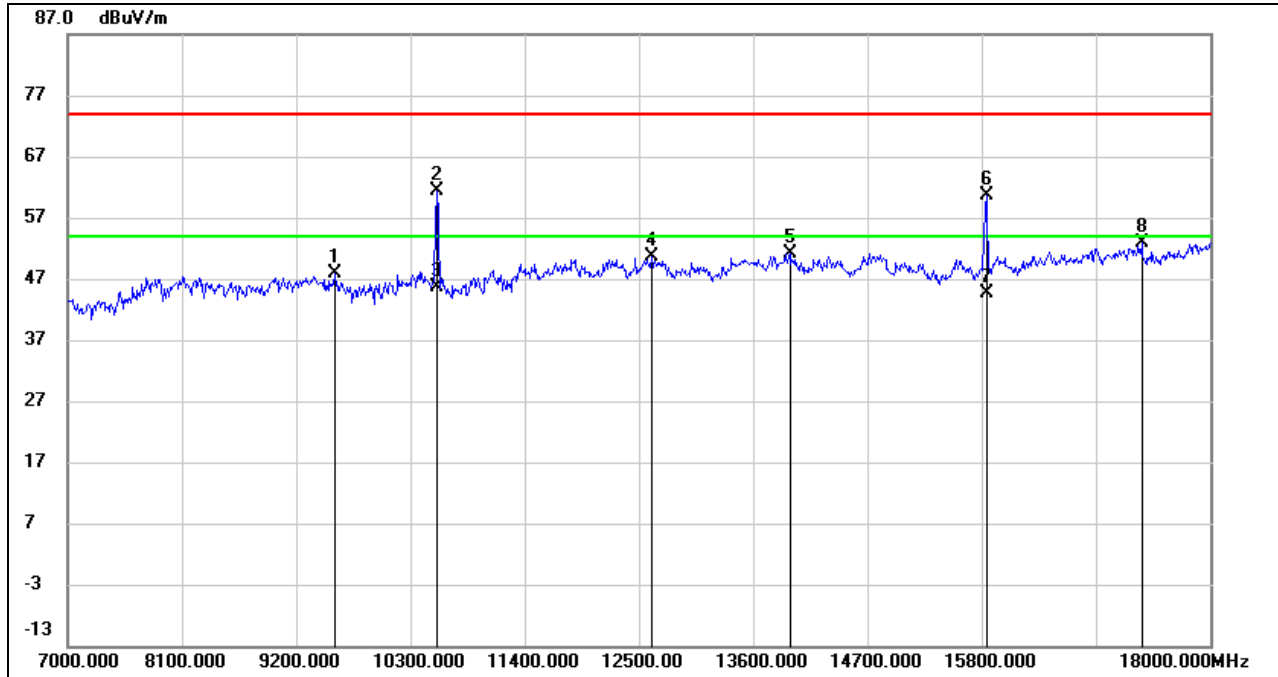

No.	Frequency (MHz)	Reading (dBuV)	Correct (dB/m)	Result (dBuV/m)	Limit (dBuV/m)	Margin (dB)	Remark
1	9574.000	37.01	10.90	47.91	74.00	-26.09	peak
2	10553.000	48.81	12.53	61.34	68.2	-6.86	peak
3	10553.000	33.00	12.53	45.53	/	/	AVG
4	12621.000	34.88	15.75	50.63	74.00	-23.37	peak
5	13952.000	33.64	17.60	51.24	74.00	-22.76	peak
6	15844.000	42.56	18.02	60.58	74.00	-13.42	peak
7	15844.000	26.59	18.02	44.61	54.00	-9.39	AVG
8	17340.000	30.64	22.31	52.95	74.00	-21.05	peak

- Note:
1. Measurement = Reading Level + Correct Factor.
 2. If Peak Result complies with AV limit, AV Result is deemed to comply with AV limit.
 3. Peak: Peak detector.
 4. AVG: VBW=1/Ton, where: Ton is the transmitting duration.
 5. For the transmitting duration, please refer to clause 7.1.
 6. Filter losses were only considered in the spurious frequency bands and the authorized band was not corrected for High Pass Filter losses.
 7. Proper operation of the transmitter prior to adding the filter to the measurement chain.
 8. Since non-restricted band peak emissions are less than the average limit, they also comply with the -27dBm/MHz (68.2dBuV/m) limit.



HARMONICS AND SPURIOUS EMISSIONS (HIGH CHANNEL, HORIZONTAL)

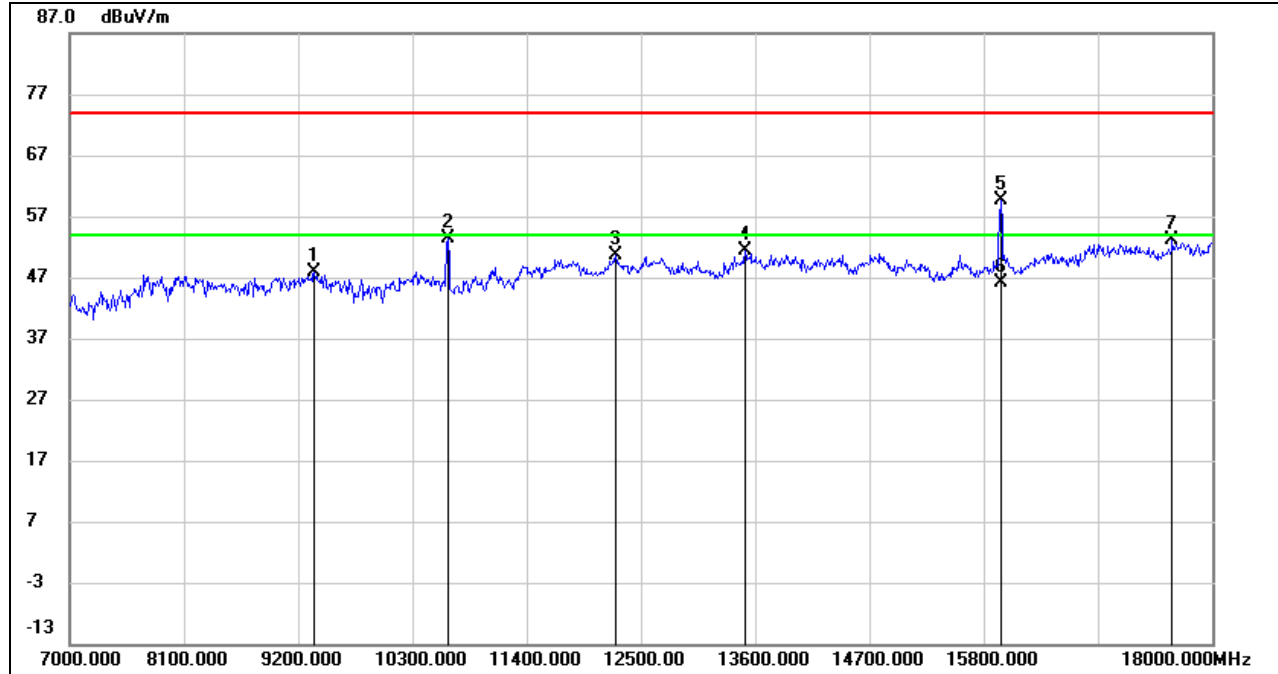

No.	Frequency (MHz)	Reading (dBuV)	Correct (dB/m)	Result (dBuV/m)	Limit (dBuV/m)	Margin (dB)	Remark
1	9354.000	37.18	10.70	47.88	74.00	-26.12	peak
2	10641.000	40.66	12.77	53.43	74.00	-20.57	peak
3	12258.000	34.72	16.03	50.75	74.00	-23.25	peak
4	13501.000	34.24	17.22	51.46	74.00	-22.54	peak
5	15965.000	41.42	18.29	59.71	74.00	-14.29	peak
6	15965.000	27.88	18.29	46.17	54.00	-7.83	AVG
7	17615.000	30.23	22.84	53.07	74.00	-20.93	peak

- Note:
1. Measurement = Reading Level + Correct Factor.
 2. If Peak Result complies with AV limit, AV Result is deemed to comply with AV limit.
 3. Peak: Peak detector.
 4. AVG: VBW=1/Ton, where: Ton is the transmitting duration.
 5. For the transmitting duration, please refer to clause 7.1.
 6. Filter losses were only considered in the spurious frequency bands and the authorized band was not corrected for High Pass Filter losses.
 7. Proper operation of the transmitter prior to adding the filter to the measurement chain.
 8. Since non-restricted band peak emissions are less than the average limit, they also comply with the -27dBm/MHz (68.2dBuV/m) limit.

HARMONICS AND SPURIOUS EMISSIONS (HIGH CHANNEL, VERTICAL)

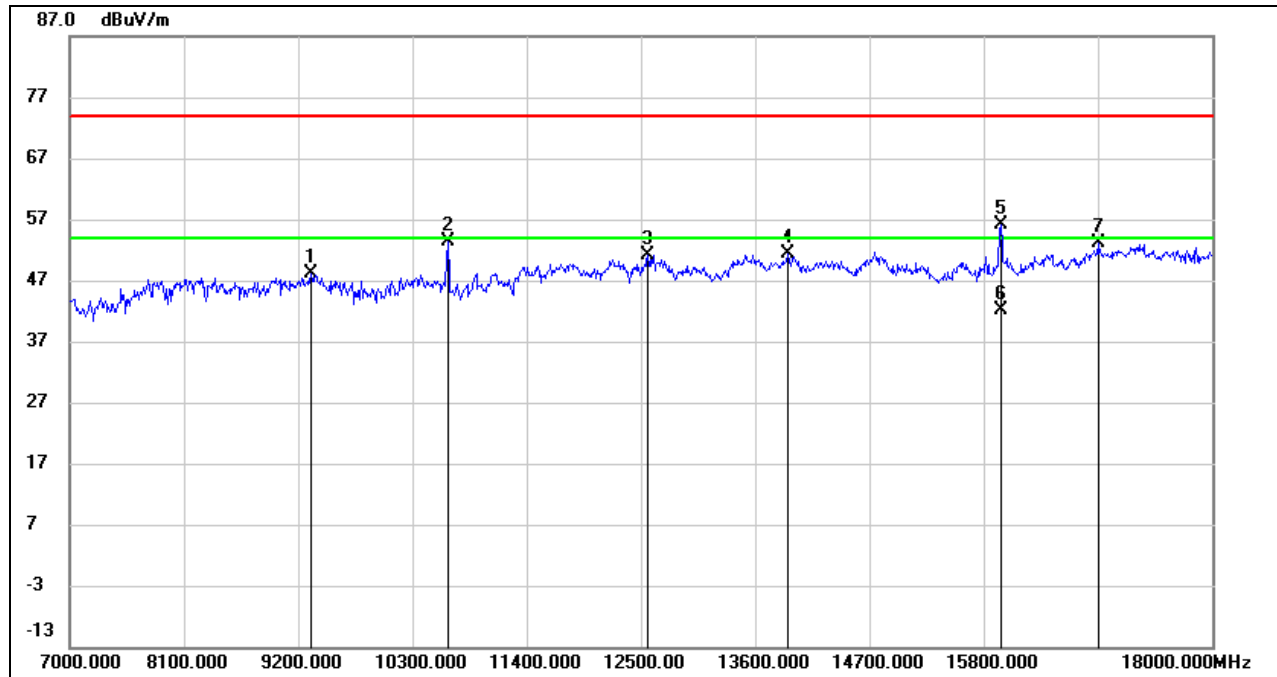

No.	Frequency (MHz)	Reading (dBuV)	Correct (dB/m)	Result (dBuV/m)	Limit (dBuV/m)	Margin (dB)	Remark
1	9321.000	37.50	10.52	48.02	74.00	-25.98	peak
2	10641.000	40.61	12.77	53.38	74.00	-20.62	peak
3	12566.000	35.38	15.74	51.12	74.00	-22.88	peak
4	13919.000	33.83	17.55	51.38	74.00	-22.62	peak
5	15965.000	37.78	18.29	56.07	74.00	-17.93	peak
6	15965.000	23.84	18.29	42.13	54.00	-11.87	AVG
7	16900.000	31.63	21.57	53.20	74.00	-20.80	peak

- Note:
1. Measurement = Reading Level + Correct Factor.
 2. If Peak Result complies with AV limit, AV Result is deemed to comply with AV limit.
 3. Peak: Peak detector.
 4. AVG: $VBW=1/Ton$, where: Ton is the transmitting duration.
 5. For the transmitting duration, please refer to clause 7.1.
 6. Filter losses were only considered in the spurious frequency bands and the authorized band was not corrected for High Pass Filter losses.
 7. Proper operation of the transmitter prior to adding the filter to the measurement chain.
 8. Since non-restricted band peak emissions are less than the average limit, they also comply with the -27dBm/MHz (68.2dBuV/m) limit.

UNII-2C BAND

HARMONICS AND SPURIOUS EMISSIONS (LOW CHANNEL, HORIZONTAL)

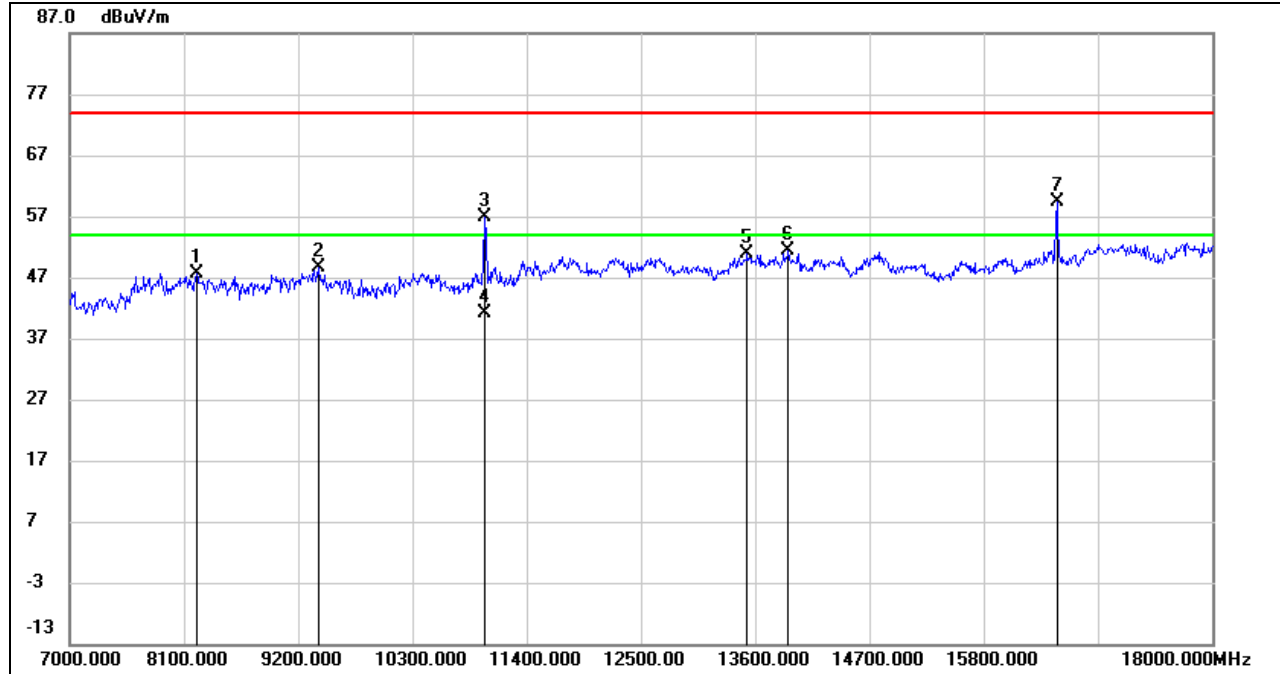

No.	Frequency (MHz)	Reading (dBuV)	Correct (dB/m)	Result (dBuV/m)	Limit (dBuV/m)	Margin (dB)	Remark
1	8221.000	37.94	9.79	47.73	74.00	-26.27	peak
2	9398.000	37.61	10.96	48.57	74.00	-25.43	peak
3	10993.000	43.49	13.31	56.80	74.00	-17.20	peak
4	10993.000	27.80	13.31	41.11	54.00	-12.89	AVG
5	13523.000	33.78	17.19	50.97	74.00	-23.03	peak
6	13919.000	33.81	17.55	51.36	74.00	-22.64	peak
7	16504.000	39.68	19.70	59.38	68.2	-8.82	peak

- Note:
1. Measurement = Reading Level + Correct Factor.
 2. If Peak Result complies with AV limit, AV Result is deemed to comply with AV limit.
 3. Peak: Peak detector.
 4. AVG: $VBW=1/Ton$, where: Ton is the transmitting duration.
 5. For the transmitting duration, please refer to clause 7.1.
 6. Filter losses were only considered in the spurious frequency bands and the authorized band was not corrected for High Pass Filter losses.
 7. Proper operation of the transmitter prior to adding the filter to the measurement chain.
 8. Since non-restricted band peak emissions are less than the average limit, they also comply with the -27dBm/MHz (68.2dBuV/m) limit.

HARMONICS AND SPURIOUS EMISSIONS (LOW CHANNEL, VERTICAL)

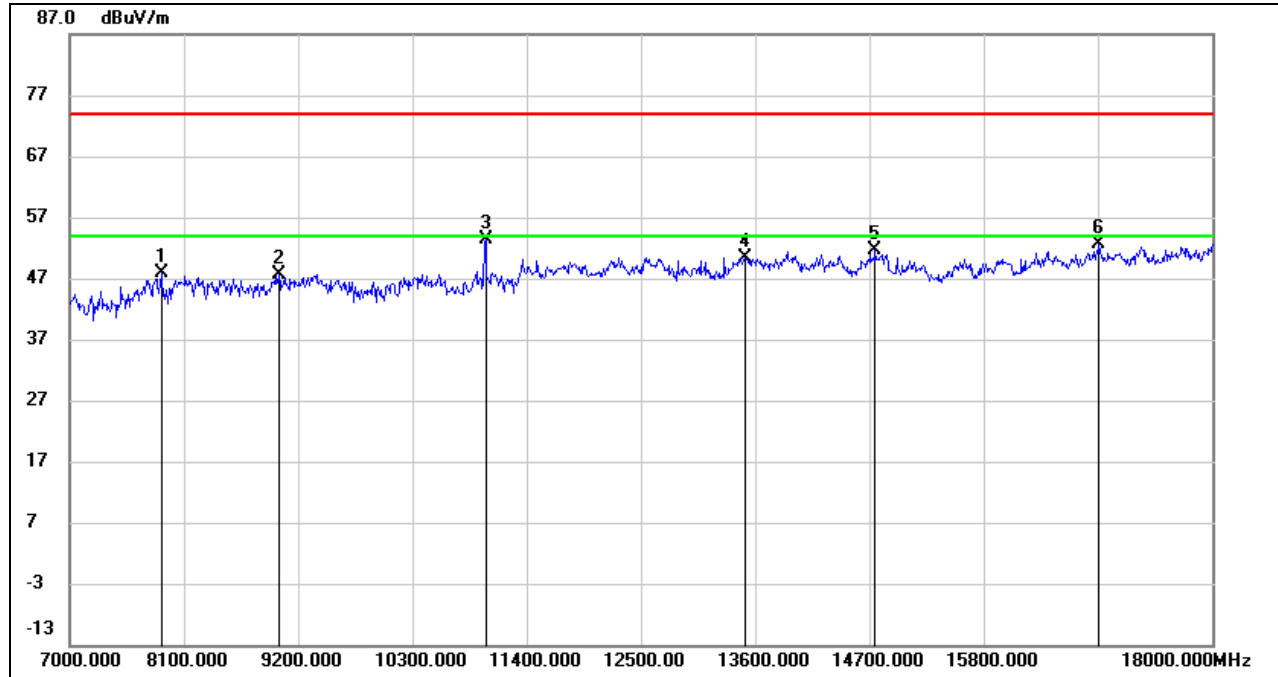

No.	Frequency (MHz)	Reading (dBuV)	Correct (dB/m)	Result (dBuV/m)	Limit (dBuV/m)	Margin (dB)	Remark
1	7880.000	38.88	8.95	47.83	74.00	-26.17	peak
2	9013.000	36.50	11.12	47.62	74.00	-26.38	peak
3	11004.000	39.99	13.32	53.31	74.00	-20.69	peak
4	13501.000	33.20	17.22	50.42	74.00	-23.58	peak
5	14755.000	33.69	17.88	51.57	74.00	-22.43	peak
6	16911.000	31.01	21.54	52.55	74.00	-21.45	peak

- Note:
1. Measurement = Reading Level + Correct Factor.
 2. If Peak Result complies with AV limit, AV Result is deemed to comply with AV limit.
 3. Peak: Peak detector.
 4. AVG: $VBW=1/Ton$, where: Ton is the transmitting duration.
 5. For the transmitting duration, please refer to clause 7.1.
 6. Filter losses were only considered in the spurious frequency bands and the authorized band was not corrected for High Pass Filter losses.
 7. Proper operation of the transmitter prior to adding the filter to the measurement chain.
 8. Since non-restricted band peak emissions are less than the average limit, they also comply with the -27dBm/MHz (68.2dBuV/m) limit.

HARMONICS AND SPURIOUS EMISSIONS (MID CHANNEL, HORIZONTAL)

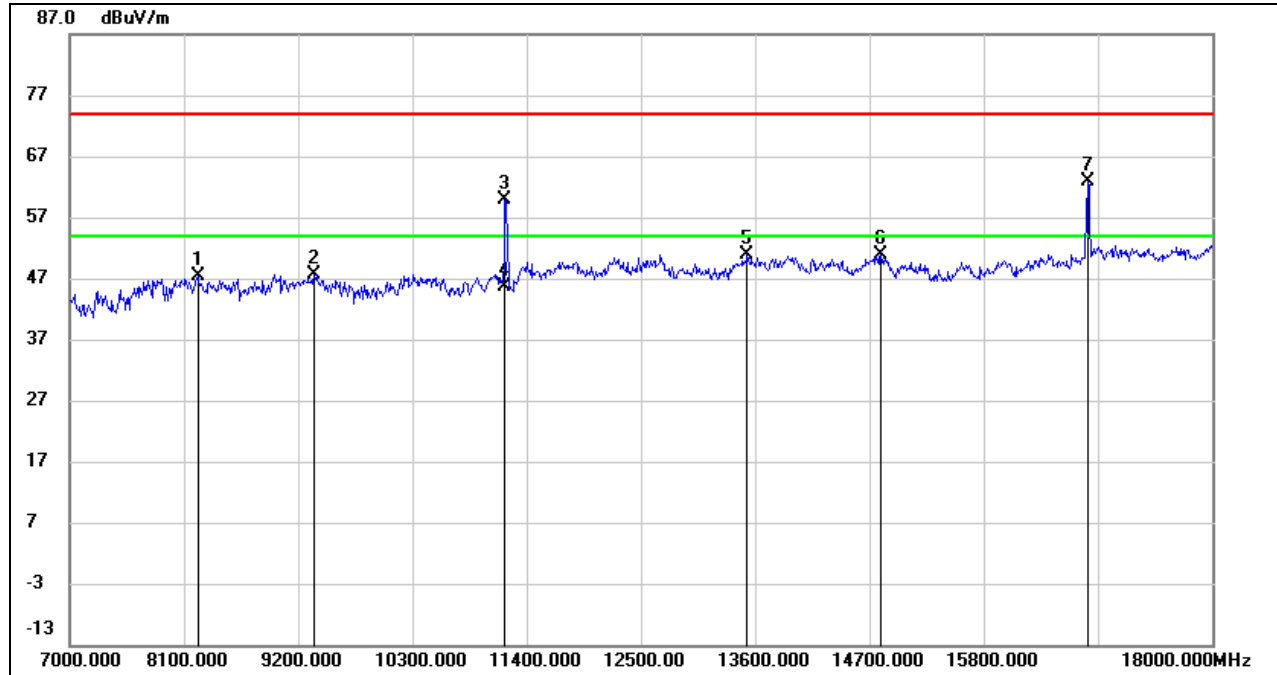

No.	Frequency (MHz)	Reading (dBuV)	Correct (dB/m)	Result (dBuV/m)	Limit (dBuV/m)	Margin (dB)	Remark
1	8232.000	37.49	9.77	47.26	74.00	-26.74	peak
2	9354.000	36.99	10.70	47.69	74.00	-26.31	peak
3	11191.000	46.19	13.78	59.97	74.00	-14.03	peak
4	11191.000	31.78	13.78	45.56	54.00	-8.44	AVG
5	13523.000	33.76	17.19	50.95	74.00	-23.05	peak
6	14810.000	32.80	17.97	50.77	74.00	-23.23	peak
7	16801.000	42.23	20.72	62.95	68.2	-5.25	peak

Note: 1. Measurement = Reading Level + Correct Factor.

2. If Peak Result complies with AV limit, AV Result is deemed to comply with AV limit.

3. Peak: Peak detector.

4. AVG: $VBW=1/Ton$, where: Ton is the transmitting duration.

5. For the transmitting duration, please refer to clause 7.1.

6. Filter losses were only considered in the spurious frequency bands and the authorized band was not corrected for High Pass Filter losses.

7. Proper operation of the transmitter prior to adding the filter to the measurement chain.

8. Since non-restricted band peak emissions are less than the average limit, they also comply with the -27dBm/MHz (68.2dBuV/m) limit.

HARMONICS AND SPURIOUS EMISSIONS (MID CHANNEL, VERTICAL)

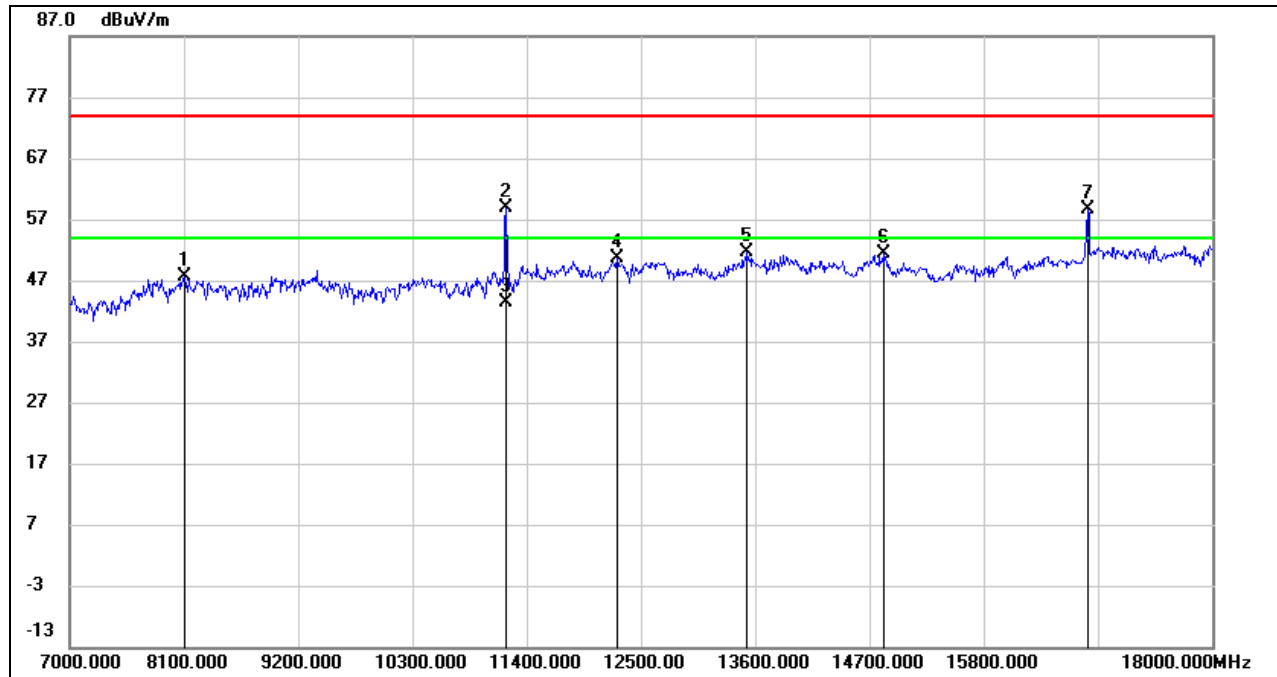

No.	Frequency (MHz)	Reading (dBuV)	Correct (dB/m)	Result (dBuV/m)	Limit (dBuV/m)	Margin (dB)	Remark
1	8100.000	37.51	10.18	47.69	74.00	-26.31	peak
2	11202.000	45.05	13.79	58.84	74.00	-15.16	peak
3	11202.000	29.56	13.79	43.35	54.00	-10.65	AVG
4	12269.000	34.53	16.04	50.57	74.00	-23.43	peak
5	13523.000	34.34	17.19	51.53	74.00	-22.47	peak
6	14832.000	33.64	17.83	51.47	74.00	-22.53	peak
7	16801.000	37.79	20.72	58.51	68.2	-9.69	peak

- Note:
1. Measurement = Reading Level + Correct Factor.
 2. If Peak Result complies with AV limit, AV Result is deemed to comply with AV limit.
 3. Peak: Peak detector.
 4. AVG: $VBW=1/Ton$, where: Ton is the transmitting duration.
 5. For the transmitting duration, please refer to clause 7.1.
 6. Filter losses were only considered in the spurious frequency bands and the authorized band was not corrected for High Pass Filter losses.
 7. Proper operation of the transmitter prior to adding the filter to the measurement chain.
 8. Since non-restricted band peak emissions are less than the average limit, they also comply with the $-27dBm/MHz$ ($68.2dBuV/m$) limit.

HARMONICS AND SPURIOUS EMISSIONS (HIGH CHANNEL, HORIZONTAL)

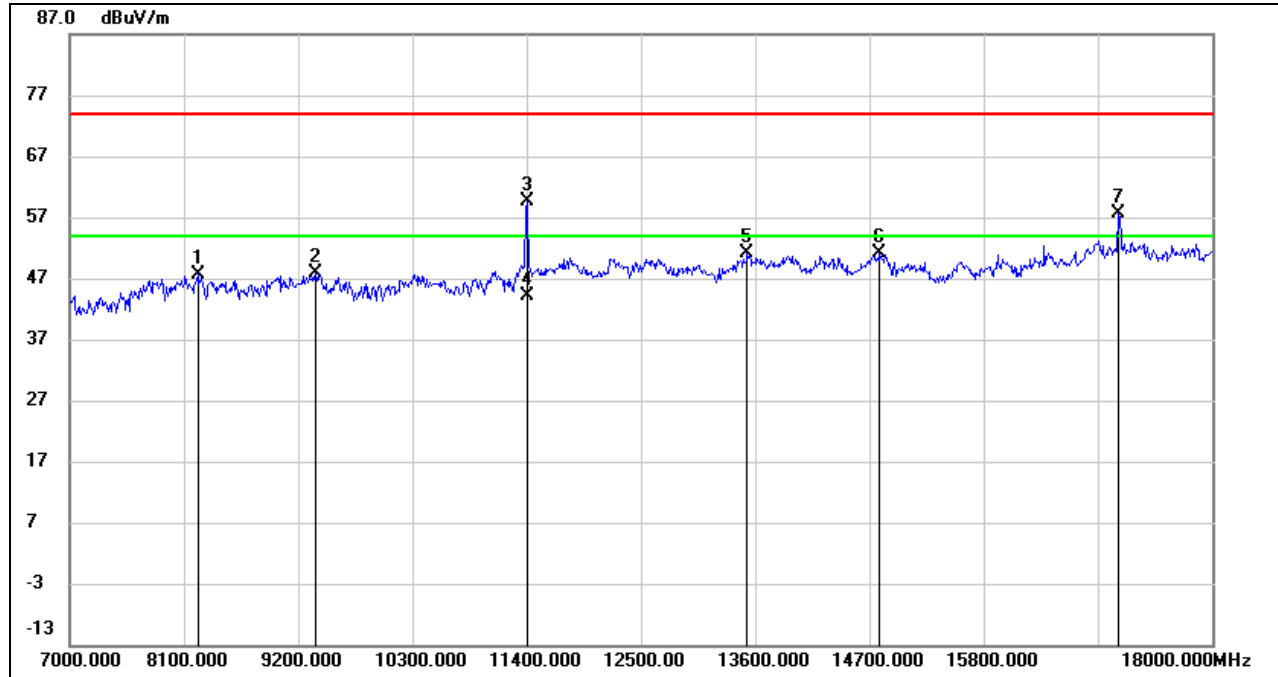

No.	Frequency (MHz)	Reading (dBuV)	Correct (dB/m)	Result (dBuV/m)	Limit (dBuV/m)	Margin (dB)	Remark
1	8232.000	37.96	9.77	47.73	74.00	-26.27	peak
2	9365.000	37.21	10.77	47.98	74.00	-26.02	peak
3	11400.000	44.82	14.76	59.58	74.00	-14.42	peak
4	11400.000	29.26	14.76	44.02	54.00	-9.98	AVG
5	13523.000	33.82	17.19	51.01	74.00	-22.99	peak
6	14799.000	33.15	18.04	51.19	74.00	-22.81	peak
7	17098.000	35.82	21.89	57.71	68.2	-10.49	peak

- Note:
1. Measurement = Reading Level + Correct Factor.
 2. If Peak Result complies with AV limit, AV Result is deemed to comply with AV limit.
 3. Peak: Peak detector.
 4. AVG: $VBW=1/Ton$, where: Ton is the transmitting duration.
 5. For the transmitting duration, please refer to clause 7.1.
 6. Filter losses were only considered in the spurious frequency bands and the authorized band was not corrected for High Pass Filter losses.
 7. Proper operation of the transmitter prior to adding the filter to the measurement chain.
 8. Since non-restricted band peak emissions are less than the average limit, they also comply with the -27dBm/MHz (68.2dBuV/m) limit.

HARMONICS AND SPURIOUS EMISSIONS (HIGH CHANNEL, VERTICAL)

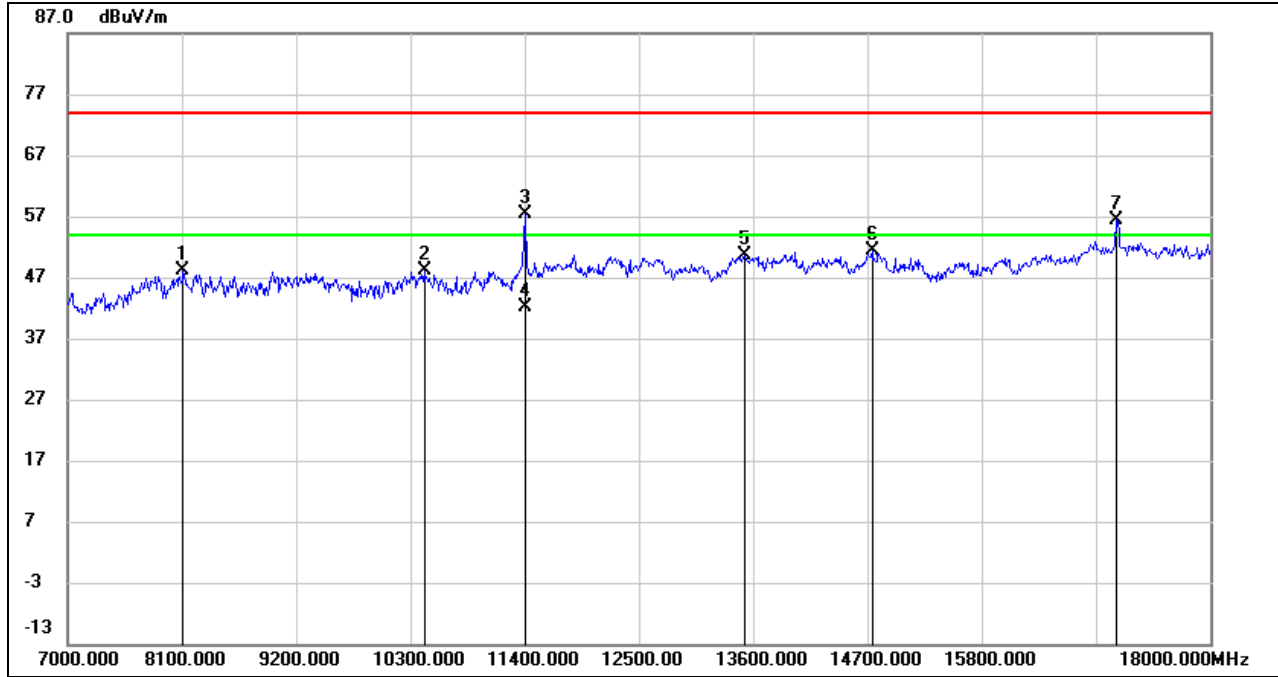

No.	Frequency (MHz)	Reading (dBuV)	Correct (dB/m)	Result (dBuV/m)	Limit (dBuV/m)	Margin (dB)	Remark
1	8111.000	38.09	10.14	48.23	74.00	-25.77	peak
2	10432.000	35.87	12.27	48.14	74.00	-25.86	peak
3	11400.000	42.59	14.76	57.35	74.00	-16.65	peak
4	11400.000	27.49	14.76	42.25	54.00	-11.75	AVG
5	13523.000	33.54	17.19	50.73	74.00	-23.27	peak
6	14744.000	33.53	17.84	51.37	74.00	-22.63	peak
7	17098.000	34.49	21.89	56.38	68.2	-11.82	peak

- Note:
1. Measurement = Reading Level + Correct Factor.
 2. If Peak Result complies with AV limit, AV Result is deemed to comply with AV limit.
 3. Peak: Peak detector.
 4. AVG: VBW=1/Ton, where: Ton is the transmitting duration.
 5. For the transmitting duration, please refer to clause 7.1.
 6. Filter losses were only considered in the spurious frequency bands and the authorized band was not corrected for High Pass Filter losses.
 7. Proper operation of the transmitter prior to adding the filter to the measurement chain.
 8. Since non-restricted band peak emissions are less than the average limit, they also comply with the -27dBm/MHz (68.2dBuV/m) limit.

UNII-3 BAND

HARMONICS AND SPURIOUS EMISSIONS (LOW CHANNEL, HORIZONTAL)

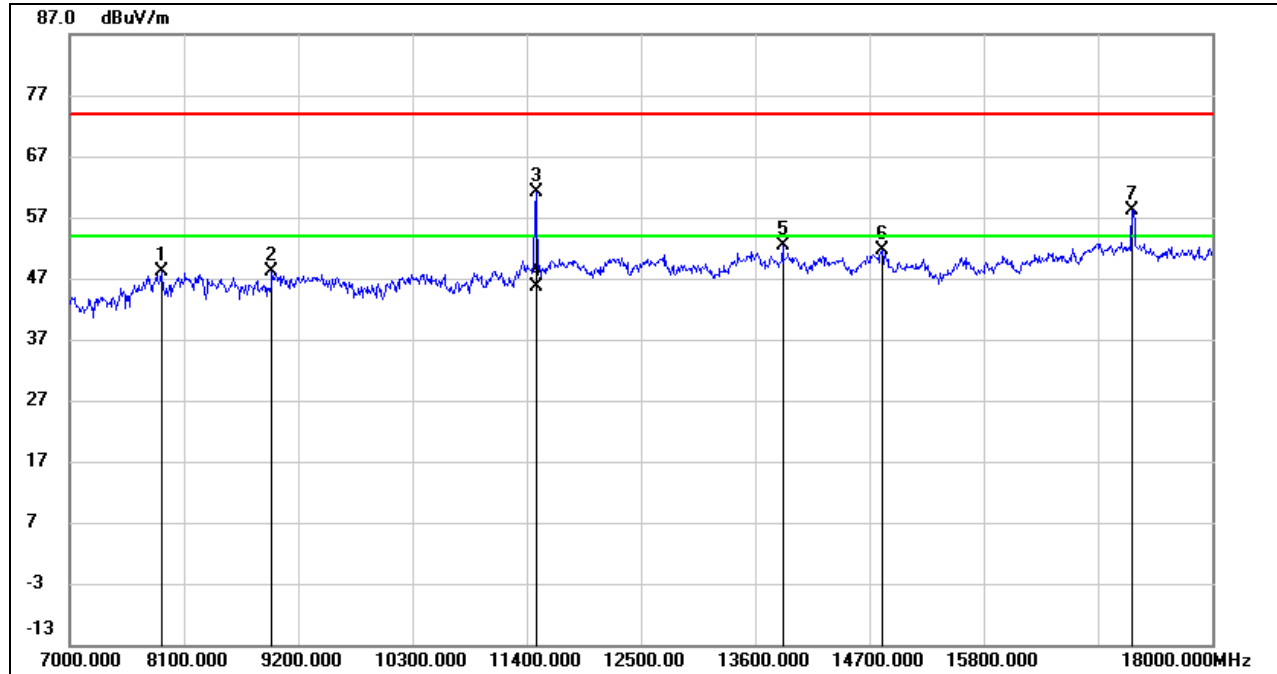

No.	Frequency (MHz)	Reading (dBuV)	Correct (dB/m)	Result (dBuV/m)	Limit (dBuV/m)	Margin (dB)	Remark
1	7880.000	39.23	8.95	48.18	74.00	-25.82	peak
2	8947.000	37.77	10.27	48.04	74.00	-25.96	peak
3	11488.000	46.36	14.66	61.02	74.00	-12.98	peak
4	11488.000	30.99	14.66	45.65	54.00	-8.35	AVG
5	13864.000	34.79	17.55	52.34	74.00	-21.66	peak
6	14821.000	33.65	17.90	51.55	74.00	-22.45	peak
7	17230.000	35.93	22.17	58.10	68.2	-10.01	peak

- Note:
1. Measurement = Reading Level + Correct Factor.
 2. If Peak Result complies with AV limit, AV Result is deemed to comply with AV limit.
 3. Peak: Peak detector.
 4. AVG: $VBW=1/Ton$, where: Ton is the transmitting duration.
 5. For the transmitting duration, please refer to clause 7.1.
 6. Filter losses were only considered in the spurious frequency bands and the authorized band was not corrected for High Pass Filter losses.
 7. Proper operation of the transmitter prior to adding the filter to the measurement chain.
 8. Since non-restricted band peak emissions are less than the average limit, they also comply with the -27dBm/MHz (68.2dBuV/m) limit.

HARMONICS AND SPURIOUS EMISSIONS (LOW CHANNEL, VERTICAL)

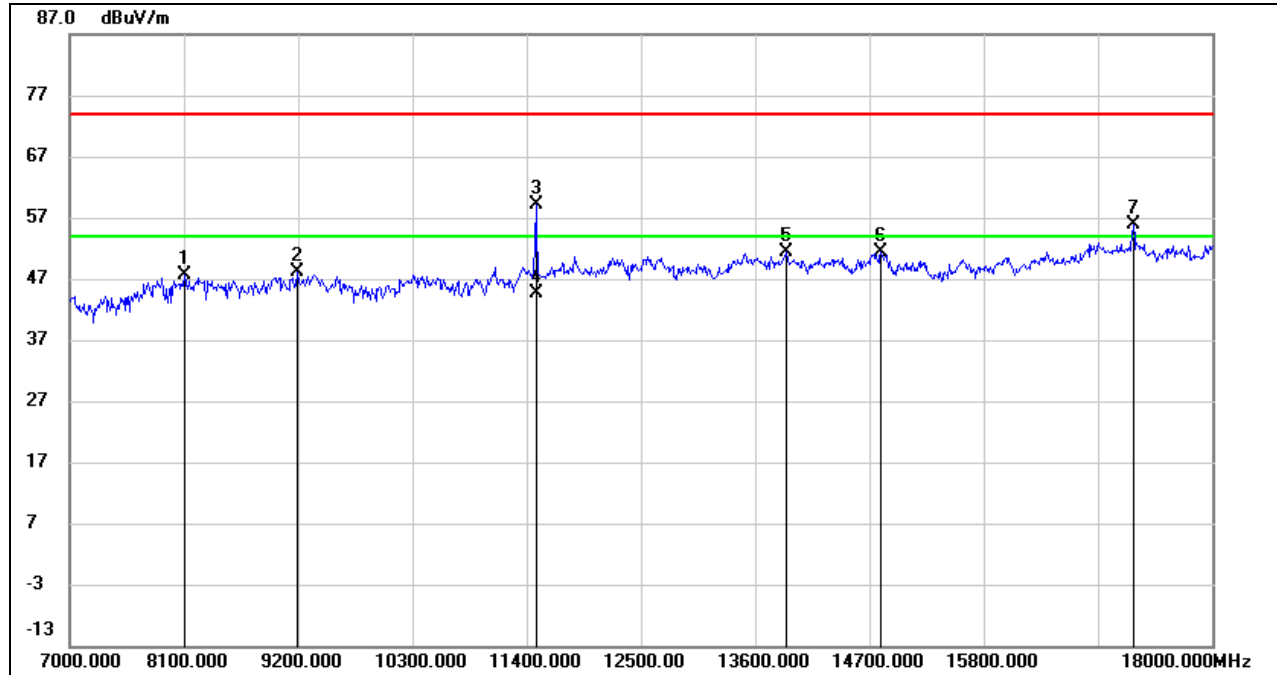

No.	Frequency (MHz)	Reading (dBuV)	Correct (dB/m)	Result (dBuV/m)	Limit (dBuV/m)	Margin (dB)	Remark
1	8111.000	37.44	10.14	47.58	74.00	-26.42	peak
2	9189.000	38.28	9.93	48.21	74.00	-25.79	peak
3	11488.000	44.42	14.66	59.08	74.00	-14.92	peak
4	11488.000	29.85	14.66	44.51	54.00	-9.49	AVG
5	13897.000	33.74	17.52	51.26	74.00	-22.74	peak
6	14810.000	33.29	17.97	51.26	74.00	-22.74	peak
7	17241.000	33.74	22.24	55.98	68.2	-12.22	peak

Note: 1. Measurement = Reading Level + Correct Factor.

2. If Peak Result complies with AV limit, AV Result is deemed to comply with AV limit.

3. Peak: Peak detector.

4. AVG: $VBW=1/Ton$, where: Ton is the transmitting duration.

5. For the transmitting duration, please refer to clause 7.1.

6. Filter losses were only considered in the spurious frequency bands and the authorized band was not corrected for High Pass Filter losses.

7. Proper operation of the transmitter prior to adding the filter to the measurement chain.

8. Since non-restricted band peak emissions are less than the average limit, they also comply with the -27dBm/MHz (68.2dBuV/m) limit.

HARMONICS AND SPURIOUS EMISSIONS (MID CHANNEL, HORIZONTAL)

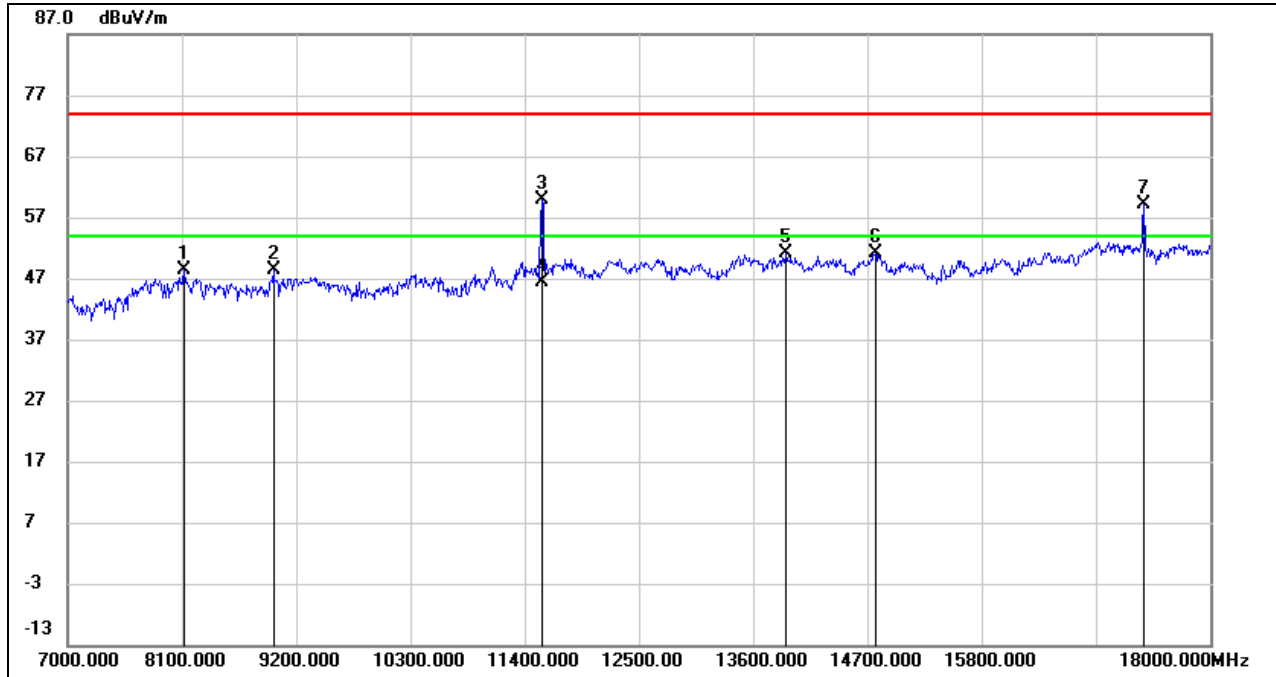

No.	Frequency (MHz)	Reading (dBuV)	Correct (dB/m)	Result (dBuV/m)	Limit (dBuV/m)	Margin (dB)	Remark
1	8122.000	38.26	10.10	48.36	74.00	-25.64	peak
2	8980.000	37.38	10.89	48.27	74.00	-25.73	peak
3	11565.000	45.19	14.69	59.88	74.00	-14.12	peak
4	11565.000	31.67	14.69	46.36	54.00	-7.64	AVG
5	13919.000	33.50	17.55	51.05	74.00	-22.95	peak
6	14777.000	33.22	17.96	51.18	74.00	-22.82	peak
7	17362.000	37.04	22.15	59.19	68.2	-9.01	peak

Note: 1. Measurement = Reading Level + Correct Factor.
 2. If Peak Result complies with AV limit, AV Result is deemed to comply with AV limit.
 3. Peak: Peak detector.
 4. AVG: $VBW=1/Ton$, where: Ton is the transmitting duration.
 5. For the transmitting duration, please refer to clause 7.1.
 6. Filter losses were only considered in the spurious frequency bands and the authorized band was not corrected for High Pass Filter losses.
 7. Proper operation of the transmitter prior to adding the filter to the measurement chain.
 8. Since non-restricted band peak emissions are less than the average limit, they also comply with the -27dBm/MHz (68.2dBuV/m) limit.

HARMONICS AND SPURIOUS EMISSIONS (MID CHANNEL, VERTICAL)

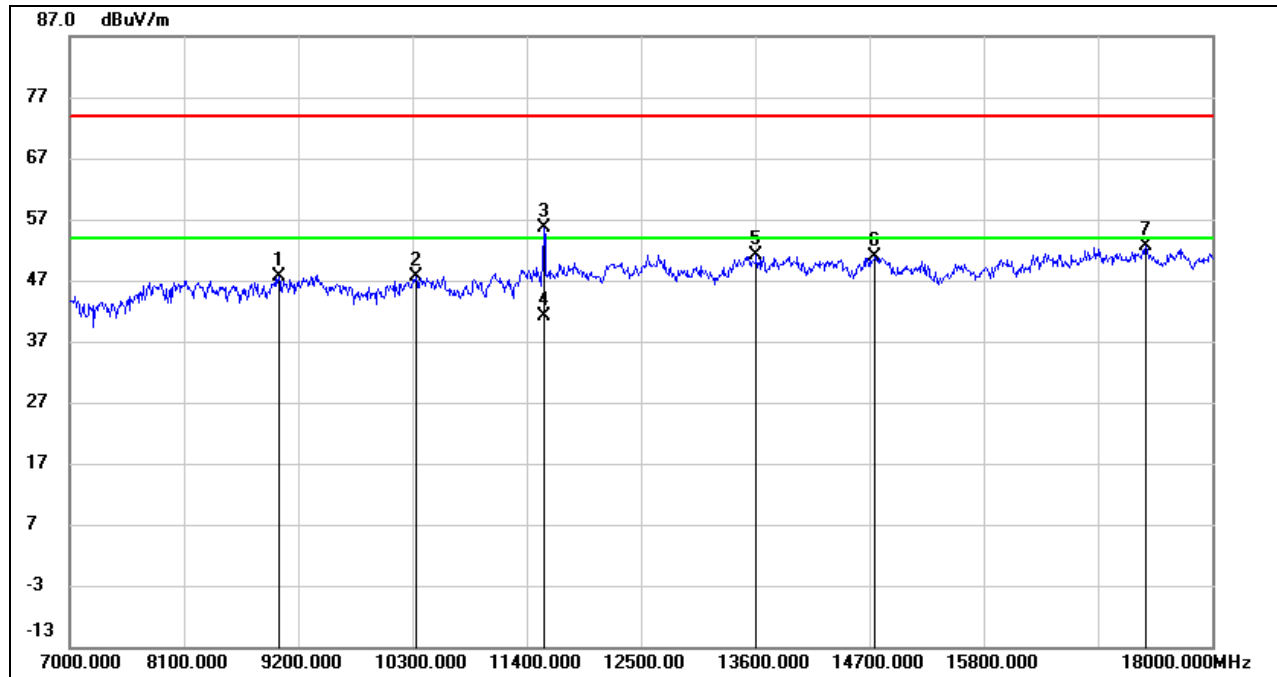

No.	Frequency (MHz)	Reading (dBuV)	Correct (dB/m)	Result (dBuV/m)	Limit (dBuV/m)	Margin (dB)	Remark
1	9013.000	36.49	11.12	47.61	74.00	-26.39	peak
2	10333.000	35.67	11.94	47.61	74.00	-26.39	peak
3	11565.000	40.94	14.69	55.63	74.00	-18.37	peak
4	11565.000	26.46	14.69	41.15	54.00	-12.85	AVG
5	13611.000	33.93	17.15	51.08	74.00	-22.92	peak
6	14755.000	32.91	17.88	50.79	74.00	-23.21	peak
7	17362.000	30.46	22.15	52.61	74.00	-21.39	peak

Note: 1. Measurement = Reading Level + Correct Factor.

2. If Peak Result complies with AV limit, AV Result is deemed to comply with AV limit.

3. Peak: Peak detector.

4. AVG: $VBW=1/Ton$, where: Ton is the transmitting duration.

5. For the transmitting duration, please refer to clause 7.1.

6. Filter losses were only considered in the spurious frequency bands and the authorized band was not corrected for High Pass Filter losses.

7. Proper operation of the transmitter prior to adding the filter to the measurement chain.

8. Since non-restricted band peak emissions are less than the average limit, they also comply with the -27dBm/MHz (68.2dBuV/m) limit.

HARMONICS AND SPURIOUS EMISSIONS (HIGH CHANNEL, HORIZONTAL)

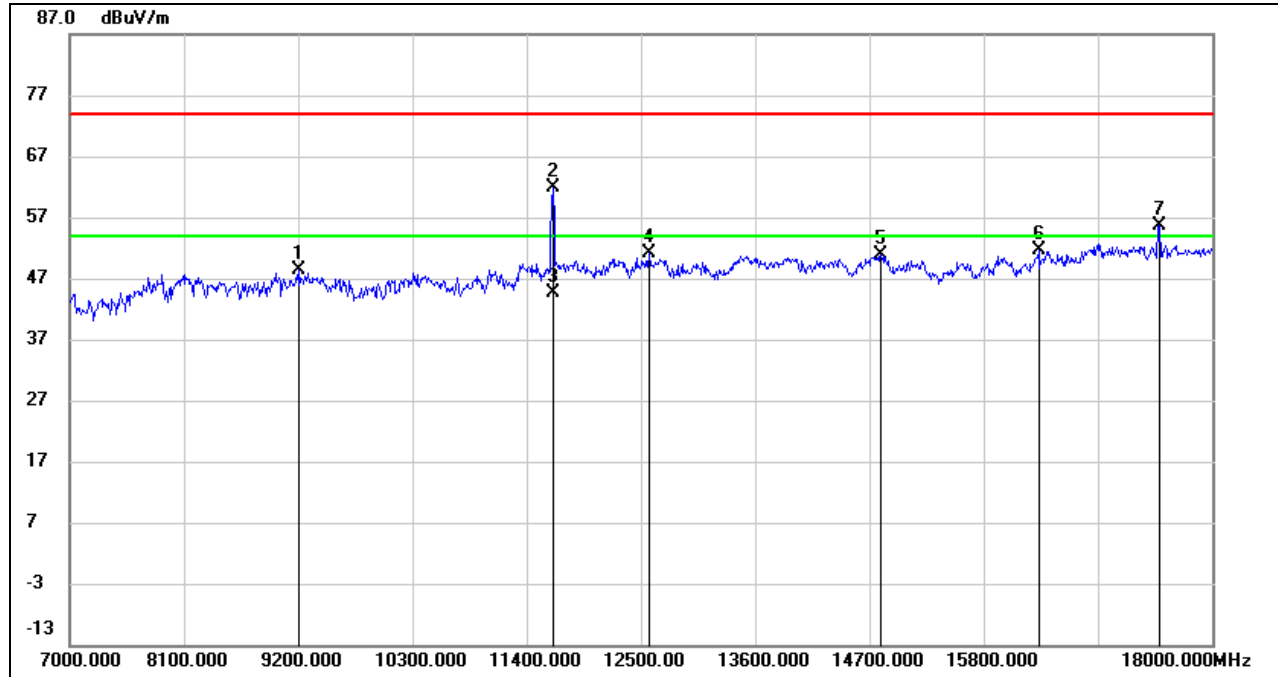

No.	Frequency (MHz)	Reading (dBuV)	Correct (dB/m)	Result (dBuV/m)	Limit (dBuV/m)	Margin (dB)	Remark
1	9211.000	38.30	9.96	48.26	74.00	-25.74	peak
2	11653.000	46.74	15.05	61.79	74.00	-12.21	peak
3	11653.000	29.46	15.05	44.51	54.00	-9.49	AVG
4	12577.000	35.49	15.75	51.24	74.00	-22.76	peak
5	14810.000	32.99	17.97	50.96	74.00	-23.04	peak
6	16328.000	31.89	19.63	51.52	74.00	-22.48	peak
7	17494.000	33.69	22.03	55.72	68.2	-12.48	peak

- Note: 1. Measurement = Reading Level + Correct Factor.
 2. If Peak Result complies with AV limit, AV Result is deemed to comply with AV limit.
 3. Peak: Peak detector.
 4. AVG: $VBW=1/Ton$, where: Ton is the transmitting duration.
 5. For the transmitting duration, please refer to clause 7.1.
 6. Filter losses were only considered in the spurious frequency bands and the authorized band was not corrected for High Pass Filter losses.
 7. Proper operation of the transmitter prior to adding the filter to the measurement chain.
 8. Since non-restricted band peak emissions are less than the average limit, they also comply with the -27dBm/MHz (68.2dBuV/m) limit.

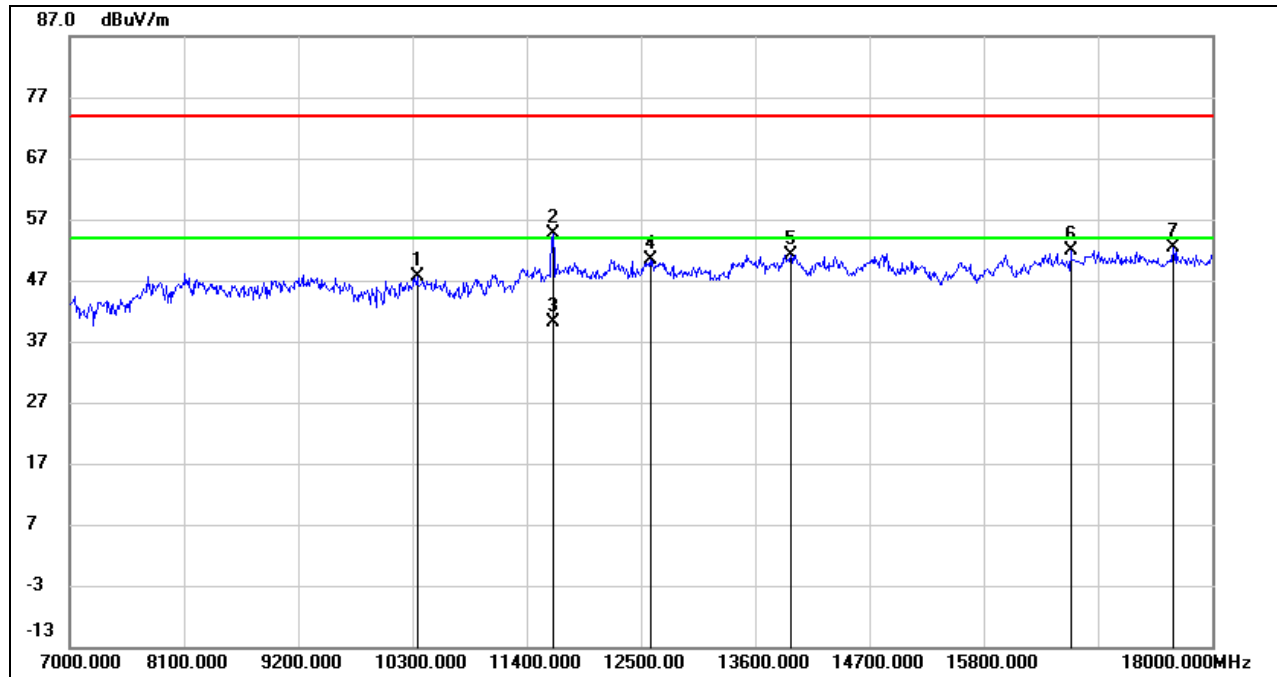
**HARMONICS AND SPURIOUS EMISSIONS (HIGH CHANNEL, VERTICAL)**

No.	Frequency (MHz)	Reading (dBuV)	Correct (dB/m)	Result (dBuV/m)	Limit (dBuV/m)	Margin (dB)	Remark
1	10344.000	35.74	11.99	47.73	74.00	-26.27	peak
2	11653.000	39.65	15.05	54.70	74.00	-19.30	peak
3	11653.000	24.97	15.05	40.02	54.00	-13.98	AVG
4	12588.000	34.58	15.76	50.34	74.00	-23.66	peak
5	13941.000	33.53	17.58	51.11	74.00	-22.89	peak
6	16636.000	31.92	19.99	51.91	74.00	-22.09	peak
7	17626.000	29.54	22.92	52.46	74.00	-21.54	peak

Note: 1. Measurement = Reading Level + Correct Factor.

2. If Peak Result complies with AV limit, AV Result is deemed to comply with AV limit.

3. Peak: Peak detector.

4. AVG: $VBW=1/Ton$, where: Ton is the transmitting duration.

5. For the transmitting duration, please refer to clause 7.1.

6. Filter losses were only considered in the spurious frequency bands and the authorized band was not corrected for High Pass Filter losses.

7. Proper operation of the transmitter prior to adding the filter to the measurement chain.

8. Since non-restricted band peak emissions are less than the average limit, they also comply with the -27dBm/MHz (68.2dBuV/m) limit.

8.3.2. 802.11ac VHT20 CDD 4TX MODE

UNII-1 BAND

HARMONICS AND SPURIOUS EMISSIONS (LOW CHANNEL, HORIZONTAL)

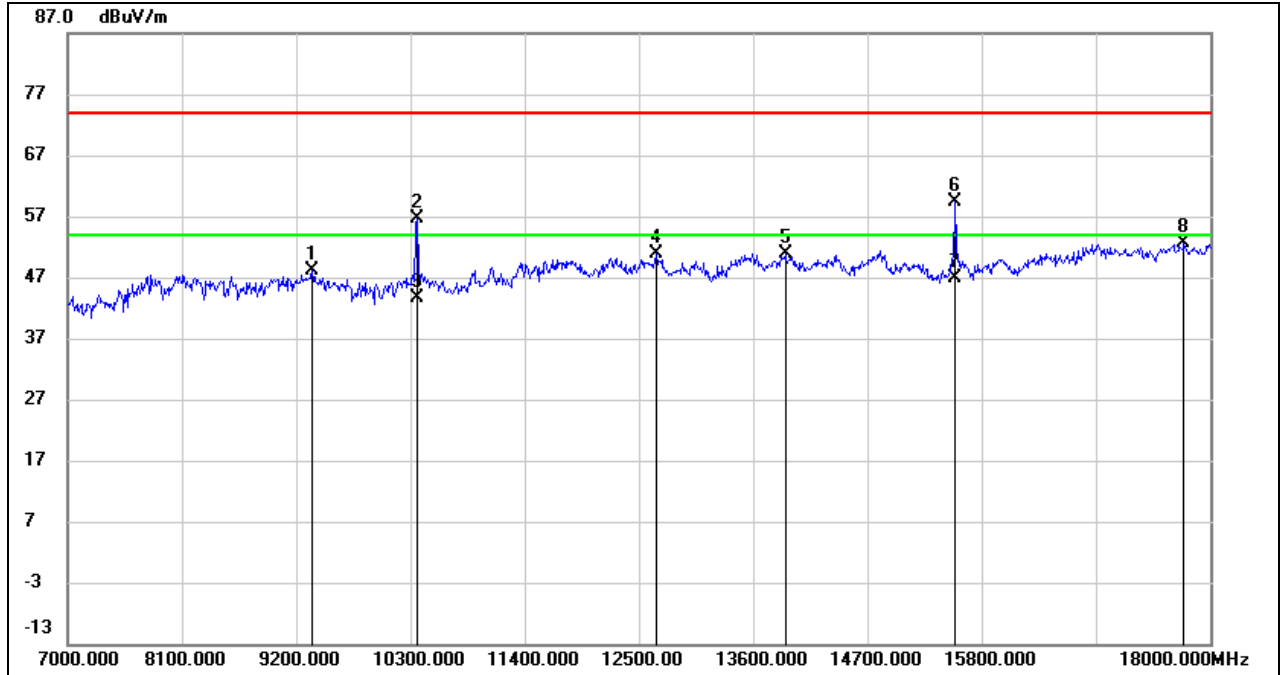

No.	Frequency (MHz)	Reading (dBuV)	Correct (dB/m)	Result (dBuV/m)	Limit (dBuV/m)	Margin (dB)	Remark
1	9354.000	37.31	10.70	48.01	74.00	-25.99	peak
2	10366.000	44.51	12.09	56.60	68.2	-11.60	peak
3	10366.000	31.54	12.09	43.63	/	/	AVG
4	12665.000	35.16	15.68	50.84	74.00	-23.16	peak
5	13908.000	33.40	17.54	50.94	74.00	-23.06	peak
6	15547.000	42.08	17.36	59.44	74.00	-14.56	peak
7	15547.000	29.50	17.36	46.86	54.00	-7.14	AVG
8	17747.000	28.90	23.75	52.65	74.00	-21.35	peak

- Note: 1. Measurement = Reading Level + Correct Factor.
 2. If Peak Result complies with AV limit, AV Result is deemed to comply with AV limit.
 3. Peak: Peak detector.
 4. AVG: $VBW=1/Ton$, where: Ton is the transmitting duration.
 5. For the transmitting duration, please refer to clause 7.1.
 6. Filter losses were only considered in the spurious frequency bands and the authorized band was not corrected for High Pass Filter losses.
 7. Proper operation of the transmitter prior to adding the filter to the measurement chain.
 8. Since non-restricted band peak emissions are less than the average limit, they also comply with the -27dBm/MHz (68.2dBuV/m) limit.



HARMONICS AND SPURIOUS EMISSIONS (LOW CHANNEL, VERTICAL)

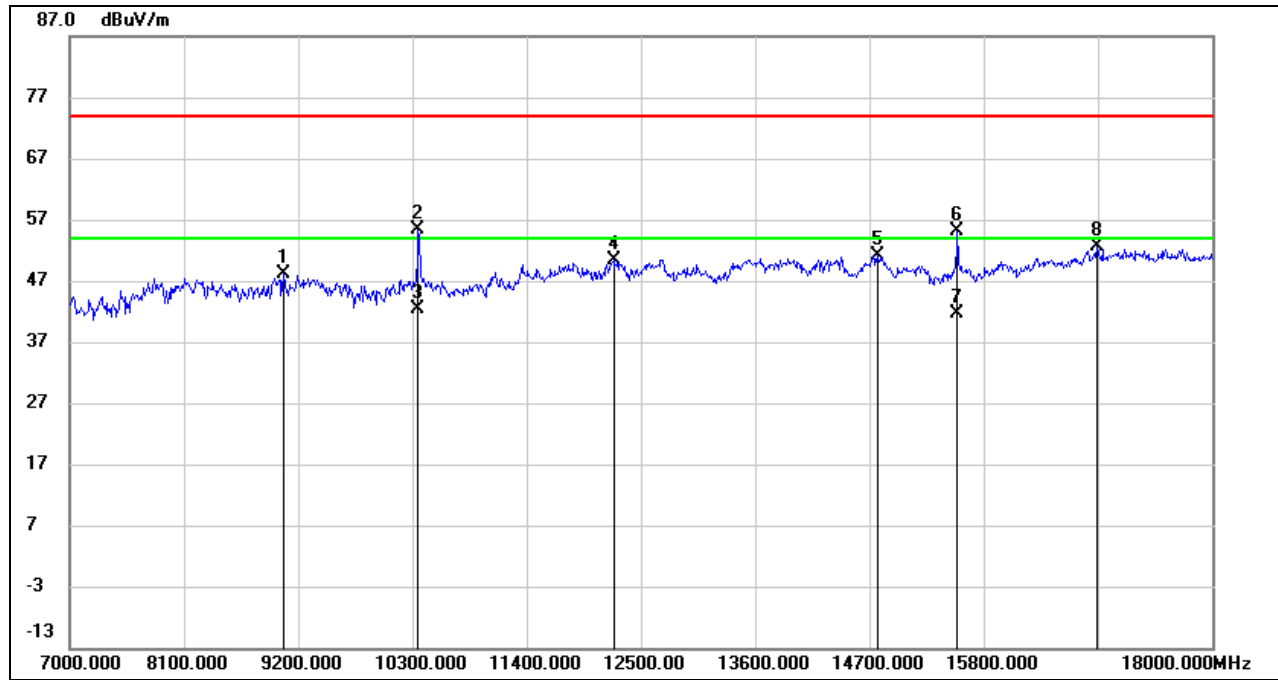

No.	Frequency (MHz)	Reading (dBuV)	Correct (dB/m)	Result (dBuV/m)	Limit (dBuV/m)	Margin (dB)	Remark
1	9057.000	37.57	10.64	48.21	74.00	-25.79	peak
2	10355.000	43.23	12.04	55.27	68.2	-12.93	peak
3	10355.000	30.27	12.04	42.31	/	/	AVG
4	12236.000	34.37	16.01	50.38	74.00	-23.62	peak
5	14777.000	33.13	17.96	51.09	74.00	-22.91	peak
6	15547.000	37.86	17.36	55.22	74.00	-18.78	peak
7	15547.000	24.23	17.36	41.59	54.00	-12.41	AVG
8	16889.000	31.09	21.47	52.56	74.00	-21.44	peak

Note: 1. Measurement = Reading Level + Correct Factor.
 2. If Peak Result complies with AV limit, AV Result is deemed to comply with AV limit.
 3. Peak: Peak detector.
 4. AVG: VBW=1/Ton, where: Ton is the transmitting duration.
 5. For the transmitting duration, please refer to clause 7.1.
 6. Filter losses were only considered in the spurious frequency bands and the authorized band was not corrected for High Pass Filter losses.
 7. Proper operation of the transmitter prior to adding the filter to the measurement chain.
 8. Since non-restricted band peak emissions are less than the average limit, they also comply with the -27dBm/MHz (68.2dBuV/m) limit.

HARMONICS AND SPURIOUS EMISSIONS (MID CHANNEL, HORIZONTAL)

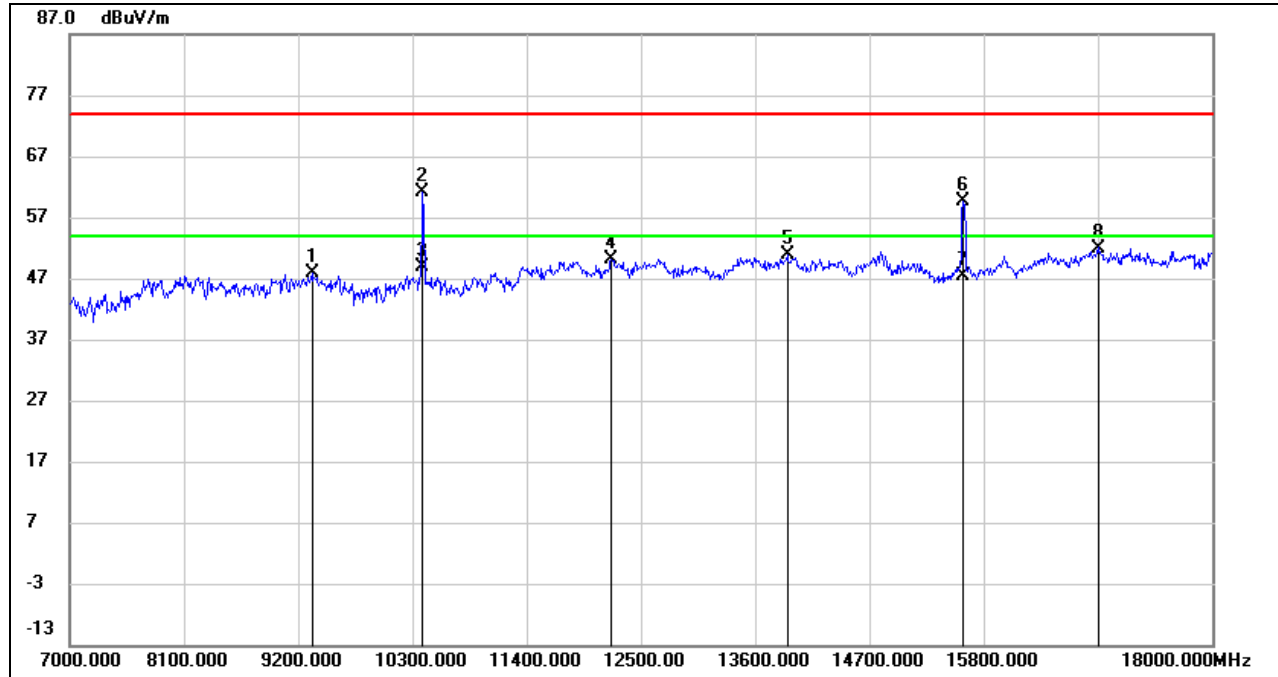

No.	Frequency (MHz)	Reading (dBuV)	Correct (dB/m)	Result (dBuV/m)	Limit (dBuV/m)	Margin (dB)	Remark
1	9332.000	37.21	10.59	47.80	74.00	-26.20	peak
2	10399.000	48.85	12.23	61.08	68.2	-7.12	peak
3	10399.000	36.65	12.23	48.88	/	/	AVG
4	12214.000	34.18	15.97	50.15	74.00	-23.85	peak
5	13908.000	33.27	17.54	50.81	74.00	-23.19	peak
6	15602.000	41.92	17.70	59.62	74.00	-14.38	peak
7	15602.000	29.58	17.70	47.28	54.00	-6.72	AVG
8	16900.000	30.43	21.57	52.00	74.00	-22.00	peak

Note: 1. Measurement = Reading Level + Correct Factor.
 2. If Peak Result complies with AV limit, AV Result is deemed to comply with AV limit.
 3. Peak: Peak detector.
 4. AVG: $VBW=1/Ton$, where: Ton is the transmitting duration.
 5. For the transmitting duration, please refer to clause 7.1.
 6. Filter losses were only considered in the spurious frequency bands and the authorized band was not corrected for High Pass Filter losses.
 7. Proper operation of the transmitter prior to adding the filter to the measurement chain.
 8. Since non-restricted band peak emissions are less than the average limit, they also comply with the -27dBm/MHz (68.2dBuV/m) limit.

HARMONICS AND SPURIOUS EMISSIONS (MID CHANNEL, VERTICAL)

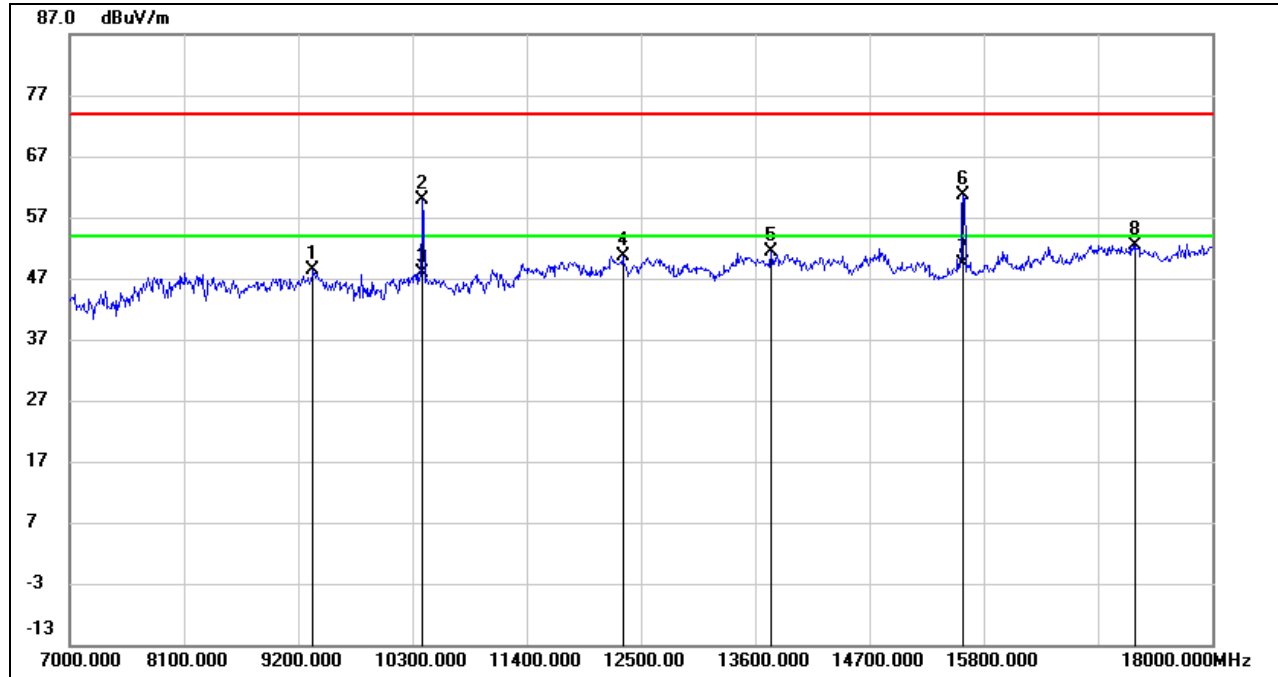

No.	Frequency (MHz)	Reading (dBuV)	Correct (dB/m)	Result (dBuV/m)	Limit (dBuV/m)	Margin (dB)	Remark
1	9343.000	37.63	10.64	48.27	74.00	-25.73	peak
2	10399.000	47.75	12.23	59.98	68.2	-8.22	peak
3	10399.000	35.73	12.23	47.96	/	/	AVG
4	12324.000	34.60	16.05	50.65	74.00	-23.35	peak
5	13754.000	33.76	17.61	51.37	74.00	-22.63	peak
6	15602.000	42.98	17.70	60.68	74.00	-13.32	peak
7	15602.000	31.63	17.70	49.33	54.00	-4.67	AVG
8	17263.000	30.08	22.38	52.46	74.00	-21.54	peak

Note: 1. Measurement = Reading Level + Correct Factor.
 2. If Peak Result complies with AV limit, AV Result is deemed to comply with AV limit.
 3. Peak: Peak detector.
 4. AVG: $VBW=1/Ton$, where: Ton is the transmitting duration.
 5. For the transmitting duration, please refer to clause 7.1.
 6. Filter losses were only considered in the spurious frequency bands and the authorized band was not corrected for High Pass Filter losses.
 7. Proper operation of the transmitter prior to adding the filter to the measurement chain.
 8. Since non-restricted band peak emissions are less than the average limit, they also comply with the -27dBm/MHz (68.2dBuV/m) limit.

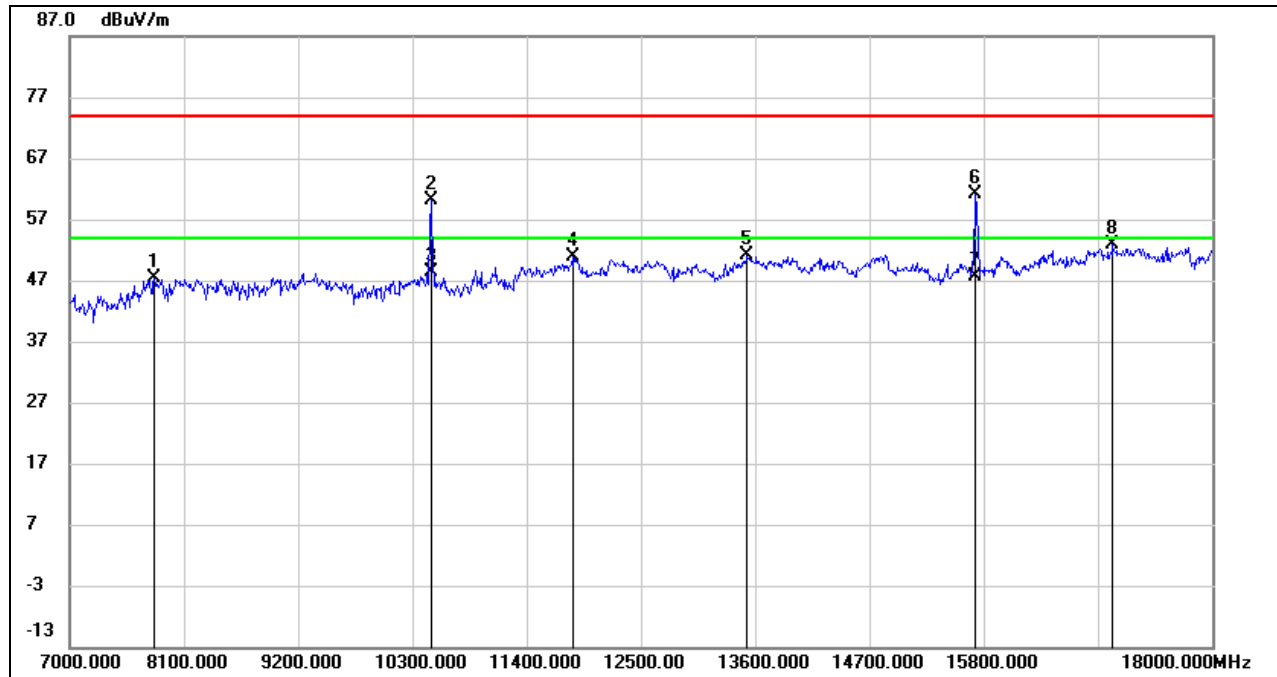
**HARMONICS AND SPURIOUS EMISSIONS (HIGH CHANNEL, HORIZONTAL)**

No.	Frequency (MHz)	Reading (dBuV)	Correct (dB/m)	Result (dBuV/m)	Limit (dBuV/m)	Margin (dB)	Remark
1	7814.000	38.10	9.28	47.38	74.00	-26.62	peak
2	10476.000	47.77	12.33	60.10	68,2	-8.1	peak
3	10476.000	36.17	12.33	48.50	/	/	AVG
4	11840.000	35.48	15.35	50.83	74.00	-23.17	peak
5	13523.000	33.94	17.19	51.13	74.00	-22.87	peak
6	15723.000	43.30	17.86	61.16	74.00	-12.84	peak
7	15723.000	29.77	17.86	47.63	54.00	-6.37	AVG
8	17043.000	31.39	21.52	52.91	74.00	-21.09	peak

Note: 1. Measurement = Reading Level + Correct Factor.

2. If Peak Result complies with AV limit, AV Result is deemed to comply with AV limit.

3. Peak: Peak detector.

4. AVG: $VBW=1/Ton$, where: Ton is the transmitting duration.

5. For the transmitting duration, please refer to clause 7.1.

6. Filter losses were only considered in the spurious frequency bands and the authorized band was not corrected for High Pass Filter losses.

7. Proper operation of the transmitter prior to adding the filter to the measurement chain.

8. Since non-restricted band peak emissions are less than the average limit, they also comply with the -27dBm/MHz (68.2dBuV/m) limit.

HARMONICS AND SPURIOUS EMISSIONS (HIGH CHANNEL, VERTICAL)

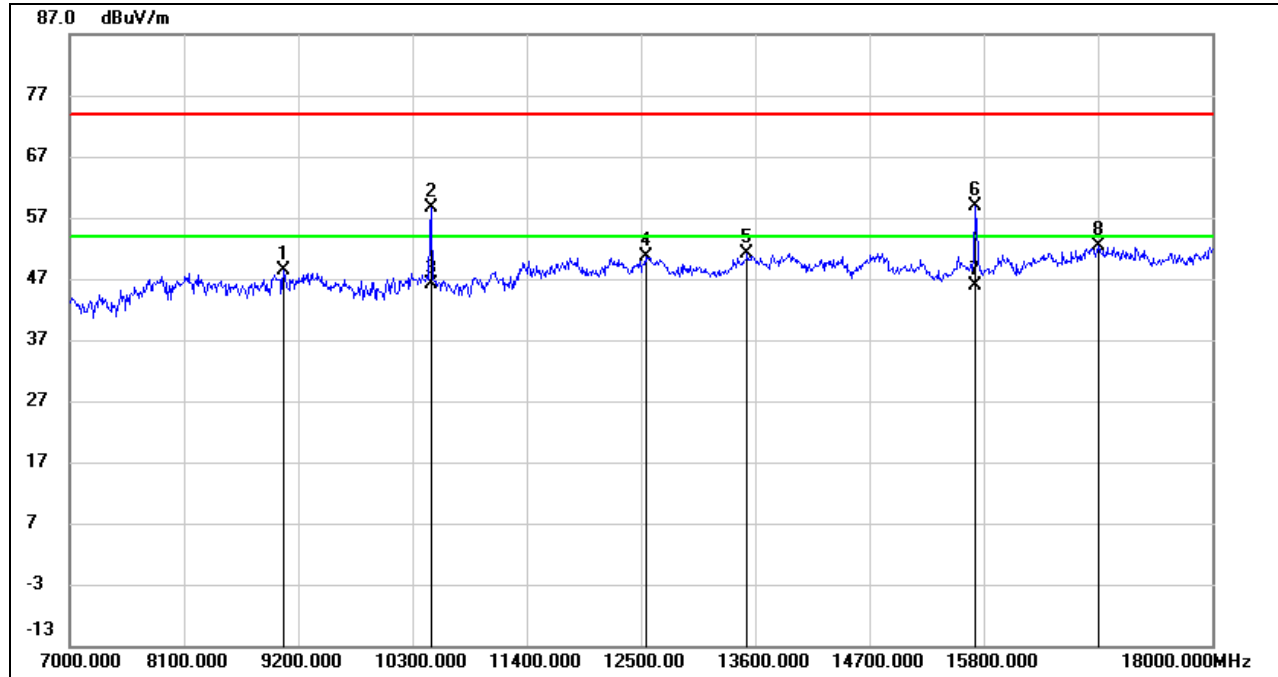

No.	Frequency (MHz)	Reading (dBuV)	Correct (dB/m)	Result (dBuV/m)	Limit (dBuV/m)	Margin (dB)	Remark
1	9057.000	37.73	10.64	48.37	74.00	-25.63	peak
2	10476.000	46.38	12.33	58.71	68.2	-9.49	peak
3	10476.000	33.90	12.33	46.23	/	/	AVG
4	12544.000	34.99	15.72	50.71	74.00	-23.29	peak
5	13523.000	34.03	17.19	51.22	74.00	-22.78	peak
6	15712.000	40.95	17.85	58.80	74.00	-15.20	peak
7	15712.000	28.03	17.85	45.88	54.00	-8.12	AVG
8	16911.000	30.95	21.54	52.49	74.00	-21.51	peak

- Note:
1. Measurement = Reading Level + Correct Factor.
 2. If Peak Result complies with AV limit, AV Result is deemed to comply with AV limit.
 3. Peak: Peak detector.
 4. AVG: VBW=1/Ton, where: Ton is the transmitting duration.
 5. For the transmitting duration, please refer to clause 7.1.
 6. Filter losses were only considered in the spurious frequency bands and the authorized band was not corrected for High Pass Filter losses.
 7. Proper operation of the transmitter prior to adding the filter to the measurement chain.
 8. Since non-restricted band peak emissions are less than the average limit, they also comply with the -27dBm/MHz (68.2dBuV/m) limit.

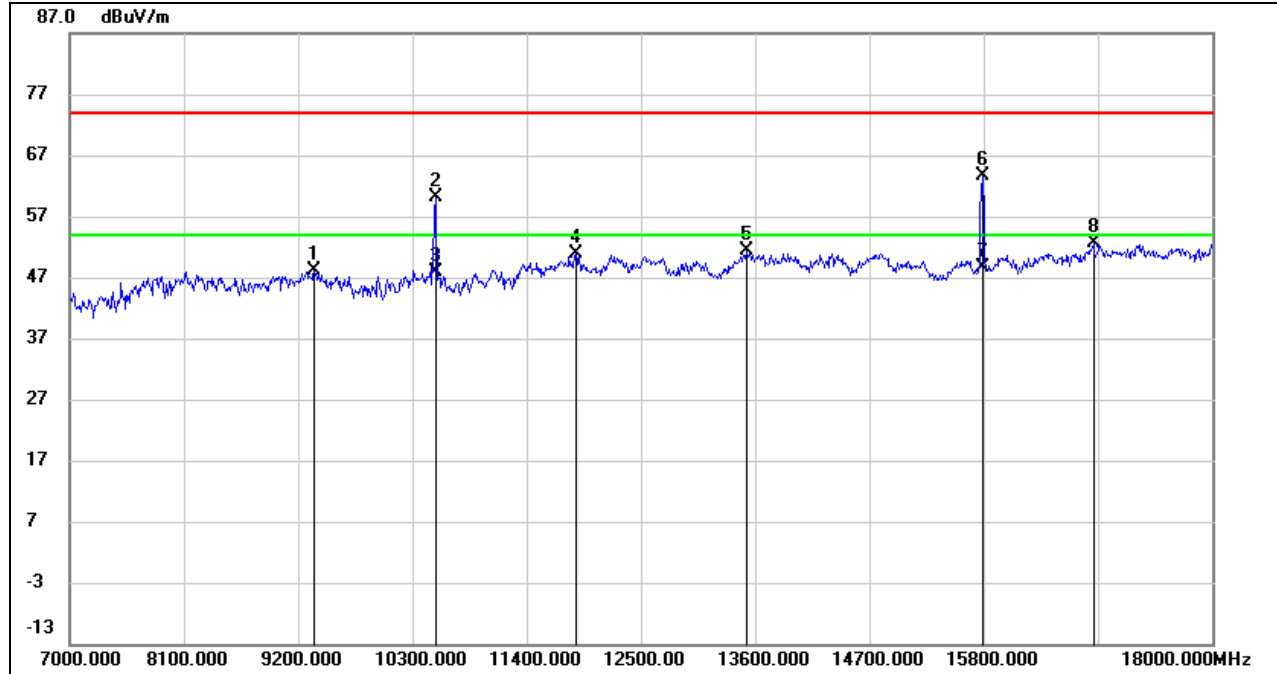
UNII-2A BAND
HARMONICS AND SPURIOUS EMISSIONS (LOW CHANNEL, HORIZONTAL)

No.	Frequency (MHz)	Reading (dBuV)	Correct (dB/m)	Result (dBuV/m)	Limit (dBuV/m)	Margin (dB)	Remark
1	9354.000	37.45	10.70	48.15	74.00	-25.85	peak
2	10520.000	47.72	12.43	60.15	68.2	-8.05	peak
3	10520.000	35.53	12.43	47.96	/	/	AVG
4	11873.000	35.39	15.44	50.83	74.00	-23.17	peak
5	13512.000	34.11	17.20	51.31	74.00	-22.69	peak
6	15789.000	45.71	17.97	63.68	74.00	-10.32	peak
7	15789.000	30.59	17.97	48.56	54.00	-5.44	AVG
8	16856.000	31.32	21.19	52.51	74.00	-21.49	peak

Note: 1. Measurement = Reading Level + Correct Factor.

2. If Peak Result complies with AV limit, AV Result is deemed to comply with AV limit.

3. Peak: Peak detector.

4. AVG: $VBW=1/Ton$, where: Ton is the transmitting duration.

5. For the transmitting duration, please refer to clause 7.1.

6. Filter losses were only considered in the spurious frequency bands and the authorized band was not corrected for High Pass Filter losses.

7. Proper operation of the transmitter prior to adding the filter to the measurement chain.

8. Since non-restricted band peak emissions are less than the average limit, they also comply with the -27dBm/MHz (68.2dBuV/m) limit.

HARMONICS AND SPURIOUS EMISSIONS (LOW CHANNEL, VERTICAL)

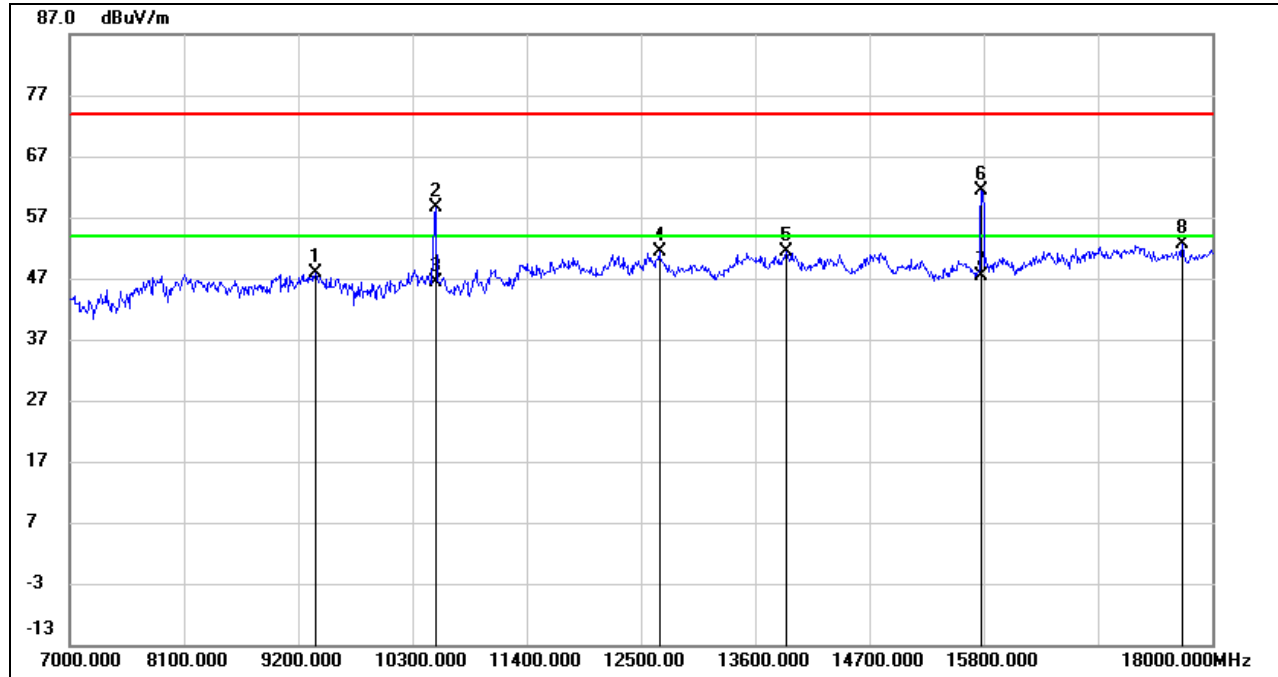

No.	Frequency (MHz)	Reading (dBuV)	Correct (dB/m)	Result (dBuV/m)	Limit (dBuV/m)	Margin (dB)	Remark
1	9365.000	37.05	10.77	47.82	74.00	-26.18	peak
2	10520.000	46.14	12.43	58.57	68.2	-9.63	peak
3	10520.000	33.93	12.43	46.36	/	/	AVG
4	12676.000	35.68	15.66	51.34	74.00	-22.66	peak
5	13897.000	33.77	17.52	51.29	74.00	-22.71	peak
6	15778.000	43.54	17.96	61.50	74.00	-12.50	peak
7	15778.000	29.52	17.96	47.48	54.00	-6.52	AVG
8	17714.000	28.98	23.55	52.53	74.00	-21.47	peak

Note: 1. Measurement = Reading Level + Correct Factor.
 2. If Peak Result complies with AV limit, AV Result is deemed to comply with AV limit.
 3. Peak: Peak detector.
 4. AVG: $VBW=1/Ton$, where: Ton is the transmitting duration.
 5. For the transmitting duration, please refer to clause 7.1.
 6. Filter losses were only considered in the spurious frequency bands and the authorized band was not corrected for High Pass Filter losses.
 7. Proper operation of the transmitter prior to adding the filter to the measurement chain.
 8. Since non-restricted band peak emissions are less than the average limit, they also comply with the -27dBm/MHz (68.2dBuV/m) limit.

HARMONICS AND SPURIOUS EMISSIONS (MID CHANNEL, HORIZONTAL)

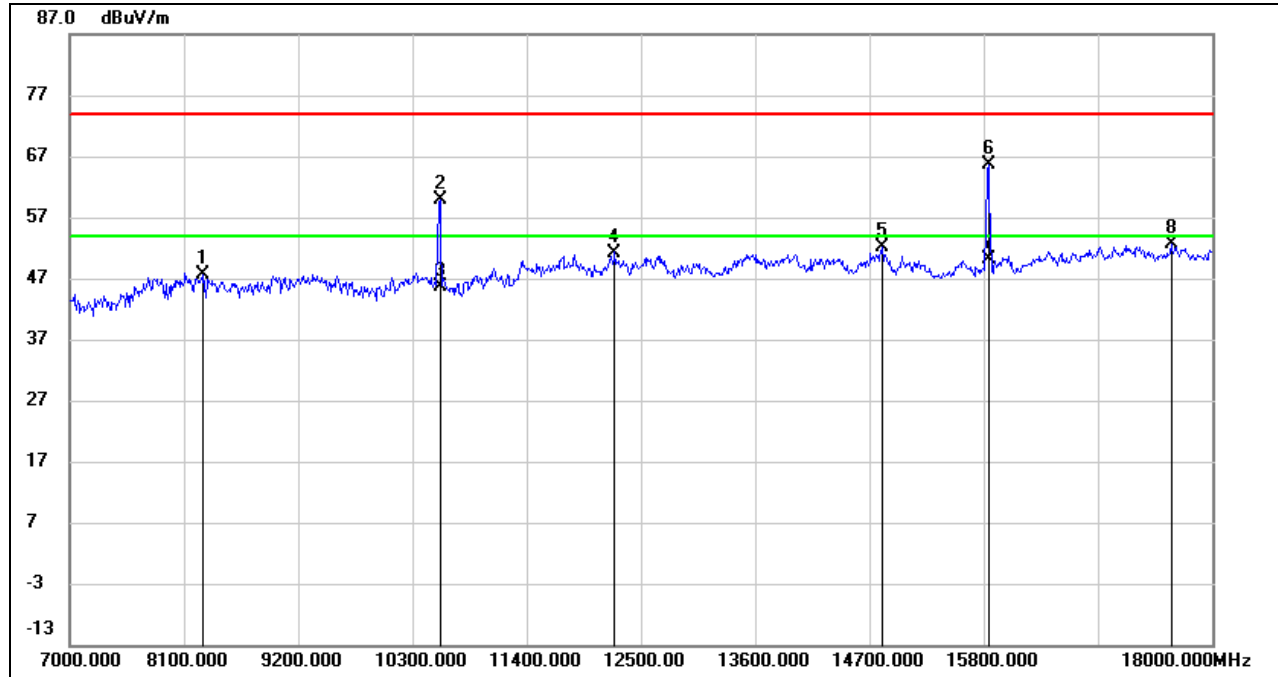

No.	Frequency (MHz)	Reading (dBuV)	Correct (dB/m)	Result (dBuV/m)	Limit (dBuV/m)	Margin (dB)	Remark
1	8287.000	37.85	9.70	47.55	74.00	-26.45	peak
2	10564.000	47.23	12.57	59.80	68.2	-8.4	peak
3	10564.000	33.12	12.57	45.69	/	/	AVG
4	12247.000	35.23	16.02	51.25	74.00	-22.75	peak
5	14821.000	34.12	17.90	52.02	74.00	-21.98	peak
6	15844.000	47.52	18.02	65.54	74.00	-8.46	peak
7	15844.000	32.14	18.02	50.16	54.00	-3.84	AVG
8	17604.000	29.85	22.76	52.61	74.00	-21.39	peak

Note: 1. Measurement = Reading Level + Correct Factor.
 2. If Peak Result complies with AV limit, AV Result is deemed to comply with AV limit.
 3. Peak: Peak detector.
 4. AVG: $VBW=1/Ton$, where: Ton is the transmitting duration.
 5. For the transmitting duration, please refer to clause 7.1.
 6. Filter losses were only considered in the spurious frequency bands and the authorized band was not corrected for High Pass Filter losses.
 7. Proper operation of the transmitter prior to adding the filter to the measurement chain.
 8. Since non-restricted band peak emissions are less than the average limit, they also comply with the -27dBm/MHz (68.2dBuV/m) limit.

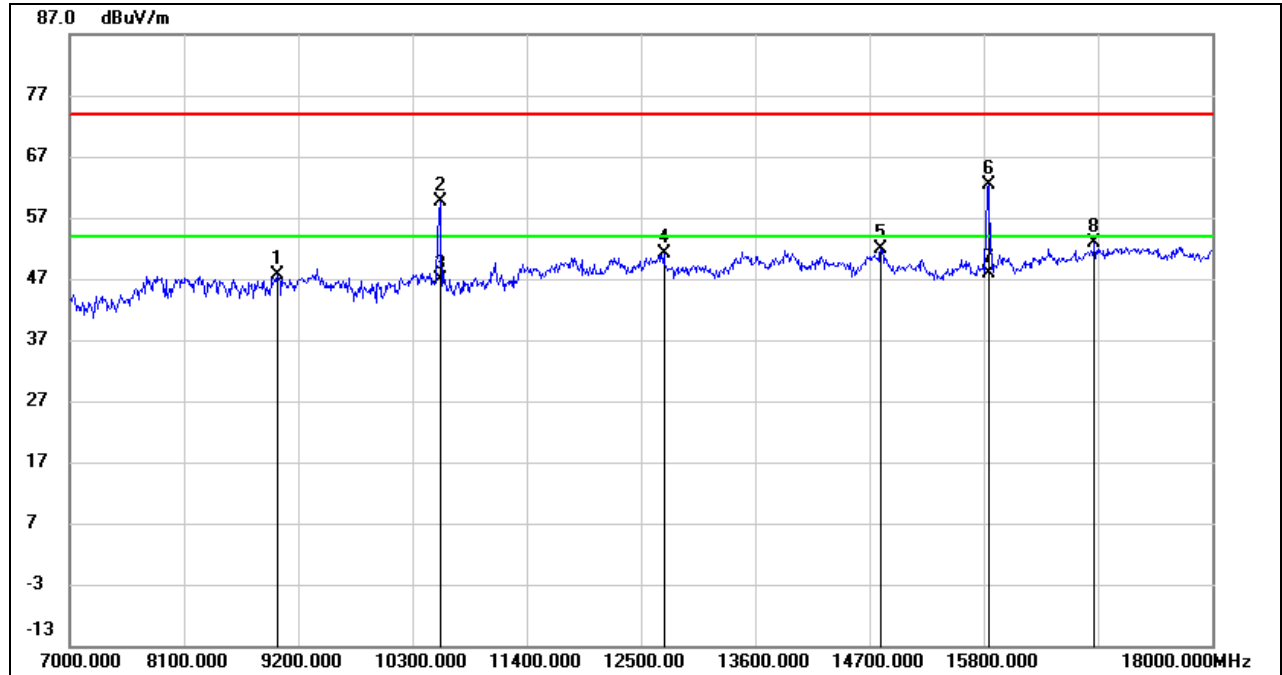
**HARMONICS AND SPURIOUS EMISSIONS (MID CHANNEL, VERTICAL)**

No.	Frequency (MHz)	Reading (dBuV)	Correct (dB/m)	Result (dBuV/m)	Limit (dBuV/m)	Margin (dB)	Remark
1	9002.000	36.50	11.24	47.74	74.00	-26.26	peak
2	10564.000	47.11	12.57	59.68	68.2	-8.52	peak
3	10564.000	34.32	12.57	46.89	/	/	AVG
4	12720.000	35.44	15.70	51.14	74.00	-22.86	peak
5	14810.000	33.96	17.97	51.93	74.00	-22.07	peak
6	15844.000	44.28	18.02	62.30	74.00	-11.70	peak
7	15844.000	29.86	18.02	47.88	54.00	-6.12	AVG
8	16867.000	31.56	21.29	52.85	74.00	-21.15	peak

- Note:
1. Measurement = Reading Level + Correct Factor.
 2. If Peak Result complies with AV limit, AV Result is deemed to comply with AV limit.
 3. Peak: Peak detector.
 4. AVG: VBW=1/Ton, where: Ton is the transmitting duration.
 5. For the transmitting duration, please refer to clause 7.1.
 6. Filter losses were only considered in the spurious frequency bands and the authorized band was not corrected for High Pass Filter losses.
 7. Proper operation of the transmitter prior to adding the filter to the measurement chain.
 8. Since non-restricted band peak emissions are less than the average limit, they also comply with the -27dBm/MHz (68.2dBuV/m) limit.

HARMONICS AND SPURIOUS EMISSIONS (HIGH CHANNEL, HORIZONTAL)

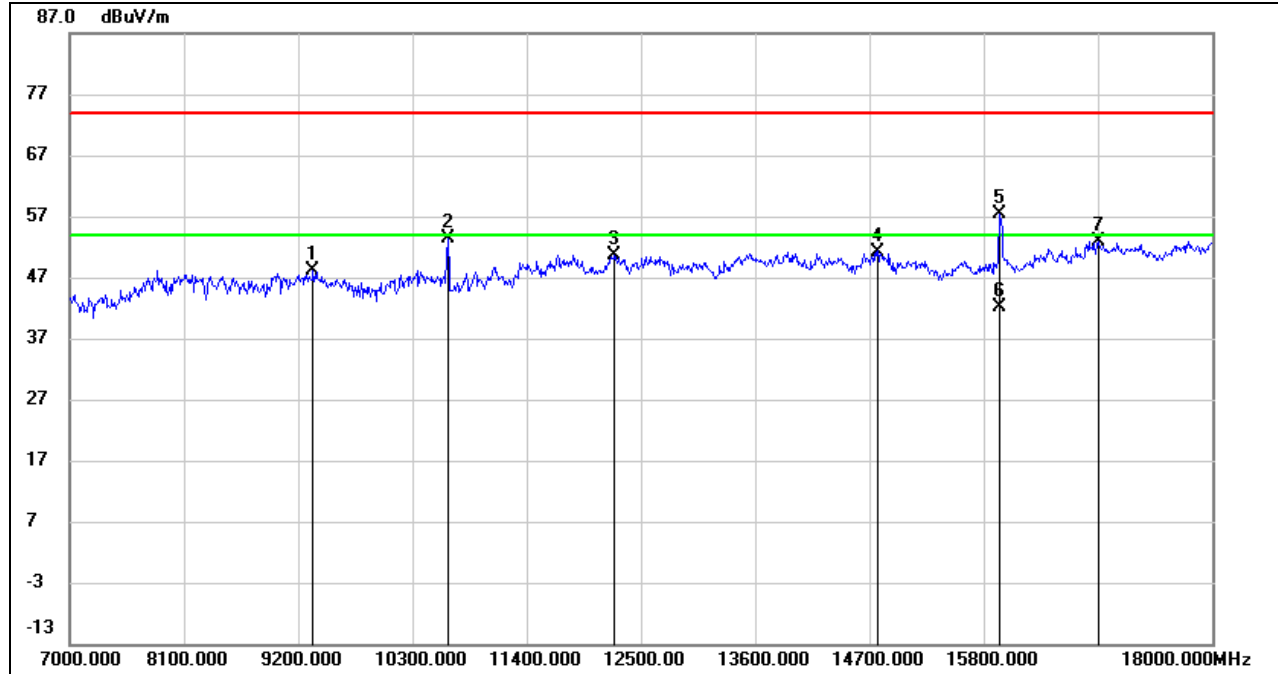

No.	Frequency (MHz)	Reading (dBuV)	Correct (dB/m)	Result (dBuV/m)	Limit (dBuV/m)	Margin (dB)	Remark
1	9343.000	37.50	10.64	48.14	74.00	-25.86	peak
2	10641.000	40.55	12.77	53.32	74.00	-20.68	peak
3	12247.000	34.70	16.02	50.72	74.00	-23.28	peak
4	14777.000	33.29	17.96	51.25	74.00	-22.75	peak
5	15954.000	39.19	18.26	57.45	74.00	-16.55	peak
6	15954.000	23.82	18.26	42.08	54.00	-11.92	AVG
7	16900.000	31.42	21.57	52.99	74.00	-21.01	peak

- Note:
1. Measurement = Reading Level + Correct Factor.
 2. If Peak Result complies with AV limit, AV Result is deemed to comply with AV limit.
 3. Peak: Peak detector.
 4. AVG: VBW=1/Ton, where: Ton is the transmitting duration.
 5. For the transmitting duration, please refer to clause 7.1.
 6. Filter losses were only considered in the spurious frequency bands and the authorized band was not corrected for High Pass Filter losses.
 7. Proper operation of the transmitter prior to adding the filter to the measurement chain.
 8. Since non-restricted band peak emissions are less than the average limit, they also comply with the -27dBm/MHz (68.2dBuV/m) limit.

HARMONICS AND SPURIOUS EMISSIONS (HIGH CHANNEL, VERTICAL)

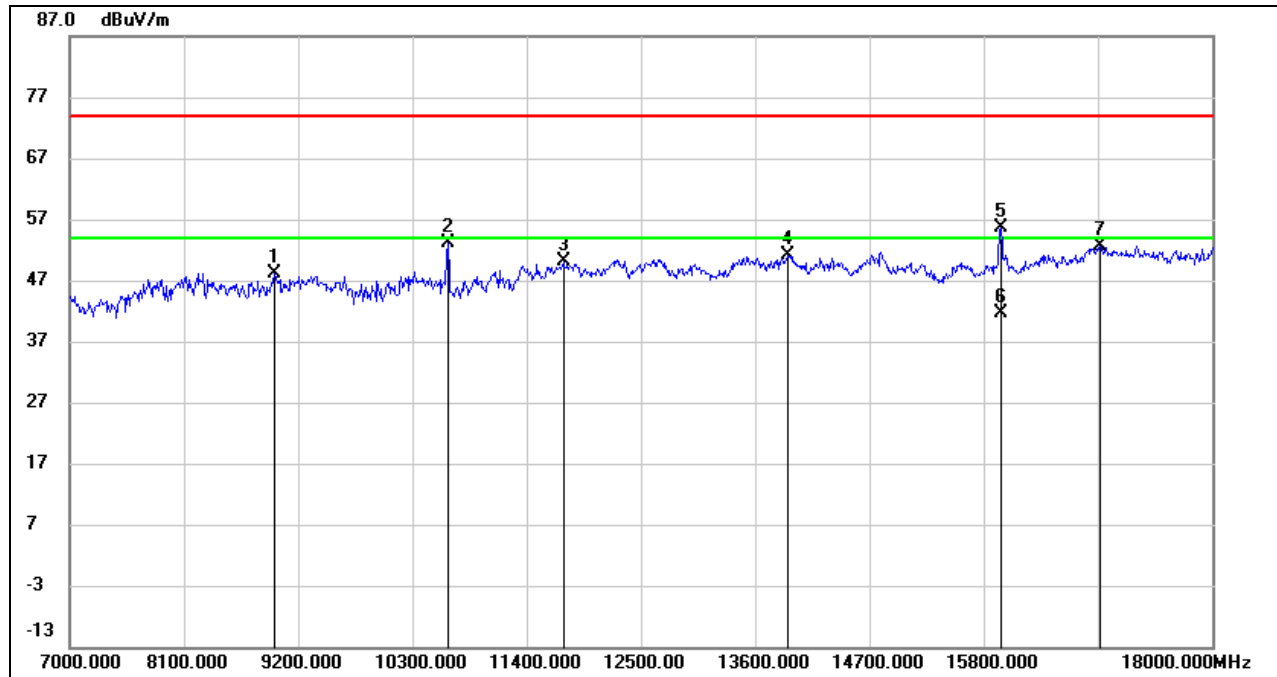

No.	Frequency (MHz)	Reading (dBuV)	Correct (dB/m)	Result (dBuV/m)	Limit (dBuV/m)	Margin (dB)	Remark
1	8969.000	37.36	10.69	48.05	74.00	-25.95	peak
2	10641.000	40.45	12.77	53.22	74.00	-20.78	peak
3	11752.000	34.92	15.29	50.21	74.00	-23.79	peak
4	13919.000	33.57	17.55	51.12	74.00	-22.88	peak
5	15965.000	37.40	18.29	55.69	74.00	-18.31	peak
6	15965.000	23.22	18.29	41.51	54.00	-12.49	AVG
7	16922.000	31.22	21.49	52.71	74.00	-21.29	peak

- Note:
1. Measurement = Reading Level + Correct Factor.
 2. If Peak Result complies with AV limit, AV Result is deemed to comply with AV limit.
 3. Peak: Peak detector.
 4. AVG: $VBW=1/Ton$, where: Ton is the transmitting duration.
 5. For the transmitting duration, please refer to clause 7.1.
 6. Filter losses were only considered in the spurious frequency bands and the authorized band was not corrected for High Pass Filter losses.
 7. Proper operation of the transmitter prior to adding the filter to the measurement chain.
 8. Since non-restricted band peak emissions are less than the average limit, they also comply with the $-27dBm/MHz$ ($68.2dBuV/m$) limit.

UNII-2C BAND

HARMONICS AND SPURIOUS EMISSIONS (LOW CHANNEL, HORIZONTAL)

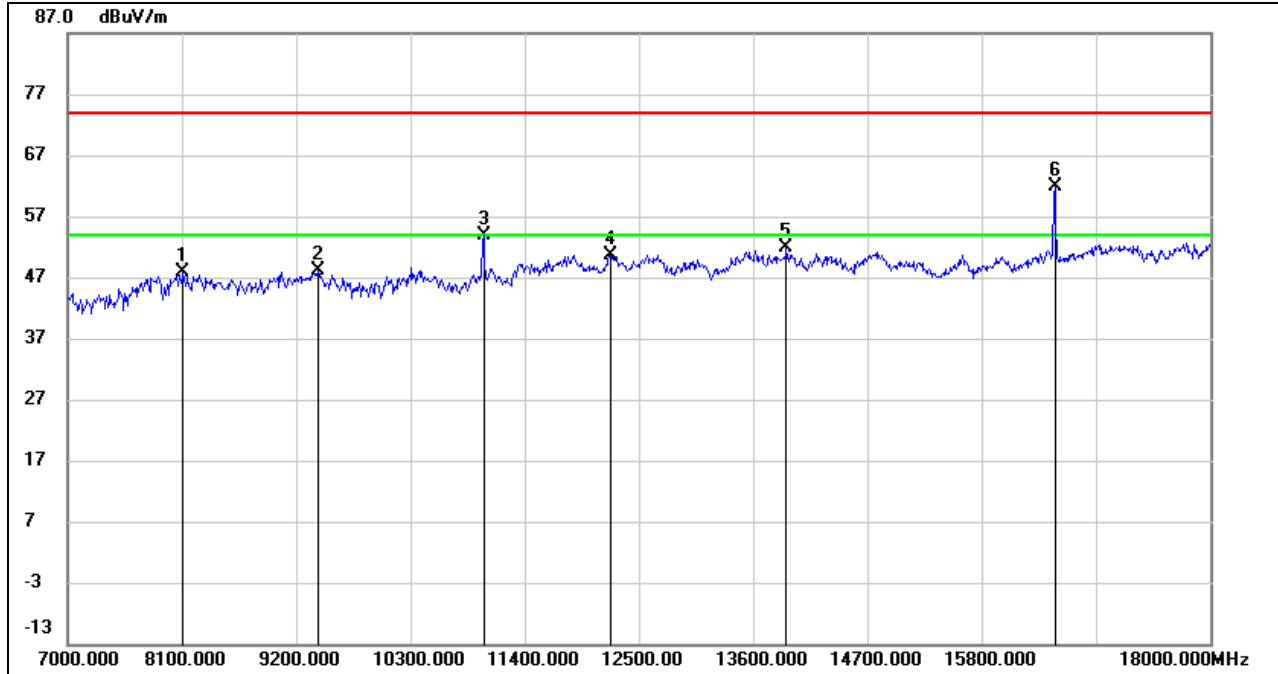

No.	Frequency (MHz)	Reading (dBuV)	Correct (dB/m)	Result (dBuV/m)	Limit (dBuV/m)	Margin (dB)	Remark
1	8111.000	37.69	10.14	47.83	74.00	-26.17	peak
2	9409.000	37.23	10.94	48.17	74.00	-25.83	peak
3	11004.000	40.56	13.32	53.88	74.00	-20.12	peak
4	12225.000	34.74	15.99	50.73	74.00	-23.27	peak
5	13919.000	34.44	17.55	51.99	74.00	-22.01	peak
6	16504.000	42.14	19.70	61.84	68.2	-6.36	peak

- Note:
1. Measurement = Reading Level + Correct Factor.
 2. If Peak Result complies with AV limit, AV Result is deemed to comply with AV limit.
 3. Peak: Peak detector.
 4. AVG: $VBW=1/Ton$, where: Ton is the transmitting duration.
 5. For the transmitting duration, please refer to clause 7.1.
 6. Filter losses were only considered in the spurious frequency bands and the authorized band was not corrected for High Pass Filter losses.
 7. Proper operation of the transmitter prior to adding the filter to the measurement chain.
 8. Since non-restricted band peak emissions are less than the average limit, they also comply with the -27dBm/MHz (68.2dBuV/m) limit.

HARMONICS AND SPURIOUS EMISSIONS (LOW CHANNEL, VERTICAL)

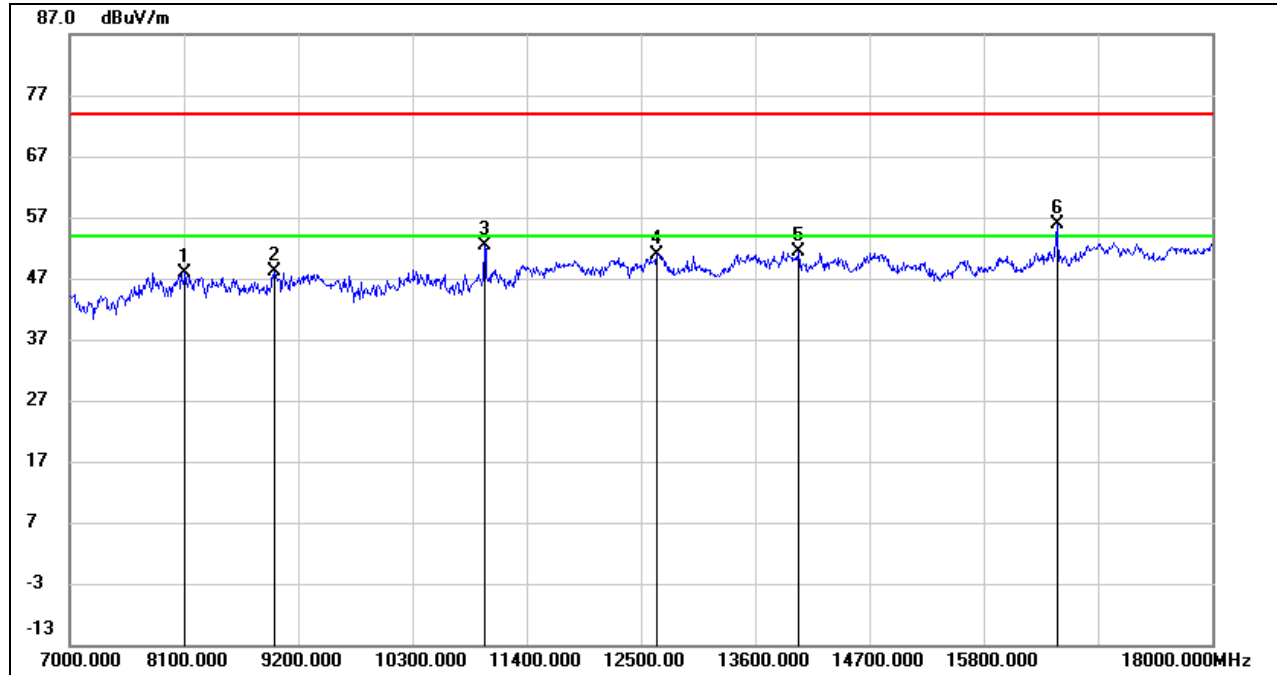

No.	Frequency (MHz)	Reading (dBuV)	Correct (dB/m)	Result (dBuV/m)	Limit (dBuV/m)	Margin (dB)	Remark
1	8111.000	37.86	10.14	48.00	74.00	-26.00	peak
2	8969.000	37.52	10.69	48.21	74.00	-25.79	peak
3	10993.000	39.16	13.31	52.47	74.00	-21.53	peak
4	12654.000	35.28	15.69	50.97	74.00	-23.03	peak
5	14018.000	33.66	17.63	51.29	74.00	-22.71	peak
6	16504.000	36.30	19.70	56.00	68.2	-12.2	peak

Note: 1. Measurement = Reading Level + Correct Factor.

2. If Peak Result complies with AV limit, AV Result is deemed to comply with AV limit.

3. Peak: Peak detector.

4. AVG: $VBW=1/Ton$, where: Ton is the transmitting duration.

5. For the transmitting duration, please refer to clause 7.1.

6. Filter losses were only considered in the spurious frequency bands and the authorized band was not corrected for High Pass Filter losses.

7. Proper operation of the transmitter prior to adding the filter to the measurement chain.

8. Since non-restricted band peak emissions are less than the average limit, they also comply with the -27dBm/MHz (68.2dBuV/m) limit.

HARMONICS AND SPURIOUS EMISSIONS (MID CHANNEL, HORIZONTAL)

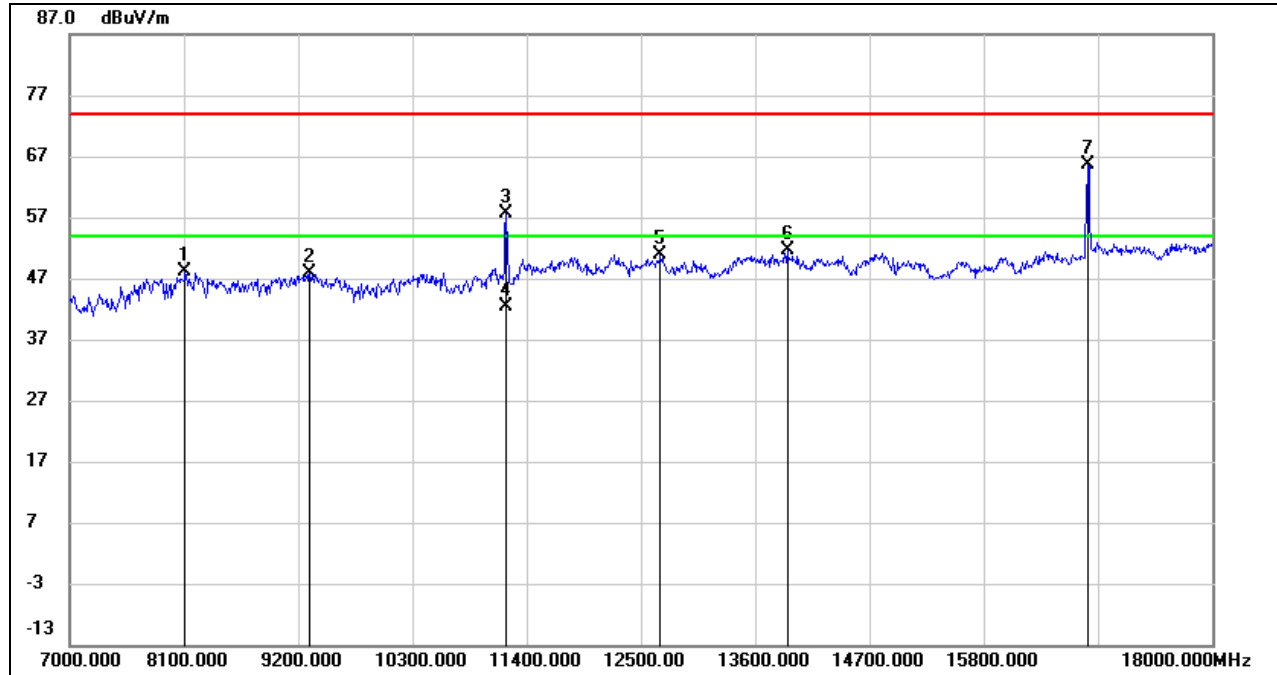

No.	Frequency (MHz)	Reading (dBuV)	Correct (dB/m)	Result (dBuV/m)	Limit (dBuV/m)	Margin (dB)	Remark
1	8111.000	38.00	10.14	48.14	74.00	-25.86	peak
2	9310.000	37.31	10.46	47.77	74.00	-26.23	peak
3	11202.000	43.80	13.79	57.59	74.00	-16.41	peak
4	11202.000	28.49	13.79	42.28	54.00	-11.72	AVG
5	12687.000	35.33	15.64	50.97	74.00	-23.03	peak
6	13908.000	33.99	17.54	51.53	74.00	-22.47	peak
7	16801.000	44.99	20.72	65.71	68.2	-2.49	peak

Note: 1. Measurement = Reading Level + Correct Factor.

2. If Peak Result complies with AV limit, AV Result is deemed to comply with AV limit.

3. Peak: Peak detector.

4. AVG: $VBW=1/Ton$, where: Ton is the transmitting duration.

5. For the transmitting duration, please refer to clause 7.1.

6. Filter losses were only considered in the spurious frequency bands and the authorized band was not corrected for High Pass Filter losses.

7. Proper operation of the transmitter prior to adding the filter to the measurement chain.

8. Since non-restricted band peak emissions are less than the average limit, they also comply with the -27dBm/MHz (68.2dBuV/m) limit.

HARMONICS AND SPURIOUS EMISSIONS (MID CHANNEL, VERTICAL)

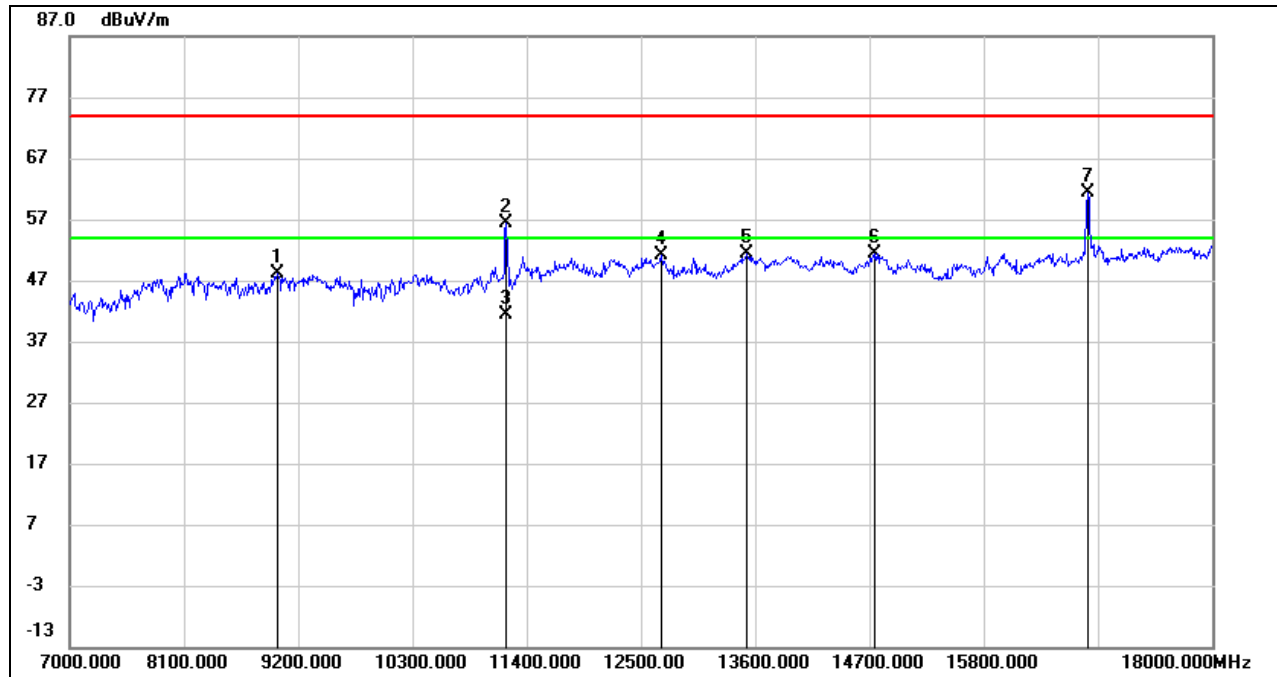

No.	Frequency (MHz)	Reading (dBuV)	Correct (dB/m)	Result (dBuV/m)	Limit (dBuV/m)	Margin (dB)	Remark
1	9002.000	36.85	11.24	48.09	74.00	-25.91	peak
2	11202.000	42.57	13.79	56.36	74.00	-17.64	peak
3	11202.000	27.57	13.79	41.36	54.00	-12.64	AVG
4	12698.000	35.58	15.62	51.20	74.00	-22.80	peak
5	13512.000	34.18	17.20	51.38	74.00	-22.62	peak
6	14744.000	33.62	17.84	51.46	74.00	-22.54	peak
7	16801.000	40.77	20.72	61.49	68.2	-6.71	peak

Note: 1. Measurement = Reading Level + Correct Factor.

2. If Peak Result complies with AV limit, AV Result is deemed to comply with AV limit.

3. Peak: Peak detector.

4. AVG: $VBW=1/Ton$, where: Ton is the transmitting duration.

5. For the transmitting duration, please refer to clause 7.1.

6. Filter losses were only considered in the spurious frequency bands and the authorized band was not corrected for High Pass Filter losses.

7. Proper operation of the transmitter prior to adding the filter to the measurement chain.

8. Since non-restricted band peak emissions are less than the average limit, they also comply with the -27dBm/MHz (68.2dBuV/m) limit.

HARMONICS AND SPURIOUS EMISSIONS (HIGH CHANNEL, HORIZONTAL)

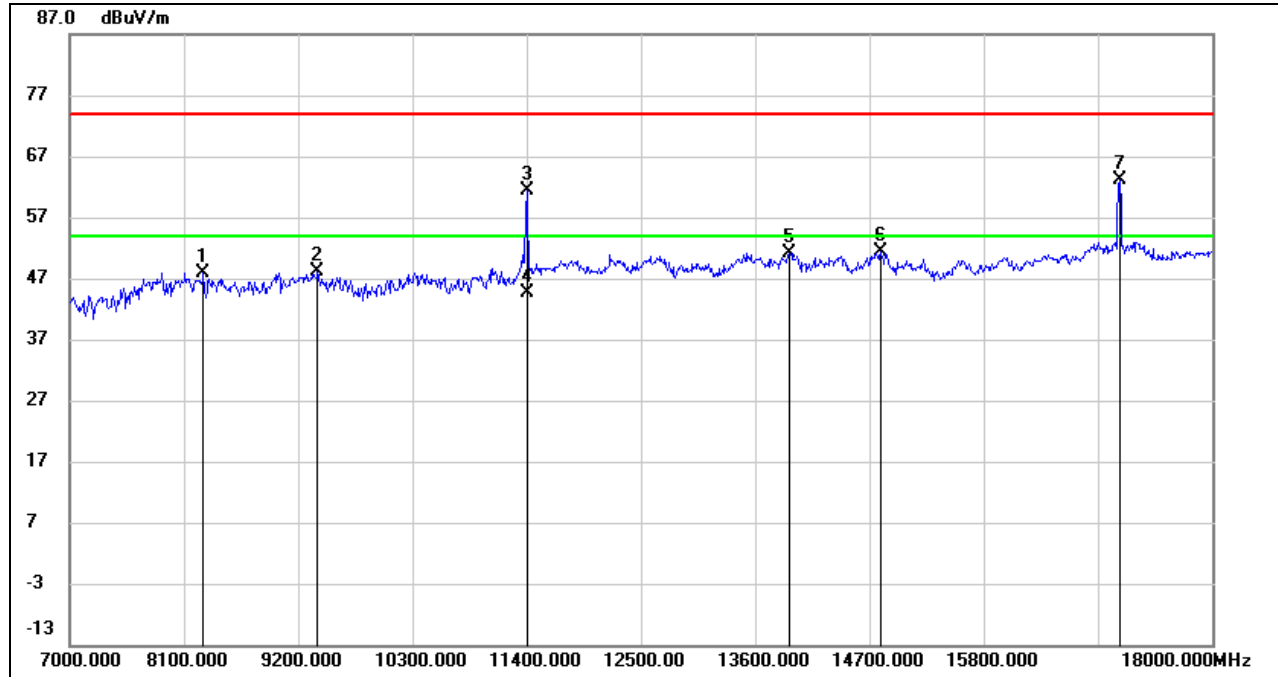

No.	Frequency (MHz)	Reading (dBuV)	Correct (dB/m)	Result (dBuV/m)	Limit (dBuV/m)	Margin (dB)	Remark
1	8287.000	38.21	9.70	47.91	74.00	-26.09	peak
2	9387.000	37.24	10.89	48.13	74.00	-25.87	peak
3	11400.000	46.53	14.76	61.29	74.00	-12.71	peak
4	11400.000	29.83	14.76	44.59	54.00	-9.41	AVG
5	13930.000	33.55	17.57	51.12	74.00	-22.88	peak
6	14810.000	33.45	17.97	51.42	74.00	-22.58	peak
7	17109.000	41.10	21.91	63.01	68.2	-5.19	peak

- Note: 1. Measurement = Reading Level + Correct Factor.
 2. If Peak Result complies with AV limit, AV Result is deemed to comply with AV limit.
 3. Peak: Peak detector.
 4. AVG: $VBW=1/Ton$, where: Ton is the transmitting duration.
 5. For the transmitting duration, please refer to clause 7.1.
 6. Filter losses were only considered in the spurious frequency bands and the authorized band was not corrected for High Pass Filter losses.
 7. Proper operation of the transmitter prior to adding the filter to the measurement chain.
 8. Since non-restricted band peak emissions are less than the average limit, they also comply with the -27dBm/MHz (68.2dBuV/m) limit.

HARMONICS AND SPURIOUS EMISSIONS (HIGH CHANNEL, VERTICAL)

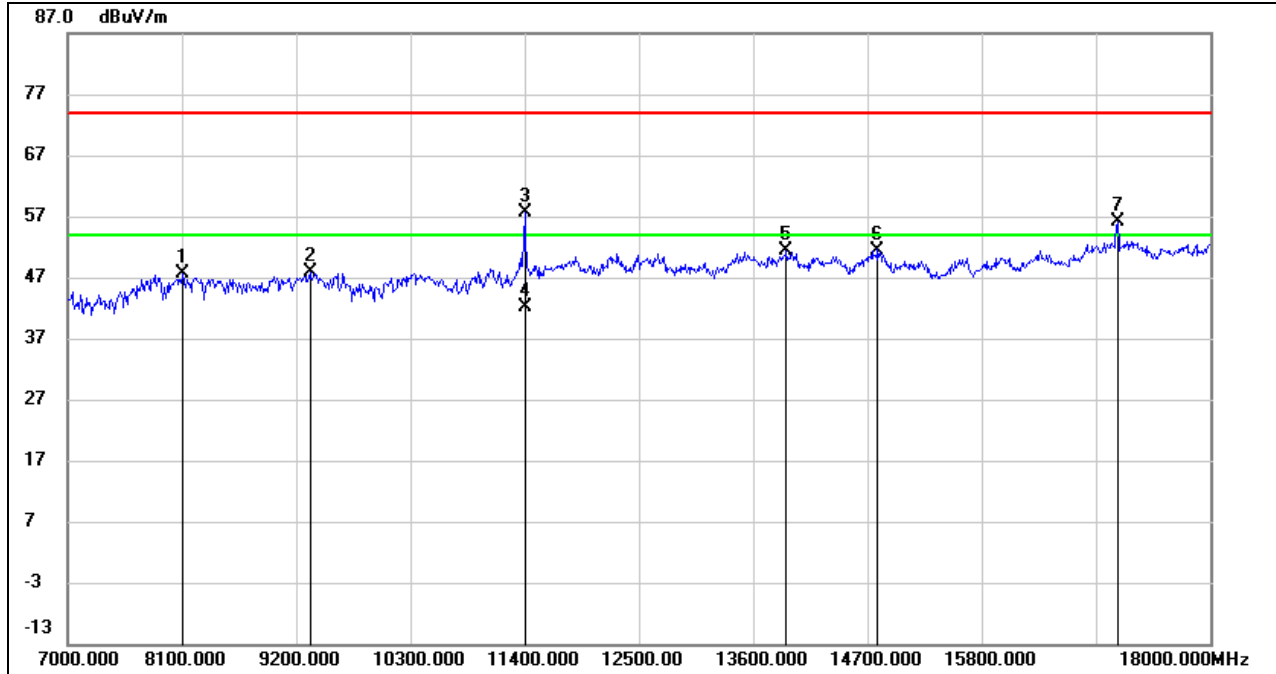

No.	Frequency (MHz)	Reading (dBuV)	Correct (dB/m)	Result (dBuV/m)	Limit (dBuV/m)	Margin (dB)	Remark
1	8111.000	37.58	10.14	47.72	74.00	-26.28	peak
2	9332.000	37.17	10.59	47.76	74.00	-26.24	peak
3	11400.000	42.87	14.76	57.63	74.00	-16.37	peak
4	11400.000	27.40	14.76	42.16	54.00	-11.84	AVG
5	13919.000	33.89	17.55	51.44	74.00	-22.56	peak
6	14799.000	33.46	18.04	51.50	74.00	-22.50	peak
7	17109.000	34.24	21.91	56.15	68.2	-12.05	peak

- Note:
1. Measurement = Reading Level + Correct Factor.
 2. If Peak Result complies with AV limit, AV Result is deemed to comply with AV limit.
 3. Peak: Peak detector.
 4. AVG: $VBW=1/T_{on}$, where: T_{on} is the transmitting duration.
 5. For the transmitting duration, please refer to clause 7.1.
 6. Filter losses were only considered in the spurious frequency bands and the authorized band was not corrected for High Pass Filter losses.
 7. Proper operation of the transmitter prior to adding the filter to the measurement chain.
 8. Since non-restricted band peak emissions are less than the average limit, they also comply with the -27dBm/MHz (68.2dBuV/m) limit.

UNII-3 BAND

HARMONICS AND SPURIOUS EMISSIONS (LOW CHANNEL, HORIZONTAL)

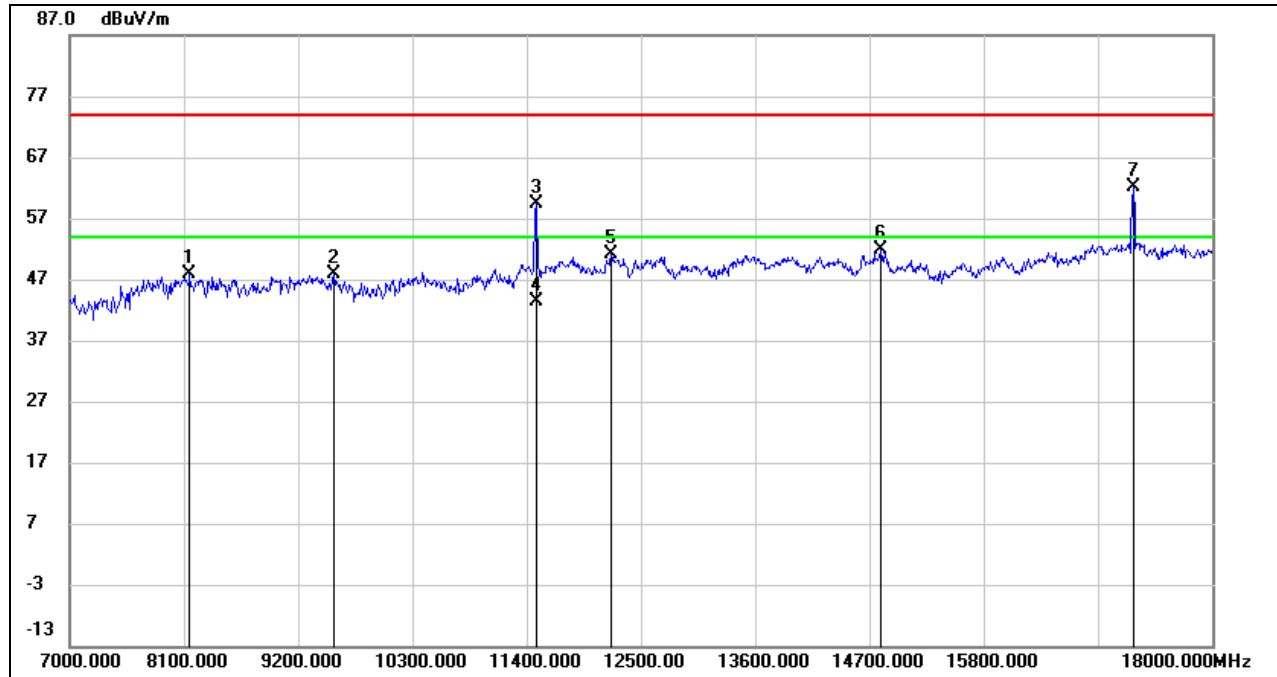

No.	Frequency (MHz)	Reading (dBuV)	Correct (dB/m)	Result (dBuV/m)	Limit (dBuV/m)	Margin (dB)	Remark
1	8155.000	37.86	9.98	47.84	74.00	-26.16	peak
2	9541.000	37.11	10.73	47.84	74.00	-26.16	peak
3	11488.000	44.64	14.66	59.30	74.00	-14.70	peak
4	11488.000	28.60	14.66	43.26	54.00	-10.74	AVG
5	12214.000	35.17	15.97	51.14	74.00	-22.86	peak
6	14810.000	33.98	17.97	51.95	74.00	-22.05	peak
7	17241.000	39.81	22.24	62.05	68.2	-6.15	peak

- Note: 1. Measurement = Reading Level + Correct Factor.
 2. If Peak Result complies with AV limit, AV Result is deemed to comply with AV limit.
 3. Peak: Peak detector.
 4. AVG: $VBW=1/Ton$, where: Ton is the transmitting duration.
 5. For the transmitting duration, please refer to clause 7.1.
 6. Filter losses were only considered in the spurious frequency bands and the authorized band was not corrected for High Pass Filter losses.
 7. Proper operation of the transmitter prior to adding the filter to the measurement chain.
 8. Since non-restricted band peak emissions are less than the average limit, they also comply with the -27dBm/MHz (68.2dBuV/m) limit.

HARMONICS AND SPURIOUS EMISSIONS (LOW CHANNEL, VERTICAL)

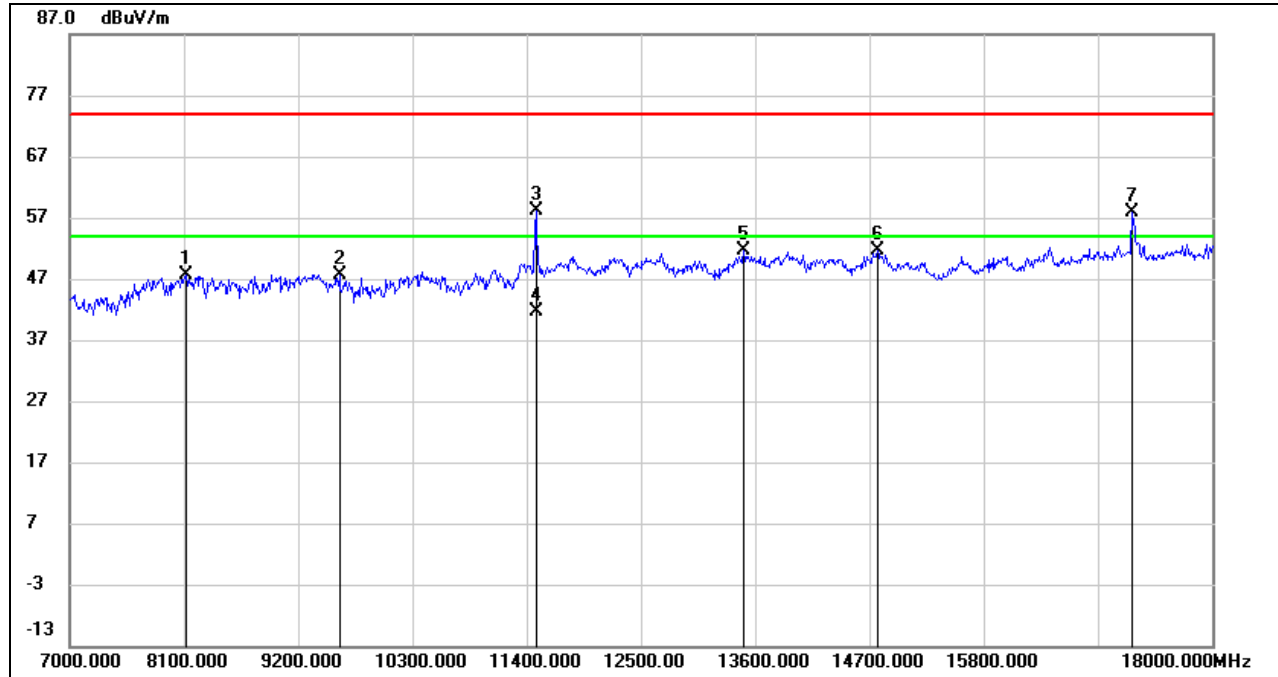

No.	Frequency (MHz)	Reading (dBuV)	Correct (dB/m)	Result (dBuV/m)	Limit (dBuV/m)	Margin (dB)	Remark
1	8122.000	37.46	10.10	47.56	74.00	-26.44	peak
2	9596.000	36.62	11.01	47.63	74.00	-26.37	peak
3	11488.000	43.57	14.66	58.23	74.00	-15.77	peak
4	11488.000	27.06	14.66	41.72	54.00	-12.28	AVG
5	13490.000	34.32	17.20	51.52	74.00	-22.48	peak
6	14777.000	33.75	17.96	51.71	74.00	-22.29	peak
7	17230.000	35.76	22.17	57.93	68.2	-10.27	peak

- Note:
1. Measurement = Reading Level + Correct Factor.
 2. If Peak Result complies with AV limit, AV Result is deemed to comply with AV limit.
 3. Peak: Peak detector.
 4. AVG: $VBW=1/Ton$, where: Ton is the transmitting duration.
 5. For the transmitting duration, please refer to clause 7.1.
 6. Filter losses were only considered in the spurious frequency bands and the authorized band was not corrected for High Pass Filter losses.
 7. Proper operation of the transmitter prior to adding the filter to the measurement chain.
 8. Since non-restricted band peak emissions are less than the average limit, they also comply with the -27dBm/MHz (68.2dBuV/m) limit.

HARMONICS AND SPURIOUS EMISSIONS (MID CHANNEL, HORIZONTAL)

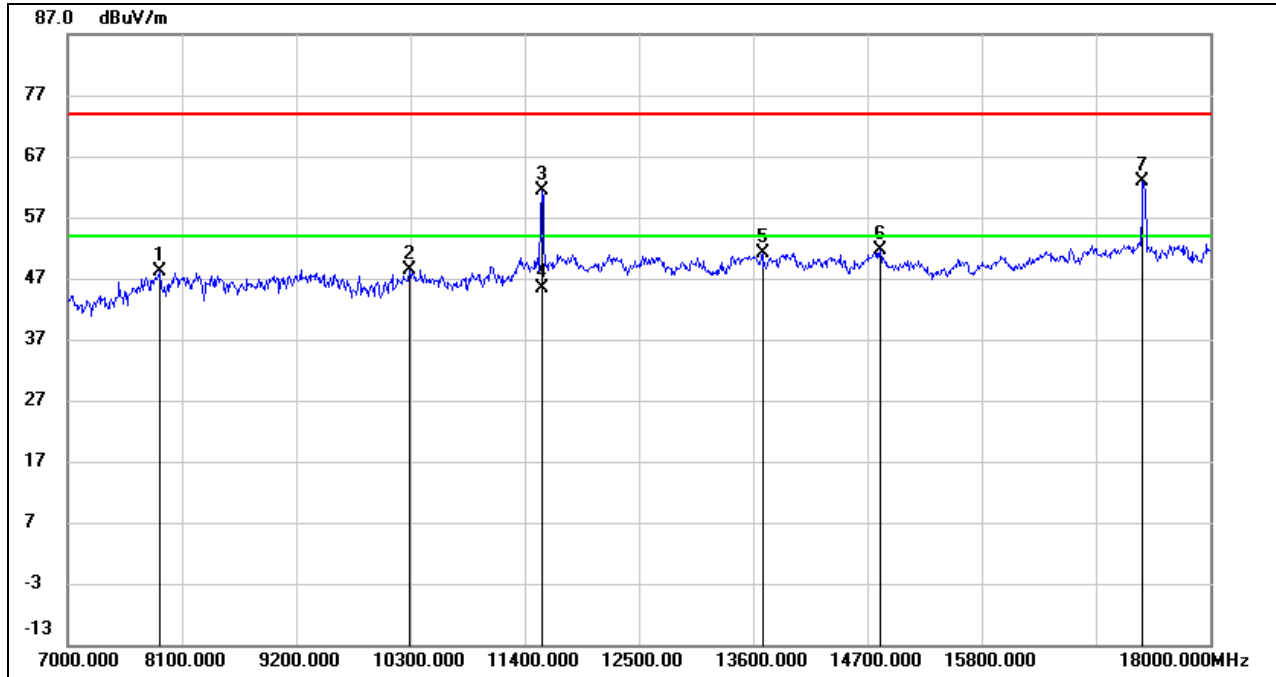

No.	Frequency (MHz)	Reading (dBuV)	Correct (dB/m)	Result (dBuV/m)	Limit (dBuV/m)	Margin (dB)	Remark
1	7891.000	39.35	8.90	48.25	74.00	-25.75	peak
2	10289.000	36.57	11.76	48.33	74.00	-25.67	peak
3	11565.000	46.80	14.69	61.49	74.00	-12.51	peak
4	11565.000	30.60	14.69	45.29	54.00	-8.71	AVG
5	13688.000	33.64	17.55	51.19	74.00	-22.81	peak
6	14821.000	33.68	17.90	51.58	74.00	-22.42	peak
7	17351.000	40.67	22.23	62.90	68.2	-5.3	peak

- Note: 1. Measurement = Reading Level + Correct Factor.
 2. If Peak Result complies with AV limit, AV Result is deemed to comply with AV limit.
 3. Peak: Peak detector.
 4. AVG: $VBW=1/Ton$, where: Ton is the transmitting duration.
 5. For the transmitting duration, please refer to clause 7.1.
 6. Filter losses were only considered in the spurious frequency bands and the authorized band was not corrected for High Pass Filter losses.
 7. Proper operation of the transmitter prior to adding the filter to the measurement chain.
 8. Since non-restricted band peak emissions are less than the average limit, they also comply with the -27dBm/MHz (68.2dBuV/m) limit.

HARMONICS AND SPURIOUS EMISSIONS (MID CHANNEL, VERTICAL)

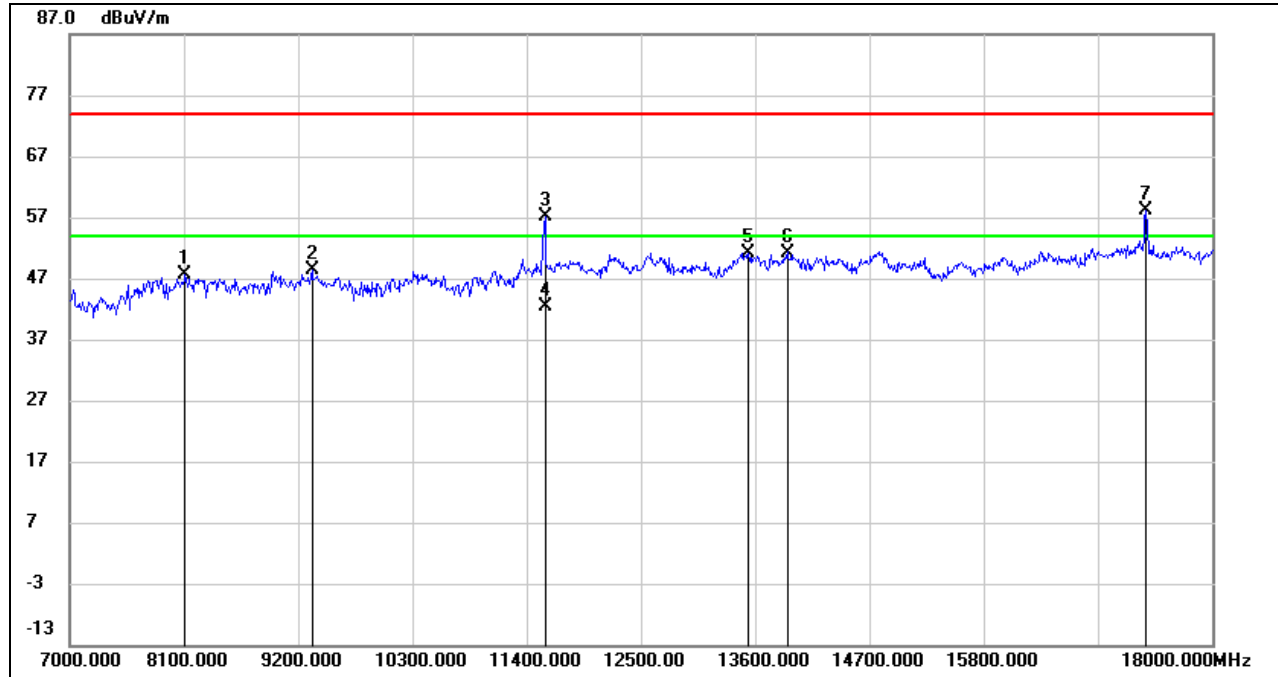

No.	Frequency (MHz)	Reading (dBuV)	Correct (dB/m)	Result (dBuV/m)	Limit (dBuV/m)	Margin (dB)	Remark
1	8111.000	37.51	10.14	47.65	74.00	-26.35	peak
2	9332.000	37.75	10.59	48.34	74.00	-25.66	peak
3	11576.000	42.33	14.71	57.04	74.00	-16.96	peak
4	11576.000	27.79	14.71	42.50	54.00	-11.50	AVG
5	13534.000	34.02	17.18	51.20	74.00	-22.80	peak
6	13908.000	33.71	17.54	51.25	74.00	-22.75	peak
7	17362.000	36.10	22.15	58.25	68.2	-9.95	peak

- Note:
1. Measurement = Reading Level + Correct Factor.
 2. If Peak Result complies with AV limit, AV Result is deemed to comply with AV limit.
 3. Peak: Peak detector.
 4. AVG: $VBW=1/Ton$, where: Ton is the transmitting duration.
 5. For the transmitting duration, please refer to clause 7.1.
 6. Filter losses were only considered in the spurious frequency bands and the authorized band was not corrected for High Pass Filter losses.
 7. Proper operation of the transmitter prior to adding the filter to the measurement chain.
 8. Since non-restricted band peak emissions are less than the average limit, they also comply with the -27dBm/MHz (68.2dBuV/m) limit.

HARMONICS AND SPURIOUS EMISSIONS (HIGH CHANNEL, HORIZONTAL)

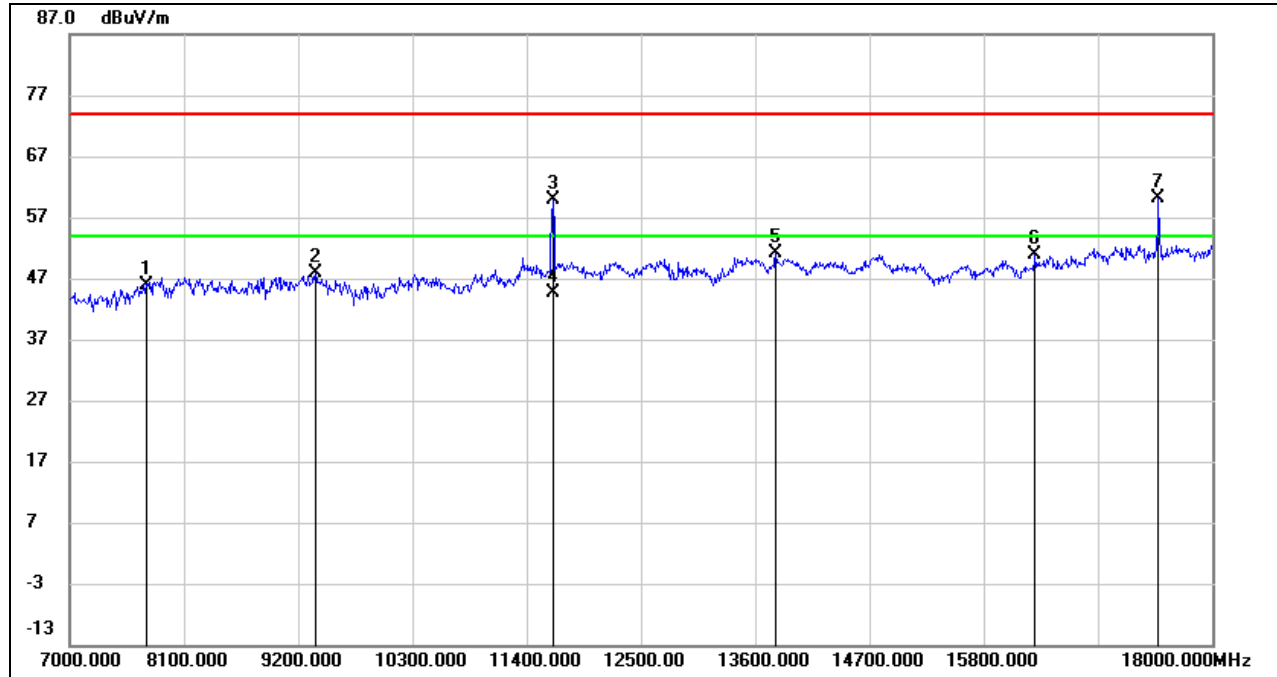

No.	Frequency (MHz)	Reading (dBuV)	Correct (dB/m)	Result (dBuV/m)	Limit (dBuV/m)	Margin (dB)	Remark
1	7737.000	37.22	8.78	46.00	74.00	-28.00	peak
2	9365.000	37.05	10.77	47.82	74.00	-26.18	peak
3	11653.000	44.75	15.05	59.80	74.00	-14.20	peak
4	11653.000	29.64	15.05	44.69	54.00	-9.31	AVG
5	13798.000	33.58	17.61	51.19	74.00	-22.81	peak
6	16295.000	31.19	19.58	50.77	74.00	-23.23	peak
7	17483.000	38.23	22.01	60.24	68.2	-7.96	peak

- Note:
1. Measurement = Reading Level + Correct Factor.
 2. If Peak Result complies with AV limit, AV Result is deemed to comply with AV limit.
 3. Peak: Peak detector.
 4. AVG: $VBW=1/Ton$, where: Ton is the transmitting duration.
 5. For the transmitting duration, please refer to clause 7.1.
 6. Filter losses were only considered in the spurious frequency bands and the authorized band was not corrected for High Pass Filter losses.
 7. Proper operation of the transmitter prior to adding the filter to the measurement chain.
 8. Since non-restricted band peak emissions are less than the average limit, they also comply with the -27dBm/MHz (68.2dBuV/m) limit.

HARMONICS AND SPURIOUS EMISSIONS (HIGH CHANNEL, VERTICAL)

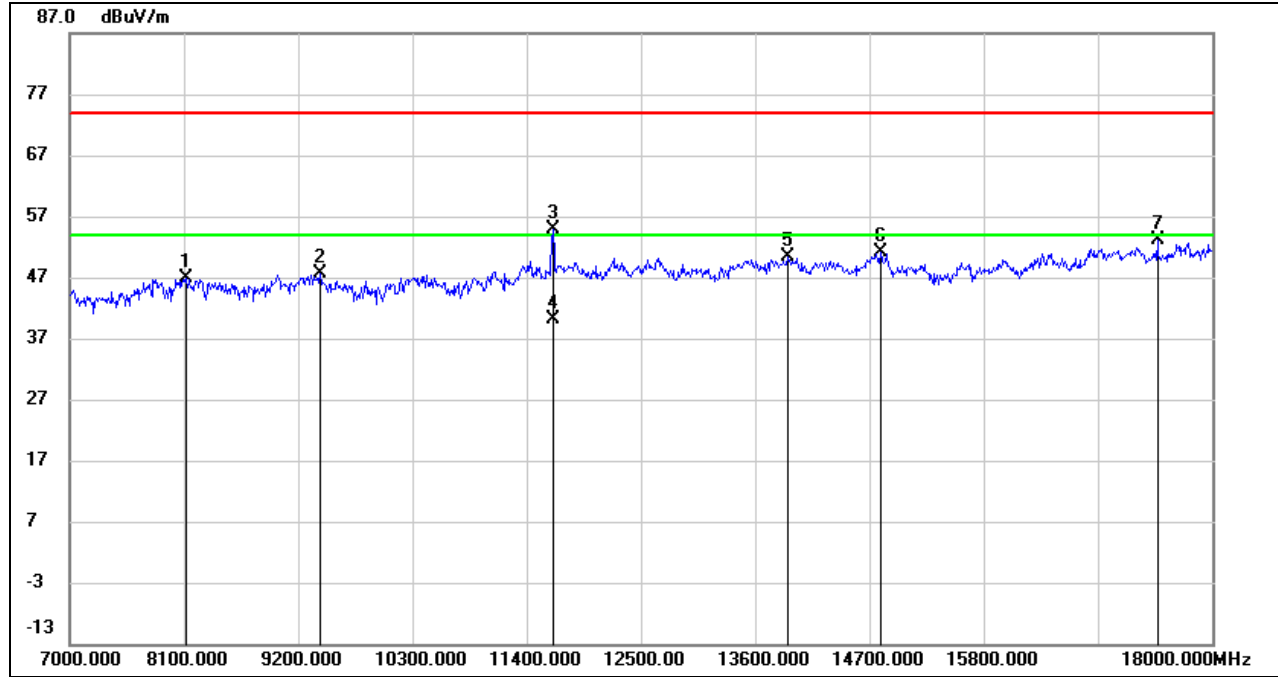

No.	Frequency (MHz)	Reading (dBuV)	Correct (dB/m)	Result (dBuV/m)	Limit (dBuV/m)	Margin (dB)	Remark
1	8122.000	36.71	10.10	46.81	74.00	-27.19	peak
2	9409.000	36.80	10.94	47.74	74.00	-26.26	peak
3	11653.000	39.94	15.05	54.99	74.00	-19.01	peak
4	11653.000	25.02	15.05	40.07	54.00	-13.93	AVG
5	13908.000	32.82	17.54	50.36	74.00	-23.64	peak
6	14810.000	33.23	17.97	51.20	74.00	-22.80	peak
7	17472.000	31.10	21.99	53.09	74.00	-20.91	peak

- Note:
1. Measurement = Reading Level + Correct Factor.
 2. If Peak Result complies with AV limit, AV Result is deemed to comply with AV limit.
 3. Peak: Peak detector.
 4. AVG: $VBW=1/Ton$, where: Ton is the transmitting duration.
 5. For the transmitting duration, please refer to clause 7.1.
 6. Filter losses were only considered in the spurious frequency bands and the authorized band was not corrected for High Pass Filter losses.
 7. Proper operation of the transmitter prior to adding the filter to the measurement chain.
 8. Since non-restricted band peak emissions are less than the average limit, they also comply with the -27dBm/MHz (68.2dBuV/m) limit.



8.3.3. 802.11ac VHT40 CDD 4TX MODE

UNII-1 BAND

HARMONICS AND SPURIOUS EMISSIONS (LOW CHANNEL, HORIZONTAL)

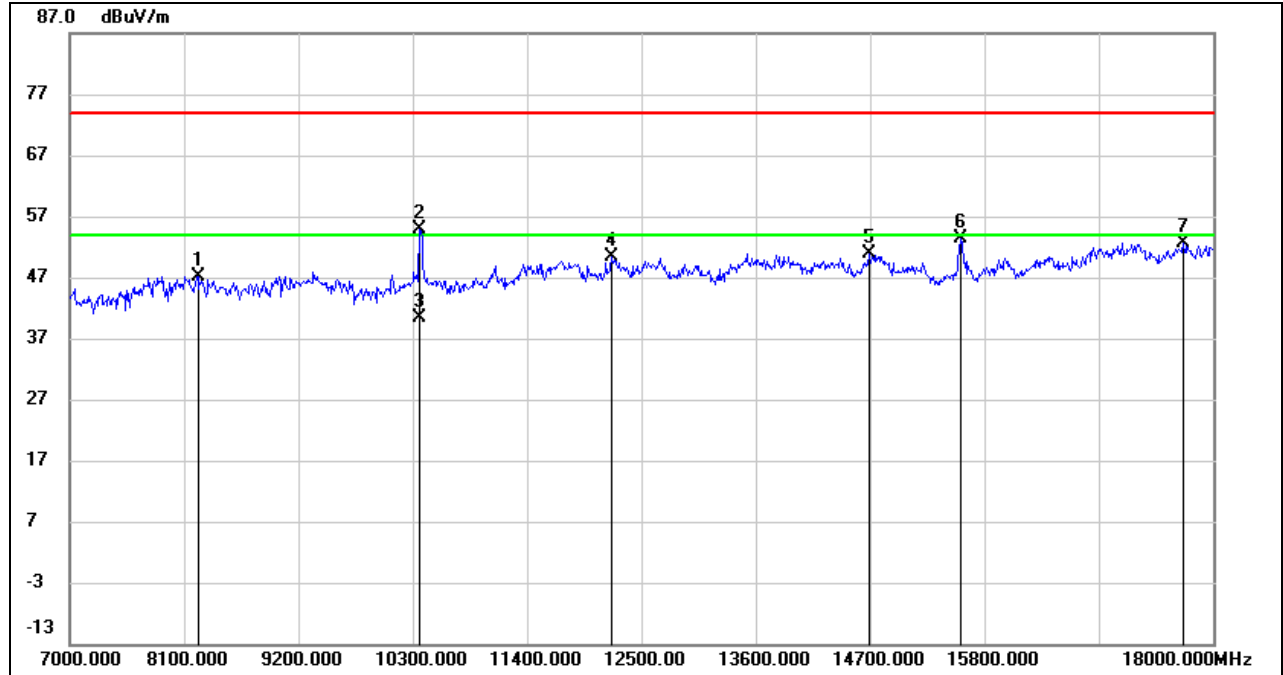

No.	Frequency (MHz)	Reading (dBuV)	Correct (dB/m)	Result (dBuV/m)	Limit (dBuV/m)	Margin (dB)	Remark
1	8232.000	37.45	9.77	47.22	74.00	-26.78	peak
2	10366.000	42.68	12.09	54.77	68.2	-13.43	peak
3	10366.000	28.19	12.09	40.28	/	/	AVG
4	12214.000	34.41	15.97	50.38	74.00	-23.62	peak
5	14689.000	33.19	17.65	50.84	74.00	-23.16	peak
6	15569.000	35.80	17.50	53.30	74.00	-20.70	peak
7	17714.000	29.04	23.55	52.59	74.00	-21.41	peak

- Note: 1. Measurement = Reading Level + Correct Factor.
 2. If Peak Result complies with AV limit, AV Result is deemed to comply with AV limit.
 3. Peak: Peak detector.
 4. AVG: $VBW=1/T_{on}$, where: T_{on} is the transmitting duration.
 5. For the transmitting duration, please refer to clause 7.1.
 6. Filter losses were only considered in the spurious frequency bands and the authorized band was not corrected for High Pass Filter losses.
 7. Proper operation of the transmitter prior to adding the filter to the measurement chain.
 8. Since non-restricted band peak emissions are less than the average limit, they also comply with the -27dBm/MHz (68.2dBuV/m) limit.



HARMONICS AND SPURIOUS EMISSIONS (LOW CHANNEL, VERTICAL)

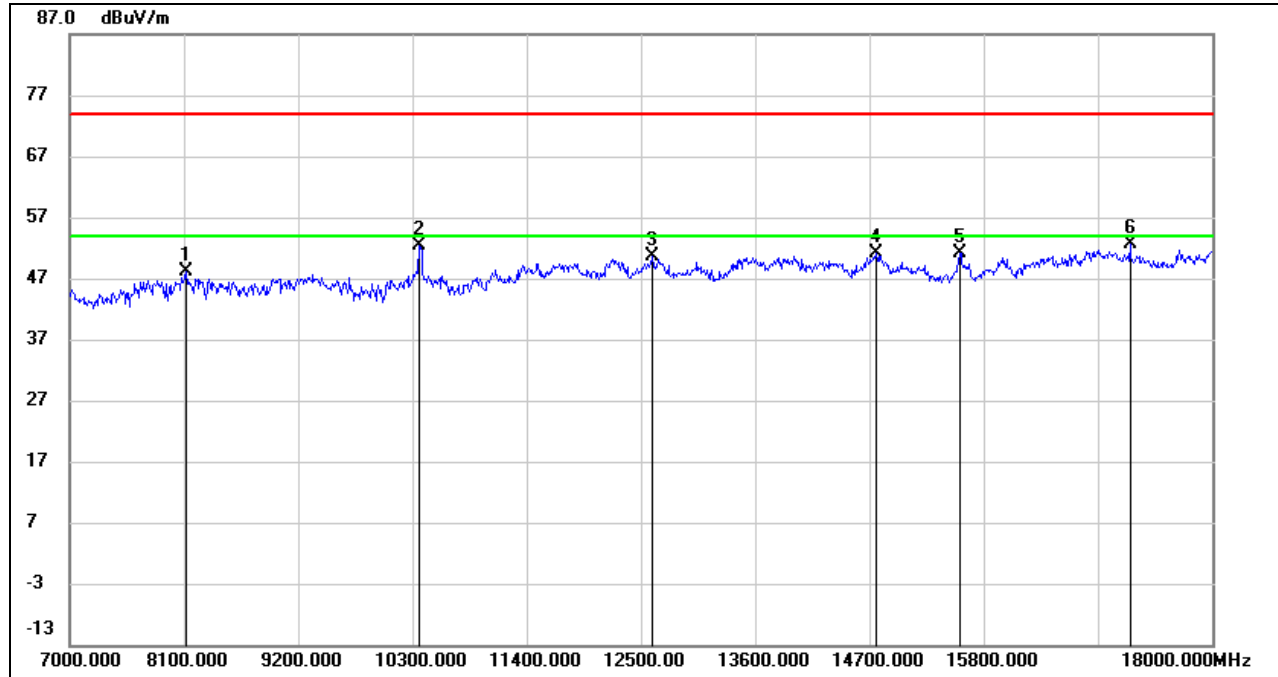

No.	Frequency (MHz)	Reading (dBuV)	Correct (dB/m)	Result (dBuV/m)	Limit (dBuV/m)	Margin (dB)	Remark
1	8122.000	38.06	10.10	48.16	74.00	-25.84	peak
2	10366.000	40.17	12.09	52.26	74.00	-21.74	peak
3	12610.000	34.89	15.76	50.65	74.00	-23.35	peak
4	14766.000	33.11	17.92	51.03	74.00	-22.97	peak
5	15569.000	33.74	17.50	51.24	74.00	-22.76	peak
6	17208.000	30.50	22.04	52.54	74.00	-21.46	peak

- Note:
1. Measurement = Reading Level + Correct Factor.
 2. If Peak Result complies with AV limit, AV Result is deemed to comply with AV limit.
 3. Peak: Peak detector.
 4. AVG: $VBW=1/Ton$, where: Ton is the transmitting duration.
 5. For the transmitting duration, please refer to clause 7.1.
 6. Filter losses were only considered in the spurious frequency bands and the authorized band was not corrected for High Pass Filter losses.
 7. Proper operation of the transmitter prior to adding the filter to the measurement chain.
 8. Since non-restricted band peak emissions are less than the average limit, they also comply with the -27dBm/MHz (68.2dBuV/m) limit.

HARMONICS AND SPURIOUS EMISSIONS (HIGH CHANNEL, HORIZONTAL)

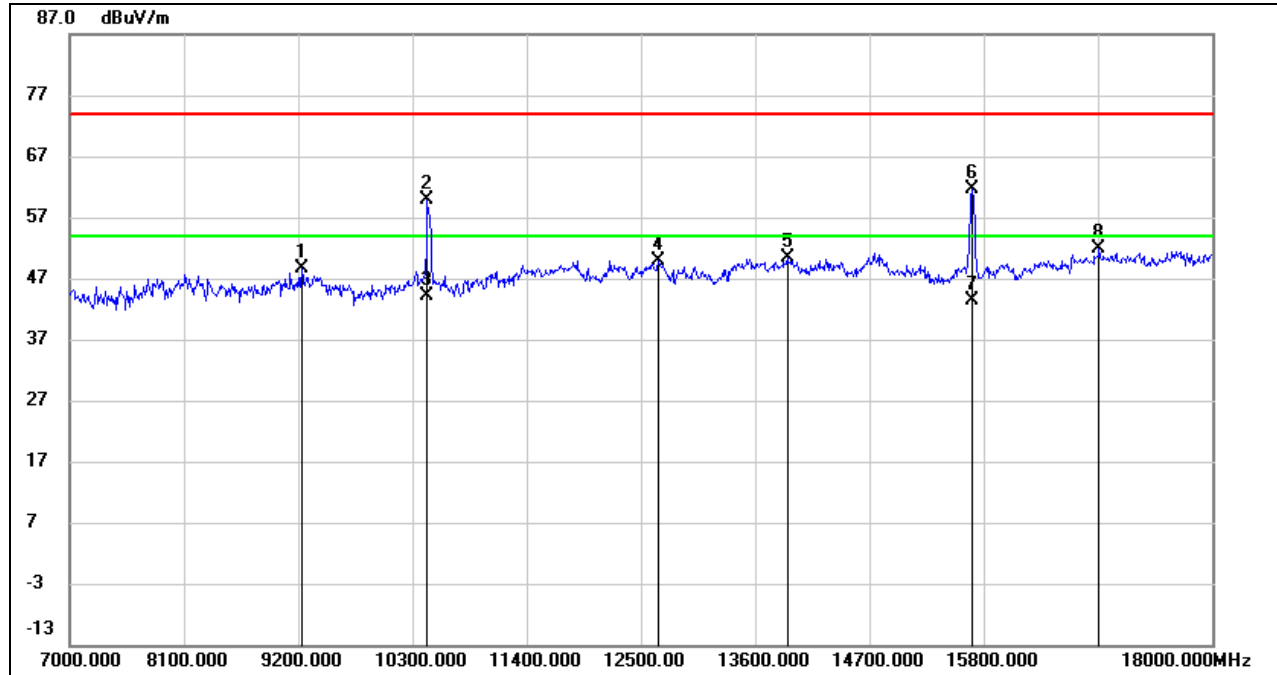

No.	Frequency (MHz)	Reading (dBuV)	Correct (dB/m)	Result (dBuV/m)	Limit (dBuV/m)	Margin (dB)	Remark
1	9233.000	38.66	10.08	48.74	74.00	-25.26	peak
2	10443.000	47.52	12.29	59.81	68.2	-8.39	peak
3	10443.000	31.74	12.29	44.03	/	/	AVG
4	12665.000	34.28	15.68	49.96	74.00	-24.04	peak
5	13908.000	32.81	17.54	50.35	74.00	-23.65	peak
6	15690.000	43.82	17.82	61.64	74.00	-12.36	peak
7	15690.000	25.46	17.82	43.28	54.00	-10.72	AVG
8	16911.000	30.46	21.54	52.00	74.00	-22.00	peak

Note: 1. Measurement = Reading Level + Correct Factor.

2. If Peak Result complies with AV limit, AV Result is deemed to comply with AV limit.

3. Peak: Peak detector.

4. AVG: $VBW=1/Ton$, where: Ton is the transmitting duration.

5. For the transmitting duration, please refer to clause 7.1.

6. Filter losses were only considered in the spurious frequency bands and the authorized band was not corrected for High Pass Filter losses.

7. Proper operation of the transmitter prior to adding the filter to the measurement chain.

8. Since non-restricted band peak emissions are less than the average limit, they also comply with the -27dBm/MHz (68.2dBuV/m) limit.

HARMONICS AND SPURIOUS EMISSIONS (HIGH CHANNEL, VERTICAL)

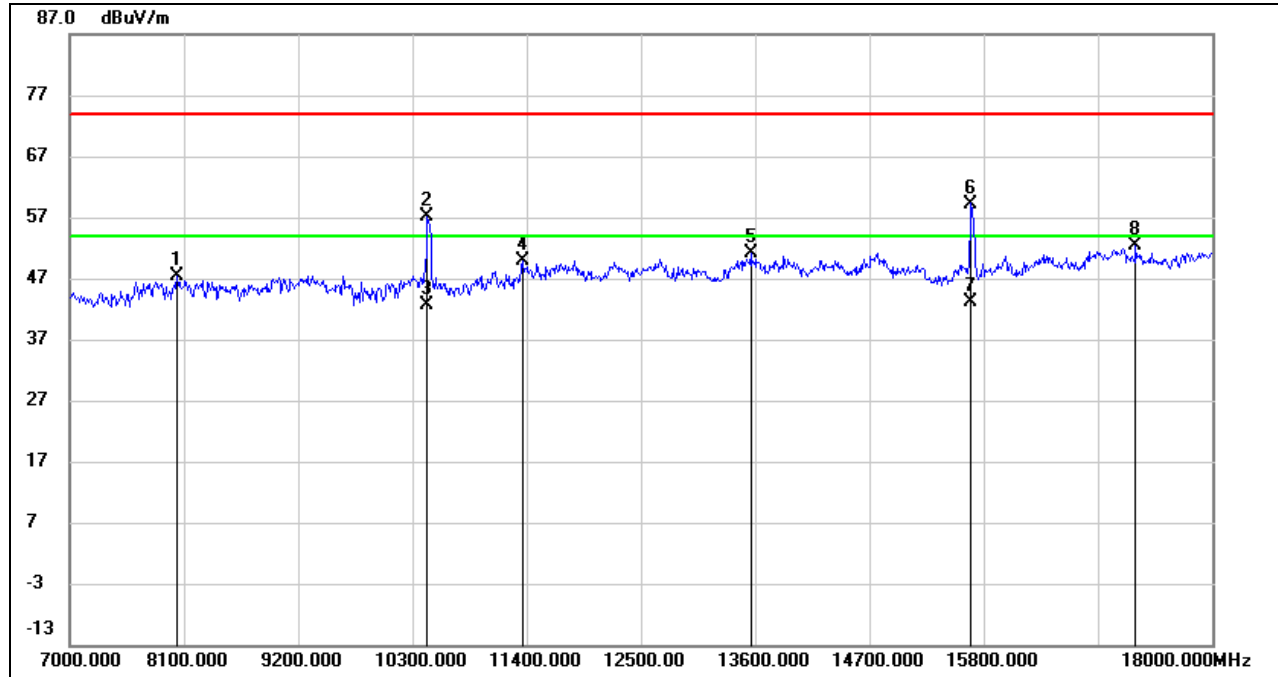

No.	Frequency (MHz)	Reading (dBuV)	Correct (dB/m)	Result (dBuV/m)	Limit (dBuV/m)	Margin (dB)	Remark
1	8034.000	38.16	9.15	47.31	74.00	-26.69	peak
2	10443.000	44.91	12.29	57.20	68.2	-11.0	peak
3	10443.000	30.40	12.29	42.69	/	/	AVG
4	11356.000	35.54	14.35	49.89	74.00	-24.11	peak
5	13556.000	34.09	17.14	51.23	74.00	-22.77	peak
6	15679.000	41.45	17.80	59.25	74.00	-14.75	peak
7	15679.000	25.23	17.80	43.03	54.00	-10.97	AVG
8	17263.000	29.88	22.38	52.26	74.00	-21.74	peak

Note: 1. Measurement = Reading Level + Correct Factor.
 2. If Peak Result complies with AV limit, AV Result is deemed to comply with AV limit.
 3. Peak: Peak detector.
 4. AVG: $VBW=1/Ton$, where: Ton is the transmitting duration.
 5. For the transmitting duration, please refer to clause 7.1.
 6. Filter losses were only considered in the spurious frequency bands and the authorized band was not corrected for High Pass Filter losses.
 7. Proper operation of the transmitter prior to adding the filter to the measurement chain.
 8. Since non-restricted band peak emissions are less than the average limit, they also comply with the -27dBm/MHz (68.2dBuV/m) limit.

UNII-2A BAND

HARMONICS AND SPURIOUS EMISSIONS (LOW CHANNEL, HORIZONTAL)

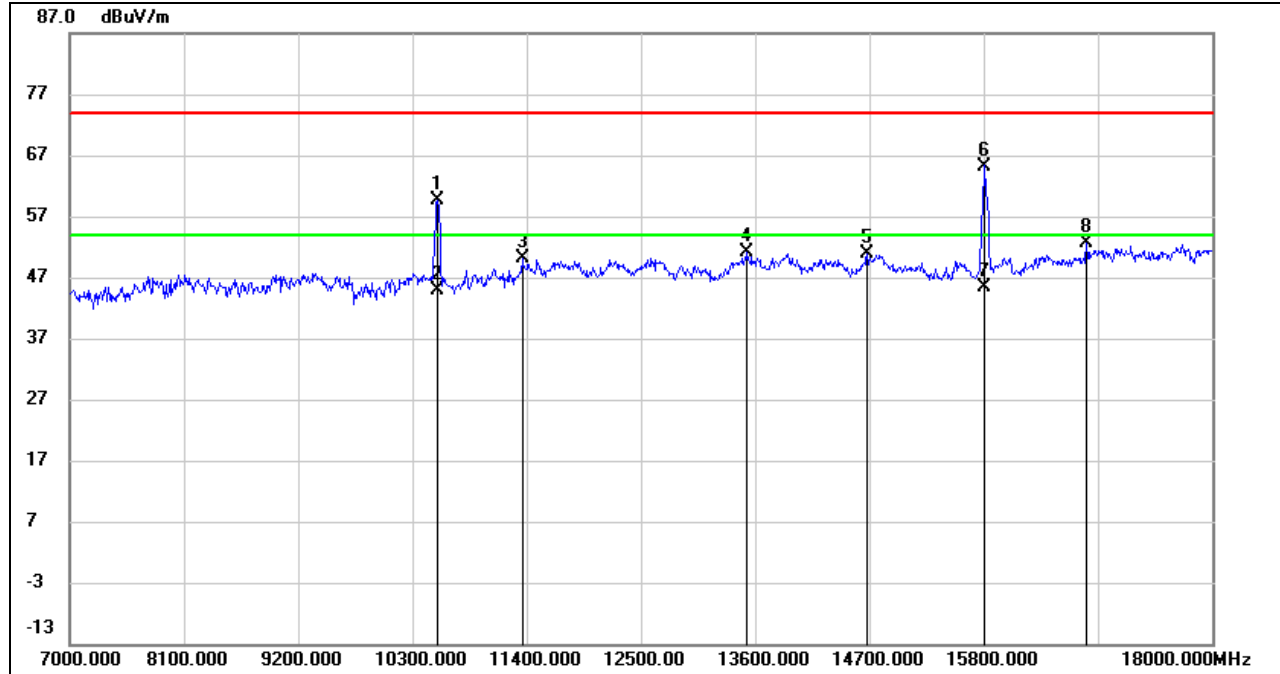

No.	Frequency (MHz)	Reading (dBuV)	Correct (dB/m)	Result (dBuV/m)	Limit (dBuV/m)	Margin (dB)	Remark
1	10542.000	47.10	12.50	59.60	68.2	-8.60	peak
2	10542.000	32.46	12.50	44.96	/	/	AVG
3	11356.000	35.81	14.35	50.16	74.00	-23.84	peak
4	13523.000	33.88	17.19	51.07	74.00	-22.93	peak
5	14678.000	33.21	17.62	50.83	74.00	-23.17	peak
6	15811.000	47.25	18.00	65.25	74.00	-8.75	peak
7	15811.000	27.27	18.00	45.27	54.00	-8.73	AVG
8	16790.000	32.07	20.64	52.71	74.00	-21.29	peak

- Note: 1. Measurement = Reading Level + Correct Factor.
 2. If Peak Result complies with AV limit, AV Result is deemed to comply with AV limit.
 3. Peak: Peak detector.
 4. AVG: $VBW=1/Ton$, where: Ton is the transmitting duration.
 5. For the transmitting duration, please refer to clause 7.1.
 6. Filter losses were only considered in the spurious frequency bands and the authorized band was not corrected for High Pass Filter losses.
 7. Proper operation of the transmitter prior to adding the filter to the measurement chain.
 8. Since non-restricted band peak emissions are less than the average limit, they also comply with the -27dBm/MHz (68.2dBuV/m) limit.

HARMONICS AND SPURIOUS EMISSIONS (LOW CHANNEL, VERTICAL)

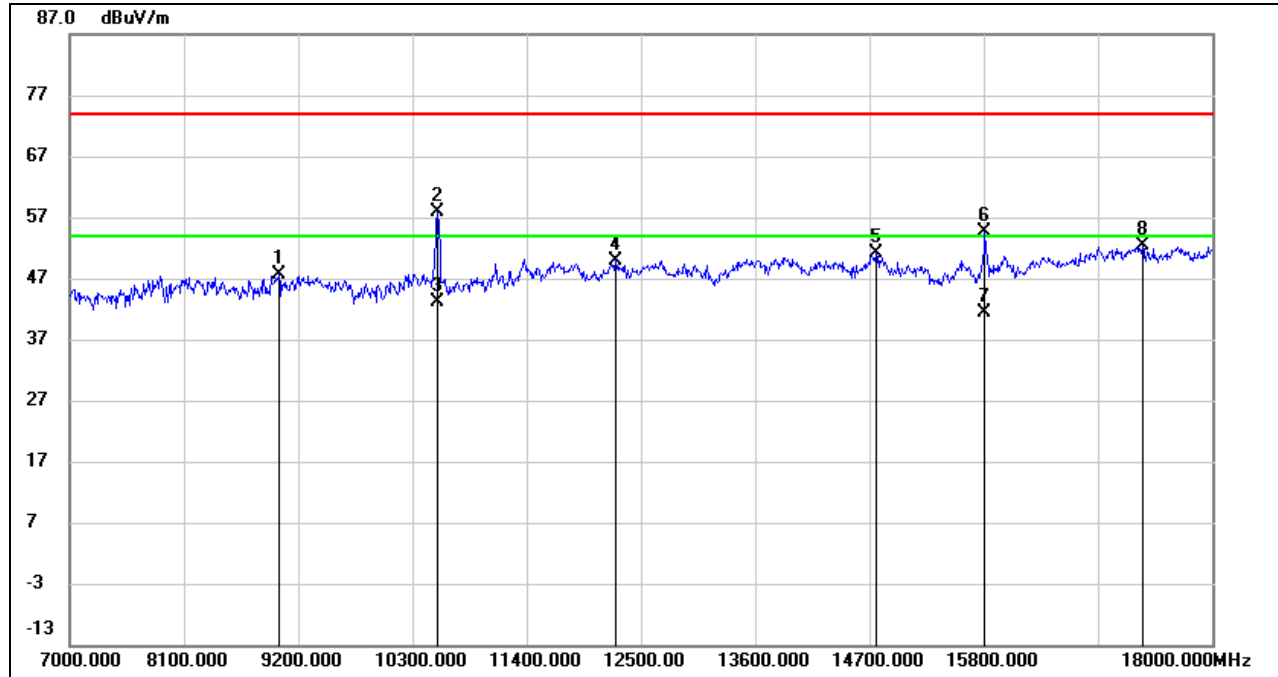

No.	Frequency (MHz)	Reading (dBuV)	Correct (dB/m)	Result (dBuV/m)	Limit (dBuV/m)	Margin (dB)	Remark
1	9013.000	36.47	11.12	47.59	74.00	-26.41	peak
2	10542.000	45.36	12.50	57.86	68.2	-10.34	peak
3	10542.000	30.55	12.50	43.05	/	/	AVG
4	12258.000	33.97	16.03	50.00	74.00	-24.00	peak
5	14766.000	33.21	17.92	51.13	74.00	-22.87	peak
6	15811.000	36.59	18.00	54.59	74.00	-19.41	peak
7	15811.000	23.28	18.00	41.28	54.00	-12.72	AVG
8	17329.000	30.05	22.39	52.44	74.00	-21.56	peak

Note: 1. Measurement = Reading Level + Correct Factor.
 2. If Peak Result complies with AV limit, AV Result is deemed to comply with AV limit.
 3. Peak: Peak detector.
 4. AVG: VBW=1/Ton, where: Ton is the transmitting duration.
 5. For the transmitting duration, please refer to clause 7.1.
 6. Filter losses were only considered in the spurious frequency bands and the authorized band was not corrected for High Pass Filter losses.
 7. Proper operation of the transmitter prior to adding the filter to the measurement chain.
 8. Since non-restricted band peak emissions are less than the average limit, they also comply with the -27dBm/MHz (68.2dBuV/m) limit.

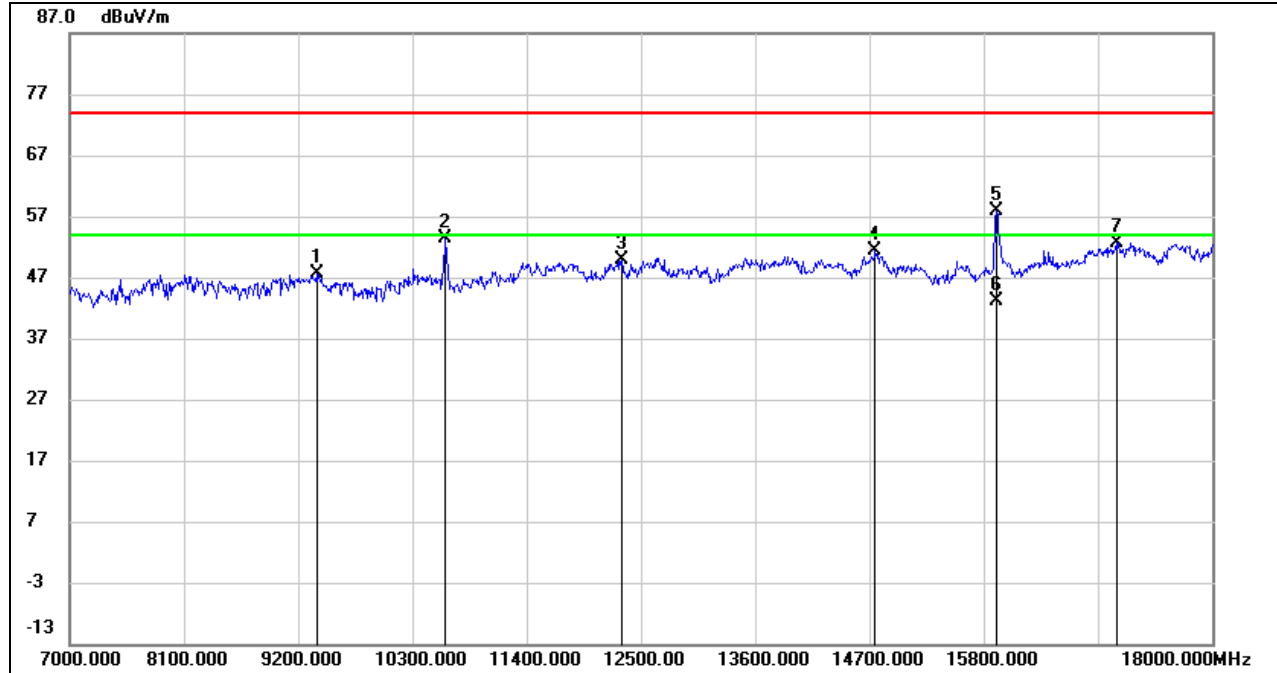
**HARMONICS AND SPURIOUS EMISSIONS (HIGH CHANNEL, HORIZONTAL)**

No.	Frequency (MHz)	Reading (dBuV)	Correct (dB/m)	Result (dBuV/m)	Limit (dBuV/m)	Margin (dB)	Remark
1	9376.000	36.73	10.84	47.57	74.00	-26.43	peak
2	10619.000	40.73	12.72	53.45	74.00	-20.55	peak
3	12313.000	33.78	16.07	49.85	74.00	-24.15	peak
4	14755.000	33.61	17.88	51.49	74.00	-22.51	peak
5	15921.000	39.75	18.14	57.89	74.00	-16.11	peak
6	15921.000	24.99	18.14	43.13	54.00	-10.87	AVG
7	17076.000	30.88	21.74	52.62	74.00	-21.38	peak

Note: 1. Measurement = Reading Level + Correct Factor.

2. If Peak Result complies with AV limit, AV Result is deemed to comply with AV limit.

3. Peak: Peak detector.

4. AVG: $VBW=1/Ton$, where: Ton is the transmitting duration.

5. For the transmitting duration, please refer to clause 7.1.

6. Filter losses were only considered in the spurious frequency bands and the authorized band was not corrected for High Pass Filter losses.

7. Proper operation of the transmitter prior to adding the filter to the measurement chain.

8. Since non-restricted band peak emissions are less than the average limit, they also comply with the $-27dBm/MHz$ ($68.2dBuV/m$) limit.

HARMONICS AND SPURIOUS EMISSIONS (HIGH CHANNEL, VERTICAL)

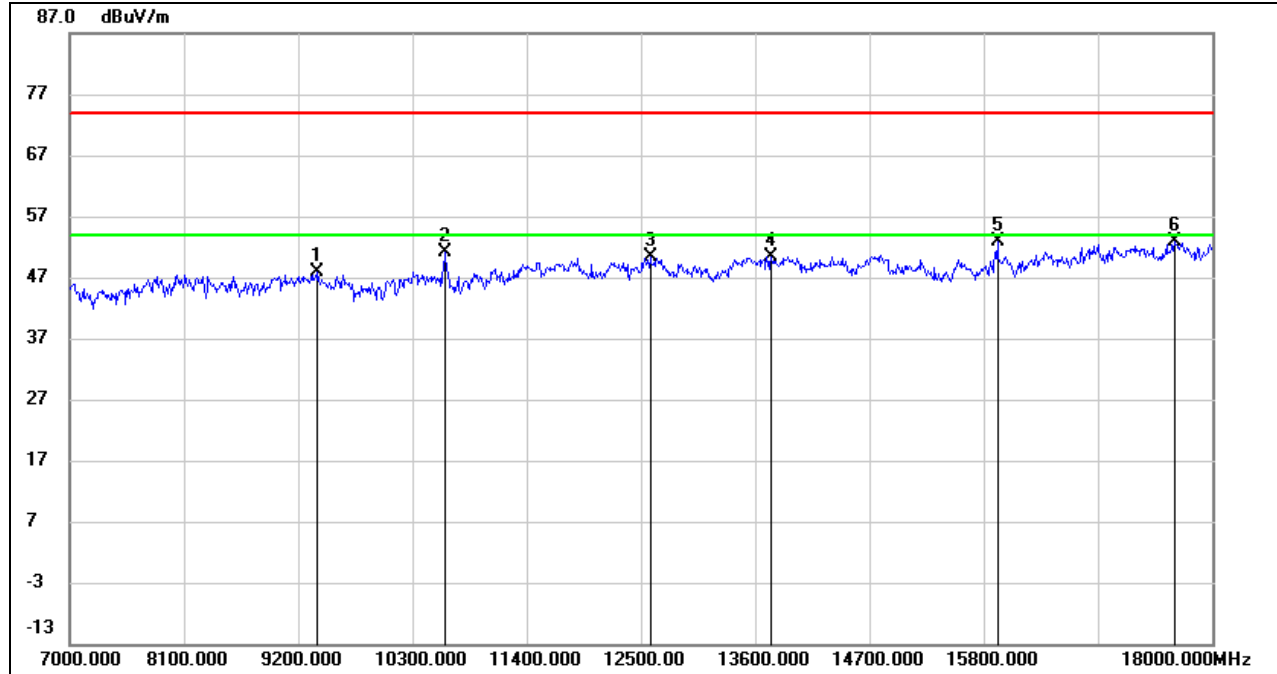

No.	Frequency (MHz)	Reading (dBuV)	Correct (dB/m)	Result (dBuV/m)	Limit (dBuV/m)	Margin (dB)	Remark
1	9387.000	36.96	10.89	47.85	74.00	-26.15	peak
2	10619.000	38.37	12.72	51.09	74.00	-22.91	peak
3	12588.000	34.52	15.76	50.28	74.00	-23.72	peak
4	13754.000	32.89	17.61	50.50	74.00	-23.50	peak
5	15932.000	34.65	18.17	52.82	74.00	-21.18	peak
6	17637.000	29.77	23.01	52.78	74.00	-21.22	peak

- Note:
1. Measurement = Reading Level + Correct Factor.
 2. If Peak Result complies with AV limit, AV Result is deemed to comply with AV limit.
 3. Peak: Peak detector.
 4. AVG: VBW=1/Ton, where: Ton is the transmitting duration.
 5. For the transmitting duration, please refer to clause 7.1.
 6. Filter losses were only considered in the spurious frequency bands and the authorized band was not corrected for High Pass Filter losses.
 7. Proper operation of the transmitter prior to adding the filter to the measurement chain.
 8. Since non-restricted band peak emissions are less than the average limit, they also comply with the -27dBm/MHz (68.2dBuV/m) limit.