

FCC Radio Test Report

FCC ID: Q78-ZXHNF680V9

This report concerns: Original Grant

Project No. : 2001H021
Equipment : GPON ONT
Brand Name : ZTE
Test Model : ZXHN F680
Series Model : ZXHN F689
Applicant : ZTE Corporation
Address : ZTE Plaza, Hi-Tech Park, Nanshan District, Shenzhen, Guangdong, P.R.China
Manufacturer : ZTE Corporation
Address : ZTE Plaza, Hi-Tech Park, Nanshan District, Shenzhen, Guangdong, P.R.China
Date of Receipt : Jan. 17, 2020
Date of Test : Apr. 23, 2020 ~ Apr. 27, 2020
Issued Date : Jun. 05, 2020
Report Version : R00
Test Sample : Engineering Sample No.: SH2020030642, SH2020030642-1
Standard(s) : FCC Part15, Subpart E(15.407)
ANSI C63.10-2013
FCC KDB 789033 D02 General UNII Test Procedures New Rules v02r01
FCC KDB 662911 D01 Multiple Transmitter Output v02r01

The above equipment has been tested and found compliance with the requirement of the relative standards by BTL Inc.

Krain. Wu

Prepared by : Krain Wu

Ryan. Wang

Approved by : Ryan Wang



Certificate # 5123. 03

Add: No. 29, Jintang Road, Tangzhen Industry Park, Pudong New Area, Shanghai 201210, China

TEL: +86-021-61765666

Web: www.newbtl.com

Declaration

BTL represents to the client that testing is done in accordance with standard procedures as applicable and that test instruments used has been calibrated with standards traceable to international standard(s) and/or national standard(s).

BTL's reports apply only to the specific samples tested under conditions. It is manufacture's responsibility to ensure that additional production units of this model are manufactured with the identical electrical and mechanical components. **BTL** shall have no liability for any declarations, inferences or generalizations drawn by the client or others from **BTL** issued reports.

The report must not be used by the client to claim product certification, approval, or endorsement by NIST, A2LA, or any agency of the U.S. Government.

This report is the confidential property of the client. As a mutual protection to the clients, the public and ourselves, the test report shall not be reproduced, except in full, without our written approval.

BTL's laboratory quality assurance procedures are in compliance with the **ISO/IEC 17025** requirements, and accredited by the conformity assessment authorities listed in this test report.

BTL is not responsible for the sampling stage, so the results only apply to the sample as received.

The information, data and test plan are provided by manufacturer which may affect the validity of results, so it is manufacturer's responsibility to ensure that the apparatus meets the essential requirements of applied standards and in all the possible configurations as representative of its intended use.

Limitation

For the use of the authority's logo is limited unless the Test Standard(s)/Scope(s)/Item(s) mentioned in this test report is (are) included in the conformity assessment authorities acceptance respective.

Please note that the measurement uncertainty is provided for informational purpose only and are not use in determining the Pass/Fail results.

| Table of Contents | Page |
|--|-------------|
| REPORT ISSUED HISTORY | 5 |
| 1 . SUMMARY OF TEST RESULTS | 6 |
| 1.1 TEST FACILITY | 7 |
| 1.2 MEASUREMENT UNCERTAINTY | 7 |
| 1.3 TEST ENVIRONMENT CONDITIONS | 7 |
| 2 . GENERAL INFORMATION | 8 |
| 2.1 GENERAL DESCRIPTION OF EUT | 8 |
| 2.2 TEST MODES | 12 |
| 2.3 PARAMETERS OF TEST SOFTWARE | 15 |
| 2.4 DUTY CYCLE | 19 |
| 2.5 BLOCK DIAGRAM SHOWING THE CONFIGURATION OF SYSTEM TESTED | 21 |
| 2.6 SUPPORT UNITS | 21 |
| 3 . AC POWER LINE CONDUCTED EMISSIONS TEST | 22 |
| 3.1 LIMIT | 22 |
| 3.2 TEST PROCEDURE | 22 |
| 3.3 DEVIATION FROM TEST STANDARD | 22 |
| 3.4 TEST SETUP | 23 |
| 3.5 EUT OPERATION CONDITIONS | 23 |
| 3.6 TEST RESULTS | 23 |
| 4 . RADIATED EMISSIONS TEST | 24 |
| 4.1 LIMIT | 24 |
| 4.2 TEST PROCEDURE | 25 |
| 4.3 DEVIATION FROM TEST STANDARD | 25 |
| 4.4 TEST SETUP | 26 |
| 4.5 EUT OPERATION CONDITIONS | 28 |
| 4.6 TEST RESULTS - 9 KHZ to 30 MHZ | 28 |
| 4.7 TEST RESULTS - 30 MHz TO 1000 MHz | 28 |
| 4.8 TEST RESULTS - ABOVE 1000 MHz | 28 |
| 5 . BANDWIDTH TEST | 29 |
| 5.1 LIMIT | 29 |
| 5.2 TEST PROCEDURE | 29 |
| 5.3 TEST PROCEDURE | 29 |
| 5.4 TEST SETUP | 30 |

| Table of Contents | Page |
|---|-------------|
| 5.5 EUT OPERATION CONDITIONS | 30 |
| 5.6 TEST RESULTS | 30 |
| 6 . MAXIMUM OUTPUT POWER TEST | 31 |
| 6.1 LIMIT | 31 |
| 6.2 TEST PROCEDURE | 31 |
| 6.3 DEVIATION FROM STANDARD | 31 |
| 6.4 TEST SETUP | 31 |
| 6.5 EUT OPERATION CONDITIONS | 31 |
| 6.6 TEST RESULTS | 31 |
| 7 . POWER SPECTRAL DENSITY TEST | 32 |
| 7.1 LIMIT | 32 |
| 7.2 TEST PROCEDURE | 32 |
| 7.3 DEVIATION FROM STANDARD | 32 |
| 7.4 TEST SETUP | 33 |
| 7.5 EUT OPERATION CONDITIONS | 33 |
| 7.6 TEST RESULTS | 33 |
| 8 . FREQUENCY STABILITY MEASUREMENT | 34 |
| 8.1 LIMIT | 34 |
| 8.2 TEST PROCEDURE | 34 |
| 8.3 DEVIATION FROM STANDARD | 34 |
| 8.4 TEST SETUP | 34 |
| 8.5 EUT OPERATION CONDITIONS | 34 |
| 8.6 TEST RESULTS | 34 |
| 9 . MEASUREMENT INSTRUMENTS LIST | 35 |
| 10 . EUT TEST PHOTOS | 37 |
| APPENDIX A - AC POWER LINE CONDUCTED EMISSIONS | 40 |
| APPENDIX B - RADIATED EMISSION - 9 KHZ TO 30 MHZ | 43 |
| APPENDIX C - RADIATED EMISSION - 30 MHZ TO 1 GHZ | 44 |
| APPENDIX D - RADIATED EMISSION - ABOVE 1000 MHZ | 47 |
| APPENDIX E - BANDWIDTH | 200 |
| APPENDIX F - CONDUCTED OUTPUT POWER | 213 |
| APPENDIX G - POWER SPECTRAL DENSITY | 258 |

REPORT ISSUED HISTORY

| Report Version | Description | Issued Date |
|----------------|-----------------|---------------|
| R00 | Original Issue. | Jun. 05, 2020 |

1. SUMMARY OF TEST RESULTS

Test procedures according to the technical standard(s):

| FCC Part15, Subpart E(15.407) | | | | |
|-------------------------------------|---|--|-----------|----------|
| Standard(s) Section | Test Item | Test Result | Judgement | Remark |
| 15.207 15.407(b) | AC Power Line Conducted Emissions | APPENDIX A | PASS | ----- |
| 15.407(b) 15.205(a) 15.209(a) | Radiated Emissions | APPENDIX B APPENDIX C APPENDIX D | PASS | ----- |
| 15.407(a) 15.407(e) | Spectrum Bandwidth | APPENDIX E | PASS | ----- |
| 15.407(a) | Maximum Output Power | APPENDIX F | PASS | ----- |
| 15.407(a) | Power Spectral Density | APPENDIX G | PASS | ----- |
| 15.407(g) | Frequency Stability | APPENDIX H | PASS | ----- |
| 15.203 | Antenna Requirements | ----- | PASS | NOTE (3) |
| 15.407(c) | Automatically Discontinue Transmission | ----- | PASS | NOTE (3) |

Note:

- (1) "N/A" denotes test is not applicable in this test report.
- (2) The device what use a permanently attached antenna were considered sufficient to comply with the provisions of 15.203.
- (3) During no any information transmission, the EUT can automatically discontinue transmission and become standby mode for power saving. the EUT can detect the controlling signal of ACK message transmitting from remote device and verify whether it shall resend or discontinue transmission.
- (4) For UNII-1 this device was functioned as a
 Access point device Client device

1.1 TEST FACILITY

The test facilities used to collect the test data in this report is at the location of No. 29, Jintang Road, Tangzhen Industry Park, Pudong New Area, Shanghai 201210,China

BTL's Test Firm Registration Number for FCC: 476765

BTL's Designation Number for FCC: CN1241

1.2 MEASUREMENT UNCERTAINTY

ISO/IEC 17025 requires that an estimate of the measurement uncertainties associated with the emissions test results be included in the report. The measurement uncertainties given below are based on a 95% confidence level (based on a coverage factor (k=2))

The BTL measurement uncertainty as below table:

A. AC Power Line Conducted Emissions test:

| Test Site | Method | Measurement Frequency Range | U, (dB) |
|-----------|--------|-----------------------------|---------|
| SH-C01 | CISPR | 9 kHz ~ 150 MHz | 2.92 |

B. Radiated emissions test:

| Test Site | Method | Measurement Frequency Range | Ant. H / V | U, (dB) |
|-----------|--------|-----------------------------|------------|---------|
| SH-CB01 | CISPR | 9 KHz~30 MHz | V | 3.79 |
| | | 9 KHz~30 MHz | H | 3.57 |
| | | 30 MHz~200 MHz | V | 4.04 |
| | | 30 MHz~200 MHz | H | 3.76 |
| | | 200 MHz~1,000 MHz | V | 4.24 |
| | | 200 MHz~1,000 MHz | H | 3.84 |
| | | 1 GHz~18 GHz | V | 4.46 |
| | | 1 GHz~18 GHz | H | 4.40 |
| | | 18 GHz~40 GHz | V | 3.95 |
| | | 18 GHz~40 GHz | H | 3.95 |

Note: Unless specifically mentioned, the uncertainty of measurement has not been taken into account to declare the compliance or non-compliance to the specification.

1.3 TEST ENVIRONMENT CONDITIONS

| Test Item | Temperature | Humidity | Test Voltage | Tested By |
|-----------------------------------|------------------|----------|------------------|-----------|
| AC Power Line Conducted Emissions | 22°C | 51% | AC 120V | Bill Dong |
| Radiated Emissions-9K-30MHz | 22°C | 51% | AC 120V | Bill Dong |
| Radiated Emissions-30 MHz to 1GHz | 20°C | 45% | AC 120V | Forest Li |
| Radiated Emissions-Above 1000 MHz | 20°C | 45% | AC 120V | Forest Li |
| Spectrum Bandwidth | 22°C | 51% | AC 120V | Bill Dong |
| Maximum Output Power | 22°C | 51% | AC 120V | Bill Dong |
| Power Spectral Density | 22°C | 51% | AC 120V | Bill Dong |
| Frequency Stability | Normal & Extreme | 51% | Normal & Extreme | Bill Dong |

2. GENERAL INFORMATION

2.1 GENERAL DESCRIPTION OF EUT

| | |
|-------------------------|--|
| Equipment | GPON ONT |
| Brand Name | ZTE |
| Test Model | ZXHN F680 |
| Series Model | ZXHN F689 |
| Model Difference(s) | Only different in outer covering color. |
| Software Version | N/A |
| Hardware Version | N/A |
| Power Source | DC voltage supplied from AC/DC adapter. |
| Power Rating | I/P: 100-240V ~ 50/60Hz 1.5A MAX O/P: 12V --- 2.5A |
| Operation Frequency | UNII-1: 5150 MHz~5250 MHz UNII-2A: 5250 MHz~5350 MHz UNII-2C: 5470 MHz~5725 MHz UNII-3: 5725 MHz~5850 MHz |
| Modulation Type | OFDM |
| Bit Rate of Transmitter | Up to 1733.2Mbps |

| | |
|--|---|
| Maximum Conducted Output Power for UNII-1 (4TX) Non-Beamforming | IEEE 802.11a: 26.07 dBm (0.4046 W) IEEE 802.11n (HT20): 25.83 dBm (0.3828 W) IEEE 802.11n (HT40): 23.99 dBm (0.2506 W) IEEE 802.11ac (VHT20): 26.77 dBm (0.4753 W) IEEE 802.11ac (VHT40): 24.03 dBm (0.2529 W) IEEE 802.11ac (VHT80): 21.50 dBm (0.1413 W) |
| Maximum Conducted Output Power for UNII-2A (4TX) Non-Beamforming | IEEE 802.11a: 20.93 dBm (0.1239 W) IEEE 802.11n (HT20): 20.62 dBm (0.1153 W) IEEE 802.11n (HT40): 20.35 dBm (0.1084 W) IEEE 802.11ac (VHT20): 20.80 dBm (0.1202 W) IEEE 802.11ac (VHT40): 20.39 dBm (0.1094 W) IEEE 802.11ac (VHT80): 20.45 dBm (0.1109 W) |
| Maximum Conducted Output Power for UNII-2C (4TX) Non-Beamforming | IEEE 802.11a: 20.65 dBm (0.1161 W) IEEE 802.11n (HT20): 19.89 dBm (0.0975 W) IEEE 802.11n (HT40): 20.69 dBm (0.1172 W) IEEE 802.11ac (VHT20): 20.78 dBm (0.1197 W) IEEE 802.11ac (VHT40): 20.72 dBm (0.1180 W) IEEE 802.11ac (VHT80): 20.79 dBm (0.1199 W) |
| Maximum Conducted Output Power for UNII-3 (4TX) Non-Beamforming | IEEE 802.11a: 22.89 dBm (0.1945 W) IEEE 802.11n (HT20): 26.70 dBm (0.4677 W) IEEE 802.11n (HT40): 26.52 dBm (0.4487 W) IEEE 802.11ac (VHT20): 26.80 dBm (0.4786 W) IEEE 802.11ac (VHT40): 26.66 dBm (0.4634 W) IEEE 802.11ac (VHT80): 26.80 dBm (0.4786 W) |

| | |
|--|---|
| Maximum Conducted Output Power for UNII-1 (4TX) Beamforming | IEEE 802.11n (HT20): 25.73 dBm (0.3741 W) IEEE 802.11n (HT40): 23.75 dBm (0.2371 W) IEEE 802.11ac (VHT20): 26.59 dBm (0.4560 W) IEEE 802.11ac (VHT40): 23.84 dBm (0.2421 W) IEEE 802.11ac (VHT80): 21.32 dBm (0.1355 W) |
| Maximum Conducted Output Power for UNII-2A (4TX) Beamforming | IEEE 802.11n (HT20): 20.53 dBm (0.1130 W) IEEE 802.11n (HT40): 20.20 dBm (0.1047 W) IEEE 802.11ac (VHT20): 20.70 dBm (0.1175 W) IEEE 802.11ac (VHT40): 20.24 dBm (0.1057 W) IEEE 802.11ac (VHT80): 20.28 dBm (0.1067 W) |
| Maximum Conducted Output Power for UNII-2C (4TX) Beamforming | IEEE 802.11n (HT20): 19.57 dBm (0.0906 W) IEEE 802.11n (HT40): 20.48 dBm (0.1117 W) IEEE 802.11ac (VHT20): 20.60 dBm (0.1148 W) IEEE 802.11ac (VHT40): 20.65 dBm (0.1161 W) IEEE 802.11ac (VHT80): 20.60 dBm (0.1148 W) |
| Maximum Conducted Output Power for UNII-3 (4TX) Beamforming | IEEE 802.11n (HT20): 26.43 dBm (0.4395 W) IEEE 802.11n (HT40): 26.39 dBm (0.4355 W) IEEE 802.11ac (VHT20): 26.69 dBm (0.4667 W) IEEE 802.11ac (VHT40): 26.53 dBm (0.4498 W) IEEE 802.11ac (VHT80): 26.54 dBm (0.4508 W) |

Note:

1. For a more detailed features description, please refer to the manufacturer's specifications or the user's manual.

2. Channel List:

| IEEE 802.11a IEEE 802.11n (HT20) IEEE 802.11ac (VHT20) | | IEEE 802.11n (HT40) IEEE 802.11ac (VHT40) | | IEEE 802.11ac (VHT80) | |
|--|-----------------|--|-----------------|-----------------------|-----------------|
| UNII-1 | | UNII-1 | | UNII-1 | |
| Channel | Frequency (MHz) | Channel | Frequency (MHz) | Channel | Frequency (MHz) |
| 36 | 5180 | 38 | 5190 | 42 | 5210 |
| 40 | 5200 | 46 | 5230 | | |
| 44 | 5220 | | | | |
| 48 | 5240 | | | | |

| IEEE 802.11a IEEE 802.11n (HT20) IEEE 802.11ac (VHT20) | | IEEE 802.11n (HT40) IEEE 802.11ac (VHT40) | | IEEE 802.11ac (VHT80) | |
|--|-----------------|--|-----------------|-----------------------|-----------------|
| UNII-2A | | UNII-2A | | UNII-2A | |
| Channel | Frequency (MHz) | Channel | Frequency (MHz) | Channel | Frequency (MHz) |
| 52 | 5260 | 54 | 5270 | 58 | 5290 |
| 56 | 5280 | 62 | 5310 | | |
| 60 | 5300 | | | | |
| 64 | 5320 | | | | |

| IEEE 802.11a IEEE 802.11n (HT20) IEEE 802.11ac (VHT20) | | IEEE 802.11n (HT40) IEEE 802.11ac (VHT40) | | IEEE 802.11ac (VHT80) | |
|--|-----------------|--|-----------------|-----------------------|-----------------|
| UNII-2C | | UNII-2C | | UNII-2C | |
| Channel | Frequency (MHz) | Channel | Frequency (MHz) | Channel | Frequency (MHz) |
| 100 | 5500 | 102 | 5510 | 106 | 5530 |
| 104 | 5520 | 110 | 5550 | 122 | 5610 |
| 108 | 5540 | 118 | 5590 | | |
| 112 | 5560 | 126 | 5630 | | |
| 116 | 5580 | 134 | 5670 | | |
| 120 | 5600 | | | | |
| 124 | 5620 | | | | |
| 128 | 5640 | | | | |
| 132 | 5660 | | | | |
| 136 | 5680 | | | | |
| 140 | 5700 | | | | |

| IEEE 802.11a IEEE 802.11n (HT20) IEEE 802.11ac (VHT20) | | IEEE 802.11n (HT40) IEEE 802.11ac (VHT40) | | IEEE 802.11ac (VHT80) | |
|--|-----------------|--|-----------------|-----------------------|-----------------|
| UNII-3 | | UNII-3 | | UNII-3 | |
| Channel | Frequency (MHz) | Channel | Frequency (MHz) | Channel | Frequency (MHz) |
| 149 | 5745 | 151 | 5755 | 155 | 5775 |
| 153 | 5765 | 159 | 5795 | | |
| 157 | 5785 | | | | |
| 161 | 5805 | | | | |
| 165 | 5825 | | | | |

3. Antenna Specification:

| Ant. | Brand | Model Name | Antenna Type | Connector | Gain (dBi) | Note |
|------|-------|------------|--------------|-----------|------------|------|
| 1 | N/A | N/A | PCB | N/A | 3 | N/A |
| 2 | N/A | N/A | PCB | N/A | 3 | N/A |
| 3 | N/A | N/A | PCB | N/A | 3 | N/A |
| 4 | N/A | N/A | PCB | N/A | 3 | N/A |

Note:

For Beamforming:

- (1) Antenna Gain=3 dBi. This EUT supports MIMO 4X4, any transmit signals are correlated with each other, so Directional gain = $G_{Ant.} 10\log(N)$ dBi, that is Directional gain= $3+10\log(4)$ dBi =9.02; So,the UNII-2A,UNII-2C output power limit is $24-9.02+6=20.98$, the UNII-1,UNII-3 output power limit is $30-9.02+6=26.98$. The UNII-1 power spectral density limit is $17-9.02+6=13.98$, the UNII-2A,UNII-2C power spectral density limit is $11-9.02+6=7.98$, the UNII-3 power spectral density limit is $30-9.02+6=26.98$.

For Non-Beamforming:

- (2) This EUT supports CDD, and all antennas have the same gain, Directional gain= $G_{ANT} + \text{Array Gain}$, where Array Gain is as follows:

For power spectral density measurements, $N_{ANT} = 3$, $N_{SS} = 1$. So Directional gain = $G_{ANT} + \text{Array Gain} = G_{ANT} + 10 \log (N_{ANT}/ N_{SS})$ dB = $3+10\log(4/1)$ dBi=9.02. Then, the UNII-1 power spectral density limit is $17-9.02+6=13.98$, the UNII-2A,UNII-2C power spectral density limit is $11-9.02+6=7.98$, the UNII-3 power spectral density limit is $30-9.02+6=26.98$.

For power measurements, Array Gain = 0 dB ($N_{ANT} \leq 4$), so the Directional gain=3.

4. Table for Antenna Configuration:

| Operating Mode TX Mode | 1TX | 2TX | 3TX | 4TX |
|---------------------------|------------|---------------------|------------------------------|---------------------------------------|
| IEEE 802.11a | V (Ant. 1) | V (Ant. 1 + Ant. 2) | V (Ant. 1 + Ant. 2 + Ant. 3) | V (Ant. 1 + Ant. 2 + Ant. 3 + Ant. 4) |
| IEEE 802.11n (HT20) | V (Ant. 1) | V (Ant. 1 + Ant. 2) | V (Ant. 1 + Ant. 2 + Ant. 3) | V (Ant. 1 + Ant. 2 + Ant. 3 + Ant. 4) |
| IEEE 802.11n (HT40) | V (Ant. 1) | V (Ant. 1 + Ant. 2) | V (Ant. 1 + Ant. 2 + Ant. 3) | V (Ant. 1 + Ant. 2 + Ant. 3 + Ant. 4) |
| IEEE 802.11ac (VHT20) | V (Ant. 1) | V (Ant. 1 + Ant. 2) | V (Ant. 1 + Ant. 2 + Ant. 3) | V (Ant. 1 + Ant. 2 + Ant. 3 + Ant. 4) |
| IEEE 802.11ac (VHT40) | V (Ant. 1) | V (Ant. 1 + Ant. 2) | V (Ant. 1 + Ant. 2 + Ant. 3) | V (Ant. 1 + Ant. 2 + Ant. 3 + Ant. 4) |
| IEEE 802.11ac (VHT80) | V (Ant. 1) | V (Ant. 1 + Ant. 2) | V (Ant. 1 + Ant. 2 + Ant. 3) | V (Ant. 1 + Ant. 2 + Ant. 3 + Ant. 4) |

2.2 TEST MODES

The test system was pre-tested based on the consideration of all possible combinations of EUT operation mode.

| Pretest Mode | Description |
|--------------|--|
| Mode 1 | TX A Mode / CH36, CH40, CH48 (UNII-1) |
| Mode 2 | TX N (HT20) Mode / CH36, CH40, CH48 (UNII-1) |
| Mode 3 | TX N (HT40) Mode / CH38, CH46 (UNII-1) |
| Mode 4 | TX AC (VHT20) Mode / CH36, CH40, CH48 (UNII-1) |
| Mode 5 | TX AC (VHT40) Mode / CH38, CH46 (UNII-1) |
| Mode 6 | TX AC (VHT80) Mode / CH42 (UNII-1) |
| Mode 7 | TX A Mode / CH52, CH60, CH64 (UNII-2A) |
| Mode 8 | TX N (HT20) Mode / CH52, CH60, CH64 (UNII-2A) |
| Mode 9 | TX N (HT40) Mode / CH54, CH62 (UNII-2A) |
| Mode 10 | TX AC (VHT20) Mode / CH52, CH60, CH64 (UNII-2A) |
| Mode 11 | TX AC (VHT40) Mode / CH54, CH62 (UNII-2A) |
| Mode 12 | TX AC (VHT80) Mode / CH58 (UNII-2A) |
| Mode 13 | TX A Mode / CH100, CH116, CH140 (UNII-2C) |
| Mode 14 | TX N (HT20) Mode / CH100, CH116, CH140 (UNII-2C) |
| Mode 15 | TX N (HT40) Mode / CH102, CH110, CH134 (UNII-2C) |
| Mode 16 | TX AC (VHT20) Mode / CH100, CH116, CH140 (UNII-2C) |
| Mode 17 | TX AC (VHT40) Mode / CH102, CH110, CH134 (UNII-2C) |
| Mode 18 | TX AC (VHT80) Mode / CH106, CH122 (UNII-2C) |
| Mode 19 | TX A Mode / CH149,CH157,CH165 (UNII-3) |
| Mode 20 | TX N (HT20) Mode / CH149,CH157,CH165 (UNII-3) |
| Mode 21 | TX N (HT40) Mode / CH151,CH159 (UNII-3) |
| Mode 22 | TX AC (VHT20) Mode / CH149,CH157,CH165 (UNII-3) |
| Mode 23 | TX AC (VHT40) Mode / CH151,CH159 (UNII-3) |
| Mode 24 | TX AC (VHT80) Mode / CH155 (UNII-3) |
| Mode 25 | TX AC(VHT20) Mode / CH149 (UNII-3) |

Following mode(s) as (were) found to be the worst case(s) and selected for the final test.

| AC power line conducted emissions test | |
|---|------------------------------------|
| Final Test Mode | Description |
| Mode 25 | TX AC(VHT20) Mode / CH149 (UNII-3) |

| Radiated emissions test | |
|--------------------------------|--|
| Final Test Mode | Description |
| Mode 1 | TX A Mode / CH36, CH40, CH48 (UNII-1) |
| Mode 2 | TX AC (VHT20) Mode / CH36, CH40, CH48 (UNII-1) |
| Mode 3 | TX AC (VHT40) Mode / CH38, CH46 (UNII-1) |
| Mode 4 | TX AC (VHT80) Mode / CH42 (UNII-1) |
| Mode 5 | TX A Mode / CH52, CH60, CH64 (UNII-2A) |
| Mode 6 | TX AC (VHT20) Mode / CH52, CH60, CH64 (UNII-2A) |
| Mode 7 | TX AC (VHT40) Mode / CH54, CH62 (UNII-2A) |
| Mode 8 | TX AC (VHT80) Mode / CH58 (UNII-2A) |
| Mode 9 | TX A Mode / CH100, CH116, CH140 (UNII-2C) |
| Mode 10 | TX AC (VHT20) Mode / CH100, CH116, CH140 (UNII-2C) |
| Mode 11 | TX AC (VHT40) Mode / CH102, CH110, CH134 (UNII-2C) |
| Mode 12 | TX AC (VHT80) Mode / CH106, CH122 (UNII-2C) |
| Mode 13 | TX A Mode / CH149,CH157,CH165 (UNII-3) |
| Mode 14 | TX AC (VHT20) Mode / CH149,CH157,CH165 (UNII-3) |
| Mode 15 | TX AC (VHT40) Mode / CH151,CH159 (UNII-3) |
| Mode 16 | TX AC (VHT80) Mode / CH155 (UNII-3) |

| Conducted test | |
|----------------|--|
| Test Mode | Description |
| Mode 1 | TX A Mode / CH36, CH40, CH48 (UNII-1) |
| Mode 4 | TX AC (VHT20) Mode / CH36, CH40, CH48 (UNII-1) |
| Mode 5 | TX AC (VHT40) Mode / CH38, CH46 (UNII-1) |
| Mode 6 | TX AC (VHT80) Mode / CH42 (UNII-1) |
| Mode 7 | TX A Mode / CH52, CH60, CH64 (UNII-2A) |
| Mode 10 | TX AC (VHT20) Mode / CH52, CH60, CH64 (UNII-2A) |
| Mode 11 | TX AC (VHT40) Mode / CH54, CH62 (UNII-2A) |
| Mode 12 | TX AC (VHT80) Mode / CH58 (UNII-2A) |
| Mode 13 | TX A Mode / CH100, CH116, CH140 (UNII-2C) |
| Mode 16 | TX AC (VHT20) Mode / CH100, CH116, CH140 (UNII-2C) |
| Mode 17 | TX AC (VHT40) Mode / CH102, CH110, CH134 (UNII-2C) |
| Mode 18 | TX AC (VHT80) Mode / CH106, CH122 (UNII-2C) |
| Mode 19 | TX A Mode / CH149,CH157,CH165 (UNII-3) |
| Mode 22 | TX AC (VHT20) Mode / CH149,CH157,CH165 (UNII-3) |
| Mode 23 | TX AC (VHT40) Mode / CH151,CH159 (UNII-3) |
| Mode 24 | TX AC (VHT80) Mode / CH155 (UNII-3) |

Note:

- (1) For radiated emission below 1 GHz test, the IEEE 802.11ac20 is found to be the worst case and recorded.
- (2) For radiated emission above 1 GHz test, 1GHz~26.5GHz and 26.5GHz~40GHz have been pre-tested and in this report only recorded the worst case. The remaining spurious points are all below the limit value of 20dB.

2.3 PARAMETERS OF TEST SOFTWARE

Non-Beamforming

| UNII-1 - 4TX | | | |
|----------------------|--------|------|------|
| Test Software | QATool | | |
| Test Frequency (MHz) | 5180 | 5200 | 5240 |
| IEEE 802.11a | 10 | 0E | 11 |
| Test Frequency (MHz) | 5180 | 5200 | 5240 |
| IEEE 802.11n (HT20) | 0F | 0F | 0F |
| Test Frequency (MHz) | 5190 | 5230 | |
| IEEE 802.11n (HT40) | 0C | 0F | |

| UNII-2A - 4TX | | | |
|----------------------|--------|------|------|
| Test Software | QATool | | |
| Test Frequency (MHz) | 5260 | 5300 | 5320 |
| IEEE 802.11a | 4 | 4 | 4 |
| Test Frequency (MHz) | 5260 | 5300 | 5320 |
| IEEE 802.11n (HT20) | 3 | 3 | 3 |
| Test Frequency (MHz) | 5270 | 5310 | |
| IEEE 802.11n (HT40) | 3 | 3 | |

| UNII-2C - 4TX | | | |
|----------------------|--------|------|------|
| Test Software | QATool | | |
| Test Frequency (MHz) | 5500 | 5580 | 5700 |
| IEEE 802.11a | 2 | 6 | 1 |
| Test Frequency (MHz) | 5500 | 5580 | 5700 |
| IEEE 802.11n (HT20) | 2 | 4 | 1 |
| Test Frequency (MHz) | 5510 | 5550 | 5670 |
| IEEE 802.11n (HT40) | 3 | 5 | 5 |

| UNII-3 - 4TX | | | |
|----------------------|--------|------|------|
| Test Software | QATool | | |
| Test Frequency (MHz) | 5745 | 5785 | 5825 |
| IEEE 802.11a | 9 | 9 | 9 |
| Test Frequency (MHz) | 5745 | 5785 | 5825 |
| IEEE 802.11n (HT20) | 9 | 0D | 0C |
| Test Frequency (MHz) | 5755 | 5795 | |
| IEEE 802.11n (HT40) | 0F | 0E | |

| UNII-1 - 4TX | | | |
|-----------------------|--------|------|------|
| Test Software | QATool | | |
| Test Frequency (MHz) | 5180 | 5200 | 5240 |
| IEEE 802.11ac (VHT20) | 0F | 0F | 0F |
| Test Frequency (MHz) | 5190 | 5230 | |
| IEEE 802.11ac (VHT40) | 0C | 0F | |
| Test Frequency (MHz) | 5210 | | |
| IEEE 802.11ac (VHT80) | 9 | | |

| UNII-2A - 4TX | | | |
|-----------------------|--------|------|------|
| Test Software | QATool | | |
| Test Frequency (MHz) | 5260 | 5300 | 5320 |
| IEEE 802.11ac (VHT20) | 3 | 3 | 3 |
| Test Frequency (MHz) | 5270 | 5310 | |
| IEEE 802.11ac (VHT40) | 3 | 3 | |
| Test Frequency (MHz) | 5290 | | |
| IEEE 802.11ac (VHT80) | 3 | | |

| UNII-2C - 4TX | | | |
|-----------------------|--------|------|------|
| Test Software | QATool | | |
| Test Frequency (MHz) | 5500 | 5580 | 5700 |
| IEEE 802.11ac (VHT20) | 2 | 4 | 1 |
| Test Frequency (MHz) | 5510 | 5550 | 5670 |
| IEEE 802.11ac (VHT40) | 3 | 5 | 5 |
| Test Frequency (MHz) | 5530 | 5610 | |
| IEEE 802.11ac (VHT80) | 4 | 5 | |

| UNII-3 - 4TX | | | |
|-----------------------|--------|------|------|
| Test Software | QATool | | |
| Test Frequency (MHz) | 5745 | 5785 | 5825 |
| IEEE 802.11ac (VHT20) | 9 | 0D | 0C |
| Test Frequency (MHz) | 5755 | 5795 | |
| IEEE 802.11ac (VHT40) | 0F | 0E | |
| Test Frequency (MHz) | 5775 | | |
| IEEE 802.11ac (VHT80) | 0F | | |

Beamforming

| UNII-1 - 4TX | | | |
|----------------------|--------|------|------|
| Test Software | QATool | | |
| Test Frequency (MHz) | 5180 | 5200 | 5240 |
| IEEE 802.11n (HT20) | 0F | 0F | 0F |
| Test Frequency (MHz) | 5190 | 5230 | |
| IEEE 802.11n (HT40) | 0C | 0F | |

| UNII-2A - 4TX | | | |
|----------------------|--------|------|------|
| Test Software | QATool | | |
| Test Frequency (MHz) | 5260 | 5300 | 5320 |
| IEEE 802.11n (HT20) | 3 | 3 | 3 |
| Test Frequency (MHz) | 5270 | 5310 | |
| IEEE 802.11n (HT40) | 3 | 3 | |

| UNII-2C - 4TX | | | |
|----------------------|--------|------|------|
| Test Software | QATool | | |
| Test Frequency (MHz) | 5500 | 5580 | 5700 |
| IEEE 802.11n (HT20) | 2 | 4 | 1 |
| Test Frequency (MHz) | 5510 | 5550 | 5670 |
| IEEE 802.11n (HT40) | 3 | 5 | 5 |

| UNII-3 - 4TX | | | |
|----------------------|--------|------|------|
| Test Software | QATool | | |
| Test Frequency (MHz) | 5745 | 5785 | 5825 |
| IEEE 802.11n (HT20) | 9 | 0D | 0C |
| Test Frequency (MHz) | 5755 | 5795 | |
| IEEE 802.11n (HT40) | 0F | 0E | |

| UNII-1 - 4TX | | | |
|-----------------------|--------|------|------|
| Test Software | QATool | | |
| Test Frequency (MHz) | 5180 | 5200 | 5240 |
| IEEE 802.11ac (VHT20) | 0F | 0F | 0F |
| Test Frequency (MHz) | 5190 | 5230 | |
| IEEE 802.11ac (VHT40) | 0C | 0F | |
| Test Frequency (MHz) | 5210 | | |
| IEEE 802.11ac (VHT80) | 9 | | |

| UNII-2A - 4TX | | | |
|-----------------------|--------|------|------|
| Test Software | QATool | | |
| Test Frequency (MHz) | 5260 | 5300 | 5320 |
| IEEE 802.11ac (VHT20) | 3 | 3 | 3 |
| Test Frequency (MHz) | 5270 | 5310 | |
| IEEE 802.11ac (VHT40) | 3 | 3 | |
| Test Frequency (MHz) | 5290 | | |
| IEEE 802.11ac (VHT80) | 3 | | |

| UNII-2C - 4TX | | | |
|-----------------------|--------|------|------|
| Test Software | QATool | | |
| Test Frequency (MHz) | 5500 | 5580 | 5700 |
| IEEE 802.11ac (VHT20) | 2 | 4 | 1 |
| Test Frequency (MHz) | 5510 | 5550 | 5670 |
| IEEE 802.11ac (VHT40) | 3 | 5 | 5 |
| Test Frequency (MHz) | 5530 | 5610 | |
| IEEE 802.11ac (VHT80) | 4 | 5 | |

| UNII-3 - 4TX | | | |
|-----------------------|--------|------|------|
| Test Software | QATool | | |
| Test Frequency (MHz) | 5745 | 5785 | 5825 |
| IEEE 802.11ac (VHT20) | 9 | 0D | 0C |
| Test Frequency (MHz) | 5755 | 5795 | |
| IEEE 802.11ac (VHT40) | 0F | 0E | |
| Test Frequency (MHz) | 5775 | | |
| IEEE 802.11ac (VHT80) | 0F | | |

2.4 DUTY CYCLE

If duty cycle is $\geq 98\%$, duty factor is not required.
 If duty cycle is $< 98\%$, duty factor shall be considered.
 The output power = measured power + duty factor.

IEEE 802.11a

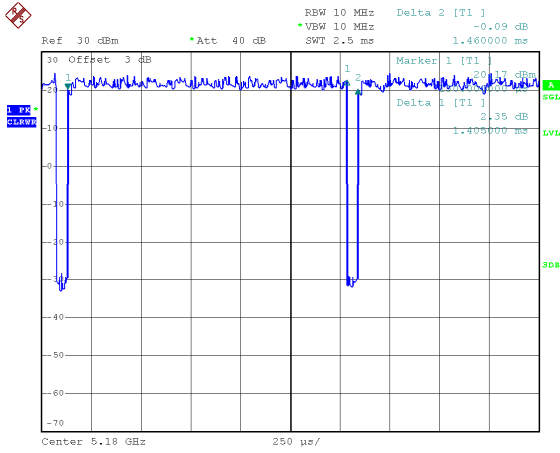

IEEE 802.11n (HT20)

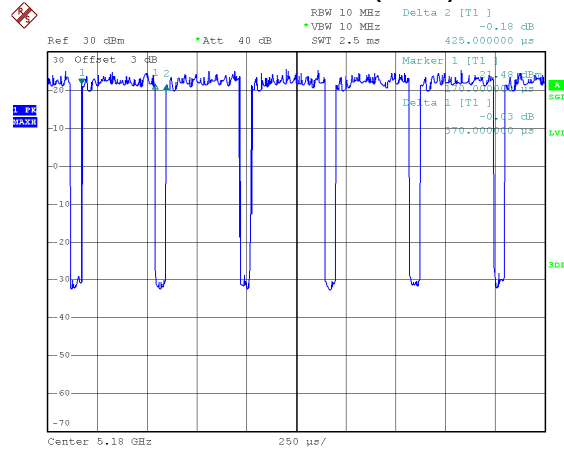

Date: 13.FEB.2020 09:25:26

Duty cycle = $1.405 \text{ ms} / 1.460 \text{ ms} = 96.23\%$
 Duty Factor = $10 * \log(1 / \text{Duty cycle}) = 0.17 \text{ dB}$

Date: 13.FEB.2020 09:34:13

Duty cycle = $0.370 \text{ ms} / 0.425 \text{ ms} = 87.06\%$
 Duty Factor = $10 * \log(1 / \text{Duty cycle}) = 0.60 \text{ dB}$

IEEE 802.11n (HT40)

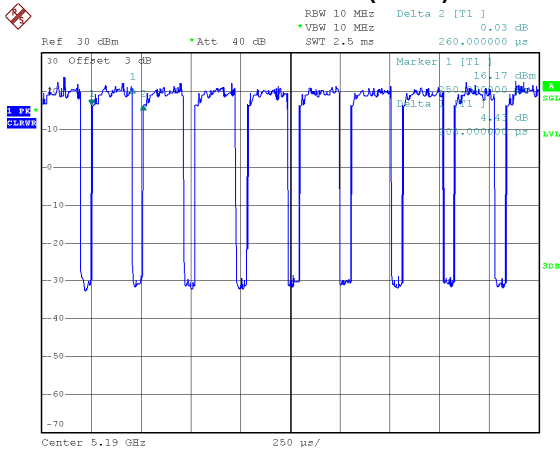

IEEE 802.11ac (VHT20)

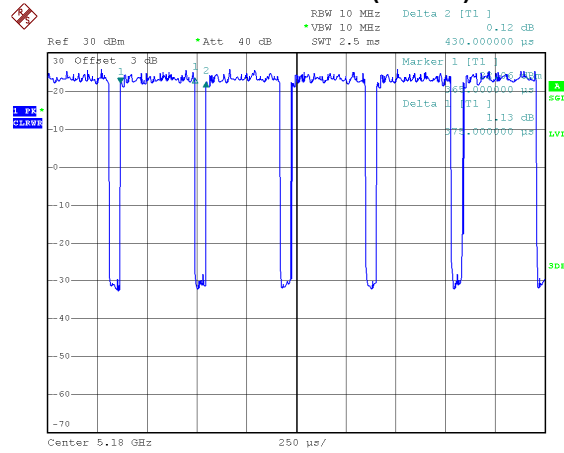

Date: 13.FEB.2020 09:39:32

Duty cycle = $0.205 \text{ ms} / 0.260 \text{ ms} = 78.85\%$
 Duty Factor = $10 * \log(1 / \text{Duty cycle}) = 1.03 \text{ dB}$

Date: 13.FEB.2020 09:37:36

Duty cycle = $0.375 \text{ ms} / 0.430 \text{ ms} = 87.21\%$
 Duty Factor = $10 * \log(1 / \text{Duty cycle}) = 0.59 \text{ dB}$

IEEE 802.11ac (VHT40)

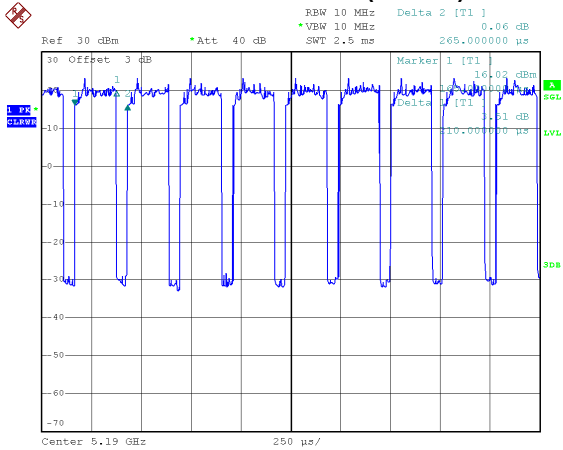

Date: 13.FEB.2020 09:38:31

Duty cycle = 0.210 ms / 0.265 ms = 79.25%
 Duty Factor = 10 * log(1 / Duty cycle) = 1.01 dB

IEEE 802.11ac (VHT80)

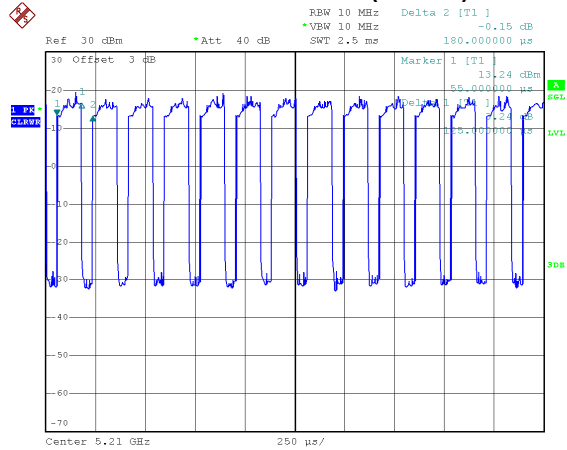

Date: 13.FEB.2020 09:38:49

Duty cycle = 0.125 ms / 0.180 ms = 69.44%
 Duty Factor = 10 * log(1 / Duty cycle) = 1.58 dB

NOTE:

For IEEE 802.11a, IEEE 802.11n (HT20) and IEEE 802.11ac (VHT20):
 For radiated emissions frequency above 1 GHz, the resolution bandwidth of test receiver/spectrum analyzer is 1 MHz and the video bandwidth is 2.67 kHz (Duty cycle < 98%).
 For IEEE 802.11n (HT40) and IEEE 802.11ac (VHT40):
 For radiated emissions frequency above 1 GHz, the resolution bandwidth of test receiver/spectrum analyzer is 1 MHz and the video bandwidth is 4.88 kHz (Duty cycle < 98%).
 For IEEE 802.11ac (VHT80):
 For radiated emissions frequency above 1 GHz, the resolution bandwidth of test receiver/spectrum analyzer is 1 MHz and the video bandwidth is 8 kHz (Duty cycle < 98%).

2.5 BLOCK DIAGRAM SHOWING THE CONFIGURATION OF SYSTEM TESTED

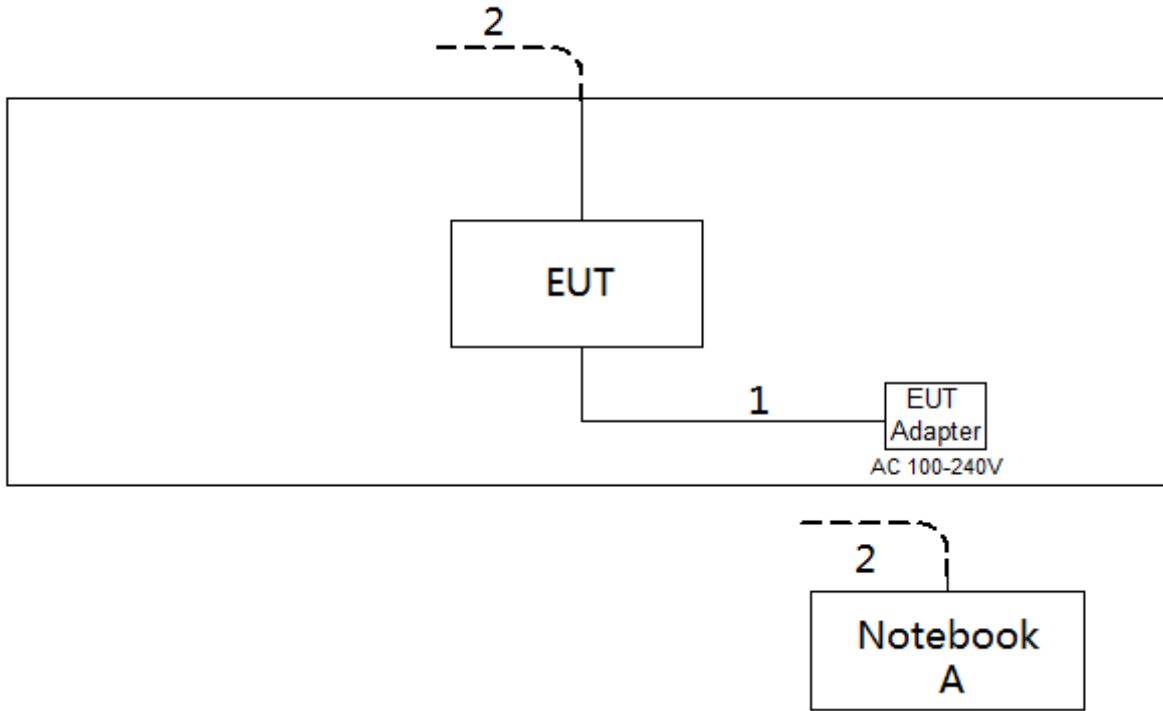

2.6 SUPPORT UNITS

| Item | Equipment | Brand | Model No. | Series No. |
|------|-----------|--------|-----------|------------|
| A | Notebook | Lenovo | #P152014 | N/A |

| Item | Cable Type | Shielded Type | Ferrite Core | Length |
|------|------------|---------------|--------------|--------|
| 1 | DC Cable | NO | NO | 1.5m |
| 2 | RJ45 Cable | NO | NO | 10m |

3. AC POWER LINE CONDUCTED EMISSIONS TEST

3.1 LIMIT

| Frequency (MHz) | Limit (dB μ V) | |
|-----------------|--------------------|-----------|
| | Quasi-peak | Average |
| 0.15 - 0.5 | 66 to 56* | 56 to 46* |
| 0.50 - 5.0 | 56 | 46 |
| 5.0 - 30.0 | 60 | 50 |

NOTE:

- (1) The tighter limit applies at the band edges.
- (2) The limit of " * " marked band means the limitation decreases linearly with the logarithm of the frequency in the range.

The following table is the setting of the receiver

| Receiver Parameter | Setting |
|--------------------|----------|
| Attenuation | 10 dB |
| Start Frequency | 0.15 MHz |
| Stop Frequency | 30 MHz |
| IF Bandwidth | 9 KHz |

3.2 TEST PROCEDURE

- a. The EUT was placed 0.8 meters from the horizontal ground plane with EUT being connected to the power mains through a line impedance stabilization network (LISN). All other support equipment powered from additional LISN(s). The LISN provide 50 Ohm/ 50uH of coupling impedance for the measuring instrument.
- b. Interconnecting cables that hang closer than 40 cm to the ground plane shall be folded back and forth in the center forming a bundle 30 to 40 cm long.
- c. I/O cables that are not connected to a peripheral shall be bundled in the center. The end of the cable may be terminated, if required, using the correct terminating impedance. The overall length shall not exceed 1 m.
- d. LISN at least 80 cm from nearest part of EUT chassis.
- e. For the actual test configuration, please refer to the related Item -EUT Test Photos.

3.3 DEVIATION FROM TEST STANDARD

No deviation

3.4 TEST SETUP

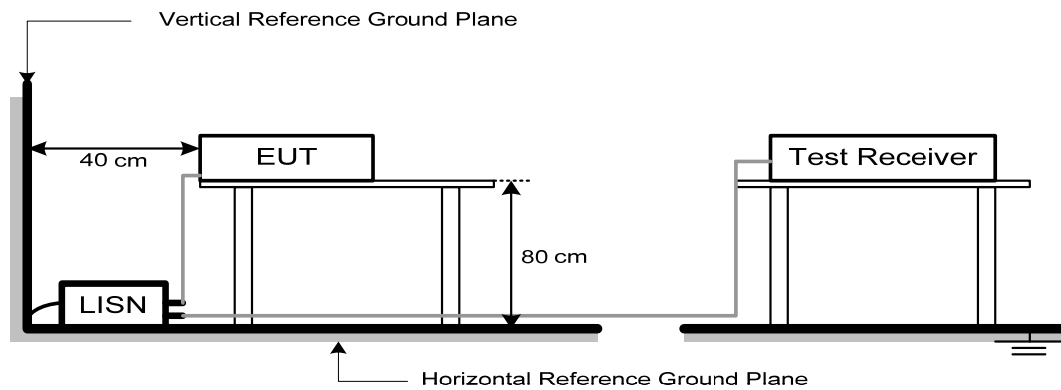

3.5 EUT OPERATION CONDITIONS

The EUT was configured for testing in a typical fashion (as a customer would normally use it). The EUT has been programmed to continuously transmit during test. This operating condition was tested and used to collect the included data.

The EUT was programmed to be in continuously transmitting/TX mode.

3.6 TEST RESULTS

Please refer to the APPENDIX A.

4. RADIATED EMISSIONS TEST

4.1 LIMIT

In case the emission fall within the restricted band specified on 15.205(a), then the 15.209(a) limit in the table below has to be followed.

LIMITS OF RADIATED EMISSIONS MEASUREMENT (9 kHz to 1000 MHz)

| Frequency (MHz) | Field Strength (microvolts/meter) | Measurement Distance (meters) |
|-----------------|-----------------------------------|-------------------------------|
| 0.009-0.490 | 2400/F(kHz) | 300 |
| 0.490-1.705 | 24000/F(kHz) | 30 |
| 1.705-30.0 | 30 | 30 |
| 30-88 | 100 | 3 |
| 88-216 | 150 | 3 |
| 216-960 | 200 | 3 |
| Above 960 | 500 | 3 |

LIMITS OF UNWANTED EMISSION OUT OF THE RESTRICTED BANDS

| Frequency (MHz) | EIRP Limit (dBm/MHz) | Equivalent Field Strength at 3m (dBμV/m) |
|-----------------|----------------------|--|
| 5150-5250 | -27 | 68.3 |
| 5250-5350 | -27 | 68.3 |
| 5470-5725 | -27 | 68.3 |
| 5725-5850 | -27 NOTE (2) | 68.3 |
| | 10 NOTE (2) | 105.3 |
| | 15.6 NOTE (2) | 110.9 |
| | 27 NOTE (2) | 122.3 |

NOTE:

(1) The following formula is used to convert the equipment isotropic radiated power (eirp) to field strength:

$$E = \frac{1000000\sqrt{30P}}{3} \mu\text{V/m, where P is the eirp (Watts)}$$

(2) According to 15.407(b)(4)(i), all emissions shall be limited to a level of -27 dBm/MHz at 75 MHz or more above or below the band edge increasing linearly to 10 dBm/MHz at 25 MHz above or below the band edge, and from 25 MHz above or below the band edge increasing linearly to a level of 15.6 dBm/MHz at 5 MHz above or below the band edge, and from 5 MHz above or below the band edge increasing linearly to a level of 27 dBm/MHz at the band edge.

4.2 TEST PROCEDURE

- a. The measuring distance of 3 m shall be used for measurements. The EUT was placed on the top of a rotating table 0.8 meter above the ground at a 3 meter semi-anechoic chamber. The table was rotated 360 degrees to determine the position of the highest radiation.(below 1GHz)
- b. The measuring distance of 3 m shall be used for measurements. The EUT was placed on the top of a rotating table 1.5 meter above the ground at a 3 meter semi-anechoic chamber. The table was rotated 360 degrees to determine the position of the highest radiation.(above 1GHz)
- c. The height of the equipment or of the substitution antenna shall be 0.8m or 1.5m; the height of the test antenna shall vary between 1 m to 4 m. Both horizontal and vertical polarizations of the antenna are set to make the measurement.
- d. For each suspected emission, the EUT was arranged to its worst case and then the antenna was tuned to heights find the maximum reading (used Bore sight function).
- e. The receiver system was set to peak and average detect function and specified bandwidth with maximum hold mode when the test frequency is above 1 GHz.
- f. The initial step in collecting radiated emission data is a receiver peak detector mode pre-scanning the measurement frequency range. Significant peaks are then marked and then Quasi Peak detector mode re-measured.
- g. All readings are Peak unless otherwise stated QP in column of Note. Peak denotes that the Peak reading compliance with the QP Limits and then QP Mode measurement didn't perform.
(below 1 GHz)
- h. All readings are Peak Mode value unless otherwise stated AVG in column of Note. If the Peak Mode Measured value compliance with the Peak Limits and lower than AVG Limits, the EUT shall be deemed to meet both Peak & AVG Limits and then only Peak Mode was measured, but AVG Mode didn't perform. (above 1 GHz)
- i. For the actual test configuration, please refer to the related Item –EUT Test Photos.

4.3 DEVIATION FROM TEST STANDARD

No deviation

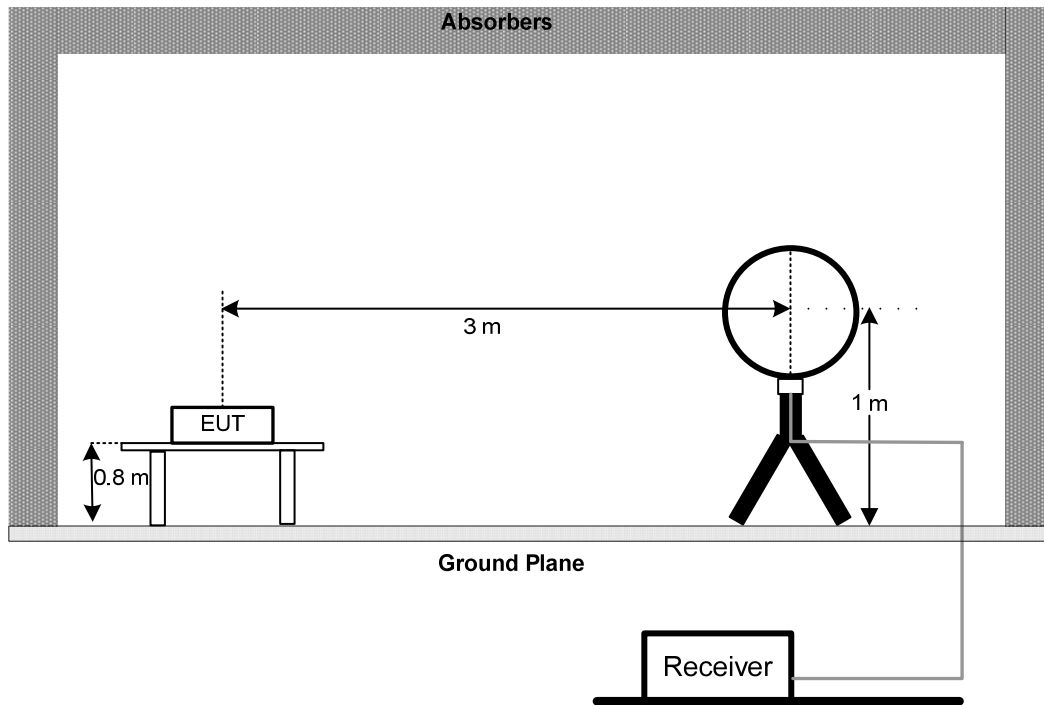
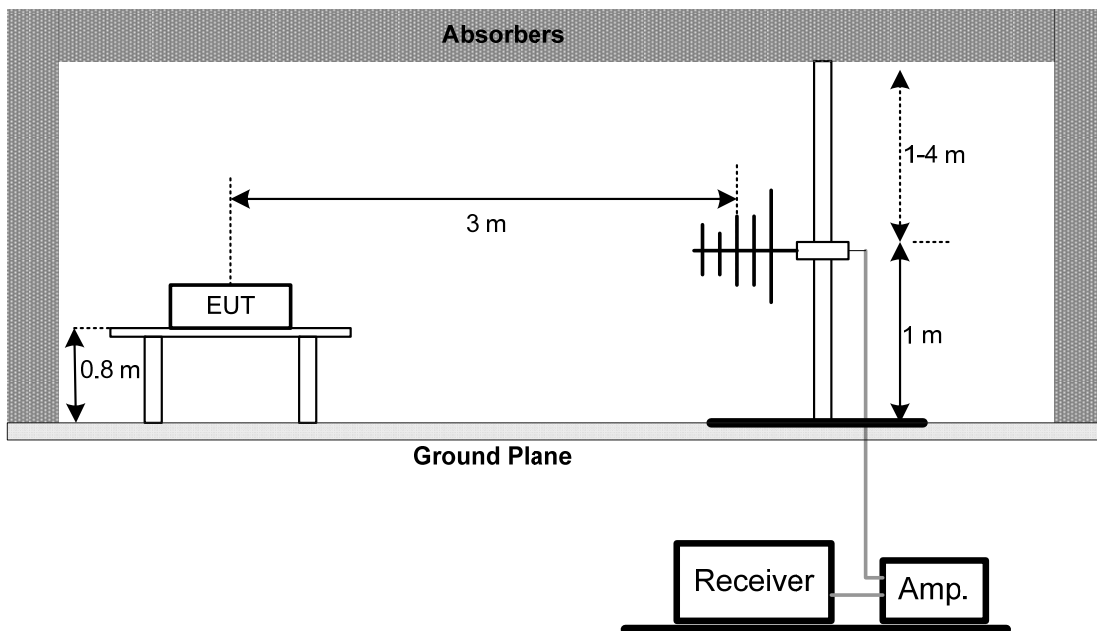
4.4 TEST SETUP**9 kHz to 30 MHz****30 MHz to 1 GHz**

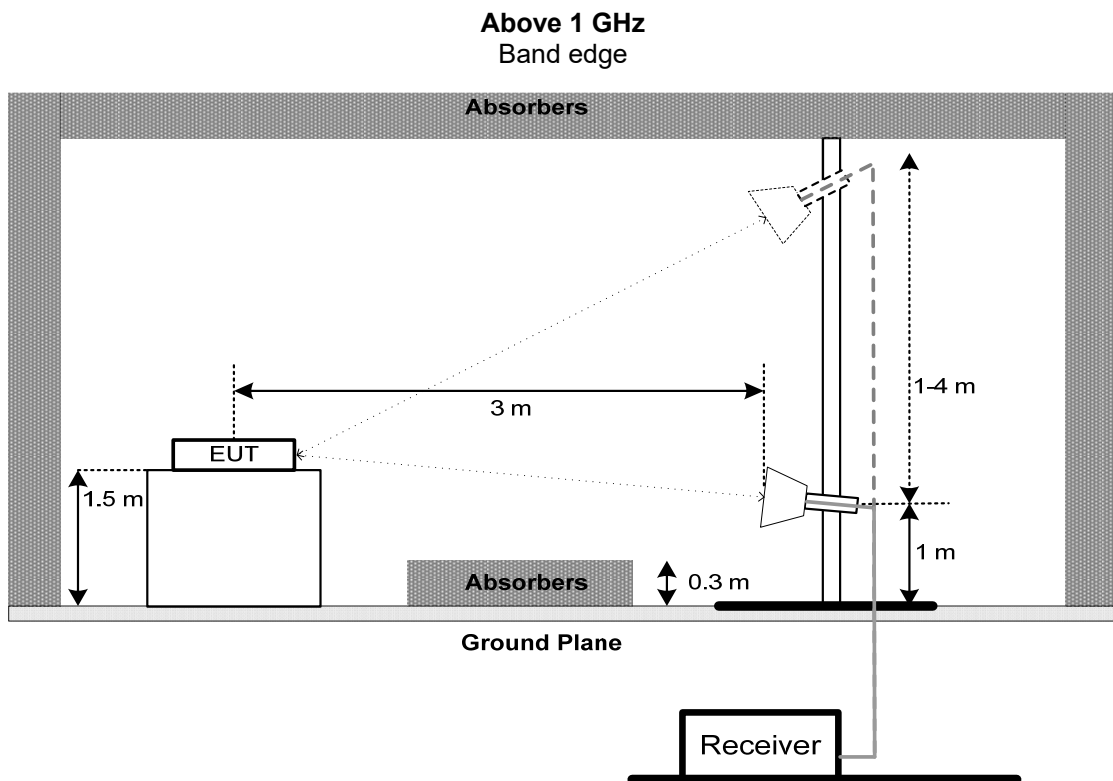
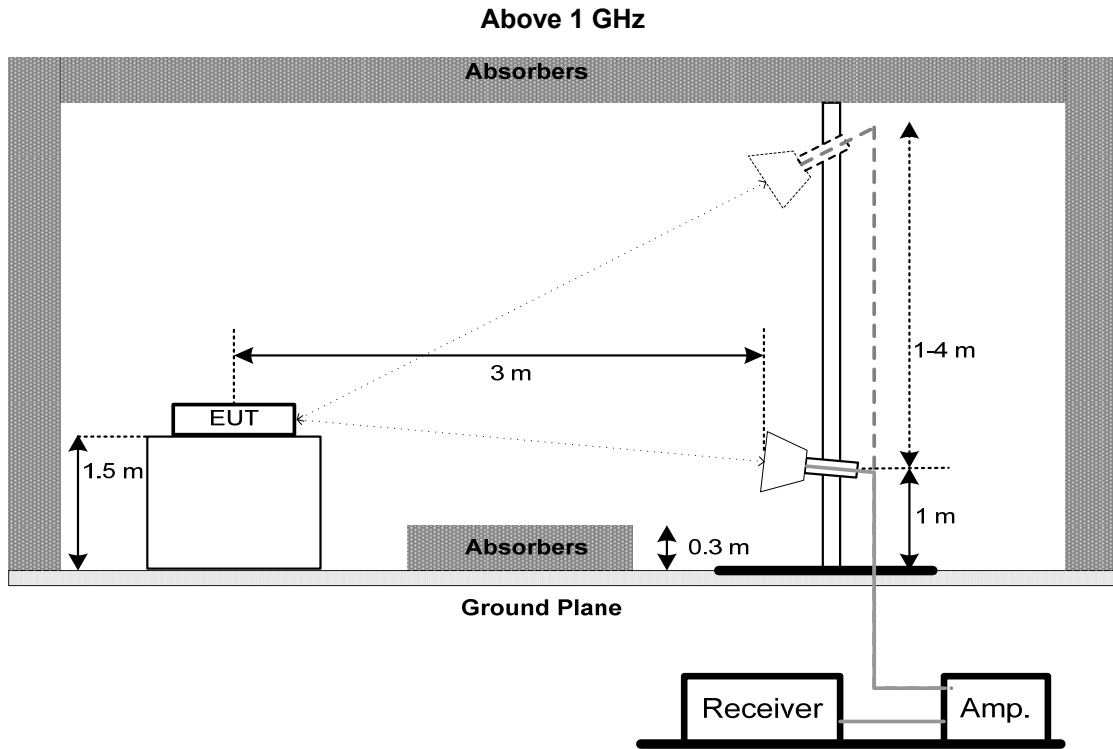

4.5 EUT OPERATION CONDITIONS

The EUT tested system was configured as the statements of 3.5 unless otherwise a special operating condition is specified in the follows during the testing.

4.6 TEST RESULTS - 9 KHZ to 30 MHZ

Please refer to the APPENDIX B

Remark:

- (1) The amplitude of spurious emissions which are attenuated by more than 20 dB below the permissible value has no need to be reported.
- (2) Distance extrapolation factor = $40 \log(\text{specific distance} / \text{test distance})$ (dB).
- (3) Limit line = specific limits (dBuV) + distance extrapolation factor.

4.7 TEST RESULTS - 30 MHz TO 1000 MHz

Please refer to the APPENDIX C.

4.8 TEST RESULTS - ABOVE 1000 MHz

Please refer to the APPENDIX D.

Remark:

- (1) No limit: This is fundamental signal, the judgment is not applicable.
For fundamental signal judgment was referred to Peak output test.

5. BANDWIDTH TEST

5.1 LIMIT

| FCC Part15, Subpart E (15.407) | | | |
|--------------------------------|-----------------|-----------------|-----------------------|
| Section | Test Item | Limit | Frequency Range (MHz) |
| 15.407(a) | 26 dB Bandwidth | - | 5150-5250 |
| | 26 dB Bandwidth | - | 5250-5350 |
| 15.407(e) | 26 dB Bandwidth | - | 5470-5725 |
| | 6 dB Bandwidth | Minimum 500 kHz | 5725-5850 |

5.2 TEST PROCEDURE

- a. The EUT was directly connected to the spectrum analyzer and antenna output port as show in the block diagram below
- b. a. Spectrum Setting:
For UNII-1, UNII-2A, UNII-2C:

| Spectrum Parameter | Setting |
|--------------------|---|
| Attenuation | Auto |
| Span Frequency | > 26 dB Bandwidth |
| RBW | 300 kHz (Bandwidth 20 MHz) 1 MHz (Bandwidth 40 MHz and 80 MHz) |
| VBW | 1 MHz (Bandwidth 20 MHz) 3 MHz (Bandwidth 40 MHz and 80 MHz) |
| Detector | Peak |
| Trace | Max Hold |
| Sweep Time | Auto |

For UNII-3:

| Spectrum Parameter | Setting |
|--------------------|----------------|
| Attenuation | Auto |
| Span Frequency | 6 dB Bandwidth |
| RBW | 100 kHz |
| VBW | 300 kHz |
| Detector | Peak |
| Trace | Max Hold |
| Sweep Time | Auto |

- c. Measured the spectrum width with power higher than 26 dB below carrier

5.3 TEST PROCEDURE

No deviation.

5.4 TEST SETUP**5.5 EUT OPERATION CONDITIONS**

The EUT was programmed to be in continuously transmitting mode.

5.6 TEST RESULTS

Please refer to the APPENDIX E.

6. MAXIMUM OUTPUT POWER TEST

6.1 LIMIT

| FCC Part15, Subpart E (15.407) | | | |
|--------------------------------|------------------------|--|-----------------------|
| Section | Test Item | Limit | Frequency Range (MHz) |
| 15.407(a) | Conducted Output Power | AP device: 1 Watt (30 dBm) Client device: 250 mW (24 dBm) | 5150-5250 |
| | | 250 mW (24 dBm) | 5250-5350 |
| | | 250 mW (24 dBm) | 5470-5725 |
| | | 1 Watt (30dBm) | 5725-5850 |

Note:

- a. For an outdoor access point operating in the band 5.15-5.25 GHz, the maximum conducted output power over the frequency band of operation shall not exceed 1 W provided the maximum antenna gain does not exceed 6 dBi. In addition, the maximum power spectral density shall not exceed 17 dBm in any 1 megahertz band. If transmitting antennas of directional gain greater than 6 dBi are used, both the maximum conducted output power and the maximum power spectral density shall be reduced by the amount in dB that the directional gain of the antenna exceeds 6 dBi. The maximum e.i.r.p. at any elevation angle above 30 degrees as measured from the horizon must not exceed 125 mW (21 dBm).
- b. For the 5.25-5.35 GHz and 5.47-5.725 GHz bands, the maximum conducted output power over the frequency bands of operation shall not exceed the lesser of 250 mW or 11 dBm + 10log B, where B is the 26dB Bandwidth in megahertz.

6.2 TEST PROCEDURE

- a. The EUT was directly connected to the power meter and antenna output port as show in the block diagram below.
- b. Test test was performed in accordance with method of FCC KDB 789033 D02 General UNII Test Procedures New Rules v02r01.

6.3 DEVIATION FROM STANDARD

No deviation.

6.4 TEST SETUP



6.5 EUT OPERATION CONDITIONS

The EUT was programmed to be in continuously transmitting mode.

6.6 TEST RESULTS

Please refer to the APPENDIX F.

7. POWER SPECTRAL DENSITY TEST

7.1 LIMIT

| FCC Part15, Subpart E (15.407) | | | |
|--------------------------------|------------------------|--|-----------------------|
| Section | Test Item | Limit | Frequency Range (MHz) |
| 15.407(a) | Power Spectral Density | AP device: 17 dBm/MHz Client device: 11 dBm/MHz | 5150-5250 |
| | | 11 dBm/MHz | 5250-5350 |
| | | 11 dBm/MHz | 5470-5725 |
| | | 30 dBm/500 kHz | 5725-5850 |

7.2 TEST PROCEDURE

- a. The EUT was directly connected to the spectrum analyzer and antenna output port as show in the block diagram below.
- b. Spectrum Setting

| Spectrum Parameter | Setting |
|--------------------|--|
| Attenuation | Auto |
| Span Frequency | Encompass the entire emissions bandwidth (EBW) of the signal |
| RBW | = 1 MHz. |
| VBW | ≥ 3 MHz. |
| Detector | RMS |
| Trace average | 100 trace |
| Sweep Time | Auto |

Note:

1. For UNII-3, according to KDB publication 789033 D02 General UNII Test Procedures New Rules v02r01, section II.F.5., it is acceptable to set RBW at 1 MHz and VBW at 3 MHz if the spectrum analyzer does not have 500 kHz RBW.
2. The value measured with RBW=1 MHz is to be added with $10\log(500 \text{ kHz}/1 \text{ MHz})$ which is -3 dB. For example, if the measured value is +10dBm using RBW=1 MHz (that is +10 dBm/MHz), then the converted value will be +7dBm/500kHz.

7.3 DEVIATION FROM STANDARD

No deviation.

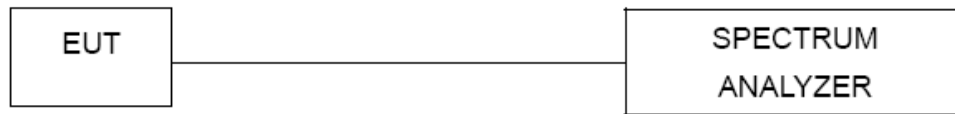
7.4 TEST SETUP**7.5 EUT OPERATION CONDITIONS**

The EUT was programmed to be in continuously transmitting mode.

7.6 TEST RESULTS

Please refer to the APPENDIX G.

8. FREQUENCY STABILITY MEASUREMENT

8.1 LIMIT

| FCC Part15, Subpart E (15.407) | | | |
|--------------------------------|---------------------|---|-----------------------|
| Section | Test Item | Limit | Frequency Range (MHz) |
| 15.407(g) | Frequency Stability | An emission is maintained within the band of operation under all conditions of normal operation as specified in the users manual. | 5150-5250 |
| | | | 5250-5350 |
| | | | 5470-5725 |
| | | | 5725-5850 |

8.2 TEST PROCEDURE

- a. The EUT was directly connected to the spectrum analyzer and antenna output port as show in the block diagram below.
- b. Spectrum Setting:

| Spectrum Parameter | Setting |
|--------------------|--|
| Attenuation | Auto |
| Span Frequency | Entire absence of modulation emissions bandwidth |
| RBW | 10 kHz |
| VBW | 10 kHz |
| Sweep Time | Auto |

- c. The test extreme voltage is to change the primary supply voltage from 85 to 115 percent of the nominal value.
- d. User manual temperature is 0°C~60°C.

8.3 DEVIATION FROM STANDARD

No deviation.

8.4 TEST SETUP

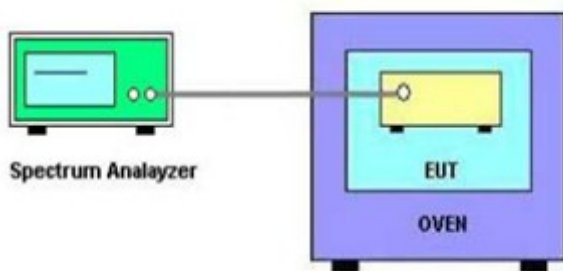

8.5 EUT OPERATION CONDITIONS

The EUT was programmed to be in continuously transmitting mode.

8.6 TEST RESULTS

Please refer to the APPENDIX H.

9. MEASUREMENT INSTRUMENTS LIST

| AC Power Line Conducted Emissions | | | | | |
|-----------------------------------|--------------------------------------|--------------|--------------------------|------------|------------------|
| Item | Kind of Equipment | Manufacturer | Type No. | Serial No. | Calibrated until |
| 1 | Line Impedance Stabilisation Network | Schwarzbeck | NNLK 8121 | 8121-822 | Mar. 21, 2021 |
| 2 | TWO-LINE V-NETWORK | R&S | ENV216 | 101340 | Sep. 01, 2020 |
| 3 | Test Cable | emci | EMCRG400-BM-NM-10000 | 170628 | Jul. 15, 2020 |
| 4 | EMI Test Receiver | R&S | ESCI | 100082 | Mar. 28, 2021 |
| 5 | 50Ω Terminator | SHX | TF2-1G-A | 17051602 | Mar. 21, 2021 |
| 6 | 50Ω coaxial switch | Anritsu | MP59B | 6201750902 | Mar. 21, 2021 |
| 7 | Measurement Software | Farad | EZ-EMC Ver.NB-03A1-01 | N/A | N/A |

| Radiated Emissions - 30 MHz to 1 GHz | | | | | |
|--------------------------------------|--------------------------|--------------|--------------------------|------------|------------------|
| Item | Kind of Equipment | Manufacturer | Type No. | Serial No. | Calibrated until |
| 1 | TRILOG Broadband Antenna | Schwarzbeck | VULB 9168 | 719 | Mar. 28, 2021 |
| 2 | Pre-Amplifier | emci | EMC9135 | 980400 | Mar. 21, 2021 |
| 3 | MXE EMI Receiver | Keysight | N9038A | MY57150106 | Mar. 21, 2021 |
| 4 | Test Cable | emci | EMC104-SM-SM-7000 | 170330 | Apr. 16, 2021 |
| 5 | Test Cable | emci | EMC104-SM-SM-1000 | 170331 | Apr. 16, 2021 |
| 6 | Test Cable | emci | EMC104-SM-NM-3500 | 170621 | Apr. 16, 2021 |
| 7 | Measurement Software | Farad | EZ-EMC Ver.NB-03A1-01 | N/A | N/A |

| Radiated Emissions - Above 1 GHz | | | | | |
|----------------------------------|--------------------------------------|--------------|--------------------------|------------|------------------|
| Item | Kind of Equipment | Manufacturer | Type No. | Serial No. | Calibrated until |
| 1 | Double-Ridged Waveguide Horn Antenna | ETS-Lindgren | 9120D | 00206960 | Mar. 28, 2021 |
| 2 | Pre-Amplifier | emci | EMC012645SE | 980421 | Mar. 28, 2021 |
| 3 | EXA Spectrum Analyzer | Keysight | N9010A | MY56480545 | Mar. 21, 2021 |
| 4 | Test Cable | emci | EMC104-SM-SM-700 0 | 170330 | Apr. 16, 2021 |
| 5 | Test Cable | emci | EMC104-SM-SM-100 0 | 170331 | Apr. 16, 2021 |
| 6 | Test Cable | emci | EMC104-SM-NM-350 0 | 170621 | Apr. 16, 2021 |
| 7 | Measurement Software | Farad | EZ-EMC Ver.NB-03A1-01 | N/A | N/A |
| 8 | MXE EMI Receiver | Keysight | N9038A | MY57150106 | Mar. 28, 2021 |

| Bandwidth | | | | | |
|-----------|-------------------|--------------|----------|------------|------------------|
| Item | Kind of Equipment | Manufacturer | Type No. | Serial No. | Calibrated until |
| 1 | Spectrum Analyzer | R&S | FSP40 | 100626 | Mar. 21, 2021 |

| Conducted Output Power | | | | | |
|------------------------|-------------------|--------------|----------|------------|------------------|
| Item | Kind of Equipment | Manufacturer | Type No. | Serial No. | Calibrated until |
| 1 | Spectrum Analyzer | R&S | FSP40 | 100626 | Mar. 21, 2021 |

| Power Spectral Density | | | | | |
|------------------------|-------------------|--------------|----------|------------|------------------|
| Item | Kind of Equipment | Manufacturer | Type No. | Serial No. | Calibrated until |
| 1 | Spectrum Analyzer | R&S | FSP40 | 100626 | Mar. 21, 2021 |

| Frequency Stability | | | | | |
|---------------------|------------------------------|--------------|-----------|------------|------------------|
| Item | Kind of Equipment | Manufacturer | Type No. | Serial No. | Calibrated until |
| 1 | Spectrum Analyzer | R&S | FSP40 | 100626 | Mar. 21, 2021 |
| 2 | Temperature And Humidity Box | Blue pand | BPHS-120B | 170616454 | Mar. 21, 2021 |

Remark: "N/A" denotes no model name, serial no. or calibration specified.

All calibration period of equipment list is one year.

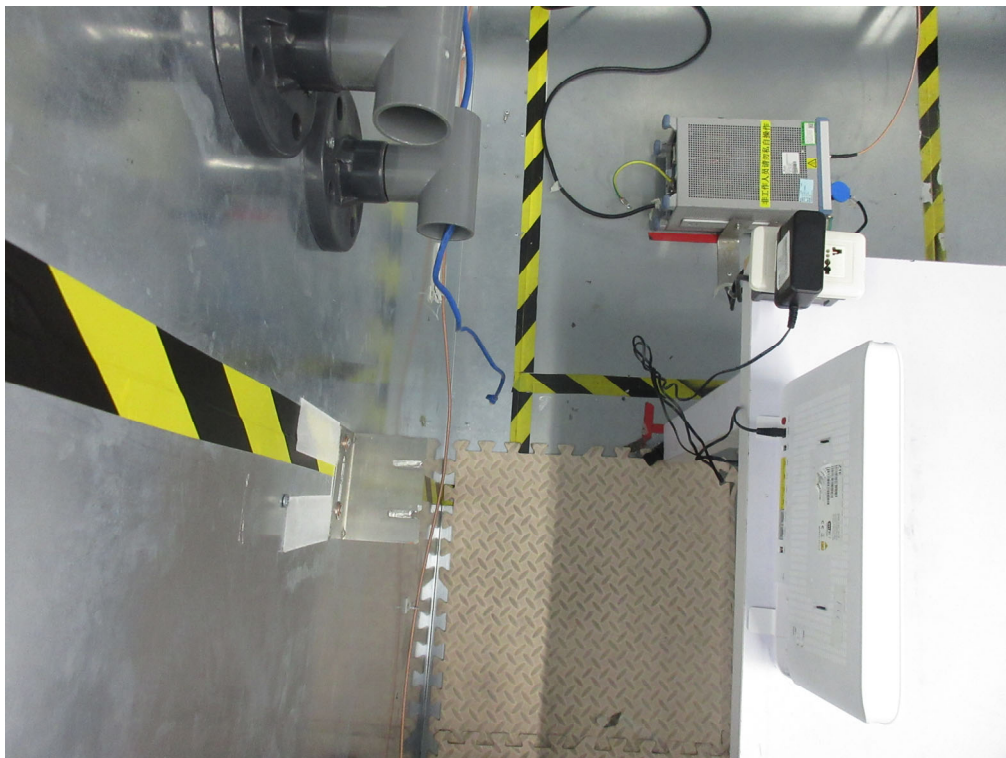
10. EUT TEST PHOTOS**Conducted Emissions Test Photos**

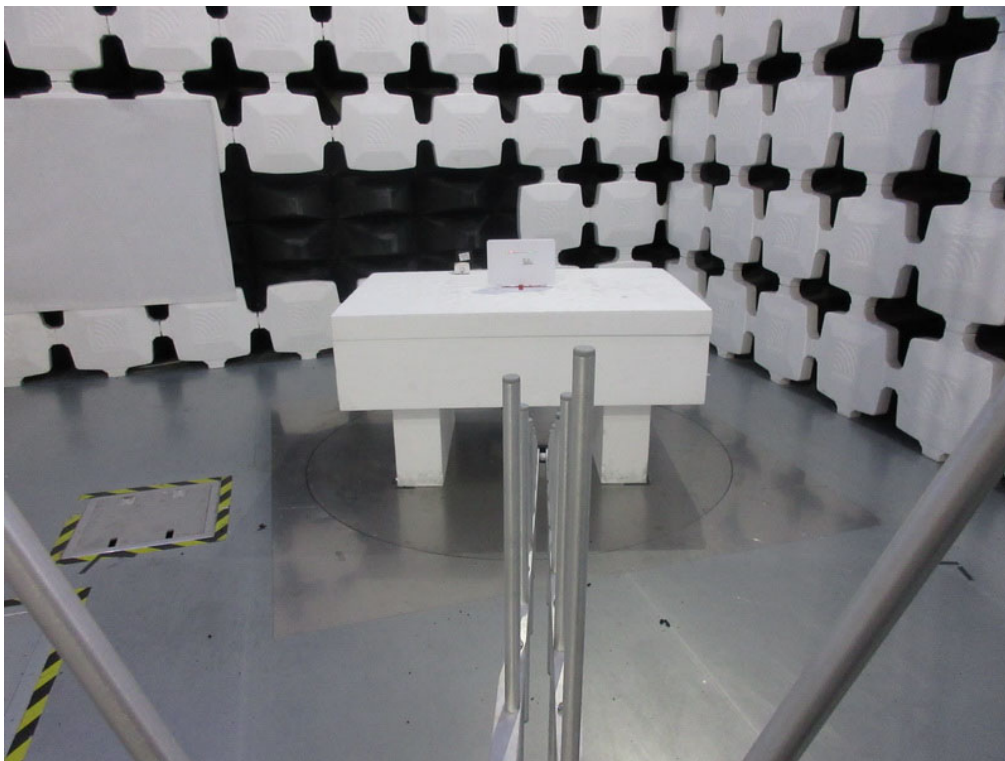
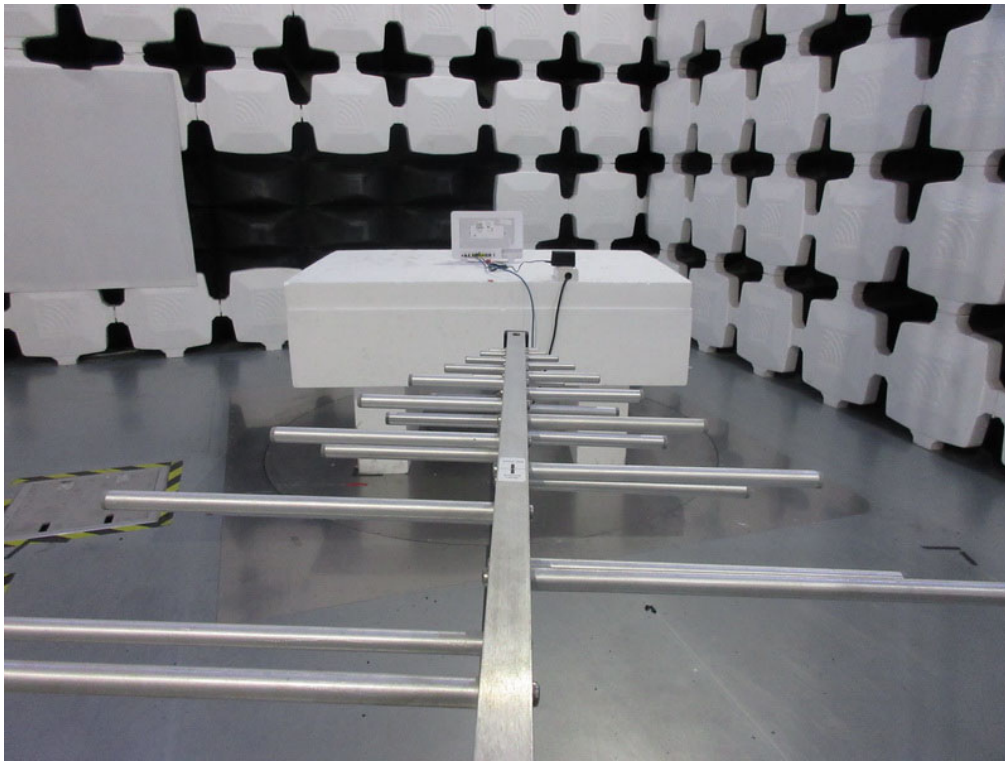
Radiated Emissions Test Photos**30 MHz to 1 GHz**

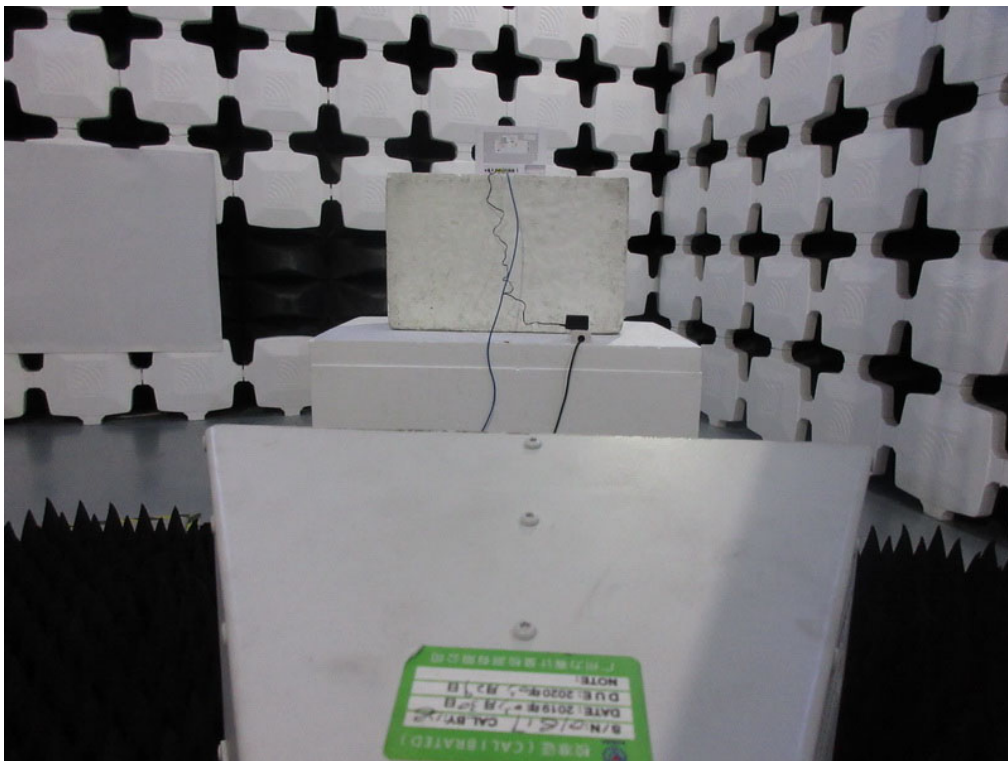
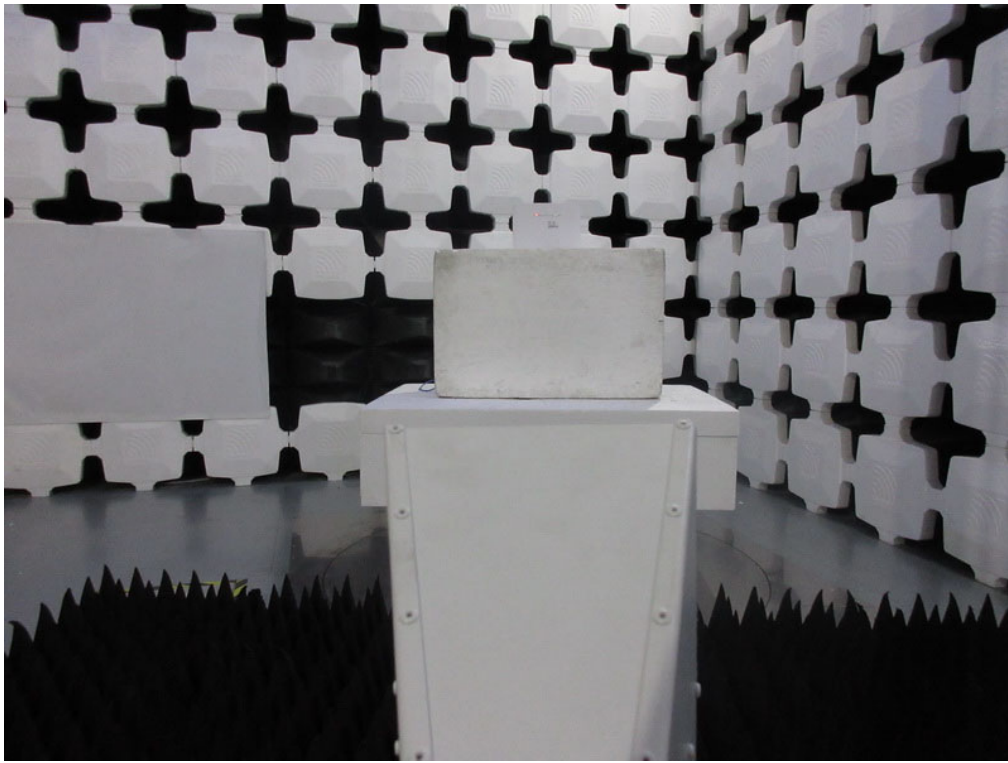
Radiated Emissions Test Photos**Above 1 GHz**

APPENDIX A - AC POWER LINE CONDUCTED EMISSIONS

Test Mode: TX Mode

Line

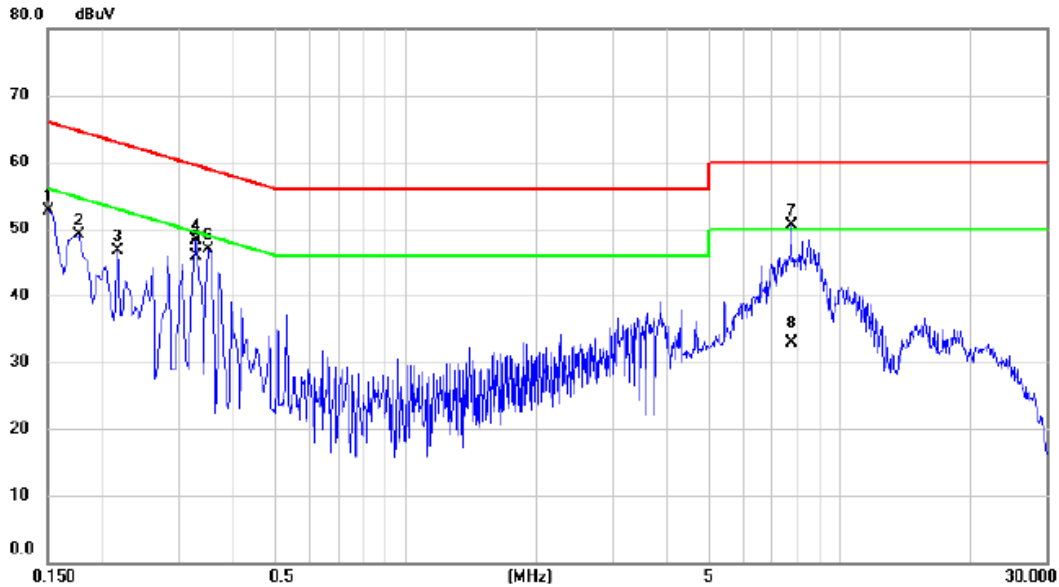

| No. | Mk. | Freq. MHz | Reading Level dBuV | Correct Factor dB | Measure- ment dBuV | Limit dBuV | Margin dB | Detector | Comment |
|-----|-----|--------------|--------------------------|-------------------------|--------------------------|---------------|--------------|----------|---------|
| 1 | | 0.1500 | 42.93 | 9.73 | 52.66 | 66.00 | -13.34 | peak | |
| 2 | | 0.1770 | 39.26 | 9.76 | 49.02 | 64.63 | -15.61 | peak | |
| 3 | | 0.2175 | 37.00 | 9.79 | 46.79 | 62.91 | -16.12 | peak | |
| 4 | | 0.3300 | 38.42 | 9.83 | 48.25 | 59.45 | -11.20 | peak | |
| 5 | * | 0.3300 | 36.08 | 9.83 | 45.91 | 49.45 | -3.54 | AVG | |
| 6 | | 0.3525 | 37.04 | 9.85 | 46.89 | 58.90 | -12.01 | peak | |
| 7 | | 7.7280 | 40.30 | 10.11 | 50.41 | 60.00 | -9.59 | peak | |
| 8 | | 7.7280 | 22.85 | 10.11 | 32.96 | 50.00 | -17.04 | AVG | |

REMARKS:

- (1) Measurement Value = Reading Level + Correct Factor.
- (2) Margin Level = Measurement Value - Limit Value.

Test Mode: TX Mode

Neutral

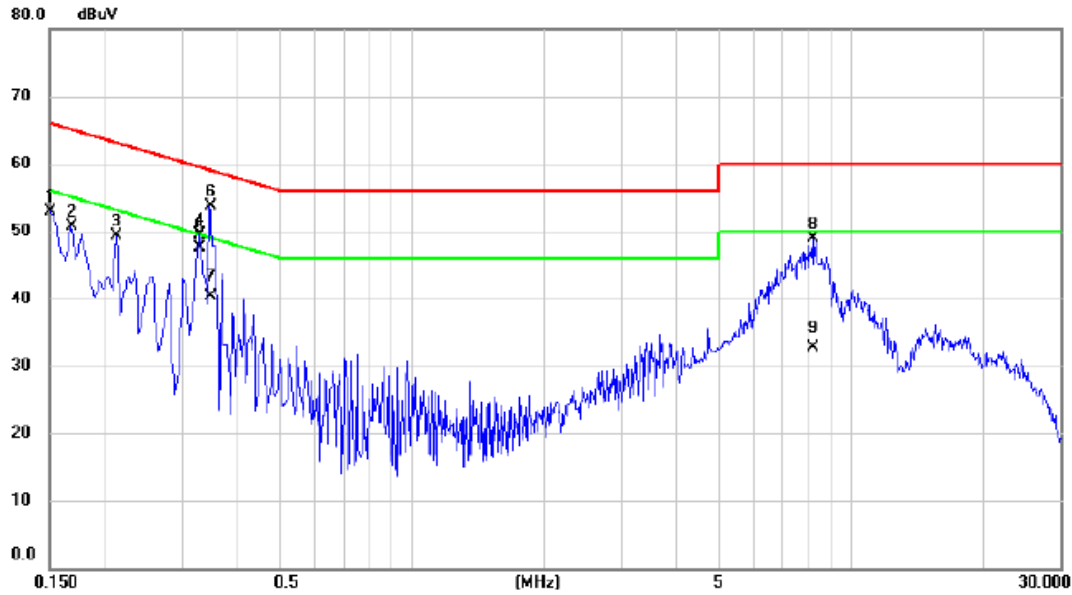

| No. | Mk. | Freq. MHz | Reading Level dBuV | Correct Factor dB | Measure- ment dBuV | Limit dBuV | Margin dB | Detector | Comment |
|-----|-----|--------------|--------------------------|-------------------------|--------------------------|---------------|--------------|----------|---------|
| 1 | | 0.1500 | 43.24 | 9.73 | 52.97 | 66.00 | -13.03 | peak | |
| 2 | | 0.1680 | 41.05 | 9.74 | 50.79 | 65.06 | -14.27 | peak | |
| 3 | | 0.2130 | 39.45 | 9.78 | 49.23 | 63.09 | -13.86 | peak | |
| 4 | | 0.3300 | 39.73 | 9.83 | 49.56 | 59.45 | -9.89 | peak | |
| 5 | * | 0.3300 | 37.61 | 9.83 | 47.44 | 49.45 | -2.01 | AVG | |
| 6 | | 0.3480 | 43.79 | 9.83 | 53.62 | 59.01 | -5.39 | peak | |
| 7 | | 0.3480 | 30.52 | 9.83 | 40.35 | 49.01 | -8.66 | AVG | |
| 8 | | 8.2320 | 38.75 | 10.13 | 48.88 | 60.00 | -11.12 | peak | |
| 9 | | 8.2320 | 22.61 | 10.13 | 32.74 | 50.00 | -17.26 | AVG | |

REMARKS:

- (1) Measurement Value = Reading Level + Correct Factor.
- (2) Margin Level = Measurement Value - Limit Value.

APPENDIX B - RADIATED EMISSION - 9 KHZ TO 30 MHZ

Note: Below 30MHz, The measured value have enough margin over 20dB than the limit,
therefore they are not reported

APPENDIX C - RADIATED EMISSION - 30 MHZ TO 1 GHZ

Test Mode: TX Mode

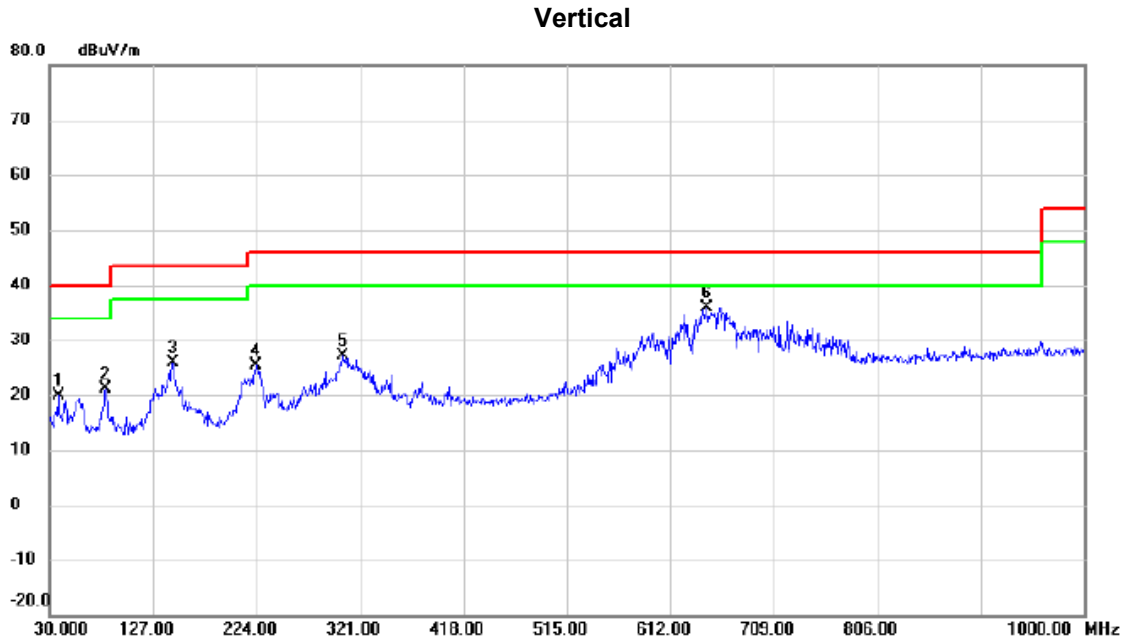

| No. | Mk. | Freq. MHz | Reading Level dBuV | Correct Factor dB | Measure- ment dBuV/m | Limit dBuV/m | Margin dB | Detector | Comment |
|-----|-----|--------------|--------------------------|-------------------------|----------------------------|-----------------|--------------|----------|---------|
| 1 | | 37.7600 | 36.47 | -16.66 | 19.81 | 40.00 | -20.19 | peak | |
| 2 | | 82.3800 | 41.58 | -20.34 | 21.24 | 40.00 | -18.76 | peak | |
| 3 | | 145.4300 | 41.11 | -15.21 | 25.90 | 43.50 | -17.60 | peak | |
| 4 | | 223.0300 | 43.11 | -17.79 | 25.32 | 46.00 | -20.68 | peak | |
| 5 | | 304.5100 | 41.38 | -14.25 | 27.13 | 46.00 | -18.87 | peak | |
| 6 | * | 646.9200 | 44.46 | -8.52 | 35.94 | 46.00 | -10.06 | peak | |

REMARKS:

- (1) Measurement Value = Reading Level + Correct Factor.
- (2) Margin Level = Measurement Value - Limit Value.

Test Mode: TX Mode

Horizontal

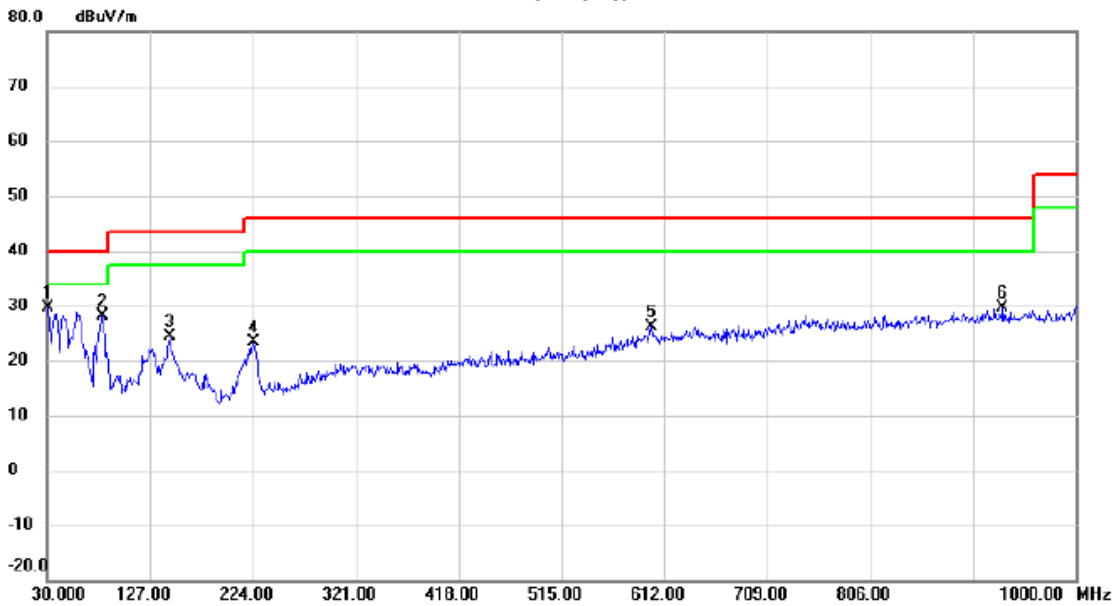

| No. | Mk. | Freq. MHz | Reading Level dBuV | Correct Factor dB | Measure- ment dBuV/m | Limit dBuV/m | Margin dB | Detector | Comment |
|-----|-----|--------------|--------------------------|-------------------------|----------------------------|-----------------|--------------|----------|---------|
| 1 | * | 30.0000 | 46.85 | -17.34 | 29.51 | 40.00 | -10.49 | peak | |
| 2 | | 82.3800 | 48.45 | -20.34 | 28.11 | 40.00 | -11.89 | peak | |
| 3 | | 145.4300 | 39.52 | -15.21 | 24.31 | 43.50 | -19.19 | peak | |
| 4 | | 224.0000 | 41.14 | -17.73 | 23.41 | 46.00 | -22.59 | peak | |
| 5 | | 599.3900 | 34.93 | -8.68 | 26.25 | 46.00 | -19.75 | peak | |
| 6 | | 931.1300 | 34.76 | -5.25 | 29.51 | 46.00 | -16.49 | peak | |

REMARKS:

- (1) Measurement Value = Reading Level + Correct Factor.
- (2) Margin Level = Measurement Value - Limit Value.

APPENDIX D - RADIATED EMISSION - ABOVE 1000 MHZ

| | |
|-----------------|---------------------------|
| Orthogonal Axis | X |
| Test Mode | UNII-1_TX A Mode 5180 MHz |

Vertical

130 dBuV/m

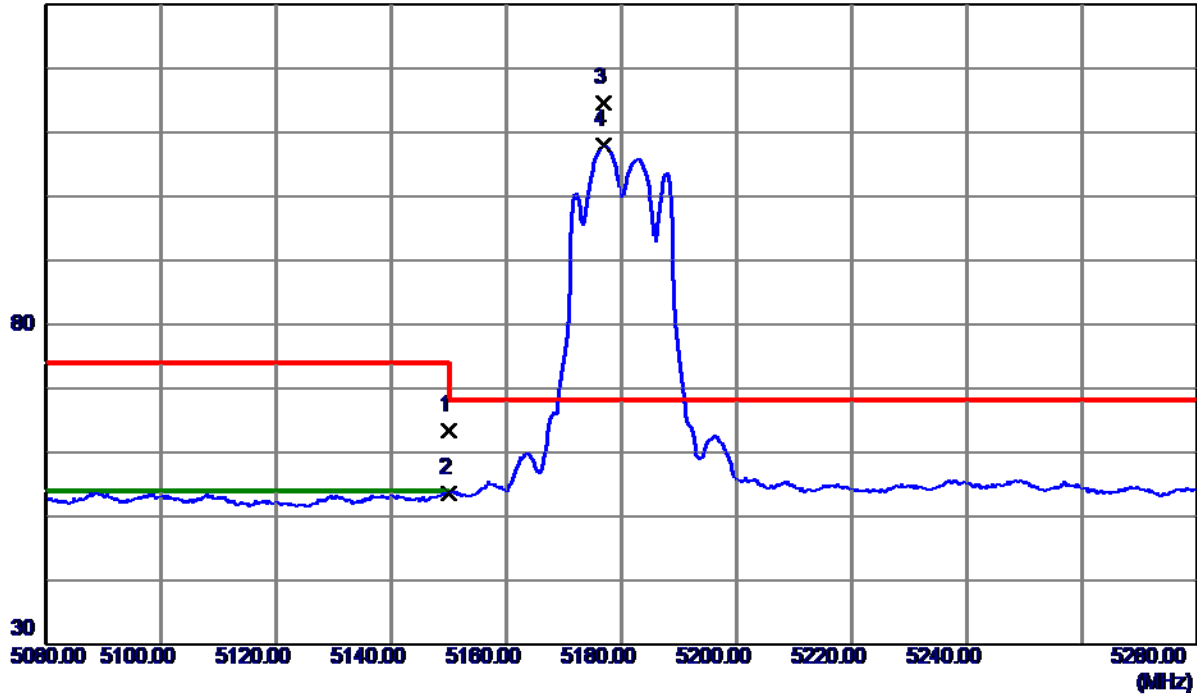

| No. | Freq. MHz | Reading Level dBuV/m | Correct Factor dB | Measure ment dBuV/m | Limit dBuV/m | Margin dB | Detector | Comment |
|-----|--------------|----------------------------|-------------------------|---------------------------|-----------------|--------------|----------|----------|
| 1 | 5150.0000 | 24.24 | 39.07 | 63.31 | 74.00 | -10.69 | Peak | |
| 2 | 5150.0000 | 14.61 | 39.07 | 53.68 | 54.00 | -0.32 | AVG | |
| 3 * | 5176.8000 | 75.52 | 39.10 | 114.62 | 68.30 | 46.32 | Peak | No Limit |
| 4 | 5176.8000 | 68.81 | 39.10 | 107.91 | 999.00 | -891.09 | AVG | No Limit |

REMARKS:

- (1) Measurement Value = Reading Level + Correct Factor.
- (2) Margin Level = Measurement Value - Limit Value.

| | |
|-----------------|---------------------------|
| Orthogonal Axis | X |
| Test Mode | UNII-1_TX A Mode 5180 MHz |

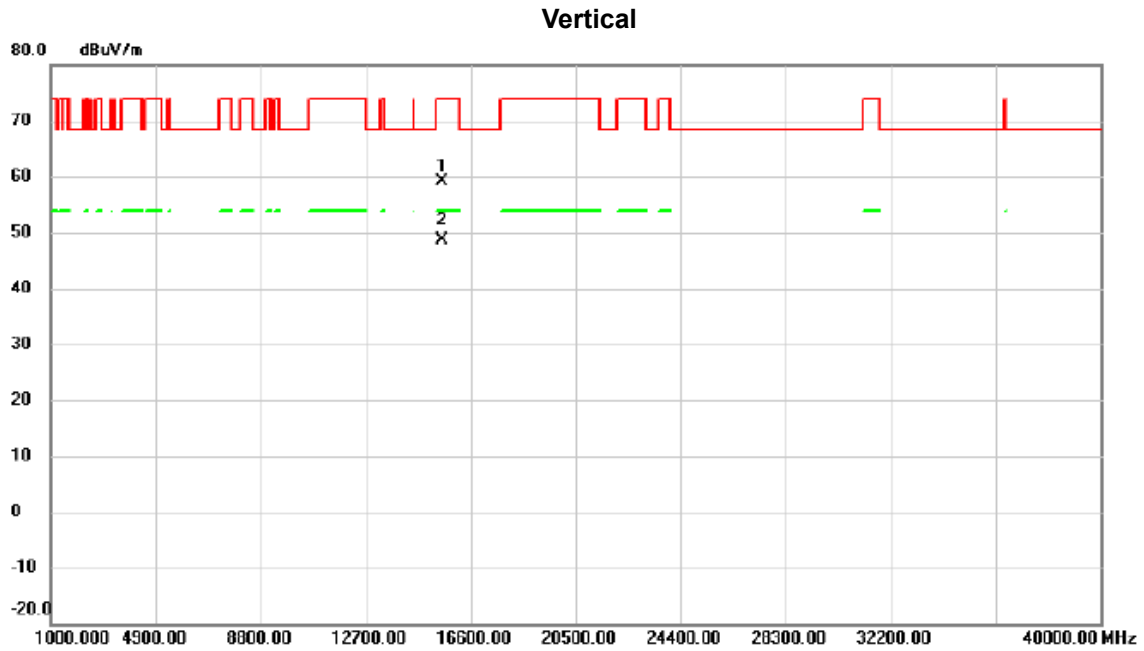

| No. | Mk. | Freq. MHz | Reading Level dBuV | Correct Factor dB | Measure- ment dBuV/m | Limit dBuV/m | Margin dB | Detector | Comment |
|-----|-----|--------------|--------------------------|-------------------------|----------------------------|-----------------|--------------|----------|---------|
| 1 | | 15534.30 | 55.92 | 3.13 | 59.05 | 74.00 | -14.95 | peak | |
| 2 | * | 15534.92 | 45.57 | 3.13 | 48.70 | 54.00 | -5.30 | AVG | |

REMARKS:

- (1) Measurement Value = Reading Level + Correct Factor.
- (2) Margin Level = Measurement Value - Limit Value.

| | |
|-----------------|---------------------------|
| Orthogonal Axis | X |
| Test Mode | UNII-1_TX A Mode 5180 MHz |

Horizontal

130 dBuV/m

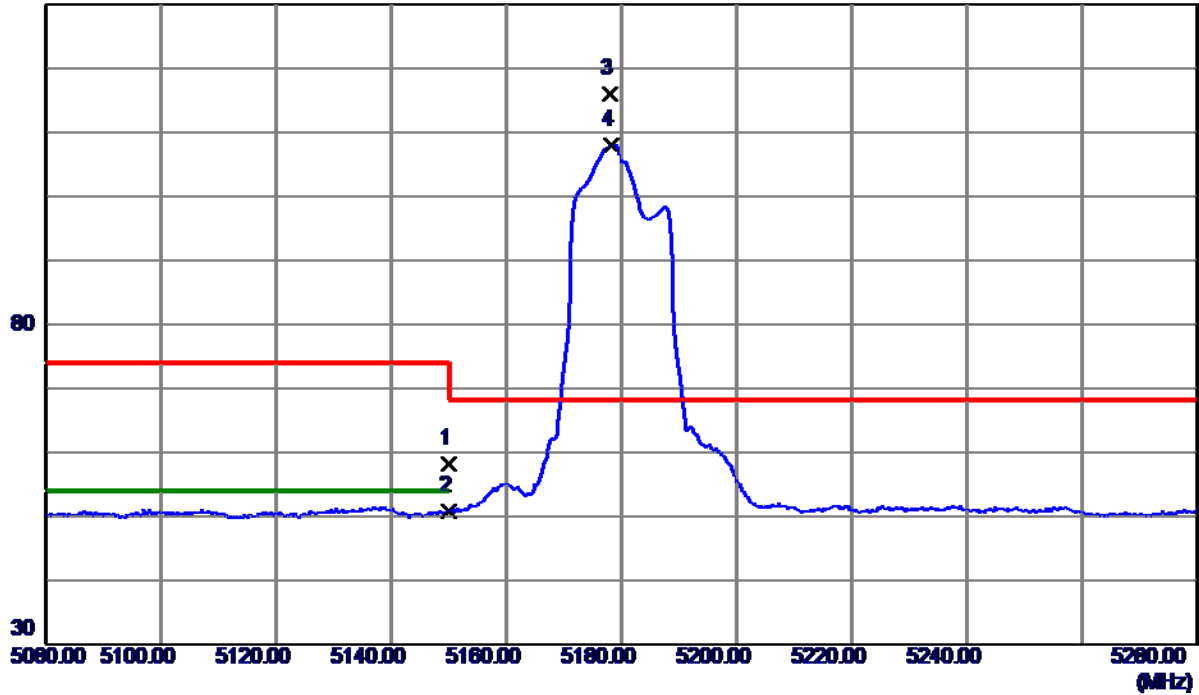

| No. | Freq. MHz | Reading Level dBuV/m | Correct Factor dB | Measure ment dBuV/m | Limit dBuV/m | Margin dB | Detector | Comment |
|-----|--------------|----------------------------|-------------------------|---------------------------|-----------------|--------------|----------|----------|
| 1 | 5150.0000 | 19.19 | 39.07 | 58.26 | 74.00 | -15.74 | Peak | |
| 2 | 5150.0000 | 11.82 | 39.07 | 50.89 | 54.00 | -3.11 | AVG | |
| 3 * | 5178.0000 | 76.97 | 39.10 | 116.07 | 68.30 | 47.77 | Peak | No Limit |
| 4 | 5178.2000 | 68.85 | 39.10 | 107.95 | 999.00 | -891.05 | AVG | No Limit |

REMARKS:

- (1) Measurement Value = Reading Level + Correct Factor.
- (2) Margin Level = Measurement Value - Limit Value.

| | |
|-----------------|---------------------------|
| Orthogonal Axis | X |
| Test Mode | UNII-1_TX A Mode 5180 MHz |

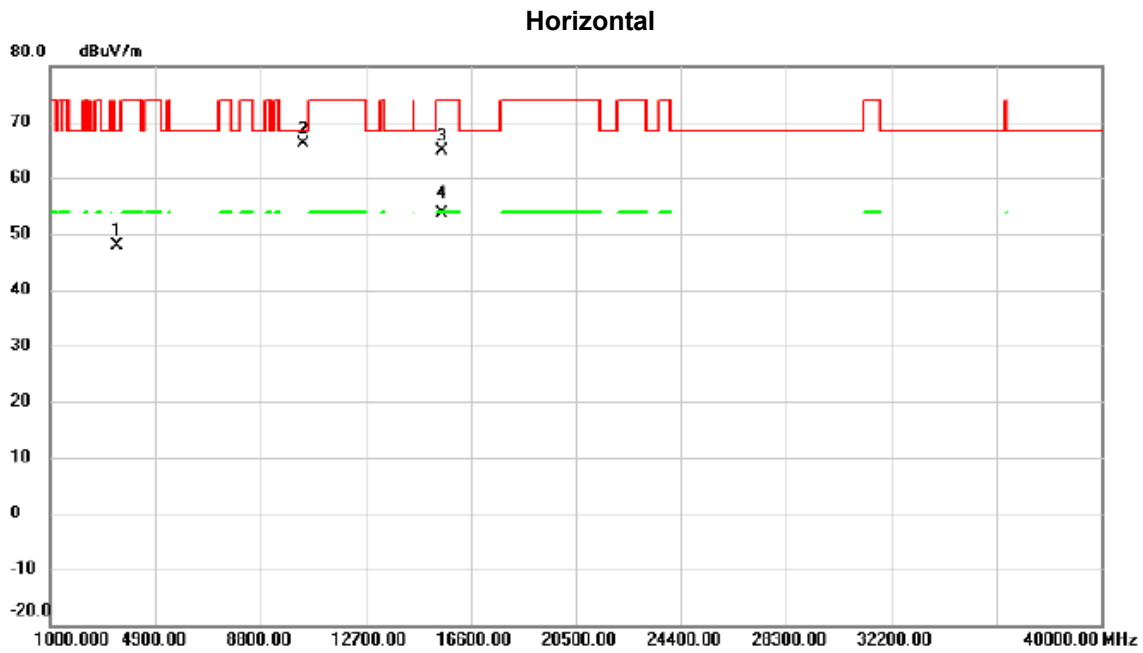

| No. | Mk. | Freq. MHz | Reading Level dBuV | Correct Factor dB | Measure- ment dBuV/m | Limit dBuV/m | Margin dB | Detector | Comment |
|-----|-----|--------------|--------------------------|-------------------------|----------------------------|-----------------|--------------|----------|---------|
| 1 | | 3453.450 | 65.45 | -17.69 | 47.76 | 68.30 | -20.54 | peak | |
| 2 | | 10365.56 | 67.82 | -1.64 | 66.18 | 68.30 | -2.12 | peak | |
| 3 | | 15535.48 | 61.66 | 3.13 | 64.79 | 74.00 | -9.21 | peak | |
| 4 | * | 15535.74 | 50.41 | 3.12 | 53.53 | 54.00 | -0.47 | AVG | |

REMARKS:

- (1) Measurement Value = Reading Level + Correct Factor.
- (2) Margin Level = Measurement Value - Limit Value.

| | |
|-----------------|---------------------------|
| Orthogonal Axis | X |
| Test Mode | UNII-1_TX A Mode 5200 MHz |

Vertical

130 dBuV/m

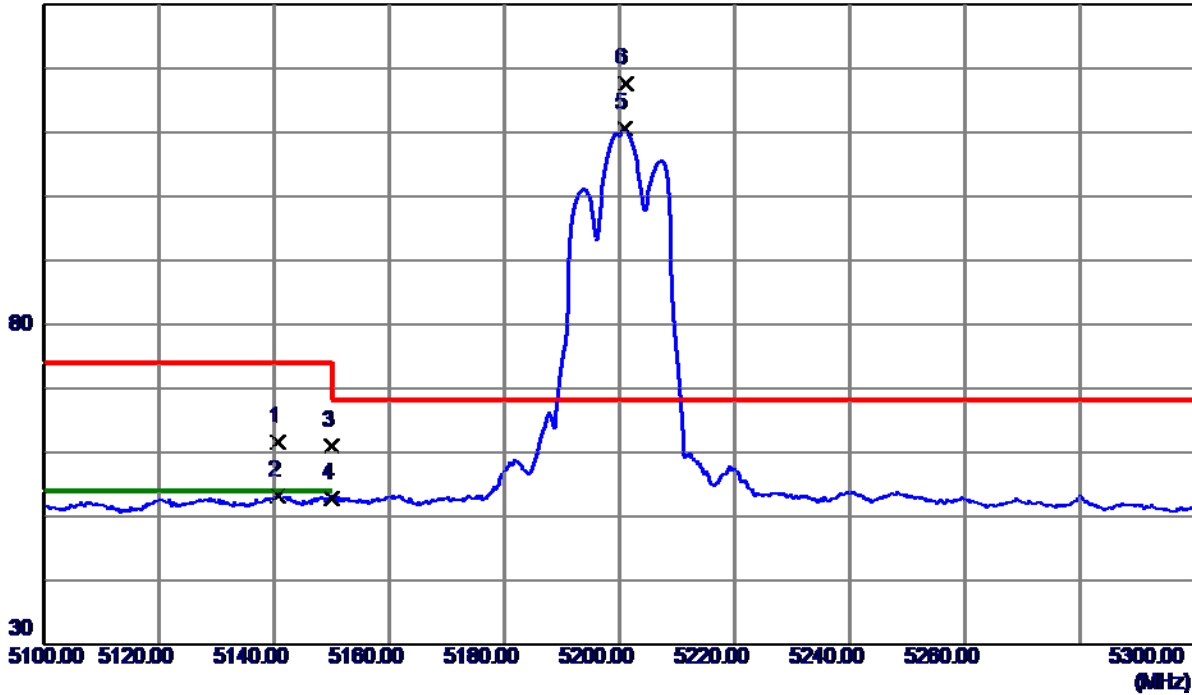

| No. | Freq. MHz | Reading Level dBuV/m | Correct Factor dB | Measure ment dBuV/m | Limit dBuV/m | Margin dB | Detector | Comment |
|-----|--------------|----------------------------|-------------------------|---------------------------|-----------------|--------------|----------|----------|
| 1 | 5140.6000 | 22.61 | 39.06 | 61.67 | 74.00 | -12.33 | Peak | |
| 2 | 5140.6000 | 14.14 | 39.06 | 53.20 | 54.00 | -0.80 | AVG | |
| 3 | 5150.0000 | 21.99 | 39.07 | 61.06 | 74.00 | -12.94 | Peak | |
| 4 | 5150.0000 | 13.80 | 39.07 | 52.87 | 54.00 | -1.13 | AVG | |
| 5 | 5200.8000 | 71.49 | 39.13 | 110.62 | 999.00 | -888.38 | AVG | No Limit |
| 6 * | 5201.0000 | 78.42 | 39.13 | 117.55 | 68.30 | 49.25 | Peak | No Limit |

REMARKS:

- (1) Measurement Value = Reading Level + Correct Factor.
- (2) Margin Level = Measurement Value - Limit Value.

| | |
|-----------------|---------------------------|
| Orthogonal Axis | X |
| Test Mode | UNII-1_TX A Mode 5200 MHz |

Vertical

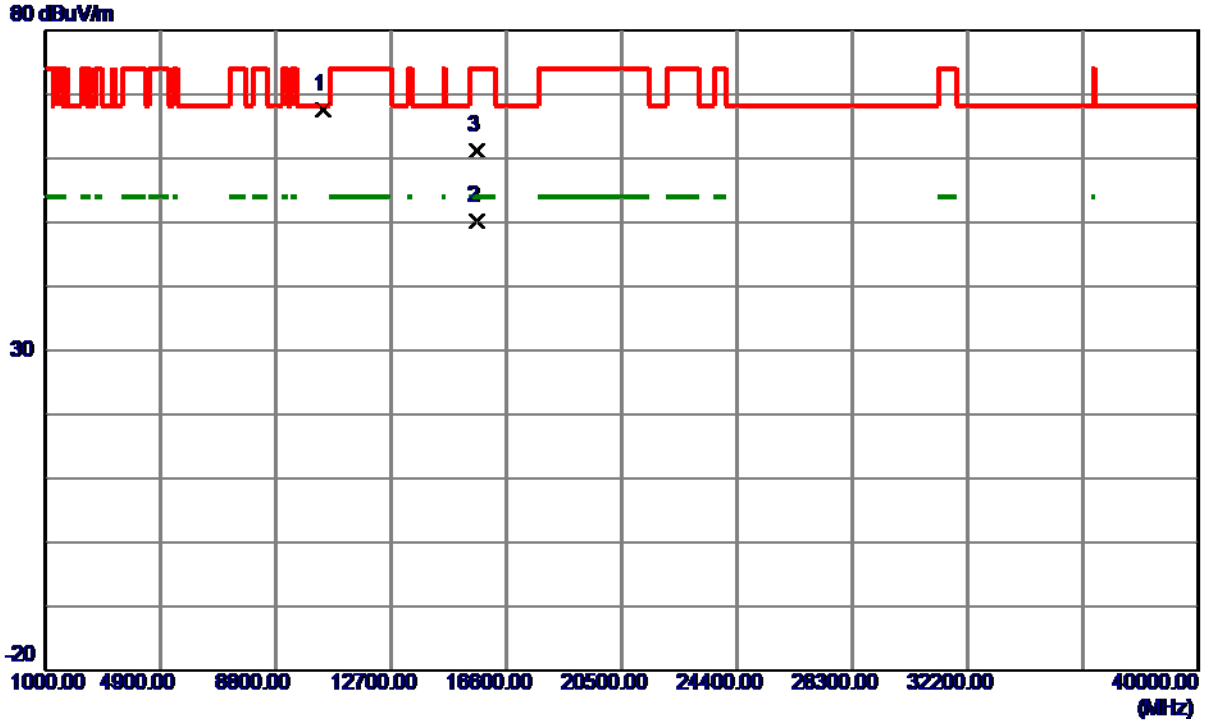

| No. | Freq. MHz | Reading Level dBuV/m | Correct Factor dB | Measure ment dBuV/m | Limit dBuV/m | Margin dB | Detector | Comment |
|-----|--------------|----------------------------|-------------------------|---------------------------|-----------------|--------------|----------|---------|
| 1 * | 10398.7000 | 69.27 | -1.61 | 67.66 | 68.30 | -0.64 | Peak | |
| 2 | 15597.6000 | 47.20 | 2.95 | 50.15 | 54.00 | -3.85 | AVG | |
| 3 | 15597.6600 | 58.34 | 2.95 | 61.29 | 74.00 | -12.71 | Peak | |

REMARKS:

- (1) Measurement Value = Reading Level + Correct Factor.
- (2) Margin Level = Measurement Value - Limit Value.

| | |
|-----------------|---------------------------|
| Orthogonal Axis | X |
| Test Mode | UNII-1_TX A Mode 5200 MHz |

Horizontal

130 dBuV/m

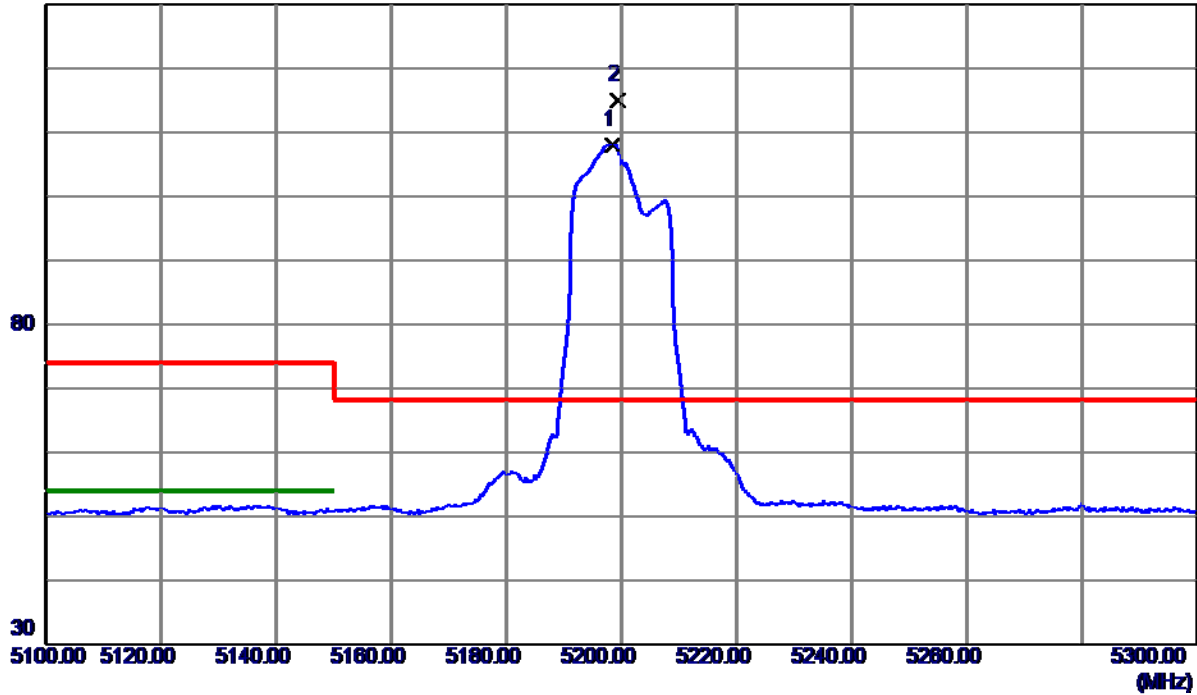

| No. | Freq. MHz | Reading Level dBuV/m | Correct Factor dB | Measure ment dBuV/m | Limit dBuV/m | Margin dB | Detector | Comment |
|-----|--------------|----------------------------|-------------------------|---------------------------|-----------------|--------------|----------|----------|
| 1 | 5198.4000 | 68.95 | 39.13 | 108.08 | 999.00 | -890.92 | AVG | No Limit |
| 2 * | 5199.4000 | 75.85 | 39.13 | 114.98 | 68.30 | 46.68 | Peak | No Limit |

REMARKS:

- (1) Measurement Value = Reading Level + Correct Factor.
- (2) Margin Level = Measurement Value - Limit Value.

| | |
|-----------------|---------------------------|
| Orthogonal Axis | X |
| Test Mode | UNII-1_TX A Mode 5200 MHz |

Horizontal

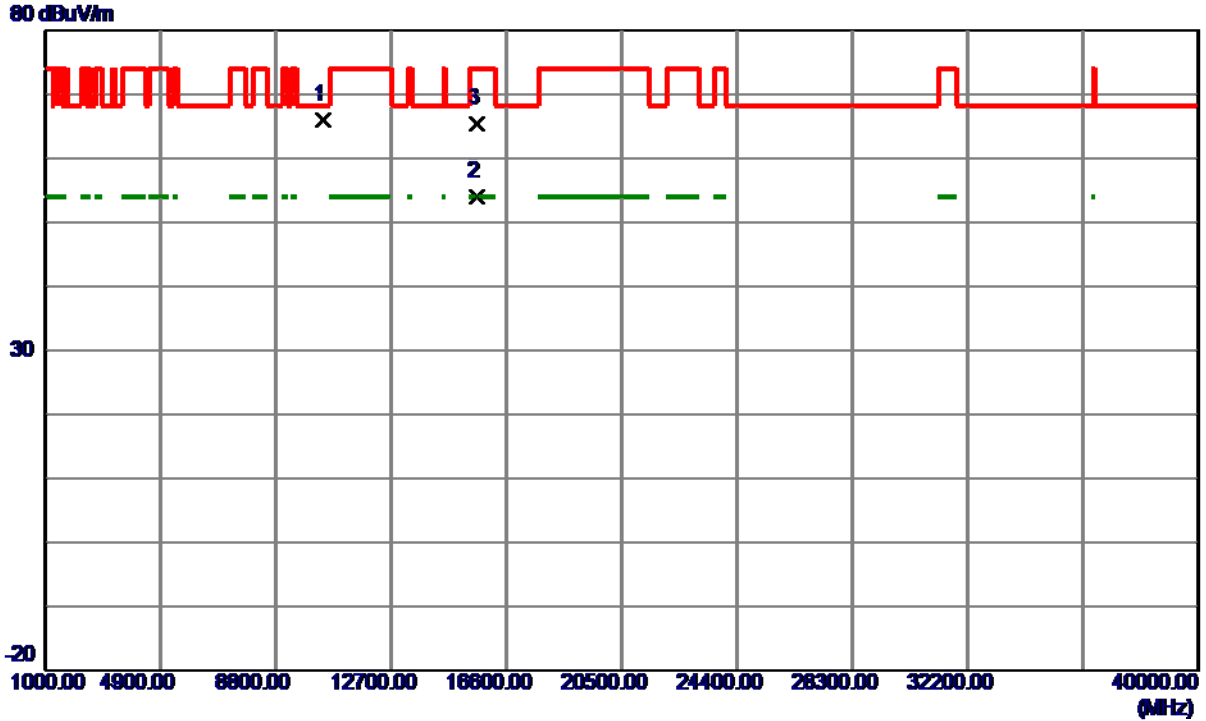

| No. | Freq. MHz | Reading Level dBuV/m | Correct Factor dB | Measure ment dBuV/m | Limit dBuV/m | Margin dB | Detector | Comment |
|-----|--------------|----------------------------|-------------------------|---------------------------|-----------------|--------------|----------|---------|
| 1 | 10401.6400 | 67.58 | -1.60 | 65.98 | 68.30 | -2.32 | Peak | |
| 2 * | 15595.6200 | 50.98 | 2.96 | 53.94 | 54.00 | -0.06 | AVG | |
| 3 | 15596.5200 | 62.54 | 2.95 | 65.49 | 74.00 | -8.51 | Peak | |

REMARKS:

- (1) Measurement Value = Reading Level + Correct Factor.
- (2) Margin Level = Measurement Value - Limit Value.

| | |
|-----------------|---------------------------|
| Orthogonal Axis | X |
| Test Mode | UNII-1_TX A Mode 5240 MHz |

Vertical

130 dBuV/m

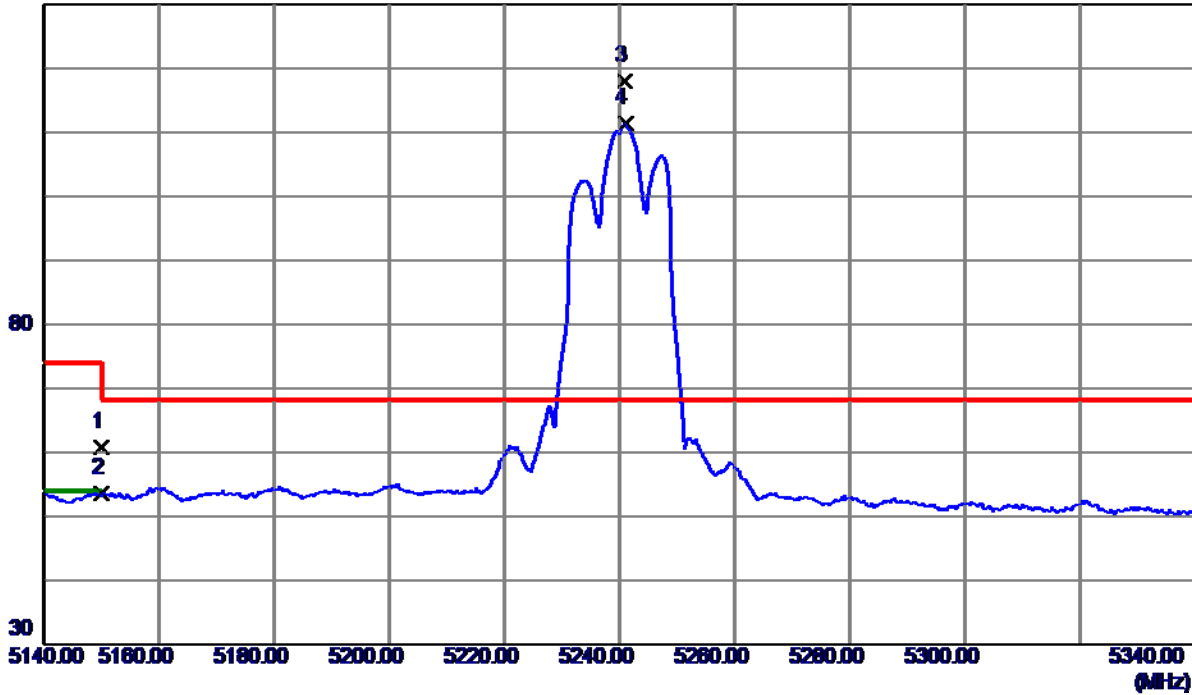

| No. | Freq. MHz | Reading Level dBuV/m | Correct Factor dB | Measure ment dBuV/m | Limit dBuV/m | Margin dB | Detector | Comment |
|-----|--------------|----------------------------|-------------------------|---------------------------|-----------------|--------------|----------|----------|
| 1 | 5150.0000 | 21.80 | 39.07 | 60.87 | 74.00 | -13.13 | Peak | |
| 2 | 5150.0000 | 14.46 | 39.07 | 53.53 | 54.00 | -0.47 | AVG | |
| 3 * | 5240.8000 | 78.76 | 39.18 | 117.94 | 68.30 | 49.64 | Peak | No Limit |
| 4 | 5241.0000 | 72.23 | 39.18 | 111.41 | 999.00 | -887.59 | AVG | No Limit |

REMARKS:

- (1) Measurement Value = Reading Level + Correct Factor.
- (2) Margin Level = Measurement Value - Limit Value.

| | |
|-----------------|---------------------------|
| Orthogonal Axis | X |
| Test Mode | UNII-1_TX A Mode 5240 MHz |

Vertical

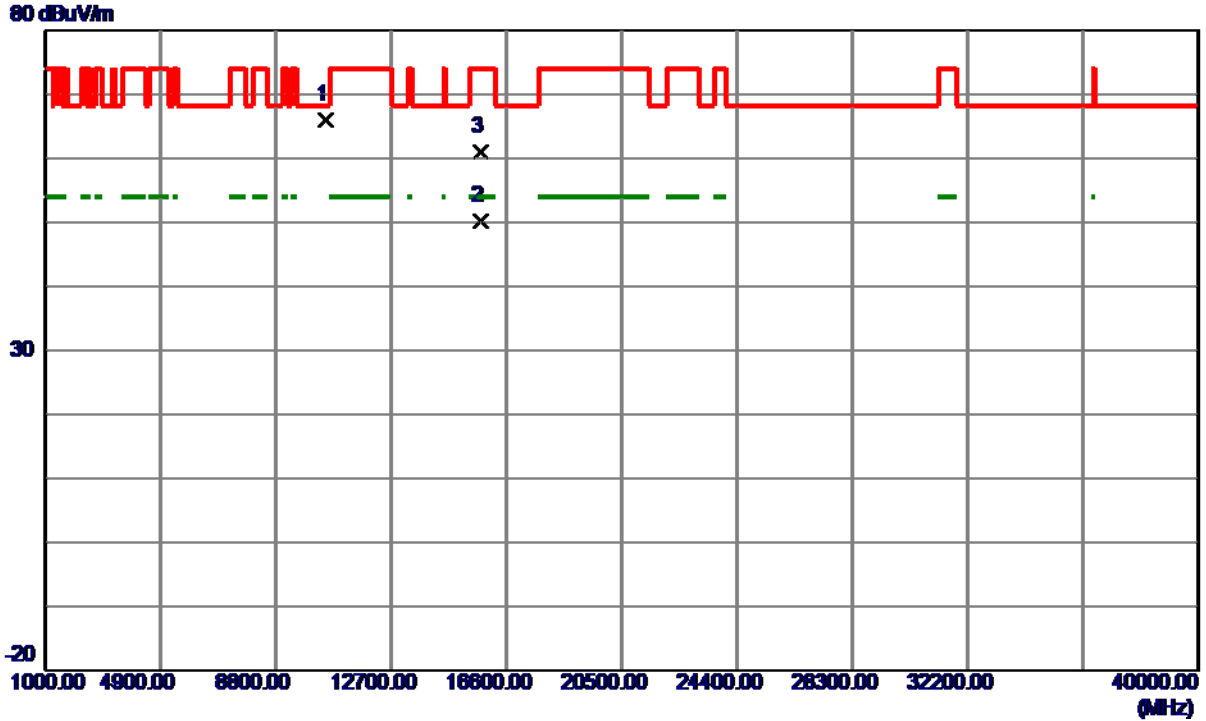

| No. | Freq. MHz | Reading Level dBuV/m | Correct Factor dB | Measure ment dBuV/m | Limit dBuV/m | Margin dB | Detector | Comment |
|-----|--------------|----------------------------|-------------------------|---------------------------|-----------------|--------------|----------|---------|
| 1 * | 10478.7650 | 67.53 | -1.53 | 66.00 | 68.30 | -2.30 | Peak | |
| 2 | 15718.1200 | 47.56 | 2.61 | 50.17 | 54.00 | -3.83 | AVG | |
| 3 | 15718.5800 | 58.47 | 2.60 | 61.07 | 74.00 | -12.93 | Peak | |

REMARKS:

- (1) Measurement Value = Reading Level + Correct Factor.
- (2) Margin Level = Measurement Value - Limit Value.

| | |
|-----------------|---------------------------|
| Orthogonal Axis | X |
| Test Mode | UNII-1_TX A Mode 5240 MHz |

Horizontal

130 dBuV/m

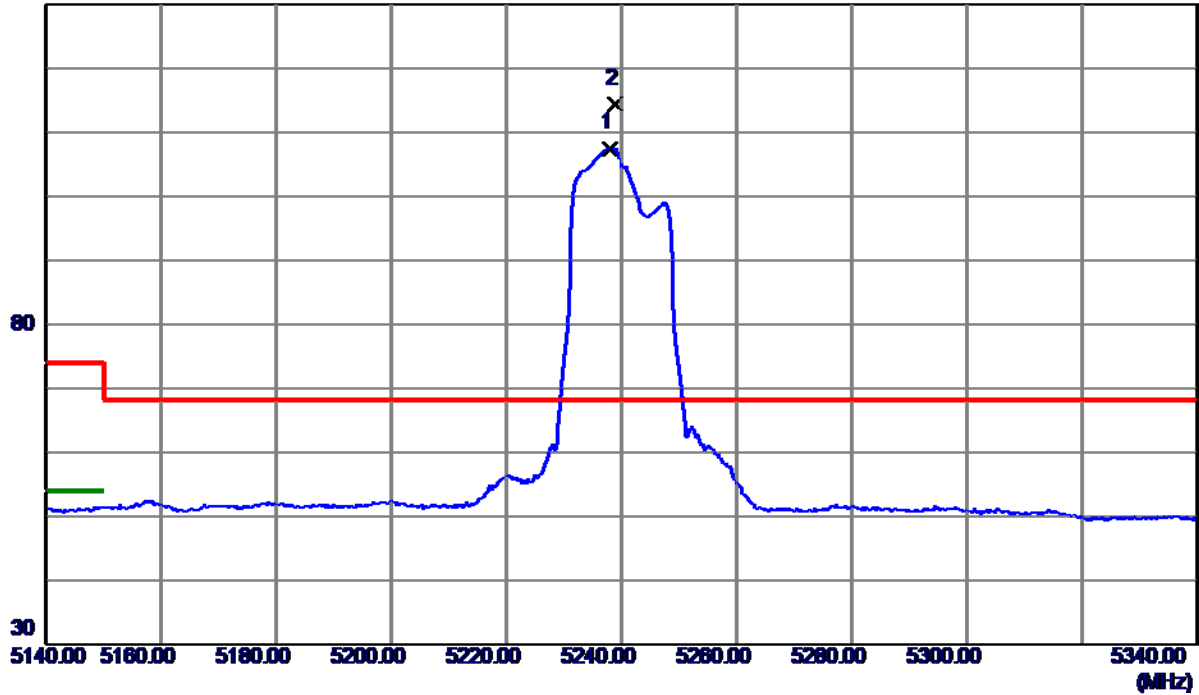

| No. | Freq. MHz | Reading Level dBuV/m | Correct Factor dB | Measure ment dBuV/m | Limit dBuV/m | Margin dB | Detector | Comment |
|-----|--------------|----------------------------|-------------------------|---------------------------|-----------------|--------------|----------|----------|
| 1 | 5238.0000 | 68.32 | 39.18 | 107.50 | 999.00 | -891.50 | AVG | No Limit |
| 2 * | 5238.8000 | 75.31 | 39.18 | 114.49 | 68.30 | 46.19 | Peak | No Limit |

REMARKS:

- (1) Measurement Value = Reading Level + Correct Factor.
- (2) Margin Level = Measurement Value - Limit Value.

| | |
|-----------------|---------------------------|
| Orthogonal Axis | X |
| Test Mode | UNII-1_TX A Mode 5240 MHz |

Horizontal

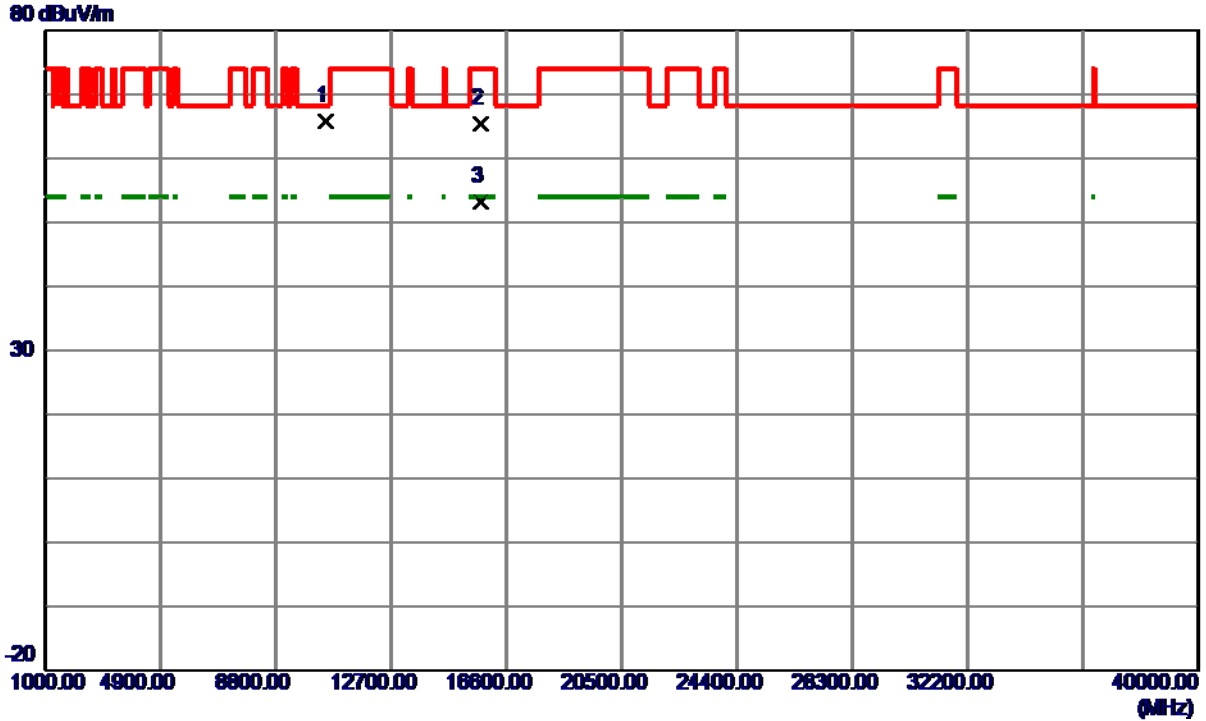

| No. | Freq. MHz | Reading Level dBuV/m | Correct Factor dB | Measure ment dBuV/m | Limit dBuV/m | Margin dB | Detector | Comment |
|-----|--------------|----------------------------|-------------------------|---------------------------|-----------------|--------------|----------|---------|
| 1 | 10481.7650 | 67.40 | -1.53 | 65.87 | 68.30 | -2.43 | Peak | |
| 2 | 15716.4200 | 62.83 | 2.61 | 65.44 | 74.00 | -8.56 | Peak | |
| 3 * | 15716.7400 | 50.67 | 2.61 | 53.28 | 54.00 | -0.72 | AVG | |

REMARKS:

- (1) Measurement Value = Reading Level + Correct Factor.
- (2) Margin Level = Measurement Value - Limit Value.

| | |
|-----------------|----------------------------|
| Orthogonal Axis | X |
| Test Mode | UNII-2A_TX A Mode 5260 MHz |

Vertical

130 dBuV/m

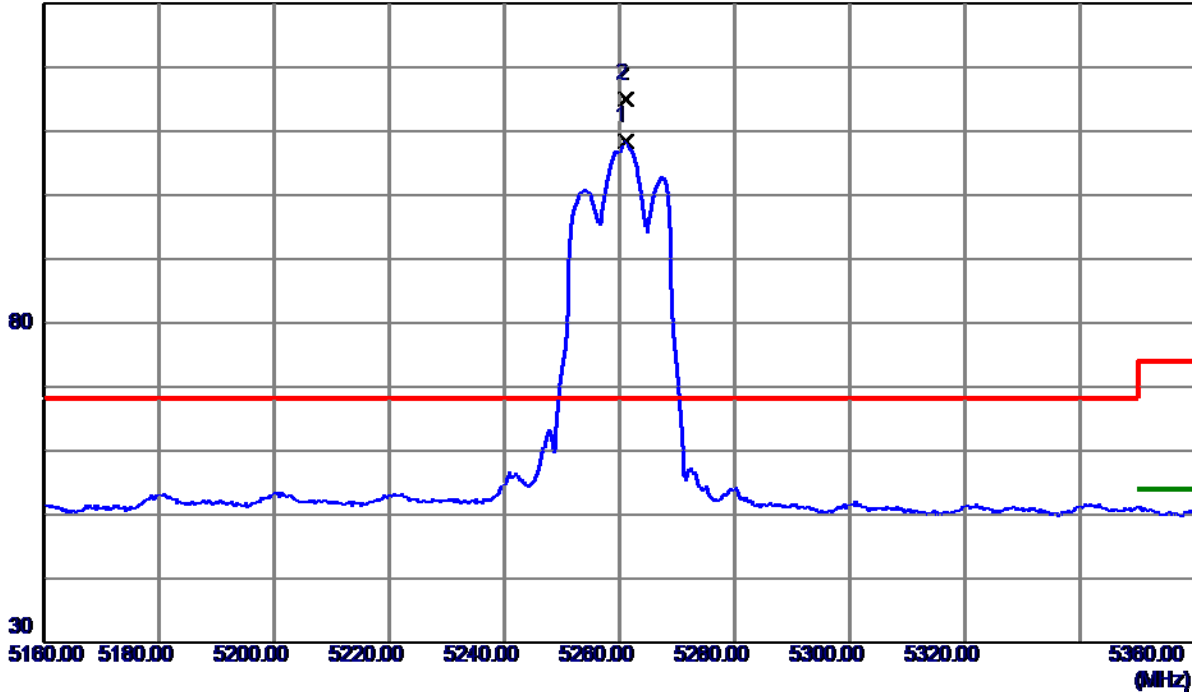

| No. | Freq. MHz | Reading Level dBuV/m | Correct Factor dB | Measure ment dBuV/m | Limit dBuV/m | Margin dB | Detector | Comment |
|-----|--------------|----------------------------|-------------------------|---------------------------|-----------------|--------------|----------|----------|
| 1 | 5261.0000 | 69.13 | 39.21 | 108.34 | 999.00 | -890.66 | AVG | No Limit |
| 2 * | 5261.2000 | 75.78 | 39.21 | 114.99 | 68.30 | 46.69 | Peak | No Limit |

REMARKS:

- (1) Measurement Value = Reading Level + Correct Factor.
- (2) Margin Level = Measurement Value - Limit Value.

| | |
|-----------------|----------------------------|
| Orthogonal Axis | X |
| Test Mode | UNII-2A_TX A Mode 5260 MHz |

Vertical

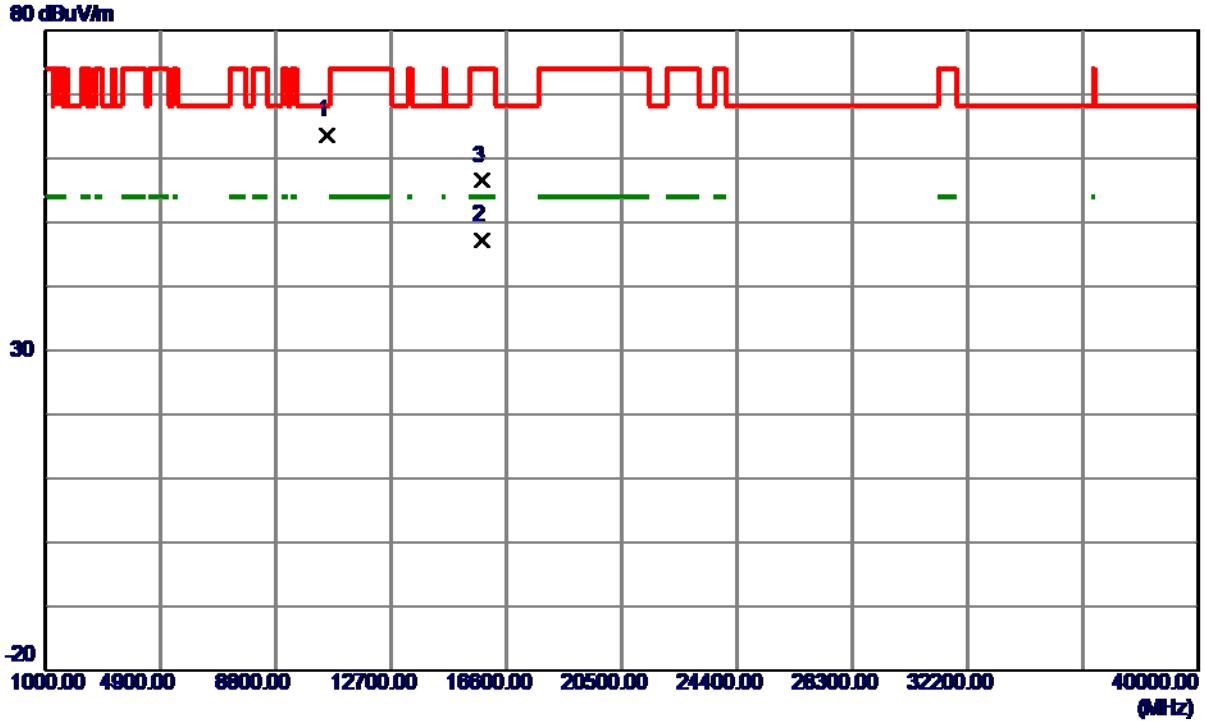

| No. | Freq. MHz | Reading Level dBuV/m | Correct Factor dB | Measure ment dBuV/m | Limit dBuV/m | Margin dB | Detector | Comment |
|-----|--------------|----------------------------|-------------------------|---------------------------|-----------------|--------------|----------|---------|
| 1 * | 10518.7000 | 65.13 | -1.44 | 63.69 | 68.30 | -4.61 | Peak | |
| 2 | 15778.1200 | 44.85 | 2.43 | 47.28 | 74.00 | -26.72 | Peak | |
| 3 | 15778.8800 | 54.07 | 2.43 | 56.50 | 74.00 | -17.50 | Peak | |

REMARKS:

- (1) Measurement Value = Reading Level + Correct Factor.
- (2) Margin Level = Measurement Value - Limit Value.

| | |
|-----------------|----------------------------|
| Orthogonal Axis | X |
| Test Mode | UNII-2A_TX A Mode 5260 MHz |

Horizontal

130 dBuV/m

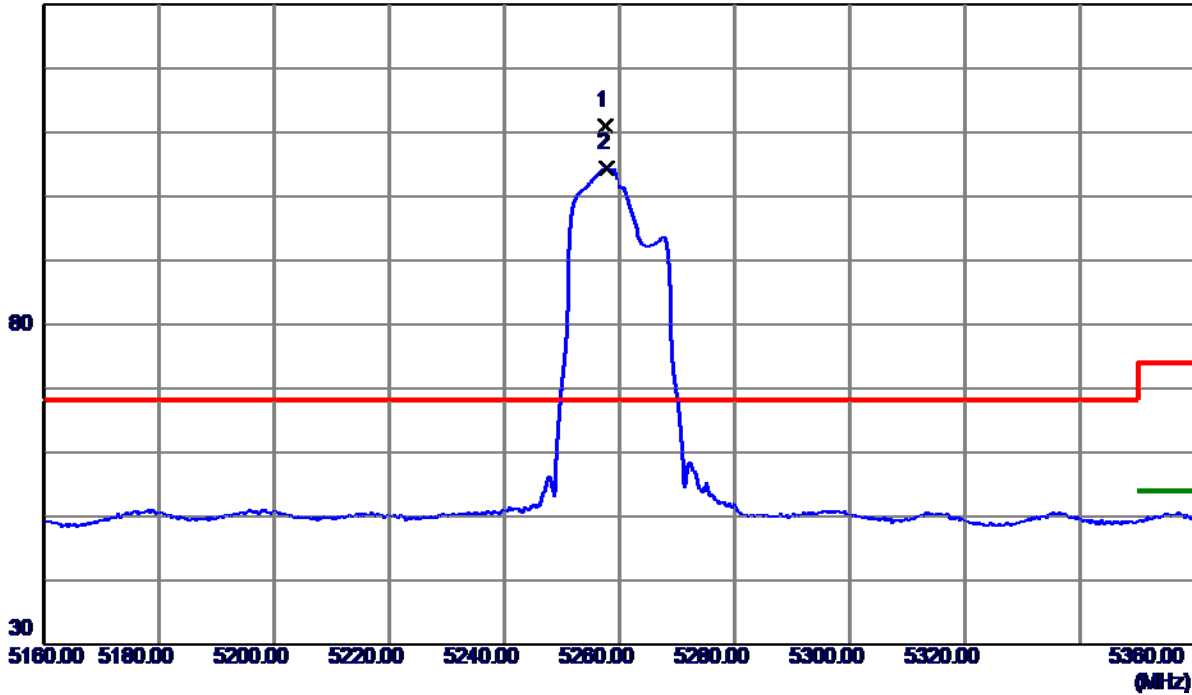

| No. | Freq. MHz | Reading Level dBuV/m | Correct Factor dB | Measure ment dBuV/m | Limit dBuV/m | Margin dB | Detector | Comment |
|-----|--------------|----------------------------|-------------------------|---------------------------|-----------------|--------------|----------|----------|
| 1 * | 5257.6000 | 71.85 | 39.20 | 111.05 | 68.30 | 42.75 | Peak | No Limit |
| 2 | 5257.8000 | 65.26 | 39.20 | 104.46 | 999.00 | -894.54 | AVG | No Limit |

REMARKS:

- (1) Measurement Value = Reading Level + Correct Factor.
- (2) Margin Level = Measurement Value - Limit Value.

| | |
|-----------------|----------------------------|
| Orthogonal Axis | X |
| Test Mode | UNII-2A_TX A Mode 5260 MHz |

Horizontal

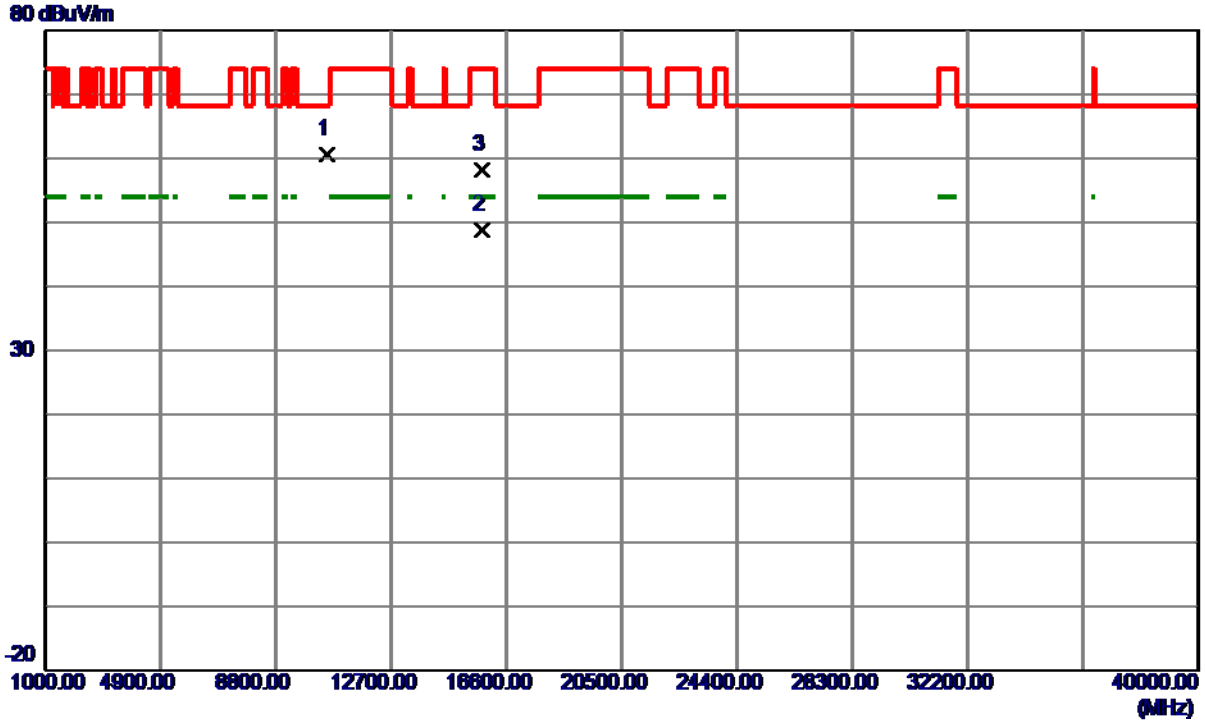

| No. | Freq. MHz | Reading Level dBuV/m | Correct Factor dB | Measure ment dBuV/m | Limit dBuV/m | Margin dB | Detector | Comment |
|-----|--------------|----------------------------|-------------------------|---------------------------|-----------------|--------------|----------|---------|
| 1 | 10521.6200 | 62.03 | -1.43 | 60.60 | 68.30 | -7.70 | Peak | |
| 2 * | 15776.2800 | 46.36 | 2.44 | 48.80 | 54.00 | -5.20 | AVG | |
| 3 | 15776.4800 | 55.73 | 2.44 | 58.17 | 74.00 | -15.83 | Peak | |

REMARKS:

- (1) Measurement Value = Reading Level + Correct Factor.
- (2) Margin Level = Measurement Value - Limit Value.

| | |
|-----------------|----------------------------|
| Orthogonal Axis | X |
| Test Mode | UNII-2A_TX A Mode 5300 MHz |

Vertical

130 dBuV/m

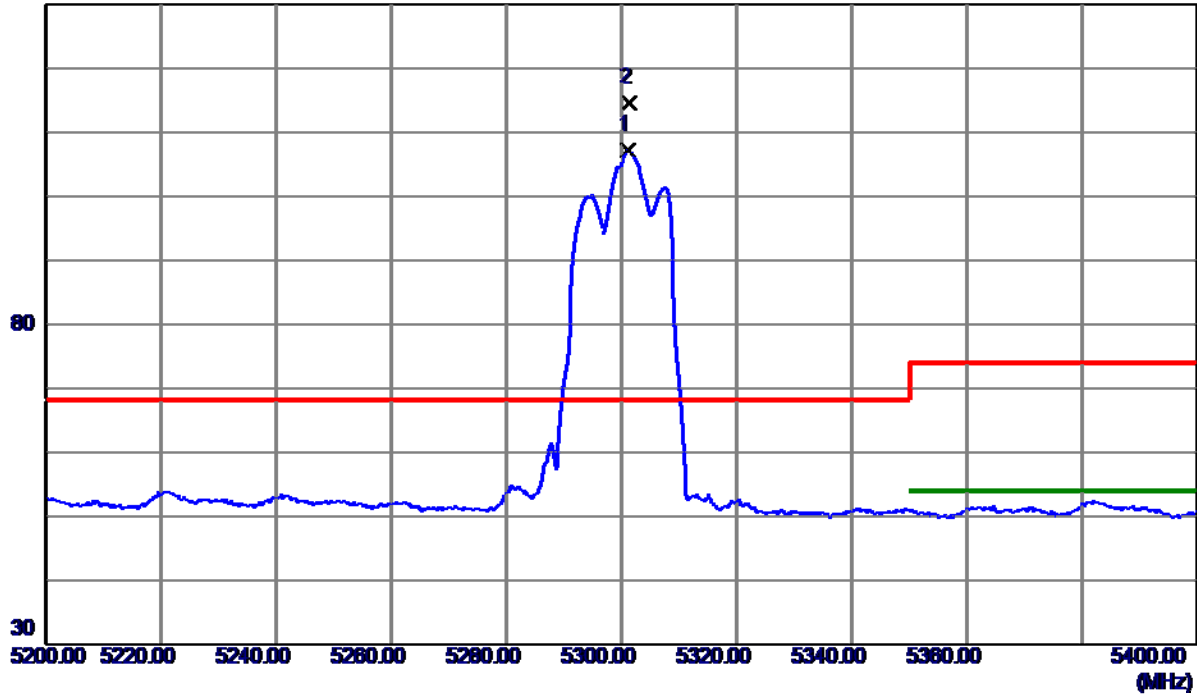

| No. | Freq. MHz | Reading Level dBuV/m | Correct Factor dB | Measure ment dBuV/m | Limit dBuV/m | Margin dB | Detector | Comment |
|-----|--------------|----------------------------|-------------------------|---------------------------|-----------------|--------------|----------|----------|
| 1 | 5301.2000 | 67.87 | 39.26 | 107.13 | 999.00 | -891.87 | AVG | No Limit |
| 2 * | 5301.4000 | 75.29 | 39.26 | 114.55 | 68.30 | 46.25 | Peak | No Limit |

REMARKS:

- (1) Measurement Value = Reading Level + Correct Factor.
- (2) Margin Level = Measurement Value - Limit Value.

| | |
|-----------------|----------------------------|
| Orthogonal Axis | X |
| Test Mode | UNII-2A_TX A Mode 5300 MHz |

Vertical

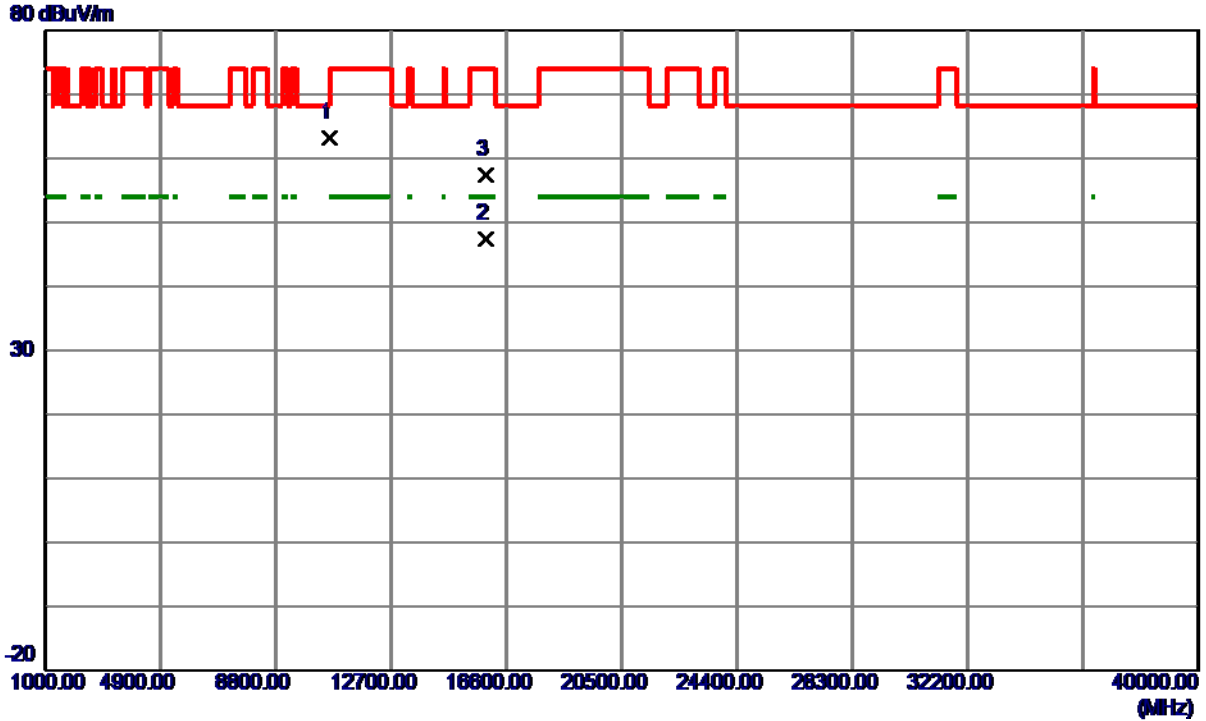

| No. | Freq. MHz | Reading Level dBuV/m | Correct Factor dB | Measure ment dBuV/m | Limit dBuV/m | Margin dB | Detector | Comment |
|-----|--------------|----------------------------|-------------------------|---------------------------|-----------------|--------------|----------|---------|
| 1 * | 10598.5599 | 64.44 | -1.16 | 63.28 | 68.30 | -5.02 | Peak | |
| 2 | 15897.8200 | 45.26 | 2.09 | 47.35 | 54.00 | -6.65 | AVG | |
| 3 | 15898.5800 | 55.39 | 2.09 | 57.48 | 74.00 | -16.52 | Peak | |

REMARKS:

- (1) Measurement Value = Reading Level + Correct Factor.
- (2) Margin Level = Measurement Value - Limit Value.

| | |
|-----------------|----------------------------|
| Orthogonal Axis | X |
| Test Mode | UNII-2A_TX A Mode 5300 MHz |

Horizontal

130 dBuV/m

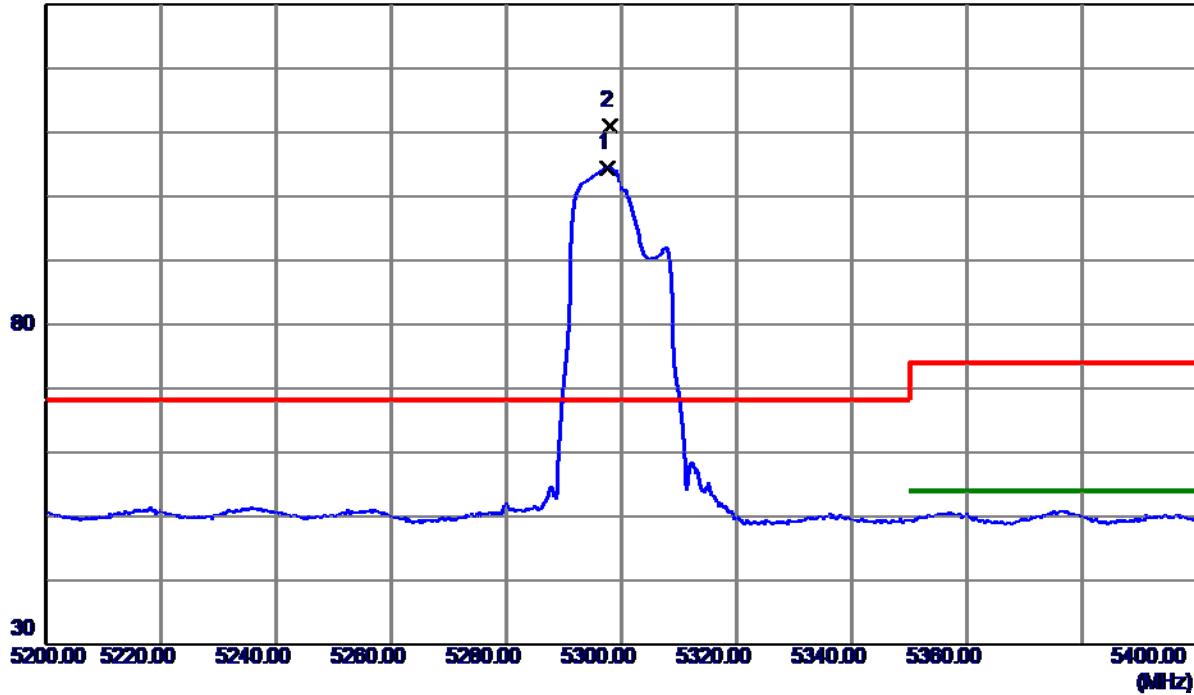

| No. | Freq. MHz | Reading Level dBuV/m | Correct Factor dB | Measure ment dBuV/m | Limit dBuV/m | Margin dB | Detector | Comment |
|-----|--------------|----------------------------|-------------------------|---------------------------|-----------------|--------------|----------|----------|
| 1 | 5297.6000 | 65.24 | 39.25 | 104.49 | 999.00 | -894.51 | AVG | No Limit |
| 2 * | 5298.0000 | 71.81 | 39.26 | 111.07 | 68.30 | 42.77 | Peak | No Limit |

REMARKS:

- (1) Measurement Value = Reading Level + Correct Factor.
- (2) Margin Level = Measurement Value - Limit Value.

| | |
|-----------------|----------------------------|
| Orthogonal Axis | X |
| Test Mode | UNII-2A_TX A Mode 5300 MHz |

Horizontal

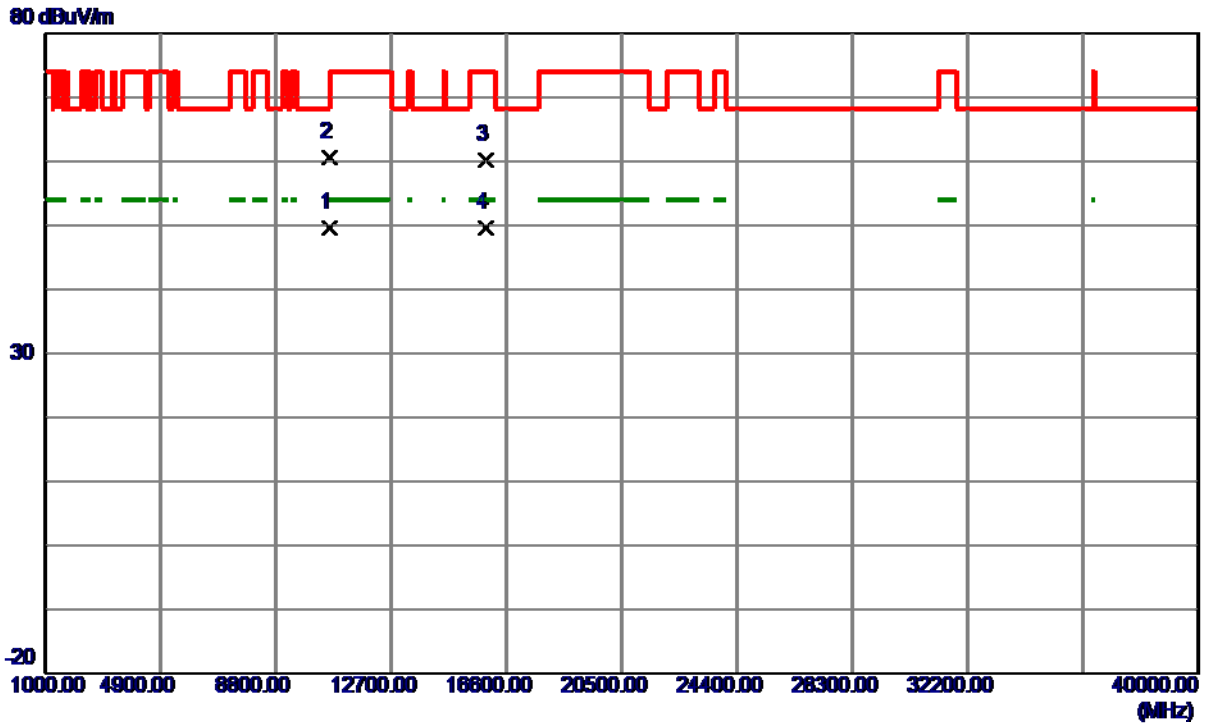

| No. | Freq. MHz | Reading Level dBuV/m | Correct Factor dB | Measure ment dBuV/m | Limit dBuV/m | Margin dB | Detector | Comment |
|-----|--------------|----------------------------|-------------------------|---------------------------|-----------------|--------------|----------|---------|
| 1 * | 10601.8650 | 50.73 | -1.15 | 49.58 | 54.00 | -4.42 | AVG | |
| 2 | 10602.0800 | 61.82 | -1.14 | 60.68 | 74.00 | -13.32 | Peak | |
| 3 | 15894.5600 | 58.16 | 2.10 | 60.26 | 74.00 | -13.74 | Peak | |
| 4 | 15895.2200 | 47.43 | 2.10 | 49.53 | 54.00 | -4.47 | AVG | |

REMARKS:

- (1) Measurement Value = Reading Level + Correct Factor.
- (2) Margin Level = Measurement Value - Limit Value.

| | |
|-----------------|----------------------------|
| Orthogonal Axis | X |
| Test Mode | UNII-2A_TX A Mode 5320 MHz |

Vertical

130 dBuV/m

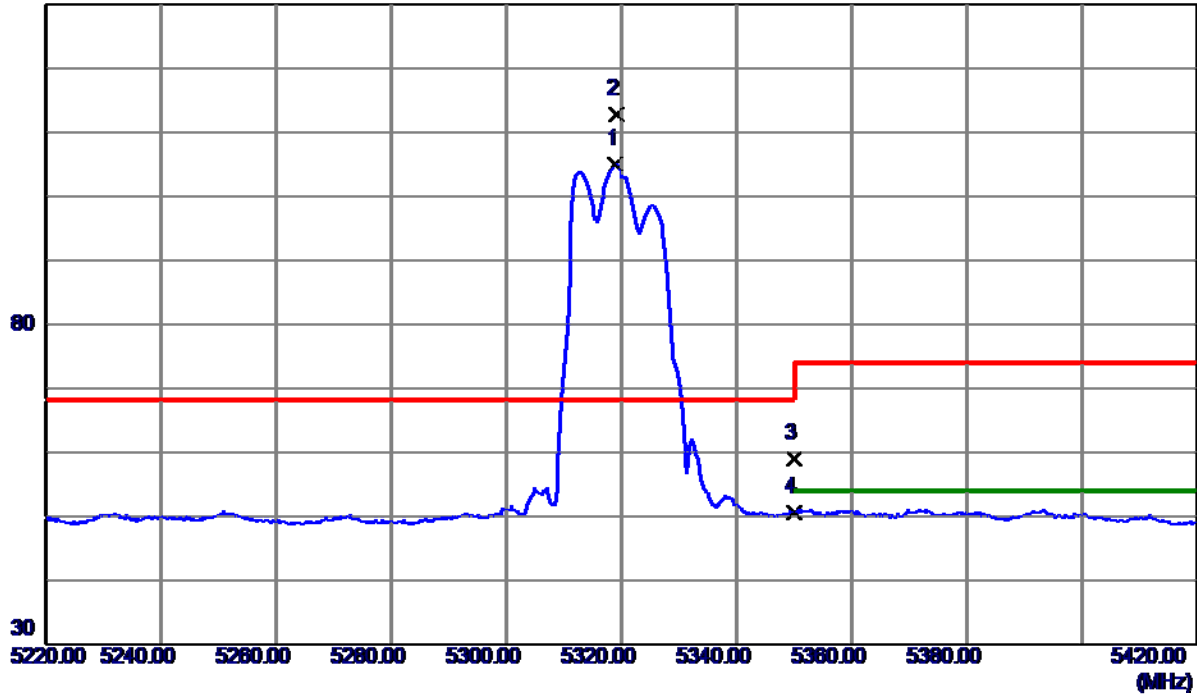

| No. | Freq. MHz | Reading Level dBuV/m | Correct Factor dB | Measure ment dBuV/m | Limit dBuV/m | Margin dB | Detector | Comment |
|-----|--------------|----------------------------|-------------------------|---------------------------|-----------------|--------------|----------|----------|
| 1 | 5319.0000 | 65.76 | 39.28 | 105.04 | 999.00 | -893.96 | AVG | No Limit |
| 2 * | 5319.2000 | 73.61 | 39.28 | 112.89 | 68.30 | 44.59 | Peak | No Limit |
| 3 | 5350.0000 | 19.72 | 39.32 | 59.04 | 74.00 | -14.96 | Peak | |
| 4 | 5350.0000 | 11.34 | 39.32 | 50.66 | 54.00 | -3.34 | AVG | |

REMARKS:

- (1) Measurement Value = Reading Level + Correct Factor.
- (2) Margin Level = Measurement Value - Limit Value.

| | |
|-----------------|----------------------------|
| Orthogonal Axis | X |
| Test Mode | UNII-2A_TX A Mode 5320 MHz |

Vertical

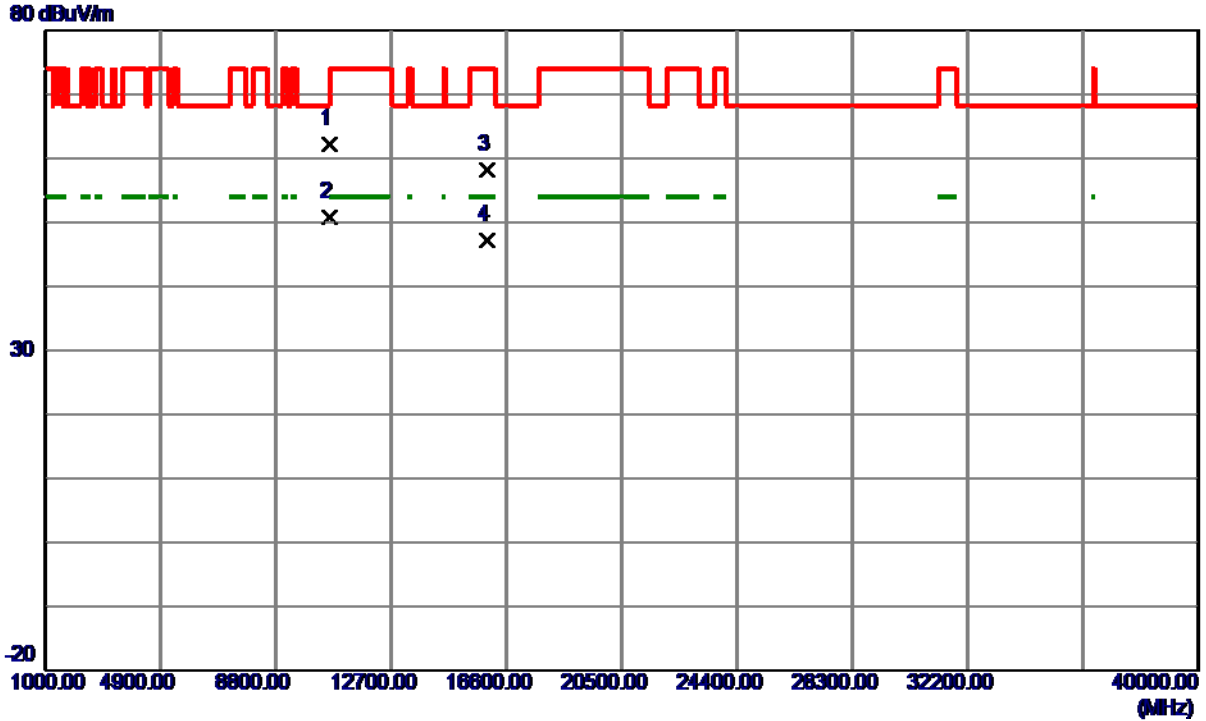

| No. | Freq. MHz | Reading Level dBuV/m | Correct Factor dB | Measure ment dBuV/m | Limit dBuV/m | Margin dB | Detector | Comment |
|-----|--------------|----------------------------|-------------------------|---------------------------|-----------------|--------------|----------|---------|
| 1 | 10637.7500 | 63.24 | -1.02 | 62.22 | 74.00 | -11.78 | Peak | |
| 2 * | 10637.8900 | 51.90 | -1.02 | 50.88 | 54.00 | -3.12 | AVG | |
| 3 | 15952.2600 | 56.34 | 1.94 | 58.28 | 74.00 | -15.72 | Peak | |
| 4 | 15958.6000 | 45.27 | 1.92 | 47.19 | 54.00 | -6.81 | AVG | |

REMARKS:

- (1) Measurement Value = Reading Level + Correct Factor.
- (2) Margin Level = Measurement Value - Limit Value.

| | |
|-----------------|----------------------------|
| Orthogonal Axis | X |
| Test Mode | UNII-2A_TX A Mode 5320 MHz |

Horizontal

130 dBuV/m

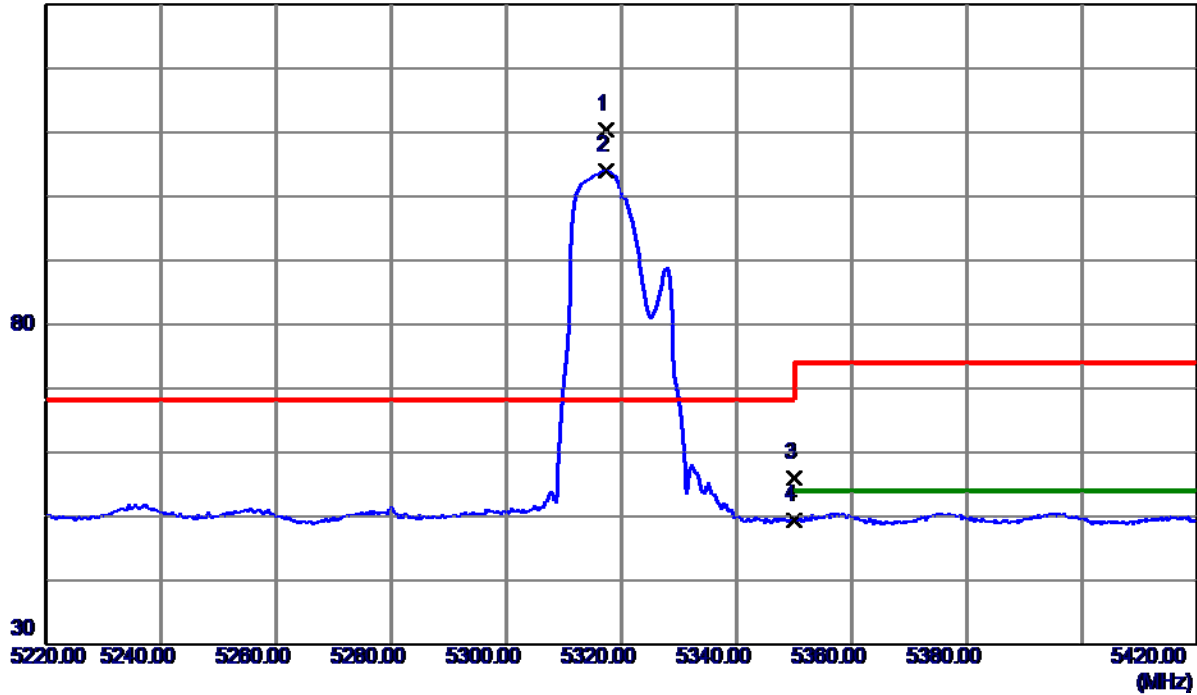

| No. | Freq. MHz | Reading Level dBuV/m | Correct Factor dB | Measure ment dBuV/m | Limit dBuV/m | Margin dB | Detector | Comment |
|-----|--------------|----------------------------|-------------------------|---------------------------|-----------------|--------------|----------|----------|
| 1 * | 5317.4000 | 71.05 | 39.28 | 110.33 | 68.30 | 42.03 | Peak | No Limit |
| 2 | 5317.4000 | 64.67 | 39.28 | 103.95 | 999.00 | -895.05 | AVG | No Limit |
| 3 | 5350.0000 | 16.73 | 39.32 | 56.05 | 74.00 | -17.95 | Peak | |
| 4 | 5350.0000 | 10.02 | 39.32 | 49.34 | 54.00 | -4.66 | AVG | |

REMARKS:

- (1) Measurement Value = Reading Level + Correct Factor.
- (2) Margin Level = Measurement Value - Limit Value.

| | |
|-----------------|----------------------------|
| Orthogonal Axis | X |
| Test Mode | UNII-2A_TX A Mode 5320 MHz |

Horizontal

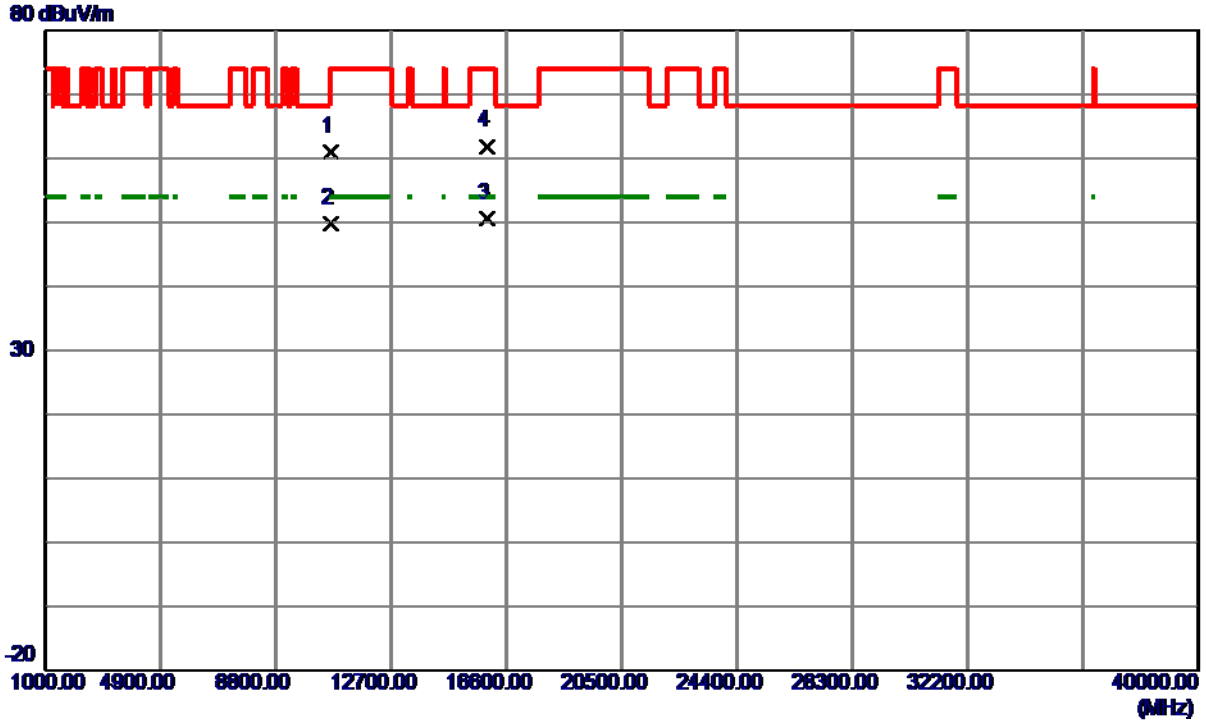

| No. | Freq. MHz | Reading Level dBuV/m | Correct Factor dB | Measure ment dBuV/m | Limit dBuV/m | Margin dB | Detector | Comment |
|-----|--------------|----------------------------|-------------------------|---------------------------|-----------------|--------------|----------|---------|
| 1 | 10641.8800 | 62.02 | -1.00 | 61.02 | 74.00 | -12.98 | Peak | |
| 2 | 10641.9200 | 50.75 | -1.00 | 49.75 | 54.00 | -4.25 | AVG | |
| 3 * | 15955.3400 | 48.63 | 1.93 | 50.56 | 54.00 | -3.44 | AVG | |
| 4 | 15956.3600 | 59.98 | 1.92 | 61.90 | 74.00 | -12.10 | Peak | |

REMARKS:

- (1) Measurement Value = Reading Level + Correct Factor.
- (2) Margin Level = Measurement Value - Limit Value.

| | |
|-----------------|----------------------------|
| Orthogonal Axis | X |
| Test Mode | UNII-2C_TX A Mode 5500 MHz |

Vertical

130 dBuV/m

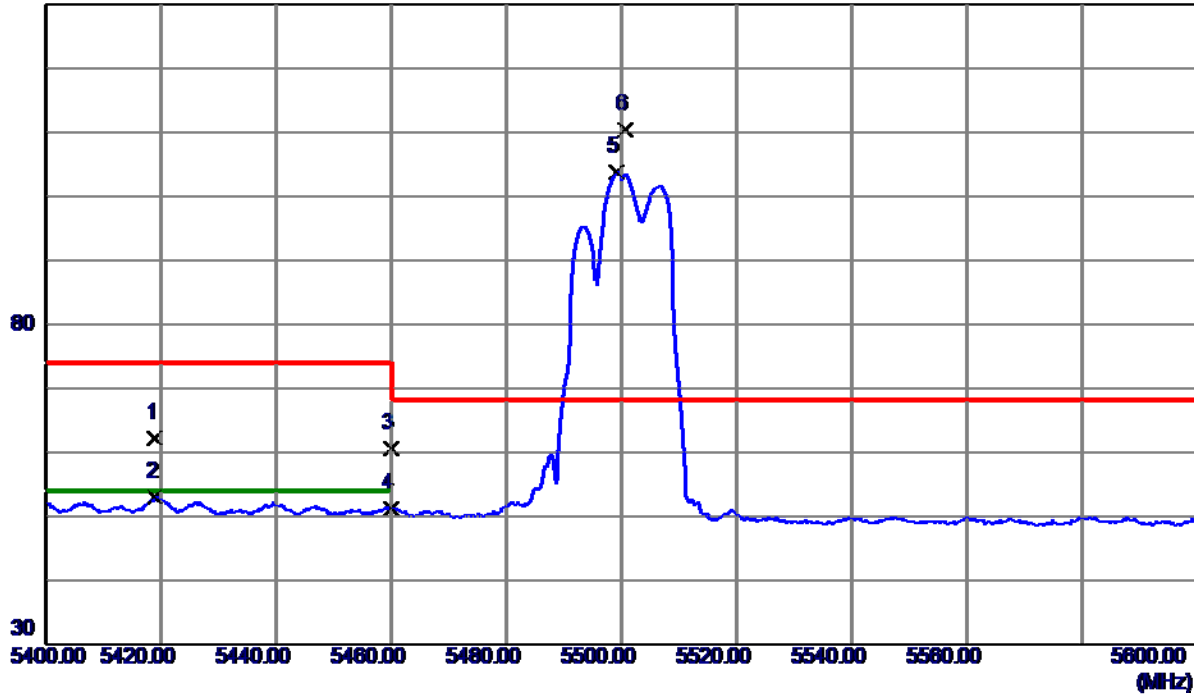

| No. | Freq. MHz | Reading Level dBuV/m | Correct Factor dB | Measure ment dBuV/m | Limit dBuV/m | Margin dB | Detector | Comment |
|-----|--------------|----------------------------|-------------------------|---------------------------|-----------------|--------------|----------|----------|
| 1 | 5419.0000 | 22.87 | 39.41 | 62.28 | 74.00 | -11.72 | Peak | |
| 2 | 5419.0000 | 13.52 | 39.41 | 52.93 | 54.00 | -1.07 | AVG | |
| 3 | 5460.0000 | 21.09 | 39.46 | 60.55 | 74.00 | -13.45 | Peak | |
| 4 | 5460.0000 | 11.77 | 39.46 | 51.23 | 54.00 | -2.77 | AVG | |
| 5 | 5499.2000 | 64.37 | 39.51 | 103.88 | 999.00 | -895.12 | AVG | No Limit |
| 6 * | 5500.6000 | 70.80 | 39.51 | 110.31 | 68.30 | 42.01 | Peak | No Limit |

REMARKS:

- (1) Measurement Value = Reading Level + Correct Factor.
- (2) Margin Level = Measurement Value - Limit Value.

| | |
|-----------------|----------------------------|
| Orthogonal Axis | X |
| Test Mode | UNII-2C_TX A Mode 5500 MHz |

Vertical

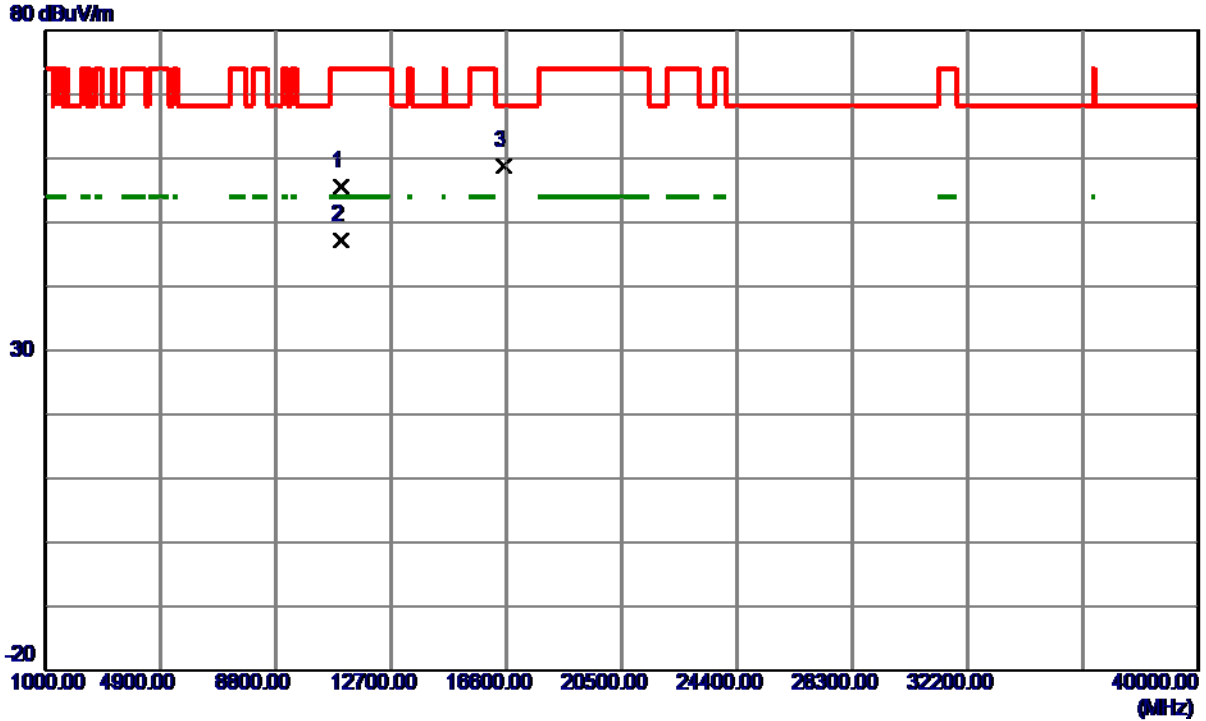

| No. | Freq. MHz | Reading Level dBuV/m | Correct Factor dB | Measure ment dBuV/m | Limit dBuV/m | Margin dB | Detector | Comment |
|-----|--------------|----------------------------|-------------------------|---------------------------|-----------------|--------------|----------|---------|
| 1 | 10999.9550 | 55.33 | 0.28 | 55.61 | 74.00 | -18.39 | Peak | |
| 2 * | 10999.9850 | 46.88 | 0.28 | 47.16 | 54.00 | -6.84 | AVG | |
| 3 | 16497.6600 | 55.76 | 3.00 | 58.76 | 68.30 | -9.54 | Peak | |

REMARKS:

- (1) Measurement Value = Reading Level + Correct Factor.
- (2) Margin Level = Measurement Value - Limit Value.

| | |
|-----------------|----------------------------|
| Orthogonal Axis | X |
| Test Mode | UNII-2C_TX A Mode 5500 MHz |

Horizontal

130 dBuV/m

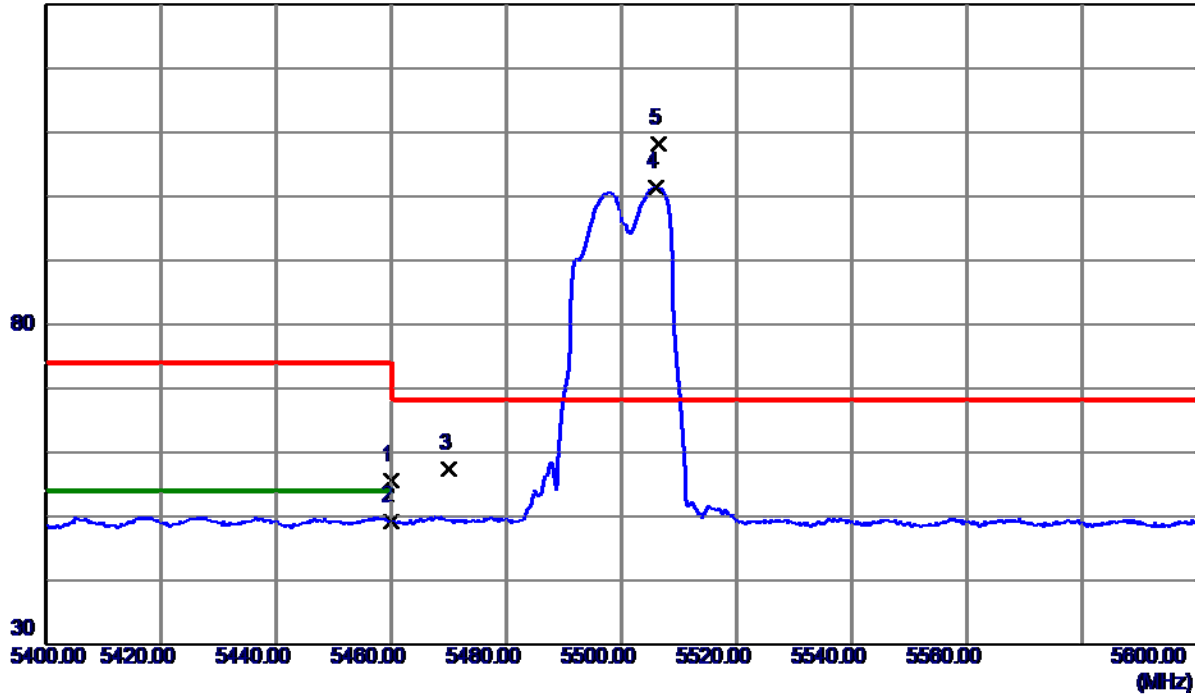

| No. | Freq. MHz | Reading Level dBuV/m | Correct Factor dB | Measure ment dBuV/m | Limit dBuV/m | Margin dB | Detector | Comment |
|-----|--------------|----------------------------|-------------------------|---------------------------|-----------------|--------------|----------|----------|
| 1 | 5460.0000 | 16.15 | 39.46 | 55.61 | 74.00 | -18.39 | Peak | |
| 2 | 5460.0000 | 9.80 | 39.46 | 49.26 | 54.00 | -4.74 | AVG | |
| 3 | 5470.0000 | 17.97 | 39.47 | 57.44 | 68.30 | -10.86 | Peak | |
| 4 | 5506.0000 | 61.85 | 39.52 | 101.37 | 999.00 | -897.63 | AVG | No Limit |
| 5 * | 5506.4000 | 68.74 | 39.53 | 108.27 | 68.30 | 39.97 | Peak | No Limit |

REMARKS:

- (1) Measurement Value = Reading Level + Correct Factor.
- (2) Margin Level = Measurement Value - Limit Value.

| | |
|-----------------|----------------------------|
| Orthogonal Axis | X |
| Test Mode | UNII-2C_TX A Mode 5500 MHz |

Horizontal

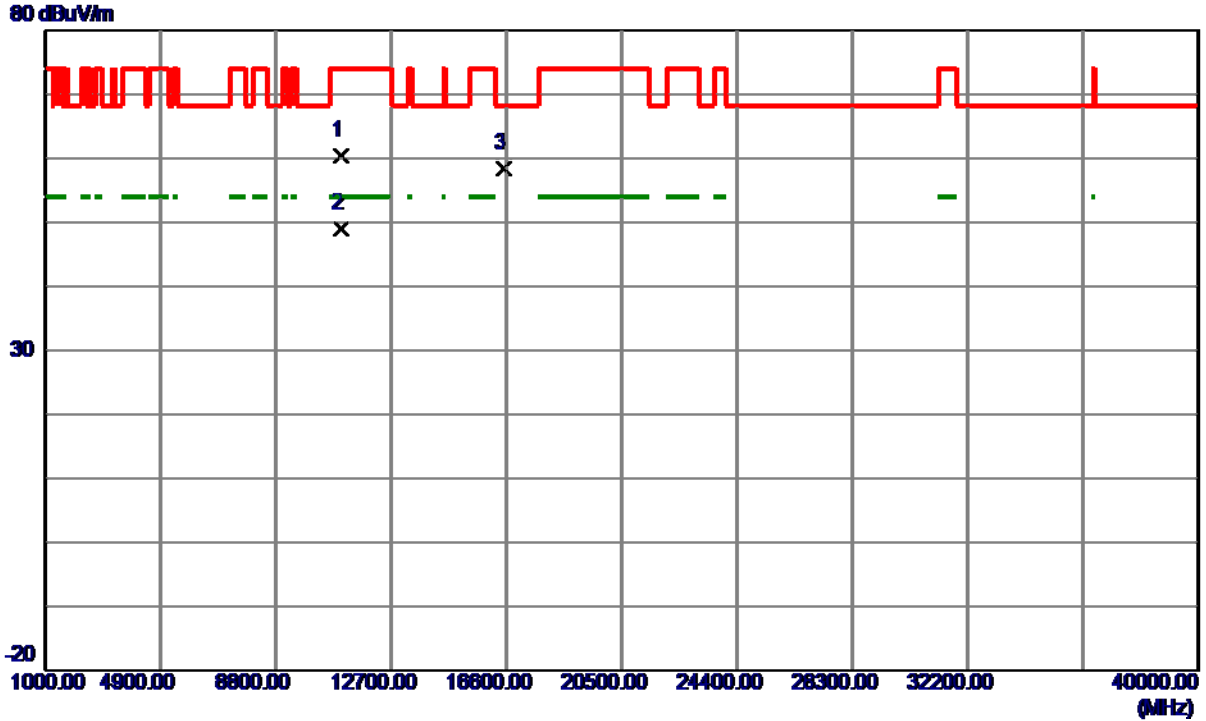

| No. | Freq. MHz | Reading Level dBuV/m | Correct Factor dB | Measure ment dBuV/m | Limit dBuV/m | Margin dB | Detector | Comment |
|-----|--------------|----------------------------|-------------------------|---------------------------|-----------------|--------------|----------|---------|
| 1 | 11001.7500 | 60.11 | 0.28 | 60.39 | 74.00 | -13.61 | Peak | |
| 2 * | 11002.3150 | 48.69 | 0.28 | 48.97 | 54.00 | -5.03 | AVG | |
| 3 | 16496.5800 | 55.42 | 3.00 | 58.42 | 68.30 | -9.88 | Peak | |

REMARKS:

- (1) Measurement Value = Reading Level + Correct Factor.
- (2) Margin Level = Measurement Value - Limit Value.

| | |
|-----------------|----------------------------|
| Orthogonal Axis | X |
| Test Mode | UNII-2C_TX A Mode 5580 MHz |

Vertical

130 dBuV/m

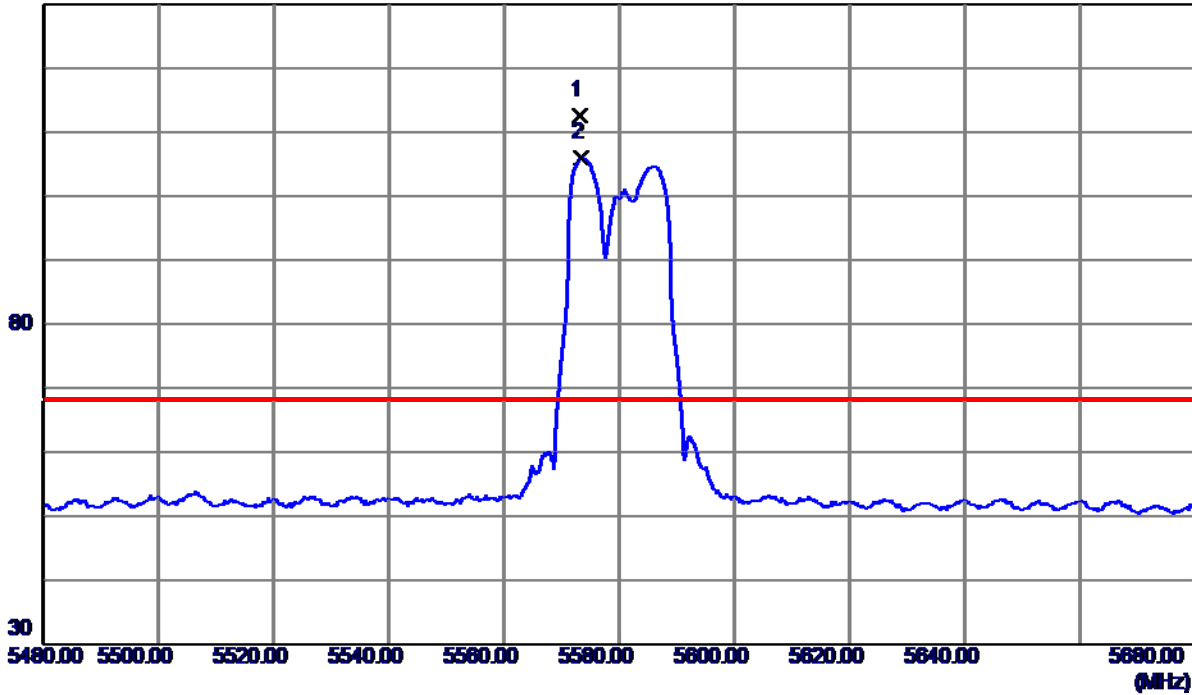

| No. | Freq. MHz | Reading Level dBuV/m | Correct Factor dB | Measure ment dBuV/m | Limit dBuV/m | Margin dB | Detector | Comment |
|-----|--------------|----------------------------|-------------------------|---------------------------|-----------------|--------------|----------|----------|
| 1 * | 5573.2000 | 72.96 | 39.68 | 112.64 | 68.30 | 44.34 | Peak | No Limit |
| 2 | 5573.4000 | 66.35 | 39.68 | 106.03 | 999.00 | -892.97 | AVG | No Limit |

REMARKS:

- (1) Measurement Value = Reading Level + Correct Factor.
- (2) Margin Level = Measurement Value - Limit Value.

| | |
|-----------------|----------------------------|
| Orthogonal Axis | X |
| Test Mode | UNII-2C_TX A Mode 5580 MHz |

Vertical

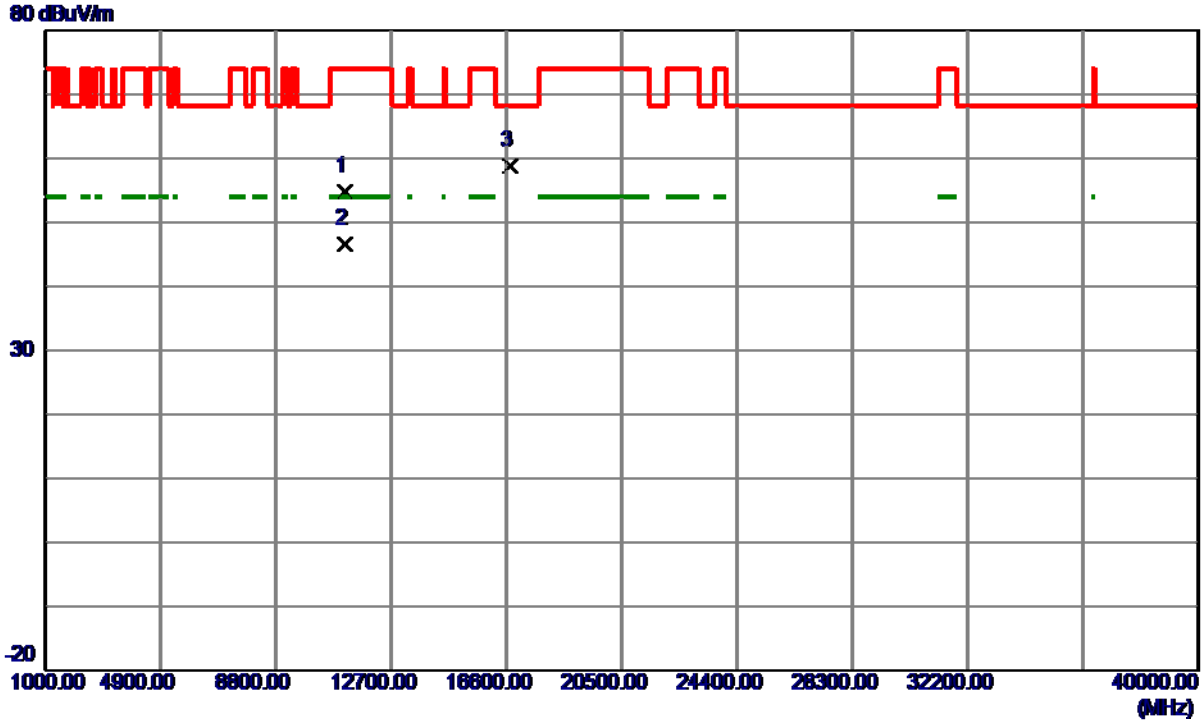

| No. | Freq. MHz | Reading Level dBuV/m | Correct Factor dB | Measurement dBuV/m | Limit dBuV/m | Margin dB | Detector | Comment |
|-----|------------|----------------------|-------------------|--------------------|--------------|-----------|----------|---------|
| 1 | 11159.9000 | 54.77 | 0.07 | 54.84 | 74.00 | -19.16 | Peak | |
| 2 * | 11159.9500 | 46.44 | 0.07 | 46.51 | 54.00 | -7.49 | AVG | |
| 3 | 16748.5000 | 54.63 | 4.13 | 58.76 | 68.30 | -9.54 | Peak | |

REMARKS:

- (1) Measurement Value = Reading Level + Correct Factor.
- (2) Margin Level = Measurement Value - Limit Value.

| | |
|-----------------|----------------------------|
| Orthogonal Axis | X |
| Test Mode | UNII-2C_TX A Mode 5580 MHz |

Horizontal

130 dBuV/m

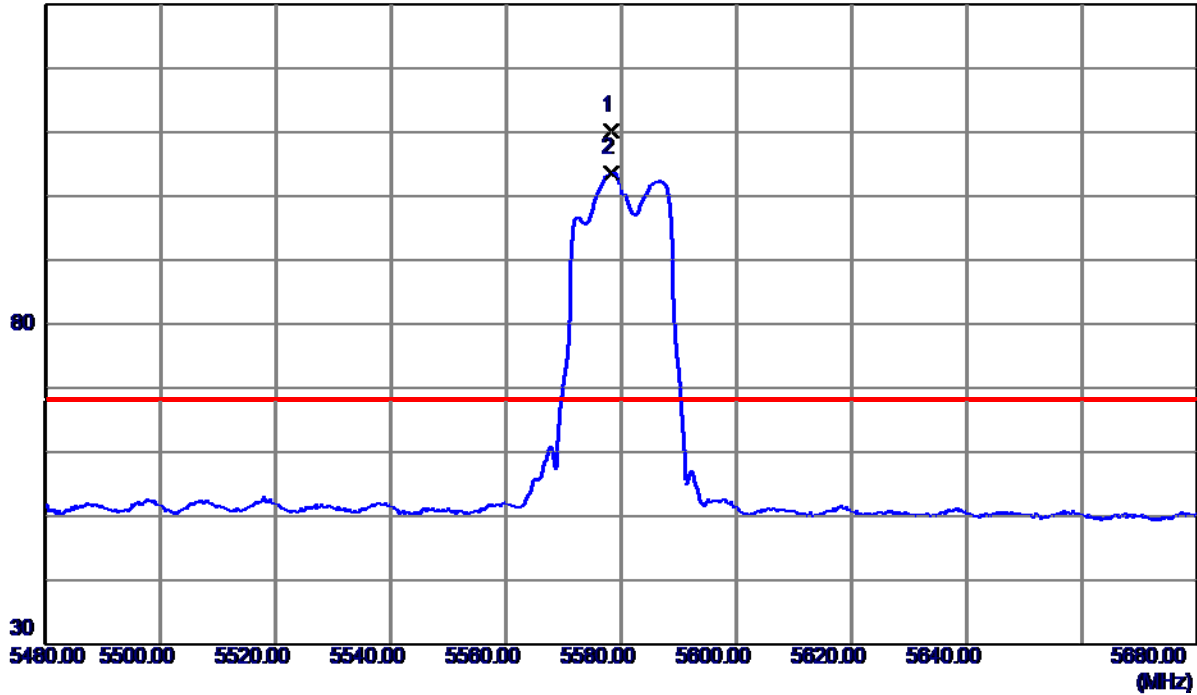

| No. | Freq. MHz | Reading Level dBuV/m | Correct Factor dB | Measure ment dBuV/m | Limit dBuV/m | Margin dB | Detector | Comment |
|-----|--------------|----------------------------|-------------------------|---------------------------|-----------------|--------------|----------|----------|
| 1 * | 5578.2000 | 70.48 | 39.70 | 110.18 | 68.30 | 41.88 | Peak | No Limit |
| 2 | 5578.2000 | 63.85 | 39.70 | 103.55 | 999.00 | -895.45 | AVG | No Limit |

REMARKS:

- (1) Measurement Value = Reading Level + Correct Factor.
- (2) Margin Level = Measurement Value - Limit Value.

| | |
|-----------------|----------------------------|
| Orthogonal Axis | X |
| Test Mode | UNII-2C_TX A Mode 5580 MHz |

Horizontal

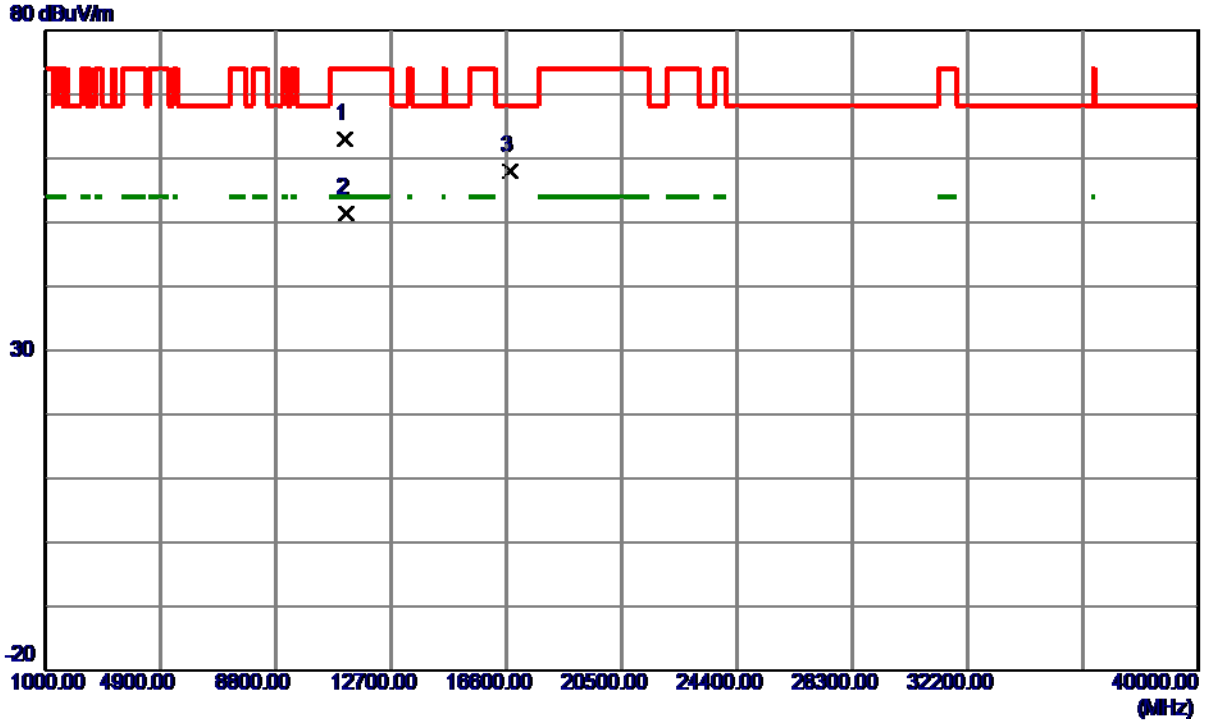

| No. | Freq. MHz | Reading Level dBuV/m | Correct Factor dB | Measure ment dBuV/m | Limit dBuV/m | Margin dB | Detector | Comment |
|-----|--------------|----------------------------|-------------------------|---------------------------|-----------------|--------------|----------|---------|
| 1 | 11161.6400 | 63.01 | 0.07 | 63.08 | 74.00 | -10.92 | Peak | |
| 2 * | 11161.9550 | 51.29 | 0.07 | 51.36 | 54.00 | -2.64 | AVG | |
| 3 | 16733.1800 | 53.96 | 4.06 | 58.02 | 68.30 | -10.28 | Peak | |

REMARKS:

- (1) Measurement Value = Reading Level + Correct Factor.
- (2) Margin Level = Measurement Value - Limit Value.

| | |
|-----------------|----------------------------|
| Orthogonal Axis | X |
| Test Mode | UNII-2C_TX A Mode 5700 MHz |

Vertical

130 dBuV/m

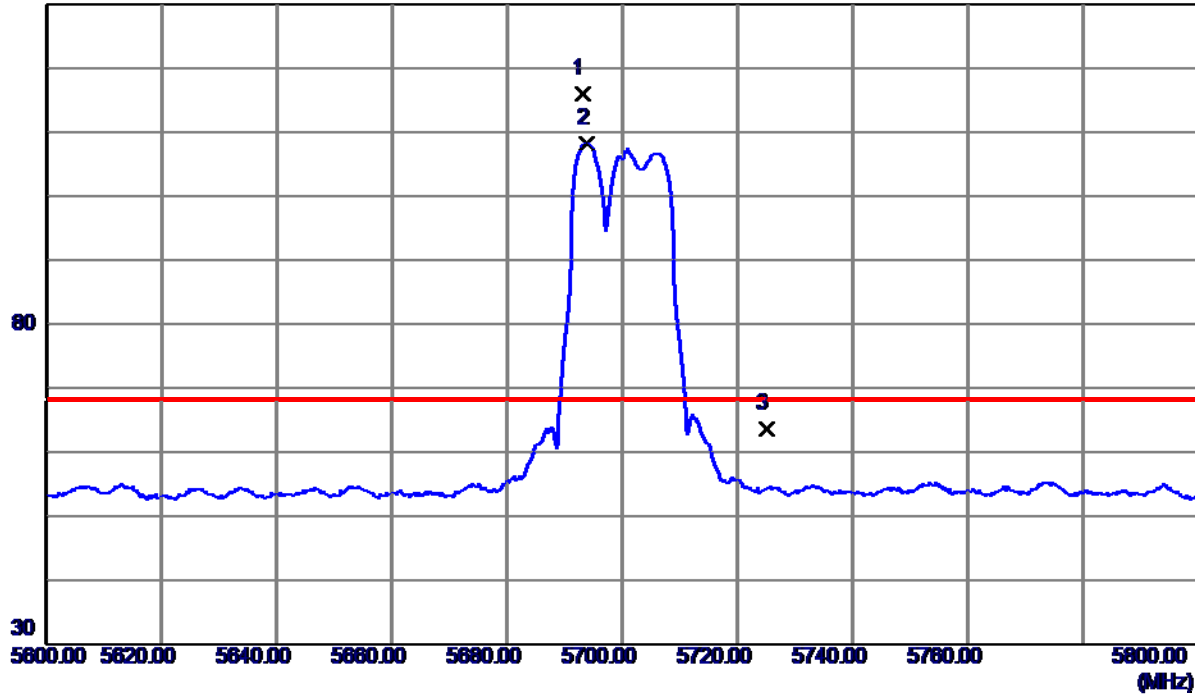

| No. | Freq. MHz | Reading Level dBuV/m | Correct Factor dB | Measure ment dBuV/m | Limit dBuV/m | Margin dB | Detector | Comment |
|-----|--------------|----------------------------|-------------------------|---------------------------|-----------------|--------------|----------|----------|
| 1 * | 5693.0000 | 75.93 | 39.97 | 115.90 | 68.30 | 47.60 | Peak | No Limit |
| 2 | 5693.8000 | 68.29 | 39.97 | 108.26 | 999.00 | -890.74 | AVG | No Limit |
| 3 | 5725.0000 | 23.54 | 40.05 | 63.59 | 68.30 | -4.71 | Peak | |

REMARKS:

- (1) Measurement Value = Reading Level + Correct Factor.
- (2) Margin Level = Measurement Value - Limit Value.

| | |
|-----------------|----------------------------|
| Orthogonal Axis | X |
| Test Mode | UNII-2C_TX A Mode 5700 MHz |

Vertical

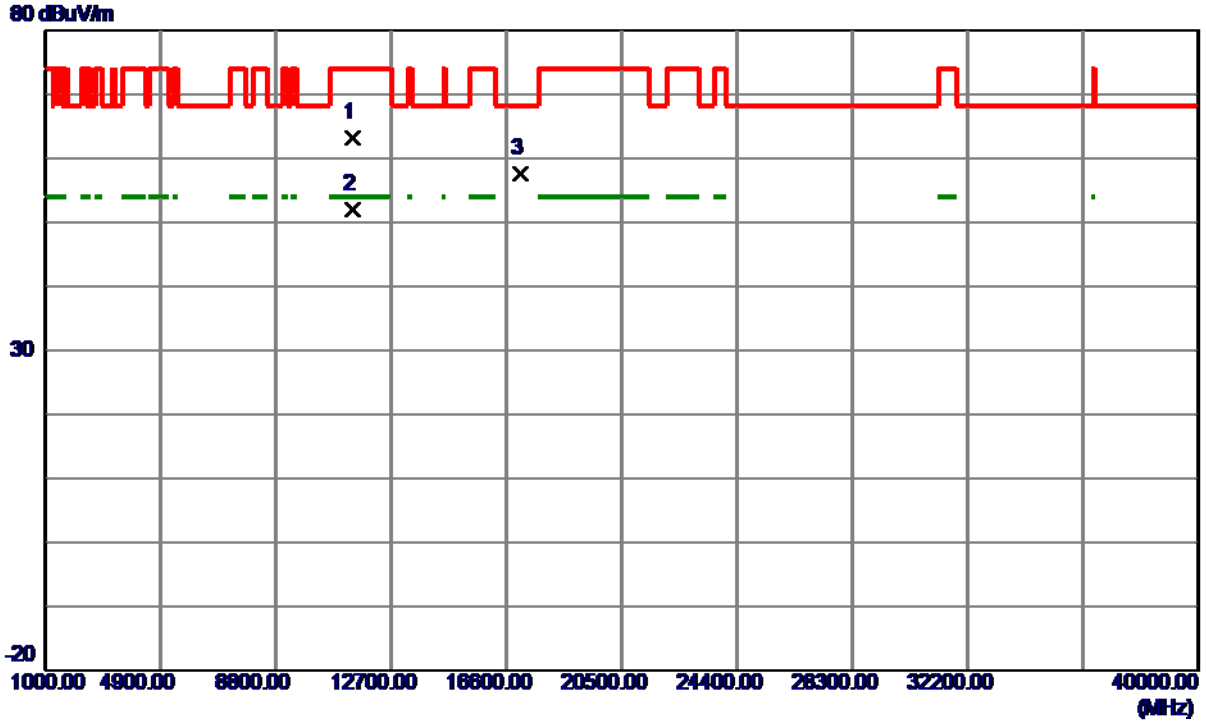

| No. | Freq. MHz | Reading Level dBuV/m | Correct Factor dB | Measure ment dBuV/m | Limit dBuV/m | Margin dB | Detector | Comment |
|-----|--------------|----------------------------|-------------------------|---------------------------|-----------------|--------------|----------|---------|
| 1 | 11399.7400 | 63.48 | -0.25 | 63.23 | 74.00 | -10.77 | Peak | |
| 2 * | 11401.1550 | 52.18 | -0.25 | 51.93 | 54.00 | -2.07 | AVG | |
| 3 | 17093.2000 | 52.27 | 5.40 | 57.67 | 68.30 | -10.63 | Peak | |

REMARKS:

- (1) Measurement Value = Reading Level + Correct Factor.
- (2) Margin Level = Measurement Value - Limit Value.

| | |
|-----------------|----------------------------|
| Orthogonal Axis | X |
| Test Mode | UNII-2C_TX A Mode 5700 MHz |

Horizontal

130 dBuV/m

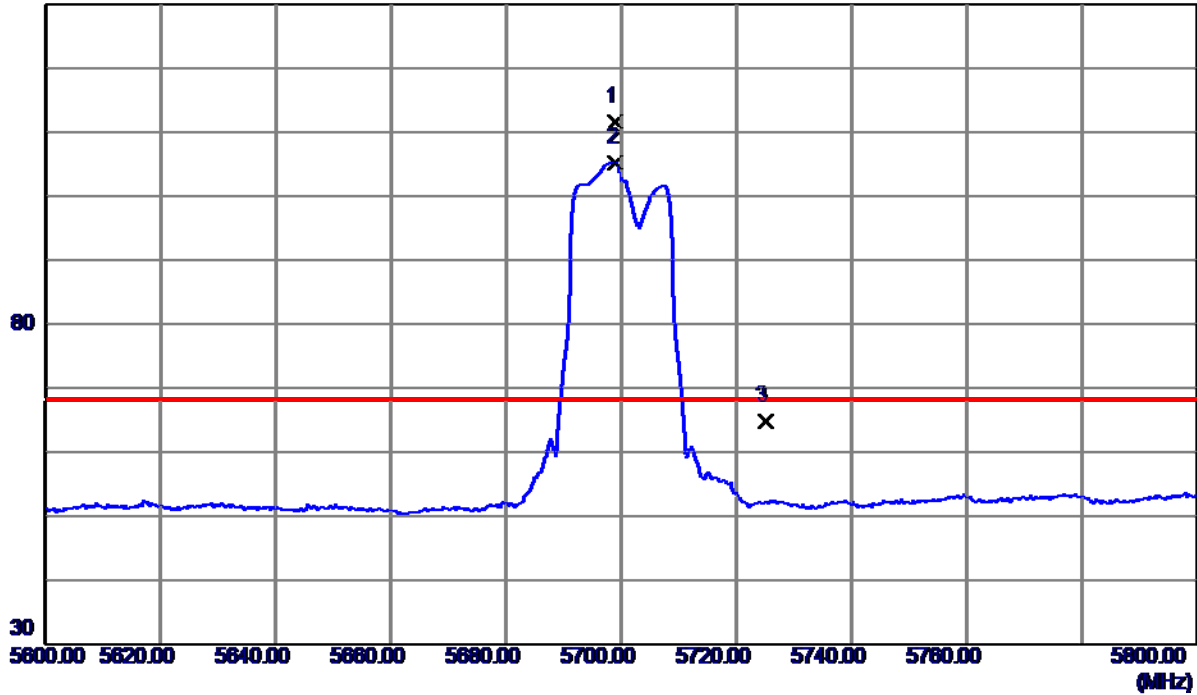

| No. | Freq. MHz | Reading Level dBuV/m | Correct Factor dB | Measure ment dBuV/m | Limit dBuV/m | Margin dB | Detector | Comment |
|-----|--------------|----------------------------|-------------------------|---------------------------|-----------------|--------------|----------|----------|
| 1 * | 5698.8000 | 71.65 | 39.98 | 111.63 | 68.30 | 43.33 | Peak | No Limit |
| 2 | 5699.0000 | 65.22 | 39.98 | 105.20 | 999.00 | -893.80 | AVG | No Limit |
| 3 | 5725.0000 | 24.72 | 40.05 | 64.77 | 68.30 | -3.53 | Peak | |

REMARKS:

- (1) Measurement Value = Reading Level + Correct Factor.
- (2) Margin Level = Measurement Value - Limit Value.

| | |
|-----------------|----------------------------|
| Orthogonal Axis | X |
| Test Mode | UNII-2C_TX A Mode 5700 MHz |

Horizontal

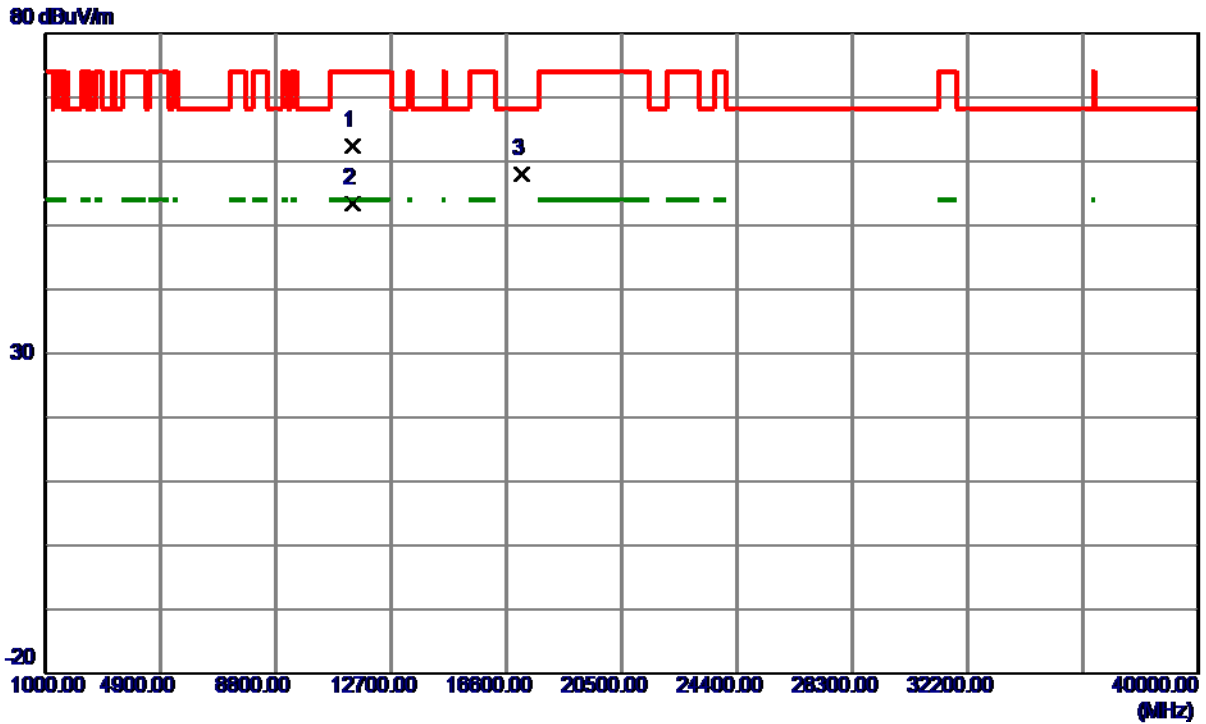

| No. | Freq. MHz | Reading Level dBuV/m | Correct Factor dB | Measure ment dBuV/m | Limit dBuV/m | Margin dB | Detector | Comment |
|-----|--------------|----------------------------|-------------------------|---------------------------|-----------------|--------------|----------|---------|
| 1 | 11401.1200 | 62.66 | -0.25 | 62.41 | 74.00 | -11.59 | Peak | |
| 2 * | 11401.7150 | 53.69 | -0.25 | 53.44 | 54.00 | -0.56 | AVG | |
| 3 | 17099.7000 | 52.58 | 5.41 | 57.99 | 68.30 | -10.31 | Peak | |

REMARKS:

- (1) Measurement Value = Reading Level + Correct Factor.
- (2) Margin Level = Measurement Value - Limit Value.

| | |
|-----------------|---------------------------|
| Orthogonal Axis | X |
| Test Mode | UNII-3_TX A Mode 5745 MHz |

Vertical

130 dBuV/m

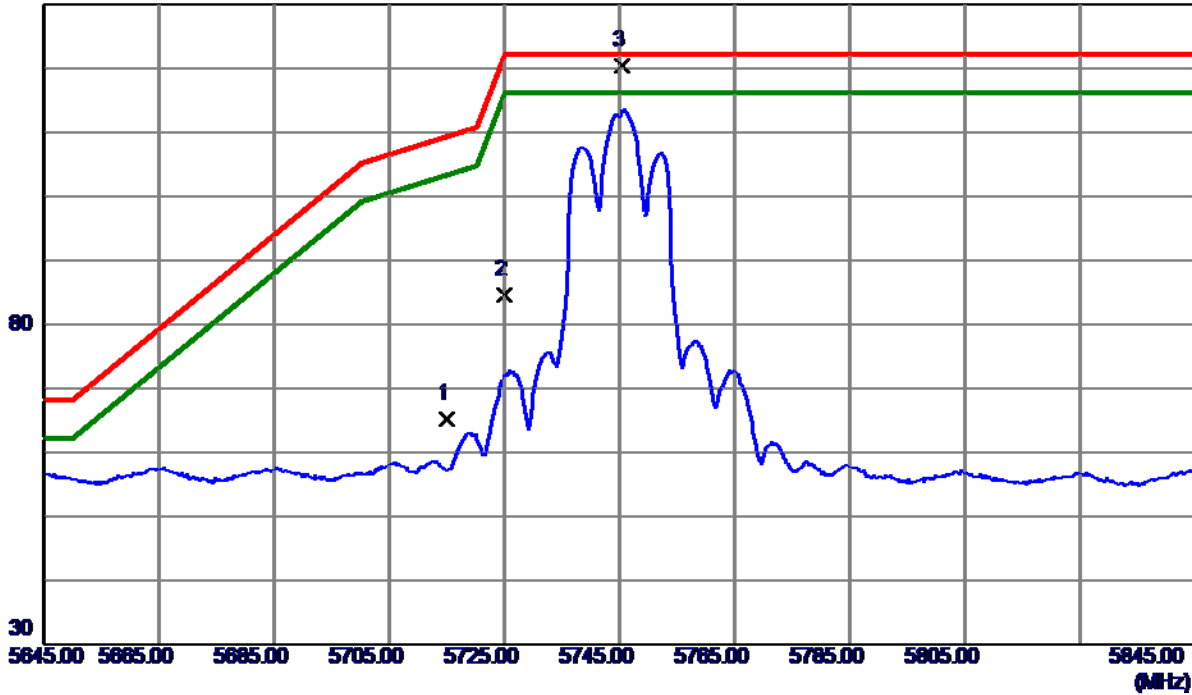

| No. | Freq. MHz | Reading Level dBuV/m | Correct Factor dB | Measure ment dBuV/m | Limit dBuV/m | Margin dB | Detector | Comment |
|-----|--------------|----------------------------|-------------------------|---------------------------|-----------------|--------------|----------|---------|
| 1 | 5715.0000 | 25.18 | 40.02 | 65.20 | 109.40 | -44.20 | Peak | |
| 2 | 5725.0000 | 44.58 | 40.05 | 84.63 | 122.20 | -37.57 | Peak | |
| 3 * | 5745.4000 | 80.22 | 40.09 | 120.31 | 122.20 | -1.89 | Peak | |

REMARKS:

- (1) Measurement Value = Reading Level + Correct Factor.
- (2) Margin Level = Measurement Value - Limit Value.

| | |
|-----------------|---------------------------|
| Orthogonal Axis | X |
| Test Mode | UNII-3_TX A Mode 5745 MHz |

Vertical

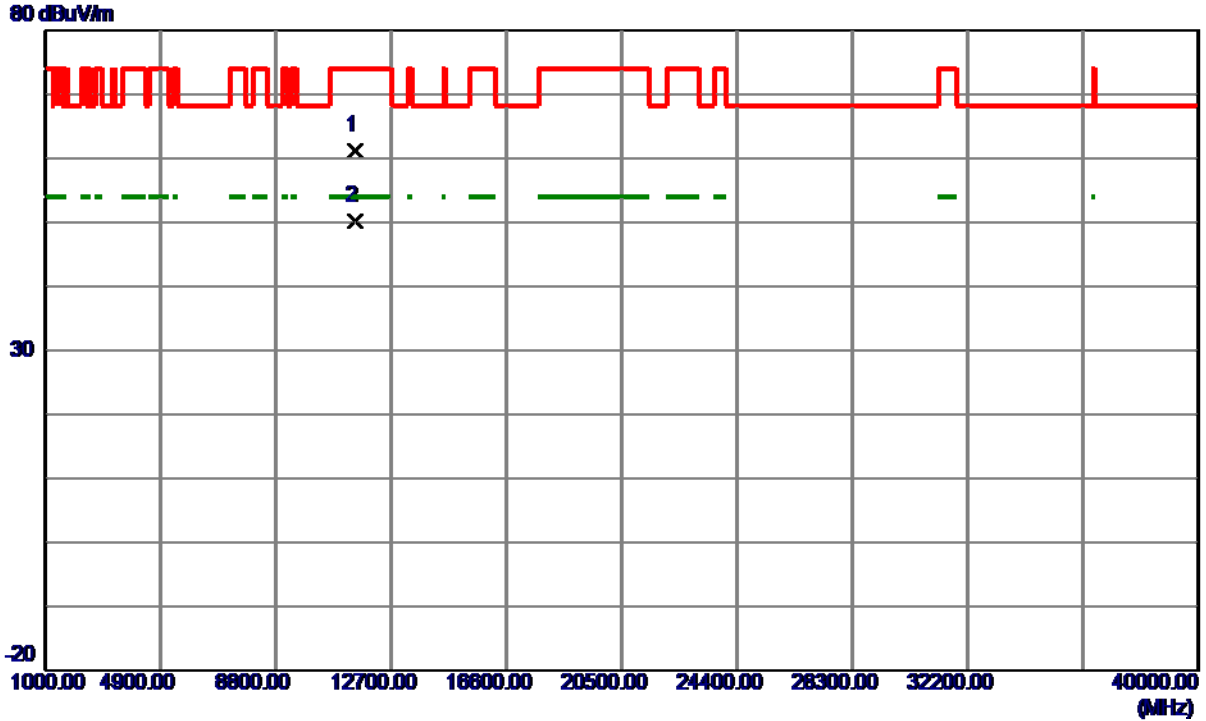

| No. | Freq. MHz | Reading Level dBuV/m | Correct Factor dB | Measure ment dBuV/m | Limit dBuV/m | Margin dB | Detector | Comment |
|-----|--------------|----------------------------|-------------------------|---------------------------|-----------------|--------------|----------|---------|
| 1 | 11489.6550 | 61.62 | -0.37 | 61.25 | 74.00 | -12.75 | Peak | |
| 2 * | 11490.0350 | 50.64 | -0.37 | 50.27 | 54.00 | -3.73 | AVG | |

REMARKS:

- (1) Measurement Value = Reading Level + Correct Factor.
- (2) Margin Level = Measurement Value - Limit Value.

| | |
|-----------------|---------------------------|
| Orthogonal Axis | X |
| Test Mode | UNII-3_TX A Mode 5745 MHz |

Horizontal

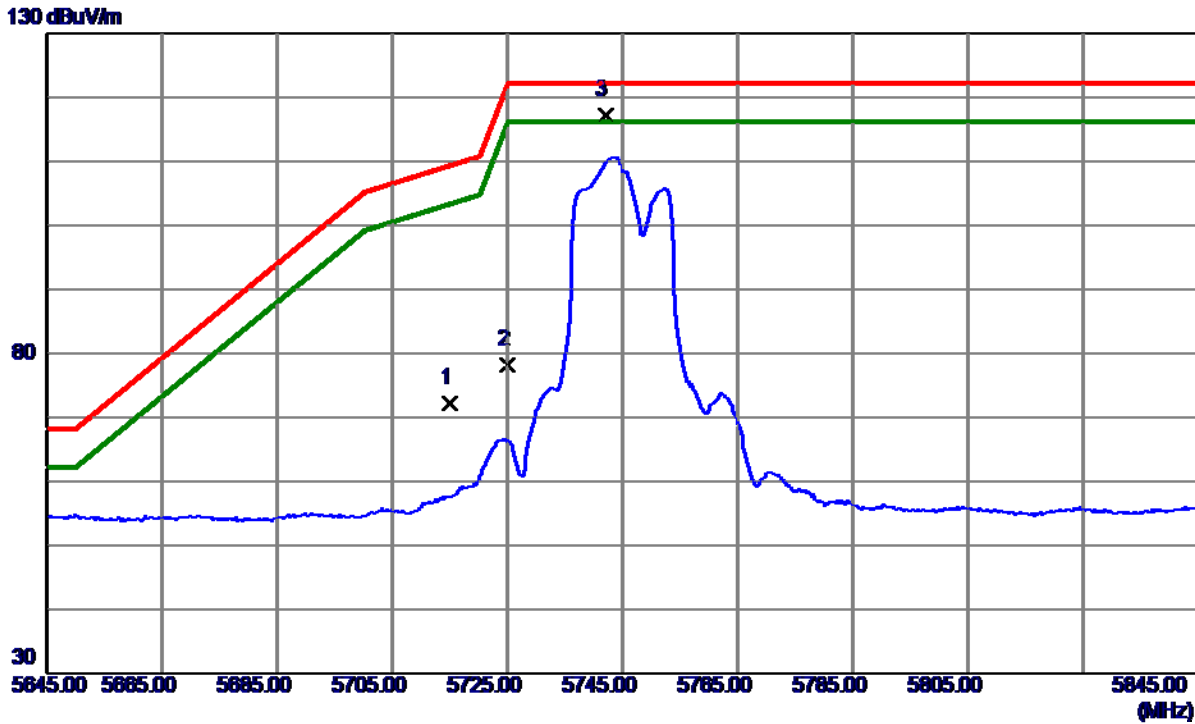

| No. | Freq. MHz | Reading Level dBuV/m | Correct Factor dB | Measure ment dBuV/m | Limit dBuV/m | Margin dB | Detector | Comment |
|-----|--------------|----------------------------|-------------------------|---------------------------|-----------------|--------------|----------|---------|
| 1 | 5715.0000 | 32.11 | 40.02 | 72.13 | 109.40 | -37.27 | Peak | |
| 2 | 5725.0000 | 38.24 | 40.05 | 78.29 | 122.20 | -43.91 | Peak | |
| 3 * | 5742.0000 | 77.15 | 40.09 | 117.24 | 122.20 | -4.96 | Peak | |

REMARKS:

- (1) Measurement Value = Reading Level + Correct Factor.
- (2) Margin Level = Measurement Value - Limit Value.

| | |
|-----------------|---------------------------|
| Orthogonal Axis | X |
| Test Mode | UNII-3_TX A Mode 5745 MHz |

Horizontal

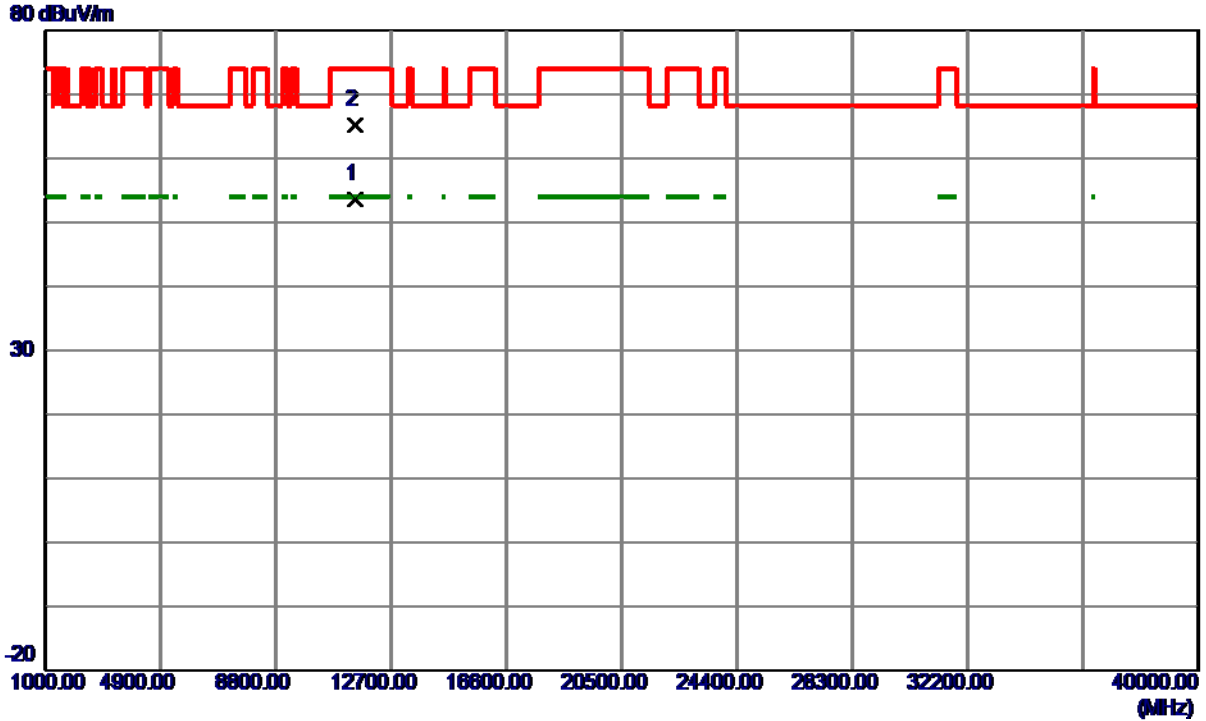

| No. | Freq. MHz | Reading Level dBuV/m | Correct Factor dB | Measure ment dBuV/m | Limit dBuV/m | Margin dB | Detector | Comment |
|-----|--------------|----------------------------|-------------------------|---------------------------|-----------------|--------------|----------|---------|
| 1 * | 11488.0400 | 53.94 | -0.36 | 53.58 | 54.00 | -0.42 | AVG | |
| 2 | 11488.5950 | 65.64 | -0.37 | 65.27 | 74.00 | -8.73 | Peak | |

REMARKS:

- (1) Measurement Value = Reading Level + Correct Factor.
- (2) Margin Level = Measurement Value - Limit Value.

| | |
|-----------------|---------------------------|
| Orthogonal Axis | X |
| Test Mode | UNII-3_TX A Mode 5785 MHz |

Vertical

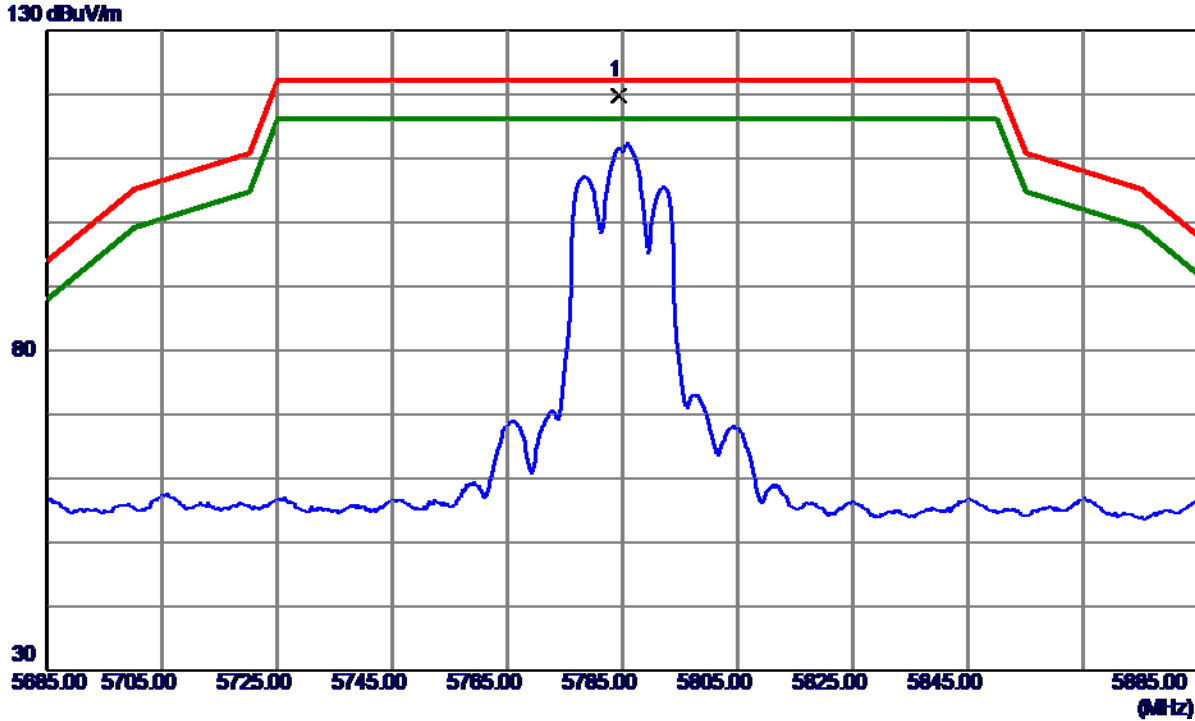

| No. | Freq. MHz | Reading Level dBuV/m | Correct Factor dB | Measure ment dBuV/m | Limit dBuV/m | Margin dB | Detector | Comment |
|-----|--------------|----------------------------|-------------------------|---------------------------|-----------------|--------------|----------|---------|
| 1 * | 5784.4000 | 79.66 | 40.19 | 119.85 | 122.20 | -2.35 | Peak | |

REMARKS:

- (1) Measurement Value = Reading Level + Correct Factor.
- (2) Margin Level = Measurement Value - Limit Value.

| | |
|-----------------|---------------------------|
| Orthogonal Axis | X |
| Test Mode | UNII-3_TX A Mode 5785 MHz |

Vertical

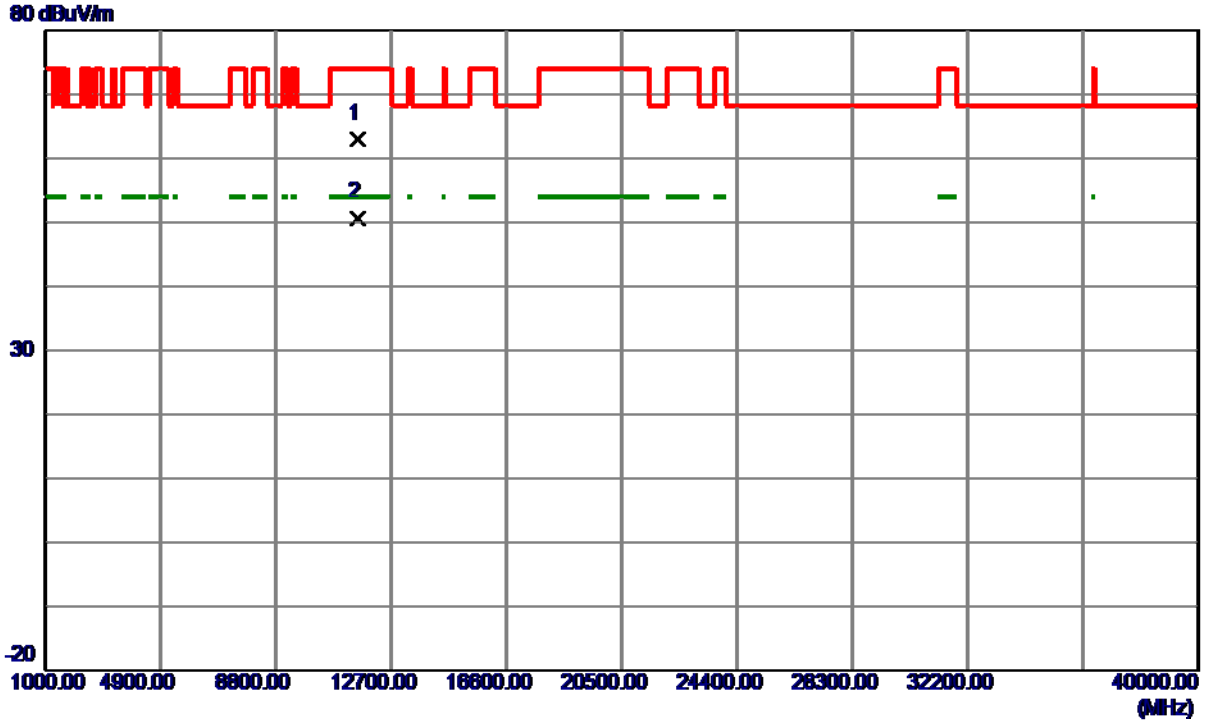

| No. | Freq. MHz | Reading Level dBuV/m | Correct Factor dB | Measure ment dBuV/m | Limit dBuV/m | Margin dB | Detector | Comment |
|-----|--------------|----------------------------|-------------------------|---------------------------|-----------------|--------------|----------|---------|
| 1 | 11570.0050 | 63.42 | -0.34 | 63.08 | 74.00 | -10.92 | Peak | |
| 2 * | 11570.2000 | 51.04 | -0.34 | 50.70 | 54.00 | -3.30 | AVG | |

REMARKS:

- (1) Measurement Value = Reading Level + Correct Factor.
- (2) Margin Level = Measurement Value - Limit Value.

| | |
|-----------------|---------------------------|
| Orthogonal Axis | X |
| Test Mode | UNII-3_TX A Mode 5785 MHz |

Horizontal

130 dBuV/m

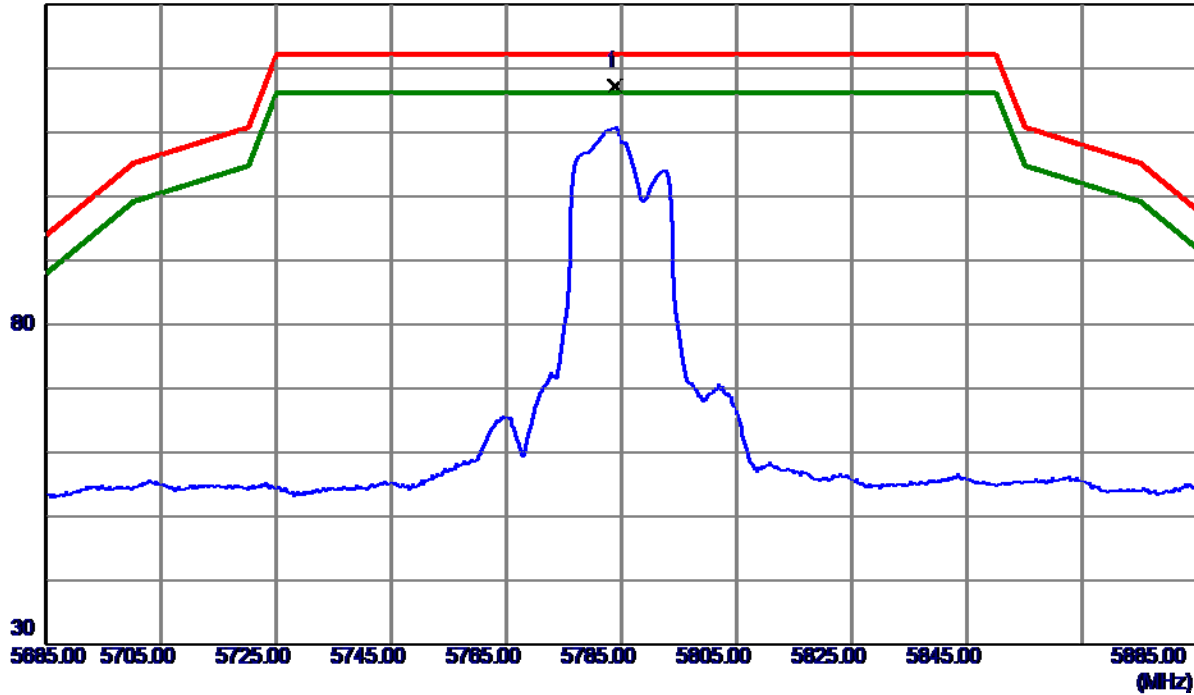

| No. | Freq. MHz | Reading Level dBuV/m | Correct Factor dB | Measure ment dBuV/m | Limit dBuV/m | Margin dB | Detector | Comment |
|-----|--------------|----------------------------|-------------------------|---------------------------|-----------------|--------------|----------|---------|
| 1 * | 5783.8000 | 76.99 | 40.19 | 117.18 | 122.20 | -5.02 | Peak | |

REMARKS:

- (1) Measurement Value = Reading Level + Correct Factor.
- (2) Margin Level = Measurement Value - Limit Value.

| | |
|-----------------|---------------------------|
| Orthogonal Axis | X |
| Test Mode | UNII-3_TX A Mode 5785 MHz |

Horizontal

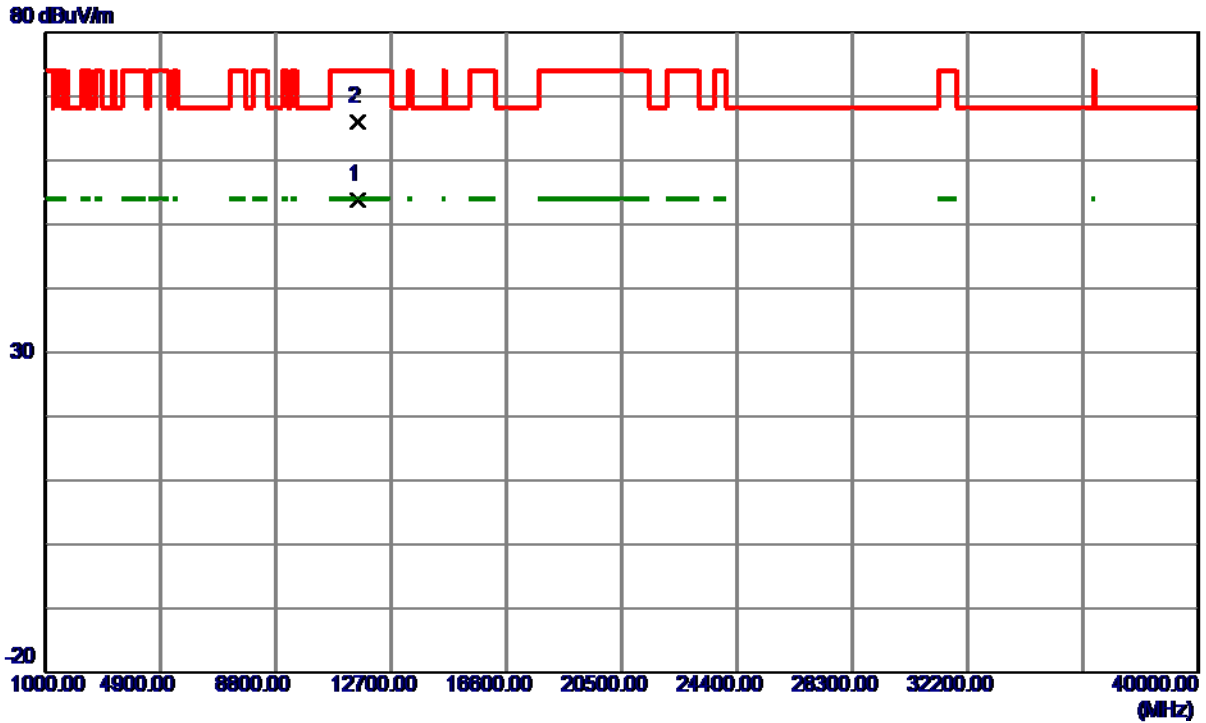

| No. | Freq. MHz | Reading Level dBuV/m | Correct Factor dB | Measure ment dBuV/m | Limit dBuV/m | Margin dB | Detector | Comment |
|-----|--------------|----------------------------|-------------------------|---------------------------|-----------------|--------------|----------|---------|
| 1 * | 11568.3750 | 54.05 | -0.34 | 53.71 | 54.00 | -0.29 | AVG | |
| 2 | 11569.7100 | 66.40 | -0.34 | 66.06 | 74.00 | -7.94 | Peak | |

REMARKS:

- (1) Measurement Value = Reading Level + Correct Factor.
- (2) Margin Level = Measurement Value - Limit Value.

| | |
|-----------------|---------------------------|
| Orthogonal Axis | X |
| Test Mode | UNII-3_TX A Mode 5825 MHz |

Vertical

130 dBuV/m

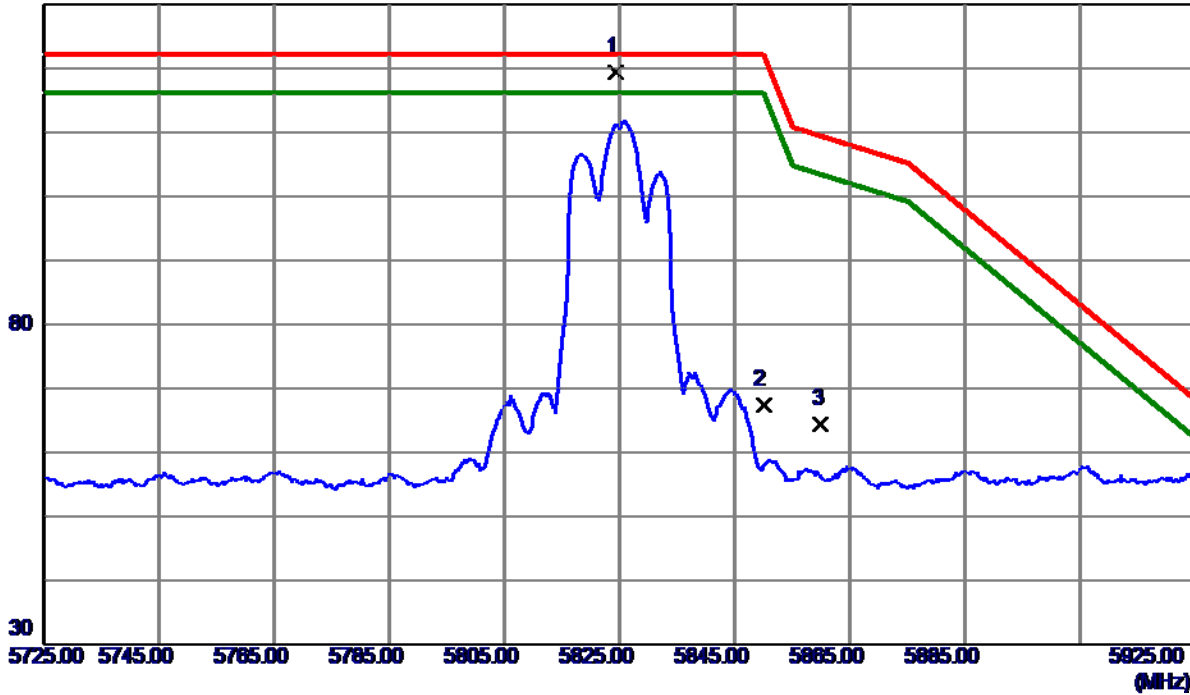

| No. | Freq. MHz | Reading Level dBuV/m | Correct Factor dB | Measure ment dBuV/m | Limit dBuV/m | Margin dB | Detector | Comment |
|-----|--------------|----------------------------|-------------------------|---------------------------|-----------------|--------------|----------|---------|
| 1 * | 5824.4000 | 79.19 | 40.28 | 119.47 | 122.20 | -2.73 | Peak | |
| 2 | 5850.0000 | 27.01 | 40.34 | 67.35 | 122.20 | -54.85 | Peak | |
| 3 | 5860.0000 | 24.02 | 40.37 | 64.39 | 109.40 | -45.01 | Peak | |

REMARKS:

- (1) Measurement Value = Reading Level + Correct Factor.
- (2) Margin Level = Measurement Value - Limit Value.

| | |
|-----------------|---------------------------|
| Orthogonal Axis | X |
| Test Mode | UNII-3_TX A Mode 5825 MHz |

Vertical

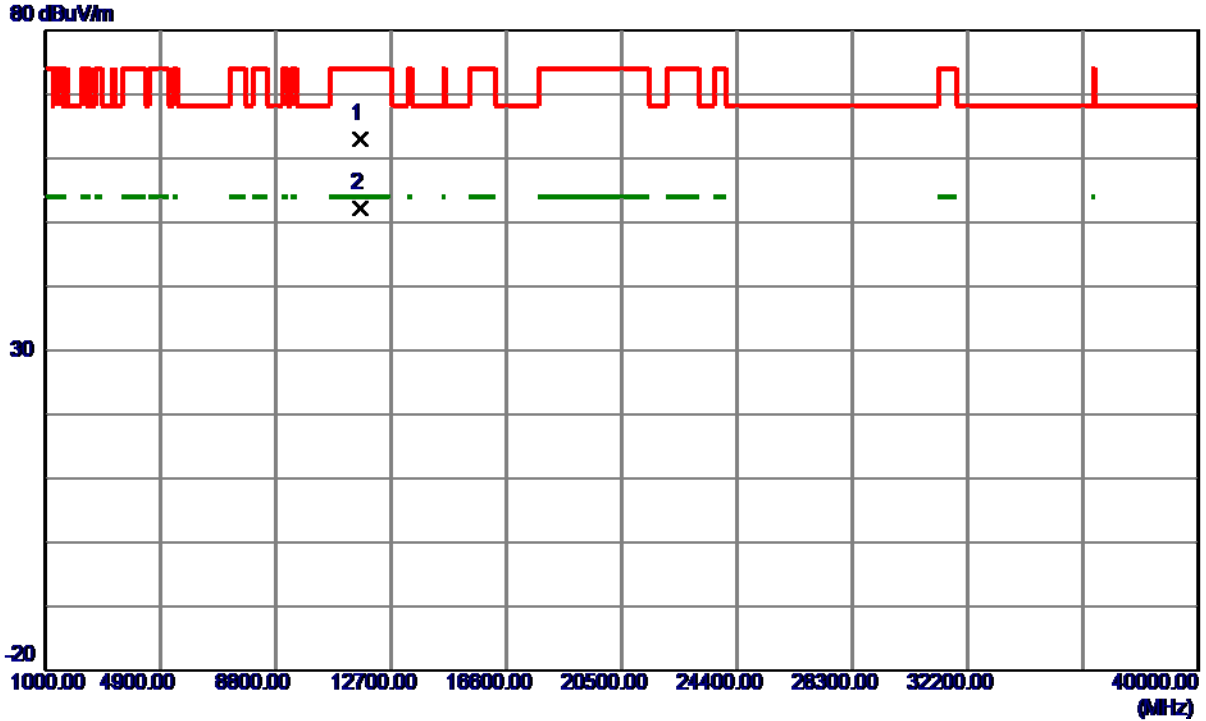

| No. | Freq. MHz | Reading Level dBuV/m | Correct Factor dB | Measure ment dBuV/m | Limit dBuV/m | Margin dB | Detector | Comment |
|-----|--------------|----------------------------|-------------------------|---------------------------|-----------------|--------------|----------|---------|
| 1 | 11649.8350 | 63.21 | -0.30 | 62.91 | 74.00 | -11.09 | Peak | |
| 2 * | 11649.9550 | 52.46 | -0.30 | 52.16 | 54.00 | -1.84 | AVG | |

REMARKS:

- (1) Measurement Value = Reading Level + Correct Factor.
- (2) Margin Level = Measurement Value - Limit Value.

| | |
|-----------------|---------------------------|
| Orthogonal Axis | X |
| Test Mode | UNII-3_TX A Mode 5825 MHz |

Horizontal

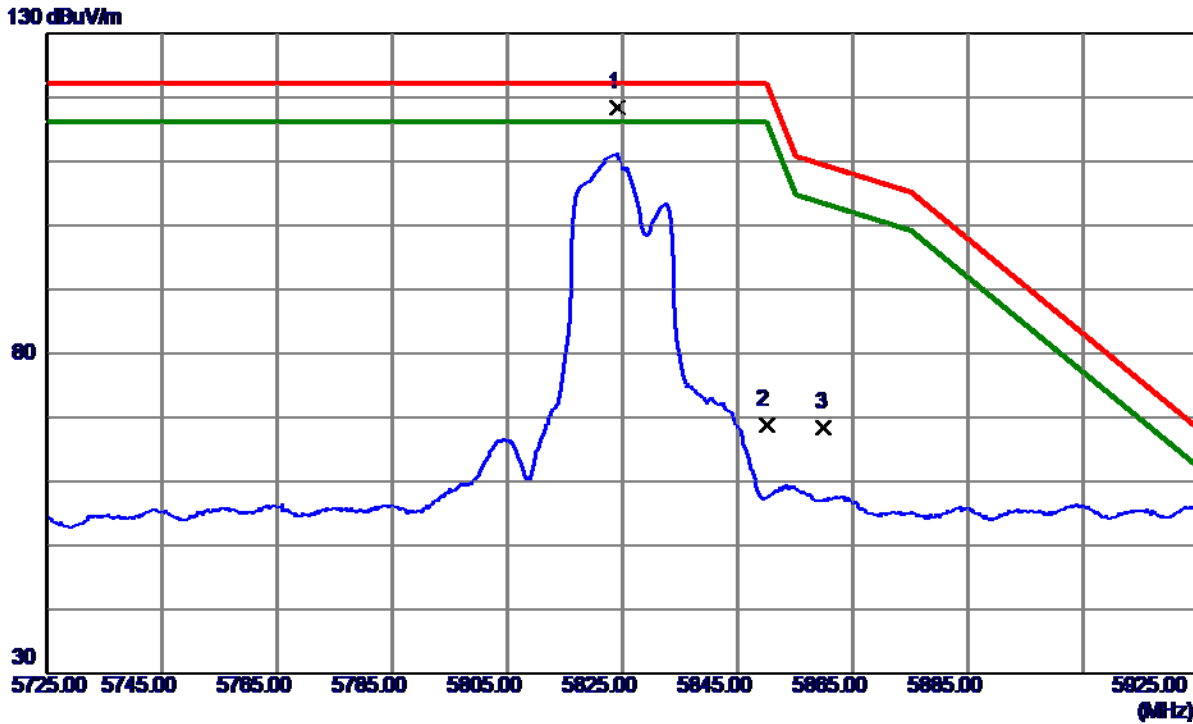

| No. | Freq. MHz | Reading Level dBuV/m | Correct Factor dB | Measure ment dBuV/m | Limit dBuV/m | Margin dB | Detector | Comment |
|-----|--------------|----------------------------|-------------------------|---------------------------|-----------------|--------------|----------|---------|
| 1 * | 5824.2000 | 78.20 | 40.28 | 118.48 | 122.20 | -3.72 | Peak | |
| 2 | 5850.0000 | 28.48 | 40.34 | 68.82 | 122.20 | -53.38 | Peak | |
| 3 | 5860.0000 | 28.08 | 40.37 | 68.45 | 109.40 | -40.95 | Peak | |

REMARKS:

- (1) Measurement Value = Reading Level + Correct Factor.
- (2) Margin Level = Measurement Value - Limit Value.

| | |
|-----------------|---------------------------|
| Orthogonal Axis | X |
| Test Mode | UNII-3_TX A Mode 5825 MHz |

Horizontal

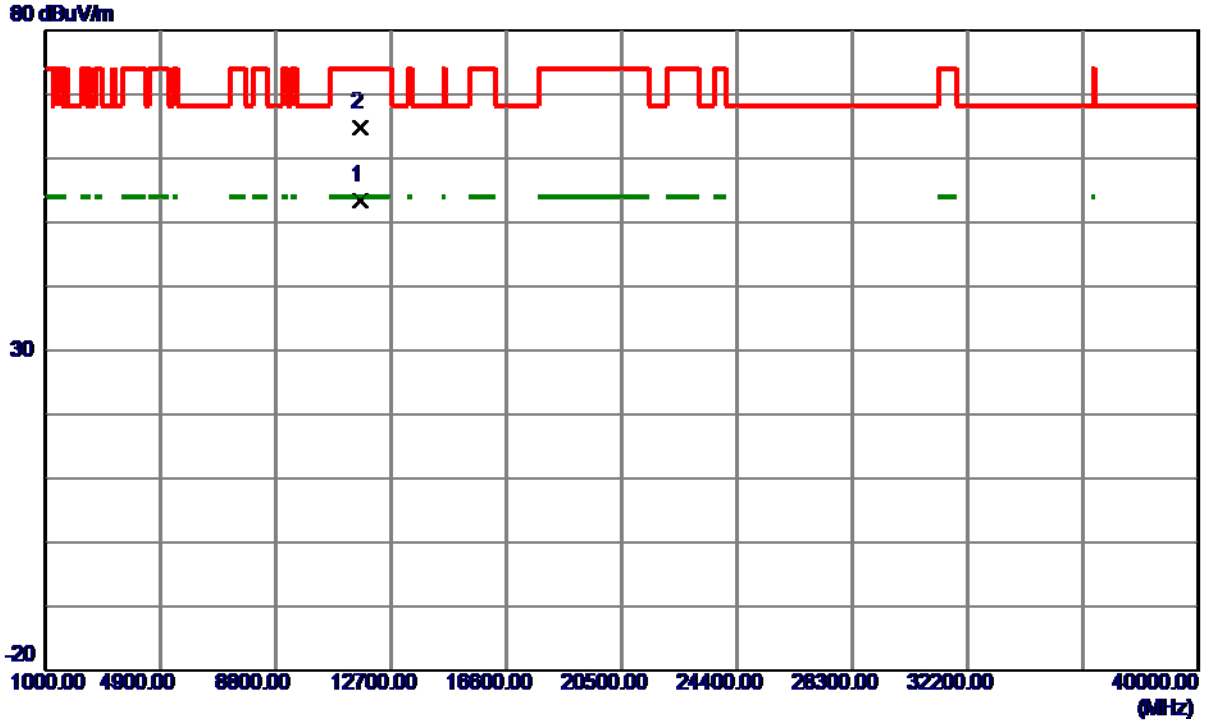

| No. | Freq. MHz | Reading Level dBuV/m | Correct Factor dB | Measure ment dBuV/m | Limit dBuV/m | Margin dB | Detector | Comment |
|-----|--------------|----------------------------|-------------------------|---------------------------|-----------------|--------------|----------|---------|
| 1 * | 11648.2450 | 53.76 | -0.30 | 53.46 | 54.00 | -0.54 | AVG | |
| 2 | 11648.7200 | 65.14 | -0.30 | 64.84 | 74.00 | -9.16 | Peak | |

REMARKS:

- (1) Measurement Value = Reading Level + Correct Factor.
- (2) Margin Level = Measurement Value - Limit Value.

| | |
|-----------------|------------------------------------|
| Orthogonal Axis | X |
| Test Mode | UNII-1_TX AC (VHT20) Mode 5180 MHz |

Vertical

130 dBuV/m

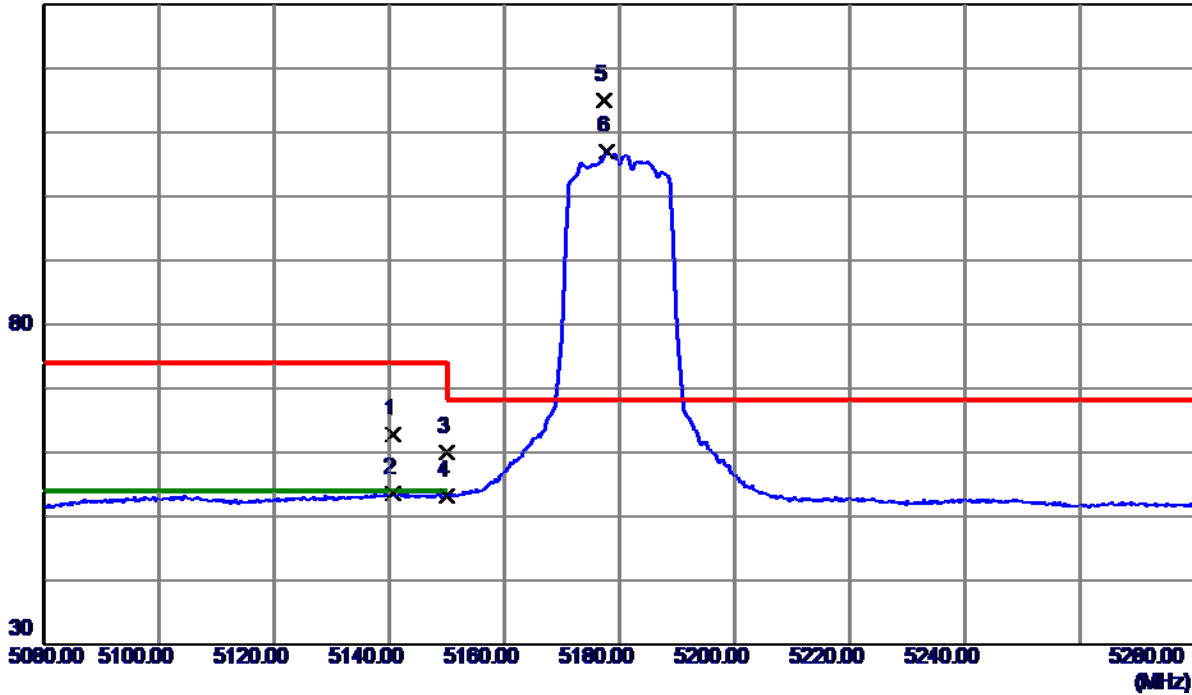

| No. | Freq. MHz | Reading Level dBuV/m | Correct Factor dB | Measure ment dBuV/m | Limit dBuV/m | Margin dB | Detector | Comment |
|-----|--------------|----------------------------|-------------------------|---------------------------|-----------------|--------------|----------|----------|
| 1 | 5140.6000 | 23.65 | 39.06 | 62.71 | 74.00 | -11.29 | Peak | |
| 2 | 5140.6000 | 14.51 | 39.06 | 53.57 | 54.00 | -0.43 | AVG | |
| 3 | 5150.0000 | 20.93 | 39.07 | 60.00 | 74.00 | -14.00 | Peak | |
| 4 | 5150.0000 | 14.06 | 39.07 | 53.13 | 54.00 | -0.87 | AVG | |
| 5 * | 5177.4000 | 75.80 | 39.10 | 114.90 | 68.30 | 46.60 | Peak | No Limit |
| 6 | 5177.8000 | 67.93 | 39.10 | 107.03 | 999.00 | -891.97 | AVG | No Limit |

REMARKS:

- (1) Measurement Value = Reading Level + Correct Factor.
- (2) Margin Level = Measurement Value - Limit Value.

| | |
|-----------------|------------------------------------|
| Orthogonal Axis | X |
| Test Mode | UNII-1_TX AC (VHT20) Mode 5180 MHz |

Vertical

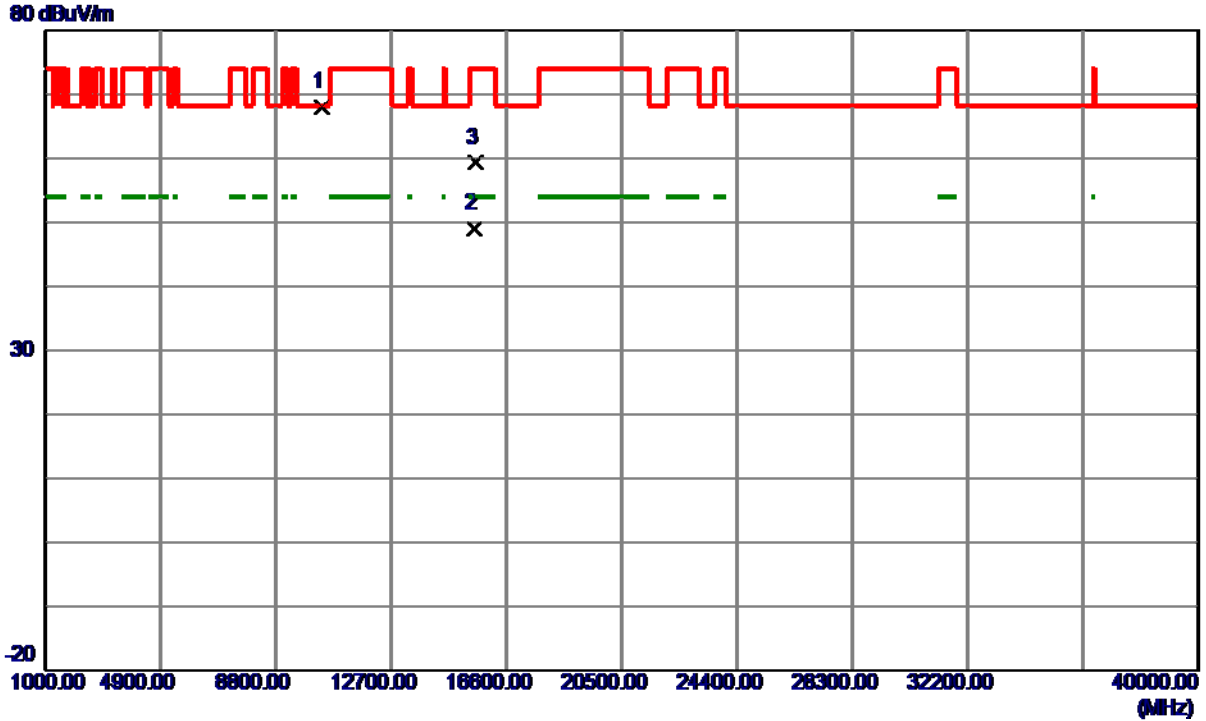

| No. | Freq. MHz | Reading Level dBuV/m | Correct Factor dB | Measure ment dBuV/m | Limit dBuV/m | Margin dB | Detector | Comment |
|-----|--------------|----------------------------|-------------------------|---------------------------|-----------------|--------------|----------|---------|
| 1 * | 10358.3099 | 69.60 | -1.65 | 67.95 | 68.30 | -0.35 | Peak | |
| 2 | 15537.0400 | 45.94 | 3.12 | 49.06 | 54.00 | -4.94 | AVG | |
| 3 | 15538.8600 | 56.18 | 3.12 | 59.30 | 74.00 | -14.70 | Peak | |

REMARKS:

- (1) Measurement Value = Reading Level + Correct Factor.
- (2) Margin Level = Measurement Value - Limit Value.

| | |
|-----------------|------------------------------------|
| Orthogonal Axis | X |
| Test Mode | UNII-1_TX AC (VHT20) Mode 5180 MHz |

Horizontal

130 dBuV/m

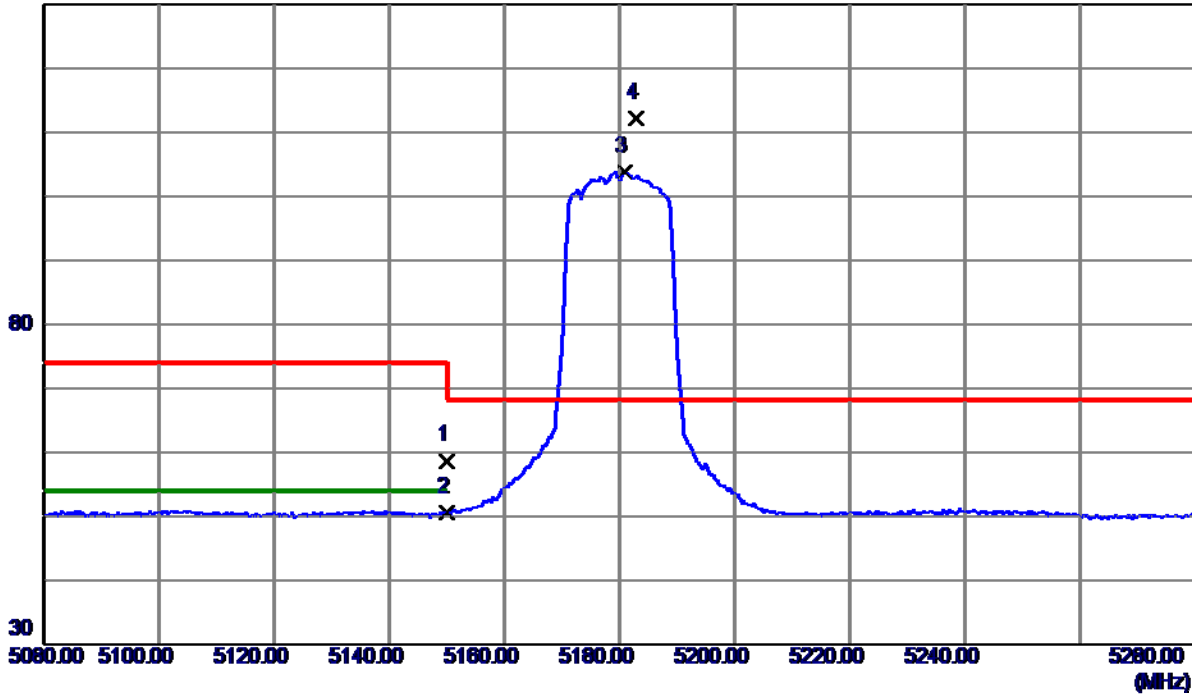

| No. | Freq. MHz | Reading Level dBuV/m | Correct Factor dB | Measure ment dBuV/m | Limit dBuV/m | Margin dB | Detector | Comment |
|-----|--------------|----------------------------|-------------------------|---------------------------|-----------------|--------------|----------|----------|
| 1 | 5150.0000 | 19.63 | 39.07 | 58.70 | 74.00 | -15.30 | Peak | |
| 2 | 5150.0000 | 11.46 | 39.07 | 50.53 | 54.00 | -3.47 | AVG | |
| 3 | 5180.8000 | 64.63 | 39.11 | 103.74 | 999.00 | -895.26 | AVG | No Limit |
| 4 * | 5182.8000 | 73.07 | 39.11 | 112.18 | 68.30 | 43.88 | Peak | No Limit |

REMARKS:

- (1) Measurement Value = Reading Level + Correct Factor.
- (2) Margin Level = Measurement Value - Limit Value.

| | |
|-----------------|------------------------------------|
| Orthogonal Axis | X |
| Test Mode | UNII-1_TX AC (VHT20) Mode 5180 MHz |

Horizontal

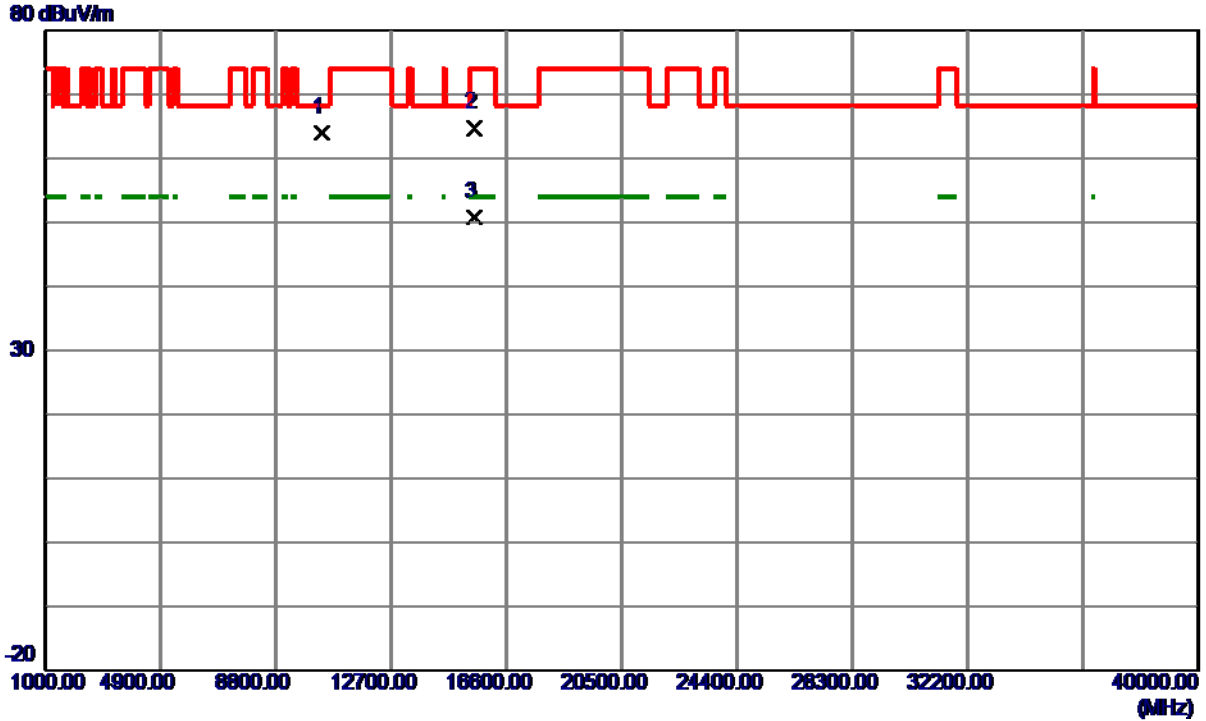

| No. | Freq. MHz | Reading Level dBuV/m | Correct Factor dB | Measure ment dBuV/m | Limit dBuV/m | Margin dB | Detector | Comment |
|-----|--------------|----------------------------|-------------------------|---------------------------|-----------------|--------------|----------|---------|
| 1 | 10362.2050 | 65.66 | -1.64 | 64.02 | 68.30 | -4.28 | Peak | |
| 2 | 15534.2000 | 61.57 | 3.13 | 64.70 | 74.00 | -9.30 | Peak | |
| 3 * | 15537.6800 | 47.66 | 3.12 | 50.78 | 54.00 | -3.22 | AVG | |

REMARKS:

- (1) Measurement Value = Reading Level + Correct Factor.
- (2) Margin Level = Measurement Value - Limit Value.

| | |
|-----------------|------------------------------------|
| Orthogonal Axis | X |
| Test Mode | UNII-1_TX AC (VHT20) Mode 5200 MHz |

Vertical

130 dBuV/m

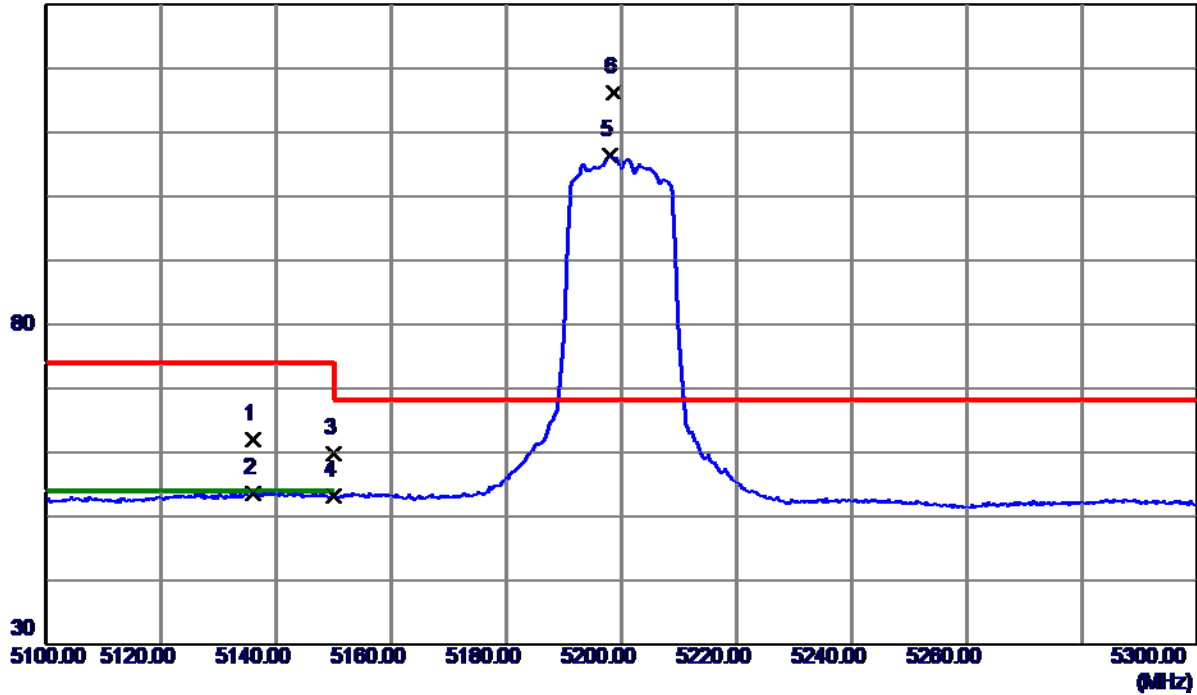

| No. | Freq. MHz | Reading Level dBuV/m | Correct Factor dB | Measure ment dBuV/m | Limit dBuV/m | Margin dB | Detector | Comment |
|-----|--------------|----------------------------|-------------------------|---------------------------|-----------------|--------------|----------|----------|
| 1 | 5136.0000 | 22.86 | 39.05 | 61.91 | 74.00 | -12.09 | Peak | |
| 2 | 5136.0000 | 14.56 | 39.05 | 53.61 | 54.00 | -0.39 | AVG | |
| 3 | 5150.0000 | 20.77 | 39.07 | 59.84 | 74.00 | -14.16 | Peak | |
| 4 | 5150.0000 | 14.04 | 39.07 | 53.11 | 54.00 | -0.89 | AVG | |
| 5 | 5198.0000 | 67.32 | 39.13 | 106.45 | 999.00 | -892.55 | AVG | No Limit |
| 6 * | 5198.6000 | 77.12 | 39.13 | 116.25 | 68.30 | 47.95 | Peak | No Limit |

REMARKS:

- (1) Measurement Value = Reading Level + Correct Factor.
- (2) Margin Level = Measurement Value - Limit Value.

| | |
|-----------------|------------------------------------|
| Orthogonal Axis | X |
| Test Mode | UNII-1_TX AC (VHT20) Mode 5200 MHz |

Vertical

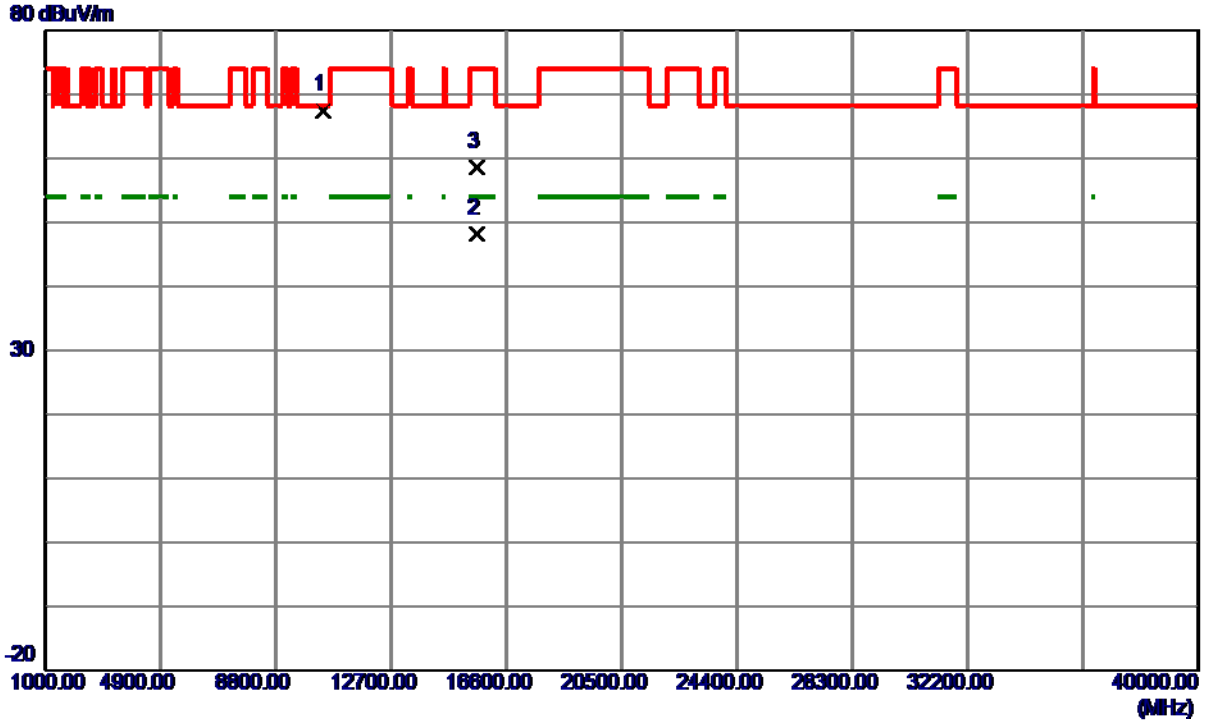

| No. | Freq. MHz | Reading Level dBuV/m | Correct Factor dB | Measure ment dBuV/m | Limit dBuV/m | Margin dB | Detector | Comment |
|-----|--------------|----------------------------|-------------------------|---------------------------|-----------------|--------------|----------|---------|
| 1 * | 10398.3949 | 69.11 | -1.61 | 67.50 | 68.30 | -0.80 | Peak | |
| 2 | 15599.1400 | 45.31 | 2.95 | 48.26 | 54.00 | -5.74 | AVG | |
| 3 | 15602.9200 | 55.57 | 2.94 | 58.51 | 74.00 | -15.49 | Peak | |

REMARKS:

- (1) Measurement Value = Reading Level + Correct Factor.
- (2) Margin Level = Measurement Value - Limit Value.

| | |
|-----------------|------------------------------------|
| Orthogonal Axis | X |
| Test Mode | UNII-1_TX AC (VHT20) Mode 5200 MHz |

Horizontal

130 dBuV/m

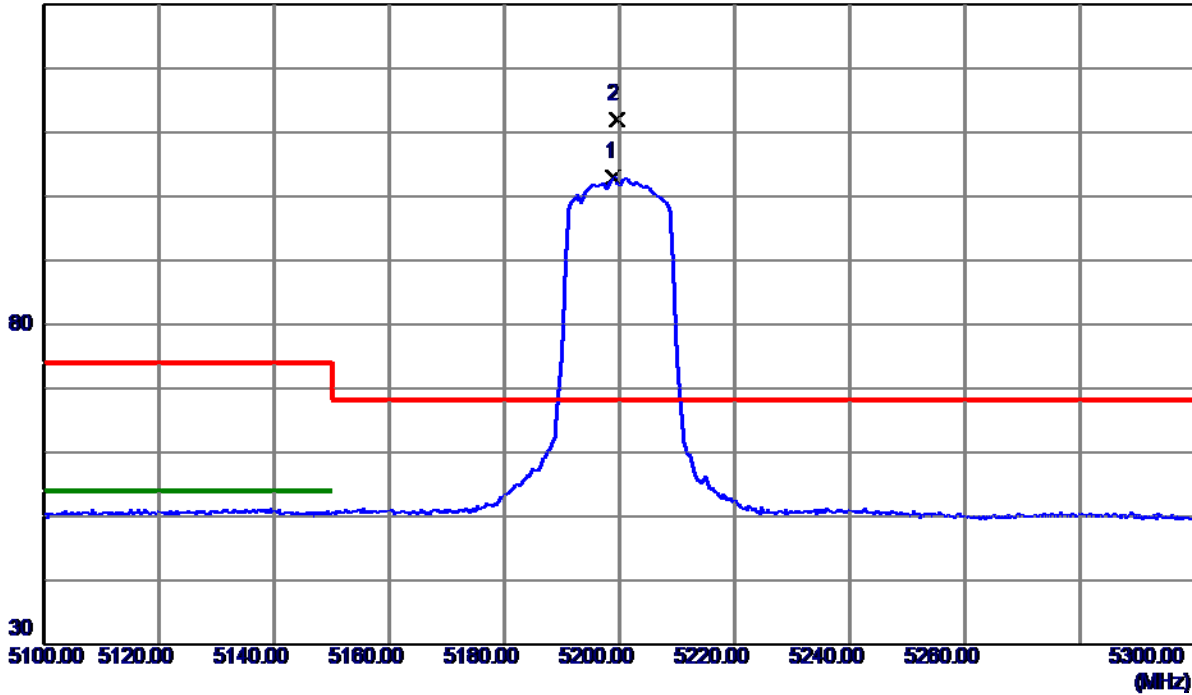

| No. | Freq. MHz | Reading Level dBuV/m | Correct Factor dB | Measure ment dBuV/m | Limit dBuV/m | Margin dB | Detector | Comment |
|-----|--------------|----------------------------|-------------------------|---------------------------|-----------------|--------------|----------|----------|
| 1 | 5199.0000 | 63.77 | 39.13 | 102.90 | 999.00 | -896.10 | AVG | No Limit |
| 2 * | 5199.6000 | 72.79 | 39.13 | 111.92 | 68.30 | 43.62 | Peak | No Limit |

REMARKS:

- (1) Measurement Value = Reading Level + Correct Factor.
- (2) Margin Level = Measurement Value - Limit Value.

| | |
|-----------------|------------------------------------|
| Orthogonal Axis | X |
| Test Mode | UNII-1_TX AC (VHT20) Mode 5200 MHz |

Horizontal

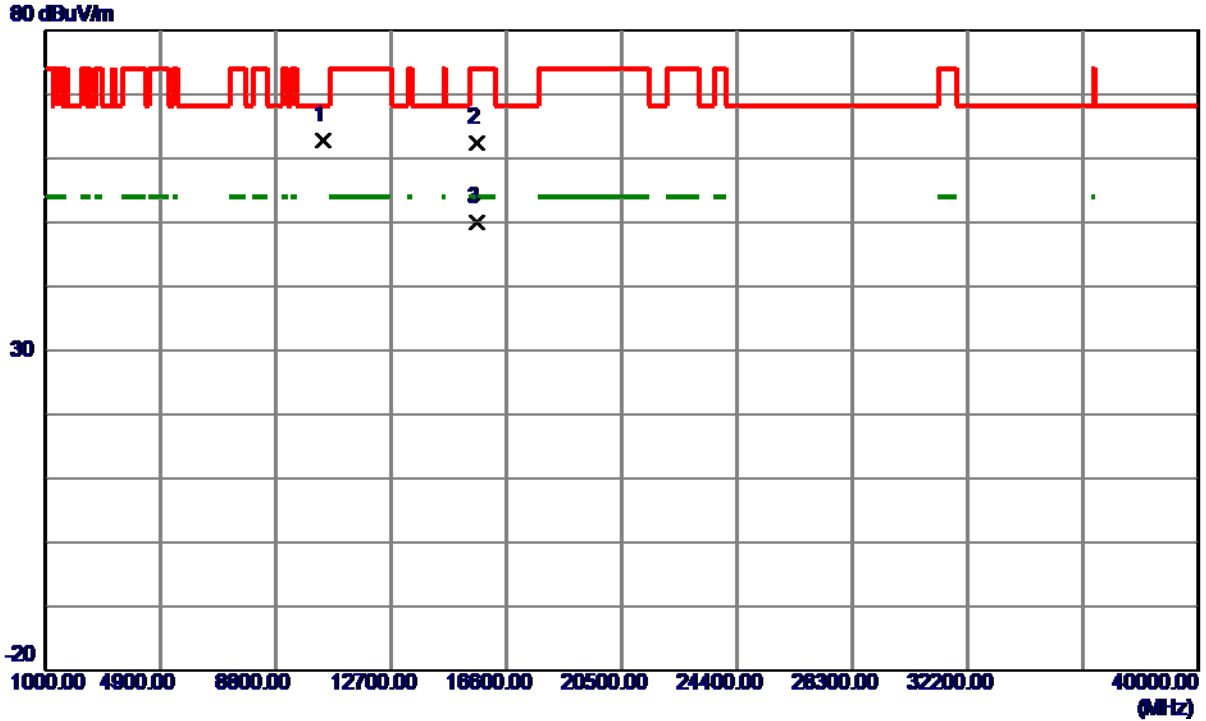

| No. | Freq. MHz | Reading Level dBuV/m | Correct Factor dB | Measure ment dBuV/m | Limit dBuV/m | Margin dB | Detector | Comment |
|-----|--------------|----------------------------|-------------------------|---------------------------|-----------------|--------------|----------|---------|
| 1 | 10401.8750 | 64.44 | -1.60 | 62.84 | 68.30 | -5.46 | Peak | |
| 2 | 15596.8800 | 59.49 | 2.95 | 62.44 | 74.00 | -11.56 | Peak | |
| 3 * | 15597.8000 | 47.13 | 2.95 | 50.08 | 54.00 | -3.92 | AVG | |

REMARKS:

- (1) Measurement Value = Reading Level + Correct Factor.
- (2) Margin Level = Measurement Value - Limit Value.

| | |
|-----------------|------------------------------------|
| Orthogonal Axis | X |
| Test Mode | UNII-1_TX AC (VHT20) Mode 5240 MHz |

Vertical

130 dBuV/m

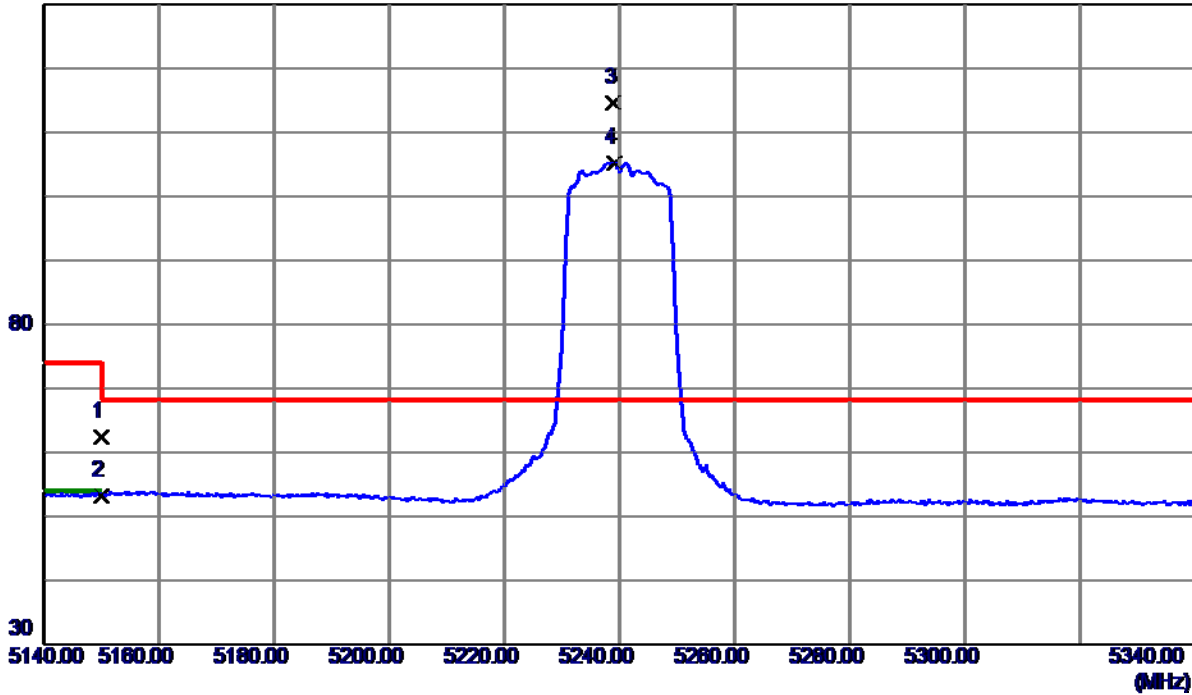

| No. | Freq. MHz | Reading Level dBuV/m | Correct Factor dB | Measure ment dBuV/m | Limit dBuV/m | Margin dB | Detector | Comment |
|-----|--------------|----------------------------|-------------------------|---------------------------|-----------------|--------------|----------|----------|
| 1 | 5150.0000 | 23.33 | 39.07 | 62.40 | 74.00 | -11.60 | Peak | |
| 2 | 5150.0000 | 14.20 | 39.07 | 53.27 | 54.00 | -0.73 | AVG | |
| 3 * | 5239.0000 | 75.44 | 39.18 | 114.62 | 68.30 | 46.32 | Peak | No Limit |
| 4 | 5239.2000 | 66.11 | 39.18 | 105.29 | 999.00 | -893.71 | AVG | No Limit |

REMARKS:

- (1) Measurement Value = Reading Level + Correct Factor.
- (2) Margin Level = Measurement Value - Limit Value.

| | |
|-----------------|------------------------------------|
| Orthogonal Axis | X |
| Test Mode | UNII-1_TX AC (VHT20) Mode 5240 MHz |

Vertical

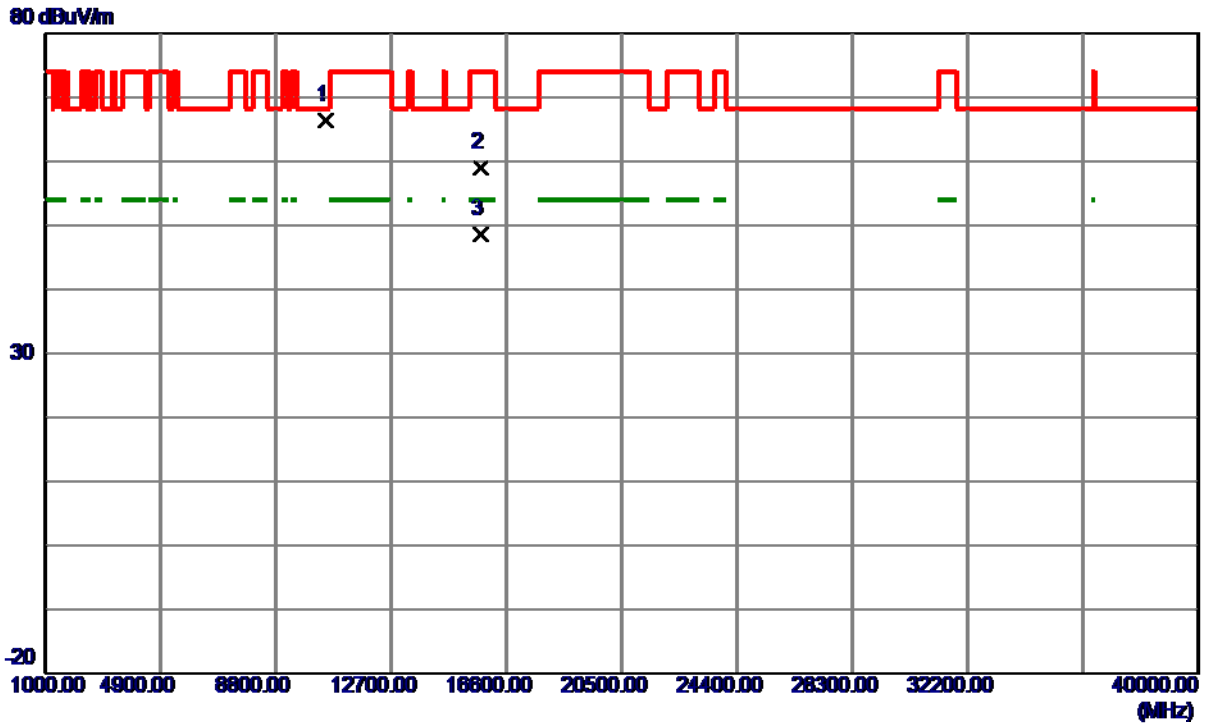

| No. | Freq. MHz | Reading Level dBuV/m | Correct Factor dB | Measure ment dBuV/m | Limit dBuV/m | Margin dB | Detector | Comment |
|-----|--------------|----------------------------|-------------------------|---------------------------|-----------------|--------------|----------|---------|
| 1 * | 10478.4000 | 67.99 | -1.53 | 66.46 | 68.30 | -1.84 | Peak | |
| 2 | 15716.1400 | 56.30 | 2.61 | 58.91 | 74.00 | -15.09 | Peak | |
| 3 | 15719.8000 | 45.98 | 2.60 | 48.58 | 54.00 | -5.42 | AVG | |

REMARKS:

- (1) Measurement Value = Reading Level + Correct Factor.
- (2) Margin Level = Measurement Value - Limit Value.

| | |
|-----------------|------------------------------------|
| Orthogonal Axis | X |
| Test Mode | UNII-1_TX AC (VHT20) Mode 5240 MHz |

Horizontal

130 dBuV/m

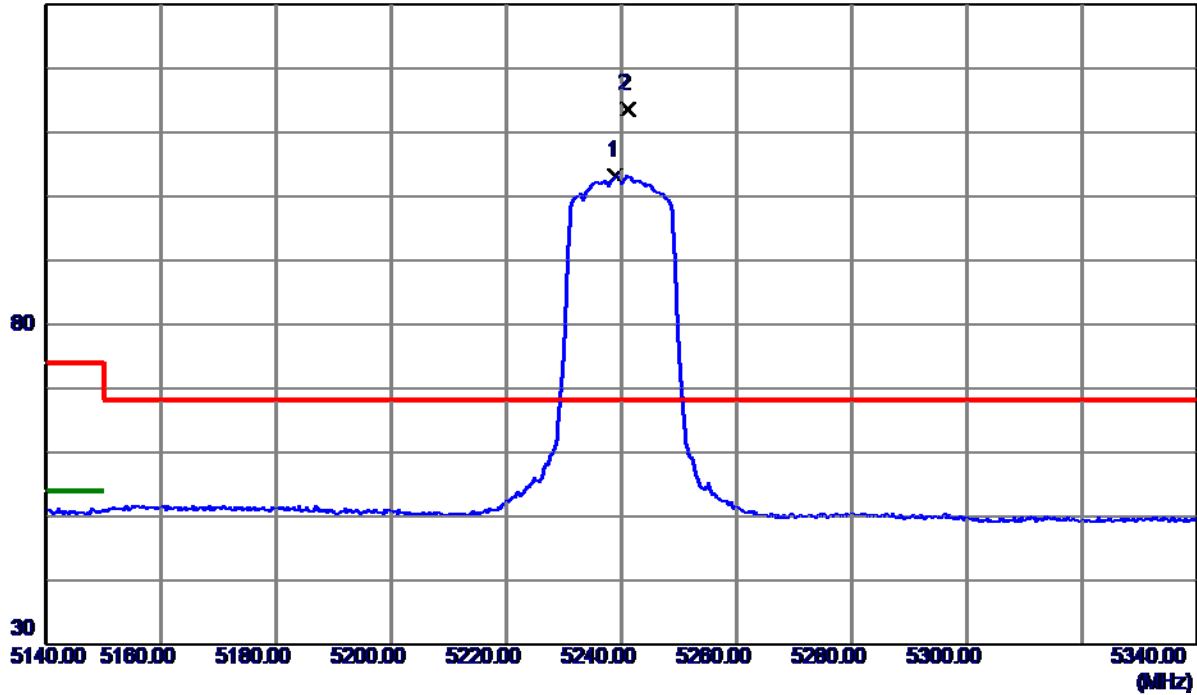

| No. | Freq. MHz | Reading Level dBuV/m | Correct Factor dB | Measure ment dBuV/m | Limit dBuV/m | Margin dB | Detector | Comment |
|-----|--------------|----------------------------|-------------------------|---------------------------|-----------------|--------------|----------|----------|
| 1 | 5239.0000 | 64.04 | 39.18 | 103.22 | 999.00 | -895.78 | AVG | No Limit |
| 2 * | 5241.2000 | 74.46 | 39.18 | 113.64 | 68.30 | 45.34 | Peak | No Limit |

REMARKS:

- (1) Measurement Value = Reading Level + Correct Factor.
- (2) Margin Level = Measurement Value - Limit Value.

| | |
|-----------------|------------------------------------|
| Orthogonal Axis | X |
| Test Mode | UNII-1_TX AC (VHT20) Mode 5240 MHz |

Horizontal

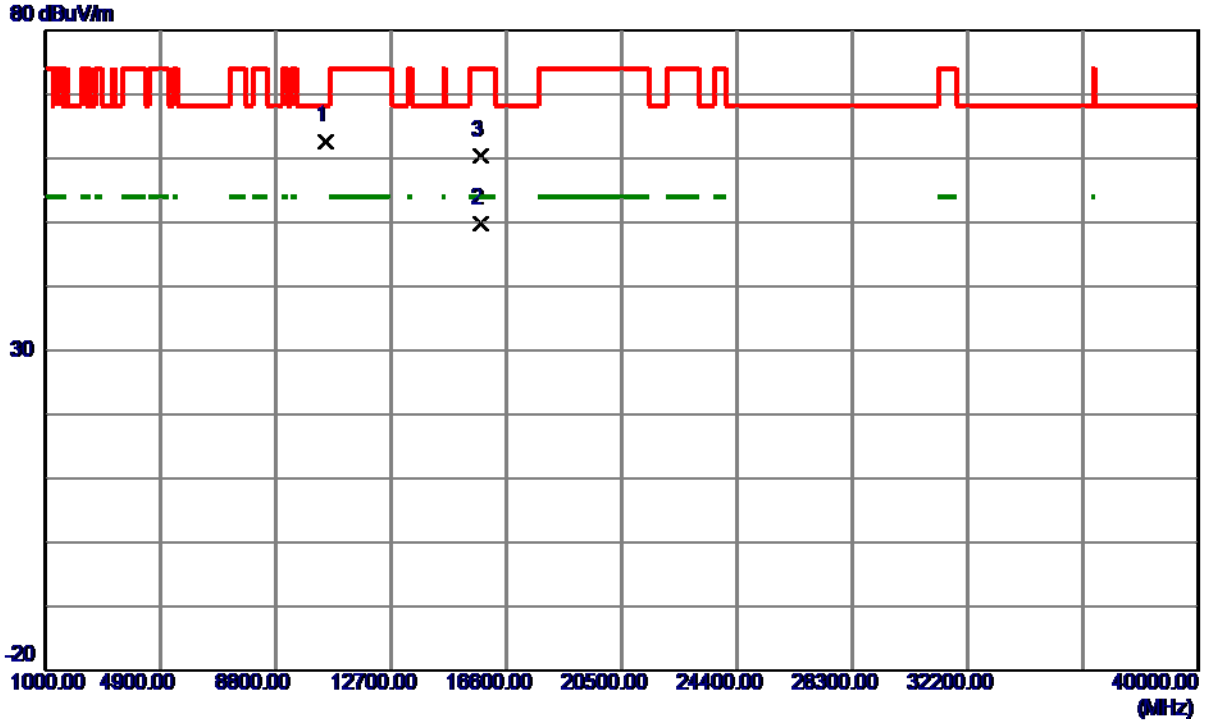

| No. | Freq. MHz | Reading Level dBuV/m | Correct Factor dB | Measure ment dBuV/m | Limit dBuV/m | Margin dB | Detector | Comment |
|-----|--------------|----------------------------|-------------------------|---------------------------|-----------------|--------------|----------|---------|
| 1 | 10482.1050 | 64.23 | -1.53 | 62.70 | 68.30 | -5.60 | Peak | |
| 2 * | 15717.3000 | 47.21 | 2.61 | 49.82 | 54.00 | -4.18 | AVG | |
| 3 | 15723.2000 | 57.79 | 2.59 | 60.38 | 74.00 | -13.62 | Peak | |

REMARKS:

- (1) Measurement Value = Reading Level + Correct Factor.
- (2) Margin Level = Measurement Value - Limit Value.

| | |
|-----------------|------------------------------------|
| Orthogonal Axis | X |
| Test Mode | UNII-1_TX AC (VHT40) Mode 5190 MHz |

Vertical

130 dBuV/m

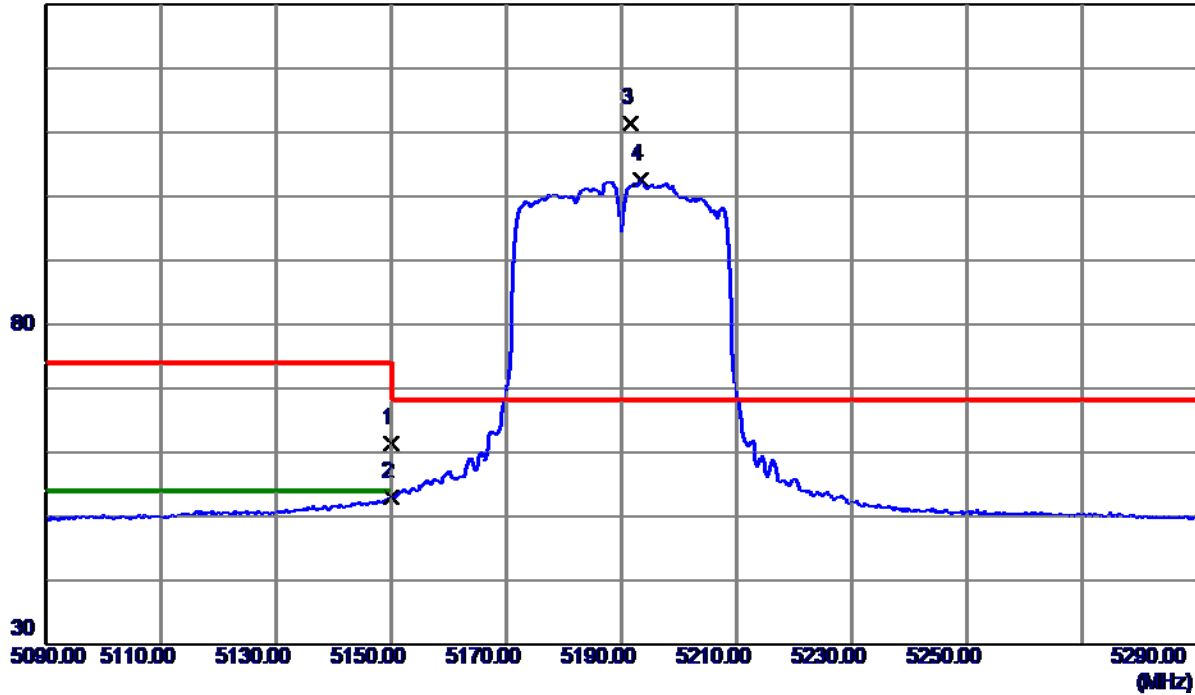

| No. | Freq. MHz | Reading Level dBuV/m | Correct Factor dB | Measure ment dBuV/m | Limit dBuV/m | Margin dB | Detector | Comment |
|-----|--------------|----------------------------|-------------------------|---------------------------|-----------------|--------------|----------|----------|
| 1 | 5150.0000 | 22.41 | 39.07 | 61.48 | 74.00 | -12.52 | Peak | |
| 2 | 5150.0000 | 13.94 | 39.07 | 53.01 | 54.00 | -0.99 | AVG | |
| 3 * | 5191.6000 | 72.32 | 39.12 | 111.44 | 68.30 | 43.14 | Peak | No Limit |
| 4 | 5193.4000 | 63.54 | 39.12 | 102.66 | 999.00 | -896.34 | AVG | No Limit |

REMARKS:

- (1) Measurement Value = Reading Level + Correct Factor.
- (2) Margin Level = Measurement Value - Limit Value.

| | |
|-----------------|------------------------------------|
| Orthogonal Axis | X |
| Test Mode | UNII-1_TX AC (VHT40) Mode 5190 MHz |

Vertical

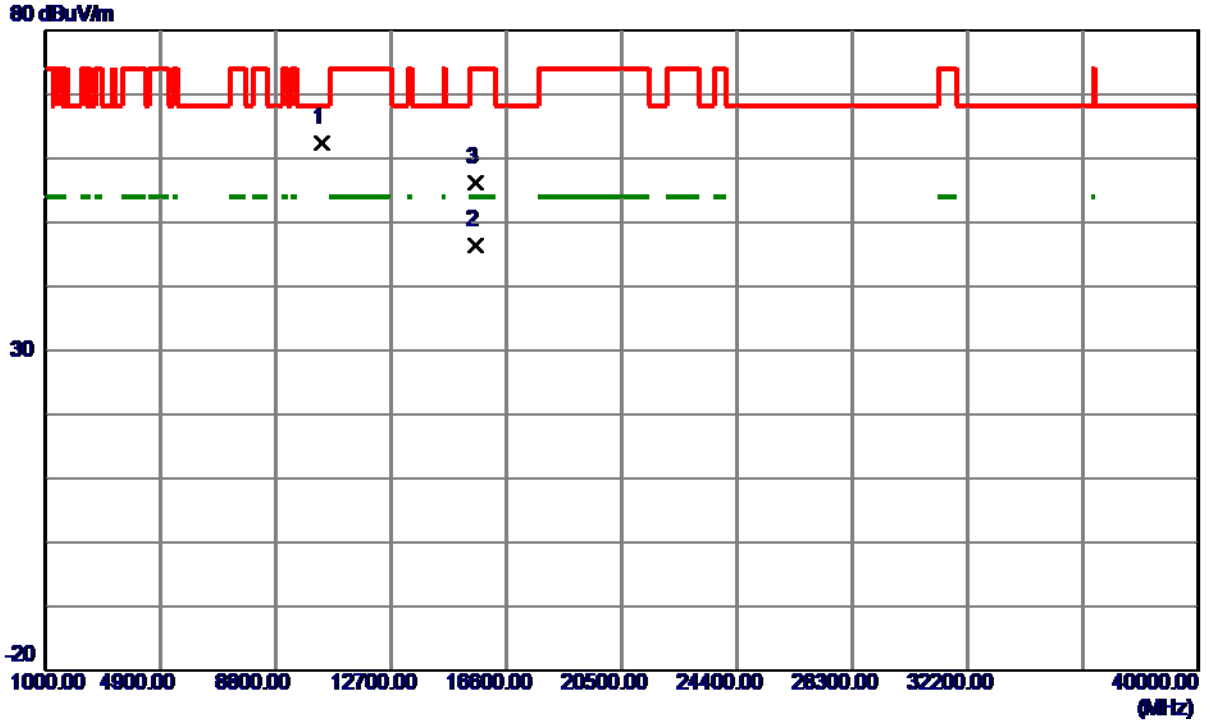

| No. | Freq. MHz | Reading Level dBuV/m | Correct Factor dB | Measure ment dBuV/m | Limit dBuV/m | Margin dB | Detector | Comment |
|-----|--------------|----------------------------|-------------------------|---------------------------|-----------------|--------------|----------|---------|
| 1 * | 10378.3949 | 64.07 | -1.63 | 62.44 | 68.30 | -5.86 | Peak | |
| 2 | 15564.1400 | 43.27 | 3.05 | 46.32 | 54.00 | -7.68 | AVG | |
| 3 | 15573.4200 | 53.18 | 3.02 | 56.20 | 74.00 | -17.80 | Peak | |

REMARKS:

- (1) Measurement Value = Reading Level + Correct Factor.
- (2) Margin Level = Measurement Value - Limit Value.

| | |
|-----------------|------------------------------------|
| Orthogonal Axis | X |
| Test Mode | UNII-1_TX AC (VHT40) Mode 5190 MHz |

Horizontal

130 dBuV/m

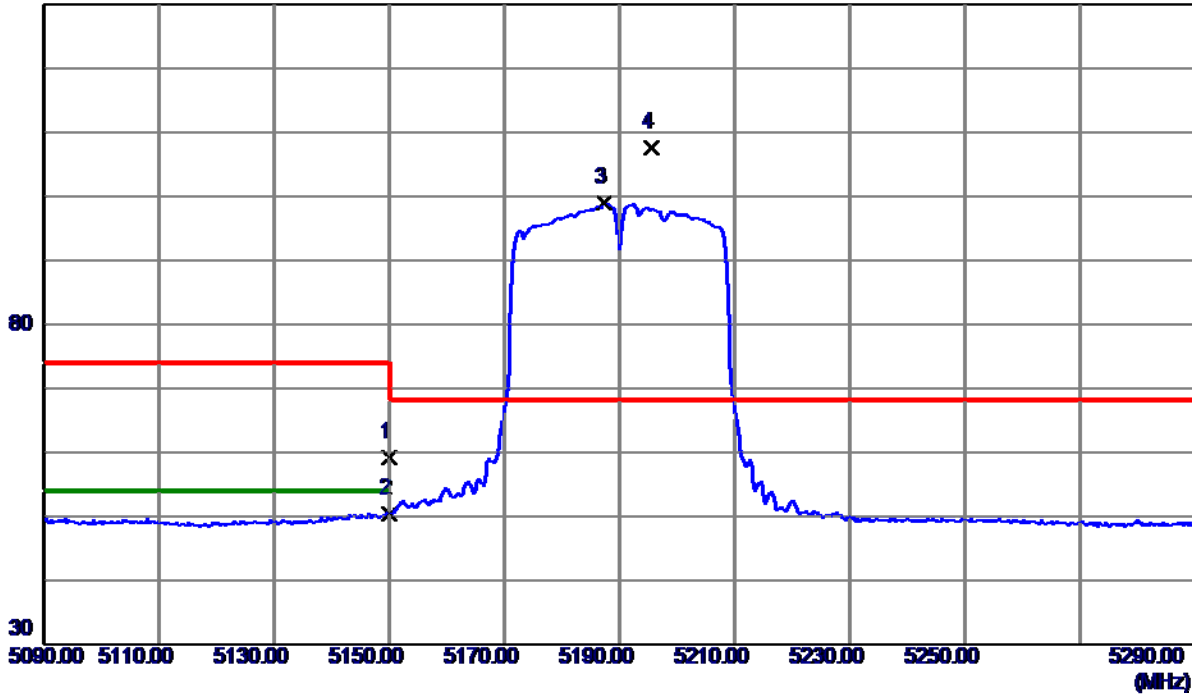

| No. | Freq. MHz | Reading Level dBuV/m | Correct Factor dB | Measure ment dBuV/m | Limit dBuV/m | Margin dB | Detector | Comment |
|-----|--------------|----------------------------|-------------------------|---------------------------|-----------------|--------------|----------|----------|
| 1 | 5150.0000 | 20.08 | 39.07 | 59.15 | 74.00 | -14.85 | Peak | |
| 2 | 5150.0000 | 11.33 | 39.07 | 50.40 | 54.00 | -3.60 | AVG | |
| 3 | 5187.4000 | 59.82 | 39.12 | 98.94 | 999.00 | -900.06 | AVG | No Limit |
| 4 * | 5195.6000 | 68.51 | 39.13 | 107.64 | 68.30 | 39.34 | Peak | No Limit |

REMARKS:

- (1) Measurement Value = Reading Level + Correct Factor.
- (2) Margin Level = Measurement Value - Limit Value.

| | |
|-----------------|------------------------------------|
| Orthogonal Axis | X |
| Test Mode | UNII-1_TX AC (VHT40) Mode 5190 MHz |

Horizontal

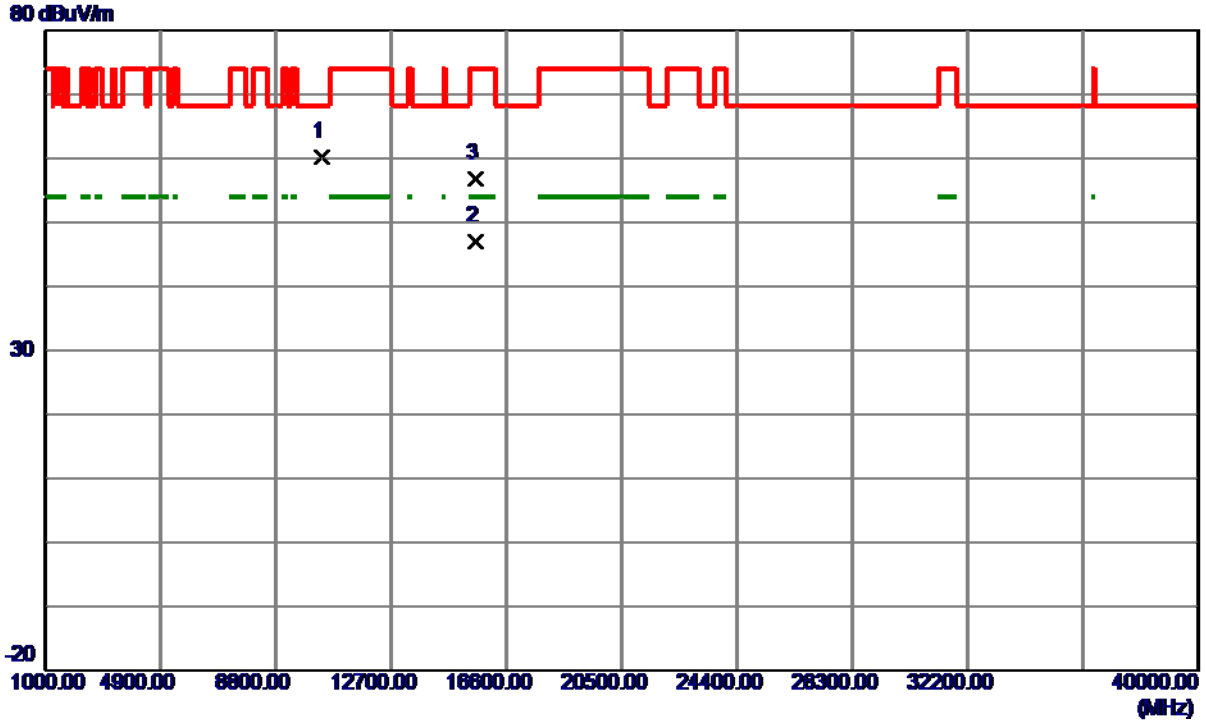

| No. | Freq. MHz | Reading Level dBuV/m | Correct Factor dB | Measure ment dBuV/m | Limit dBuV/m | Margin dB | Detector | Comment |
|-----|--------------|----------------------------|-------------------------|---------------------------|-----------------|--------------|----------|---------|
| 1 | 10381.2000 | 61.74 | -1.62 | 60.12 | 68.30 | -8.18 | Peak | |
| 2 * | 15563.5000 | 44.02 | 3.05 | 47.07 | 54.00 | -6.93 | AVG | |
| 3 | 15567.4600 | 53.71 | 3.04 | 56.75 | 74.00 | -17.25 | Peak | |

REMARKS:

- (1) Measurement Value = Reading Level + Correct Factor.
- (2) Margin Level = Measurement Value - Limit Value.

| | |
|-----------------|------------------------------------|
| Orthogonal Axis | X |
| Test Mode | UNII-1_TX AC (VHT40) Mode 5230 MHz |

Vertical

130 dBuV/m

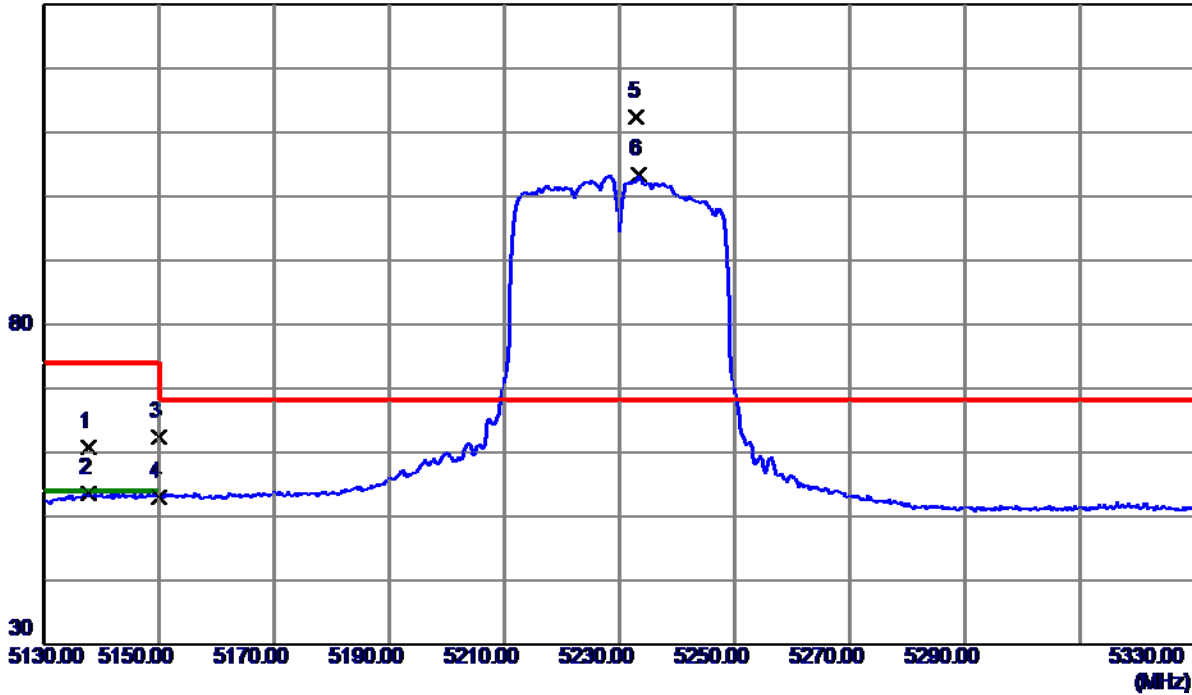

| No. | Freq. MHz | Reading Level dBuV/m | Correct Factor dB | Measure ment dBuV/m | Limit dBuV/m | Margin dB | Detector | Comment |
|-----|--------------|----------------------------|-------------------------|---------------------------|-----------------|--------------|----------|----------|
| 1 | 5137.8000 | 21.66 | 39.05 | 60.71 | 74.00 | -13.29 | Peak | |
| 2 | 5137.8000 | 14.53 | 39.05 | 53.58 | 54.00 | -0.42 | AVG | |
| 3 | 5150.0000 | 23.29 | 39.07 | 62.36 | 74.00 | -11.64 | Peak | |
| 4 | 5150.0000 | 14.02 | 39.07 | 53.09 | 54.00 | -0.91 | AVG | |
| 5 * | 5233.0000 | 73.27 | 39.17 | 112.44 | 68.30 | 44.14 | Peak | No Limit |
| 6 | 5233.4000 | 64.27 | 39.17 | 103.44 | 999.00 | -895.56 | AVG | No Limit |

REMARKS:

- (1) Measurement Value = Reading Level + Correct Factor.
- (2) Margin Level = Measurement Value - Limit Value.

| | |
|-----------------|------------------------------------|
| Orthogonal Axis | X |
| Test Mode | UNII-1_TX AC (VHT40) Mode 5230 MHz |

Vertical

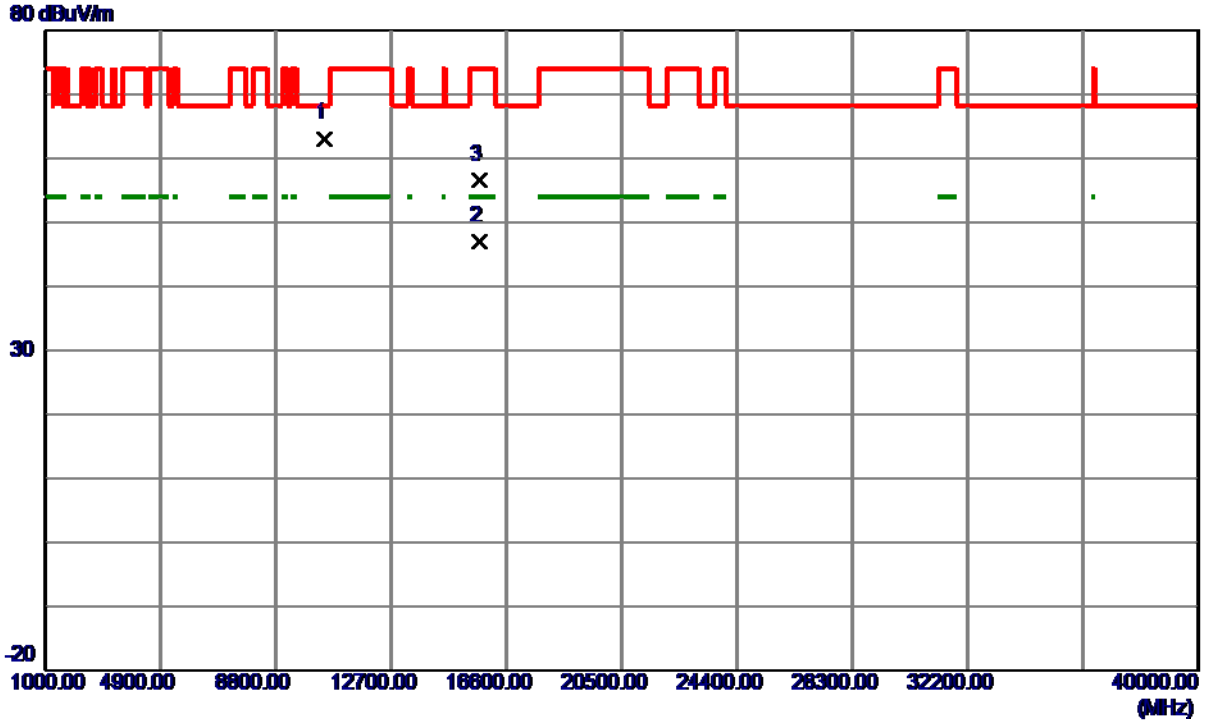

| No. | Freq. MHz | Reading Level dBuV/m | Correct Factor dB | Measure ment dBuV/m | Limit dBuV/m | Margin dB | Detector | Comment |
|-----|--------------|----------------------------|-------------------------|---------------------------|-----------------|--------------|----------|---------|
| 1 * | 10458.3000 | 64.65 | -1.55 | 63.10 | 68.30 | -5.20 | Peak | |
| 2 | 15683.6200 | 44.21 | 2.70 | 46.91 | 54.00 | -7.09 | AVG | |
| 3 | 15695.7000 | 53.89 | 2.67 | 56.56 | 74.00 | -17.44 | Peak | |

REMARKS:

- (1) Measurement Value = Reading Level + Correct Factor.
- (2) Margin Level = Measurement Value - Limit Value.

| | |
|-----------------|------------------------------------|
| Orthogonal Axis | X |
| Test Mode | UNII-1_TX AC (VHT40) Mode 5230 MHz |

Horizontal

130 dBuV/m

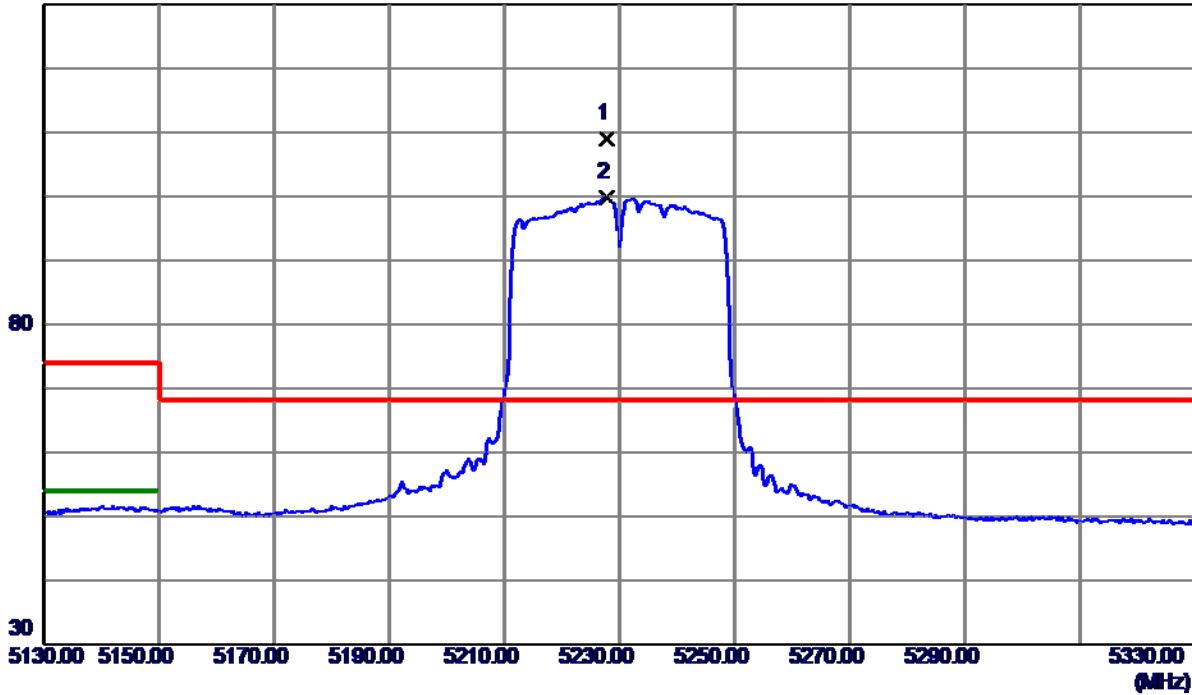

| No. | Freq. MHz | Reading Level dBuV/m | Correct Factor dB | Measure ment dBuV/m | Limit dBuV/m | Margin dB | Detector | Comment |
|-----|--------------|----------------------------|-------------------------|---------------------------|-----------------|--------------|----------|----------|
| 1 * | 5227.8000 | 69.73 | 39.17 | 108.90 | 68.30 | 40.60 | Peak | No Limit |
| 2 | 5227.8000 | 60.60 | 39.17 | 99.77 | 999.00 | -899.23 | AVG | No Limit |

REMARKS:

- (1) Measurement Value = Reading Level + Correct Factor.
- (2) Margin Level = Measurement Value - Limit Value.

| | |
|-----------------|------------------------------------|
| Orthogonal Axis | X |
| Test Mode | UNII-1_TX AC (VHT40) Mode 5230 MHz |

Horizontal

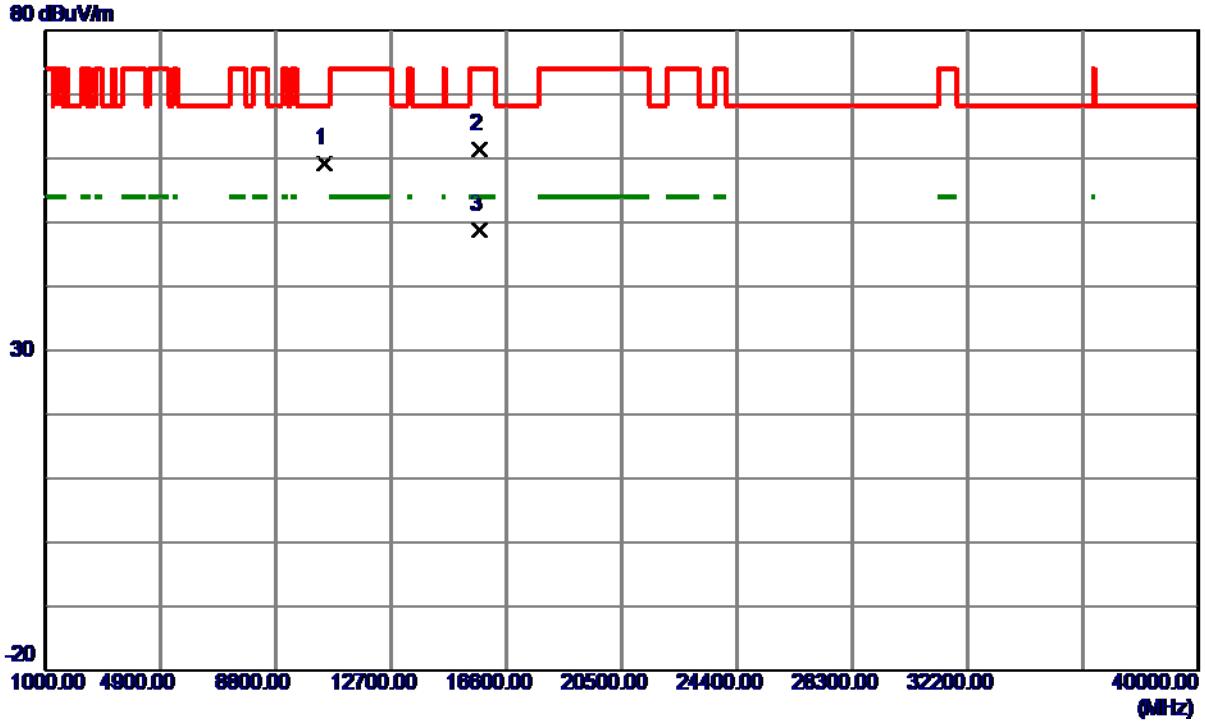

| No. | Freq. MHz | Reading Level dBuV/m | Correct Factor dB | Measure ment dBuV/m | Limit dBuV/m | Margin dB | Detector | Comment |
|-----|--------------|----------------------------|-------------------------|---------------------------|-----------------|--------------|----------|---------|
| 1 | 10461.1000 | 60.83 | -1.55 | 59.28 | 68.30 | -9.02 | Peak | |
| 2 | 15684.2000 | 58.67 | 2.70 | 61.37 | 74.00 | -12.63 | Peak | |
| 3 * | 15686.4000 | 46.04 | 2.70 | 48.74 | 54.00 | -5.26 | AVG | |

REMARKS:

- (1) Measurement Value = Reading Level + Correct Factor.
- (2) Margin Level = Measurement Value - Limit Value.

| | |
|-----------------|------------------------------------|
| Orthogonal Axis | X |
| Test Mode | UNII-1_TX AC (VHT80) Mode 5210 MHz |

Vertical

130 dBuV/m

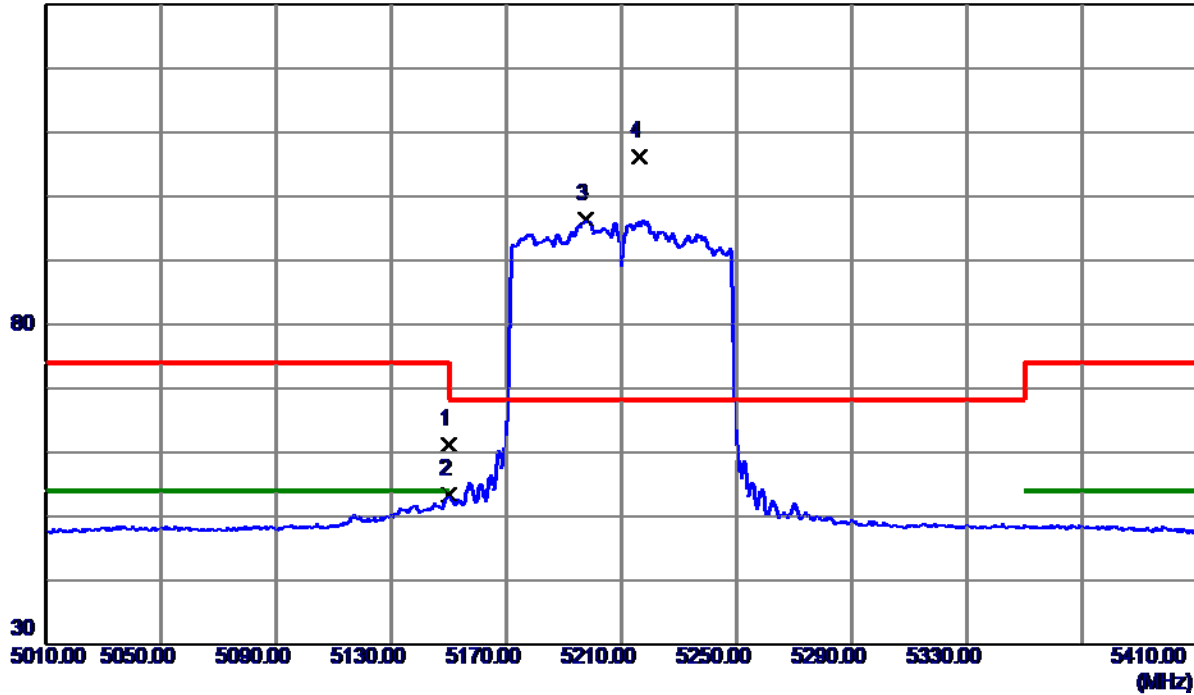

| No. | Freq. MHz | Reading Level dBuV/m | Correct Factor dB | Measure ment dBuV/m | Limit dBuV/m | Margin dB | Detector | Comment |
|-----|--------------|----------------------------|-------------------------|---------------------------|-----------------|--------------|----------|----------|
| 1 | 5150.0000 | 22.05 | 39.07 | 61.12 | 74.00 | -12.88 | Peak | |
| 2 | 5150.0000 | 14.35 | 39.07 | 53.42 | 54.00 | -0.58 | AVG | |
| 3 | 5197.6000 | 57.36 | 39.13 | 96.49 | 999.00 | -902.51 | AVG | No Limit |
| 4 * | 5216.4000 | 67.12 | 39.15 | 106.27 | 68.30 | 37.97 | Peak | No Limit |

REMARKS:

- (1) Measurement Value = Reading Level + Correct Factor.
- (2) Margin Level = Measurement Value - Limit Value.

| | |
|-----------------|------------------------------------|
| Orthogonal Axis | X |
| Test Mode | UNII-1_TX AC (VHT80) Mode 5210 MHz |

Vertical

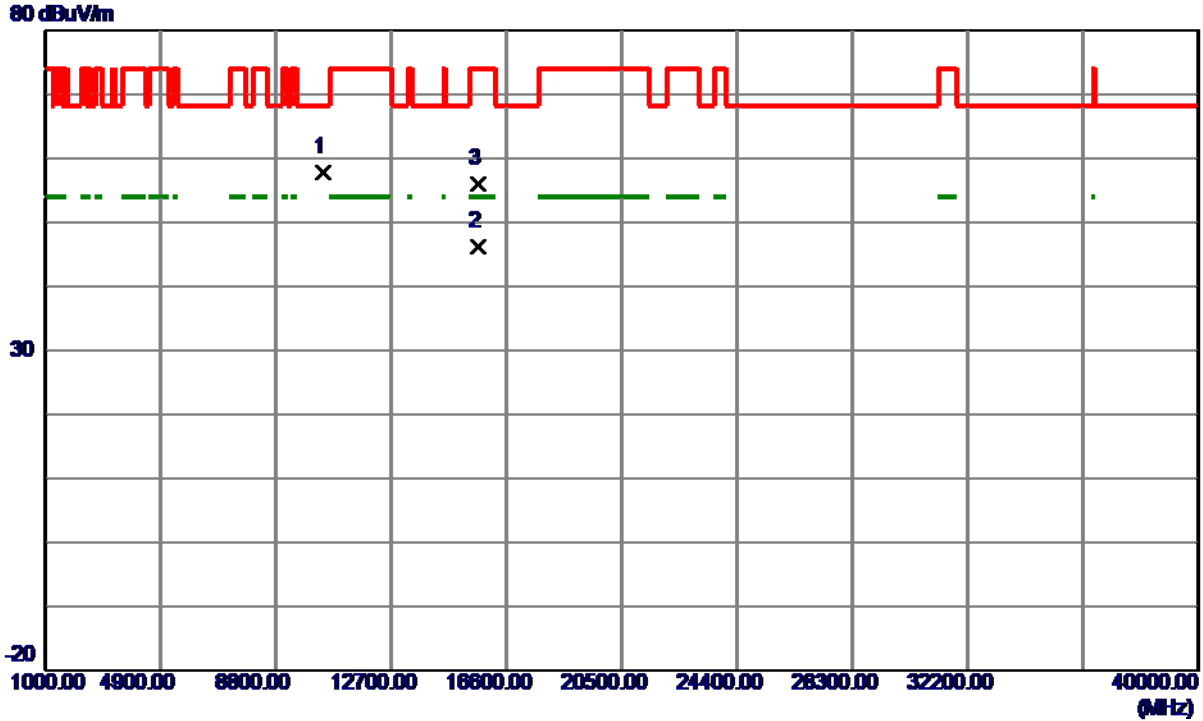

| No. | Freq. MHz | Reading Level dBuV/m | Correct Factor dB | Measure ment dBuV/m | Limit dBuV/m | Margin dB | Detector | Comment |
|-----|--------------|----------------------------|-------------------------|---------------------------|-----------------|--------------|----------|---------|
| 1 | 10420.6950 | 59.33 | -1.59 | 57.74 | 68.30 | -10.56 | Peak | |
| 2 * | 15625.8000 | 43.41 | 2.87 | 46.28 | 54.00 | -7.72 | AVG | |
| 3 | 15627.8600 | 53.20 | 2.86 | 56.06 | 74.00 | -17.94 | Peak | |

REMARKS:

- (1) Measurement Value = Reading Level + Correct Factor.
- (2) Margin Level = Measurement Value - Limit Value.

| | |
|-----------------|------------------------------------|
| Orthogonal Axis | X |
| Test Mode | UNII-1_TX AC (VHT80) Mode 5210 MHz |

Horizontal

130 dBuV/m

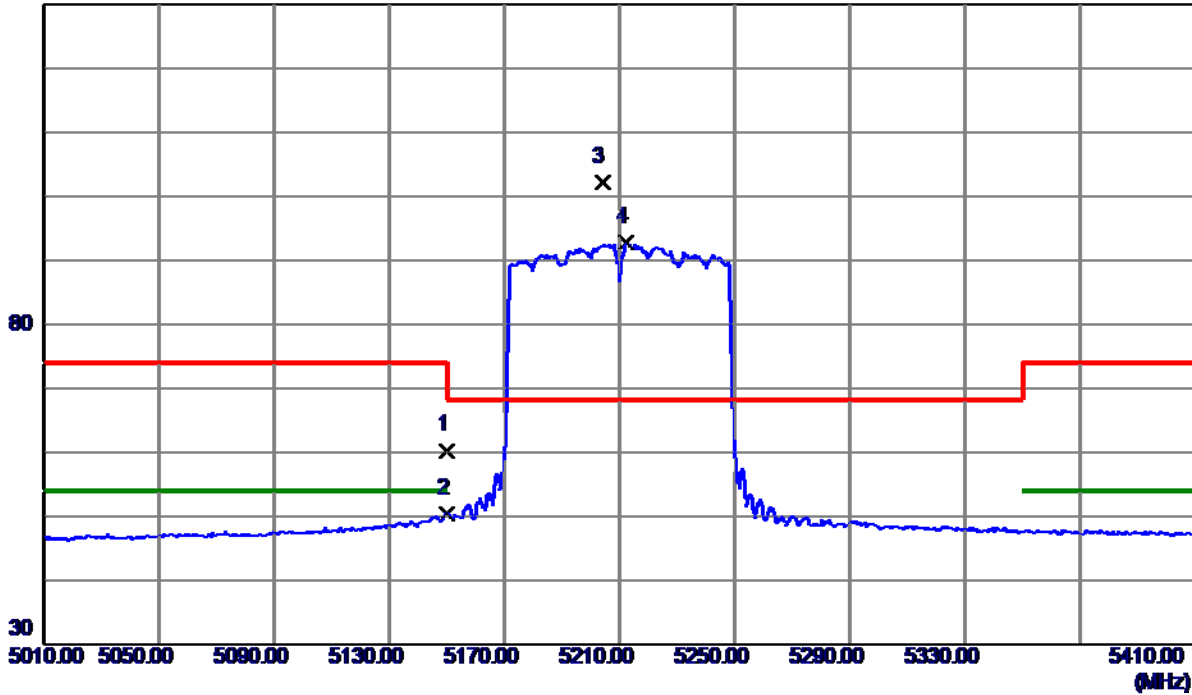

| No. | Freq. MHz | Reading Level dBuV/m | Correct Factor dB | Measure ment dBuV/m | Limit dBuV/m | Margin dB | Detector | Comment |
|-----|--------------|----------------------------|-------------------------|---------------------------|-----------------|--------------|----------|----------|
| 1 | 5150.0000 | 21.23 | 39.07 | 60.30 | 74.00 | -13.70 | Peak | |
| 2 | 5150.0000 | 11.42 | 39.07 | 50.49 | 54.00 | -3.51 | AVG | |
| 3 * | 5204.0000 | 63.02 | 39.14 | 102.16 | 68.30 | 33.86 | Peak | No Limit |
| 4 | 5212.4000 | 53.57 | 39.15 | 92.72 | 999.00 | -906.28 | AVG | No Limit |

REMARKS:

- (1) Measurement Value = Reading Level + Correct Factor.
- (2) Margin Level = Measurement Value - Limit Value.

| | |
|-----------------|------------------------------------|
| Orthogonal Axis | X |
| Test Mode | UNII-1_TX AC (VHT80) Mode 5210 MHz |

Horizontal

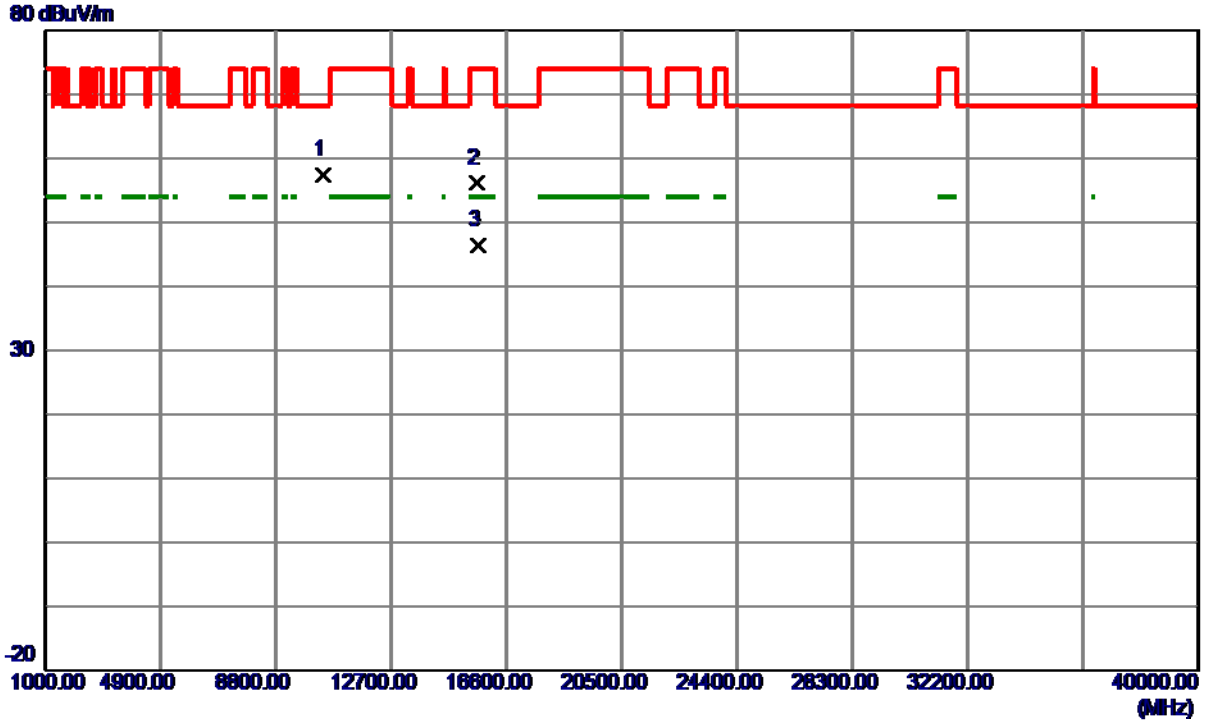

| No. | Freq. MHz | Reading Level dBuV/m | Correct Factor dB | Measure ment dBuV/m | Limit dBuV/m | Margin dB | Detector | Comment |
|-----|--------------|----------------------------|-------------------------|---------------------------|-----------------|--------------|----------|---------|
| 1 | 10417.9050 | 58.91 | -1.59 | 57.32 | 68.30 | -10.98 | Peak | |
| 2 | 15621.9600 | 53.22 | 2.88 | 56.10 | 74.00 | -17.90 | Peak | |
| 3 * | 15636.7200 | 43.64 | 2.84 | 46.48 | 54.00 | -7.52 | AVG | |

REMARKS:

- (1) Measurement Value = Reading Level + Correct Factor.
- (2) Margin Level = Measurement Value - Limit Value.

| | |
|-----------------|-------------------------------------|
| Orthogonal Axis | X |
| Test Mode | UNII-2A_TX AC (VHT20) Mode 5260 MHz |

Vertical

130 dBuV/m

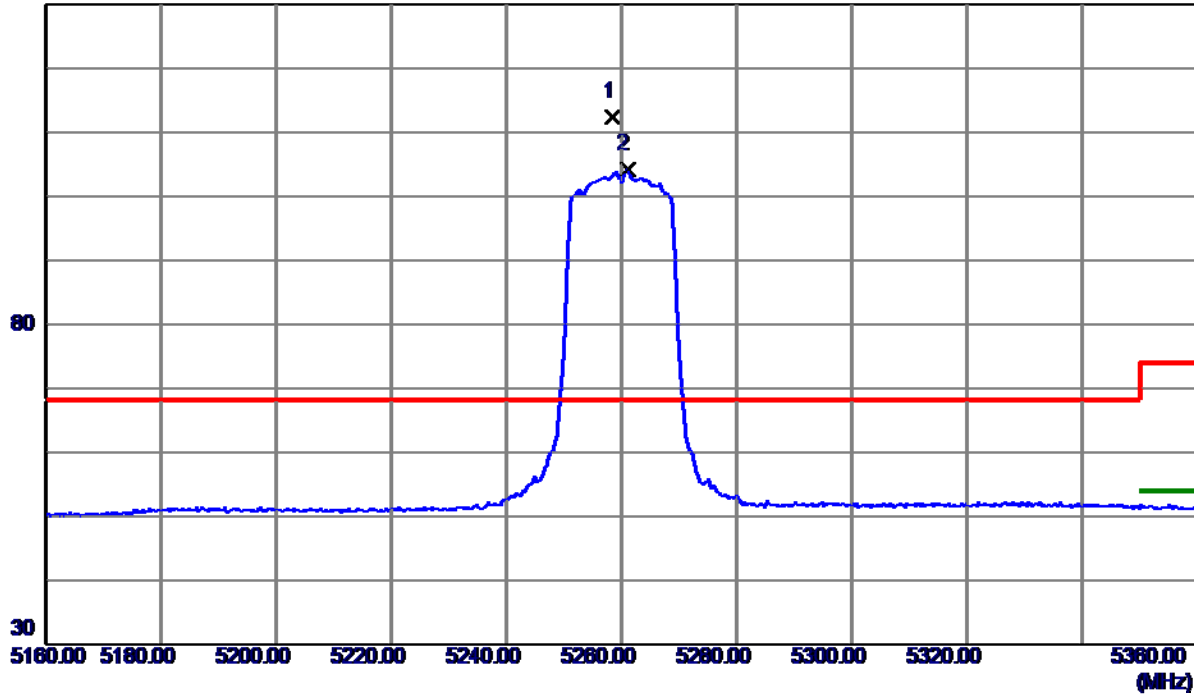

| No. | Freq. MHz | Reading Level dBuV/m | Correct Factor dB | Measure ment dBuV/m | Limit dBuV/m | Margin dB | Detector | Comment |
|-----|--------------|----------------------------|-------------------------|---------------------------|-----------------|--------------|----------|----------|
| 1 * | 5258.4000 | 73.28 | 39.21 | 112.49 | 68.30 | 44.19 | Peak | No Limit |
| 2 | 5261.0000 | 64.94 | 39.21 | 104.15 | 999.00 | -894.85 | AVG | No Limit |

REMARKS:

- (1) Measurement Value = Reading Level + Correct Factor.
- (2) Margin Level = Measurement Value - Limit Value.

| | |
|-----------------|-------------------------------------|
| Orthogonal Axis | X |
| Test Mode | UNII-2A_TX AC (VHT20) Mode 5260 MHz |

Vertical

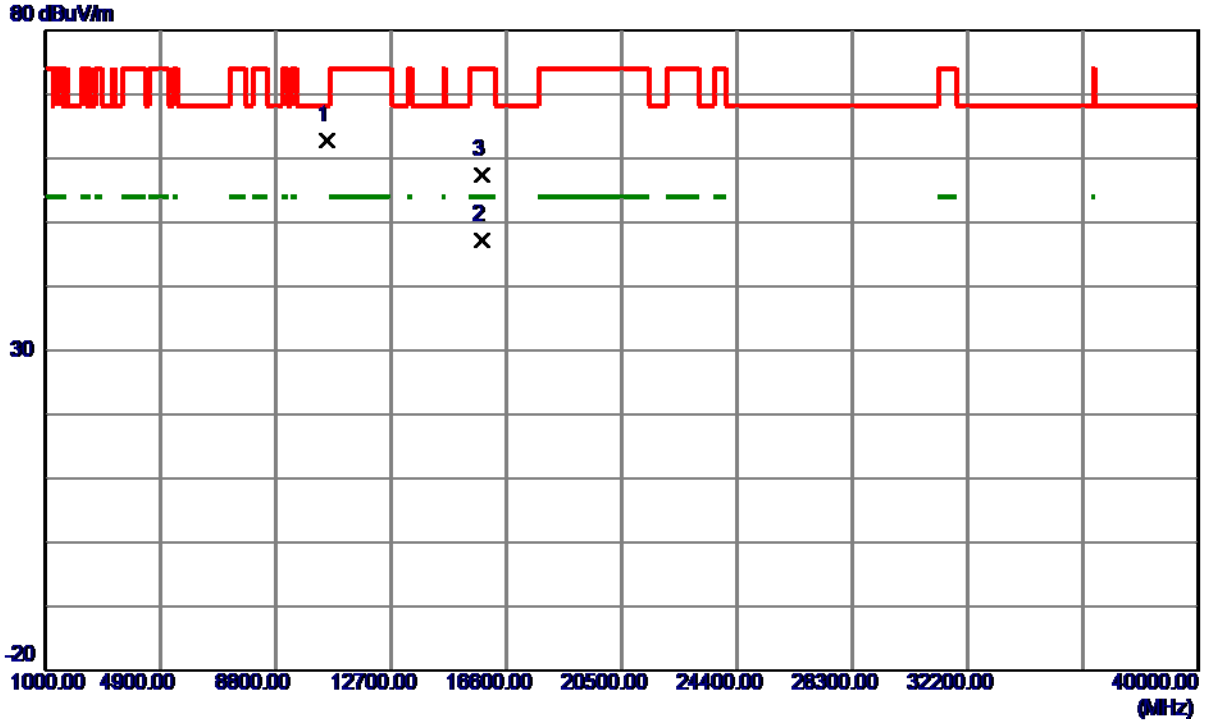

| No. | Freq. MHz | Reading Level dBuV/m | Correct Factor dB | Measure ment dBuV/m | Limit dBuV/m | Margin dB | Detector | Comment |
|-----|--------------|----------------------------|-------------------------|---------------------------|-----------------|--------------|----------|---------|
| 1 * | 10519.6150 | 64.19 | -1.44 | 62.75 | 68.30 | -5.55 | Peak | |
| 2 | 15777.5800 | 44.76 | 2.44 | 47.20 | 54.00 | -6.80 | AVG | |
| 3 | 15789.4000 | 54.95 | 2.40 | 57.35 | 74.00 | -16.65 | Peak | |

REMARKS:

- (1) Measurement Value = Reading Level + Correct Factor.
- (2) Margin Level = Measurement Value - Limit Value.

| | |
|-----------------|-------------------------------------|
| Orthogonal Axis | X |
| Test Mode | UNII-2A_TX AC (VHT20) Mode 5260 MHz |

Horizontal

130 dBuV/m

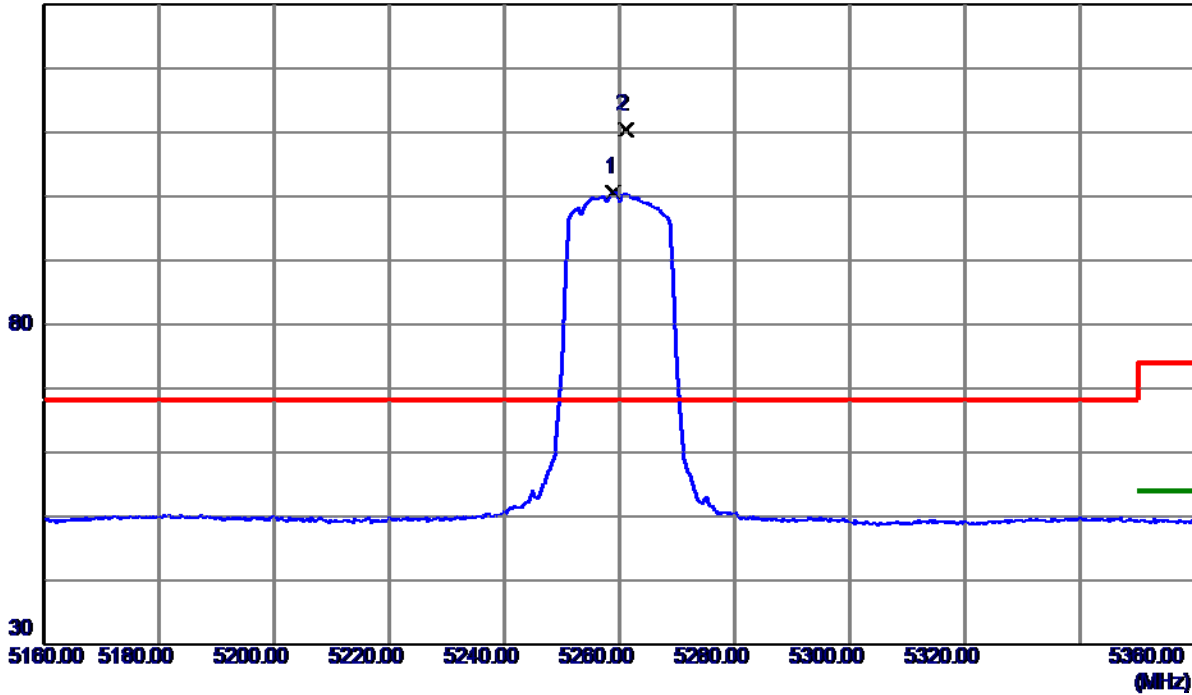

| No. | Freq. MHz | Reading Level dBuV/m | Correct Factor dB | Measure ment dBuV/m | Limit dBuV/m | Margin dB | Detector | Comment |
|-----|--------------|----------------------------|-------------------------|---------------------------|-----------------|--------------|----------|----------|
| 1 | 5259.0000 | 61.44 | 39.21 | 100.65 | 999.00 | -898.35 | AVG | No Limit |
| 2 * | 5261.2000 | 71.13 | 39.21 | 110.34 | 68.30 | 42.04 | Peak | No Limit |

REMARKS:

- (1) Measurement Value = Reading Level + Correct Factor.
- (2) Margin Level = Measurement Value - Limit Value.

| | |
|-----------------|-------------------------------------|
| Orthogonal Axis | X |
| Test Mode | UNII-2A_TX AC (VHT20) Mode 5260 MHz |

Horizontal

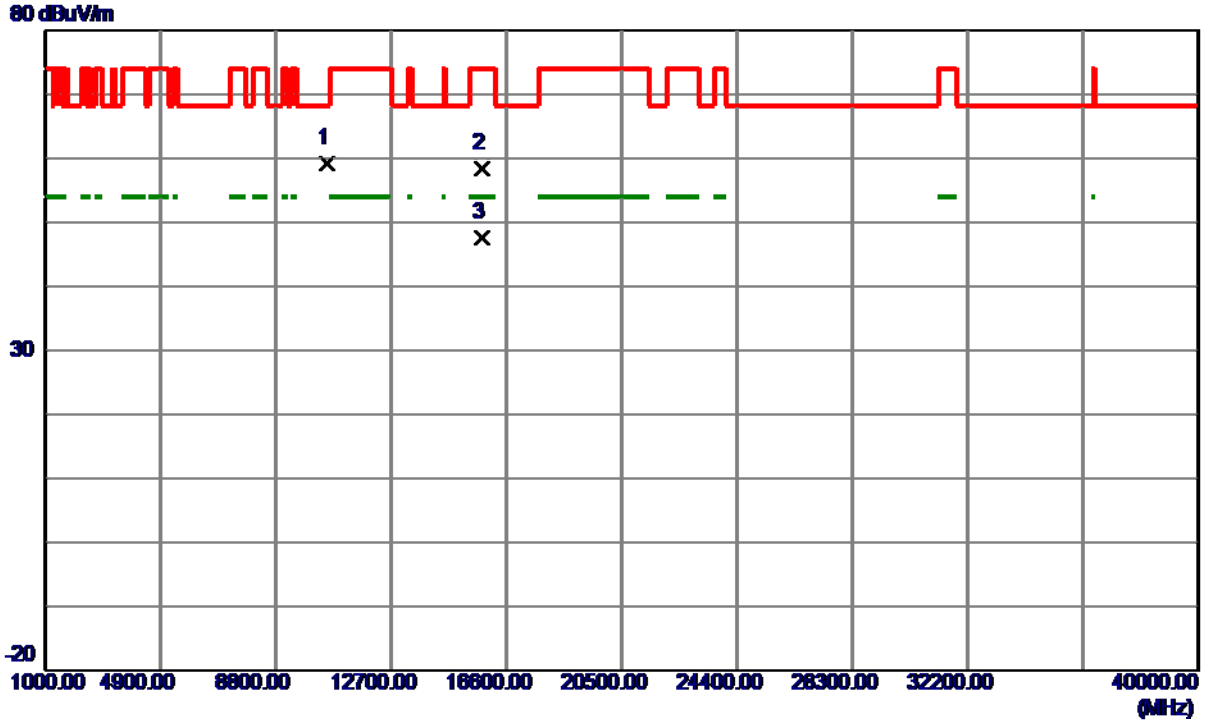

| No. | Freq. MHz | Reading Level dBuV/m | Correct Factor dB | Measure ment dBuV/m | Limit dBuV/m | Margin dB | Detector | Comment |
|-----|--------------|----------------------------|-------------------------|---------------------------|-----------------|--------------|----------|---------|
| 1 | 10519.5650 | 60.70 | -1.44 | 59.26 | 68.30 | -9.04 | Peak | |
| 2 | 15775.4200 | 55.95 | 2.44 | 58.39 | 74.00 | -15.61 | Peak | |
| 3 * | 15778.2200 | 45.16 | 2.43 | 47.59 | 54.00 | -6.41 | AVG | |

REMARKS:

- (1) Measurement Value = Reading Level + Correct Factor.
- (2) Margin Level = Measurement Value - Limit Value.

| | |
|-----------------|-------------------------------------|
| Orthogonal Axis | X |
| Test Mode | UNII-2A_TX AC (VHT20) Mode 5300 MHz |

Vertical

130 dBuV/m

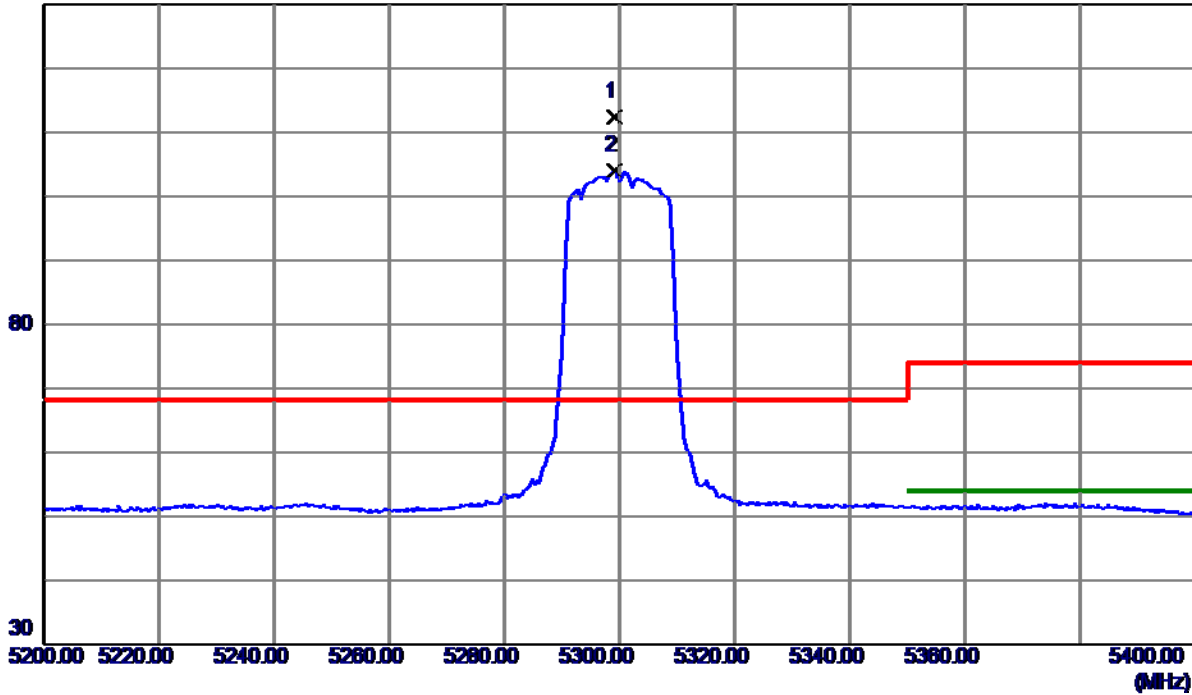

| No. | Freq. MHz | Reading Level dBuV/m | Correct Factor dB | Measure ment dBuV/m | Limit dBuV/m | Margin dB | Detector | Comment |
|-----|--------------|----------------------------|-------------------------|---------------------------|-----------------|--------------|----------|----------|
| 1 * | 5299.2000 | 73.13 | 39.26 | 112.39 | 68.30 | 44.09 | Peak | No Limit |
| 2 | 5299.2000 | 64.70 | 39.26 | 103.96 | 999.00 | -895.04 | AVG | No Limit |

REMARKS:

- (1) Measurement Value = Reading Level + Correct Factor.
- (2) Margin Level = Measurement Value - Limit Value.

| | |
|-----------------|-------------------------------------|
| Orthogonal Axis | X |
| Test Mode | UNII-2A_TX AC (VHT20) Mode 5300 MHz |

Vertical

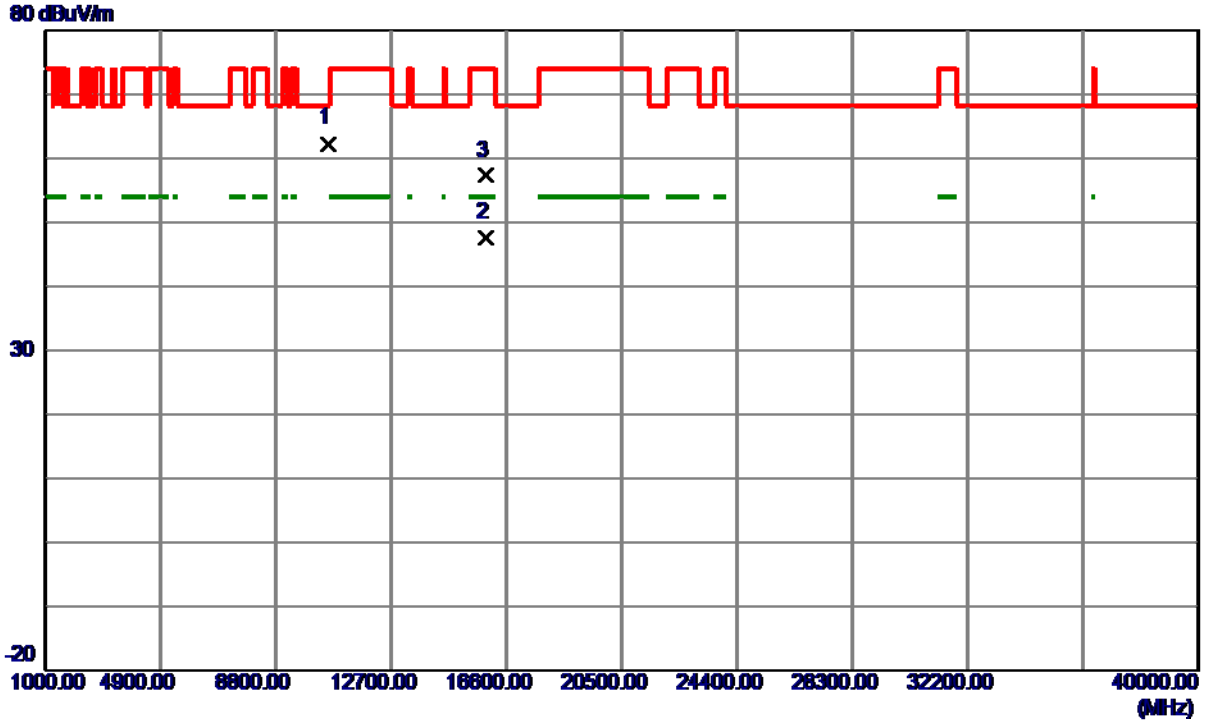

| No. | Freq. MHz | Reading Level dBuV/m | Correct Factor dB | Measurement dBuV/m | Limit dBuV/m | Margin dB | Detector | Comment |
|-----|------------|----------------------|-------------------|--------------------|--------------|-----------|----------|---------|
| 1 * | 10598.3150 | 63.46 | -1.16 | 62.30 | 68.30 | -6.00 | Peak | |
| 2 | 15897.2800 | 45.46 | 2.09 | 47.55 | 54.00 | -6.45 | AVG | |
| 3 | 15907.3000 | 55.23 | 2.07 | 57.30 | 74.00 | -16.70 | Peak | |

REMARKS:

- (1) Measurement Value = Reading Level + Correct Factor.
- (2) Margin Level = Measurement Value - Limit Value.

| | |
|-----------------|-------------------------------------|
| Orthogonal Axis | X |
| Test Mode | UNII-2A_TX AC (VHT20) Mode 5300 MHz |

Horizontal

130 dBuV/m

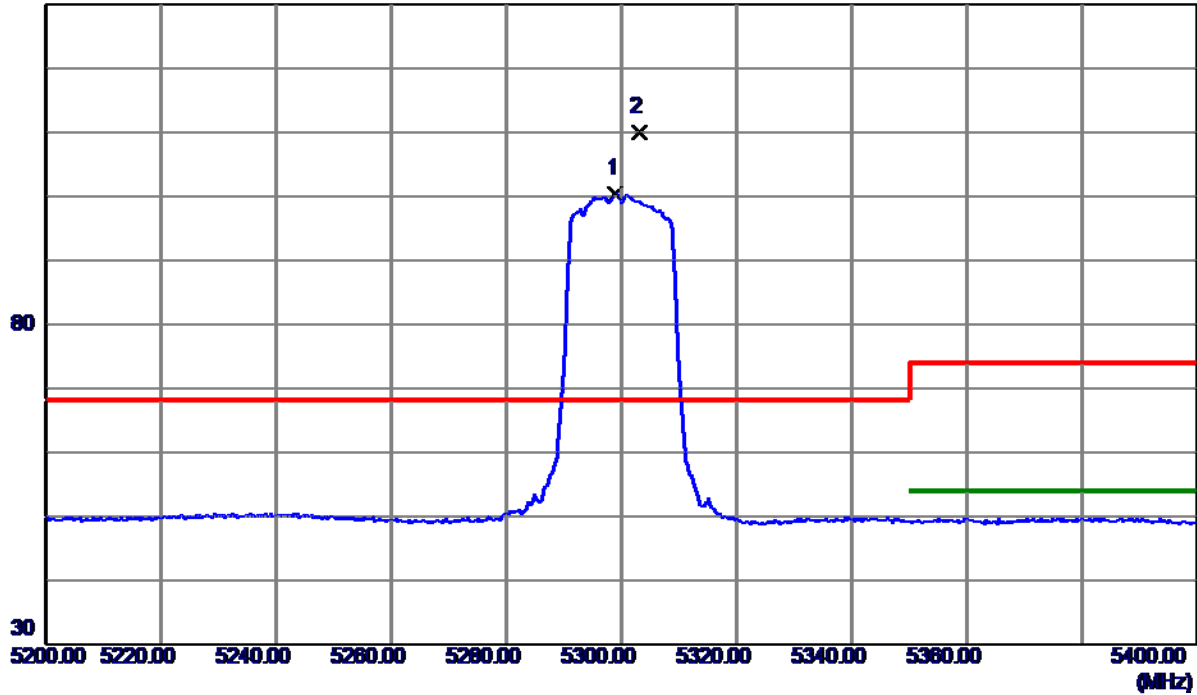

| No. | Freq. MHz | Reading Level dBuV/m | Correct Factor dB | Measure ment dBuV/m | Limit dBuV/m | Margin dB | Detector | Comment |
|-----|--------------|----------------------------|-------------------------|---------------------------|-----------------|--------------|----------|----------|
| 1 | 5299.0000 | 61.15 | 39.26 | 100.41 | 999.00 | -898.59 | AVG | No Limit |
| 2 * | 5303.2000 | 70.79 | 39.26 | 110.05 | 68.30 | 41.75 | Peak | No Limit |

REMARKS:

- (1) Measurement Value = Reading Level + Correct Factor.
- (2) Margin Level = Measurement Value - Limit Value.

| | |
|-----------------|-------------------------------------|
| Orthogonal Axis | X |
| Test Mode | UNII-2A_TX AC (VHT20) Mode 5300 MHz |

Horizontal

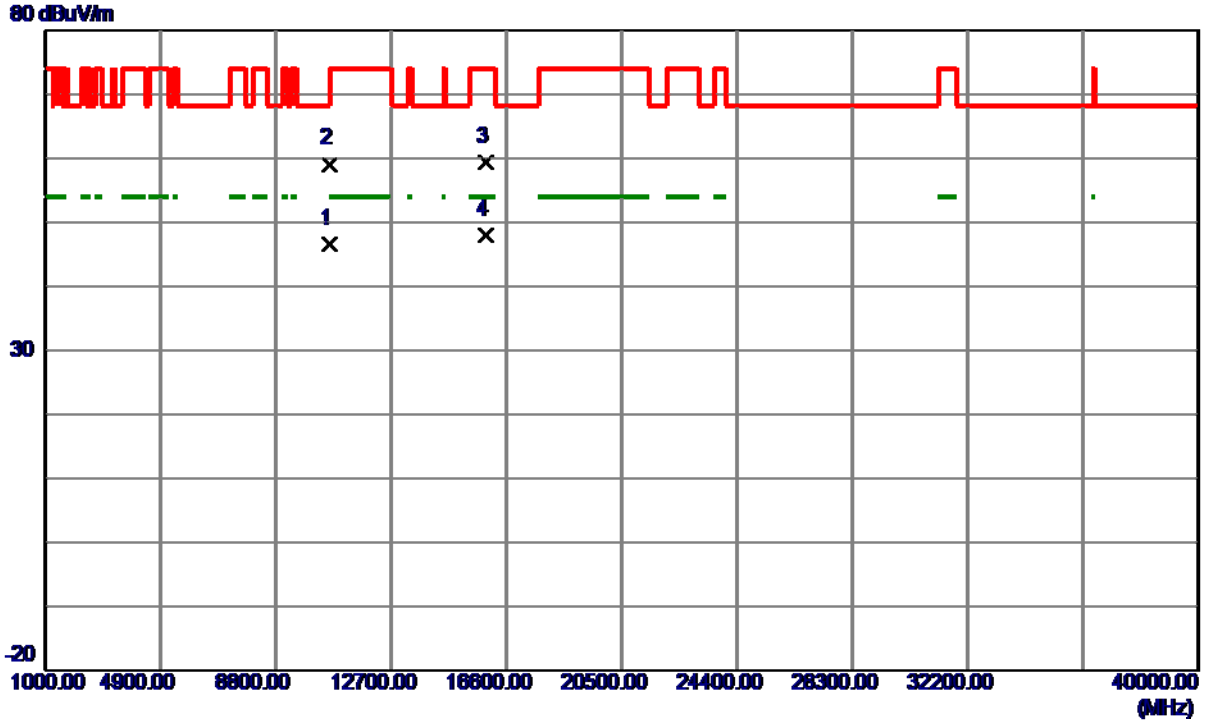

| No. | Freq. MHz | Reading Level dBuV/m | Correct Factor dB | Measure ment dBuV/m | Limit dBuV/m | Margin dB | Detector | Comment |
|-----|--------------|----------------------------|-------------------------|---------------------------|-----------------|--------------|----------|---------|
| 1 | 10600.5350 | 47.73 | -1.15 | 46.58 | 54.00 | -7.42 | AVG | |
| 2 | 10602.0350 | 60.24 | -1.14 | 59.10 | 74.00 | -14.90 | Peak | |
| 3 | 15894.1000 | 57.27 | 2.10 | 59.37 | 74.00 | -14.63 | Peak | |
| 4 * | 15899.7600 | 45.94 | 2.09 | 48.03 | 54.00 | -5.97 | AVG | |

REMARKS:

- (1) Measurement Value = Reading Level + Correct Factor.
- (2) Margin Level = Measurement Value - Limit Value.

| | |
|-----------------|-------------------------------------|
| Orthogonal Axis | X |
| Test Mode | UNII-2A_TX AC (VHT20) Mode 5320 MHz |

Vertical

130 dBuV/m

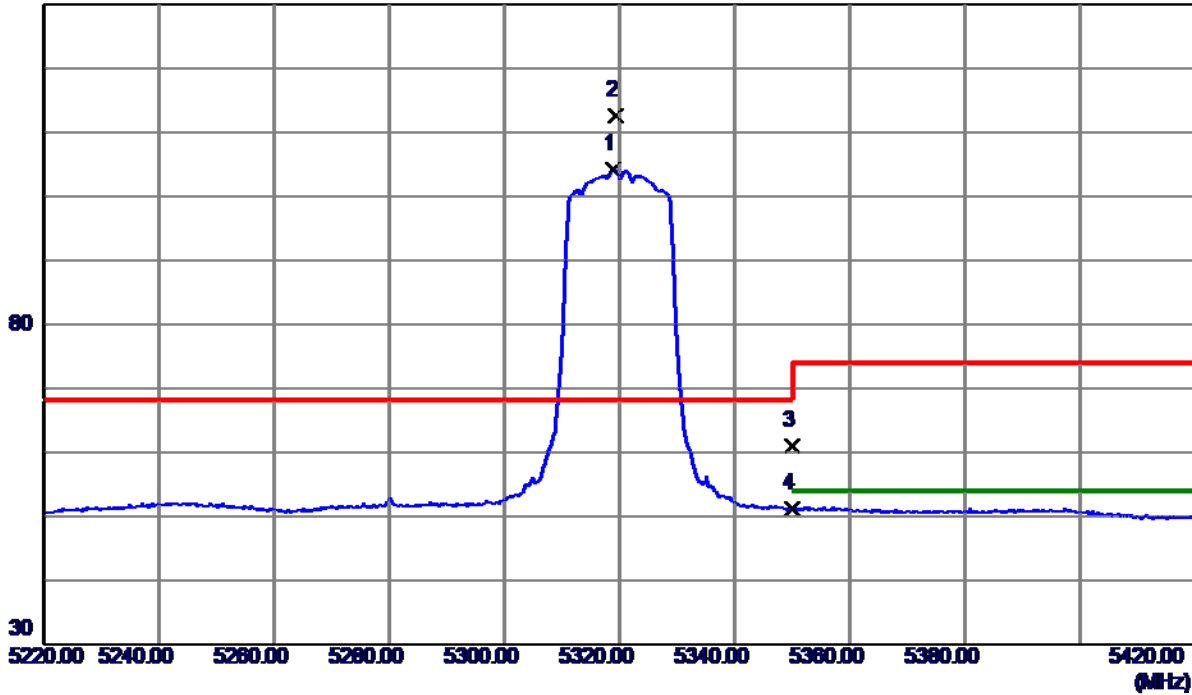

| No. | Freq. MHz | Reading Level dBuV/m | Correct Factor dB | Measure ment dBuV/m | Limit dBuV/m | Margin dB | Detector | Comment |
|-----|--------------|----------------------------|-------------------------|---------------------------|-----------------|--------------|----------|----------|
| 1 | 5318.8000 | 64.84 | 39.28 | 104.12 | 999.00 | -894.88 | AVG | No Limit |
| 2 * | 5319.4000 | 73.32 | 39.28 | 112.60 | 68.30 | 44.30 | Peak | No Limit |
| 3 | 5350.0000 | 21.73 | 39.32 | 61.05 | 74.00 | -12.95 | Peak | |
| 4 | 5350.0000 | 11.79 | 39.32 | 51.11 | 54.00 | -2.89 | AVG | |

REMARKS:

- (1) Measurement Value = Reading Level + Correct Factor.
- (2) Margin Level = Measurement Value - Limit Value.

| | |
|-----------------|-------------------------------------|
| Orthogonal Axis | X |
| Test Mode | UNII-2A_TX AC (VHT20) Mode 5320 MHz |

Vertical

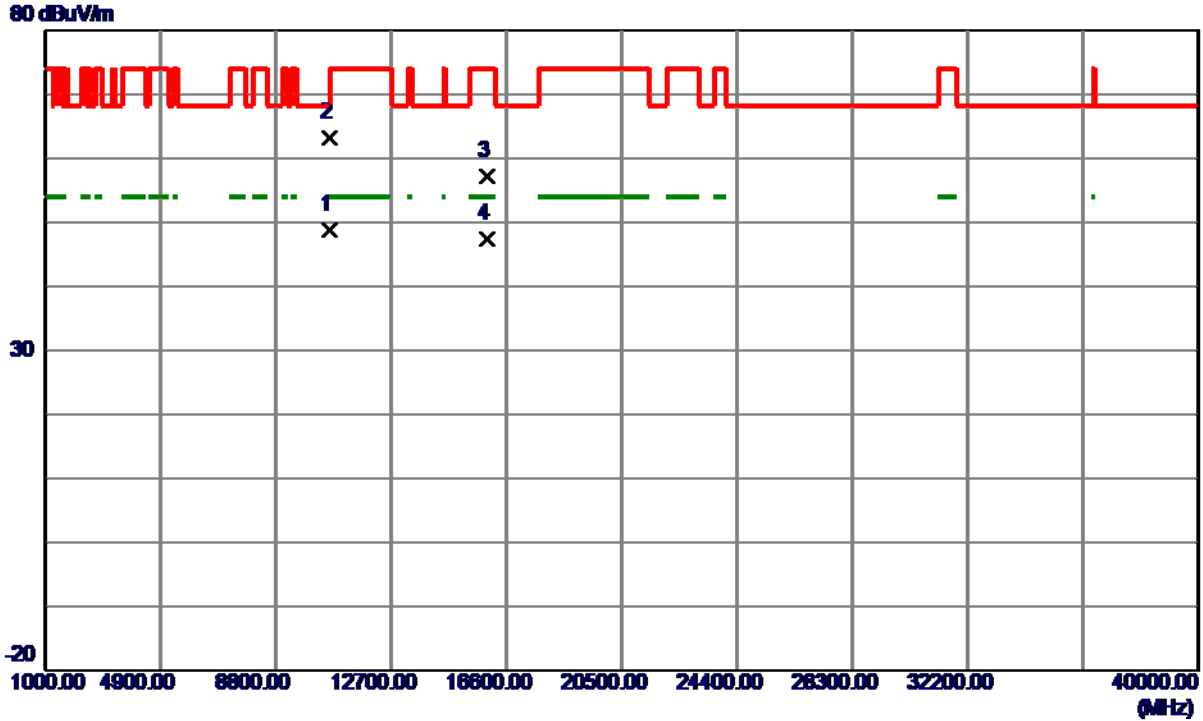

| No. | Freq. MHz | Reading Level dBuV/m | Correct Factor dB | Measure ment dBuV/m | Limit dBuV/m | Margin dB | Detector | Comment |
|-----|--------------|----------------------------|-------------------------|---------------------------|-----------------|--------------|----------|---------|
| 1 * | 10638.5650 | 49.78 | -1.01 | 48.77 | 54.00 | -5.23 | AVG | |
| 2 | 10639.4100 | 64.21 | -1.01 | 63.20 | 74.00 | -10.80 | Peak | |
| 3 | 15955.3800 | 55.34 | 1.93 | 57.27 | 74.00 | -16.73 | Peak | |
| 4 | 15956.5200 | 45.40 | 1.92 | 47.32 | 54.00 | -6.68 | AVG | |

REMARKS:

- (1) Measurement Value = Reading Level + Correct Factor.
- (2) Margin Level = Measurement Value - Limit Value.

| | |
|-----------------|-------------------------------------|
| Orthogonal Axis | X |
| Test Mode | UNII-2A_TX AC (VHT20) Mode 5320 MHz |

Horizontal

130 dBuV/m

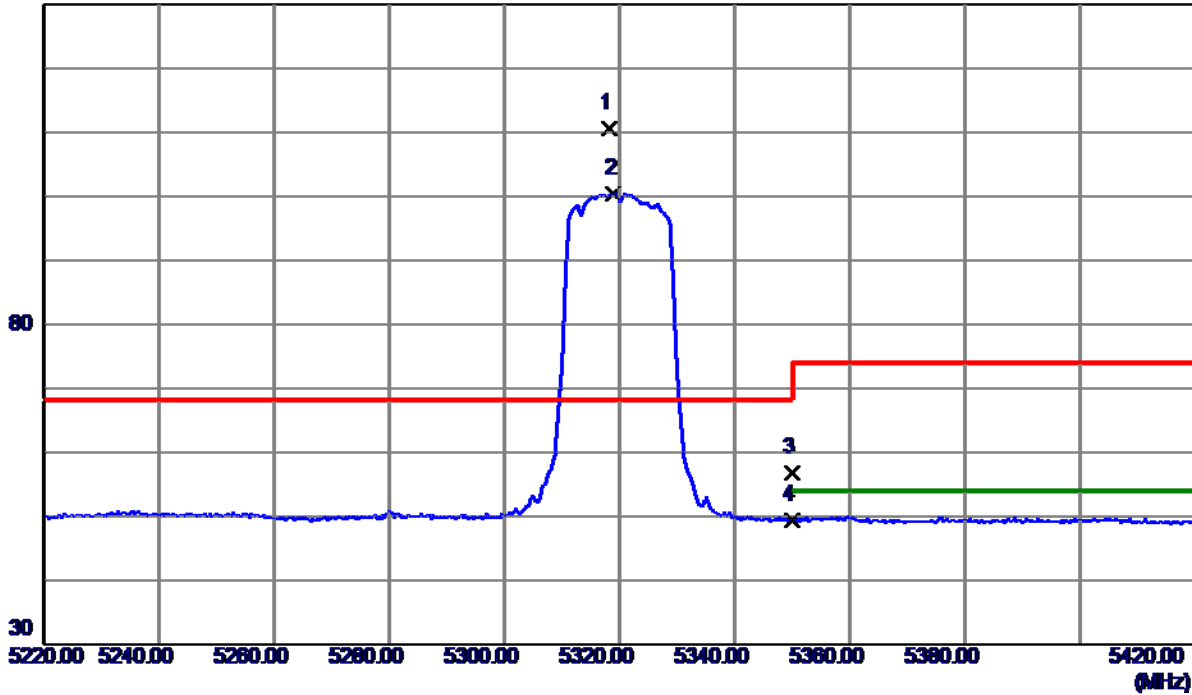

| No. | Freq. MHz | Reading Level dBuV/m | Correct Factor dB | Measure ment dBuV/m | Limit dBuV/m | Margin dB | Detector | Comment |
|-----|--------------|----------------------------|-------------------------|---------------------------|-----------------|--------------|----------|----------|
| 1 * | 5318.2000 | 71.34 | 39.28 | 110.62 | 68.30 | 42.32 | Peak | No Limit |
| 2 | 5319.0000 | 61.14 | 39.28 | 100.42 | 999.00 | -898.58 | AVG | No Limit |
| 3 | 5350.0000 | 17.47 | 39.32 | 56.79 | 74.00 | -17.21 | Peak | |
| 4 | 5350.0000 | 10.10 | 39.32 | 49.42 | 54.00 | -4.58 | AVG | |

REMARKS:

- (1) Measurement Value = Reading Level + Correct Factor.
- (2) Margin Level = Measurement Value - Limit Value.