

# FCC DFS Test Report

## FCC ID: Q78-ZXHNF680V5

This report concerns: Original Grant

**Project No.** : 1906H014  
**Equipment** : GPON ONT  
**Test Model** : ZXHN F680  
**Series Model** : N/A  
**Applicant** : ZTE Corporation  
**Address** : ZTE Plaza, Hi-Tech Park, Nanshan District,  
Shenzhen, Guangdong, P.R.China

**Date of Receipt** : Jun. 27, 2019  
**Date of Test** : Jun. 27, 2019~Jul. 29, 2019  
**Issued Date** : Sep. 03, 2019  
**Tested by** : BTL Inc.

**Testing Engineer** : Thomas Yu  
(Thomas Yu)

**Technical Manager** : Krain Wu  
(Krain Wu)

**Authorized Signatory** : young chai  
(Young Chai)

# B T L I N C .

No. 29, Jintang Road, Tangzhen Industry Park, Pudong New Area,  
Shanghai 201210, China  
TEL: +86-021-61765666



Certificate # 5123.03

## Declaration

**BTL** represents to the client that testing is done in accordance with standard procedures as applicable and that test instruments used has been calibrated with standards traceable to international standard(s) and/or national standard(s).

**BTL's** reports apply only to the specific samples tested under conditions. It is manufacture's responsibility to ensure that additional production units of this model are manufactured with the identical electrical and mechanical components. **BTL** shall have no liability for any declarations, inferences or generalizations drawn by the client or others from **BTL** issued reports.

The report must not be used by the client to claim product certification, approval, or endorsement by NVLAP, NIST, A2LA, or any agency of the U.S. Government.

This report is the confidential property of the client. As a mutual protection to the clients, the public and ourselves, the test report shall not be reproduced, except in full, without our written approval.

**BTL's** laboratory quality assurance procedures are in compliance with the **ISO/IEC 17025** requirements, and accredited by the conformity assessment authorities listed in this test report.

**BTL** is not responsible for the sampling stage, so the results only apply to the sample as received.

The information, data and test plan are provided by manufacturer which may affect the validity of results, so it is manufacturer's responsibility to ensure that the apparatus meets the essential requirements of applied standards and in all the possible configurations as representative of its intended use.

## Limitation

For the use of the authority's logo is limited unless the Test Standard(s)/Scope(s)/Item(s) mentioned in this test report is (are) included in the conformity assessment authorities acceptance respective.

Please note that the measurement uncertainty is provided for informational purpose only and are not use in determining the Pass/Fail results.

<b>Table of Contents</b>	<b>page</b>
<b>REPORT ISSUED HISTORY</b>	<b>4</b>
<b>1 . GENERAL SUMMARY</b>	<b>5</b>
<b>2 . EUT INFORMATION</b>	<b>6</b>
2.1 EUT SPECIFICATION TABLE	6
2.2 CONDUCTED OUTPUT POWER AND EIRP	9
<b>3 .U-NII DFS RULE REQUIREMENTS</b>	<b>10</b>
3.1 WORKING MODES AND REQUIRED TEST ITEMS	10
3.2 TEST LIMITS AND RADAR SIGNAL PARAMETERS	11
<b>4 . TEST INSTRUMENTS</b>	<b>14</b>
<b>5 . DYNAMIC FREQUENCY SELECTION (DFS) TEST</b>	<b>15</b>
5.1 DFS MEASUREMENT SYSTEM	15
5.2 CALIBRATION OF DFS DETECTION THRESHOLD LEVEL	19
5.3 DEVIATION FROM TEST STANDARD	19
<b>6 . TEST RESULTS</b>	<b>20</b>
6.1 SUMMARY OF TEST RESULT	20
6.2 TEST MODE: DEVICE OPERATING IN MASTER MODE.	20
6.3 DFS DETECTION THRESHOLD	20
6.4 CHANNEL AVAILABILITY CHECK TIME	97
6.5 CHANNEL CLOSING TRANSMISSION AND CHANNEL MOVE TIME WLAN TRAFFIC	106
6.6 NON- OCCUPANCY PERIOD	122
6.7 UNIFORM SPREADING	124
6.8 U-NII DETECTION BANDWIDTH	124

### REPORT ISSUED HISTORY

Report Version	Description	Issued Date
R00	Original Issue.	Sep. 03, 2019

## 1. GENERAL SUMMARY

Equipment : GPON ONT  
Brand Name : ZTE  
Test Model : ZXHN F680  
Series Model : N/A  
Applicant : ZTE Corporation  
Manufacturer : ZTE Corporation  
Address : ZTE Plaza, Hi-Tech Park, Nanshan District, Shenzhen, Guangdong,  
P.R.China  
Date of Test : Jun. 27, 2019~Jul. 29, 2019  
Test Sample : Engineering Sample No.: SH190612106  
Standard(s) : FCC Part 15, Subpart E (Section 15.407) / FCC 06-96  
RSS-247 Section 6  
FCC KDB 789033 D02 General U-NII Test Procedures New Rules v02r01  
FCC KDB 905462 D02 UNII DFS Compliance Procedures New Rules v02

The above equipment has been tested and found compliance with the requirement of the relative standards by BTL Inc.

The test data, data evaluation, and equipment configuration contained in our test report (Ref No. BTL-FCCP-3-1906H014) were obtained utilizing the test procedures, test instruments, test sites that has been accredited by the Authority of A2LA according to the ISO/IEC 17025 quality assessment standard and technical standard(s).

**Test results included in this report are only for the DFS Master part.**

## 2. EUT INFORMATION

### 2.1 EUT SPECIFICATION TABLE

Table 1: Specification of EUT

<b>Product Name</b>	GPON ONT
<b>Brand Name</b>	ZTE
<b>Test Model</b>	ZXHN F680
<b>Series Model</b>	N/A
<b>Model Difference(s)</b>	N/A
<b>Software Version</b>	V5.0.xx
<b>Hardware Version</b>	V5.0
<b>Operational Mode</b>	Master
<b>Operating Frequency Range</b>	5250 MHz~5350 MHz & 5470 MHz~5725 MHz
<b>Modulation</b>	OFDM

**Note:** This device was functioned as a

Master     Slave device without radar detection     Slave device with radar detection

Note:

1. For a more detailed features description, please refer to the manufacturer's specifications or the user's manual.

2. Channel List:

802.11a 802.11n 20MHz 802.11ac 20MHz		802.11n 40MHz 802.11ac 40MHz		802.11ac 80MHz	
UNII-2A		UNII-2A		UNII-2A	
Channel	Frequency (MHz)	Channel	Frequency (MHz)	Channel	Frequency (MHz)
52	5260	54	5270	58	5290
56	5280	62	5310		
60	5300				
64	5320				

IEEE 802.11a IEEE 802.11n (HT20) IEEE 802.11ac (VHT20)		IEEE 802.11n (HT40) IEEE 802.11ac (VHT40)		IEEE 802.11ac (VHT80)	
UNII-2C		UNII-2C		UNII-2C	
Channel	Frequency (MHz)	Channel	Frequency (MHz)	Channel	Frequency (MHz)
100	5500	102	5510	106	5530
104	5520	110	5550	122	5610
108	5540	118	5590		
112	5560	126	5630		
116	5580	134	5670		
120	5600				
124	5620				
128	5640				
132	5660				
136	5680				
140	5700				

### 3. Antenna Specification:

#### For UNII-2A

Ant.	Brand	Model Name	Antenna Type	Connector	Gain (dBi)	Note
1	N/A	N/A	PCB	N/A	2.2	N/A
2	N/A	N/A	PCB	N/A	2.2	N/A
3	N/A	N/A	PCB	N/A	2.2	N/A
4	N/A	N/A	PCB	N/A	2.4	N/A

#### For UNII-2C

Ant.	Brand	Model Name	Antenna Type	Connector	Gain (dBi)	Note
1	N/A	N/A	PCB	N/A	2.5	N/A
2	N/A	N/A	PCB	N/A	2.5	N/A
3	N/A	N/A	PCB	N/A	2.5	N/A
4	N/A	N/A	PCB	N/A	2.8	N/A

Note:

- (1) The EUT incorporates a MIMO function. Physically, the EUT provides four completed transmitters and receivers (4T4R), all transmit signals are completely uncorrelated, then, Directional gain =  $G_{ANT}$ , that is Directional gain for UNII-2A=2.4; for UNII-2C=2.8.
- (2) Beamforming Function, Beamforming Gain: 5dB, so Directional gain for UNII-2A=7.4; for UNII-2C=7.8; Then, the UNII-2A output power limit is  $24-(7.4-6)=22.6$ , the UNII-2C output power limit is  $24-(7.8-6)=22.2$ , the UNII-1 power density limit is  $17-(7.4-6)=15.6$ , the UNII-2A power spectral density limit is  $11-(7.4-6)=9.6$ , the UNII-2C power spectral density limit is  $11-(7.8-6)=9.2$ .



## 2.2 CONDUCTED OUTPUT POWER AND EIRP

Table 2: The Conducted Output Power and EIRP List

Non-Beamforming:

Mode: TX (11a)				
Frequency Band (MHz)	Max Couducted Output Power (dBm)	Antenna Gain	Max EIRP (dBm)	Max EIRP (mW)
5250~5350	20.97	2.4	23.37	217.27
5470~5725	20.42	2.8	23.22	209.89

Mode: TX (11n 40MHz)				
Frequency Band (MHz)	Max Couducted Output Power (dBm)	Antenna Gain	Max EIRP (dBm)	Max EIRP (mW)
5250~5350	20.80	2.4	23.20	208.93
5470~5725	17.32	2.8	20.12	102.80

Mode: TX (11ac 80 MHz)				
Frequency Band (MHz)	Max Couducted Output Power (dBm)	Antenna Gain	Max EIRP (dBm)	Max EIRP (mW)
5250~5350	15.94	2.4	18.34	68.23
5470~5725	20.59	2.8	23.39	218.27

Beamforming:

Mode: TX (11n 40MHz)				
Frequency Band (MHz)	Max Couducted Output Power (dBm)	Antenna Gain	Max EIRP (dBm)	Max EIRP (mW)
5250~5350	20.58	2.4	22.98	198.61
5470~5725	17.06	2.8	19.86	96.83

Mode: TX (11ac 80 MHz)				
Frequency Band (MHz)	Max Couducted Output Power (dBm)	Antenna Gain	Max EIRP (dBm)	Max EIRP (mW)
5250~5350	15.88	2.4	18.28	67.30
5470~5725	20.39	2.8	23.19	208.45

### 3.U-NII DFS RULE REQUIREMENTS

#### 3.1 WORKING MODES AND REQUIRED TEST ITEMS

The manufacturer shall state whether the UUT is capable of operating as a Master and/or a Client. If the UUT is capable of operating in more than one operating mode then each operating mode shall be tested separately. See tables 3 and 4 for the applicability of DFS requirements for each of the operational modes.

Table 3: Applicability of DFS requirements prior to use a channel

Requirement	Operational Mode		
	Master	Client without radar detection	Client with radar detection
Non-Occupancy Period	✓	✓	✓
DFS Detection Threshold	✓	Not required	✓
Channel Availability Check Time	✓	Not required	Not required
Uniform Spreading	✓	Not required	Not required
U-NII Detection Bandwidth	✓	Not required	✓

Table 4: Applicability of DFS requirements during normal operation.

Requirement	Operational Mode		
	Master	Client without radar detection	Client with radar detection
DFS Detection Threshold	✓	Not required	✓
Channel Closing Transmission Time	✓	✓	✓
Channel Move Time	✓	✓	✓
U-NII Detection Bandwidth	✓	Not required	✓

### 3.2 TEST LIMITS AND RADAR SIGNAL PARAMETERS

#### DETECTION THRESHOLD VALUES

Table 5: DFS Detection Thresholds for Master Devices and Client Devices With Radar Detection.

Maximum Transmit Power	Value (See Notes 1 and 2)
EIRP $\geq$ 200 milliwatt	-64 dBm
EIRP < 200 milliwatt and power spectral density < 10 dBm/MHz	-62 dBm
EIRP < 200 milliwatt that do not meet the power spectral density requirement	-64 dBm

**Note 1:** This is the level at the input of the receiver assuming a 0 dBi receive antenna.

**Note 2:** Throughout these test procedures an additional 1 dB has been added to the amplitude of the test transmission waveforms to account for variations in measurement equipment. This will ensure that the test signal is at or above the detection threshold level to trigger a DFS response.

**Note3:** EIRP is based on the highest antenna gain. For MIMO devices refer to KDB Publication 662911 D01.

Table 6: DFS Response Requirement Values

Parameter	Value
Non-occupancy period	Minimum 30 minutes
Channel Availability Check Time	60 seconds
Channel Move Time	10 seconds See Note 1.
Channel Closing Transmission Time	200 milliseconds + an aggregate of 60 milliseconds over remaining 10 second period. See Notes 1 and 2.
U-NII Detection Bandwidth	Minimum 100% of the UNII 99% transmission power bandwidth. See Note 3.

**Note 1:** Channel Move Time and the Channel Closing Transmission Time should be performed with Radar Type 0. The measurement timing begins at the end of the Radar Type 0 burst.

**Note 2:** The Channel Closing Transmission Time is comprised of 200 milliseconds starting at the beginning of the Channel Move Time plus any additional intermittent control signals required to facilitate a Channel move (an aggregate of 60 milliseconds) during the remainder of the 10 second period. The aggregate duration of control signals will not count quiet periods in between transmissions.

**Note 3:** During the U-NII Detection Bandwidth detection test, radar type 0 should be used. For each frequency step the minimum percentage of detection is 90 percent. Measurements are performed with no data traffic.

### PARAMETERS OF DFS TEST SIGNALS

Step intervals of 0.1 microsecond for Pulse Width, 1 microsecond for PRI, 1 MHz for chirp width and 1 for the number of pulses will be utilized for the random determination of specific test waveforms.

Table 7: Short Pulse Radar Test Waveforms.

Radar Type	Pulse Width (μsec)	PRI (μsec)	Number of Pulses	Minimum Percentage of Successful Detection	Minimum Number of Trials
0	1	1428	18	See Note 1	See Note 1
1	1	Test A: 15 unique PRI values randomly selected from the list of 23 PRI values in Table 5a	Roundup $\left\{ \begin{matrix} \left( \frac{1}{360} \right) \cdot \\ \left( \frac{19 \cdot 10^6}{PRI_{\mu sec}} \right) \end{matrix} \right\}$	60%	30
		Test B: 15 unique PRI values randomly selected within the range of 518-3066 μsec, with a minimum increment of 1 μsec, excluding PRI values selected in Test A			
2	1-5	150-230	23-29	60%	30
3	6-10	200-500	16-18	60%	30
4	11-20	200-500	12-16	60%	30
Aggregate (Radar Types 1-4)				80%	120
<b>Note 1:</b> Short Pulse Radar Type 0 should be used for the detection bandwidth test, channel move time, and channel closing time tests.					

A minimum of 30 unique waveforms are required for each of the Short Pulse Radar Types 2 through 4. If more than 30 waveforms are used for Short Pulse Radar Types 2 through 4, then each additional waveform must also be unique and not repeated from the previous waveforms. If more than 30 waveforms are used for Short Pulse Radar Type 1, then each additional waveform is generated with Test B and must also be unique and not repeated from the previous waveforms in Tests A or B.

Table 8: Long Pulse Radar Test Waveform

Radar Type	Pulse Width (μsec)	Chirp Width (MHz)	PRI (μsec)	Number of Pulses per Burst	Number of Bursts	Minimum Percentage of Successful Detection	Minimum Number of Trials
5	50-100	5-20	1000-2000	1-3	8-20	80%	30

The parameters for this waveform are randomly chosen (The center frequency for each of the 30 trials of the Bin 5 radar shall be randomly selected within 80% of the Occupied Bandwidth.) Thirty unique waveforms are required for the Long Pulse Radar Type waveforms. If more than 30 waveforms are used for the Long Pulse Radar Type waveforms, then each additional waveform must also be unique and not repeated from the previous waveforms.

Table 9: Frequency Hopping Radar Test Waveform

Radar Type	Pulse Width (μsec)	Chirp Width (MHz)	PRI (μsec)	Number of Pulses per Burst	Number of Bursts	Minimum Percentage of Successful Detection	Minimum Number of Trials
6	1	333	9	0.333	300	70%	30

#### 4. TEST INSTRUMENTS

Table 10: Test instruments list.

Kind of Equipment	Manufacturer	Type No.	Serial No.	Calibrated until
EXA Spectrum Analyzer	Keysight	N9010A	MY56480561	Mar. 29, 2020
MXG X-Series RF Vector Signal Generator	Keysight	N5182B	MY56200484	Mar. 29, 2020
Power Divider	JUK	PD-2SF-2060	N/A	N/A
Power Divider	JUK	PD-2SF-2060	N/A	N/A
Attenuator	Solvang Technology	5.8GHz 0-65dB	STI02-0203-01	Nov. 20, 2019

Note: Calibration interval of instruments listed above is one year.

## 5. DYNAMIC FREQUENCY SELECTION (DFS) TEST

### 5.1 DFS MEASUREMENT SYSTEM

#### Test Procedure

1. Master device and client device are set up by conduction method as the following configuration.
2. The client device is connected to notebook and to access a IP address on wireless connection with the master device.
3. Then the master device is connected to another notebook to access a IP address.
4. Finally, let the two IP addresses run traffic with each other through the Run flow software “Lan test” to reach 17% channel loading as below.

#### Setup

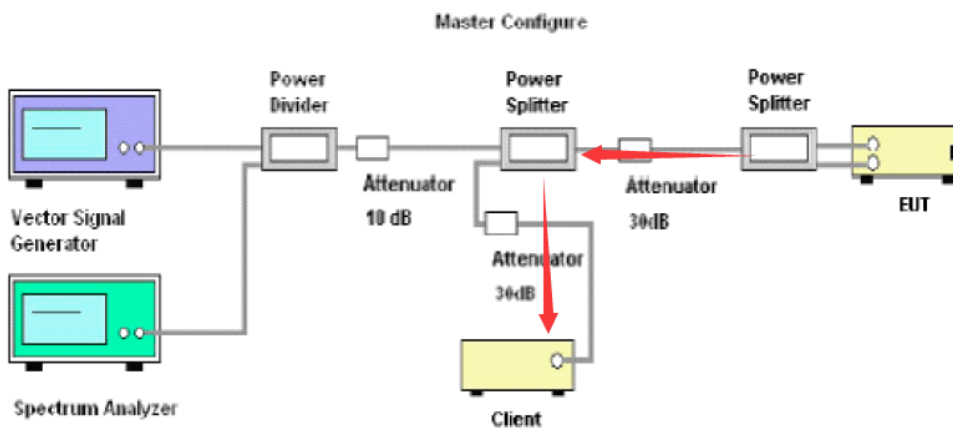

Channel Loading

11a Mode

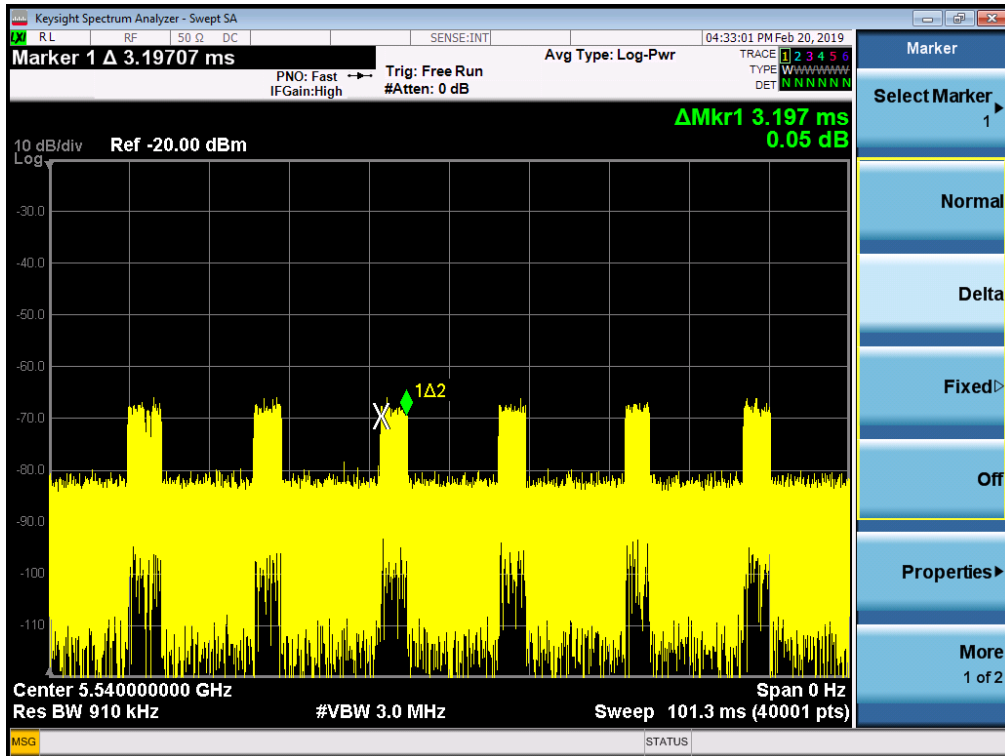

11n 40MHz Mode

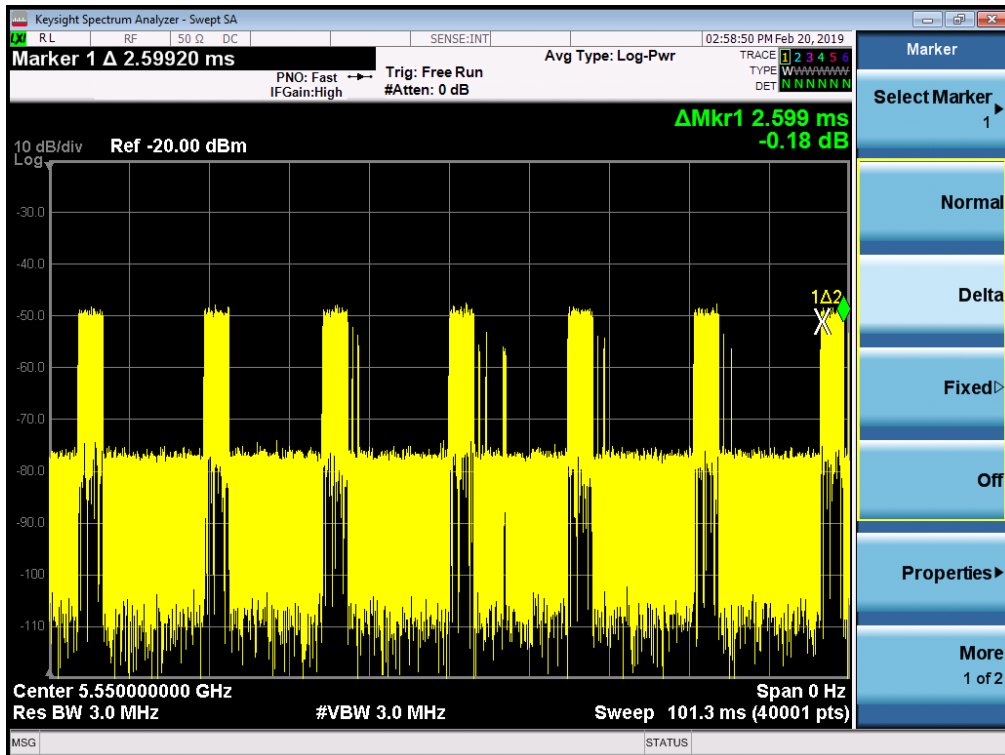



### 11ac 80MHz Mode

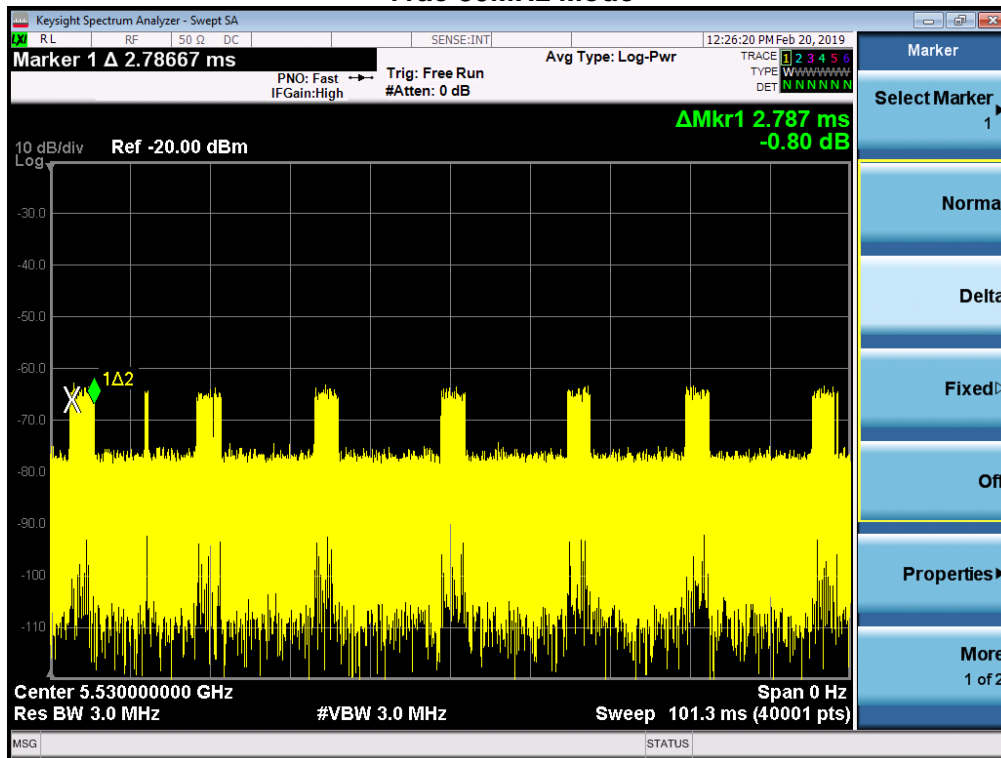

Channel (MHz)	Marker Delta (ms)	Number	On Time (ms)	Total Time (ms)	Duty cycle (%)	Limit (%)
5540	3.197	6	19.18	101.3	18.94	17.00
5550	2.599	7	18.19	101.3	17.96	17.00
5530	2.787	7	19.51	101.3	19.26	17.00

The hopping type 6 pulse parameters are fixed while the hopping sequence is based on the August 2005 NTIA Hopping Frequency List. The initial starting point randomized at run-time and each subsequent starting point is incremented by 475. Each frequency in the 100-length segment is compared to the boundaries of the EUT Detection Bandwidth and the software creates a hopping burst pattern in accordance with Section 7.4.1.3 Method #2 Simulated Frequency Hopping Radar Waveform Generating Subsystem of FCC 06-96. The frequency of the signal generator is incremented in 1 MHz steps from FL to FH for each successive trial. This incremental sequence is repeated as required to generate a minimum of 30 total trials and to maintain a uniform frequency distribution over the entire Detection Bandwidth.

The signal monitoring equipment consists of a spectrum analyzer set to display 8001 bins on the horizontal axis. The time-domain resolution is 2 msec / bin with a 16 second sweep time, meeting the 10 second short pulse reporting criteria. The aggregate ON time is calculated by multiplying the number of bins above a threshold during a particular observation period by the dwell time per bin, with the analyzer set to peak detection and max hold.

Should multiple RF ports be utilized for the Master and/or Slave devices (for example, for diversity or MIMO implementations), additional combiner/dividers are inserted between the Master Combiner/Divider and the pad connected to the Master Device (and/or between the Slave Combiner/Divider and the pad connected to the Slave Device). Additional pads are utilized such that there is one pad at each RF port on each EUT.

**5.2 CALIBRATION OF DFS DETECTION THRESHOLD LEVEL**

A 50 ohm load is connected in place of the spectrum analyzer, and the spectrum analyzer is connected in place of the master device and the signal generator is set to CW mode. The amplitude of the signal generator is adjusted to yield a level of -64dBm as measured on the spectrum analyzer.

Without changing any of the instrument settings, the spectrum analyzer is reconnected to the Common port of the Spectrum Analyzer Combiner/Divider. Measure the amplitude and calculate the difference from -64 dBm. Adjust the Reference Level Offset of the spectrum analyzer to this difference.

The spectrum analyzer displays the level of the signal generator as received at the antenna ports of the Master Device. The interference detection threshold may be varied from the calibrated value of -64 dBm and the spectrum analyzer will still indicate the level as received by the Master Device.

Set the signal generator to produce a radar waveform, trigger a burst manually and measure the level on the spectrum analyzer. Readjust the amplitude of the signal generator as required so that the peak level of the waveform is at a displayed level equal to the required or desired interference detection threshold. Separate signal generator amplitude settings are determined as required for each radar type.

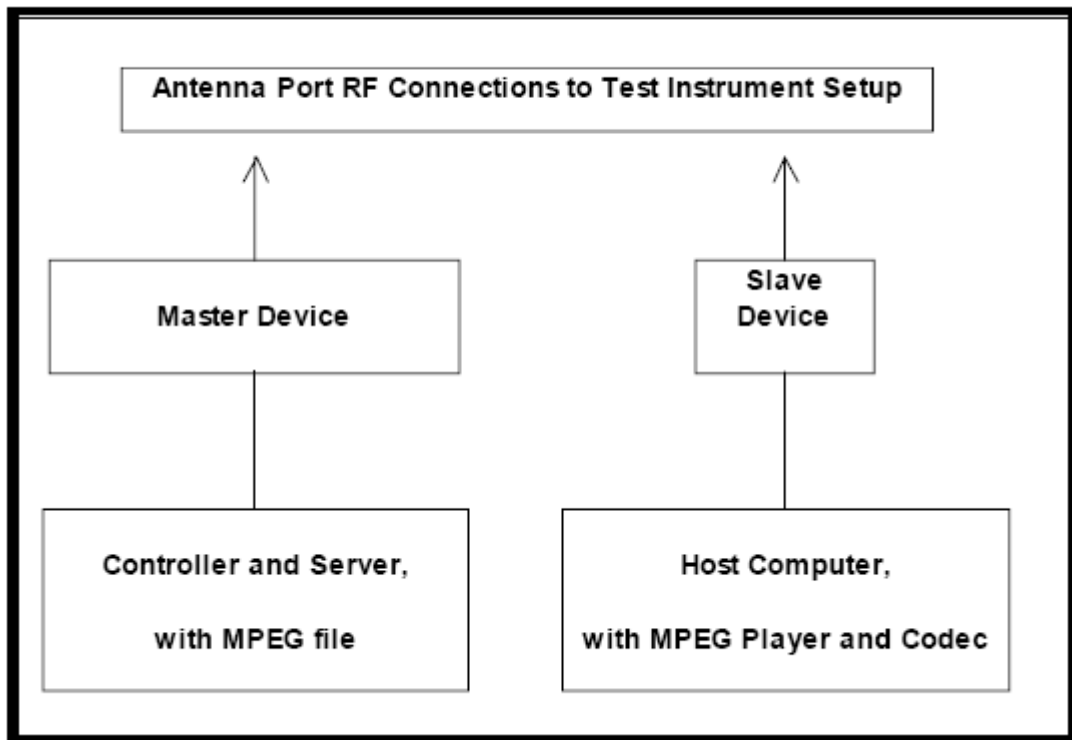

**5.3 DEVIATION FROM TEST STANDARD**

No deviation.

## 6. TEST RESULTS

### 6.1 SUMMARY OF TEST RESULT

Clause	Test Parameter	Test Mode and Channel	Remarks	Pass/Fail
15.407	DFS Detection Threshold	11a 5540MHz	Applicable	Pass
		11n 40MHz 5550MHz		
		11ac 80MHz 5530MHz		
15.407	Channel Availability Check Time	11a 5540MHz	Applicable	Pass
		11n 40MHz 5550MHz		
		11ac 80MHz 5530MHz		
15.407	Channel Move Time	11a 5540MHz	Applicable	Pass
		11n 40MHz 5550MHz		
		11ac 80MHz 5530MHz		
15.407	Channel Closing Transmission Time	11a 5540MHz	Applicable	Pass
		11n 40MHz 5550MHz		
		11ac 80MHz 5530MHz		
15.407	Non- Occupancy Period	11a 5540MHz	Applicable	Pass
		11n 40MHz 5550MHz		
		11ac 80MHz 5530MHz		
15.407	Uniform Spreading	11a 5540MHz	Applicable	Pass
		11n 40MHz 5550MHz		
		11ac 80MHz 5530MHz		
15.407	U-NII Detection Bandwidth	11a 5540MHz	Applicable	Pass
		11n 40MHz 5550MHz		
		11ac 80MHz 5530MHz		

### 6.2 TEST MODE: DEVICE OPERATING IN MASTER MODE.

Master with injection at the Master. (Radar Test Waveforms are injected into the Master)

### 6.3 DFS DETECTION THRESHOLD

Calibration:

For a detection threshold level of -64dBm and the Master antenna gain is 2.8dBi, required detection threshold is -61.20dBm (= -64+2.8).

Note: Maximum Transmit Power is more than 200 milliwatt in this report, so detection threshold level is -64dBm (please refer to Table 5 [page 9]).

### Radar Signal 0

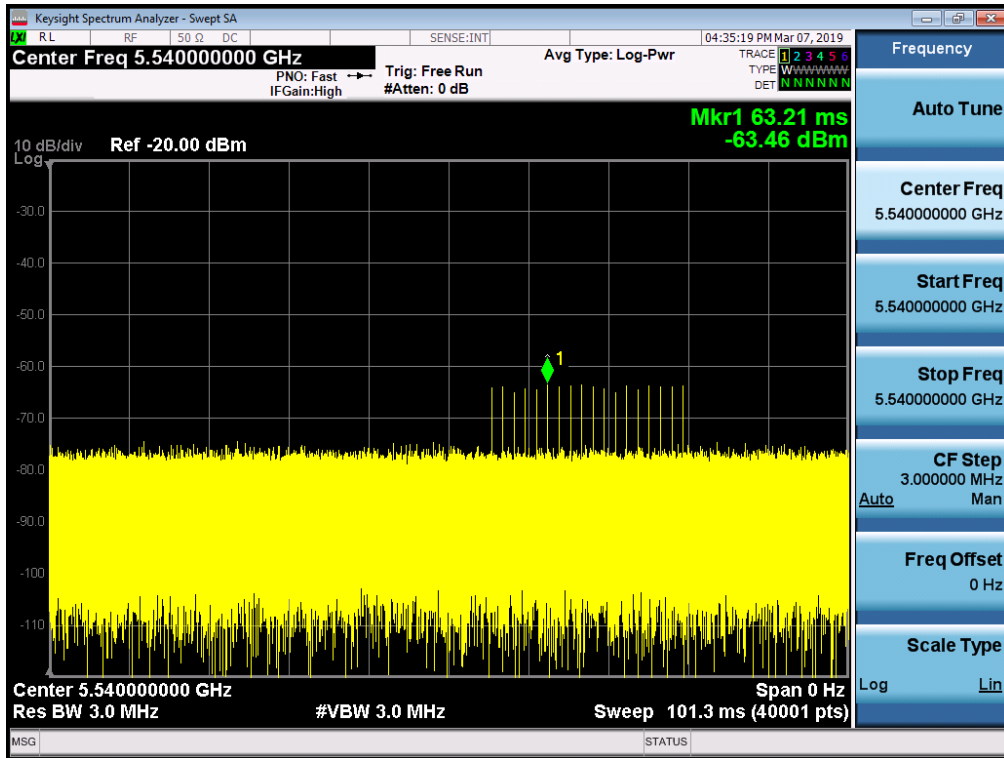

### Radar Signal 1

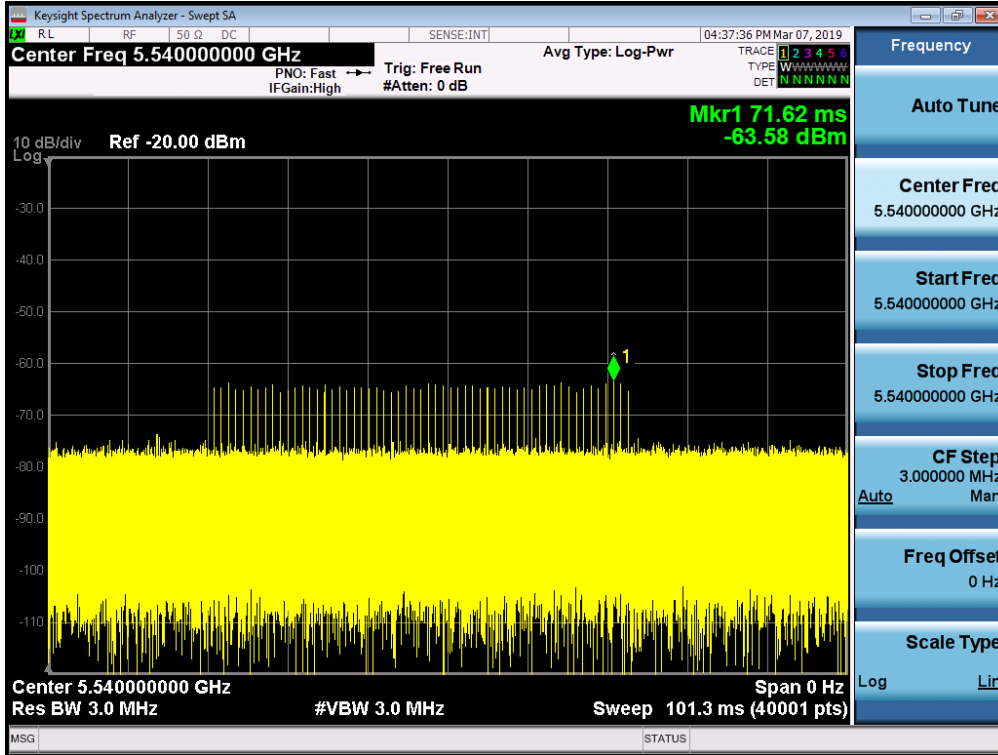

### Radar Signal 2

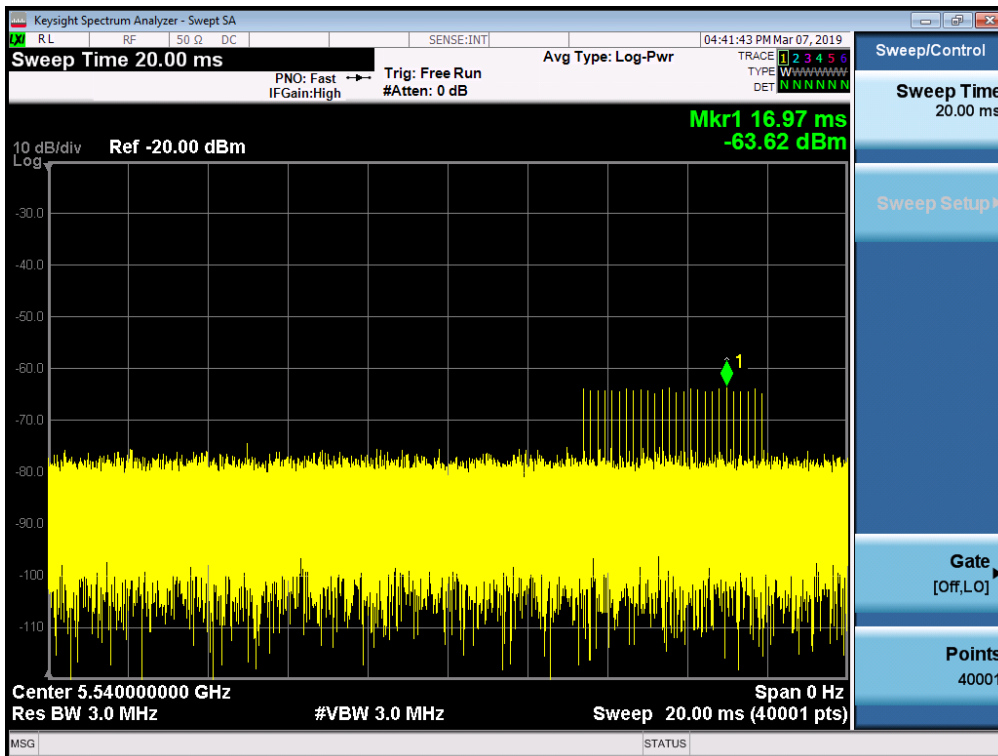

### Radar Signal 3

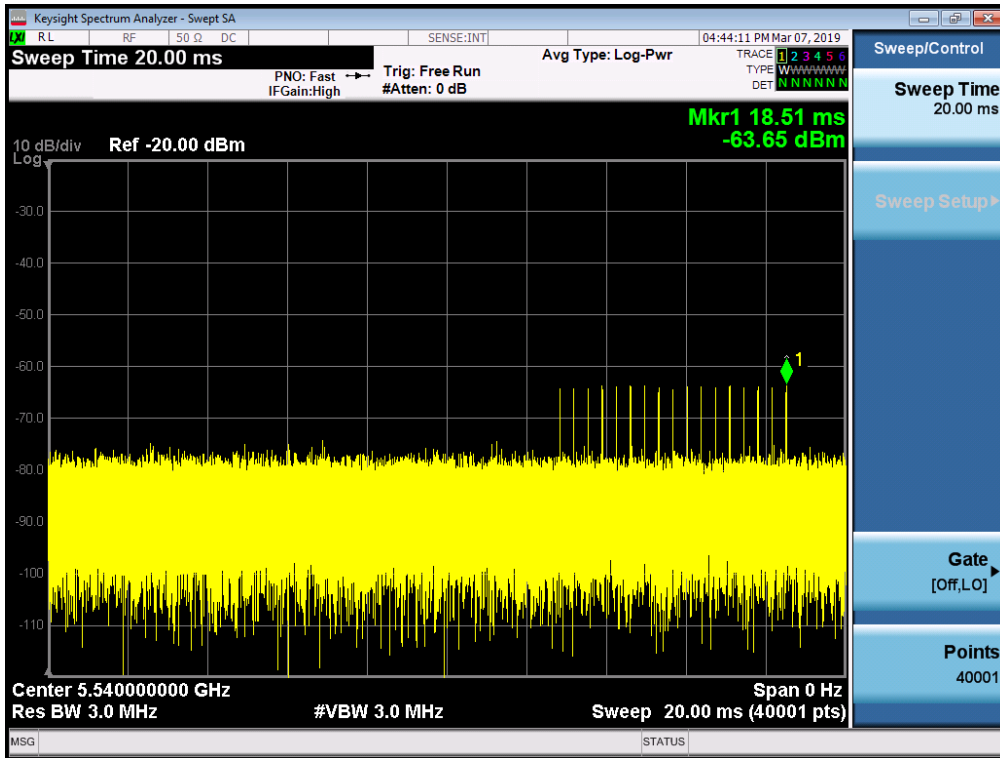

### Radar Signal 4

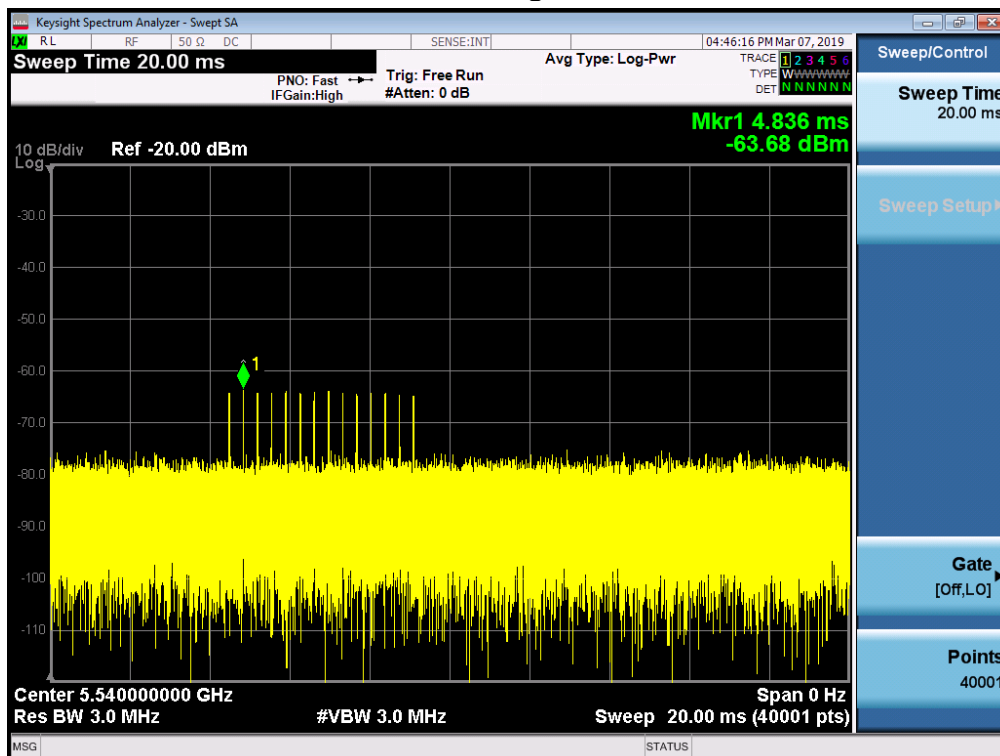

### Radarsignal 5

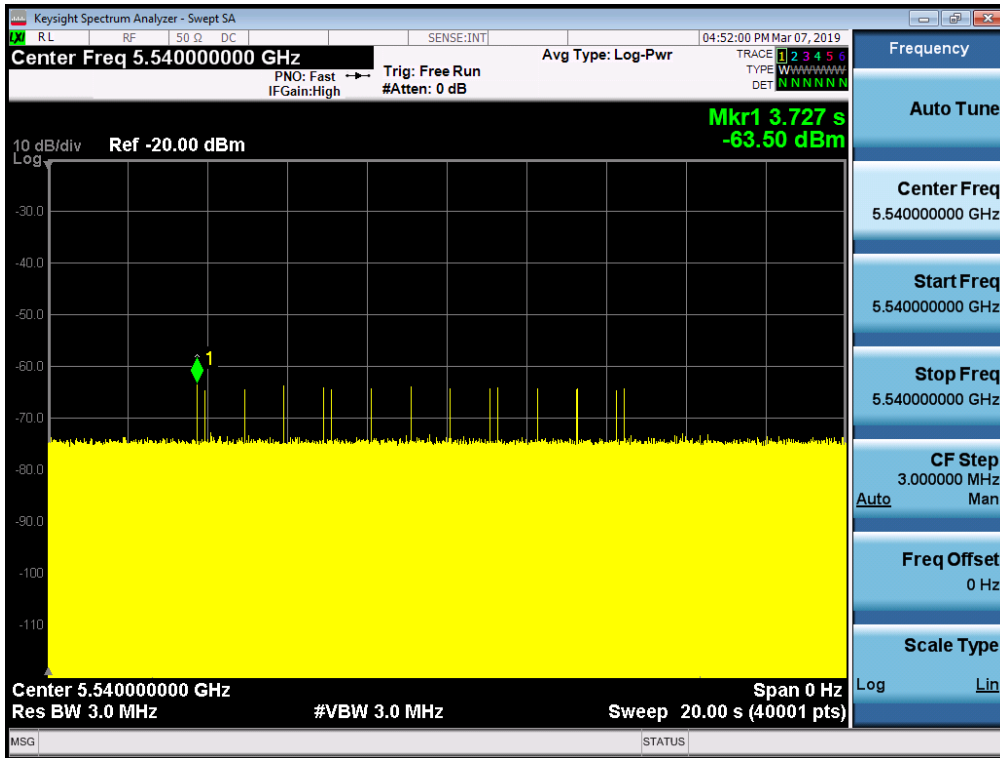

### Radarsignal 6

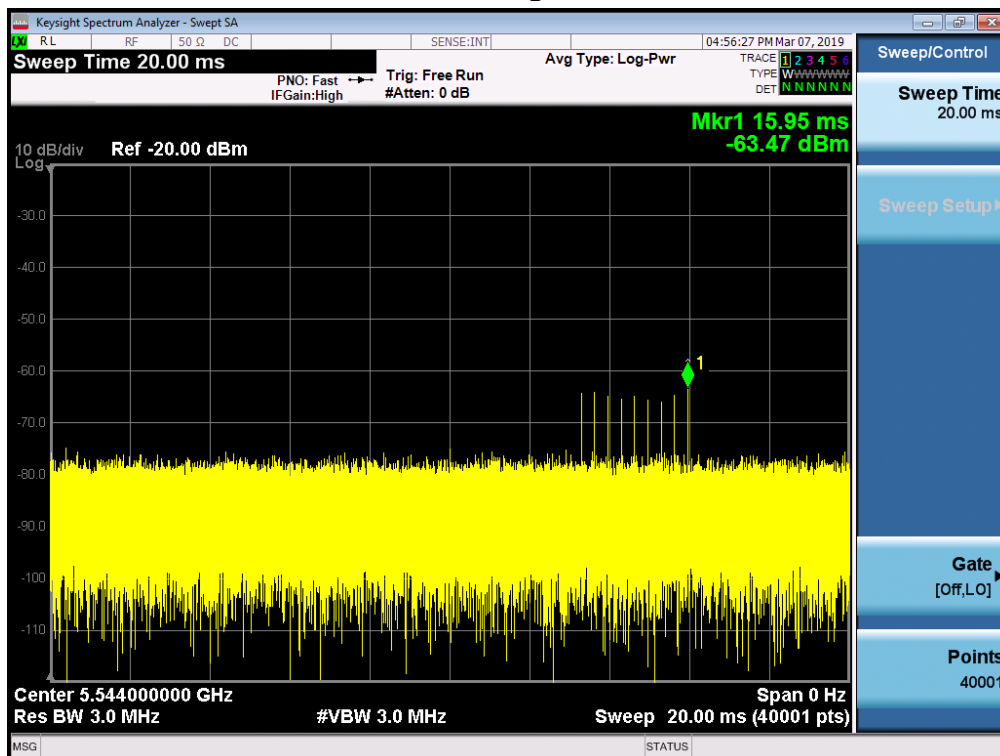



### Radar Signal 0

Trial ID	Radar Type	Pulse Width (us)	PRI (us)	Number of Pulses	Waveform Length (us)
0	Type 0	1	1428	18	25704
1	Type 0	1	1428	18	25704
2	Type 0	1	1428	18	25704
3	Type 0	1	1428	18	25704
4	Type 0	1	1428	18	25704
5	Type 0	1	1428	18	25704
6	Type 0	1	1428	18	25704
7	Type 0	1	1428	18	25704
8	Type 0	1	1428	18	25704
9	Type 0	1	1428	18	25704
10	Type 0	1	1428	18	25704
11	Type 0	1	1428	18	25704
12	Type 0	1	1428	18	25704
13	Type 0	1	1428	18	25704
14	Type 0	1	1428	18	25704
15	Type 0	1	1428	18	25704
16	Type 0	1	1428	18	25704
17	Type 0	1	1428	18	25704
18	Type 0	1	1428	18	25704
19	Type 0	1	1428	18	25704
20	Type 0	1	1428	18	25704
21	Type 0	1	1428	18	25704
22	Type 0	1	1428	18	25704
23	Type 0	1	1428	18	25704
24	Type 0	1	1428	18	25704
25	Type 0	1	1428	18	25704
26	Type 0	1	1428	18	25704
27	Type 0	1	1428	18	25704
28	Type 0	1	1428	18	25704
29	Type 0	1	1428	18	25704

### Radar Signal 1

Trial ID	Radar Type	Pulse Width (us)	PRI (us)	Number of Pulses	Waveform Length (us)	Pulse Repetition Frequency (Pulses Per Second)	Pulse Repetition Interval (Microseconds)
0	Type A	1	938	57	53466	1066.1	938
1	Type A	1	698	76	53048	1432.7	698
2	Type A	1	618	86	53148	1618.1	618
3	Type A	1	538	99	53262	1858.7	538
4	Type A	1	878	61	53558	1139	878
5	Type A	1	3066	18	55188	326.2	326.2
6	Type A	1	638	83	52954	1567.4	1567.4
7	Type A	1	918	58	53244	1089.3	1089.3
8	Type A	1	838	63	52794	1193.3	1193.3
9	Type A	1	858	62	53196	1165.6	1165.6
10	Type A	1	798	67	53466	1253.1	1253.1
11	Type A	1	718	74	53132	1392.8	1392.8
12	Type A	1	578	92	53176	1730.1	1730.1
13	Type A	1	598	89	53222	1672.2	1672.2
14	Type A	1	558	95	53010	1792.1	1792.1
15	Type B	1	2536	21	53256	-	-
16	Type B	1	966	55	53130	-	-
17	Type B	1	827	64	52928	-	-
18	Type B	1	2501	22	55022	-	-
19	Type B	1	2595	21	54495	-	-
20	Type B	1	1114	48	53472	-	-
21	Type B	1	1302	41	53382	-	-
22	Type B	1	3045	18	54810	-	-
23	Type B	1	1624	33	53592	-	-
24	Type B	1	2878	19	54682	-	-
25	Type B	1	1027	52	53404	-	-
26	Type B	1	2485	22	54670	-	-
27	Type B	1	1600	33	52800	-	-
28	Type B	1	1172	46	53912	-	-
29	Type B	1	1177	45	52965	-	-

### Radar Signal 2

Trial ID	Radar Type	Pulse Width (us)	PRI (us)	Number of Pulses	Waveform Length (us)
0	Type 2	3.2	179	26	4654
1	Type 2	1.1	207	23	4761
2	Type 2	2.1	230	24	5520
3	Type 2	4.8	200	29	5800
4	Type 2	3.9	214	28	5992
5	Type 2	2.9	222	26	5772
6	Type 2	3.2	204	26	5304
7	Type 2	2.5	192	25	4800
8	Type 2	3.1	164	26	4264
9	Type 2	1.2	156	23	3588
10	Type 2	3.9	210	27	5670
11	Type 2	4.6	201	29	5829
12	Type 2	3.2	162	26	4212
13	Type 2	2.2	197	25	4925
14	Type 2	4.5	163	29	4727
15	Type 2	3	203	26	5278
16	Type 2	5	168	29	4872
17	Type 2	2.4	217	25	5425
18	Type 2	2.9	191	26	4966
19	Type 2	2.3	166	25	4150
20	Type 2	3.7	150	27	4050
21	Type 2	2.2	176	25	4400
22	Type 2	4.9	195	29	5655
23	Type 2	2.9	202	26	5252
24	Type 2	2.5	178	25	4450
25	Type 2	1.1	206	23	4738
26	Type 2	3.8	155	27	4185
27	Type 2	4.7	157	29	4553
28	Type 2	2.4	224	25	5600
29	Type 2	4.2	159	28	4452

### Radar Signal 3

Trial ID	Radar Type	Pulse Width (us)	PRI (us)	Number of Pulses	Waveform Length (us)
0	Type 3	8.2	355	17	6035
1	Type 3	6.1	487	16	7792
2	Type 3	7.1	344	16	5504
3	Type 3	9.8	288	18	5184
4	Type 3	8.9	230	18	4140
5	Type 3	7.9	432	17	7344
6	Type 3	8.2	207	17	3519
7	Type 3	7.5	443	17	7531
8	Type 3	8.1	439	17	7463
9	Type 3	6.2	223	16	3568
10	Type 3	8.9	208	18	3744
11	Type 3	9.6	463	18	8334
12	Type 3	8.2	441	17	7497
13	Type 3	7.2	323	16	5168
14	Type 3	9.5	297	18	5346
15	Type 3	8	412	17	7004
16	Type 3	10	324	18	5832
17	Type 3	7.4	271	17	4607
18	Type 3	7.9	349	17	5933
19	Type 3	7.3	409	16	6544
20	Type 3	8.7	373	18	6714
21	Type 3	7.2	254	16	4064
22	Type 3	9.9	274	18	4932
23	Type 3	7.9	278	17	4726
24	Type 3	7.5	317	17	5389
25	Type 3	6.1	260	16	4160
26	Type 3	8.8	211	18	3798
27	Type 3	9.7	272	18	4896
28	Type 3	7.4	264	17	4488
29	Type 3	9.2	284	18	5112

### Radar Signal 4

Trial ID	Radar Type	Pulse Width (us)	PRI (us)	Number of Pulses	Waveform Length (us)
0	Type 4	16	355	14	4970
1	Type 4	11.3	487	12	5844
2	Type 4	13.5	344	13	4472
3	Type 4	19.4	288	16	4608
4	Type 4	17.5	230	15	3450
5	Type 4	15.3	432	14	6048
6	Type 4	15.9	207	14	2898
7	Type 4	14.3	443	13	5759
8	Type 4	15.8	439	14	6146
9	Type 4	11.5	223	12	2676
10	Type 4	17.4	208	15	3120
11	Type 4	19	463	16	7408
12	Type 4	16	441	14	6174
13	Type 4	13.8	323	13	4199
14	Type 4	18.9	297	16	4752
15	Type 4	15.5	412	14	5768
16	Type 4	19.9	324	16	5184
17	Type 4	14.1	271	13	3523
18	Type 4	15.2	349	14	4886
19	Type 4	13.8	409	13	5317
20	Type 4	17.1	373	15	5595
21	Type 4	13.8	254	13	3302
22	Type 4	19.8	274	16	4384
23	Type 4	15.3	278	14	3892
24	Type 4	14.5	317	13	4121
25	Type 4	11.3	260	12	3120
26	Type 4	17.3	211	15	3165
27	Type 4	19.2	272	16	4352
28	Type 4	14.2	264	13	3432
29	Type 4	18.2	284	15	4260

### Radar Signal 5\_5530 MHz

Trial ID	Radar Type	Number of Bursts	Burst Period(s)	Wave from Length (s)	Center Frequency(GHz)	-		
0	Type 5	15	0.8	12	5.53	-		
	Burst ID	Pulse Width (us)	PRI (us)	Chirp Width(MHz)	Number of Pulses per Burst	PRI-1 (us)	PRI-2 (us)	PRI-3 (us)
	0	636185	77.8	13	2	1665	1477	-
	1	32674	51.9	13	1	1074	-	-
	2	226294	63.8	13	1	1584	-	-
	3	417976	96.6	13	3	1682	1786	1843
	4	611152	85.9	13	3	1795	1215	1729
	5	8789	73.7	13	2	1198	1549	-
	6	201917	77.2	13	2	1837	1819	-
	7	395530	68.4	13	2	1587	1114	-
	8	588564	76.7	13	2	2000	1155	-
	9	783794	53.2	13	1	1147	-	-
	10	177933	85.7	13	3	1433	1695	1394
	11	370624	94.3	13	3	1670	1426	1935
	12	564893	77.6	13	2	1294	1671	-
	13	759583	65.7	13	1	1512	-	-
	14	154262	93.5	13	3	1444	1130	1468
1	Type 5	8	1.5	12	5.53			
	Burst ID	Burst Offset (us)	Pulse Width (us)	Chirp Width (MHz)	Number of Pulses per Burst	PRI-1 (us)	PRI-2 (us)	PRI-3 (us)
	0	653020	75	5	2	1880	1527	-
	1	1015643	99.4	5	3	1401	1262	1257
	2	1379398	67.4	5	2	1531	1403	-
	3	245489	73.6	5	2	1449	1041	-
	4	609113	65.9	5	1	1432	-	-
	5	970852	83.8	5	3	1356	1292	1419
	6	1335913	65.5	5	1	1543	-	-
	7	200406	98.6	5	3	1548	1796	1728

Trial ID	Radar Type	Number of Bursts	Burst Period(s)	Wave from Length (s)	Center Frequency(GHz)	-		
2	Type 5	11	1.090909	12	5.53			
	Burst ID	Burst Offset (us)	Pulse Width (us)	Chirp Width (MHz)	Number of Pulses per Burst	PRI-1 (us)	PRI-2 (us)	PRI-3 (us)
	0	409565	73.8	9	2	1806	1538	-
	1	673692	69.5	9	2	1117	1649	-
	2	938562	51.9	9	1	1651	-	-
	3	113209	84.6	9	3	1976	1032	1271
	4	376726	95.4	9	3	1060	1903	1388
	5	641212	68	9	2	1368	1351	-
	6	903714	89.6	9	3	1338	1514	1573
	7	80863	81.9	9	2	1022	1689	-
	8	344067	88.3	9	3	1810	1330	1838
	9	609331	53.7	9	1	1597	-	-
	10	871542	91.3	9	3	1961	1106	1001
3	Type 5	20	0.6	12	5.53			
	Burst ID	Burst Offset (us)	Pulse Width (us)	Chirp Width (MHz)	Number of Pulses per Burst	PRI-1 (us)	PRI-2 (us)	PRI-3 (us)
	0	26541	68.1	19	2	1339	1355	-
	1	171821	58.7	19	1	1251	-	-
	2	316229	75.3	19	2	1136	1640	-
	3	461864	56.4	19	1	1753	-	-
	4	8677	99.7	19	3	1196	1708	1159
	5	153995	57.7	19	1	1013	-	-
	6	299238	59.5	19	1	1072	-	-
	7	443177	80	19	2	1482	1369	-
	8	587671	82	19	2	1993	1197	-
	9	135674	82.8	19	2	1883	1005	-
	10	279928	88	19	3	1061	1928	1101
	11	424279	93.2	19	3	1207	1907	1223
	12	570132	70.4	19	2	1526	1360	-
	13	117439	95.3	19	3	1171	1955	1775
	14	262502	81.9	19	2	1690	1545	-
	15	406573	98.5	19	3	1975	1169	1062
	16	553328	65	19	1	1767	-	-
	17	99799	85.4	19	3	1011	1637	1425
	18	244095	91.6	19	3	1878	1445	1325
	19	390012	67.3	19	2	1091	1218	-

Trial ID	Radar Type	Number of Bursts	Burst Period(s)	Wave from Length (s)	Center Frequency(GHz)	-		
4	Type 5	17	0.705882	12	5.53			
	Burst ID	Burst Offset (us)	Pulse Width (us)	Chirp Width (MHz)	Number of Pulses per Burst	PRI-1 (us)	PRI-2 (us)	PRI-3 (us)
	0	629614	67.9	16	2	1320	1133	-
	1	96856	62.3	16	1	1957	-	-
	2	267719	53.3	16	1	1592	-	-
	3	436784	90	16	3	1900	1153	1346
	4	608289	77.1	16	2	1166	1646	-
	5	75610	83.9	16	3	1278	1232	1459
	6	245638	89.1	16	3	1240	1384	1939
	7	416355	81.8	16	2	1833	1676	-
	8	588736	50.3	16	1	1075	-	-
	9	54571	87.1	16	3	1116	1996	1756
	10	225175	71.3	16	2	1225	1815	-
	11	394825	97.5	16	3	1884	1465	1132
	12	565361	90.6	16	3	1561	1040	1354
	13	33643	86.3	16	3	1596	1183	1792
	14	203957	97.6	16	3	1365	1073	1361
	15	373812	84.7	16	3	1021	1718	1854
	16	544060	99.7	16	3	1150	1244	1988



Trial ID	Radar Type	Number of Bursts	Burst Peried(s)	Wave from Length (s)	Center Frequency(GHz)	-		
5	Type 5	14	0.857143	12	5.53			
	Burst ID	Burst Offset (us)	Pulse Width (us)	Chirp Width (MHz)	Number of Pulses per Burst	PRI-1 (us)	PRI-2 (us)	PRI-3 (us)
	0	15438	92.9	12	3	1085	1564	1407
	1	222486	67.7	12	2	1744	1747	-
	2	430731	65.8	12	1	1092	-	-
	3	637784	56.3	12	1	1851	-	-
	4	845342	53.7	12	1	1727	-	-
	5	196720	83.5	12	3	1679	1930	1025
	6	404955	65.8	12	1	1519	-	-
	7	610711	85.9	12	3	1134	1034	1808
	8	818057	76.3	12	2	1606	1926	-
	9	171459	81.5	12	2	1891	1714	-
	10	377969	89.4	12	3	1310	1594	1827
	11	586875	63.4	12	1	1568	-	-
	12	792834	69.6	12	2	1307	1925	-
	13	146044	74.5	12	2	1264	1846	-

Trial ID	Radar Type	Number of Bursts	Burst Period(s)	Wave from Length (s)	Center Frequency(GHz)	-		
6	Type 5	15	0.8	12	5.53			
	Burst ID	Burst Offset (us)	Pulse Width (us)	Chirp Width (MHz)	Number of Pulses per Burst	PRI-1 (us)	PRI-2 (us)	PRI-3 (us)
	0	329022	96.6	13	3	1182	1609	1581
	1	521718	96.7	13	3	1829	1799	1154
	2	714222	86.5	13	3	1923	1396	1865
	3	112450	73.3	13	2	1908	1318	-
	4	306283	55.8	13	1	1688	-	-
	5	500239	55.4	13	1	1145	-	-
	6	690932	85.3	13	3	1336	1504	1820
	7	88645	79.4	13	2	1344	1893	-
	8	282508	65.7	13	1	1476	-	-
	9	475842	68.6	13	2	1008	1028	-
	10	667887	77.7	13	2	1972	1835	-
	11	64845	79.6	13	2	1882	1331	-
	12	257755	94.9	13	3	1830	1070	1349
	13	452335	61.4	13	1	1451	-	-
	14	643395	90.6	13	3	1233	1562	1887
7	Type 5	12	1	12	5.53			
	Burst ID	Burst Offset (us)	Pulse Width (us)	Chirp Width (MHz)	Number of Pulses per Burst	PRI-1 (us)	PRI-2 (us)	PRI-3 (us)
	0	51446	52.6	10	1	1210	-	-
	1	292696	84.1	10	3	1314	1725	1529
	2	533989	97.7	10	3	1139	1868	1805
	3	775564	97.3	10	3	1341	1446	1755
	4	21542	98.8	10	3	1544	1386	1302
	5	263385	72.2	10	2	1771	1184	-
	6	505581	67.6	10	2	1175	1027	-
	7	747058	75.7	10	2	1026	1871	-
	8	989976	60.9	10	1	1798	-	-
	9	234024	64.2	10	1	1138	-	-
	10	475207	78.8	10	2	1784	1604	-
	11	715825	87.5	10	3	1511	1712	1683

Trial ID	Radar Type	Number of Bursts	Burst Period(s)	Wave from Length (s)	Center Frequency(GHz)	-		
8	Type 5	14	0.857143	12	5.53			
	Burst ID	Burst Offset (us)	Pulse Width (us)	Chirp Width (MHz)	Number of Pulses per Burst	PRI-1 (us)	PRI-2 (us)	PRI-3 (us)
	0	823112	54.1	13	1	1415	-	-
	1	174965	50.7	13	1	1221	-	-
	2	382216	52.3	13	1	1974	-	-
	3	587395	99.8	13	3	1558	1696	1949
	4	796897	68.4	13	2	1014	1099	-
	5	149042	80.8	13	2	1736	1505	-
	6	356750	62.5	13	1	1778	-	-
	7	563824	74.8	13	2	1149	1204	-
	8	772314	50.8	13	1	1049	-	-
	9	123796	54	13	1	1417	-	-
	10	331215	63	13	1	1730	-	-
	11	537402	91.8	13	3	1143	1270	1347
	12	744805	79.3	13	2	1274	1992	-
	13	98172	64.3	13	1	1937	-	-
9	Type 5	8	1.5	12	5.53			
	Burst ID	Burst Offset (us)	Pulse Width (us)	Chirp Width (MHz)	Number of Pulses per Burst	PRI-1 (us)	PRI-2 (us)	PRI-3 (us)
	0	535615	63.4	6	1	1043	-	-
	1	898668	52	6	1	1863	-	-
	2	1259235	97.2	6	3	1973	1605	1583
	3	127106	78.7	6	2	1466	1743	-
	4	490358	74.2	6	2	1280	1219	-
	5	852409	88.7	6	3	1293	1934	1273
	6	1217152	54.3	6	1	1991	-	-
	7	82296	95.4	6	3	1580	1555	1791

Trial ID	Radar Type	Number of Bursts	Burst Period(s)	Wave from Length (s)	Center Frequency(GHz)	-		
10	Type 5	17	0.705882	12	5.4979			
	Burst ID	Burst Offset (us)	Pulse Width (us)	Chirp Width (MHz)	Number of Pulses per Burst	PRI-1 (us)	PRI-2 (us)	PRI-3 (us)
	0	209249	73.7	16	2	1208	1497	-
	1	378386	97.4	16	3	1942	1754	1613
	2	548411	91.7	16	3	1999	1702	1462
	3	17733	66.2	16	1	1393	-	-
	4	187952	70.8	16	2	1968	1821	-
	5	359277	52.3	16	1	1740	-	-
	6	528886	78.9	16	2	1308	1984	-
	7	700166	70.9	16	2	1050	1358	-
	8	167197	75.6	16	2	1437	1430	-
	9	338262	59.1	16	1	1697	-	-
	10	508324	77	16	2	1397	1304	-
	11	678689	67.9	16	2	1803	1083	-
	12	146031	81.2	16	2	1720	1932	-
	13	316923	78.7	16	2	1247	1121	-
	14	488056	63.3	16	1	1634	-	-
	15	657326	68.9	16	2	1849	1423	-
	16	125509	59.3	16	1	1093	-	-

Trial ID	Radar Type	Number of Bursts	Burst Period(s)	Wave from Length (s)	Center Frequency(GHz)	-		
11	Type 5	19	0.631579	12	5.4991			
	Burst ID	Burst Offset (us)	Pulse Width (us)	Chirp Width (MHz)	Number of Pulses per Burst	PRI-1 (us)	PRI-2 (us)	PRI-3 (us)
	0	263736	98.9	19	3	1381	1680	1488
	1	416459	82.3	19	2	1716	1855	-
	2	567902	86.7	19	3	1211	1400	1919
	3	92979	89.7	19	3	1861	1068	1282
	4	245155	98.6	19	3	1507	1194	1461
	5	397609	71.1	19	2	1921	1789	-
	6	551431	55.9	19	1	1947	-	-
	7	74413	67.9	19	2	1350	1372	-
	8	226559	84.4	19	3	1203	1107	1443
	9	380056	58.8	19	1	1715	-	-
	10	533408	65.6	19	1	1017	-	-
	11	55547	78.5	19	2	1911	1704	-
	12	207876	82.3	19	2	1845	1686	-
	13	359771	90.1	19	3	1938	1071	1266
	14	511297	90.2	19	3	1989	1089	1950
	15	36803	83.1	19	2	1943	1406	-
	16	189652	58.8	19	1	1742	-	-
	17	341809	77	19	2	1187	1657	-
	18	495737	55	19	1	1012	-	-

Trial ID	Radar Type	Number of Bursts	Burst Period(s)	Wave from Length (s)	Center Frequency(GHz)	-		
12	Type 5	15	0.8	12	5.4967			
	Burst ID	Burst Offset (us)	Pulse Width (us)	Chirp Width (MHz)	Number of Pulses per Burst	PRI-1 (us)	PRI-2 (us)	PRI-3 (us)
	0	22911	58.1	13	1	1929	-	-
	1	216473	52.1	13	1	1910	-	-
	2	410004	59.9	13	1	1971	-	-
	3	603671	60.2	13	1	1812	-	-
	4	794160	95.9	13	3	1399	1906	1608
	5	192251	79.9	13	2	1626	1859	-
	6	385590	78.5	13	2	1238	1917	-
	7	579862	53.8	13	1	1763	-	-
	8	773423	64.7	13	1	1800	-	-
	9	168898	61.4	13	1	1390	-	-
	10	361606	83.2	13	2	1692	1858	-
	11	553866	84.7	13	3	1533	1677	1638
	12	747241	88.7	13	3	1703	1528	1058
	13	144710	78.3	13	2	1258	1951	-
	14	337856	69.3	13	2	1731	1717	-
13	Type 5	12	1	12	5.4955			
	Burst ID	Burst Offset (us)	Pulse Width (us)	Chirp Width (MHz)	Number of Pulses per Burst	PRI-1 (us)	PRI-2 (us)	PRI-3 (us)
	0	664275	75.3	10	2	1994	1612	-
	1	907886	56.3	10	1	1456	-	-
	2	151316	67.7	10	2	1617	1185	-
	3	393746	55.6	10	1	1337	-	-
	4	635093	75.2	10	2	1421	1267	-
	5	876993	76.3	10	2	1359	1305	-
	6	121278	85.7	10	3	1547	1362	1924
	7	362696	98.4	10	3	1873	1550	1249
	8	604342	86.4	10	3	1779	1439	1046
	9	846453	93.6	10	3	1059	1031	1452
	10	91871	63.3	10	1	1328	-	-
	11	333050	92.4	10	3	1412	1673	1322

Trial ID	Radar Type	Number of Bursts	Burst Period(s)	Wave from Length (s)	Center Frequency(GHz)	-		
14	Type 5	19	0.631579	12	5.4987			
	Burst ID	Burst Offset (us)	Pulse Width (us)	Chirp Width (MHz)	Number of Pulses per Burst	PRI-1 (us)	PRI-2 (us)	PRI-3 (us)
	0	361323	93.3	18	3	1983	1912	1535
	1	515261	69.1	18	2	1102	1794	-
	2	39025	86.9	18	3	1044	1152	1148
	3	190900	84.9	18	3	1894	1948	1118
	4	343941	72.3	18	2	1094	1916	-
	5	497624	51.7	18	1	1447	-	-
	6	20319	58.3	18	1	1429	-	-
	7	172999	60.8	18	1	1979	-	-
	8	325872	57.1	18	1	1641	-	-
	9	475841	88.9	18	3	1886	1964	1489
	10	1489	72	18	2	1909	1297	-
	11	153647	90.9	18	3	1261	1566	1370
	12	307096	59.8	18	1	1552	-	-
	13	458804	70	18	2	1759	1291	-
	14	610798	67.2	18	2	1625	1881	-
	15	134759	91.2	18	3	1382	1832	1661
	16	288306	56.5	18	1	1483	-	-
	17	441296	51.2	18	1	1237	-	-
	18	592780	74.1	18	2	1471	1245	-

Trial ID	Radar Type	Number of Bursts	Burst Peried(s)	Wave from Length (s)	Center Frequency(GHz)	-		
15	Type 5	14	0.857143	12	5.4963			
	Burst ID	Burst Offset (us)	Pulse Width (us)	Chirp Width (MHz)	Number of Pulses per Burst	PRI-1 (us)	PRI-2 (us)	PRI-3 (us)
	0	158286	76.9	12	2	1110	1140	-
	1	366024	50.2	12	1	1316	-	-
	2	573452	62.9	12	1	1520	-	-
	3	780619	64.7	12	1	1902	-	-
	4	132455	83.8	12	3	1410	1097	1621
	5	340207	65.4	12	1	1944	-	-
	6	548208	53.2	12	1	1024	-	-
	7	755333	51.7	12	1	1603	-	-
	8	107117	78.7	12	2	1804	1168	-
	9	314500	72.4	12	2	1030	1343	-
	10	522447	53.8	12	1	1327	-	-
	11	728517	73.6	12	2	1524	1553	-
	12	81611	66.7	12	2	1722	1122	-
	13	288948	82.5	12	2	1404	1019	-



Trial ID	Radar Type	Number of Bursts	Burst Period(s)	Wave from Length (s)	Center Frequency(GHz)	-		
16	Type 5	20	0.6	12	5.4995			
	Burst ID	Burst Offset (us)	Pulse Width (us)	Chirp Width (MHz)	Number of Pulses per Burst	PRI-1 (us)	PRI-2 (us)	PRI-3 (us)
	0	345766	87.6	20	3	1565	1055	1840
	1	490019	85.2	20	3	1735	1541	1408
	2	39073	84.8	20	3	1534	1889	1463
	3	183923	77.9	20	2	1749	1460	-
	4	328777	76.5	20	2	1518	1485	-
	5	474728	60.9	20	1	1540	-	-
	6	21394	83	20	2	1080	1010	-
	7	165992	80.4	20	2	1824	1752	-
	8	310973	67.5	20	2	1764	1181	-
	9	456884	62.1	20	1	1495	-	-
	10	3515	86.4	20	3	1773	1966	1263
	11	147928	84.3	20	3	1593	1188	1788
	12	293225	76.9	20	2	1226	1537	-
	13	436922	95.8	20	3	1192	1298	1844
	14	584015	55.2	20	1	1644	-	-
	15	130832	59	20	1	1402	-	-
	16	274684	94.5	20	3	1296	1700	1283
	17	418579	91.9	20	3	1970	1978	1165
	18	563464	85.2	20	3	1732	1551	1189
	19	112787	69.5	20	2	1038	1224	-

Trial ID	Radar Type	Number of Bursts	Burst Period(s)	Wave from Length (s)	Center Frequency(GHz)	-		
17	Type 5	12	1	12	5.4955			
	Burst ID	Burst Offset (us)	Pulse Width (us)	Chirp Width (MHz)	Number of Pulses per Burst	PRI-1 (us)	PRI-2 (us)	PRI-3 (us)
	0	429224	86.4	10	3	1259	1918	1455
	1	670241	92.2	10	3	1598	1719	1895
	2	912880	80.4	10	2	1816	1899	-
	3	158603	54.3	10	1	1335	-	-
	4	400824	53.1	10	1	1303	-	-
	5	641915	69.4	10	2	1503	1546	-
	6	883823	69.1	10	2	1279	1639	-
	7	128373	100	10	3	1375	1438	1595
	8	370379	79.6	10	2	1239	1705	-
	9	611194	88.4	10	3	1374	1579	1623
	10	855665	53.3	10	1	1016	-	-
	11	98897	65.3	10	1	1709	-	-

Trial ID	Radar Type	Number of Bursts	Burst Period(s)	Wave from Length (s)	Center Frequency(GHz)	-		
18	Type 5	14	0.857143	12	5.4963			
	Burst ID	Burst Offset (us)	Pulse Width (us)	Chirp Width (MHz)	Number of Pulses per Burst	PRI-1 (us)	PRI-2 (us)	PRI-3 (us)
	0	292143	55.3	12	1	1920	-	-
	1	499633	58.3	12	1	1797	-	-
	2	706377	72.3	12	2	1610	1039	-
	3	58989	84.8	12	3	1131	1761	1721
	4	266161	82.5	12	2	1875	1431	-
	5	474469	63.3	12	1	1095	-	-
	6	680544	80	12	2	1119	1913	-
	7	33519	90.3	12	3	1660	1853	1123
	8	240319	91.1	12	3	1539	1783	1172
	9	447400	96.6	12	3	1525	1036	1385
	10	654516	82.7	12	2	1710	1990	-
	11	8083	50.7	12	1	1234	-	-
	12	215435	78.4	12	2	1047	1109	-
	13	421325	99.5	12	3	1299	1965	1869
19	Type 5	12	1	12	5.4955			
	Burst ID	Burst Offset (us)	Pulse Width (us)	Chirp Width (MHz)	Number of Pulses per Burst	PRI-1 (us)	PRI-2 (us)	PRI-3 (us)
	0	733725	88.6	10	3	1501	1067	1927
	1	977882	57.4	10	1	1723	-	-
	2	221197	96.6	10	3	1086	1658	1324
	3	462915	69.7	10	2	1751	1945	-
	4	705071	77.9	10	2	1642	1317	-
	5	947923	62	10	1	1866	-	-
	6	191373	88.4	10	3	1997	1077	1366
	7	432561	97.3	10	3	1790	1896	1367
	8	674004	96.2	10	3	1391	1787	1672
	9	915842	95.4	10	3	1020	1892	1414
	10	162176	54.8	10	1	1084	-	-
	11	403553	80.4	10	2	1850	1436	-

Trial ID	Radar Type	Number of Bursts	Burst Period(s)	Wave from Length (s)	Center Frequency(GHz)	-		
20	Type 5	16	0.75	12	5.5625			
	Burst ID	Burst Offset (us)	Pulse Width (us)	Chirp Width (MHz)	Number of Pulses per Burst	PRI-1 (us)	PRI-2 (us)	PRI-3 (us)
	0	483470	74.7	15	2	1619	1611	-
	1	666072	57.1	15	1	1560	-	-
	2	98810	91.9	15	3	1392	1475	1276
	3	279914	83.1	15	2	1809	1772	-
	4	462536	50.7	15	1	1003	-	-
	5	642324	79.2	15	2	1574	1600	-
	6	76831	58.7	15	1	1186	-	-
	7	257785	71	15	2	1521	1567	-
	8	438554	79	15	2	1777	1960	-
	9	620397	68.5	15	2	1284	1428	-
	10	54310	73.5	15	2	1904	1352	-
	11	235506	70.5	15	2	1864	1115	-
	12	417036	76.6	15	2	1045	1300	-
	13	597974	81.2	15	2	1160	1675	-
	14	32086	61.8	15	1	1277	-	-
	15	212751	94.9	15	3	1450	1206	1860
21	Type 5	12	1	12	5.5649			
	Burst ID	Burst Offset (us)	Pulse Width (us)	Chirp Width (MHz)	Number of Pulses per Burst	PRI-1 (us)	PRI-2 (us)	PRI-3 (us)
	0	526149	78.5	9	2	1653	1698	-
	1	767135	89.8	9	3	1174	1962	1167
	2	12955	59.4	9	1	1982	-	-
	3	254612	79.6	9	2	1633	1890	-
	4	496588	76	9	2	1112	1811	-
	5	739728	53.6	9	1	1144	-	-
	6	980872	80.9	9	2	1220	1053	-
	7	225249	61.6	9	1	1724	-	-
	8	467279	53.4	9	1	1901	-	-
	9	709720	59.9	9	1	1379	-	-
	10	951847	60.4	9	1	1453	-	-
	11	194839	91.4	9	3	1768	1726	1227

Trial ID	Radar Type	Number of Bursts	Burst Period(s)	Wave from Length (s)	Center Frequency(GHz)	-		
22	Type 5	20	0.6	12	5.5605			
	Burst ID	Burst Offset (us)	Pulse Width (us)	Chirp Width (MHz)	Number of Pulses per Burst	PRI-1 (us)	PRI-2 (us)	PRI-3 (us)
	0	261858	77	20	2	1191	1363	-
	1	407646	58.1	20	1	1248	-	-
	2	552319	62.1	20	1	1836	-	-
	3	99107	76.9	20	2	1334	1236	-
	4	243514	80	20	2	1914	1852	-
	5	389464	52	20	1	1701	-	-
	6	531093	88.6	20	3	1693	1995	1905
	7	81159	72.9	20	2	1922	1387	-
	8	225245	98.5	20	3	1839	1746	1389
	9	371906	57.9	20	1	1193	-	-
	10	514197	95.9	20	3	1659	1870	1066
	11	63561	53.5	20	1	1162	-	-
	12	207510	92	20	3	1745	1654	1458
	13	353638	57.3	20	1	1834	-	-
	14	497515	70.5	20	2	1684	1586	-
	15	45553	70	20	2	1042	1664	-
	16	189821	84	20	3	1765	1630	1176
	17	335330	76.1	20	2	1557	1057	-
	18	478825	93.2	20	3	1985	1018	1340
	19	27594	96.8	20	3	1760	1614	1817

Trial ID	Radar Type	Number of Bursts	Burst Period(s)	Wave from Length (s)	Center Frequency(GHz)	-		
23	Type 5	14	0.857143	12	5.5637			
	Burst ID	Burst Offset (us)	Pulse Width (us)	Chirp Width (MHz)	Number of Pulses per Burst	PRI-1 (us)	PRI-2 (us)	PRI-3 (us)
	0	247117	50.1	12	1	1841	-	-
	1	453362	93.5	12	3	1590	1081	1413
	2	660875	68.8	12	2	1707	1577	-
	3	14140	56.3	12	1	1056	-	-
	4	220734	86	12	3	1953	1108	1987
	5	428367	75.2	12	2	1572	1536	-
	6	636681	54.4	12	1	1517	-	-
	7	843157	71.1	12	2	1329	1243	-
	8	195585	76.2	12	2	1940	1770	-
	9	403231	80.2	12	2	1098	1209	-
	10	610202	79.7	12	2	1588	1214	-
	11	815229	90.9	12	3	1615	1862	1601
	12	170267	68.7	12	2	1377	1441	-
	13	377306	67.4	12	2	1872	1313	-

Trial ID	Radar Type	Number of Bursts	Burst Period(s)	Wave from Length (s)	Center Frequency(GHz)	-		
24	Type 5	13	0.923077	12	5.5641			
	Burst ID	Burst Offset (us)	Pulse Width (us)	Chirp Width (MHz)	Number of Pulses per Burst	PRI-1 (us)	PRI-2 (us)	PRI-3 (us)
	0	628071	94	11	3	1643	1748	1941
	1	853391	70.8	11	2	1177	1201	-
	2	156223	56.3	11	1	1006	-	-
	3	378734	96.7	11	3	1230	1163	1332
	4	601331	90.6	11	3	1217	1582	1498
	5	825462	74.5	11	2	1569	1281	-
	6	128265	92.6	11	3	1065	1669	1222
	7	351161	89	11	3	1493	1135	1380
	8	573425	96.5	11	3	1607	1822	1602
	9	798431	70.5	11	2	1141	1178	-
	10	100737	94	11	3	1009	1629	1956
	11	324661	55.8	11	1	1290	-	-
	12	546278	87.7	11	3	1435	1963	1164
25	Type 5	8	1.5	12	5.5665			
	Burst ID	Burst Offset (us)	Pulse Width (us)	Chirp Width (MHz)	Number of Pulses per Burst	PRI-1 (us)	PRI-2 (us)	PRI-3 (us)
	0	1253842	68.6	5	2	1306	1161	-
	1	119486	83.1	5	2	1420	1315	-
	2	482958	60.9	5	1	1687	-	-
	3	845641	77.7	5	2	1776	1158	-
	4	1208428	77.4	5	2	1793	1510	-
	5	74748	66.8	5	2	1576	1323	-
	6	438300	63.7	5	1	1333	-	-
	7	800152	91.2	5	3	1409	1681	1275

Trial ID	Radar Type	Number of Bursts	Burst Period(s)	Wave from Length (s)	Center Frequency(GHz)	-		
26	Type 5	17	0.705882	12	5.5621			
	Burst ID	Burst Offset (us)	Pulse Width (us)	Chirp Width (MHz)	Number of Pulses per Burst	PRI-1 (us)	PRI-2 (us)	PRI-3 (us)
	0	545865	83.6	16	3	1632	1195	1000
	1	14067	89.4	16	3	1173	1627	1656
	2	184953	55.8	16	1	1532	-	-
	3	353759	90.9	16	3	1981	1554	1998
	4	526388	54.7	16	1	1825	-	-
	5	694806	97.7	16	3	1734	1202	1250
	6	163568	67.5	16	2	1571	1434	-
	7	333410	96.7	16	3	1589	1469	1268
	8	504006	68.3	16	2	1750	1954	-
	9	675297	78.3	16	2	1591	1082	-
	10	142890	55	16	1	1427	-	-
	11	312479	84.9	16	3	1129	1936	1199
	12	482953	74.6	16	2	1959	1856	-
	13	655022	63.3	16	1	1885	-	-
	14	121457	99.8	16	3	1035	1515	1120
	15	292606	63.6	16	1	1647	-	-
	16	461322	87.3	16	3	1931	1051	1831



Trial ID	Radar Type	Number of Bursts	Burst Period(s)	Wave from Length (s)	Center Frequency(GHz)	-		
27	Type 5	19	0.631579	12	5.5609			
	Burst ID	Burst Offset (us)	Pulse Width (us)	Chirp Width (MHz)	Number of Pulses per Burst	PRI-1 (us)	PRI-2 (us)	PRI-3 (us)
	0	565136	85.6	19	3	1946	1078	1015
	1	89970	68.6	19	2	1029	1780	-
	2	243121	54.2	19	1	1111	-	-
	3	396034	61.2	19	1	1104	-	-
	4	546225	97.1	19	3	1157	1969	1100
	5	70998	98.3	19	3	1142	1699	1622
	6	224093	62.4	19	1	1655	-	-
	7	376127	80.2	19	2	1126	1769	-
	8	527806	87.5	19	3	1216	1448	1179
	9	52247	85.8	19	3	1847	1348	1472
	10	204582	88.1	19	3	1023	1124	1631
	11	357941	65.3	19	1	1848	-	-
	12	510977	52.5	19	1	1470	-	-
	13	33698	52.3	19	1	1312	-	-
	14	186023	74.1	19	2	1915	1200	-
	15	339327	54.9	19	1	1479	-	-
	16	491053	76.2	19	2	1376	1502	-
	17	14858	60.4	19	1	1758	-	-
	18	167387	81.5	19	2	1491	1103	-

28	Type 5	12	1	12	5.5645			
	Burst ID	Burst Offset (us)	Pulse Width (us)	Chirp Width (MHz)	Number of Pulses per Burst	PRI-1 (us)	PRI-2 (us)	PRI-3 (us)
	0	507709	50.5	10	1	1857	-	-
	1	750249	55.7	10	1	1246	-	-
	2	989003	85.8	10	3	1774	1002	1967
	3	235634	76.9	10	2	1125	1474	-
	4	477675	75.1	10	2	1254	1052	-
	5	718312	92.3	10	3	1180	1486	1492
	6	960895	78.1	10	2	1301	1757	-
	7	205370	92.2	10	3	1898	1252	1713
	8	446940	89	10	3	1260	1706	1411
	9	689225	70.9	10	2	1578	1620	-
	10	932305	63.1	10	1	1782	-	-
	11	176231	55.3	10	1	1522	-	-

Trial ID	Radar Type	Number of Bursts	Burst Period(s)	Wave from Length (s)	Center Frequency(GHz)	-		
29	Type 5	18	0.666667	12	5.5617			
	Burst ID	Burst Offset (us)	Pulse Width (us)	Chirp Width (MHz)	Number of Pulses per Burst	PRI-1 (us)	PRI-2 (us)	PRI-3 (us)
	0	277485	83.4	17	3	1454	1205	1801
	1	437880	97.3	17	3	1319	1826	1635
	2	598445	90.4	17	3	1079	1986	1674
	3	97088	91.8	17	3	1563	1151	1802
	4	257251	98.2	17	3	1876	1977	1766
	5	419893	59.5	17	1	1952	-	-
	6	580724	80	17	2	1253	1137	-
	7	77366	86.5	17	3	1054	1128	1828
	8	238032	91.1	17	3	1105	1599	1442
	9	398605	93.5	17	3	1867	1373	1087
	10	562025	60.7	17	1	1033	-	-
	11	57684	67.2	17	2	1288	1405	-
	12	219083	61.8	17	1	1585	-	-
	13	379234	79.4	17	2	1933	1667	-
	14	540896	81.4	17	2	1096	1464	-
	15	37916	65.7	17	1	1496	-	-
	16	198794	76	17	2	1733	1255	-
	17	359754	81	17	2	1326	1668	-

### Radar Signal 5\_5540 MHz

Trial ID	Radar Type	Number of Bursts	Burst Period(s)	Wave from Length (s)	Center Frequency(GHz)	-		
0	Type 5	15	0.8	12	5.54			
	Burst ID	Burst Offset (us)	Pulse Width (us)	Chirp Width (MHz)	Number of Pulses per Burst	PRI-1 (us)	PRI-2 (us)	PRI-3 (us)
	0	636185	77.8	13	2	1665	1477	-
	1	32674	51.9	13	1	1074	-	-
	2	226294	63.8	13	1	1584	-	-
	3	417976	96.6	13	3	1682	1786	1843
	4	611152	85.9	13	3	1795	1215	1729
	5	8789	73.7	13	2	1198	1549	-
	6	201917	77.2	13	2	1837	1819	-
	7	395530	68.4	13	2	1587	1114	-
	8	588564	76.7	13	2	2000	1155	-
	9	783794	53.2	13	1	1147	-	-
	10	177933	85.7	13	3	1433	1695	1394
	11	370624	94.3	13	3	1670	1426	1935
	12	564893	77.6	13	2	1294	1671	-
	13	759583	65.7	13	1	1512	-	-
	14	154262	93.5	13	3	1444	1130	1468
1	Type 5	8	1.5	12	5.54			
	Burst ID	Burst Offset (us)	Pulse Width (us)	Chirp Width (MHz)	Number of Pulses per Burst	PRI-1 (us)	PRI-2 (us)	PRI-3 (us)
	0	653020	75	5	2	1880	1527	-
	1	1015643	99.4	5	3	1401	1262	1257
	2	1379398	67.4	5	2	1531	1403	-
	3	245489	73.6	5	2	1449	1041	-
	4	609113	65.9	5	1	1432	-	-
	5	970852	83.8	5	3	1356	1292	1419
	6	1335913	65.5	5	1	1543	-	-
	7	200406	98.6	5	3	1548	1796	1728

Trial ID	Radar Type	Number of Bursts	Burst Period(s)	Wave from Length (s)	Center Frequency(GHz)	-		
2	Type 5	11	1.090909	12	5.54			
	Burst ID	Burst Offset (us)	Pulse Width (us)	Chirp Width (MHz)	Number of Pulses per Burst	PRI-1 (us)	PRI-2 (us)	PRI-3 (us)
	0	409565	73.8	9	2	1806	1538	-
	1	673692	69.5	9	2	1117	1649	-
	2	938562	51.9	9	1	1651	-	-
	3	113209	84.6	9	3	1976	1032	1271
	4	376726	95.4	9	3	1060	1903	1388
	5	641212	68	9	2	1368	1351	-
	6	903714	89.6	9	3	1338	1514	1573
	7	80863	81.9	9	2	1022	1689	-
	8	344067	88.3	9	3	1810	1330	1838
	9	609331	53.7	9	1	1597	-	-
	10	871542	91.3	9	3	1961	1106	1001
3	Type 5	20	0.6	12	5.54			
	Burst ID	Burst Offset (us)	Pulse Width (us)	Chirp Width (MHz)	Number of Pulses per Burst	PRI-1 (us)	PRI-2 (us)	PRI-3 (us)
	0	26541	68.1	19	2	1339	1355	-
	1	171821	58.7	19	1	1251	-	-
	2	316229	75.3	19	2	1136	1640	-
	3	461864	56.4	19	1	1753	-	-
	4	8677	99.7	19	3	1196	1708	1159
	5	153995	57.7	19	1	1013	-	-
	6	299238	59.5	19	1	1072	-	-
	7	443177	80	19	2	1482	1369	-
	8	587671	82	19	2	1993	1197	-
	9	135674	82.8	19	2	1883	1005	-
	10	279928	88	19	3	1061	1928	1101
	11	424279	93.2	19	3	1207	1907	1223
	12	570132	70.4	19	2	1526	1360	-
	13	117439	95.3	19	3	1171	1955	1775
	14	262502	81.9	19	2	1690	1545	-
	15	406573	98.5	19	3	1975	1169	1062
	16	553328	65	19	1	1767	-	-
	17	99799	85.4	19	3	1011	1637	1425
	18	244095	91.6	19	3	1878	1445	1325
	19	390012	67.3	19	2	1091	1218	-

Trial ID	Radar Type	Number of Bursts	Burst Period(s)	Wave from Length (s)	Center Frequency(GHz)	-		
4	Type 5	17	0.705882	12	5.54			
	Burst ID	Burst Offset (us)	Pulse Width (us)	Chirp Width (MHz)	Number of Pulses per Burst	PRI-1 (us)	PRI-2 (us)	PRI-3 (us)
	0	629614	67.9	16	2	1320	1133	-
	1	96856	62.3	16	1	1957	-	-
	2	267719	53.3	16	1	1592	-	-
	3	436784	90	16	3	1900	1153	1346
	4	608289	77.1	16	2	1166	1646	-
	5	75610	83.9	16	3	1278	1232	1459
	6	245638	89.1	16	3	1240	1384	1939
	7	416355	81.8	16	2	1833	1676	-
	8	588736	50.3	16	1	1075	-	-
	9	54571	87.1	16	3	1116	1996	1756
	10	225175	71.3	16	2	1225	1815	-
	11	394825	97.5	16	3	1884	1465	1132
	12	565361	90.6	16	3	1561	1040	1354
	13	33643	86.3	16	3	1596	1183	1792
	14	203957	97.6	16	3	1365	1073	1361
	15	373812	84.7	16	3	1021	1718	1854
	16	544060	99.7	16	3	1150	1244	1988

Trial ID	Radar Type	Number of Bursts	Burst Period(s)	Wave from Length (s)	Center Frequency(GHz)	-		
5	Type 5	14	0.857143	12	5.54			
	Burst ID	Burst Offset (us)	Pulse Width (us)	Chirp Width (MHz)	Number of Pulses per Burst	PRI-1 (us)	PRI-2 (us)	PRI-3 (us)
	0	15438	92.9	12	3	1085	1564	1407
	1	222486	67.7	12	2	1744	1747	-
	2	430731	65.8	12	1	1092	-	-
	3	637784	56.3	12	1	1851	-	-
	4	845342	53.7	12	1	1727	-	-
	5	196720	83.5	12	3	1679	1930	1025
	6	404955	65.8	12	1	1519	-	-
	7	610711	85.9	12	3	1134	1034	1808
	8	818057	76.3	12	2	1606	1926	-
	9	171459	81.5	12	2	1891	1714	-
	10	377969	89.4	12	3	1310	1594	1827
	11	586875	63.4	12	1	1568	-	-
	12	792834	69.6	12	2	1307	1925	-
	13	146044	74.5	12	2	1264	1846	-

Trial ID	Radar Type	Number of Bursts	Burst Period(s)	Wave from Length (s)	Center Frequency(GHz)	-		
6	Type 5	15	0.8	12	5.54			
	Burst ID	Burst Offset (us)	Pulse Width (us)	Chirp Width (MHz)	Number of Pulses per Burst	PRI-1 (us)	PRI-2 (us)	PRI-3 (us)
	0	329022	96.6	13	3	1182	1609	1581
	1	521718	96.7	13	3	1829	1799	1154
	2	714222	86.5	13	3	1923	1396	1865
	3	112450	73.3	13	2	1908	1318	-
	4	306283	55.8	13	1	1688	-	-
	5	500239	55.4	13	1	1145	-	-
	6	690932	85.3	13	3	1336	1504	1820
	7	88645	79.4	13	2	1344	1893	-
	8	282508	65.7	13	1	1476	-	-
	9	475842	68.6	13	2	1008	1028	-
	10	667887	77.7	13	2	1972	1835	-
	11	64845	79.6	13	2	1882	1331	-
	12	257755	94.9	13	3	1830	1070	1349
	13	452335	61.4	13	1	1451	-	-
	14	643395	90.6	13	3	1233	1562	1887
7	Type 5	12	1	12	5.54			
	Burst ID	Burst Offset (us)	Pulse Width (us)	Chirp Width (MHz)	Number of Pulses per Burst	PRI-1 (us)	PRI-2 (us)	PRI-3 (us)
	0	51446	52.6	10	1	1210	-	-
	1	292696	84.1	10	3	1314	1725	1529
	2	533989	97.7	10	3	1139	1868	1805
	3	775564	97.3	10	3	1341	1446	1755
	4	21542	98.8	10	3	1544	1386	1302
	5	263385	72.2	10	2	1771	1184	-
	6	505581	67.6	10	2	1175	1027	-
	7	747058	75.7	10	2	1026	1871	-
	8	989976	60.9	10	1	1798	-	-
	9	234024	64.2	10	1	1138	-	-
	10	475207	78.8	10	2	1784	1604	-
	11	715825	87.5	10	3	1511	1712	1683



Trial ID	Radar Type	Number of Bursts	Burst Period(s)	Wave from Length (s)	Center Frequency(GHz)	-		
8	Type 5	14	0.857143	12	5.54			
	Burst ID	Burst Offset (us)	Pulse Width (us)	Chirp Width (MHz)	Number of Pulses per Burst	PRI-1 (us)	PRI-2 (us)	PRI-3 (us)
	0	823112	54.1	13	1	1415	-	-
	1	174965	50.7	13	1	1221	-	-
	2	382216	52.3	13	1	1974	-	-
	3	587395	99.8	13	3	1558	1696	1949
	4	796897	68.4	13	2	1014	1099	-
	5	149042	80.8	13	2	1736	1505	-
	6	356750	62.5	13	1	1778	-	-
	7	563824	74.8	13	2	1149	1204	-
	8	772314	50.8	13	1	1049	-	-
	9	123796	54	13	1	1417	-	-
	10	331215	63	13	1	1730	-	-
	11	537402	91.8	13	3	1143	1270	1347
	12	744805	79.3	13	2	1274	1992	-
	13	98172	64.3	13	1	1937	-	-
9	Type 5	8	1.5	12	5.54			
	Burst ID	Burst Offset (us)	Pulse Width (us)	Chirp Width (MHz)	Number of Pulses per Burst	PRI-1 (us)	PRI-2 (us)	PRI-3 (us)
	0	535615	63.4	6	1	1043	-	-
	1	898668	52	6	1	1863	-	-
	2	1259235	97.2	6	3	1973	1605	1583
	3	127106	78.7	6	2	1466	1743	-
	4	490358	74.2	6	2	1280	1219	-
	5	852409	88.7	6	3	1293	1934	1273
	6	1217152	54.3	6	1	1991	-	-
	7	82296	95.4	6	3	1580	1555	1791

Trial ID	Radar Type	Number of Bursts	Burst Period(s)	Wave from Length (s)	Center Frequency(GHz)	-		
10	Type 5	17	0.705882	12	5.5369			
	Burst ID	Burst Offset (us)	Pulse Width (us)	Chirp Width (MHz)	Number of Pulses per Burst	PRI-1 (us)	PRI-2 (us)	PRI-3 (us)
	0	209249	73.7	16	2	1208	1497	-
	1	378386	97.4	16	3	1942	1754	1613
	2	548411	91.7	16	3	1999	1702	1462
	3	17733	66.2	16	1	1393	-	-
	4	187952	70.8	16	2	1968	1821	-
	5	359277	52.3	16	1	1740	-	-
	6	528886	78.9	16	2	1308	1984	-
	7	700166	70.9	16	2	1050	1358	-
	8	167197	75.6	16	2	1437	1430	-
	9	338262	59.1	16	1	1697	-	-
	10	508324	77	16	2	1397	1304	-
	11	678689	67.9	16	2	1803	1083	-
	12	146031	81.2	16	2	1720	1932	-
	13	316923	78.7	16	2	1247	1121	-
	14	488056	63.3	16	1	1634	-	-
	15	657326	68.9	16	2	1849	1423	-
	16	125509	59.3	16	1	1093	-	-

Trial ID	Radar Type	Number of Bursts	Burst Period(s)	Wave from Length (s)	Center Frequency(GHz)	-		
11	Type 5	19	0.631579	12	5.5381			
	Burst ID	Burst Offset (us)	Pulse Width (us)	Chirp Width (MHz)	Number of Pulses per Burst	PRI-1 (us)	PRI-2 (us)	PRI-3 (us)
	0	263736	98.9	19	3	1381	1680	1488
	1	416459	82.3	19	2	1716	1855	-
	2	567902	86.7	19	3	1211	1400	1919
	3	92979	89.7	19	3	1861	1068	1282
	4	245155	98.6	19	3	1507	1194	1461
	5	397609	71.1	19	2	1921	1789	-
	6	551431	55.9	19	1	1947	-	-
	7	74413	67.9	19	2	1350	1372	-
	8	226559	84.4	19	3	1203	1107	1443
	9	380056	58.8	19	1	1715	-	-
	10	533408	65.6	19	1	1017	-	-
	11	55547	78.5	19	2	1911	1704	-
	12	207876	82.3	19	2	1845	1686	-
	13	359771	90.1	19	3	1938	1071	1266
	14	511297	90.2	19	3	1989	1089	1950
	15	36803	83.1	19	2	1943	1406	-
	16	189652	58.8	19	1	1742	-	-
	17	341809	77	19	2	1187	1657	-
	18	495737	55	19	1	1012	-	-

Trial ID	Radar Type	Number of Bursts	Burst Period(s)	Wave from Length (s)	Center Frequency(GHz)	-		
12	Type 5	15	0.8	12	5.5357			
	Burst ID	Burst Offset (us)	Pulse Width (us)	Chirp Width (MHz)	Number of Pulses per Burst	PRI-1 (us)	PRI-2 (us)	PRI-3 (us)
	0	22911	58.1	13	1	1929	-	-
	1	216473	52.1	13	1	1910	-	-
	2	410004	59.9	13	1	1971	-	-
	3	603671	60.2	13	1	1812	-	-
	4	794160	95.9	13	3	1399	1906	1608
	5	192251	79.9	13	2	1626	1859	-
	6	385590	78.5	13	2	1238	1917	-
	7	579862	53.8	13	1	1763	-	-
	8	773423	64.7	13	1	1800	-	-
	9	168898	61.4	13	1	1390	-	-
	10	361606	83.2	13	2	1692	1858	-
	11	553866	84.7	13	3	1533	1677	1638
	12	747241	88.7	13	3	1703	1528	1058
	13	144710	78.3	13	2	1258	1951	-
	14	337856	69.3	13	2	1731	1717	-
13	Type 5	12	1	12	5.5345			
	Burst ID	Burst Offset (us)	Pulse Width (us)	Chirp Width (MHz)	Number of Pulses per Burst	PRI-1 (us)	PRI-2 (us)	PRI-3 (us)
	0	664275	75.3	10	2	1994	1612	-
	1	907886	56.3	10	1	1456	-	-
	2	151316	67.7	10	2	1617	1185	-
	3	393746	55.6	10	1	1337	-	-
	4	635093	75.2	10	2	1421	1267	-
	5	876993	76.3	10	2	1359	1305	-
	6	121278	85.7	10	3	1547	1362	1924
	7	362696	98.4	10	3	1873	1550	1249
	8	604342	86.4	10	3	1779	1439	1046
	9	846453	93.6	10	3	1059	1031	1452
	10	91871	63.3	10	1	1328	-	-
	11	333050	92.4	10	3	1412	1673	1322

Trial ID	Radar Type	Number of Bursts	Burst Period(s)	Wave from Length (s)	Center Frequency(GHz)	-		
14	Type 5	19	0.631579	12	5.5377			
	Burst ID	Burst Offset (us)	Pulse Width (us)	Chirp Width (MHz)	Number of Pulses per Burst	PRI-1 (us)	PRI-2 (us)	PRI-3 (us)
	0	361323	93.3	18	3	1983	1912	1535
	1	515261	69.1	18	2	1102	1794	-
	2	39025	86.9	18	3	1044	1152	1148
	3	190900	84.9	18	3	1894	1948	1118
	4	343941	72.3	18	2	1094	1916	-
	5	497624	51.7	18	1	1447	-	-
	6	20319	58.3	18	1	1429	-	-
	7	172999	60.8	18	1	1979	-	-
	8	325872	57.1	18	1	1641	-	-
	9	475841	88.9	18	3	1886	1964	1489
	10	1489	72	18	2	1909	1297	-
	11	153647	90.9	18	3	1261	1566	1370
	12	307096	59.8	18	1	1552	-	-
	13	458804	70	18	2	1759	1291	-
	14	610798	67.2	18	2	1625	1881	-
	15	134759	91.2	18	3	1382	1832	1661
	16	288306	56.5	18	1	1483	-	-
	17	441296	51.2	18	1	1237	-	-
	18	592780	74.1	18	2	1471	1245	-

Trial ID	Radar Type	Number of Bursts	Burst Period(s)	Wave from Length (s)	Center Frequency(GHz)	-		
15	Type 5	14	0.857143	12	5.5353			
	Burst ID	Burst Offset (us)	Pulse Width (us)	Chirp Width (MHz)	Number of Pulses per Burst	PRI-1 (us)	PRI-2 (us)	PRI-3 (us)
	0	158286	76.9	12	2	1110	1140	-
	1	366024	50.2	12	1	1316	-	-
	2	573452	62.9	12	1	1520	-	-
	3	780619	64.7	12	1	1902	-	-
	4	132455	83.8	12	3	1410	1097	1621
	5	340207	65.4	12	1	1944	-	-
	6	548208	53.2	12	1	1024	-	-
	7	755333	51.7	12	1	1603	-	-
	8	107117	78.7	12	2	1804	1168	-
	9	314500	72.4	12	2	1030	1343	-
	10	522447	53.8	12	1	1327	-	-
	11	728517	73.6	12	2	1524	1553	-
	12	81611	66.7	12	2	1722	1122	-
	13	288948	82.5	12	2	1404	1019	-

Trial ID	Radar Type	Number of Bursts	Burst Period(s)	Wave from Length (s)	Center Frequency(GHz)	-		
16	Type 5	20	0.6	12	5.5385			
	Burst ID	Burst Offset (us)	Pulse Width (us)	Chirp Width (MHz)	Number of Pulses per Burst	PRI-1 (us)	PRI-2 (us)	PRI-3 (us)
	0	345766	87.6	20	3	1565	1055	1840
	1	490019	85.2	20	3	1735	1541	1408
	2	39073	84.8	20	3	1534	1889	1463
	3	183923	77.9	20	2	1749	1460	-
	4	328777	76.5	20	2	1518	1485	-
	5	474728	60.9	20	1	1540	-	-
	6	21394	83	20	2	1080	1010	-
	7	165992	80.4	20	2	1824	1752	-
	8	310973	67.5	20	2	1764	1181	-
	9	456884	62.1	20	1	1495	-	-
	10	3515	86.4	20	3	1773	1966	1263
	11	147928	84.3	20	3	1593	1188	1788
	12	293225	76.9	20	2	1226	1537	-
	13	436922	95.8	20	3	1192	1298	1844
	14	584015	55.2	20	1	1644	-	-
	15	130832	59	20	1	1402	-	-
	16	274684	94.5	20	3	1296	1700	1283
	17	418579	91.9	20	3	1970	1978	1165
	18	563464	85.2	20	3	1732	1551	1189
	19	112787	69.5	20	2	1038	1224	-

Trial ID	Radar Type	Number of Bursts	Burst Period(s)	Wave from Length (s)	Center Frequency(GHz)	-		
17	Type 5	12	1	12	5.5345			
	Burst ID	Burst Offset (us)	Pulse Width (us)	Chirp Width (MHz)	Number of Pulses per Burst	PRI-1 (us)	PRI-2 (us)	PRI-3 (us)
	0	429224	86.4	10	3	1259	1918	1455
	1	670241	92.2	10	3	1598	1719	1895
	2	912880	80.4	10	2	1816	1899	-
	3	158603	54.3	10	1	1335	-	-
	4	400824	53.1	10	1	1303	-	-
	5	641915	69.4	10	2	1503	1546	-
	6	883823	69.1	10	2	1279	1639	-
	7	128373	100	10	3	1375	1438	1595
	8	370379	79.6	10	2	1239	1705	-
	9	611194	88.4	10	3	1374	1579	1623
	10	855665	53.3	10	1	1016	-	-
	11	98897	65.3	10	1	1709	-	-



Trial ID	Radar Type	Number of Bursts	Burst Period(s)	Wave from Length (s)	Center Frequency(GHz)	-		
18	Type 5	14	0.857143	12	5.5353			
	Burst ID	Burst Offset (us)	Pulse Width (us)	Chirp Width (MHz)	Number of Pulses per Burst	PRI-1 (us)	PRI-2 (us)	PRI-3 (us)
	0	292143	55.3	12	1	1920	-	-
	1	499633	58.3	12	1	1797	-	-
	2	706377	72.3	12	2	1610	1039	-
	3	58989	84.8	12	3	1131	1761	1721
	4	266161	82.5	12	2	1875	1431	-
	5	474469	63.3	12	1	1095	-	-
	6	680544	80	12	2	1119	1913	-
	7	33519	90.3	12	3	1660	1853	1123
	8	240319	91.1	12	3	1539	1783	1172
	9	447400	96.6	12	3	1525	1036	1385
	10	654516	82.7	12	2	1710	1990	-
	11	8083	50.7	12	1	1234	-	-
	12	215435	78.4	12	2	1047	1109	-
	13	421325	99.5	12	3	1299	1965	1869
19	Type 5	12	1	12	5.5345			
	Burst ID	Burst Offset (us)	Pulse Width (us)	Chirp Width (MHz)	Number of Pulses per Burst	PRI-1 (us)	PRI-2 (us)	PRI-3 (us)
	0	733725	88.6	10	3	1501	1067	1927
	1	977882	57.4	10	1	1723	-	-
	2	221197	96.6	10	3	1086	1658	1324
	3	462915	69.7	10	2	1751	1945	-
	4	705071	77.9	10	2	1642	1317	-
	5	947923	62	10	1	1866	-	-
	6	191373	88.4	10	3	1997	1077	1366
	7	432561	97.3	10	3	1790	1896	1367
	8	674004	96.2	10	3	1391	1787	1672
	9	915842	95.4	10	3	1020	1892	1414
	10	162176	54.8	10	1	1084	-	-
	11	403553	80.4	10	2	1850	1436	-

Trial ID	Radar Type	Number of Bursts	Burst Period(s)	Wave from Length (s)	Center Frequency(GHz)	-		
20	Type 5	16	0.75	12	5.5435			
	Burst ID	Burst Offset (us)	Pulse Width (us)	Chirp Width (MHz)	Number of Pulses per Burst	PRI-1 (us)	PRI-2 (us)	PRI-3 (us)
	0	483470	74.7	15	2	1619	1611	-
	1	666072	57.1	15	1	1560	-	-
	2	98810	91.9	15	3	1392	1475	1276
	3	279914	83.1	15	2	1809	1772	-
	4	462536	50.7	15	1	1003	-	-
	5	642324	79.2	15	2	1574	1600	-
	6	76831	58.7	15	1	1186	-	-
	7	257785	71	15	2	1521	1567	-
	8	438554	79	15	2	1777	1960	-
	9	620397	68.5	15	2	1284	1428	-
	10	54310	73.5	15	2	1904	1352	-
	11	235506	70.5	15	2	1864	1115	-
	12	417036	76.6	15	2	1045	1300	-
	13	597974	81.2	15	2	1160	1675	-
	14	32086	61.8	15	1	1277	-	-
	15	212751	94.9	15	3	1450	1206	1860
21	Type 5	12	1	12	5.5459			
	Burst ID	Burst Offset (us)	Pulse Width (us)	Chirp Width (MHz)	Number of Pulses per Burst	PRI-1 (us)	PRI-2 (us)	PRI-3 (us)
	0	526149	78.5	9	2	1653	1698	-
	1	767135	89.8	9	3	1174	1962	1167
	2	12955	59.4	9	1	1982	-	-
	3	254612	79.6	9	2	1633	1890	-
	4	496588	76	9	2	1112	1811	-
	5	739728	53.6	9	1	1144	-	-
	6	980872	80.9	9	2	1220	1053	-
	7	225249	61.6	9	1	1724	-	-
	8	467279	53.4	9	1	1901	-	-
	9	709720	59.9	9	1	1379	-	-
	10	951847	60.4	9	1	1453	-	-
	11	194839	91.4	9	3	1768	1726	1227

Trial ID	Radar Type	Number of Bursts	Burst Period(s)	Wave from Length (s)	Center Frequency(GHz)	-		
22	Type 5	20	0.6	12	5.5415			
	Burst ID	Burst Offset (us)	Pulse Width (us)	Chirp Width (MHz)	Number of Pulses per Burst	PRI-1 (us)	PRI-2 (us)	PRI-3 (us)
	0	261858	77	20	2	1191	1363	-
	1	407646	58.1	20	1	1248	-	-
	2	552319	62.1	20	1	1836	-	-
	3	99107	76.9	20	2	1334	1236	-
	4	243514	80	20	2	1914	1852	-
	5	389464	52	20	1	1701	-	-
	6	531093	88.6	20	3	1693	1995	1905
	7	81159	72.9	20	2	1922	1387	-
	8	225245	98.5	20	3	1839	1746	1389
	9	371906	57.9	20	1	1193	-	-
	10	514197	95.9	20	3	1659	1870	1066
	11	63561	53.5	20	1	1162	-	-
	12	207510	92	20	3	1745	1654	1458
	13	353638	57.3	20	1	1834	-	-
	14	497515	70.5	20	2	1684	1586	-
	15	45553	70	20	2	1042	1664	-
	16	189821	84	20	3	1765	1630	1176
	17	335330	76.1	20	2	1557	1057	-
	18	478825	93.2	20	3	1985	1018	1340
	19	27594	96.8	20	3	1760	1614	1817

Trial ID	Radar Type	Number of Bursts	Burst Period(s)	Wave from Length (s)	Center Frequency(GHz)	-		
23	Type 5	14	0.857143	12	5.5447			
	Burst ID	Burst Offset (us)	Pulse Width (us)	Chirp Width (MHz)	Number of Pulses per Burst	PRI-1 (us)	PRI-2 (us)	PRI-3 (us)
	0	247117	50.1	12	1	1841	-	-
	1	453362	93.5	12	3	1590	1081	1413
	2	660875	68.8	12	2	1707	1577	-
	3	14140	56.3	12	1	1056	-	-
	4	220734	86	12	3	1953	1108	1987
	5	428367	75.2	12	2	1572	1536	-
	6	636681	54.4	12	1	1517	-	-
	7	843157	71.1	12	2	1329	1243	-
	8	195585	76.2	12	2	1940	1770	-
	9	403231	80.2	12	2	1098	1209	-
	10	610202	79.7	12	2	1588	1214	-
	11	815229	90.9	12	3	1615	1862	1601
	12	170267	68.7	12	2	1377	1441	-
	13	377306	67.4	12	2	1872	1313	-

Trial ID	Radar Type	Number of Bursts	Burst Period(s)	Wave from Length (s)	Center Frequency(GHz)	-		
24	Type 5	13	0.923077	12	5.5451			
	Burst ID	Burst Offset (us)	Pulse Width (us)	Chirp Width (MHz)	Number of Pulses per Burst	PRI-1 (us)	PRI-2 (us)	PRI-3 (us)
	0	628071	94	11	3	1643	1748	1941
	1	853391	70.8	11	2	1177	1201	-
	2	156223	56.3	11	1	1006	-	-
	3	378734	96.7	11	3	1230	1163	1332
	4	601331	90.6	11	3	1217	1582	1498
	5	825462	74.5	11	2	1569	1281	-
	6	128265	92.6	11	3	1065	1669	1222
	7	351161	89	11	3	1493	1135	1380
	8	573425	96.5	11	3	1607	1822	1602
	9	798431	70.5	11	2	1141	1178	-
	10	100737	94	11	3	1009	1629	1956
	11	324661	55.8	11	1	1290	-	-
	12	546278	87.7	11	3	1435	1963	1164
25	Type 5	8	1.5	12	5.5475			
	Burst ID	Burst Offset (us)	Pulse Width (us)	Chirp Width (MHz)	Number of Pulses per Burst	PRI-1 (us)	PRI-2 (us)	PRI-3 (us)
	0	1253842	68.6	5	2	1306	1161	-
	1	119486	83.1	5	2	1420	1315	-
	2	482958	60.9	5	1	1687	-	-
	3	845641	77.7	5	2	1776	1158	-
	4	1208428	77.4	5	2	1793	1510	-
	5	74748	66.8	5	2	1576	1323	-
	6	438300	63.7	5	1	1333	-	-
	7	800152	91.2	5	3	1409	1681	1275

Trial ID	Radar Type	Number of Bursts	Burst Period(s)	Wave from Length (s)	Center Frequency(GHz)	-		
26	Type 5	17	0.705882	12	5.5431			
	Burst ID	Burst Offset (us)	Pulse Width (us)	Chirp Width (MHz)	Number of Pulses per Burst	PRI-1 (us)	PRI-2 (us)	PRI-3 (us)
	0	545865	83.6	16	3	1632	1195	1000
	1	14067	89.4	16	3	1173	1627	1656
	2	184953	55.8	16	1	1532	-	-
	3	353759	90.9	16	3	1981	1554	1998
	4	526388	54.7	16	1	1825	-	-
	5	694806	97.7	16	3	1734	1202	1250
	6	163568	67.5	16	2	1571	1434	-
	7	333410	96.7	16	3	1589	1469	1268
	8	504006	68.3	16	2	1750	1954	-
	9	675297	78.3	16	2	1591	1082	-
	10	142890	55	16	1	1427	-	-
	11	312479	84.9	16	3	1129	1936	1199
	12	482953	74.6	16	2	1959	1856	-
	13	655022	63.3	16	1	1885	-	-
	14	121457	99.8	16	3	1035	1515	1120
	15	292606	63.6	16	1	1647	-	-
	16	461322	87.3	16	3	1931	1051	1831

Trial ID	Radar Type	Number of Bursts	Burst Period(s)	Wave from Length (s)	Center Frequency(GHz)	-		
27	Type 5	19	0.631579	12	5.5419			
	Burst ID	Burst Offset (us)	Pulse Width (us)	Chirp Width (MHz)	Number of Pulses per Burst	PRI-1 (us)	PRI-2 (us)	PRI-3 (us)
	0	565136	85.6	19	3	1946	1078	1015
	1	89970	68.6	19	2	1029	1780	-
	2	243121	54.2	19	1	1111	-	-
	3	396034	61.2	19	1	1104	-	-
	4	546225	97.1	19	3	1157	1969	1100
	5	70998	98.3	19	3	1142	1699	1622
	6	224093	62.4	19	1	1655	-	-
	7	376127	80.2	19	2	1126	1769	-
	8	527806	87.5	19	3	1216	1448	1179
	9	52247	85.8	19	3	1847	1348	1472
	10	204582	88.1	19	3	1023	1124	1631
	11	357941	65.3	19	1	1848	-	-
	12	510977	52.5	19	1	1470	-	-
	13	33698	52.3	19	1	1312	-	-
	14	186023	74.1	19	2	1915	1200	-
	15	339327	54.9	19	1	1479	-	-
	16	491053	76.2	19	2	1376	1502	-
	17	14858	60.4	19	1	1758	-	-
	18	167387	81.5	19	2	1491	1103	-

Trial ID	Radar Type	Number of Bursts	Burst Period(s)	Wave from Length (s)	Center Frequency(GHz)	-		
28	Type 5	12	1	12	5.5455			
	Burst ID	Burst Offset (us)	Pulse Width (us)	Chirp Width (MHz)	Number of Pulses per Burst	PRI-1 (us)	PRI-2 (us)	PRI-3 (us)
	0	507709	50.5	10	1	1857	-	-
	1	750249	55.7	10	1	1246	-	-
	2	989003	85.8	10	3	1774	1002	1967
	3	235634	76.9	10	2	1125	1474	-
	4	477675	75.1	10	2	1254	1052	-
	5	718312	92.3	10	3	1180	1486	1492
	6	960895	78.1	10	2	1301	1757	-
	7	205370	92.2	10	3	1898	1252	1713
	8	446940	89	10	3	1260	1706	1411
	9	689225	70.9	10	2	1578	1620	-
	10	932305	63.1	10	1	1782	-	-
	11	176231	55.3	10	1	1522	-	-



Trial ID	Radar Type	Number of Bursts	Burst Period(s)	Wave from Length (s)	Center Frequency(GHz)	-		
29	Type 5	18	0.666667	12	5.5427			
	Burst ID	Burst Offset (us)	Pulse Width (us)	Chirp Width (MHz)	Number of Pulses per Burst	PRI-1 (us)	PRI-2 (us)	PRI-3 (us)
	0	277485	83.4	17	3	1454	1205	1801
	1	437880	97.3	17	3	1319	1826	1635
	2	598445	90.4	17	3	1079	1986	1674
	3	97088	91.8	17	3	1563	1151	1802
	4	257251	98.2	17	3	1876	1977	1766
	5	419893	59.5	17	1	1952	-	-
	6	580724	80	17	2	1253	1137	-
	7	77366	86.5	17	3	1054	1128	1828
	8	238032	91.1	17	3	1105	1599	1442
	9	398605	93.5	17	3	1867	1373	1087
	10	562025	60.7	17	1	1033	-	-
	11	57684	67.2	17	2	1288	1405	-
	12	219083	61.8	17	1	1585	-	-
	13	379234	79.4	17	2	1933	1667	-
	14	540896	81.4	17	2	1096	1464	-
	15	37916	65.7	17	1	1496	-	-
	16	198794	76	17	2	1733	1255	-
	17	359754	81	17	2	1326	1668	-

### Radar Signal 5\_5550 MHz

Trial ID	Radar Type	Number of Bursts	Burst Period(s)	Wave from Length (s)	Center Frequency(GHz)	-		
0	Type 5	15	0.8	12	5.55			
	Burst ID	Burst Offset (us)	Pulse Width (us)	Chirp Width (MHz)	Number of Pulses per Burst	PRI-1 (us)	PRI-2 (us)	PRI-3 (us)
	0	636185	77.8	13	2	1665	1477	-
	1	32674	51.9	13	1	1074	-	-
	2	226294	63.8	13	1	1584	-	-
	3	417976	96.6	13	3	1682	1786	1843
	4	611152	85.9	13	3	1795	1215	1729
	5	8789	73.7	13	2	1198	1549	-
	6	201917	77.2	13	2	1837	1819	-
	7	395530	68.4	13	2	1587	1114	-
	8	588564	76.7	13	2	2000	1155	-
	9	783794	53.2	13	1	1147	-	-
	10	177933	85.7	13	3	1433	1695	1394
	11	370624	94.3	13	3	1670	1426	1935
	12	564893	77.6	13	2	1294	1671	-
	13	759583	65.7	13	1	1512	-	-
	14	154262	93.5	13	3	1444	1130	1468
1	Type 5	8	1.5	12	5.55			
	Burst ID	Burst Offset (us)	Pulse Width (us)	Chirp Width (MHz)	Number of Pulses per Burst	PRI-1 (us)	PRI-2 (us)	PRI-3 (us)
	0	653020	75	5	2	1880	1527	-
	1	1015643	99.4	5	3	1401	1262	1257
	2	1379398	67.4	5	2	1531	1403	-
	3	245489	73.6	5	2	1449	1041	-
	4	609113	65.9	5	1	1432	-	-
	5	970852	83.8	5	3	1356	1292	1419
	6	1335913	65.5	5	1	1543	-	-
	7	200406	98.6	5	3	1548	1796	1728

Trial ID	Radar Type	Number of Bursts	Burst Period(s)	Wave from Length (s)	Center Frequency(GHz)	-		
2	Type 5	11	1.090909	12	5.55			
	Burst ID	Burst Offset (us)	Pulse Width (us)	Chirp Width (MHz)	Number of Pulses per Burst	PRI-1 (us)	PRI-2 (us)	PRI-3 (us)
	0	409565	73.8	9	2	1806	1538	-
	1	673692	69.5	9	2	1117	1649	-
	2	938562	51.9	9	1	1651	-	-
	3	113209	84.6	9	3	1976	1032	1271
	4	376726	95.4	9	3	1060	1903	1388
	5	641212	68	9	2	1368	1351	-
	6	903714	89.6	9	3	1338	1514	1573
	7	80863	81.9	9	2	1022	1689	-
	8	344067	88.3	9	3	1810	1330	1838
	9	609331	53.7	9	1	1597	-	-
	10	871542	91.3	9	3	1961	1106	1001
3	Type 5	20	0.6	12	5.55			
	Burst ID	Burst Offset (us)	Pulse Width (us)	Chirp Width (MHz)	Number of Pulses per Burst	PRI-1 (us)	PRI-2 (us)	PRI-3 (us)
	0	26541	68.1	19	2	1339	1355	-
	1	171821	58.7	19	1	1251	-	-
	2	316229	75.3	19	2	1136	1640	-
	3	461864	56.4	19	1	1753	-	-
	4	8677	99.7	19	3	1196	1708	1159
	5	153995	57.7	19	1	1013	-	-
	6	299238	59.5	19	1	1072	-	-
	7	443177	80	19	2	1482	1369	-
	8	587671	82	19	2	1993	1197	-
	9	135674	82.8	19	2	1883	1005	-
	10	279928	88	19	3	1061	1928	1101
	11	424279	93.2	19	3	1207	1907	1223
	12	570132	70.4	19	2	1526	1360	-
	13	117439	95.3	19	3	1171	1955	1775
	14	262502	81.9	19	2	1690	1545	-
	15	406573	98.5	19	3	1975	1169	1062
	16	553328	65	19	1	1767	-	-
	17	99799	85.4	19	3	1011	1637	1425
	18	244095	91.6	19	3	1878	1445	1325
	19	390012	67.3	19	2	1091	1218	-

Trial ID	Radar Type	Number of Bursts	Burst Period(s)	Wave from Length (s)	Center Frequency(GHz)	-		
4	Type 5	17	0.705882	12	5.55			
	Burst ID	Burst Offset (us)	Pulse Width (us)	Chirp Width (MHz)	Number of Pulses per Burst	PRI-1 (us)	PRI-2 (us)	PRI-3 (us)
	0	629614	67.9	16	2	1320	1133	-
	1	96856	62.3	16	1	1957	-	-
	2	267719	53.3	16	1	1592	-	-
	3	436784	90	16	3	1900	1153	1346
	4	608289	77.1	16	2	1166	1646	-
	5	75610	83.9	16	3	1278	1232	1459
	6	245638	89.1	16	3	1240	1384	1939
	7	416355	81.8	16	2	1833	1676	-
	8	588736	50.3	16	1	1075	-	-
	9	54571	87.1	16	3	1116	1996	1756
	10	225175	71.3	16	2	1225	1815	-
	11	394825	97.5	16	3	1884	1465	1132
	12	565361	90.6	16	3	1561	1040	1354
	13	33643	86.3	16	3	1596	1183	1792
	14	203957	97.6	16	3	1365	1073	1361
	15	373812	84.7	16	3	1021	1718	1854
	16	544060	99.7	16	3	1150	1244	1988

Trial ID	Radar Type	Number of Bursts	Burst Peried(s)	Wave from Length (s)	Center Frequency(GHz)	-		
5	Type 5	14	0.857143	12	5.55			
	Burst ID	Burst Offset (us)	Pulse Width (us)	Chirp Width (MHz)	Number of Pulses per Burst	PRI-1 (us)	PRI-2 (us)	PRI-3 (us)
	0	15438	92.9	12	3	1085	1564	1407
	1	222486	67.7	12	2	1744	1747	-
	2	430731	65.8	12	1	1092	-	-
	3	637784	56.3	12	1	1851	-	-
	4	845342	53.7	12	1	1727	-	-
	5	196720	83.5	12	3	1679	1930	1025
	6	404955	65.8	12	1	1519	-	-
	7	610711	85.9	12	3	1134	1034	1808
	8	818057	76.3	12	2	1606	1926	-
	9	171459	81.5	12	2	1891	1714	-
	10	377969	89.4	12	3	1310	1594	1827
	11	586875	63.4	12	1	1568	-	-
	12	792834	69.6	12	2	1307	1925	-
	13	146044	74.5	12	2	1264	1846	-

Trial ID	Radar Type	Number of Bursts	Burst Period(s)	Wave from Length (s)	Center Frequency(GHz)	-		
6	Type 5	15	0.8	12	5.55			
	Burst ID	Burst Offset (us)	Pulse Width (us)	Chirp Width (MHz)	Number of Pulses per Burst	PRI-1 (us)	PRI-2 (us)	PRI-3 (us)
	0	329022	96.6	13	3	1182	1609	1581
	1	521718	96.7	13	3	1829	1799	1154
	2	714222	86.5	13	3	1923	1396	1865
	3	112450	73.3	13	2	1908	1318	-
	4	306283	55.8	13	1	1688	-	-
	5	500239	55.4	13	1	1145	-	-
	6	690932	85.3	13	3	1336	1504	1820
	7	88645	79.4	13	2	1344	1893	-
	8	282508	65.7	13	1	1476	-	-
	9	475842	68.6	13	2	1008	1028	-
	10	667887	77.7	13	2	1972	1835	-
	11	64845	79.6	13	2	1882	1331	-
	12	257755	94.9	13	3	1830	1070	1349
	13	452335	61.4	13	1	1451	-	-
	14	643395	90.6	13	3	1233	1562	1887
7	Type 5	12	1	12	5.55			
	Burst ID	Burst Offset (us)	Pulse Width (us)	Chirp Width (MHz)	Number of Pulses per Burst	PRI-1 (us)	PRI-2 (us)	PRI-3 (us)
	0	51446	52.6	10	1	1210	-	-
	1	292696	84.1	10	3	1314	1725	1529
	2	533989	97.7	10	3	1139	1868	1805
	3	775564	97.3	10	3	1341	1446	1755
	4	21542	98.8	10	3	1544	1386	1302
	5	263385	72.2	10	2	1771	1184	-
	6	505581	67.6	10	2	1175	1027	-
	7	747058	75.7	10	2	1026	1871	-
	8	989976	60.9	10	1	1798	-	-
	9	234024	64.2	10	1	1138	-	-
	10	475207	78.8	10	2	1784	1604	-
	11	715825	87.5	10	3	1511	1712	1683

Trial ID	Radar Type	Number of Bursts	Burst Period(s)	Wave from Length (s)	Center Frequency(GHz)	-		
8	Type 5	14	0.857143	12	5.55			
	Burst ID	Burst Offset (us)	Pulse Width (us)	Chirp Width (MHz)	Number of Pulses per Burst	PRI-1 (us)	PRI-2 (us)	PRI-3 (us)
	0	823112	54.1	13	1	1415	-	-
	1	174965	50.7	13	1	1221	-	-
	2	382216	52.3	13	1	1974	-	-
	3	587395	99.8	13	3	1558	1696	1949
	4	796897	68.4	13	2	1014	1099	-
	5	149042	80.8	13	2	1736	1505	-
	6	356750	62.5	13	1	1778	-	-
	7	563824	74.8	13	2	1149	1204	-
	8	772314	50.8	13	1	1049	-	-
	9	123796	54	13	1	1417	-	-
	10	331215	63	13	1	1730	-	-
	11	537402	91.8	13	3	1143	1270	1347
	12	744805	79.3	13	2	1274	1992	-
	13	98172	64.3	13	1	1937	-	-
9	Type 5	8	1.5	12	5.55			
	Burst ID	Burst Offset (us)	Pulse Width (us)	Chirp Width (MHz)	Number of Pulses per Burst	PRI-1 (us)	PRI-2 (us)	PRI-3 (us)
	0	535615	63.4	6	1	1043	-	-
	1	898668	52	6	1	1863	-	-
	2	1259235	97.2	6	3	1973	1605	1583
	3	127106	78.7	6	2	1466	1743	-
	4	490358	74.2	6	2	1280	1219	-
	5	852409	88.7	6	3	1293	1934	1273
	6	1217152	54.3	6	1	1991	-	-
	7	82296	95.4	6	3	1580	1555	1791

Trial ID	Radar Type	Number of Bursts	Burst Period(s)	Wave from Length (s)	Center Frequency(GHz)	-		
10	Type 5	17	0.705882	12	5.5379			
	Burst ID	Burst Offset (us)	Pulse Width (us)	Chirp Width (MHz)	Number of Pulses per Burst	PRI-1 (us)	PRI-2 (us)	PRI-3 (us)
	0	209249	73.7	16	2	1208	1497	-
	1	378386	97.4	16	3	1942	1754	1613
	2	548411	91.7	16	3	1999	1702	1462
	3	17733	66.2	16	1	1393	-	-
	4	187952	70.8	16	2	1968	1821	-
	5	359277	52.3	16	1	1740	-	-
	6	528886	78.9	16	2	1308	1984	-
	7	700166	70.9	16	2	1050	1358	-
	8	167197	75.6	16	2	1437	1430	-
	9	338262	59.1	16	1	1697	-	-
	10	508324	77	16	2	1397	1304	-
	11	678689	67.9	16	2	1803	1083	-
	12	146031	81.2	16	2	1720	1932	-
	13	316923	78.7	16	2	1247	1121	-
	14	488056	63.3	16	1	1634	-	-
	15	657326	68.9	16	2	1849	1423	-
	16	125509	59.3	16	1	1093	-	-



Trial ID	Radar Type	Number of Bursts	Burst Period(s)	Wave from Length (s)	Center Frequency(GHz)	-		
11	Type 5	19	0.631579	12	5.5391			
	Burst ID	Burst Offset (us)	Pulse Width (us)	Chirp Width (MHz)	Number of Pulses per Burst	PRI-1 (us)	PRI-2 (us)	PRI-3 (us)
	0	263736	98.9	19	3	1381	1680	1488
	1	416459	82.3	19	2	1716	1855	-
	2	567902	86.7	19	3	1211	1400	1919
	3	92979	89.7	19	3	1861	1068	1282
	4	245155	98.6	19	3	1507	1194	1461
	5	397609	71.1	19	2	1921	1789	-
	6	551431	55.9	19	1	1947	-	-
	7	74413	67.9	19	2	1350	1372	-
	8	226559	84.4	19	3	1203	1107	1443
	9	380056	58.8	19	1	1715	-	-
	10	533408	65.6	19	1	1017	-	-
	11	55547	78.5	19	2	1911	1704	-
	12	207876	82.3	19	2	1845	1686	-
	13	359771	90.1	19	3	1938	1071	1266
	14	511297	90.2	19	3	1989	1089	1950
	15	36803	83.1	19	2	1943	1406	-
	16	189652	58.8	19	1	1742	-	-
	17	341809	77	19	2	1187	1657	-
	18	495737	55	19	1	1012	-	-

Trial ID	Radar Type	Number of Bursts	Burst Period(s)	Wave from Length (s)	Center Frequency(GHz)	-		
12	Type 5	15	0.8	12	5.5367			
	Burst ID	Burst Offset (us)	Pulse Width (us)	Chirp Width (MHz)	Number of Pulses per Burst	PRI-1 (us)	PRI-2 (us)	PRI-3 (us)
	0	22911	58.1	13	1	1929	-	-
	1	216473	52.1	13	1	1910	-	-
	2	410004	59.9	13	1	1971	-	-
	3	603671	60.2	13	1	1812	-	-
	4	794160	95.9	13	3	1399	1906	1608
	5	192251	79.9	13	2	1626	1859	-
	6	385590	78.5	13	2	1238	1917	-
	7	579862	53.8	13	1	1763	-	-
	8	773423	64.7	13	1	1800	-	-
	9	168898	61.4	13	1	1390	-	-
	10	361606	83.2	13	2	1692	1858	-
	11	553866	84.7	13	3	1533	1677	1638
	12	747241	88.7	13	3	1703	1528	1058
	13	144710	78.3	13	2	1258	1951	-
	14	337856	69.3	13	2	1731	1717	-
13	Type 5	12	1	12	5.5355			
	Burst ID	Burst Offset (us)	Pulse Width (us)	Chirp Width (MHz)	Number of Pulses per Burst	PRI-1 (us)	PRI-2 (us)	PRI-3 (us)
	0	664275	75.3	10	2	1994	1612	-
	1	907886	56.3	10	1	1456	-	-
	2	151316	67.7	10	2	1617	1185	-
	3	393746	55.6	10	1	1337	-	-
	4	635093	75.2	10	2	1421	1267	-
	5	876993	76.3	10	2	1359	1305	-
	6	121278	85.7	10	3	1547	1362	1924
	7	362696	98.4	10	3	1873	1550	1249
	8	604342	86.4	10	3	1779	1439	1046
	9	846453	93.6	10	3	1059	1031	1452
	10	91871	63.3	10	1	1328	-	-
	11	333050	92.4	10	3	1412	1673	1322

Trial ID	Radar Type	Number of Bursts	Burst Period(s)	Wave from Length (s)	Center Frequency(GHz)	-		
14	Type 5	19	0.631579	12	5.5387			
	Burst ID	Burst Offset (us)	Pulse Width (us)	Chirp Width (MHz)	Number of Pulses per Burst	PRI-1 (us)	PRI-2 (us)	PRI-3 (us)
	0	361323	93.3	18	3	1983	1912	1535
	1	515261	69.1	18	2	1102	1794	-
	2	39025	86.9	18	3	1044	1152	1148
	3	190900	84.9	18	3	1894	1948	1118
	4	343941	72.3	18	2	1094	1916	-
	5	497624	51.7	18	1	1447	-	-
	6	20319	58.3	18	1	1429	-	-
	7	172999	60.8	18	1	1979	-	-
	8	325872	57.1	18	1	1641	-	-
	9	475841	88.9	18	3	1886	1964	1489
	10	1489	72	18	2	1909	1297	-
	11	153647	90.9	18	3	1261	1566	1370
	12	307096	59.8	18	1	1552	-	-
	13	458804	70	18	2	1759	1291	-
	14	610798	67.2	18	2	1625	1881	-
	15	134759	91.2	18	3	1382	1832	1661
	16	288306	56.5	18	1	1483	-	-
	17	441296	51.2	18	1	1237	-	-
	18	592780	74.1	18	2	1471	1245	-

Trial ID	Radar Type	Number of Bursts	Burst Period(s)	Wave from Length (s)	Center Frequency(GHz)	-		
15	Type 5	14	0.857143	12	5.5363			
	Burst ID	Burst Offset (us)	Pulse Width (us)	Chirp Width (MHz)	Number of Pulses per Burst	PRI-1 (us)	PRI-2 (us)	PRI-3 (us)
	0	158286	76.9	12	2	1110	1140	-
	1	366024	50.2	12	1	1316	-	-
	2	573452	62.9	12	1	1520	-	-
	3	780619	64.7	12	1	1902	-	-
	4	132455	83.8	12	3	1410	1097	1621
	5	340207	65.4	12	1	1944	-	-
	6	548208	53.2	12	1	1024	-	-
	7	755333	51.7	12	1	1603	-	-
	8	107117	78.7	12	2	1804	1168	-
	9	314500	72.4	12	2	1030	1343	-
	10	522447	53.8	12	1	1327	-	-
	11	728517	73.6	12	2	1524	1553	-
	12	81611	66.7	12	2	1722	1122	-
	13	288948	82.5	12	2	1404	1019	-

Trial ID	Radar Type	Number of Bursts	Burst Period(s)	Wave from Length (s)	Center Frequency(GHz)	-		
16	Type 5	20	0.6	12	5.5395			
	Burst ID	Burst Offset (us)	Pulse Width (us)	Chirp Width (MHz)	Number of Pulses per Burst	PRI-1 (us)	PRI-2 (us)	PRI-3 (us)
	0	345766	87.6	20	3	1565	1055	1840
	1	490019	85.2	20	3	1735	1541	1408
	2	39073	84.8	20	3	1534	1889	1463
	3	183923	77.9	20	2	1749	1460	-
	4	328777	76.5	20	2	1518	1485	-
	5	474728	60.9	20	1	1540	-	-
	6	21394	83	20	2	1080	1010	-
	7	165992	80.4	20	2	1824	1752	-
	8	310973	67.5	20	2	1764	1181	-
	9	456884	62.1	20	1	1495	-	-
	10	3515	86.4	20	3	1773	1966	1263
	11	147928	84.3	20	3	1593	1188	1788
	12	293225	76.9	20	2	1226	1537	-
	13	436922	95.8	20	3	1192	1298	1844
	14	584015	55.2	20	1	1644	-	-
	15	130832	59	20	1	1402	-	-
	16	274684	94.5	20	3	1296	1700	1283
	17	418579	91.9	20	3	1970	1978	1165
	18	563464	85.2	20	3	1732	1551	1189
	19	112787	69.5	20	2	1038	1224	-

Trial ID	Radar Type	Number of Bursts	Burst Period(s)	Wave from Length (s)	Center Frequency(GHz)	-		
17	Type 5	12	1	12	5.5355			
	Burst ID	Burst Offset (us)	Pulse Width (us)	Chirp Width (MHz)	Number of Pulses per Burst	PRI-1 (us)	PRI-2 (us)	PRI-3 (us)
	0	429224	86.4	10	3	1259	1918	1455
	1	670241	92.2	10	3	1598	1719	1895
	2	912880	80.4	10	2	1816	1899	-
	3	158603	54.3	10	1	1335	-	-
	4	400824	53.1	10	1	1303	-	-
	5	641915	69.4	10	2	1503	1546	-
	6	883823	69.1	10	2	1279	1639	-
	7	128373	100	10	3	1375	1438	1595
	8	370379	79.6	10	2	1239	1705	-
	9	611194	88.4	10	3	1374	1579	1623
	10	855665	53.3	10	1	1016	-	-
	11	98897	65.3	10	1	1709	-	-

Trial ID	Radar Type	Number of Bursts	Burst Period(s)	Wave from Length (s)	Center Frequency(GHz)	-		
18	Type 5	14	0.857143	12	5.5363			
	Burst ID	Burst Offset (us)	Pulse Width (us)	Chirp Width (MHz)	Number of Pulses per Burst	PRI-1 (us)	PRI-2 (us)	PRI-3 (us)
	0	292143	55.3	12	1	1920	-	-
	1	499633	58.3	12	1	1797	-	-
	2	706377	72.3	12	2	1610	1039	-
	3	58989	84.8	12	3	1131	1761	1721
	4	266161	82.5	12	2	1875	1431	-
	5	474469	63.3	12	1	1095	-	-
	6	680544	80	12	2	1119	1913	-
	7	33519	90.3	12	3	1660	1853	1123
	8	240319	91.1	12	3	1539	1783	1172
	9	447400	96.6	12	3	1525	1036	1385
	10	654516	82.7	12	2	1710	1990	-
	11	8083	50.7	12	1	1234	-	-
	12	215435	78.4	12	2	1047	1109	-
	13	421325	99.5	12	3	1299	1965	1869
19	Type 5	12	1	12	5.5355			
	Burst ID	Burst Offset (us)	Pulse Width (us)	Chirp Width (MHz)	Number of Pulses per Burst	PRI-1 (us)	PRI-2 (us)	PRI-3 (us)
	0	733725	88.6	10	3	1501	1067	1927
	1	977882	57.4	10	1	1723	-	-
	2	221197	96.6	10	3	1086	1658	1324
	3	462915	69.7	10	2	1751	1945	-
	4	705071	77.9	10	2	1642	1317	-
	5	947923	62	10	1	1866	-	-
	6	191373	88.4	10	3	1997	1077	1366
	7	432561	97.3	10	3	1790	1896	1367
	8	674004	96.2	10	3	1391	1787	1672
	9	915842	95.4	10	3	1020	1892	1414
	10	162176	54.8	10	1	1084	-	-
	11	403553	80.4	10	2	1850	1436	-

Trial ID	Radar Type	Number of Bursts	Burst Period(s)	Wave from Length (s)	Center Frequency(GHz)	-		
20	Type 5	16	0.75	12	5.5625			
	Burst ID	Burst Offset (us)	Pulse Width (us)	Chirp Width (MHz)	Number of Pulses per Burst	PRI-1 (us)	PRI-2 (us)	PRI-3 (us)
	0	483470	74.7	15	2	1619	1611	-
	1	666072	57.1	15	1	1560	-	-
	2	98810	91.9	15	3	1392	1475	1276
	3	279914	83.1	15	2	1809	1772	-
	4	462536	50.7	15	1	1003	-	-
	5	642324	79.2	15	2	1574	1600	-
	6	76831	58.7	15	1	1186	-	-
	7	257785	71	15	2	1521	1567	-
	8	438554	79	15	2	1777	1960	-
	9	620397	68.5	15	2	1284	1428	-
	10	54310	73.5	15	2	1904	1352	-
	11	235506	70.5	15	2	1864	1115	-
	12	417036	76.6	15	2	1045	1300	-
	13	597974	81.2	15	2	1160	1675	-
	14	32086	61.8	15	1	1277	-	-
	15	212751	94.9	15	3	1450	1206	1860
21	Type 5	12	1	12	5.5649			
	Burst ID	Burst Offset (us)	Pulse Width (us)	Chirp Width (MHz)	Number of Pulses per Burst	PRI-1 (us)	PRI-2 (us)	PRI-3 (us)
	0	526149	78.5	9	2	1653	1698	-
	1	767135	89.8	9	3	1174	1962	1167
	2	12955	59.4	9	1	1982	-	-
	3	254612	79.6	9	2	1633	1890	-
	4	496588	76	9	2	1112	1811	-
	5	739728	53.6	9	1	1144	-	-
	6	980872	80.9	9	2	1220	1053	-
	7	225249	61.6	9	1	1724	-	-
	8	467279	53.4	9	1	1901	-	-
	9	709720	59.9	9	1	1379	-	-
	10	951847	60.4	9	1	1453	-	-
	11	194839	91.4	9	3	1768	1726	1227



Trial ID	Radar Type	Number of Bursts	Burst Period(s)	Wave from Length (s)	Center Frequency(GHz)	-		
22	Type 5	20	0.6	12	5.5605			
	Burst ID	Burst Offset (us)	Pulse Width (us)	Chirp Width (MHz)	Number of Pulses per Burst	PRI-1 (us)	PRI-2 (us)	PRI-3 (us)
	0	261858	77	20	2	1191	1363	-
	1	407646	58.1	20	1	1248	-	-
	2	552319	62.1	20	1	1836	-	-
	3	99107	76.9	20	2	1334	1236	-
	4	243514	80	20	2	1914	1852	-
	5	389464	52	20	1	1701	-	-
	6	531093	88.6	20	3	1693	1995	1905
	7	81159	72.9	20	2	1922	1387	-
	8	225245	98.5	20	3	1839	1746	1389
	9	371906	57.9	20	1	1193	-	-
	10	514197	95.9	20	3	1659	1870	1066
	11	63561	53.5	20	1	1162	-	-
	12	207510	92	20	3	1745	1654	1458
	13	353638	57.3	20	1	1834	-	-
	14	497515	70.5	20	2	1684	1586	-
	15	45553	70	20	2	1042	1664	-
	16	189821	84	20	3	1765	1630	1176
	17	335330	76.1	20	2	1557	1057	-
	18	478825	93.2	20	3	1985	1018	1340
	19	27594	96.8	20	3	1760	1614	1817

Trial ID	Radar Type	Number of Bursts	Burst Period(s)	Wave from Length (s)	Center Frequency(GHz)	-		
23	Type 5	14	0.857143	12	5.5637			
	Burst ID	Burst Offset (us)	Pulse Width (us)	Chirp Width (MHz)	Number of Pulses per Burst	PRI-1 (us)	PRI-2 (us)	PRI-3 (us)
	0	247117	50.1	12	1	1841	-	-
	1	453362	93.5	12	3	1590	1081	1413
	2	660875	68.8	12	2	1707	1577	-
	3	14140	56.3	12	1	1056	-	-
	4	220734	86	12	3	1953	1108	1987
	5	428367	75.2	12	2	1572	1536	-
	6	636681	54.4	12	1	1517	-	-
	7	843157	71.1	12	2	1329	1243	-
	8	195585	76.2	12	2	1940	1770	-
	9	403231	80.2	12	2	1098	1209	-
	10	610202	79.7	12	2	1588	1214	-
	11	815229	90.9	12	3	1615	1862	1601
	12	170267	68.7	12	2	1377	1441	-
	13	377306	67.4	12	2	1872	1313	-

Trial ID	Radar Type	Number of Bursts	Burst Period(s)	Wave from Length (s)	Center Frequency(GHz)	-		
24	Type 5	13	0.923077	12	5.5641			
	Burst ID	Burst Offset (us)	Pulse Width (us)	Chirp Width (MHz)	Number of Pulses per Burst	PRI-1 (us)	PRI-2 (us)	PRI-3 (us)
	0	628071	94	11	3	1643	1748	1941
	1	853391	70.8	11	2	1177	1201	-
	2	156223	56.3	11	1	1006	-	-
	3	378734	96.7	11	3	1230	1163	1332
	4	601331	90.6	11	3	1217	1582	1498
	5	825462	74.5	11	2	1569	1281	-
	6	128265	92.6	11	3	1065	1669	1222
	7	351161	89	11	3	1493	1135	1380
	8	573425	96.5	11	3	1607	1822	1602
	9	798431	70.5	11	2	1141	1178	-
	10	100737	94	11	3	1009	1629	1956
	11	324661	55.8	11	1	1290	-	-
	12	546278	87.7	11	3	1435	1963	1164
25	Type 5	8	1.5	12	5.5665			
	Burst ID	Burst Offset (us)	Pulse Width (us)	Chirp Width (MHz)	Number of Pulses per Burst	PRI-1 (us)	PRI-2 (us)	PRI-3 (us)
	0	1253842	68.6	5	2	1306	1161	-
	1	119486	83.1	5	2	1420	1315	-
	2	482958	60.9	5	1	1687	-	-
	3	845641	77.7	5	2	1776	1158	-
	4	1208428	77.4	5	2	1793	1510	-
	5	74748	66.8	5	2	1576	1323	-
	6	438300	63.7	5	1	1333	-	-
	7	800152	91.2	5	3	1409	1681	1275

Trial ID	Radar Type	Number of Bursts	Burst Period(s)	Wave from Length (s)	Center Frequency(GHz)	-		
26	Type 5	17	0.705882	12	5.5621			
	Burst ID	Burst Offset (us)	Pulse Width (us)	Chirp Width (MHz)	Number of Pulses per Burst	PRI-1 (us)	PRI-2 (us)	PRI-3 (us)
	0	545865	83.6	16	3	1632	1195	1000
	1	14067	89.4	16	3	1173	1627	1656
	2	184953	55.8	16	1	1532	-	-
	3	353759	90.9	16	3	1981	1554	1998
	4	526388	54.7	16	1	1825	-	-
	5	694806	97.7	16	3	1734	1202	1250
	6	163568	67.5	16	2	1571	1434	-
	7	333410	96.7	16	3	1589	1469	1268
	8	504006	68.3	16	2	1750	1954	-
	9	675297	78.3	16	2	1591	1082	-
	10	142890	55	16	1	1427	-	-
	11	312479	84.9	16	3	1129	1936	1199
	12	482953	74.6	16	2	1959	1856	-
	13	655022	63.3	16	1	1885	-	-
	14	121457	99.8	16	3	1035	1515	1120
	15	292606	63.6	16	1	1647	-	-
	16	461322	87.3	16	3	1931	1051	1831

Trial ID	Radar Type	Number of Bursts	Burst Period(s)	Wave from Length (s)	Center Frequency(GHz)	-		
27	Type 5	19	0.631579	12	5.5609			
	Burst ID	Burst Offset (us)	Pulse Width (us)	Chirp Width (MHz)	Number of Pulses per Burst	PRI-1 (us)	PRI-2 (us)	PRI-3 (us)
	0	565136	85.6	19	3	1946	1078	1015
	1	89970	68.6	19	2	1029	1780	-
	2	243121	54.2	19	1	1111	-	-
	3	396034	61.2	19	1	1104	-	-
	4	546225	97.1	19	3	1157	1969	1100
	5	70998	98.3	19	3	1142	1699	1622
	6	224093	62.4	19	1	1655	-	-
	7	376127	80.2	19	2	1126	1769	-
	8	527806	87.5	19	3	1216	1448	1179
	9	52247	85.8	19	3	1847	1348	1472
	10	204582	88.1	19	3	1023	1124	1631
	11	357941	65.3	19	1	1848	-	-
	12	510977	52.5	19	1	1470	-	-
	13	33698	52.3	19	1	1312	-	-
	14	186023	74.1	19	2	1915	1200	-
	15	339327	54.9	19	1	1479	-	-
	16	491053	76.2	19	2	1376	1502	-
	17	14858	60.4	19	1	1758	-	-
	18	167387	81.5	19	2	1491	1103	-

Trial ID	Radar Type	Number of Bursts	Burst Period(s)	Wave from Length (s)	Center Frequency(GHz)	-		
28	Type 5	12	1	12	5.5645			
	Burst ID	Burst Offset (us)	Pulse Width (us)	Chirp Width (MHz)	Number of Pulses per Burst	PRI-1 (us)	PRI-2 (us)	PRI-3 (us)
	0	507709	50.5	10	1	1857	-	-
	1	750249	55.7	10	1	1246	-	-
	2	989003	85.8	10	3	1774	1002	1967
	3	235634	76.9	10	2	1125	1474	-
	4	477675	75.1	10	2	1254	1052	-
	5	718312	92.3	10	3	1180	1486	1492
	6	960895	78.1	10	2	1301	1757	-
	7	205370	92.2	10	3	1898	1252	1713
	8	446940	89	10	3	1260	1706	1411
	9	689225	70.9	10	2	1578	1620	-
	10	932305	63.1	10	1	1782	-	-
	11	176231	55.3	10	1	1522	-	-

Trial ID	Radar Type	Number of Bursts	Burst Period(s)	Wave from Length (s)	Center Frequency(GHz)	-		
29	Type 5	18	0.666667	12	5.5617			
	Burst ID	Burst Offset (us)	Pulse Width (us)	Chirp Width (MHz)	Number of Pulses per Burst	PRI-1 (us)	PRI-2 (us)	PRI-3 (us)
	0	277485	83.4	17	3	1454	1205	1801
	1	437880	97.3	17	3	1319	1826	1635
	2	598445	90.4	17	3	1079	1986	1674
	3	97088	91.8	17	3	1563	1151	1802
	4	257251	98.2	17	3	1876	1977	1766
	5	419893	59.5	17	1	1952	-	-
	6	580724	80	17	2	1253	1137	-
	7	77366	86.5	17	3	1054	1128	1828
	8	238032	91.1	17	3	1105	1599	1442
	9	398605	93.5	17	3	1867	1373	1087
	10	562025	60.7	17	1	1033	-	-
	11	57684	67.2	17	2	1288	1405	-
	12	219083	61.8	17	1	1585	-	-
	13	379234	79.4	17	2	1933	1667	-
	14	540896	81.4	17	2	1096	1464	-
	15	37916	65.7	17	1	1496	-	-
	16	198794	76	17	2	1733	1255	-
	17	359754	81	17	2	1326	1668	-

### Radar Signal 6

Trial ID	Radar Type	Pulse Width (μs)	PRI (μs)	Pulses per Hop	Hopping Rate (kHz)	Hopping Sequence Length (ms)	Number of Pulses
0	Type 6	1	333.3	9	0.3333	300	16
1	Type 6	1	333.3	9	0.3333	300	10
2	Type 6	1	333.3	9	0.3333	300	14
3	Type 6	1	333.3	9	0.3333	300	19
4	Type 6	1	333.3	9	0.3333	300	15
5	Type 6	1	333.3	9	0.3333	300	18
6	Type 6	1	333.3	9	0.3333	300	14
7	Type 6	1	333.3	9	0.3333	300	14
8	Type 6	1	333.3	9	0.3333	300	21
9	Type 6	1	333.3	9	0.3333	300	15
10	Type 6	1	333.3	9	0.3333	300	16
11	Type 6	1	333.3	9	0.3333	300	24
12	Type 6	1	333.3	9	0.3333	300	13
13	Type 6	1	333.3	9	0.3333	300	20
14	Type 6	1	333.3	9	0.3333	300	17
15	Type 6	1	333.3	9	0.3333	300	20
16	Type 6	1	333.3	9	0.3333	300	16
17	Type 6	1	333.3	9	0.3333	300	18
18	Type 6	1	333.3	9	0.3333	300	14
19	Type 6	1	333.3	9	0.3333	300	16
20	Type 6	1	333.3	9	0.3333	300	20
21	Type 6	1	333.3	9	0.3333	300	19
22	Type 6	1	333.3	9	0.3333	300	23
23	Type 6	1	333.3	9	0.3333	300	17
24	Type 6	1	333.3	9	0.3333	300	16
25	Type 6	1	333.3	9	0.3333	300	13
26	Type 6	1	333.3	9	0.3333	300	13
27	Type 6	1	333.3	9	0.3333	300	18
28	Type 6	1	333.3	9	0.3333	300	19
29	Type 6	1	333.3	9	0.3333	300	20



### 6.4 CHANNEL AVAILABILITY CHECK TIME

If the UUT successfully detected the radar burst, it should be observed as the UUT has no transmissions occurred until the UUT starts transmitting on another channel.

#### 11a Mode

Initial Channel Availability Check Time

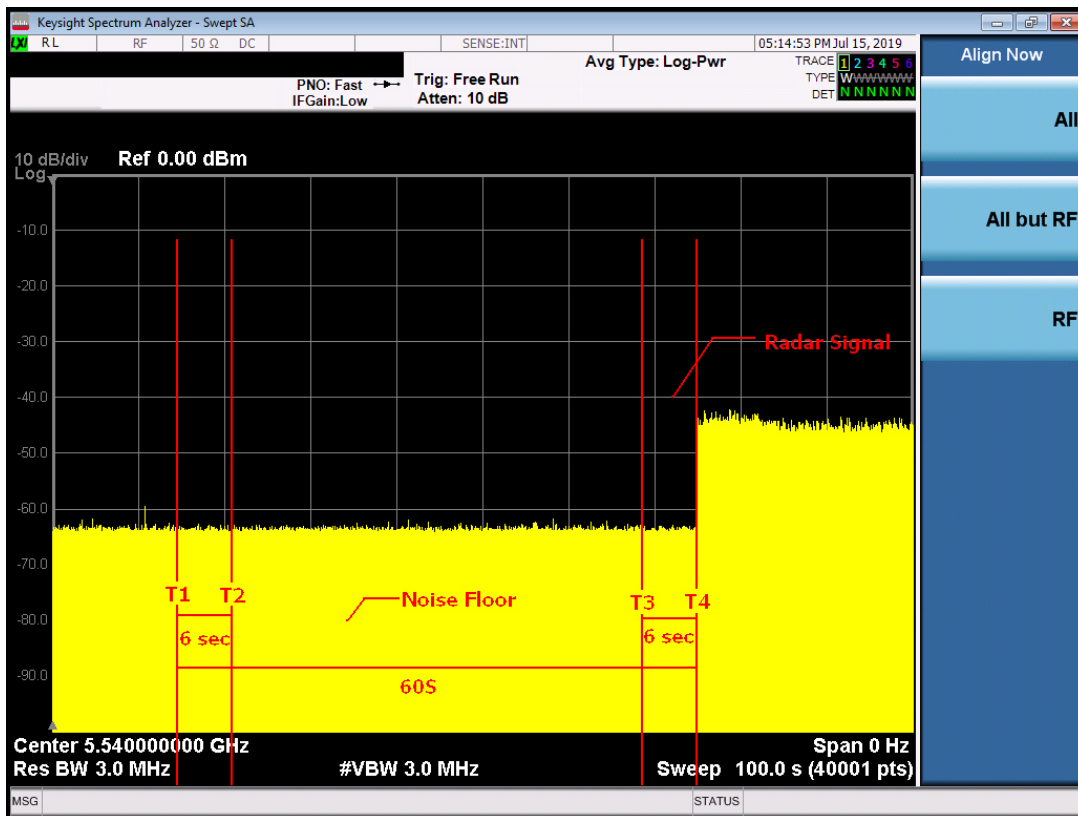

**Note:** T1 denotes the end of power-up time period is 6 second.  
 T4 denotes the end of Channel Availability Check time is 66 second. Channel Availability Check time is equal to (T4 – T1) 60 seconds.

### 11a Mode

Radar Burst at the Beginning of the Channel Availability Check Time

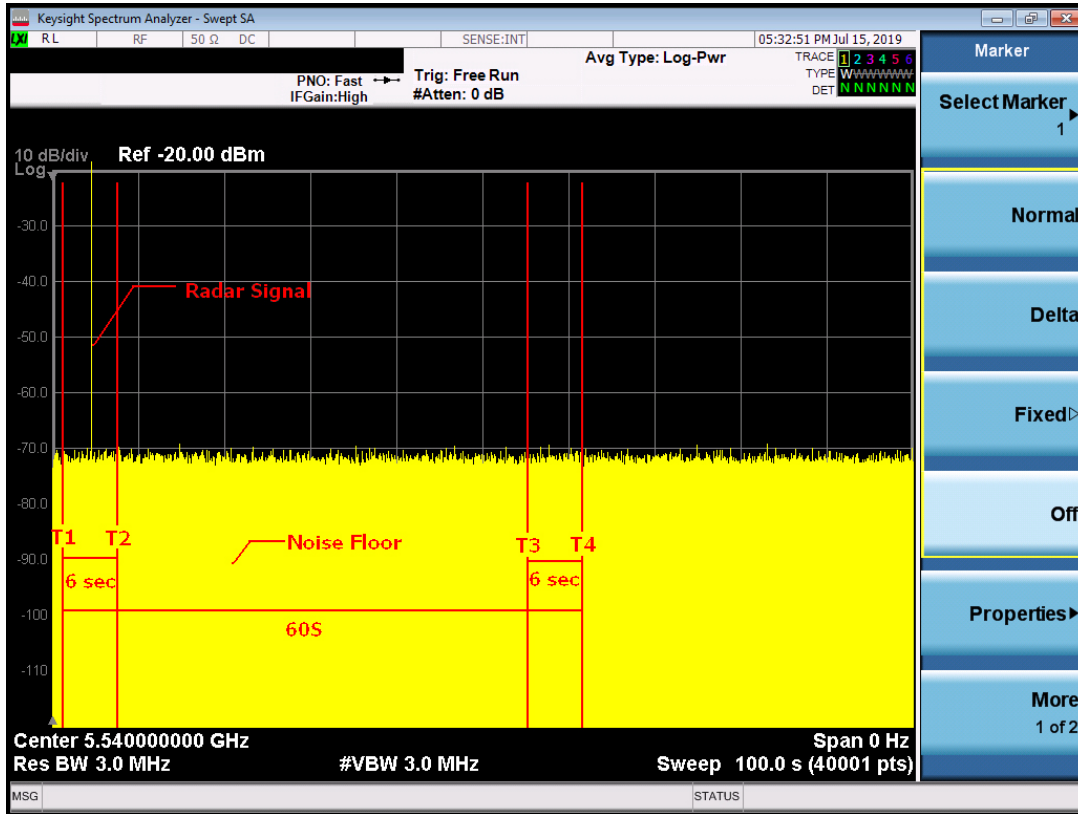

**Note:** T1 denotes the end of power up time period is 6 second.  
 T2 denotes 12 second. The radar burst was commenced within a 6 second window starting from the end of power-up sequence.  
 T4 denotes the 66 second.

### 11a Mode

Radar Burst at the End of the Channel Availability Check Time

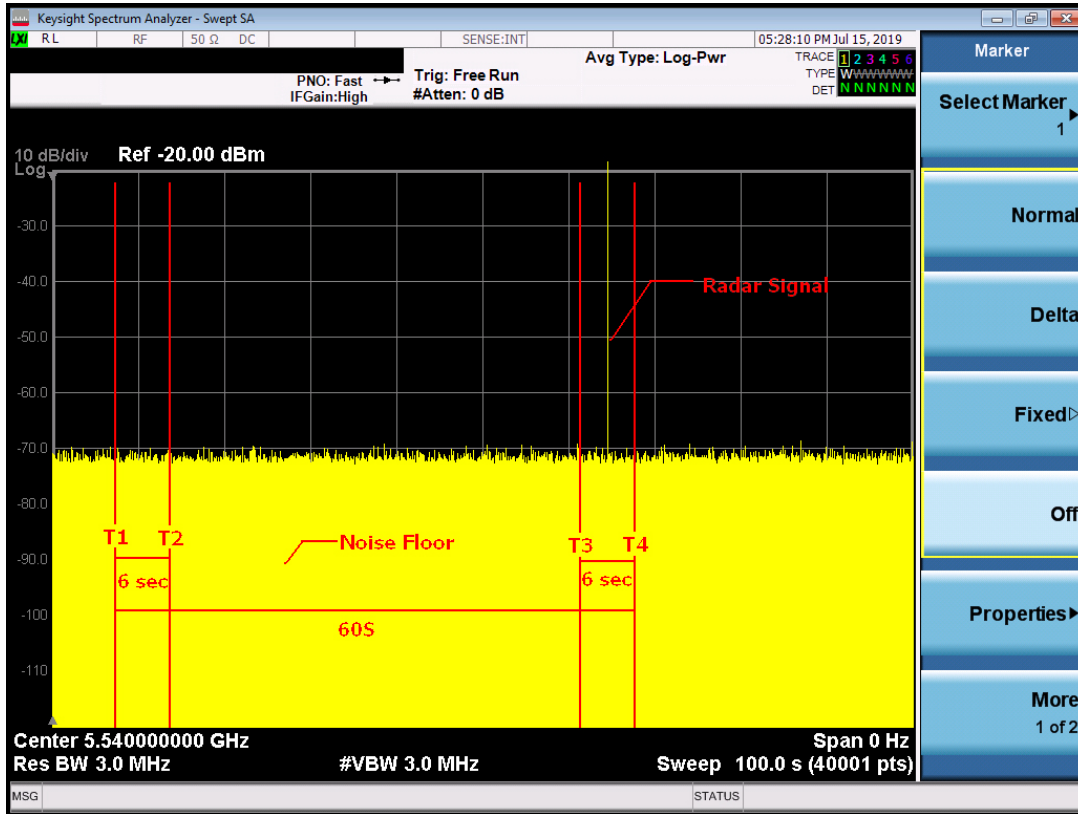

**Note:** T1 denotes the end of power up time period is 6 second.  
 T3 denotes 66 second and radar burst was commenced within 54 second to 60 second indow starting from the end of power-up sequence.  
 T4 denotes the 66 second

### 11n 40MHz Mode

#### Initial Channel Availability Check Time

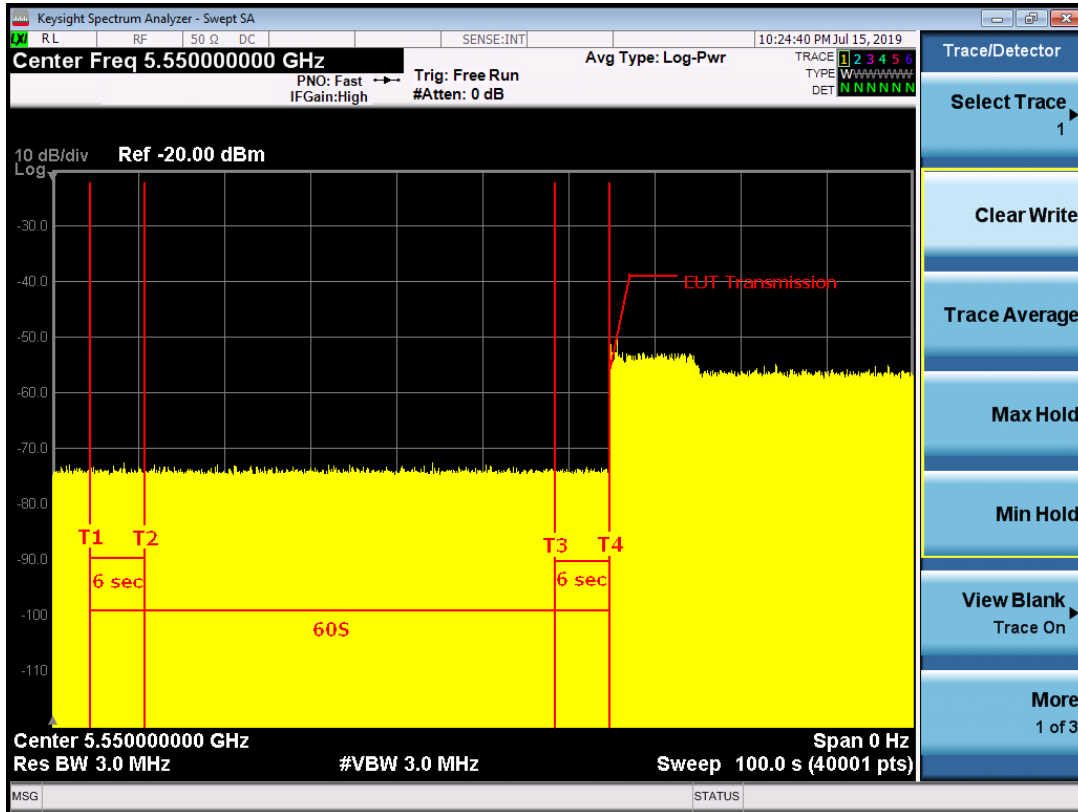

**Note:** T1 denotes the end of power-up time period is 6 second.  
 T4 denotes the end of Channel Availability Check time is 66 second. Channel Availability Check time is equal to (T4 – T1) 60 seconds.