

# FCC Radio Test Report

## FCC ID: Q78-ZXHNF680V5

This report concerns: Original Grant

**Project No.** : 1906H014  
**Equipment** : GPON ONT  
**Test Model** : ZXHN F680  
**Series Model** : N/A  
**Applicant** : ZTE Corporation  
**Address** : ZTE Plaza, Hi-Tech Park, Nanshan District,  
Shenzhen, Guangdong, P.R.China

**Date of Receipt** : Jun. 27, 2019  
**Date of Test** : Jun. 27, 2019~Jul. 29, 2019  
**Issued Date** : Sep. 03, 2019  
**Tested by** : BTL Inc.

**Testing Engineer** : Thomas Yu  
(Thomas Yu)

**Technical Manager** : Krain Wu  
(Krain Wu)

**Authorized Signatory** : young chai  
(Young Chai)

# B T L I N C .

No. 29, Jintang Road, Tangzhen Industry Park, Pudong New Area,  
Shanghai 201210, China  
TEL: +86-021-61765666



Certificate # 5123. 03

## Declaration

**BTL** represents to the client that testing is done in accordance with standard procedures as applicable and that test instruments used has been calibrated with standards traceable to international standard(s) and/or national standard(s).

**BTL's** reports apply only to the specific samples tested under conditions. It is manufacture's responsibility to ensure that additional production units of this model are manufactured with the identical electrical and mechanical components. **BTL** shall have no liability for any declarations, inferences or generalizations drawn by the client or others from **BTL** issued reports.

The report must not be used by the client to claim product certification, approval, or endorsement by NVLAP, NIST, A2LA, or any agency of the U.S. Government.

This report is the confidential property of the client. As a mutual protection to the clients, the public and ourselves, the test report shall not be reproduced, except in full, without our written approval.

**BTL's** laboratory quality assurance procedures are in compliance with the **ISO/IEC 17025** requirements, and accredited by the conformity assessment authorities listed in this test report.

**BTL** is not responsible for the sampling stage, so the results only apply to the sample as received.

The information, data and test plan are provided by manufacturer which may affect the validity of results, so it is manufacturer's responsibility to ensure that the apparatus meets the essential requirements of applied standards and in all the possible configurations as representative of its intended use.

## Limitation

For the use of the authority's logo is limited unless the Test Standard(s)/Scope(s)/Item(s) mentioned in this test report is (are) included in the conformity assessment authorities acceptance respective.

Please note that the measurement uncertainty is provided for informational purpose only and are not use in determining the Pass/Fail results.

**Table of Contents****Page**

<b>REPORT ISSUED HISTORY</b>	<b>6</b>
<b>1 . GENERAL SUMMARY</b>	<b>7</b>
<b>2 . SUMMARY OF TEST RESULTS</b>	<b>8</b>
2.1 TEST FACILITY	9
2.2 MEASUREMENT UNCERTAINTY	9
<b>3 . GENERAL INFORMATION</b>	<b>10</b>
3.1 GENERAL DESCRIPTION OF EUT	10
3.2 DESCRIPTION OF TEST MODES	11
3.3 PARAMETERS OF TEST SOFTWARE	13
3.4 DUTY CYCLE	14
3.5 BLOCK DIAGRAM SHOWING THE CONFIGURATION OF SYSTEM TESTED	15
3.6 SUPPORT UNITS	15
<b>4 . AC POWER LINE CONDUCTED EMISSIONS TEST</b>	<b>16</b>
4.1 LIMIT	16
4.2 TEST PROCEDURE	16
4.3 DEVIATION FROM TEST STANDARD	16
4.4 TEST SETUP	17
4.5 EUT OPERATION CONDITIONS	17
4.6 EUT TEST CONDITIONS	17
4.7 TEST RESULTS	17
<b>5 . RADIATED EMISSIONS TEST</b>	<b>18</b>
5.1 LIMIT	18
5.2 TEST PROCEDURE	19
5.3 DEVIATION FROM TEST STANDARD	19
5.4 TEST SETUP	20
5.5 EUT OPERATION CONDITIONS	21
5.6 EUT TEST CONDITIONS	21
5.7 TEST RESULTS - 9 KHZ TO 30 MHZ	21
5.8 TEST RESULTS - 30 MHZ TO 1000 MHZ	21
5.9 TEST RESULTS - ABOVE 1000 MHZ	21
<b>6 . BANDWIDTH TEST</b>	<b>22</b>
6.1 LIMIT	22
6.2 TEST PROCEDURE	22

Table of Contents	Page
6.3 DEVIATION FROM STANDARD	22
6.4 TEST SETUP	22
6.5 EUT OPERATION CONDITIONS	22
6.6 EUT TEST CONDITIONS	22
6.7 TEST RESULTS	22
<b>7 . MAXIMUM OUTPUT POWER TEST</b>	<b>23</b>
7.1 LIMIT	23
7.2 TEST PROCEDURE	23
7.3 DEVIATION FROM STANDARD	23
7.4 TEST SETUP	23
7.5 EUT OPERATION CONDITIONS	23
7.6 EUT TEST CONDITIONS	23
7.7 TEST RESULTS	23
<b>8 . CONDUCTED SPURIOUS EMISSIONS</b>	<b>24</b>
8.1 LIMIT	24
8.2 TEST PROCEDURE	24
8.3 DEVIATION FROM STANDARD	24
8.4 TEST SETUP	24
8.5 EUT OPERATION CONDITIONS	24
8.6 EUT TEST CONDITIONS	24
8.7 TEST RESULTS	24
<b>9 . POWER SPECTRAL DENSITY TEST</b>	<b>25</b>
9.1 LIMIT	25
9.2 TEST PROCEDURE	25
9.3 DEVIATION FROM STANDARD	25
9.4 TEST SETUP	25
9.5 EUT OPERATION CONDITIONS	25
9.6 EUT TEST CONDITIONS	25
9.7 TEST RESULTS	25
<b>10 . MEASUREMENT INSTRUMENTS LIST</b>	<b>26</b>
<b>APPENDIX A - AC POWER LINE CONDUCTED EMISSIONS</b>	<b>28</b>
<b>APPENDIX B - RADIATED EMISSION - 9 KHZ TO 30 MHZ</b>	<b>31</b>
<b>APPENDIX C - RADIATED EMISSION - 30 MHZ TO 1000 MHZ</b>	<b>36</b>

**Table of Contents****Page**

<b>APPENDIX D - RADIATED EMISSION- ABOVE 1000 MHZ</b>	<b>39</b>
<b>APPENDIX E - BANDWIDTH</b>	<b>88</b>
<b>APPENDIX F - MAXIMUM OUTPUT POWER</b>	<b>91</b>
<b>APPENDIX G - CONDUCTED SPURIOUS EMISSIONS</b>	<b>96</b>
<b>APPENDIX H - POWER SPECTRAL DENSITY</b>	<b>109</b>

### REPORT ISSUED HISTORY

Report Version	Description	Issued Date
R00	Original Issue.	Sep. 03, 2019

## 1. GENERAL SUMMARY

Equipment : GPON ONT  
Brand Name : ZTE  
Test Model : ZXHN F680  
Series Model : N/A  
Applicant : ZTE Corporation  
Manufacturer : ZTE Corporation  
Address : ZTE Plaza, Hi-Tech Park, Nanshan District, Shenzhen, Guangdong, P.R.China  
Date of Test : Jun. 27, 2019~Jul. 29, 2019  
Test Sample : Engineering Sample No.: SH190612106  
Standard(s) : FCC Part15, Subpart C (15.247)  
ANSI C63.10-2013  
KDB 558074 D01 15.247 Meas Guidance V05r02

The above equipment has been tested and found compliance with the requirement of the relative standards by BTL Inc.

The test data, data evaluation, and equipment configuration contained in our test report (Ref No. BTL-FCCP-1-1906H014) were obtained utilizing the test procedures, test instruments, test sites that has been accredited by the Authority of A2LA according to the ISO/IEC 17025 quality assessment standard and technical standard(s).

**Test results included in this report are only for the WLAN 2.4 GHz part.**

## 2. SUMMARY OF TEST RESULTS

Test procedures according to the technical standard(s):

FCC Part15, Subpart C (15.247)				
Standard(s) Section	Test Item	Test Result	Judgment	Remark
15.207	AC Power Line Conducted Emissions	APPENDIX A	PASS	-----
15.247(d) 15.205(a) 15.209(a)	Radiated Emissions	APPENDIX B APPENDIX C APPENDIX D	PASS	-----
15.247(a)(2)	Bandwidth	APPENDIX E	PASS	-----
15.247(b)(3)	Maximum Output Power	APPENDIX F	PASS	-----
15.247(d)	Conducted Spurious Emissions	APPENDIX G	PASS	-----
15.247(e)	Power Spectral Density	APPENDIX H	PASS	-----
15.203	Antenna Requirement	-----	PASS	-----

Note:

(1) "N/A" denotes test is not applicable in this test report.



## 2.1 TEST FACILITY

The test facilities used to collect the test data in this report is at the location of No. 29, Jintang Road, Tangzhen Industry Park, Pudong New Area, Shanghai 201210, China.

BTL's Test Firm Registration Number for FCC: 476765

BTL's Designation Number for FCC: CN1241

## 2.2 MEASUREMENT UNCERTAINTY

ISO/IEC 17025 requires that an estimate of the measurement uncertainties associated with the emissions test results be included in the report. The measurement uncertainties given below are based on a 95% confidence level (based on a coverage factor (k=2))

The BTL measurement uncertainty as below table:

### A. AC power line conducted emissions test:

Test Site	Method	Measurement Frequency Range	U, (dB)
SH-C01	CISPR	150 kHz ~ 30MHz	± 2.26

### A. Radiated emissions test:

Test Site	Method	Measurement Frequency Range	Ant. H / V	U, (dB)
SH-CB01	CISPR	9 KHz~30 MHz	V	3.79
		9 KHz~30 MHz	H	3.57
		30 MHz~200 MHz	V	4.04
		30 MHz~200 MHz	H	3.76
		200 MHz~1,000 MHz	V	4.24
		200 MHz~1,000 MHz	H	3.84
		1 GHz~18 GHz	V	4.46
		1 GHz~18 GHz	H	4.40
		18 GHz~40 GHz	V	3.95
		18 GHz~40 GHz	H	3.95

Note: Unless specifically mentioned, the uncertainty of measurement has not been taken into account to declare the compliance or non-compliance to the specification.

### 3. GENERAL INFORMATION

#### 3.1 GENERAL DESCRIPTION OF EUT

Equipment	GPON ONT
Brand Name	ZTE
Test Model	ZXHN F680
Series Model	N/A
Model Difference(s)	N/A
Software Version	V5.0.xx
Hardware Version	V5.0
Power Source	DC Voltage supplied from AC/DC adapter.
Power Rating	I/P: 100-240V ~ 50/60Hz 1.0A MAX O/P: 12V --- 2.0A
Operation Frequency	2412 MHz ~ 2462 MHz
Modulation Type	IEEE 802.11b: DSSS IEEE 802.11g: OFDM IEEE 802.11n: OFDM
Bit Rate of Transmitter	IEEE 802.11b: 11/5.5/2/1 Mbps IEEE 802.11g: 54/48/36/24/18/12/9/6 Mbps IEEE 802.11n: up to 450Mbps
Maximum Output Power Non-Beamforming	IEEE 802.11b: 28.99 dBm (0.7924 W) IEEE 802.11g: 26.77 dBm (0.4751 W) IEEE 802.11n (HT20): 26.85 dBm (0.4843 W) IEEE 802.11n (HT40): 16.61 dBm (0.0458 W)

Note:

- For a more detailed features description, please refer to the manufacturer's specifications or the user's manual.
- Channel List:

CH01 - CH11 for IEEE 802.11b, IEEE 802.11g, IEEE 802.11n (HT20) CH03 - CH09 for IEEE 802.11n (HT40)							
Channel	Frequency (MHz)	Channel	Frequency (MHz)	Channel	Frequency (MHz)	Channel	Frequency (MHz)
01	2412	04	2427	07	2442	10	2457
02	2417	05	2432	08	2447	11	2462
03	2422	06	2437	09	2452		

### 3. Antenna Specification:

Ant.	Brand	Model Name	Antenna Type	Connector	Gain (dBi)	Note
1	N/A	N/A	PCB	N/A	2.1	N/A
2	N/A	N/A	PCB	N/A	2.1	N/A
3	N/A	N/A	PCB	N/A	2.1	N/A

**Note:**

- (1) The EUT incorporates a MIMO function. Physically, the EUT provides three completed transmitters and receivers (3T3R), all transmit signals are completely uncorrelated, then, **Direction gain =  $G_{ANT}$** , that is Directional gain=2.1.
- (2) For IEEE 802.11 b/g /n mode (3TX/3RX):  
 Ant. 1, Ant. 2 and Ant. 3 can be used as transmitting/receiving antenna.  
 Ant. 1, Ant. 2 and Ant. 3 could both transmit/receive simultaneously.

### 4. Table for Antenna Configuration:

Operating Mode TX Mode	1TX	3TX
	802.11b	V (Ant. 1)
802.11g	-	V (Ant. 1 + Ant. 2 + Ant. 3)
802.11n(20 MHz)	-	V (Ant. 1 + Ant. 2 + Ant. 3)
802.11n(40 MHz)	-	V (Ant. 1 + Ant. 2 + Ant. 3)

### 3.2 DESCRIPTION OF TEST MODES

The test system was pre-tested based on the consideration of all possible combinations of EUT operation mode.

Pretest Mode	Description
Mode 1	TX B Mode Channel 01/06/11
Mode 2	TX G Mode Channel 01/06/11
Mode 3	TX N-20 MHz Mode Channel 01/06/11
Mode 4	TX N-40 MHz Mode Channel 03/06/09
Mode 5	TX B MODE CHANNEL 06

Following mode(s) as (were) found to be the worst case(s) and selected for the final test.

<b>AC power line conducted emissions test</b>	
Final Test Mode:	Description
Mode 5	TX B Mode Channel 01

<b>Radiated emissions test</b>	
Final Test Mode:	Description
Mode 1	TX B Mode Channel 01/06/11
Mode 2	TX G Mode Channel 01/06/11
Mode 3	TX N-20 MHz Mode Channel 01/06/11
Mode 4	TX N-40 MHz Mode Channel 03/06/09

<b>Conducted test</b>	
Final Test Mode:	Description
Mode 1	TX B Mode Channel 01/06/11
Mode 2	TX G Mode Channel 01/06/11
Mode 3	TX N-20 MHz Mode Channel 01/06/11
Mode 4	TX N-40 MHz Mode Channel 03/06/09

**NOTE:**

- (1) The measurements are performed at the high, middle, low available channels.
- (2) 802.11b mode: CCK (1 Mbps)  
 802.11g mode: OFDM (6 Mbps)  
 802.11n HT20 mode : BPSK (13 Mbps)  
 802.11n HT40 mode : BPSK (27 Mbps)  
 For radiated emission tests, the highest output powers were set for final test.
- (3) For radiated emission below 1 GHz test, the IEEE 802.11b is found to be the worst case and recorded.
- (4) For radiated emission above 1 GHz test, 1GHz~26.5GHz have been pre-tested and in this report only recorded the worst case. The remaining spurious points are all below the limit value of 20dB.

### 3.3 PARAMETERS OF TEST SOFTWARE

Test Software	CMD		
Frequency (MHz)	2412	2437	2462
IEEE 802.11b	16	26	20
IEEE 802.11g	14	24	15
IEEE 802.11n (HT20)	13	24	14
Frequency (MHz)	2422	2437	2452
IEEE 802.11n (HT40)	8	12	8

### 3.4 DUTY CYCLE

If duty cycle is  $\geq 98\%$ , duty factor is not required.  
 If duty cycle is  $< 98\%$ , duty factor shall be considered.  
 The output power = measured power + duty factor.

**IEEE 802.11b**

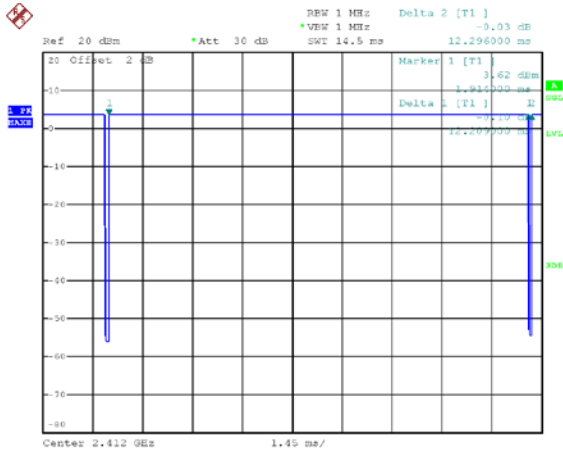

Date: 2.JUL.2019 16:05:45

Duty cycle =  $12.209 \text{ ms} / 12.296 \text{ ms} = 99.29\%$   
 Duty Factor =  $10 \log(1/\text{Duty cycle}) = 0.00$

**IEEE 802.11n (HT20)**

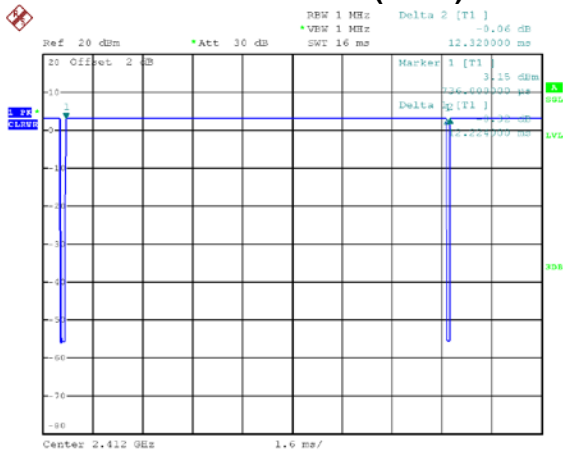

Date: 2.JUL.2019 16:09:54

Duty cycle =  $12.224 \text{ ms} / 12.320 \text{ ms} = 99.22\%$   
 Duty Factor =  $10 \log(1/\text{Duty cycle}) = 0.00$ ,

**IEEE 802.11g**

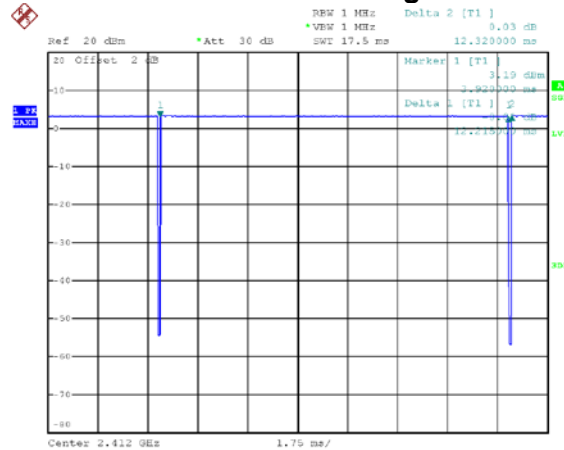

Date: 2.JUL.2019 16:08:39

Duty cycle =  $12.215 \text{ ms} / 12.320 \text{ ms} = 99.15\%$   
 Duty Factor =  $10 \log(1/\text{Duty cycle}) = 0.00$

**IEEE 802.11n (HT40)**

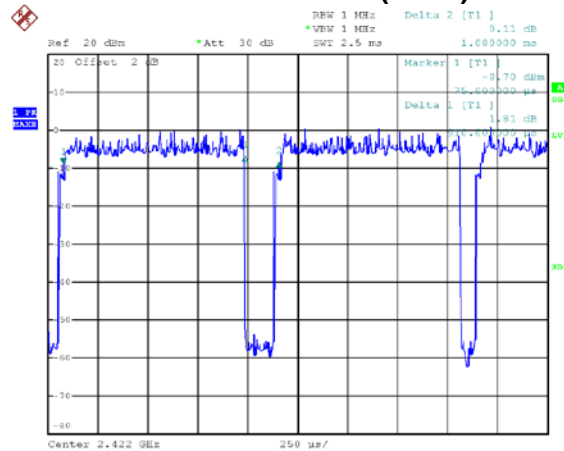

Date: 2.JUL.2019 16:51:19

Duty cycle =  $0.910 \text{ ms} / 1.080 \text{ ms} = 84.26\%$   
 Duty Factor =  $10 \log(1/\text{Duty cycle}) = 0.74$

**NOTE:**

For IEEE 802.11g and IEEE 802.11n (HT20):  
 For radiated emissions frequency above 1 GHz, the resolution bandwidth of test receiver/spectrum analyzer is 1 MHz and the video bandwidth is 1 kHz (Duty cycle  $< 98\%$ ).

For IEEE 802.11n (HT40):  
 For radiated emissions frequency above 1 GHz, the resolution bandwidth of test receiver/spectrum analyzer is 1 MHz and the video bandwidth is 2 kHz (Duty cycle  $< 98\%$ ).

**3.5 BLOCK DIAGRAM SHOWING THE CONFIGURATION OF SYSTEM TESTED**

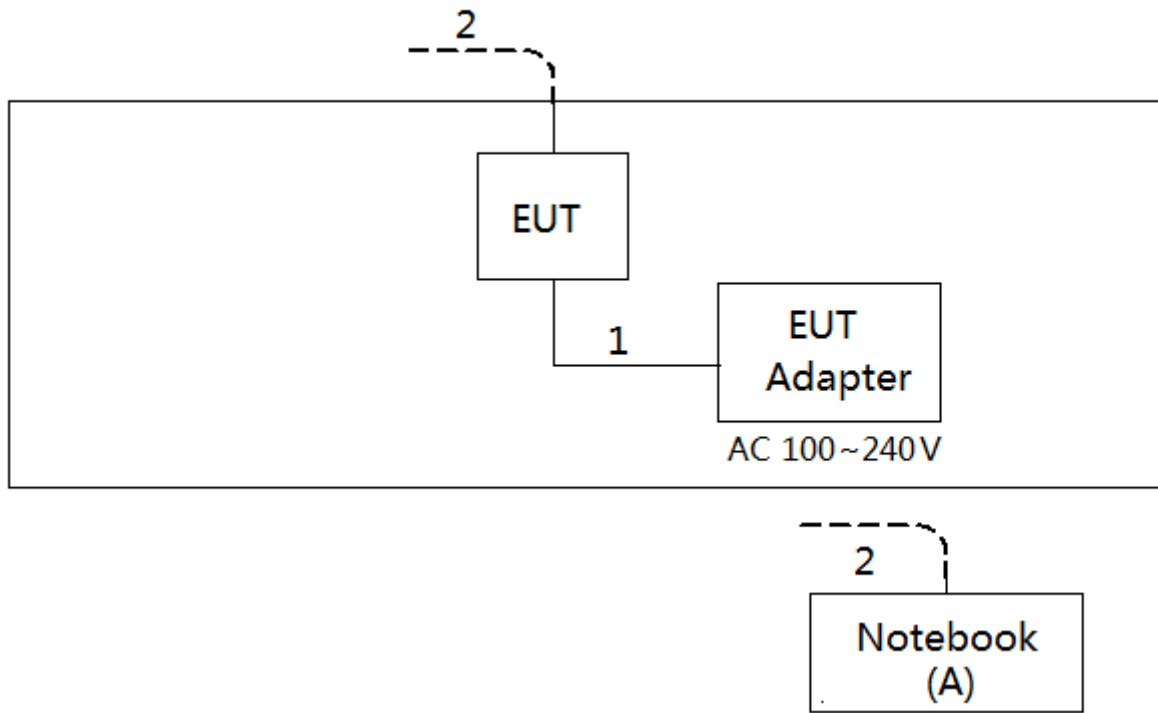

**3.6 SUPPORT UNITS**

Item	Equipment	Mfr/Brand	Model/Type No.	Series No.
A	Notebook	Lenovo	#P152014	N/A

Item	Cable Type	Shielded Type	Ferrite Core	Length
1	DC Cable	N/A	N/A	1.5m
2	RJ45 Cable	N/A	N/A	10m

## 4. AC POWER LINE CONDUCTED EMISSIONS TEST

### 4.1 LIMIT

Frequency of Emission (MHz)	Limit (dB $\mu$ V)	
	Quasi-peak	Average
0.15 - 0.50	66 to 56*	56 - 46*
0.50 - 5.0	56	46
5.0 - 30.0	60	50

**NOTE:**

- (1) The tighter limit applies at the band edges.
- (2) The limit of " \* " marked band means the limitation decreases linearly with the logarithm of the frequency in the range.

The following table is the setting of the receiver

Receiver Parameters	Setting
Attenuation	10 dB
Start Frequency	0.15 MHz
Stop Frequency	30 MHz
IF Bandwidth	9 kHz

### 4.2 TEST PROCEDURE

- a. The EUT was placed 0.8 meters from the horizontal ground plane with EUT being connected to the power mains through a line impedance stabilization network (LISN). All other support equipment powered from additional LISN(s). The LISN provide 50 Ohm/ 50uH of coupling impedance for the measuring instrument.
- b. Interconnecting cables that hang closer than 40 cm to the ground plane shall be folded back and forth in the center forming a bundle 30 to 40 cm long.
- c. I/O cables that are not connected to a peripheral shall be bundled in the center. The end of the cable may be terminated, if required, using the correct terminating impedance. The overall length shall not exceed 1 m.
- d. LISN at least 80 cm from nearest part of EUT chassis.
- e. For the actual test configuration, please refer to the related Item -EUT Test Photos.

### 4.3 DEVIATION FROM TEST STANDARD

No deviation



**4.4 TEST SETUP**

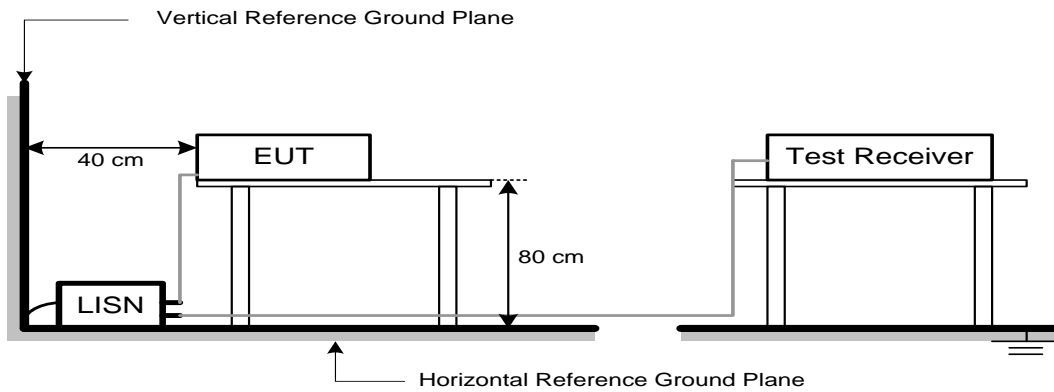

**4.5 EUT OPERATION CONDITIONS**

EUT was programmed to be in continuously transmitting mode.

**4.6 EUT TEST CONDITIONS**

Temperature: 23°C    Relative Humidity: 56%    Test Voltage: AC 120V/60Hz

**4.7 TEST RESULTS**

Please refer to the APPENDIX A.

## 5. RADIATED EMISSIONS TEST

### 5.1 LIMIT

In case the emission fall within the restricted band specified on 15.205(a), then the 15.209(a) limit in the table below has to be followed.

#### LIMITS OF RADIATED EMISSION MEASUREMENT (9 kHz-1000 MHz)

Frequency (MHz)	Field Strength (microvolts/meter)	Measurement Distance (meters)
0.009-0.490	2400/F(kHz)	300
0.490-1.705	24000/F(kHz)	30
1.705-30.0	30	30
30-88	100	3
88-216	150	3
216-960	200	3
Above 960	500	3

#### LIMITS OF RADIATED EMISSION MEASUREMENT (Above 1000 MHz)

Frequency (MHz)	(dBuV/m at 3 m)	
	Peak	Average
Above 1000	74	54

#### NOTE:

- (1) The limit for radiated test was performed according to FCC PART 15C.
- (2) The tighter limit applies at the band edges.
- (3) Emission level (dBuV/m)=20log Emission level (uV/m).
- (4) The test result calculated as following:  
 Measurement Value = Reading Level + Correct Factor  
 Correct Factor = Antenna Factor + Cable Loss - Amplifier Gain(if use)  
 Margin Level = Measurement Value - Limit Value

Spectrum Parameter	Setting
Attenuation	Auto
Start Frequency	1000 MHz
Stop Frequency	10th carrier harmonic
RBW / VBW (Emission in restricted band)	1 MHz / 3 MHz for Peak, 1 MHz / 1/T for Average

Receiver Parameter	Setting
Attenuation	Auto
Start ~ Stop Frequency	9 kHz~90 kHz for PK/AVG detector
Start ~ Stop Frequency	90 kHz~110 kHz for QP detector
Start ~ Stop Frequency	110 kHz~490 kHz for PK/AVG detector
Start ~ Stop Frequency	490 kHz~30 MHz for QP detector
Start ~ Stop Frequency	30 MHz~1000 MHz for QP detector

## 5.2 TEST PROCEDURE

- a. The measuring distance of 3 m shall be used for measurements. The EUT was placed on the top of a rotating table 0.8 meter above the ground at a 3 meter semi-anechoic chamber. The table was rotated 360 degrees to determine the position of the highest radiation.(below 1 GHz)
- b. The measuring distance of 3 m shall be used for measurements. The EUT was placed on the top of a rotating table 1.5 meter above the ground at a 3 meter semi-anechoic chamber. The table was rotated 360 degrees to determine the position of the highest radiation.(above 1 GHz)
- c. The height of the equipment or of the substitution antenna shall be 0.8m or 1.5m; the height of the test antenna shall vary between 1 m to 4 m. Both horizontal and vertical polarizations of the antenna are set to make the measurement.
- d. For each suspected emission, the EUT was arranged to its worst case and then the antenna was tuned to heights find the maximum reading (used Bore sight function).
- e. The receiver system was set to peak and average detect function and specified bandwidth with maximum hold mode when the test frequency is above 1 GHz.
- f. The initial step in collecting radiated emission data is a receiver peak detector mode pre-scanning the measurement frequency range. Significant peaks are then marked and then Quasi Peak detector mode re-measured.
- g. All readings are Peak unless otherwise stated QP in column of Note. Peak denotes that the Peak reading compliance with the QP Limits and then QP Mode measurement didn't perform. (below 1 GHz)
- h. All readings are Peak Mode value unless otherwise stated AVG in column of Note. If the Peak Mode Measured value compliance with the Peak Limits and lower than AVG Limits, the EUT shall be deemed to meet both Peak & AVG Limits and then only Peak Mode was measured, but AVG Mode didn't perform. (above 1 GHz)
- i. For the actual test configuration, please refer to the related Item -EUT Test Photos.

## 5.3 DEVIATION FROM TEST STANDARD

No deviation

**5.4 TEST SETUP**

**9 kHz-30 MHz**

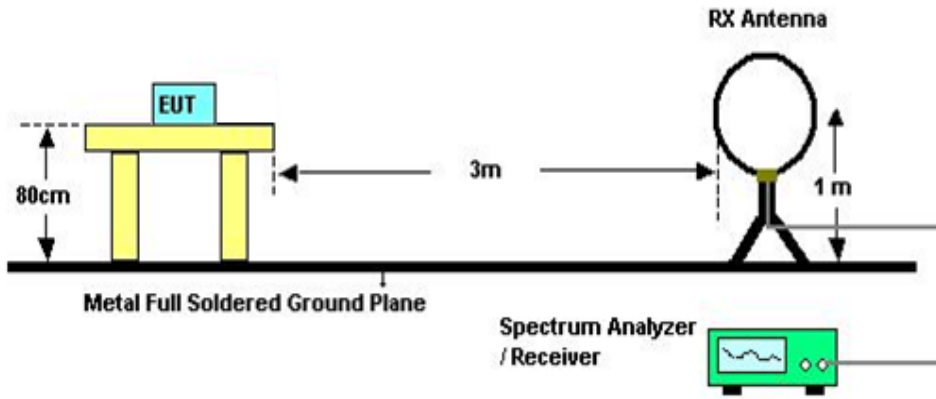

**30 MHz to 1 GHz**

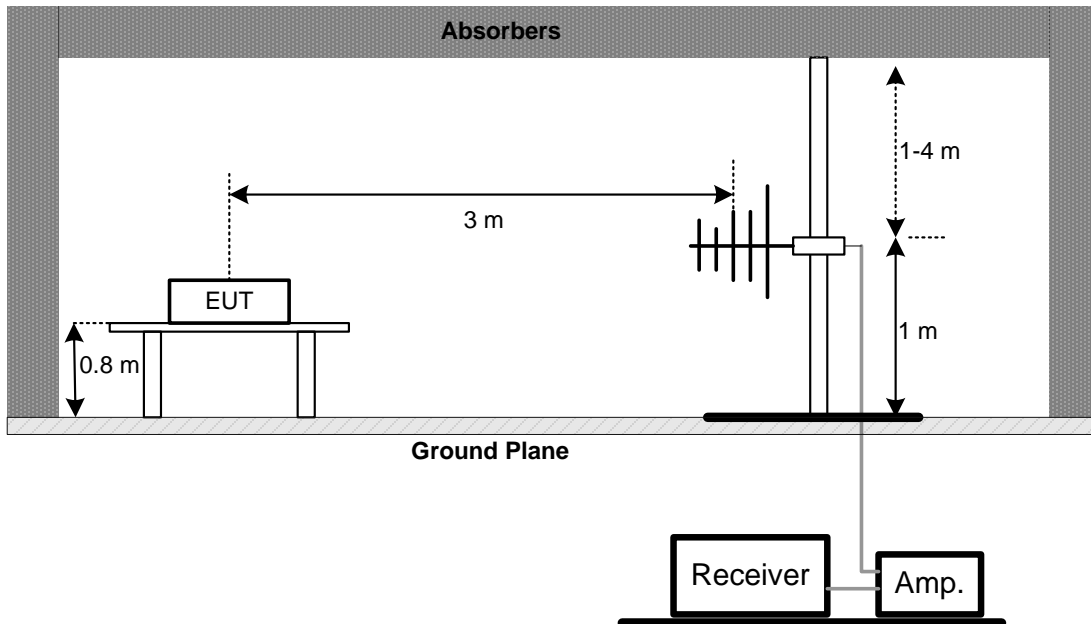

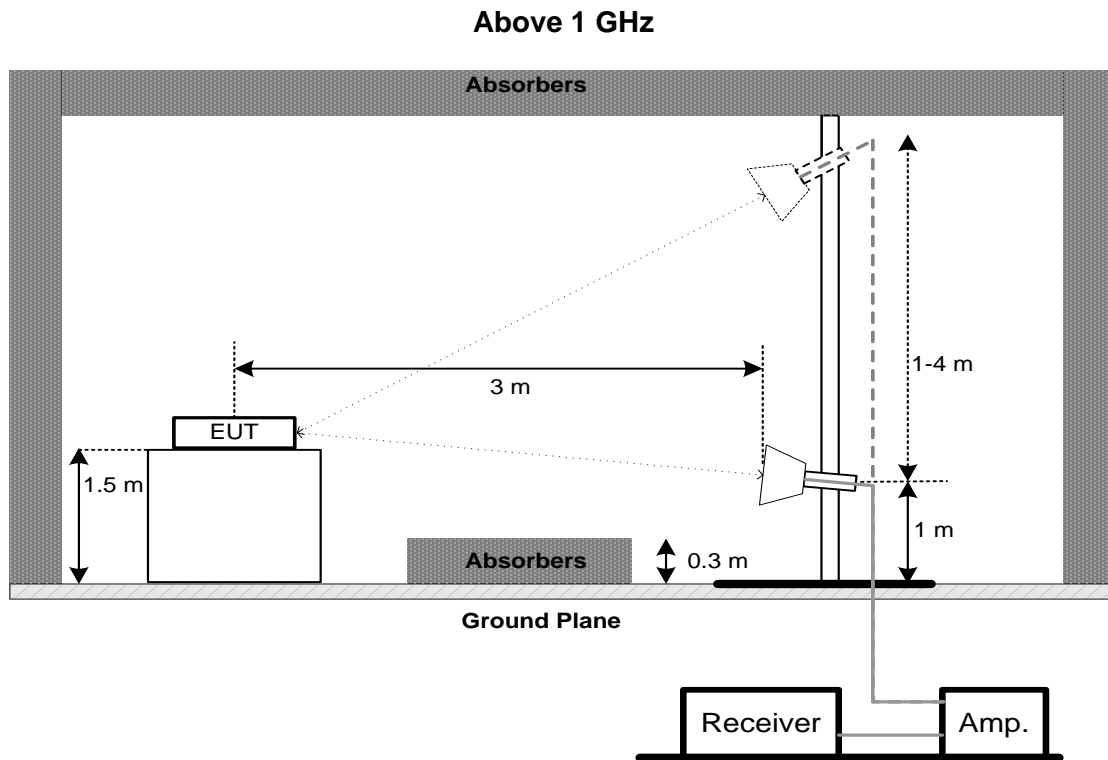

**5.5 EUT OPERATION CONDITIONS**

The EUT was programmed to be in continuously transmitting mode.

**5.6 EUT TEST CONDITIONS**

Temperature: 22°C   Relative Humidity: 56%   Test Voltage: AC 120V/60Hz

**5.7 TEST RESULTS - 9 KHZ TO 30 MHZ**

Please refer to the APPENDIX B

Remark:

- (1) Distance extrapolation factor =  $40 \log (\text{specific distance} / \text{test distance})$  (dB).
- (2) Limit line = specific limits (dBuV) + distance extrapolation factor.

**5.8 TEST RESULTS - 30 MHZ TO 1000 MHZ**

Please refer to the APPENDIX C.

**5.9 TEST RESULTS - ABOVE 1000 MHZ**

Please refer to the APPENDIX D.

Remark:

- (1) No limit: This is fundamental signal, the judgment is not applicable.  
For fundamental signal judgment was referred to Peak output test.

## 6. BANDWIDTH TEST

### 6.1 LIMIT

FCC Part15, Subpart C (15.247)		
Section	Test Item	Limit
15.247(a)(2)	6 dB Bandwidth	Minimum 500 kHz
	99% Emission Bandwidth	-

### 6.2 TEST PROCEDURE

- The EUT was directly connected to the spectrum analyzer and antenna output port as show in the block diagram below.
- Spectrum Setting: RBW= 100 kHz, VBW=300 kHz, Sweep time = 2.5 ms.
- The bandwidth was performed in accordance with method 11.8.1 of ANSI C63.10-2013.

### 6.3 DEVIATION FROM STANDARD

No deviation.

### 6.4 TEST SETUP



### 6.5 EUT OPERATION CONDITIONS

The EUT was programmed to be in continuously transmitting mode.

### 6.6 EUT TEST CONDITIONS

Temperature: 25°C    Relative Humidity: 55%    Test Voltage: AC 120V/60Hz

### 6.7 TEST RESULTS

Please refer to the APPENDIX E.

## 7. MAXIMUM OUTPUT POWER TEST

### 7.1 LIMIT

FCC Part15, Subpart C (15.247)		
Section	Test Item	Limit
15.247(b)(3)	Maximum Output Power	1 Watt or 30dBm

### 7.2 TEST PROCEDURE

- a. The EUT was directly connected to the power meter and antenna output port as show in the block diagram below.
- b. The maximum conducted output power was performed in accordance with method 11.9.1.3 (for peak power) or 11.9.2.3.1 (for AVG power) of ANSI C63.10-2013 and FCC KDB 662911 D01 v02r01 Multiple Transmitter Output.

### 7.3 DEVIATION FROM STANDARD

No deviation.

### 7.4 TEST SETUP



### 7.5 EUT OPERATION CONDITIONS

The EUT was programmed to be in continuously transmitting mode.

### 7.6 EUT TEST CONDITIONS

Temperature: 25°C    Relative Humidity: 55%    Test Voltage: AC 120V/60Hz

### 7.7 TEST RESULTS

Please refer to the APPENDIX F.

## 8. CONDUCTED SPURIOUS EMISSIONS

### 8.1 LIMIT

For FCC

In any 100 kHz bandwidth outside the frequency band in which the spread spectrum or digitally modulated intentional radiator is operating, the radio frequency power that is produced by the intentional radiator shall be at least 20 dB below that in the 100 kHz bandwidth within the band that contains the highest level of the desired power, based on either an RF conducted or a radiated measurement, provided the transmitter demonstrates compliance with the peak Output Power limits. If the transmitter complies with the Output Power limits based on the use of RMS averaging over a time interval, as permitted under paragraph (b)(3) of this section, the attenuation required under this paragraph shall be 30 dB instead of 20 dB. Attenuation below the general limits specified in Section 15.209(a) is not required. In addition, radiated emissions which fall in the restricted bands, as defined in Section 15.205(a), must also comply with the radiated emission limits specified in Section 15.209(a) (see Section 15.205(c)).

For ISSED

In any 100 kHz bandwidth outside the frequency band in which the spread spectrum or digitally modulated device is operating, the RF power that is produced shall be at least 20 dB below that in the 100 kHz bandwidth within the band that contains the highest level of the desired power, based on either an RF conducted or a radiated measurement, provided that the transmitter demonstrates compliance with the peak Output Power limits. If the transmitter complies with the Output Power limits based on the use of root-mean-square averaging over a time interval, as permitted under section 5.4(d), the attenuation required shall be 30 dB instead of 20 dB. Attenuation below the general field strength limits specified in RSS-Gen is not required.

### 8.2 TEST PROCEDURE

- a. The EUT was directly connected to the spectrum analyzer and antenna output port as show in the block diagram below.
- b. Spectrum Setting: RBW= 100 kHz, VBW=300 kHz, Sweep time = Auto.

### 8.3 DEVIATION FROM STANDARD

No deviation.

### 8.4 TEST SETUP



### 8.5 EUT OPERATION CONDITIONS

The EUT was programmed to be in continuously transmitting mode.

### 8.6 EUT TEST CONDITIONS

Temperature: 25°C    Relative Humidity: 55%    Test Voltage: AC 120V/60Hz

### 8.7 TEST RESULTS

Please refer to the APPENDIX G.



## 9. POWER SPECTRAL DENSITY TEST

### 9.1 LIMIT

FCC Part15, Subpart C (15.247)		
Section	Test Item	Limit
15.247(e)	Power Spectral Density	8 dBm (in any 3 kHz)

### 9.2 TEST PROCEDURE

- a. The EUT was directly connected to the spectrum analyzer and antenna output port as show in the block diagram below.
- b. Spectrum Setting: RBW=3 kHz, VBW=10 kHz, Sweep time = Auto.
- c. The Power Spectral Density was performed in accordance with method 11.10.2 of ANSI C63.10-2013.

### 9.3 DEVIATION FROM STANDARD

No deviation.

### 9.4 TEST SETUP

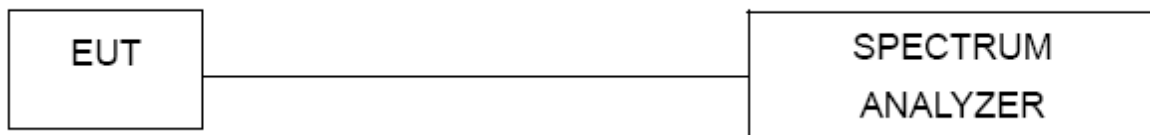

### 9.5 EUT OPERATION CONDITIONS

The EUT was programmed to be in continuously transmitting mode.

### 9.6 EUT TEST CONDITIONS

Temperature: 25°C    Relative Humidity: 55%    Test Voltage: AC 120V/60Hz

### 9.7 TEST RESULTS

Please refer to the APPENDIX H.

## 10. MEASUREMENT INSTRUMENTS LIST

AC Power Line Conducted Emissions					
Item	Kind of Equipment	Manufacturer	Type No.	Serial No.	Calibrated until
1	Line Impedance Stabilisation Network	Schwarzbeck	NNLK 8121	8121-822	Mar. 29, 2020
2	TWO-LINE V-NETWORK	R&S	ENV216	101340	Nov. 20, 2019
3	Test Cable	emci	EMCRG400-BM-NM-10000	170628	Apr. 17, 2020
4	EMI Test Receiver	R&S	ESCI	100082	Mar. 29, 2020
5	50Ω Terminator	SHX	TF2-1G-A	17051602	Mar. 29, 2020
6	50Ω coaxial switch	Anritsu	MP59B	6201750902	Mar. 29, 2020

Radiated Emissions - 9 kHz to 30 MHz					
Item	Kind of Equipment	Manufacturer	Type No.	Serial No.	Calibrated until
1	Loop Antenna	EMCI	EMCI LPA600	275	Mar. 29, 2020
2	EMI Test Receiver	R&S	ESCI	100082	Mar. 29, 2020
3	Measurement Software	Farad	EZ-EMC Ver.NB-03A1-01	N/A	N/A

Radiated Emissions - 30 MHz to 1 GHz					
Item	Kind of Equipment	Manufacturer	Type No.	Serial No.	Calibrated until
1	TRILOG Broadband Antenna	Schwarzbeck	VULB 9168	719	Mar. 29, 2020
2	Pre-Amplifier	emci	EMC9135	980400	Mar. 29, 2020
3	MXE EMI Receiver	Keysight	N9038A	MY57150106	Mar. 29, 2020
4	Test Cable	emci	EMC104-SM-SM-7000	170330	Apr. 17, 2020
5	Test Cable	emci	EMC104-SM-SM-1000	170331	Apr. 17, 2020
6	Test Cable	emci	EMC104-SM-NM-3500	170621	Apr. 17, 2020
7	Measurement Software	Farad	EZ-EMC Ver.NB-03A1-01	N/A	N/A

Radiated Emissions - Above 1 GHz					
Item	Kind of Equipment	Manufacturer	Type No.	Serial No.	Calibrated until
1	Double-Ridged Waveguide Horn Antenna	ETS-Lindgren	9120D	00206960	Mar. 29, 2020
2	Pre-Amplifier	emci	EMC012645SE	980421	Mar. 29, 2020
3	EXA Spectrum Analyzer	Keysight	N9010A	MY56480545	Mar. 29, 2020
4	Test Cable	emci	EMC104-SM-SM-7000	170330	Apr. 17, 2020
5	Test Cable	emci	EMC104-SM-SM-1000	170331	Apr. 17, 2020
6	Test Cable	emci	EMC104-SM-NM-3500	170621	Apr. 17, 2020
7	Measurement Software	Farad	EZ-EMC Ver.NB-03A1-01	N/A	N/A
8	MXE EMI Receiver	Keysight	N9038A	MY57150106	Mar. 29, 2020

Bandwidth					
Item	Kind of Equipment	Manufacturer	Type No.	Serial No.	Calibrated until
1	Spectrum Analyzer	R&S	FSP40	100626	Mar. 29, 2020

Peak Output Power					
Item	Kind of Equipment	Manufacturer	Type No.	Serial No.	Calibrated until
1	Spectrum Analyzer	R&S	FSP40	100626	Mar. 29, 2020

Antenna Conducted Spurious Emissions					
Item	Kind of Equipment	Manufacturer	Type No.	Serial No.	Calibrated until
1	Spectrum Analyzer	R&S	FSP40	100626	Mar. 29, 2020

Power Spectral Density					
Item	Kind of Equipment	Manufacturer	Type No.	Serial No.	Calibrated until
1	Spectrum Analyzer	R&S	FSP40	100626	Mar. 29, 2020

Remark: "N/A" denotes no model name, serial no. or calibration specified.  
 All calibration period of equipment list is one year.

## APPENDIX A - AC POWER LINE CONDUCTED EMISSIONS

Test Mode: TX B MODE CHANNEL 06

Line

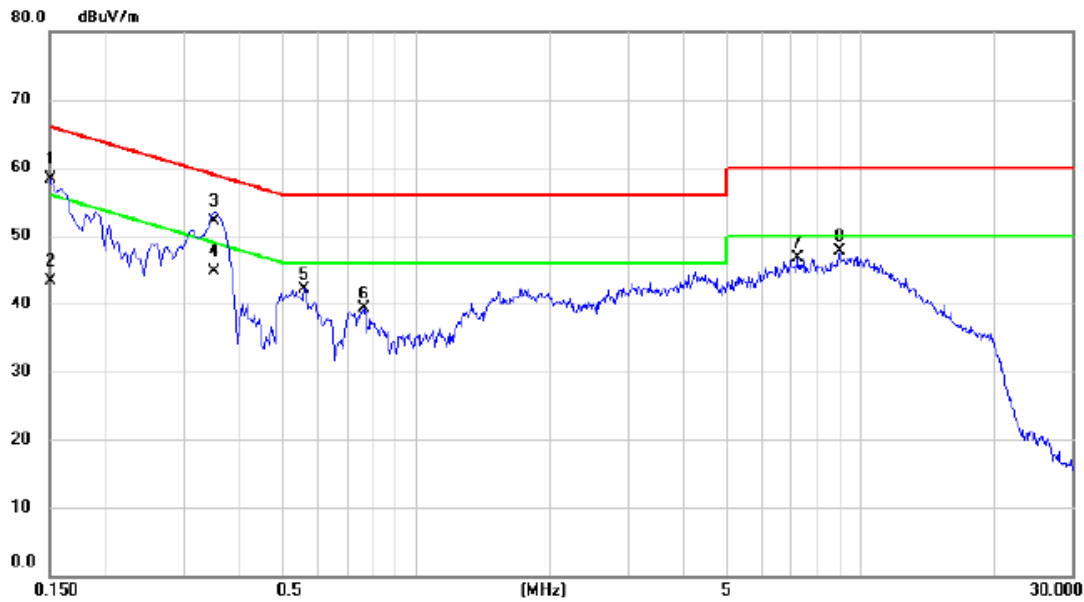

No.	Mk.	Freq. MHz	Reading Level dBuV/m	Correct Factor dB	Measure- ment dBuV/m	Limit dBuV/m	Margin dB	Detector	Comment
1		0.1500	48.48	9.75	58.23	66.00	-7.77	QP	
2		0.1500	33.50	9.75	43.25	56.00	-12.75	AVG	
3		0.3525	42.30	9.83	52.13	58.90	-6.77	QP	
4	*	0.3525	34.80	9.83	44.63	48.90	-4.27	AVG	
5		0.5594	32.24	9.96	42.20	56.00	-13.80	peak	
6		0.7620	29.56	9.78	39.34	56.00	-16.66	peak	
7		7.2195	36.79	9.85	46.64	60.00	-13.36	peak	
8		8.9880	37.77	9.86	47.63	60.00	-12.37	peak	

REMARKS:

- (1) Measurement Value = Reading Level + Correct Factor.
- (2) Margin Level = Measurement Value - Limit Value.

Test Mode: TX B MODE CHANNEL 06

Neutral

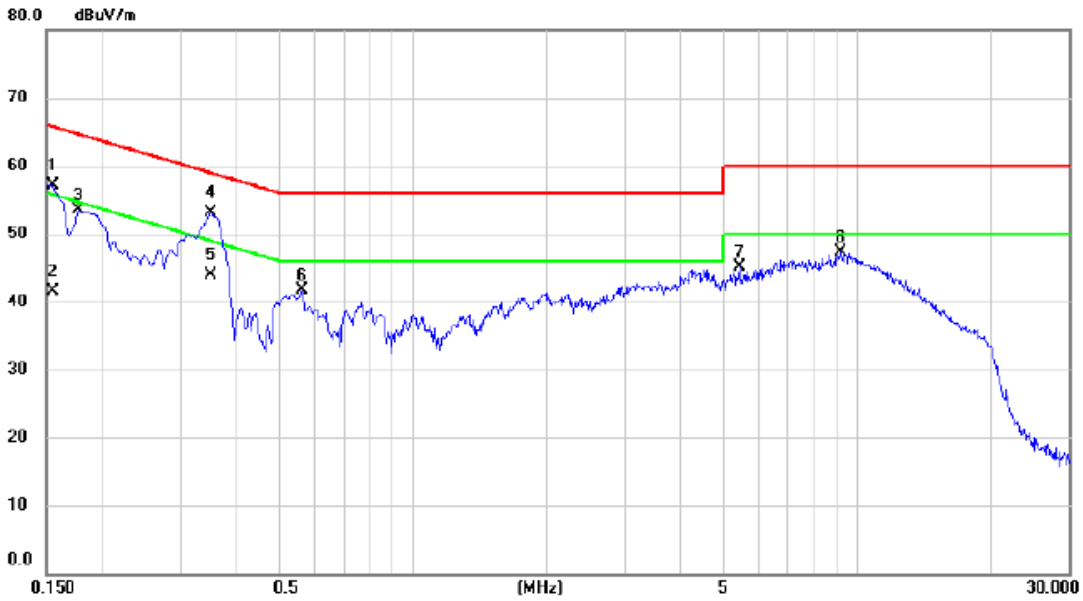

No.	Mk.	Freq. MHz	Reading Level dBuV/m	Correct Factor dB	Measure- ment dBuV/m	Limit dBuV/m	Margin dB	Detector	Comment
1		0.1545	47.57	9.61	57.18	65.75	-8.57	QP	
2		0.1545	31.90	9.61	41.51	55.75	-14.24	AVG	
3		0.1770	43.91	9.58	53.49	64.63	-11.14	peak	
4		0.3525	43.38	9.76	53.14	58.90	-5.76	QP	
5	*	0.3525	34.20	9.76	43.96	48.90	-4.94	AVG	
6		0.5640	31.87	9.79	41.66	56.00	-14.34	peak	
7		5.4465	35.19	9.83	45.02	60.00	-14.98	peak	
8		9.1995	37.57	9.83	47.40	60.00	-12.60	peak	

REMARKS:

- (1) Measurement Value = Reading Level + Correct Factor.
- (2) Margin Level = Measurement Value - Limit Value.

## APPENDIX B - RADIATED EMISSION - 9 KHZ TO 30 MHZ

Test Mode: TX B MODE CHANNEL 06

Ant 0°

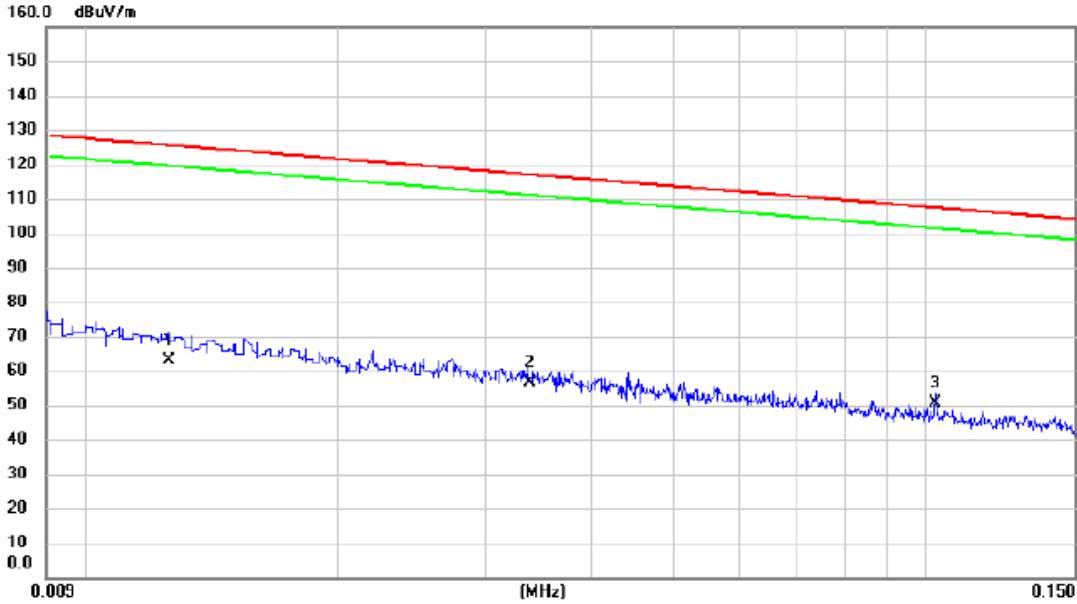

No.	Mk.	Freq. MHz	Reading Level dBuV	Correct Factor dB	Measure- ment dBuV/m	Limit dBuV/m	Margin dB	Detector	Comment
1		0.0126	-13.70	76.81	63.11	125.60	-62.49	AVG	
2		0.0338	-12.08	68.56	56.48	117.03	-60.55	AVG	
3	*	0.1025	-7.30	57.85	50.55	107.39	-56.84	QP	

REMARKS:

- (1) Measurement Value = Reading Level + Correct Factor.
- (2) Margin Level = Measurement Value - Limit Value.



Test Mode: TX B MODE CHANNEL 06

Ant 0°

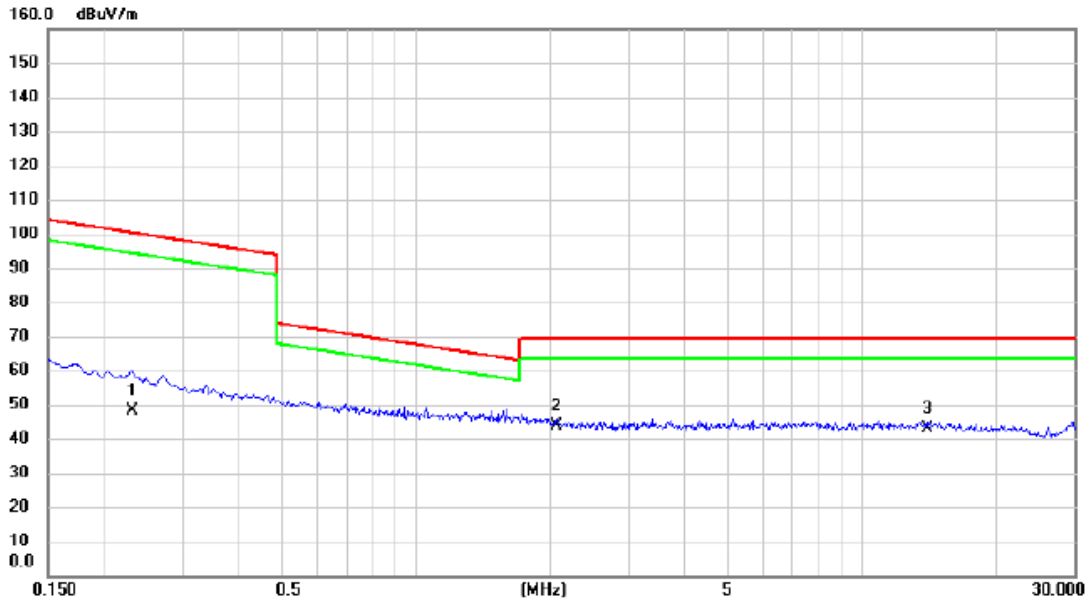

No.	Mk.	Freq. MHz	Reading Level dBuV	Correct Factor dB	Measure- ment dBuV/m	Limit dBuV/m	Margin dB	Detector	Comment
1		0.2310	-2.90	51.05	48.15	100.33	-52.18	AVG	
2	*	2.0715	5.20	38.74	43.94	69.54	-25.60	QP	
3		14.0685	5.00	38.18	43.18	69.54	-26.36	QP	

REMARKS:

- (1) Measurement Value = Reading Level + Correct Factor.
- (2) Margin Level = Measurement Value - Limit Value.

Test Mode: TX B MODE CHANNEL 06

Ant 90°

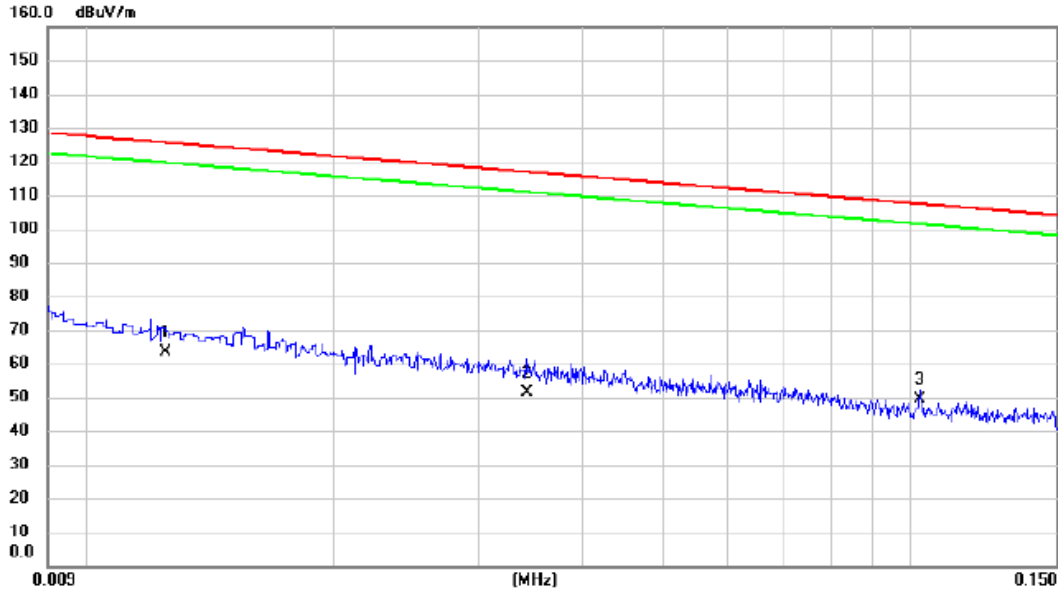

No.	Mk.	Freq.	Reading Level	Correct Factor	Measurement	Limit	Margin	Detector	Comment
		MHz	dBuV	dB	dBuV/m	dBuV/m	dB		
1		0.0125	-13.30	76.88	63.58	125.67	-62.09	AVG	
2		0.0343	-16.83	68.41	51.58	116.90	-65.32	AVG	
3	*	0.1026	-8.47	57.85	49.38	107.38	-58.00	QP	

REMARKS:

- (1) Measurement Value = Reading Level + Correct Factor.
- (2) Margin Level = Measurement Value - Limit Value.

Test Mode: TX B MODE CHANNEL 06

Ant 90°

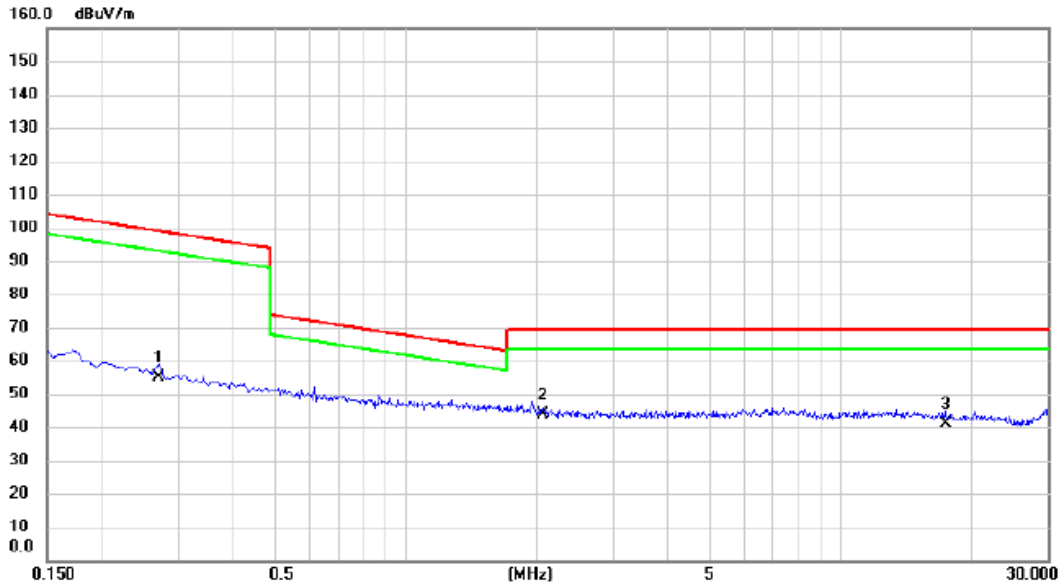

No.	Mk.	Freq. MHz	Reading Level dBuV	Correct Factor dB	Measure- ment dBuV/m	Limit dBuV/m	Margin dB	Detector	Comment
1		0.2714	5.51	49.67	55.18	98.93	-43.75	AVG	
2	*	2.0760	4.90	38.74	43.64	69.54	-25.90	QP	
3		17.4210	3.84	37.26	41.10	69.54	-28.44	QP	

REMARKS:

- (1) Measurement Value = Reading Level + Correct Factor.
- (2) Margin Level = Measurement Value - Limit Value.

## APPENDIX C - RADIATED EMISSION - 30 MHZ TO 1000 MHZ

Test Mode: TX B MODE CHANNEL 06

**Vertical**

80 dBuV/m

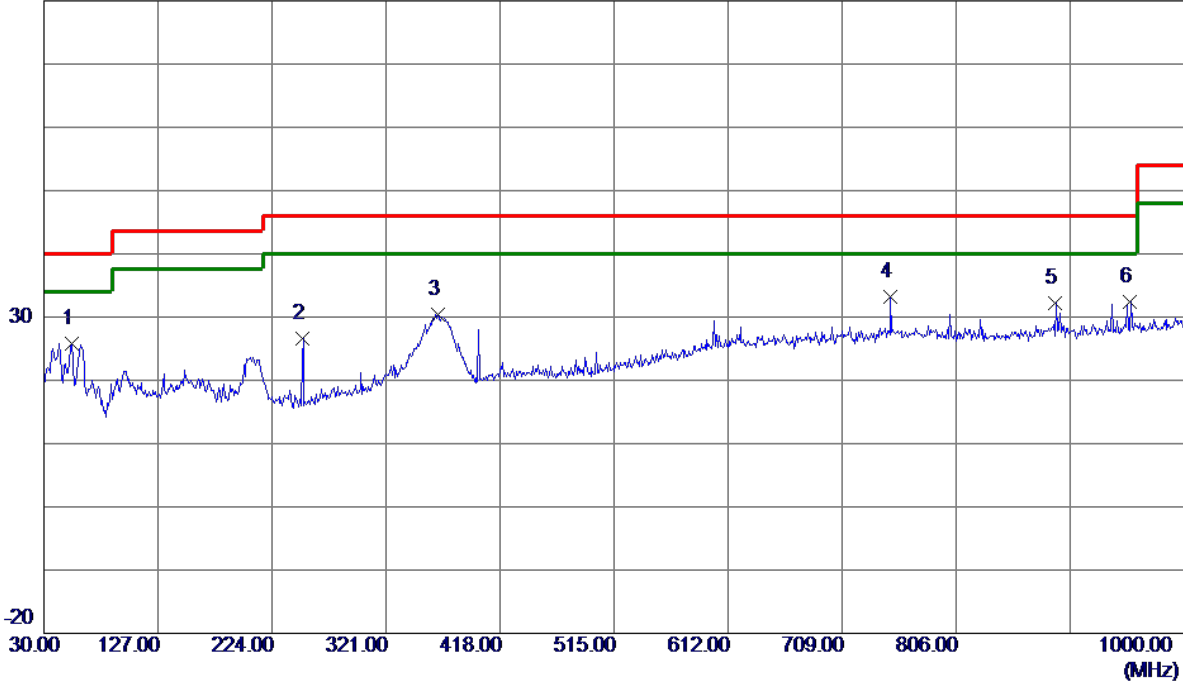

No.	Freq. MHz	Reading Level dBuV/m	Correct Factor dB	Measurement dBuV/m	Limit dBuV/m	Margin dB	Detector	Comment
1	53.2800	40.96	-15.10	25.86	40.00	-14.14	Peak	
2	250.1900	41.33	-14.72	26.61	46.00	-19.39	Peak	
3	365.1350	41.61	-11.23	30.38	46.00	-15.62	Peak	
4 *	750.2250	37.54	-4.29	33.25	46.00	-12.75	Peak	
5	890.3900	36.81	-4.63	32.18	46.00	-13.82	Peak	
6	953.4400	36.76	-4.35	32.41	46.00	-13.59	Peak	

**REMARKS:**

- (1) Measurement Value = Reading Level + Correct Factor.
- (2) Margin Level = Measurement Value - Limit Value.

Test Mode: TX B MODE CHANNEL 06

Horizontal

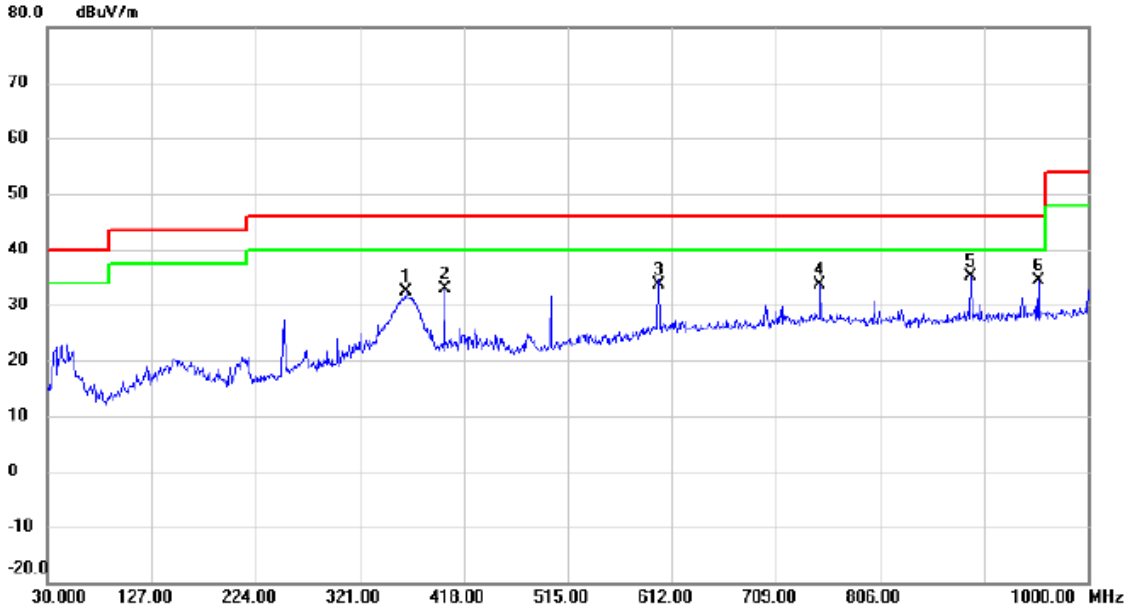

No.	Mk.	Freq. MHz	Reading Level dBuV	Correct Factor dB	Measure- ment dBuV/m	Limit dBuV/m	Margin dB	Detector	Comment
1		364.6500	43.48	-11.22	32.26	46.00	-13.74	peak	
2		400.0550	44.03	-11.25	32.78	46.00	-13.22	peak	
3		599.8750	39.47	-5.88	33.59	46.00	-12.41	peak	
4		750.2250	37.94	-4.29	33.65	46.00	-12.35	peak	
5	*	890.3900	39.76	-4.63	35.13	46.00	-10.87	peak	
6		953.4400	38.81	-4.35	34.46	46.00	-11.54	peak	

REMARKS:

- (1) Measurement Value = Reading Level + Correct Factor.
- (2) Margin Level = Measurement Value - Limit Value.

## APPENDIX D - RADIATED EMISSION- ABOVE 1000 MHZ

Test Mode: TX B Mode 2412 MHz

Vertical

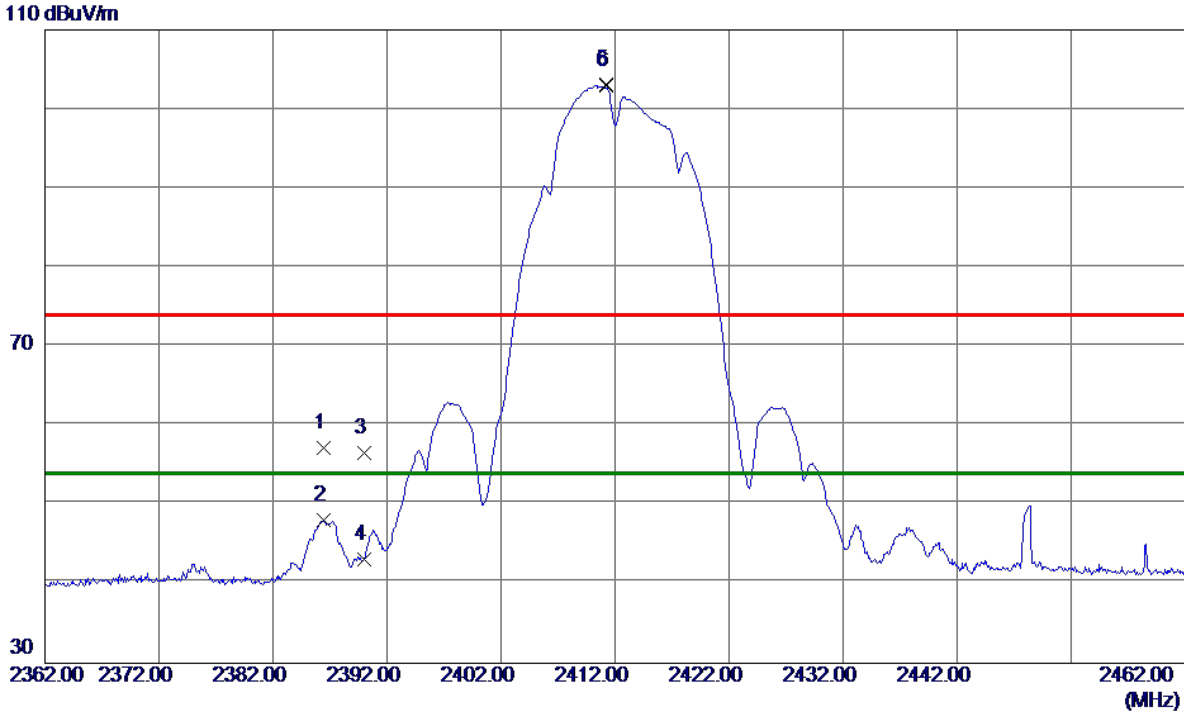

No.	Freq. MHz	Reading Level dBuV/m	Correct Factor dB	Measure ment dBuV/m	Limit dBuV/m	Margin dB	Detector	Comment
1	2386.4000	23.96	33.24	57.20	74.00	-16.80	Peak	
2	2386.4000	14.91	33.24	48.15	54.00	-5.85	AVG	
3	2390.0000	23.27	33.25	56.52	74.00	-17.48	Peak	
4	2390.0000	9.89	33.25	43.14	54.00	-10.86	AVG	
5	2411.2000	69.81	33.31	103.12	74.00	29.12	Peak	No limit
6 *	2411.2000	69.65	33.31	102.96	54.00	48.96	AVG	No limit

REMARKS:

- (1) Measurement Value = Reading Level + Correct Factor.
- (2) Margin Level = Measurement Value - Limit Value.



Test Mode: TX B Mode 2412 MHz

**Vertical**

80 dBuV/m

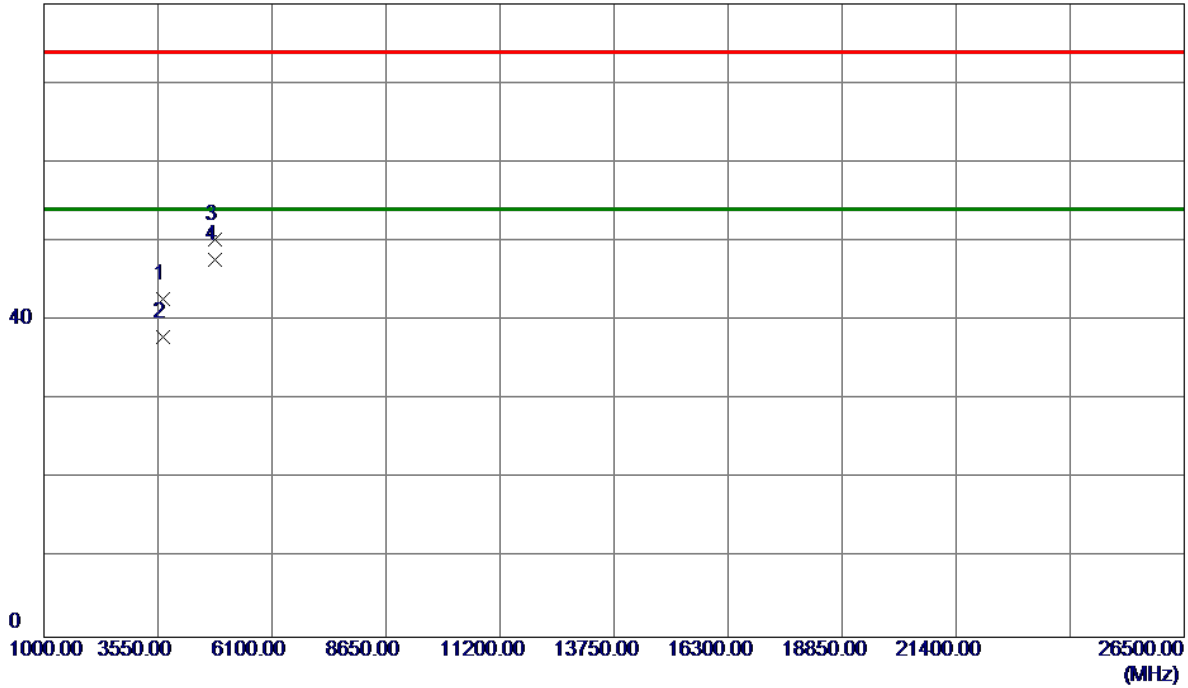

No.	Freq. MHz	Reading Level dBuV/m	Correct Factor dB	Measure ment dBuV/m	Limit dBuV/m	Margin dB	Detector	Comment
1	3666.4650	55.57	-12.88	42.69	74.00	-31.31	Peak	
2	3666.6450	50.85	-12.88	37.97	54.00	-16.03	AVG	
3	4823.9750	59.19	-8.99	50.20	74.00	-23.80	Peak	
4 *	4823.9850	56.70	-8.99	47.71	54.00	-6.29	AVG	

**REMARKS:**

(1) Measurement Value = Reading Level + Correct Factor.

(2) Margin Level = Measurement Value - Limit Value.

Test Mode: TX B Mode 2412 MHz

Horizontal

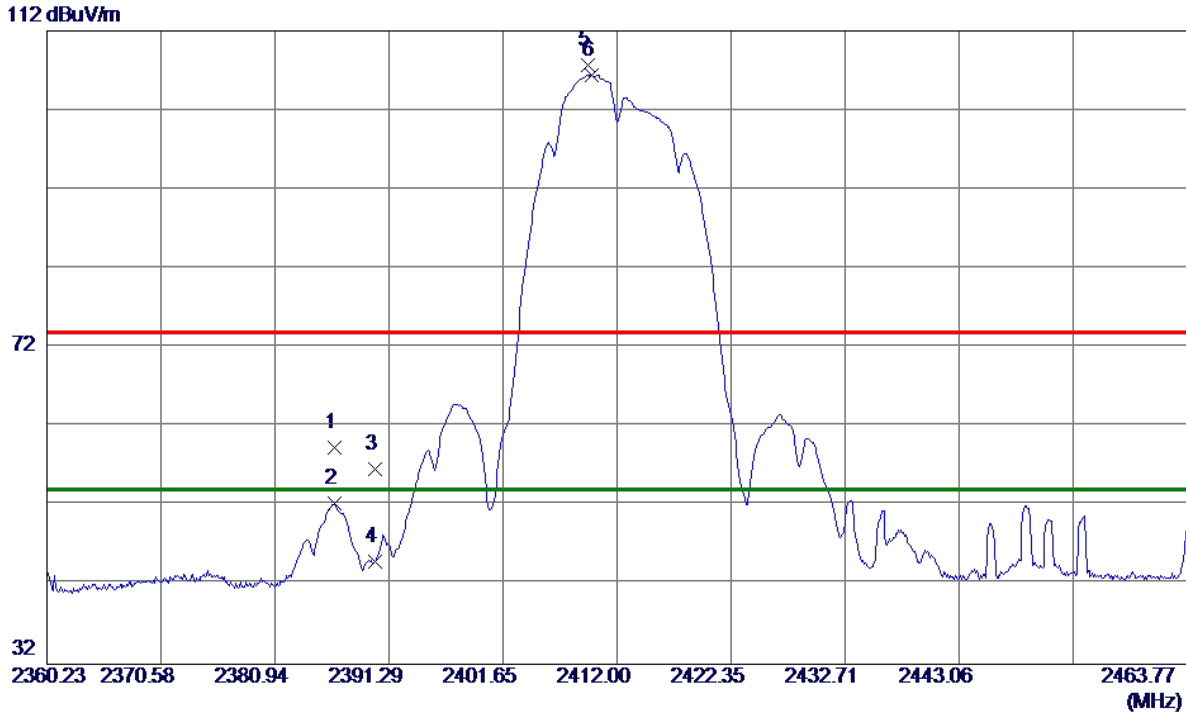

No.	Freq. MHz	Reading Level dBuV/m	Correct Factor dB	Measure ment dBuV/m	Limit dBuV/m	Margin dB	Detector	Comment
1	2386.3200	26.06	33.24	59.30	74.00	-14.70	Peak	
2	2386.3200	19.12	33.24	52.36	54.00	-1.64	AVG	
3	2390.0000	23.32	33.25	56.57	74.00	-17.43	Peak	
4	2390.0000	11.69	33.25	44.94	54.00	-9.06	AVG	
5	2409.3080	74.44	33.30	107.74	74.00	33.74	Peak	No limit
6 *	2409.7220	73.11	33.30	106.41	54.00	52.41	AVG	No limit

REMARKS:

(1) Measurement Value = Reading Level + Correct Factor.

(2) Margin Level = Measurement Value - Limit Value.

Test Mode: TX B Mode 2412 MHz

**Horizontal**

80 dBuV/m

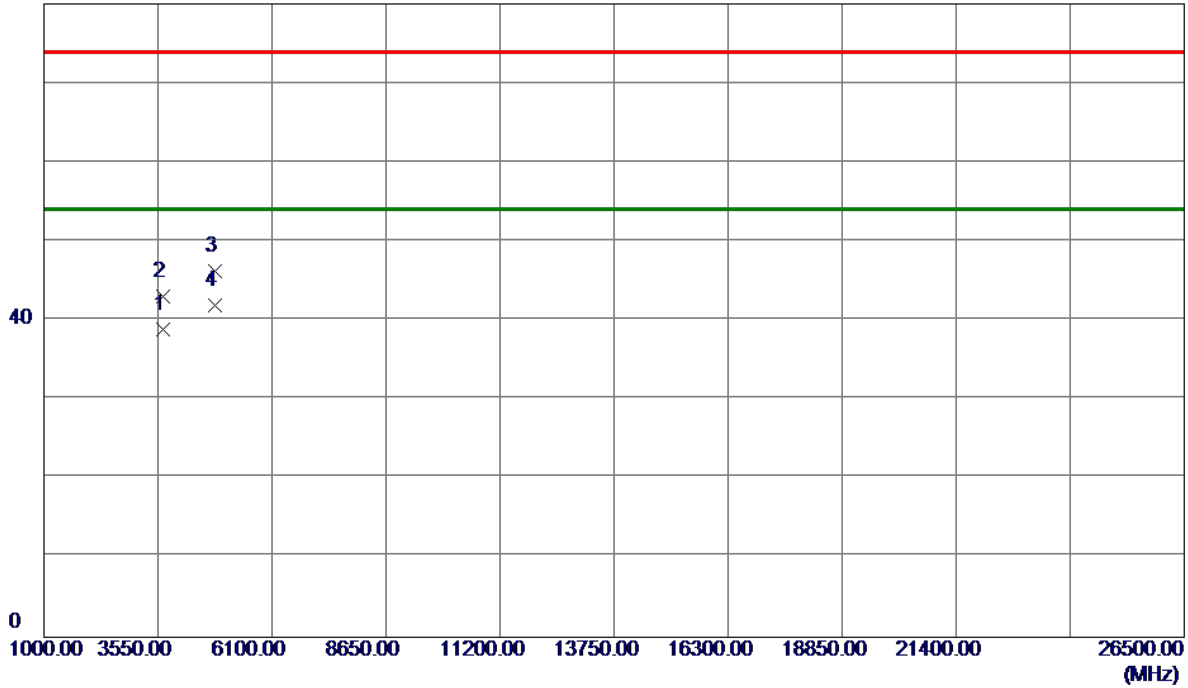

No.	Freq. MHz	Reading Level dBuV/m	Correct Factor dB	Measure ment dBuV/m	Limit dBuV/m	Margin dB	Detector	Comment
1	3666.5400	51.75	-12.88	38.87	54.00	-15.13	AVG	
2	3666.6200	55.91	-12.88	43.03	74.00	-30.97	Peak	
3	4823.9850	55.27	-8.99	46.28	74.00	-27.72	Peak	
4 *	4824.0200	50.93	-8.99	41.94	54.00	-12.06	AVG	

**REMARKS:**

- (1) Measurement Value = Reading Level + Correct Factor.
- (2) Margin Level = Measurement Value - Limit Value.

Test Mode: TX B Mode 2437 MHz

**Vertical**

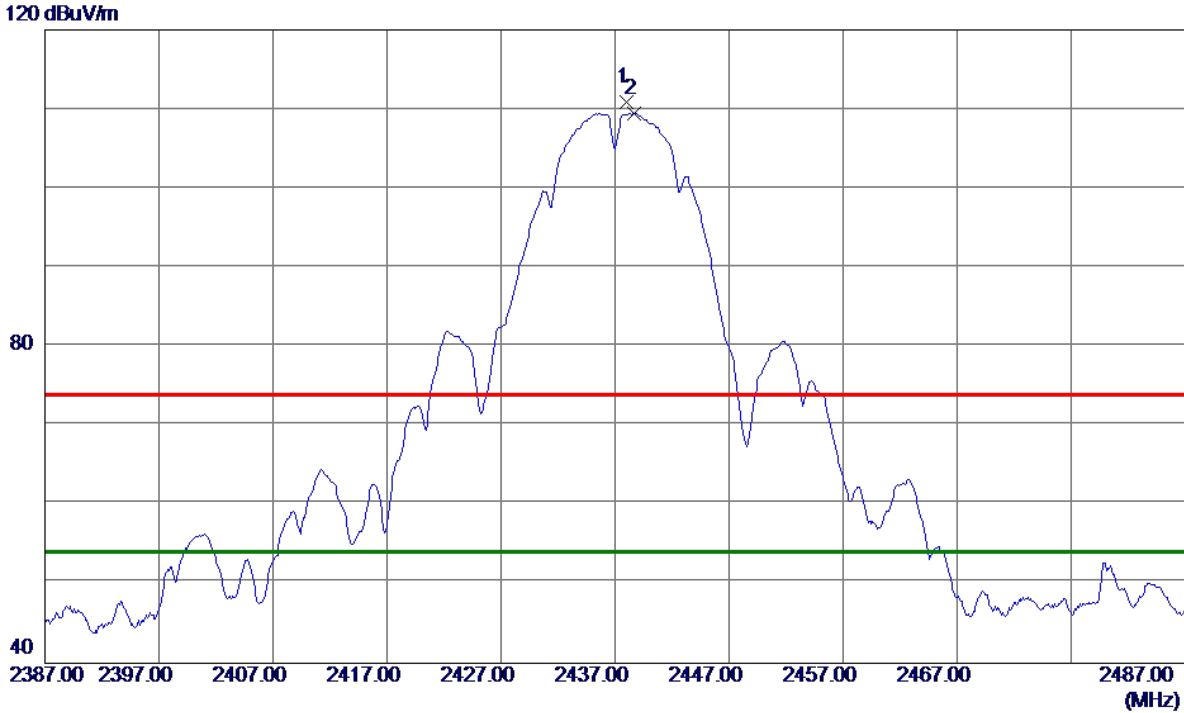

No.	Freq. MHz	Reading Level dBuV/m	Correct Factor dB	Measure ment dBuV/m	Limit dBuV/m	Margin dB	Detector	Comment
1	2438.0000	77.58	33.38	110.96	74.00	36.96	Peak	No limit
2 *	2438.7000	76.13	33.39	109.52	54.00	55.52	AVG	No limit

**REMARKS:**

- (1) Measurement Value = Reading Level + Correct Factor.
- (2) Margin Level = Measurement Value - Limit Value.

Test Mode: TX B Mode 2437 MHz

**Vertical**

80 dBuV/m

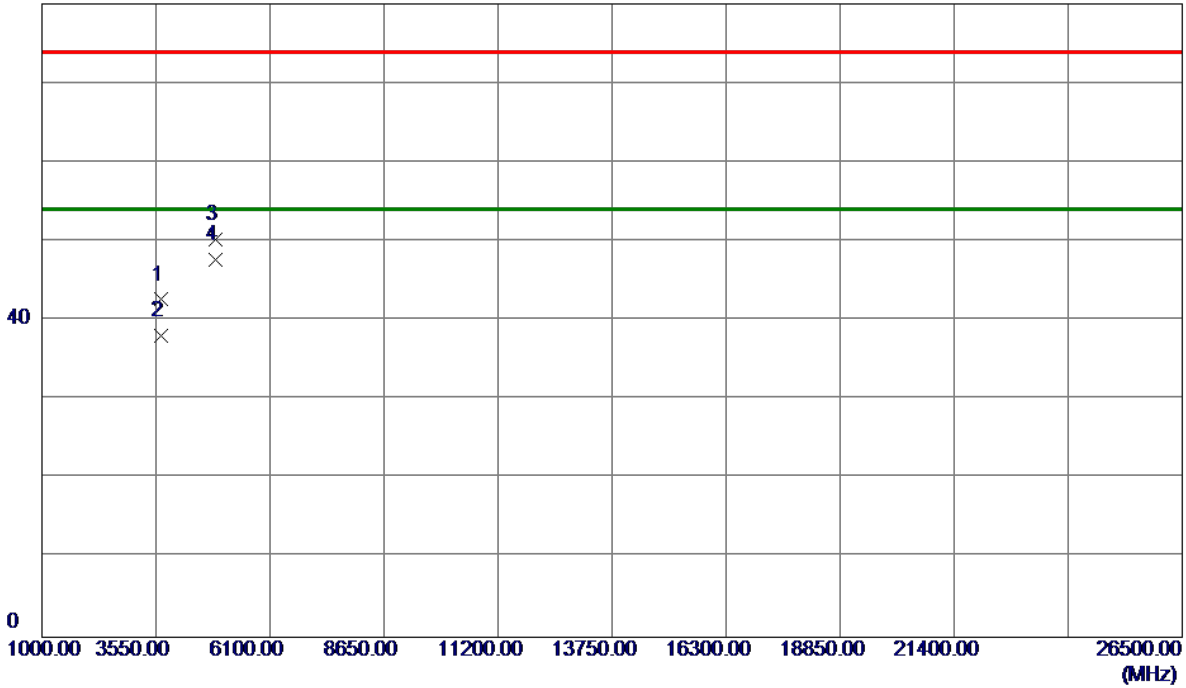

No.	Freq. MHz	Reading Level dBuV/m	Correct Factor dB	Measure ment dBuV/m	Limit dBuV/m	Margin dB	Detector	Comment
1	3666.4450	55.52	-12.88	42.64	74.00	-31.36	Peak	
2	3666.5410	50.90	-12.88	38.02	54.00	-15.98	AVG	
3	4873.9850	59.05	-8.80	50.25	74.00	-23.75	Peak	
4 *	4873.9870	56.56	-8.80	47.76	54.00	-6.24	AVG	

**REMARKS:**

(1) Measurement Value = Reading Level + Correct Factor.

(2) Margin Level = Measurement Value - Limit Value.

Test Mode: TX B Mode 2437 MHz

**Horizontal**

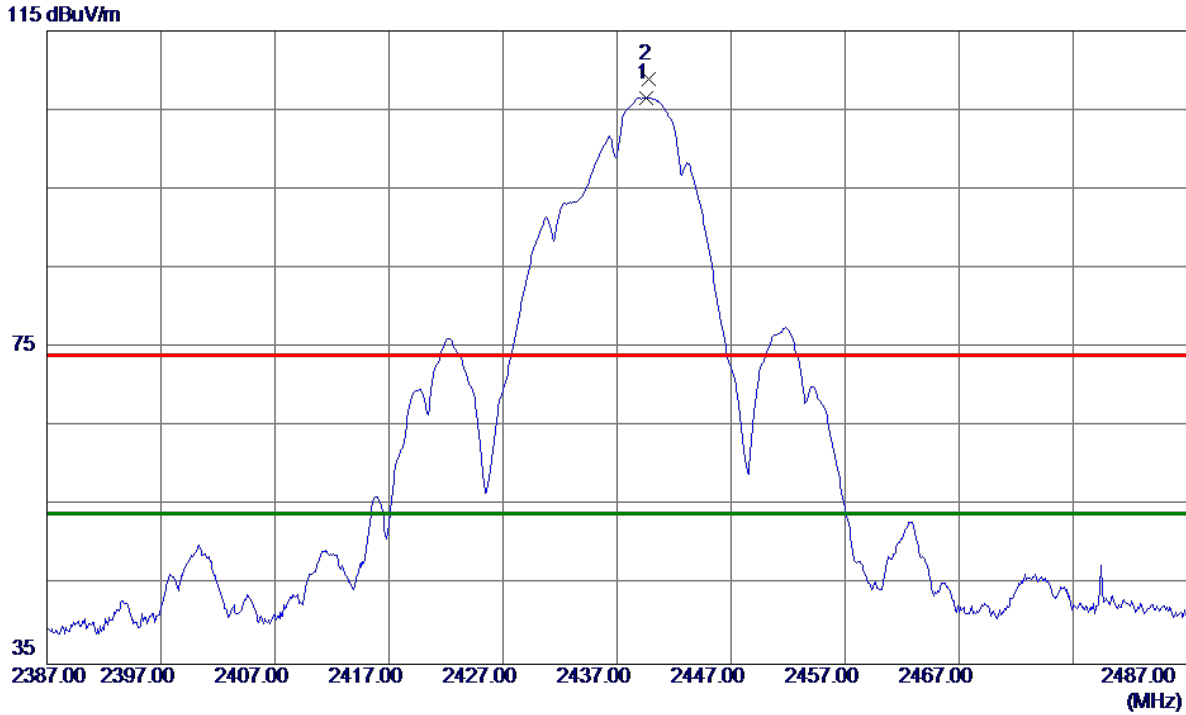

No.	Freq. MHz	Reading Level dBuV/m	Correct Factor dB	Measure ment dBuV/m	Limit dBuV/m	Margin dB	Detector	Comment
1 *	2439.6000	73.18	33.39	106.57	54.00	52.57	AVG	No limit
2	2439.8000	75.54	33.39	108.93	74.00	34.93	Peak	No limit

**REMARKS:**

(1) Measurement Value = Reading Level + Correct Factor.

(2) Margin Level = Measurement Value - Limit Value.

Test Mode: TX B Mode 2437 MHz

**Horizontal**

80 dBuV/m

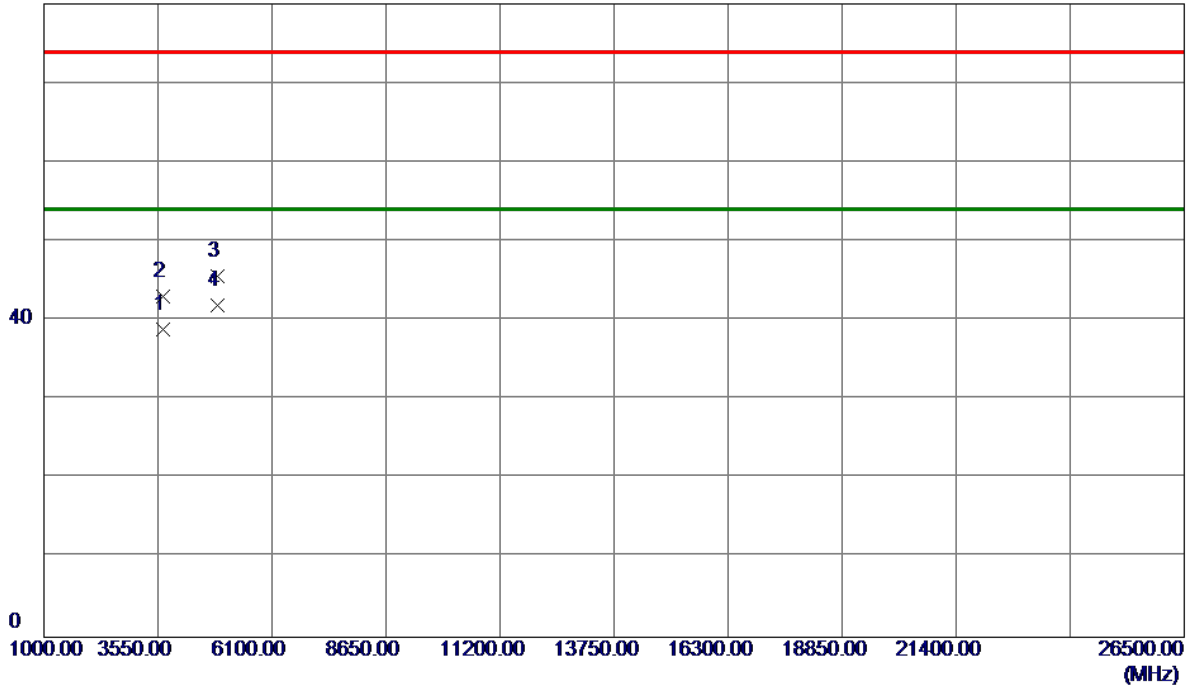

No.	Freq. MHz	Reading Level dBuV/m	Correct Factor dB	Measure ment dBuV/m	Limit dBuV/m	Margin dB	Detector	Comment
1	3666.5300	51.73	-12.88	38.85	54.00	-15.15	AVG	
2	3666.6400	55.94	-12.88	43.06	74.00	-30.94	Peak	
3	4874.0120	54.38	-8.80	45.58	74.00	-28.42	Peak	
4 *	4874.0200	50.69	-8.80	41.89	54.00	-12.11	AVG	

**REMARKS:**

- (1) Measurement Value = Reading Level + Correct Factor.
- (2) Margin Level = Measurement Value - Limit Value.

Test Mode: TX B Mode 2462 MHz

### Vertical

115 dBuV/m

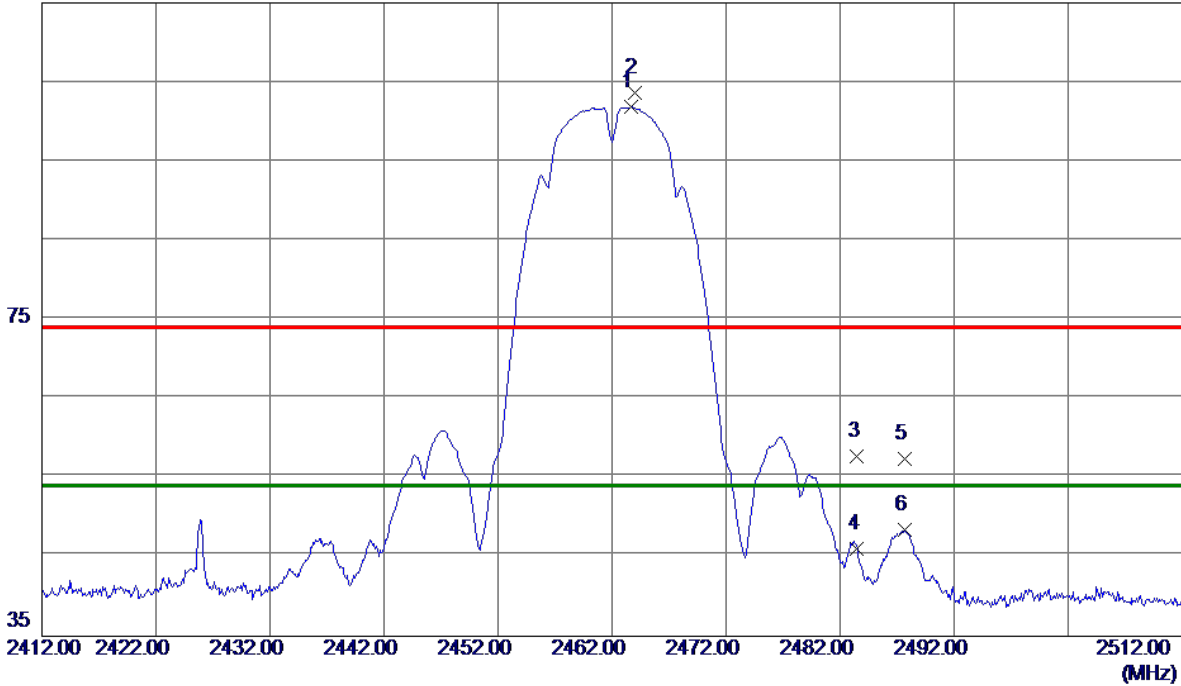

No.	Freq. MHz	Reading Level dBuV/m	Correct Factor dB	Measure ment dBuV/m	Limit dBuV/m	Margin dB	Detector	Comment
1 *	2463.7000	68.37	33.46	101.83	54.00	47.83	AVG	No limit
2	2464.0000	70.20	33.46	103.66	74.00	29.66	Peak	No limit
3	2483.5000	24.21	33.51	57.72	74.00	-16.28	Peak	
4	2483.5000	12.57	33.51	46.08	54.00	-7.92	AVG	
5	2487.7000	23.92	33.52	57.44	74.00	-16.56	Peak	
6	2487.7000	14.91	33.52	48.43	54.00	-5.57	AVG	

#### REMARKS:

- (1) Measurement Value = Reading Level + Correct Factor.
- (2) Margin Level = Measurement Value - Limit Value.



Test Mode: TX B Mode 2462 MHz

Vertical

80 dBuV/m

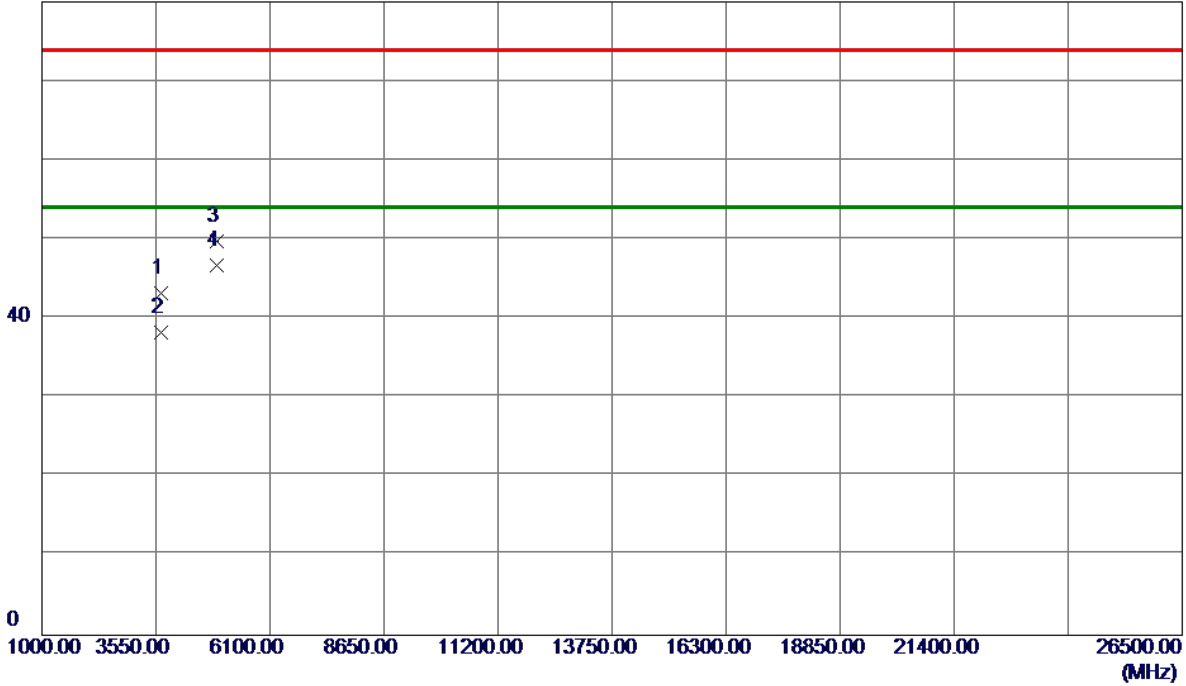

No.	Freq. MHz	Reading Level dBuV/m	Correct Factor dB	Measure ment dBuV/m	Limit dBuV/m	Margin dB	Detector	Comment
1	3666.4950	56.05	-12.88	43.17	74.00	-30.83	Peak	
2	3666.6000	51.11	-12.88	38.23	54.00	-15.77	AVG	
3	4923.9600	58.38	-8.61	49.77	74.00	-24.23	Peak	
4 *	4924.0000	55.29	-8.60	46.69	54.00	-7.31	AVG	

REMARKS:

(1) Measurement Value = Reading Level + Correct Factor.

(2) Margin Level = Measurement Value - Limit Value.

Test Mode: TX B Mode 2462 MHz

### Horizontal

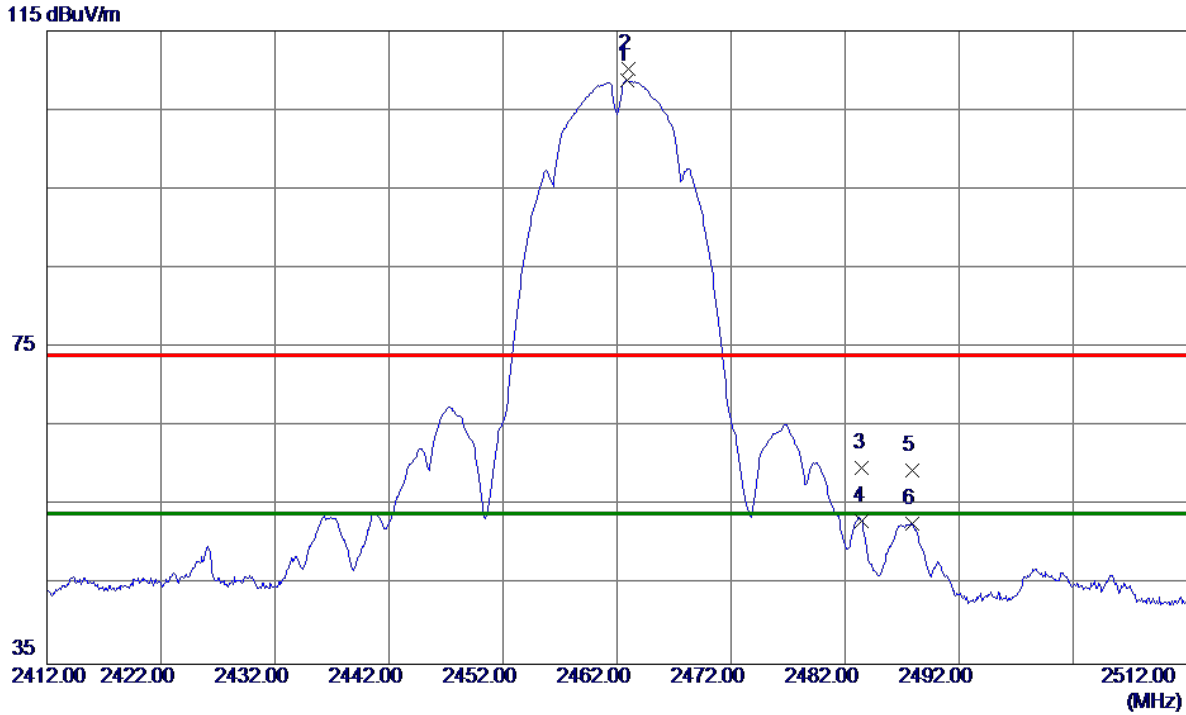

No.	Freq. MHz	Reading Level dBuV/m	Correct Factor dB	Measure ment dBuV/m	Limit dBuV/m	Margin dB	Detector	Comment
1 *	2462.9000	75.33	33.45	108.78	54.00	54.78	AVG	No limit
2	2463.0000	76.74	33.45	110.19	74.00	36.19	Peak	No limit
3	2483.5000	26.36	33.51	59.87	74.00	-14.13	Peak	
4	2483.5000	19.50	33.51	53.01	54.00	-0.99	AVG	
5	2487.9000	25.99	33.53	59.52	74.00	-14.48	Peak	
6	2487.9000	19.30	33.53	52.83	54.00	-1.17	AVG	

#### REMARKS:

- (1) Measurement Value = Reading Level + Correct Factor.
- (2) Margin Level = Measurement Value - Limit Value.

Test Mode: TX B Mode 2462 MHz

**Horizontal**

80 dBuV/m

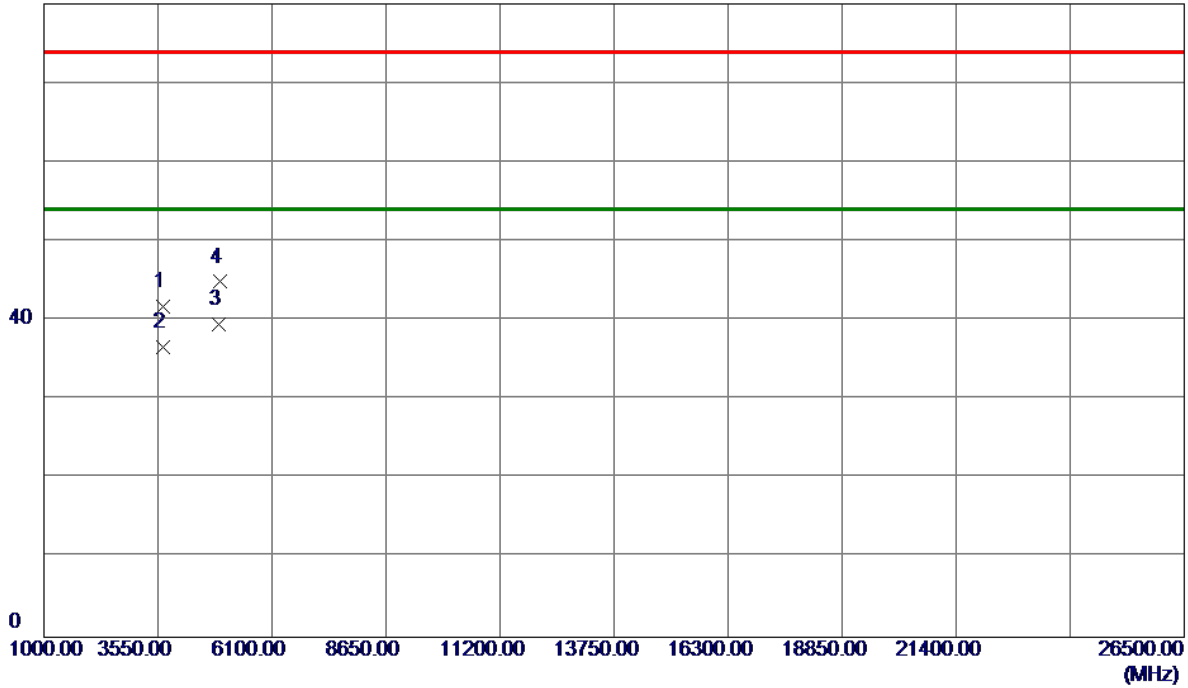

No.	Freq. MHz	Reading Level dBuV/m	Correct Factor dB	Measure ment dBuV/m	Limit dBuV/m	Margin dB	Detector	Comment
1	3666.5550	54.57	-12.88	41.69	74.00	-32.31	Peak	
2	3666.5550	49.55	-12.88	36.67	54.00	-17.33	AVG	
3 *	4923.9600	48.17	-8.61	39.56	54.00	-14.44	AVG	
4	4924.1750	53.48	-8.60	44.88	74.00	-29.12	Peak	

**REMARKS:**

- (1) Measurement Value = Reading Level + Correct Factor.
- (2) Margin Level = Measurement Value - Limit Value.

Test Mode: TX G Mode 2412 MHz

**Vertical**

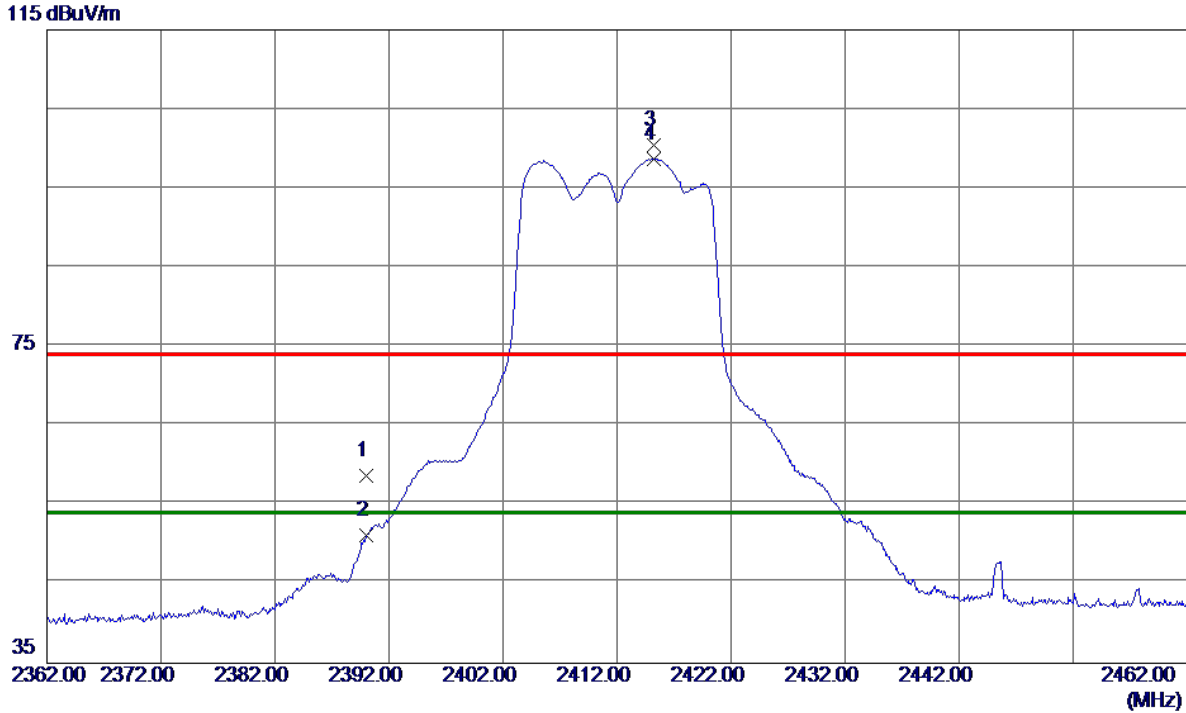

No.	Freq. MHz	Reading Level dBuV/m	Correct Factor dB	Measure ment dBuV/m	Limit dBuV/m	Margin dB	Detector	Comment
1	2390.0000	25.49	33.25	58.74	74.00	-15.26	Peak	
2	2390.0000	17.90	33.25	51.15	54.00	-2.85	AVG	
3	2415.2000	67.17	33.32	100.49	74.00	26.49	Peak	No limit
4 *	2415.2000	65.43	33.32	98.75	54.00	44.75	AVG	No limit

**REMARKS:**

- (1) Measurement Value = Reading Level + Correct Factor.
- (2) Margin Level = Measurement Value - Limit Value.

Test Mode: TX G Mode 2412 MHz

**Vertical**

80 dBuV/m

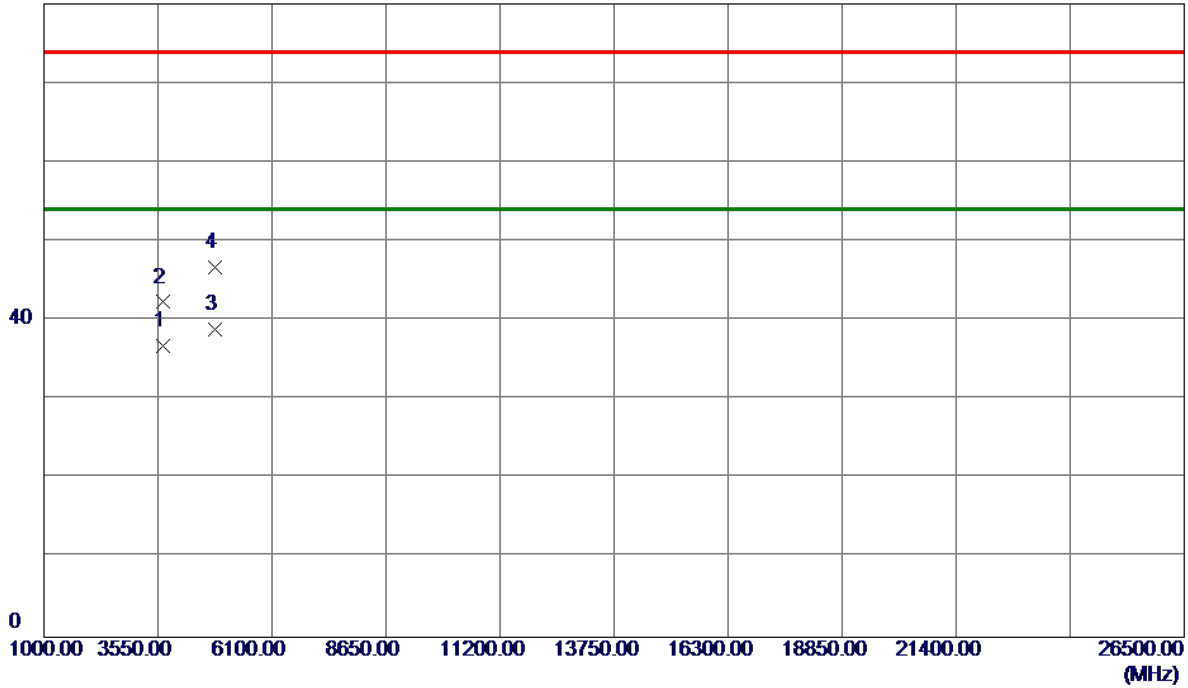

No.	Freq. MHz	Reading Level dBuV/m	Correct Factor dB	Measure ment dBuV/m	Limit dBuV/m	Margin dB	Detector	Comment
1	3666.5750	49.62	-12.88	36.74	54.00	-17.26	AVG	
2	3666.7050	55.20	-12.88	42.32	74.00	-31.68	Peak	
3 *	4822.7150	47.81	-9.00	38.81	54.00	-15.19	AVG	
4	4822.9650	55.74	-9.00	46.74	74.00	-27.26	Peak	

**REMARKS:**

(1) Measurement Value = Reading Level + Correct Factor.

(2) Margin Level = Measurement Value - Limit Value.

Test Mode: TX G Mode 2412 MHz

Horizontal

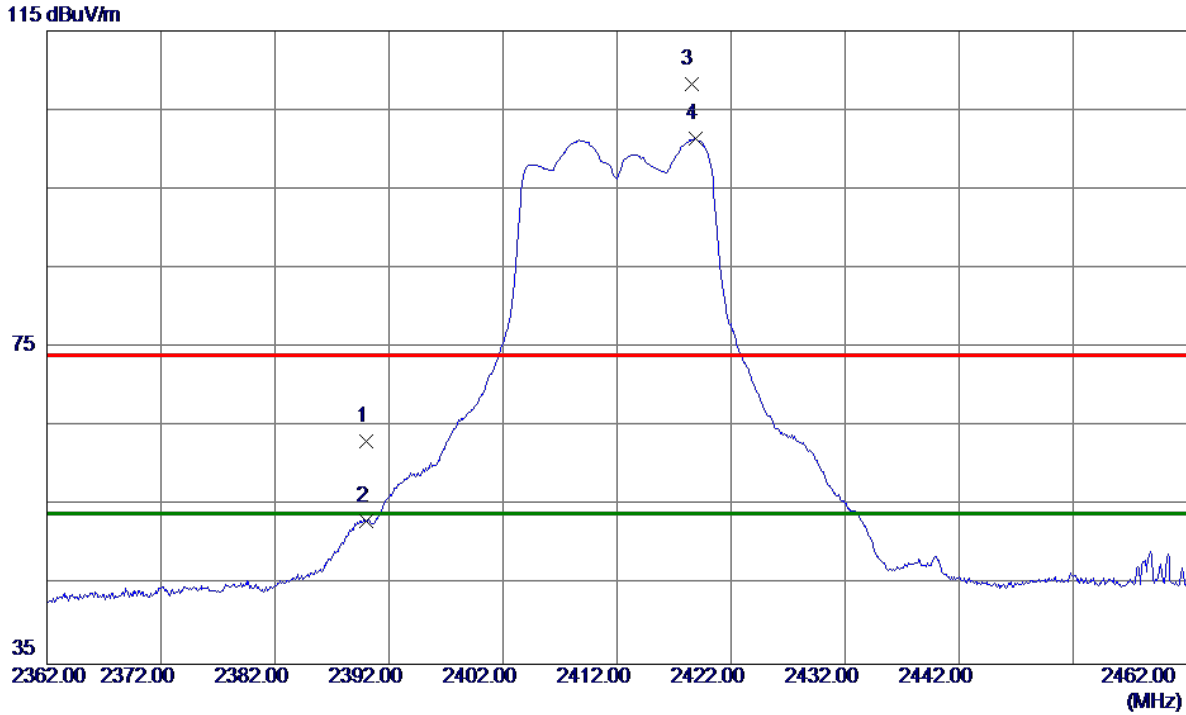

No.	Freq. MHz	Reading Level dBuV/m	Correct Factor dB	Measure ment dBuV/m	Limit dBuV/m	Margin dB	Detector	Comment
1	2390.0000	29.96	33.25	63.21	74.00	-10.79	Peak	
2	2390.0000	19.80	33.25	53.05	54.00	-0.95	AVG	
3	2418.5000	74.89	33.33	108.22	74.00	34.22	Peak	No limit
4 *	2418.9000	68.02	33.33	101.35	54.00	47.35	AVG	No limit

REMARKS:

- (1) Measurement Value = Reading Level + Correct Factor.
- (2) Margin Level = Measurement Value - Limit Value.

Test Mode: TX G Mode 2412 MHz

**Horizontal**

80 dBuV/m

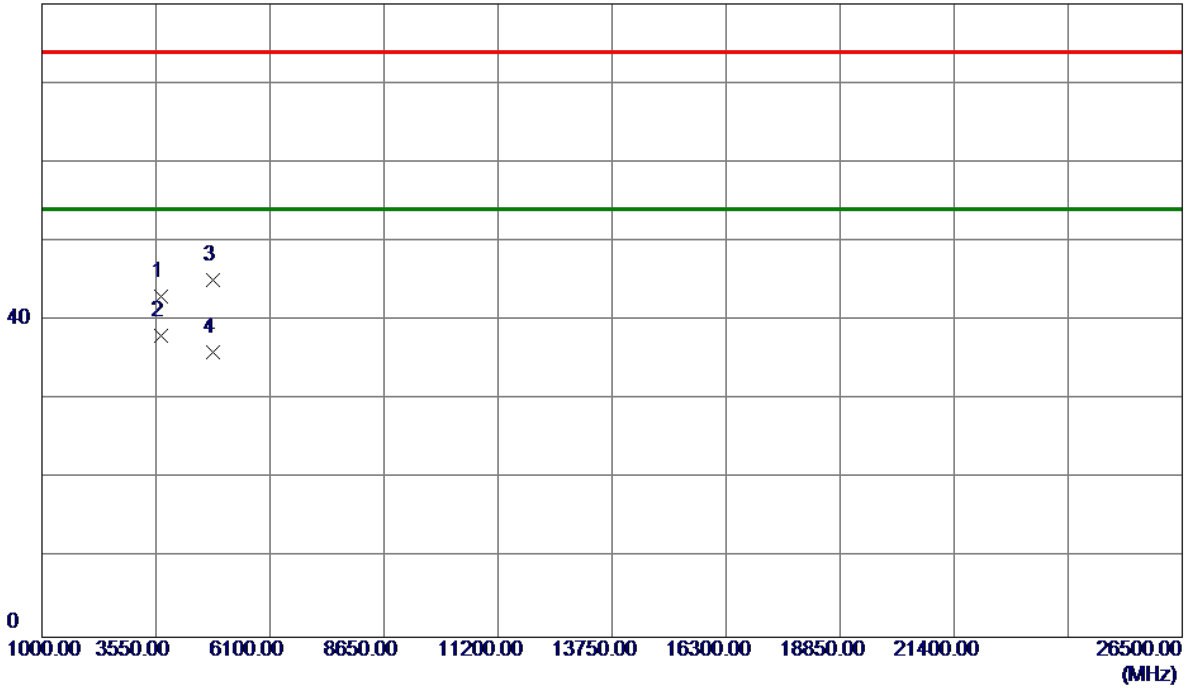

No.	Freq. MHz	Reading Level dBuV/m	Correct Factor dB	Measure ment dBuV/m	Limit dBuV/m	Margin dB	Detector	Comment
1	3666.5750	55.85	-12.88	42.97	74.00	-31.03	Peak	
2 *	3666.6150	50.93	-12.88	38.05	54.00	-15.95	AVG	
3	4820.9190	54.16	-9.00	45.16	74.00	-28.84	Peak	
4	4821.0179	45.06	-9.00	36.06	54.00	-17.94	AVG	

**REMARKS:**

- (1) Measurement Value = Reading Level + Correct Factor.
- (2) Margin Level = Measurement Value - Limit Value.

Test Mode: TX G Mode 2437 MHz

**Vertical**

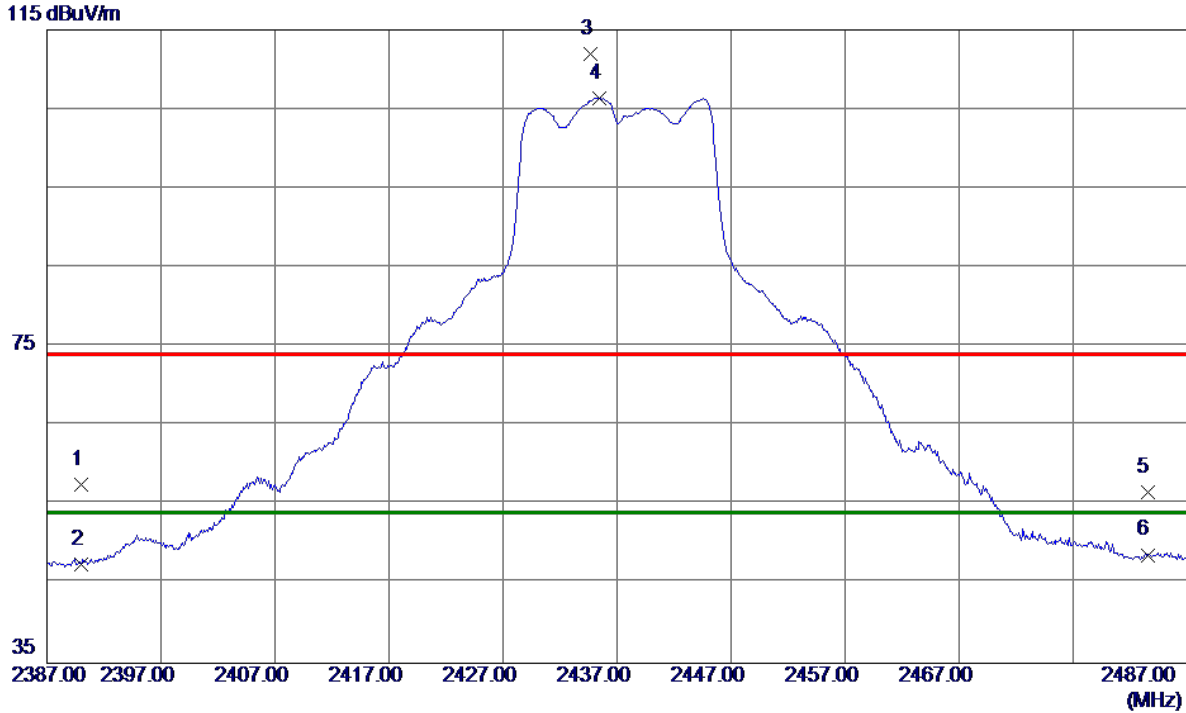

No.	Freq. MHz	Reading Level dBuV/m	Correct Factor dB	Measure ment dBuV/m	Limit dBuV/m	Margin dB	Detector	Comment
1	2390.0000	24.35	33.25	57.60	74.00	-16.40	Peak	
2	2390.0000	14.19	33.25	47.44	54.00	-6.56	AVG	
3	2434.7000	78.55	33.37	111.92	74.00	37.92	Peak	No limit
4 *	2435.4000	73.03	33.38	106.41	54.00	52.41	AVG	No limit
5	2483.5000	23.13	33.51	56.64	74.00	-17.36	Peak	
6	2483.5000	15.17	33.51	48.68	54.00	-5.32	AVG	

**REMARKS:**

- (1) Measurement Value = Reading Level + Correct Factor.
- (2) Margin Level = Measurement Value - Limit Value.



Test Mode: TX G Mode 2437 MHz

**Vertical**

80 dBuV/m

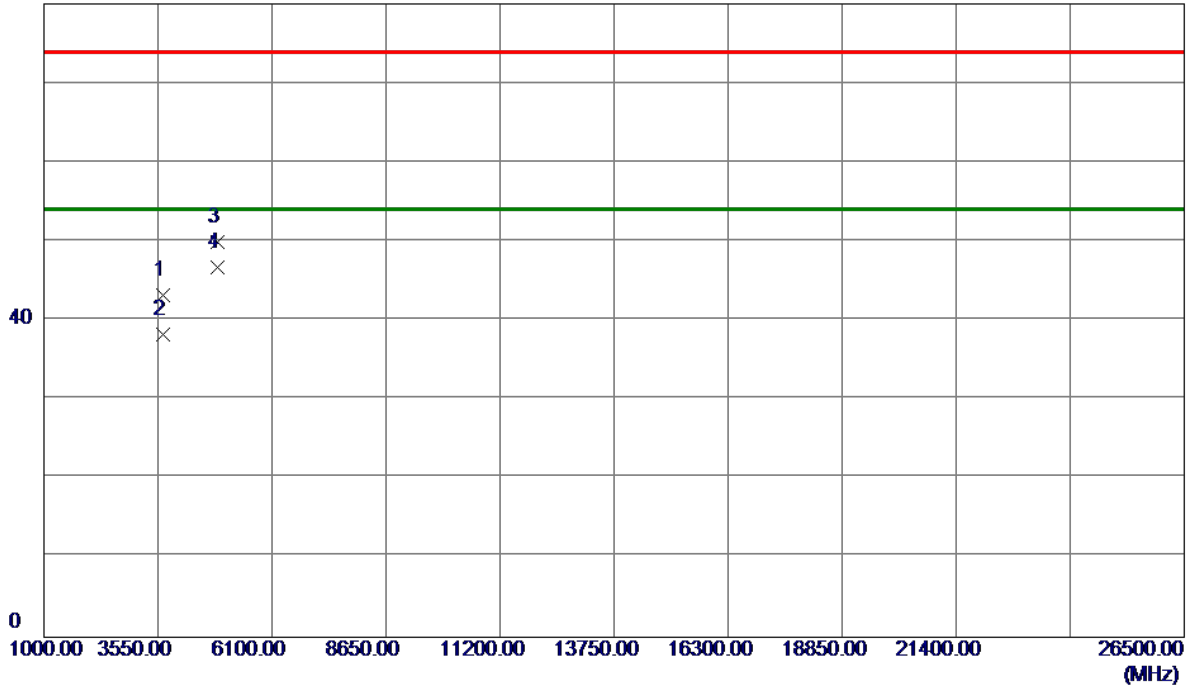

No.	Freq. MHz	Reading Level dBuV/m	Correct Factor dB	Measure ment dBuV/m	Limit dBuV/m	Margin dB	Detector	Comment
1	3666.4750	56.15	-12.88	43.27	74.00	-30.73	Peak	
2	3666.5900	51.19	-12.88	38.31	54.00	-15.69	AVG	
3	4873.9800	58.77	-8.80	49.97	74.00	-24.03	Peak	
4 *	4874.0000	55.54	-8.80	46.74	54.00	-7.26	AVG	

**REMARKS:**

(1) Measurement Value = Reading Level + Correct Factor.

(2) Margin Level = Measurement Value - Limit Value.

Test Mode: TX G Mode 2437 MHz

**Horizontal**

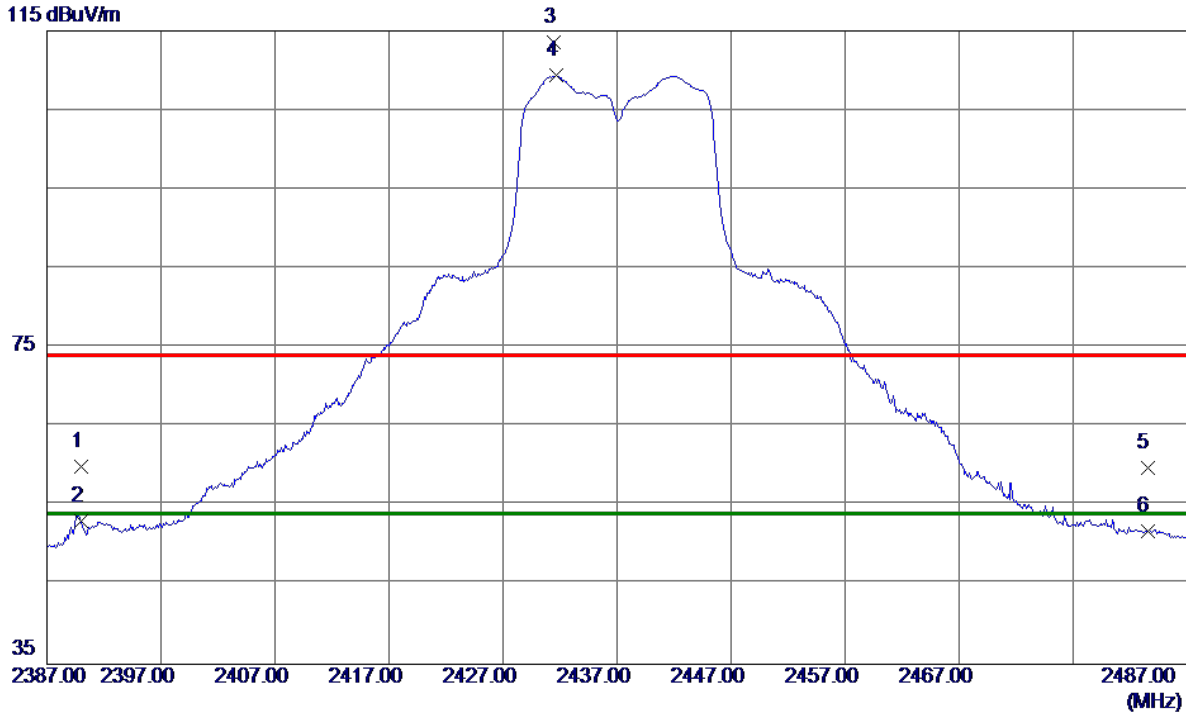

No.	Freq. MHz	Reading Level dBuV/m	Correct Factor dB	Measure ment dBuV/m	Limit dBuV/m	Margin dB	Detector	Comment
1	2390.0000	26.74	33.25	59.99	74.00	-14.01	Peak	
2	2390.0000	19.81	33.25	53.06	54.00	-0.94	AVG	
3	2431.4700	80.20	33.37	113.57	74.00	39.57	Peak	No limit
4 *	2431.7000	75.96	33.37	109.33	54.00	55.33	AVG	No limit
5	2483.5000	26.29	33.51	59.80	74.00	-14.20	Peak	
6	2483.5000	18.33	33.51	51.84	54.00	-2.16	AVG	

**REMARKS:**

(1) Measurement Value = Reading Level + Correct Factor.

(2) Margin Level = Measurement Value - Limit Value.

Test Mode: TX G Mode 2437 MHz

**Horizontal**

80 dBuV/m

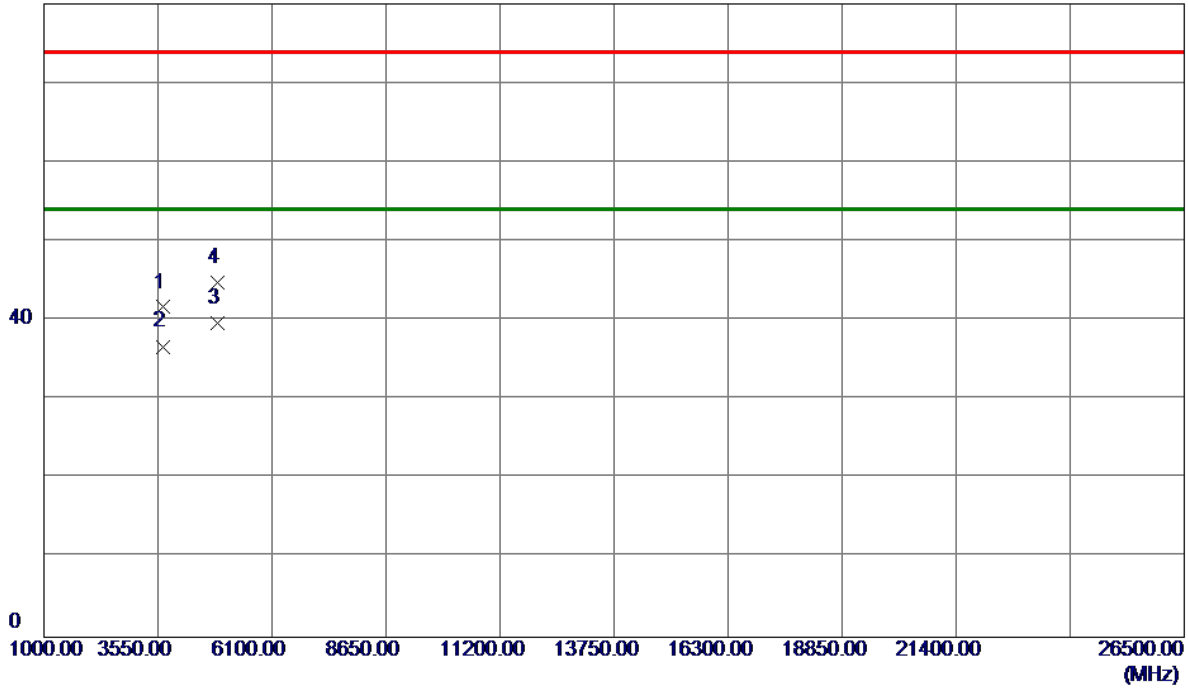

No.	Freq. MHz	Reading Level dBuV/m	Correct Factor dB	Measure ment dBuV/m	Limit dBuV/m	Margin dB	Detector	Comment
1	3666.5570	54.56	-12.88	41.68	74.00	-32.32	Peak	
2	3666.5650	49.60	-12.88	36.72	54.00	-17.28	AVG	
3 *	4873.9600	48.46	-8.80	39.66	54.00	-14.34	AVG	
4	4874.0710	53.64	-8.80	44.84	74.00	-29.16	Peak	

**REMARKS:**

- (1) Measurement Value = Reading Level + Correct Factor.
- (2) Margin Level = Measurement Value - Limit Value.

Test Mode: TX G Mode 2462 MHz

Vertical

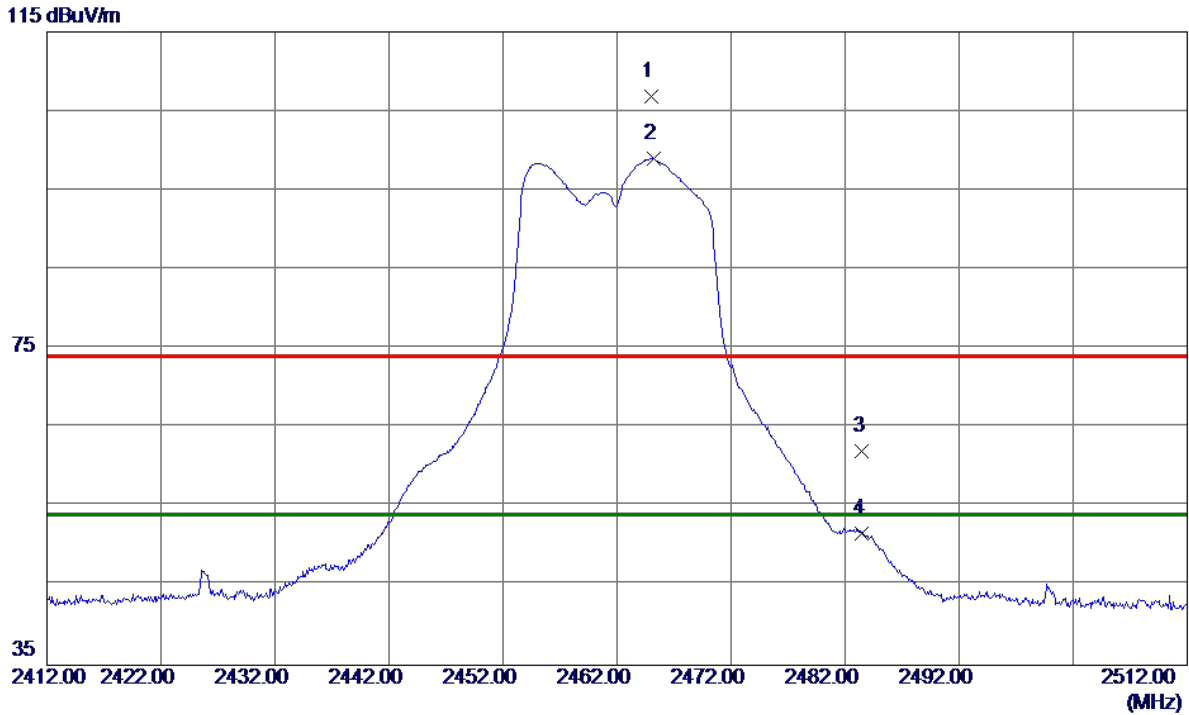

No.	Freq. MHz	Reading Level dBuV/m	Correct Factor dB	Measure ment dBuV/m	Limit dBuV/m	Margin dB	Detector	Comment
1	2465.0000	73.34	33.46	106.80	74.00	32.80	Peak	No limit
2 *	2465.2000	65.54	33.46	99.00	54.00	45.00	AVG	No limit
3	2483.5000	28.47	33.51	61.98	74.00	-12.02	Peak	
4	2483.5000	18.10	33.51	51.61	54.00	-2.39	AVG	

REMARKS:

- (1) Measurement Value = Reading Level + Correct Factor.
- (2) Margin Level = Measurement Value - Limit Value.

Test Mode: TX G Mode 2462 MHz

**Vertical**

80 dBuV/m

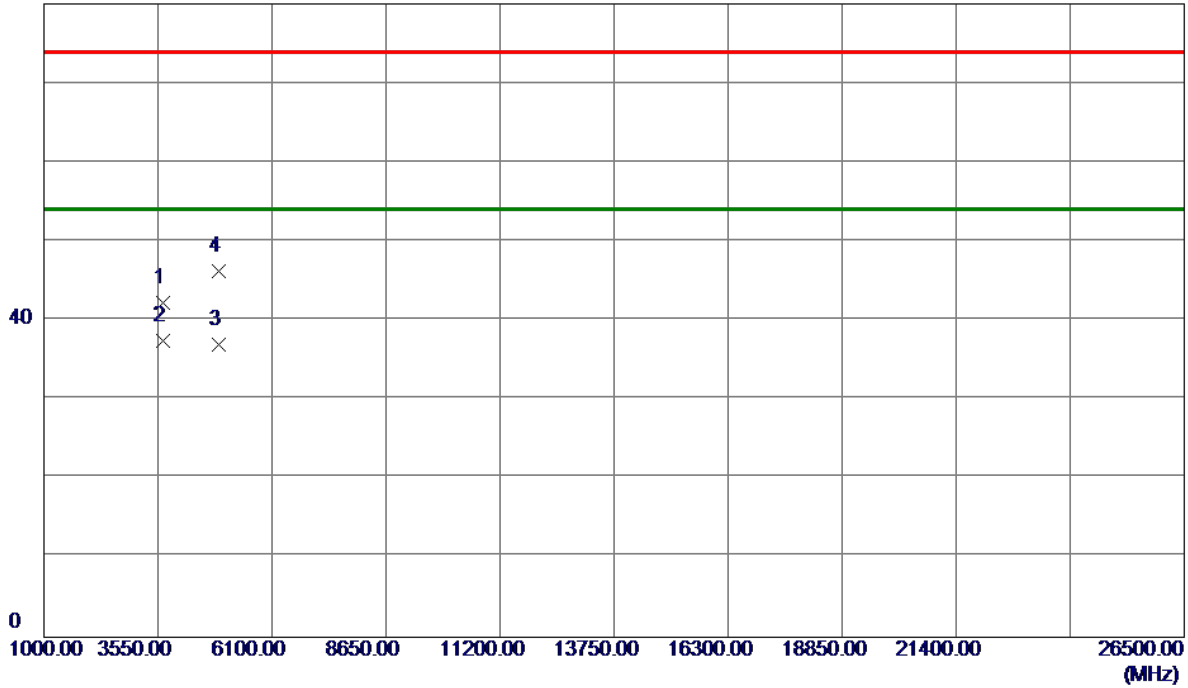

No.	Freq. MHz	Reading Level dBuV/m	Correct Factor dB	Measure ment dBuV/m	Limit dBuV/m	Margin dB	Detector	Comment
1	3666.4400	55.12	-12.88	42.24	74.00	-31.76	Peak	
2 *	3666.5650	50.26	-12.88	37.38	54.00	-16.62	AVG	
3	4923.1600	45.59	-8.61	36.98	54.00	-17.02	AVG	
4	4923.5400	54.89	-8.61	46.28	74.00	-27.72	Peak	

**REMARKS:**

(1) Measurement Value = Reading Level + Correct Factor.

(2) Margin Level = Measurement Value - Limit Value.

Test Mode: TX G Mode 2462 MHz

**Horizontal**

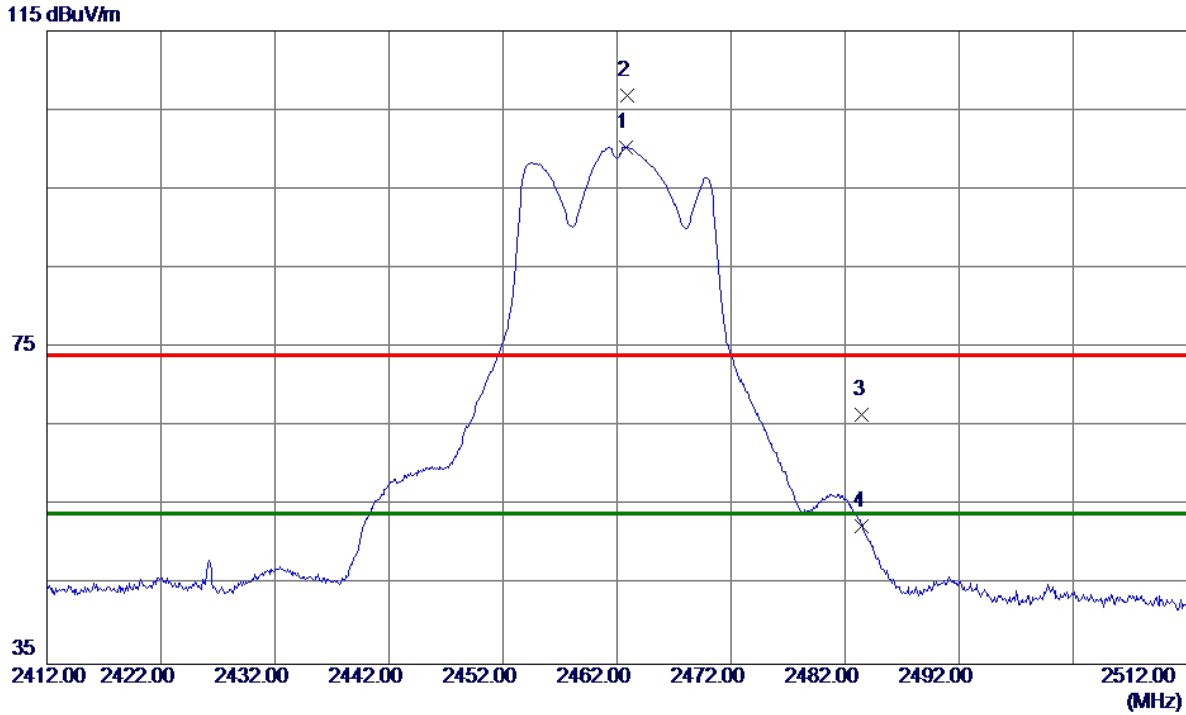

No.	Freq. MHz	Reading Level dBuV/m	Correct Factor dB	Measure ment dBuV/m	Limit dBuV/m	Margin dB	Detector	Comment
1 *	2462.8000	66.89	33.45	100.34	54.00	46.34	AVG	No limit
2	2462.9000	73.43	33.45	106.88	74.00	32.88	Peak	No limit
3	2483.5000	32.96	33.51	66.47	74.00	-7.53	Peak	
4	2483.5000	18.92	33.51	52.43	54.00	-1.57	AVG	

**REMARKS:**

- (1) Measurement Value = Reading Level + Correct Factor.
- (2) Margin Level = Measurement Value - Limit Value.

Test Mode: TX G Mode 2462 MHz

**Horizontal**

80 dBuV/m

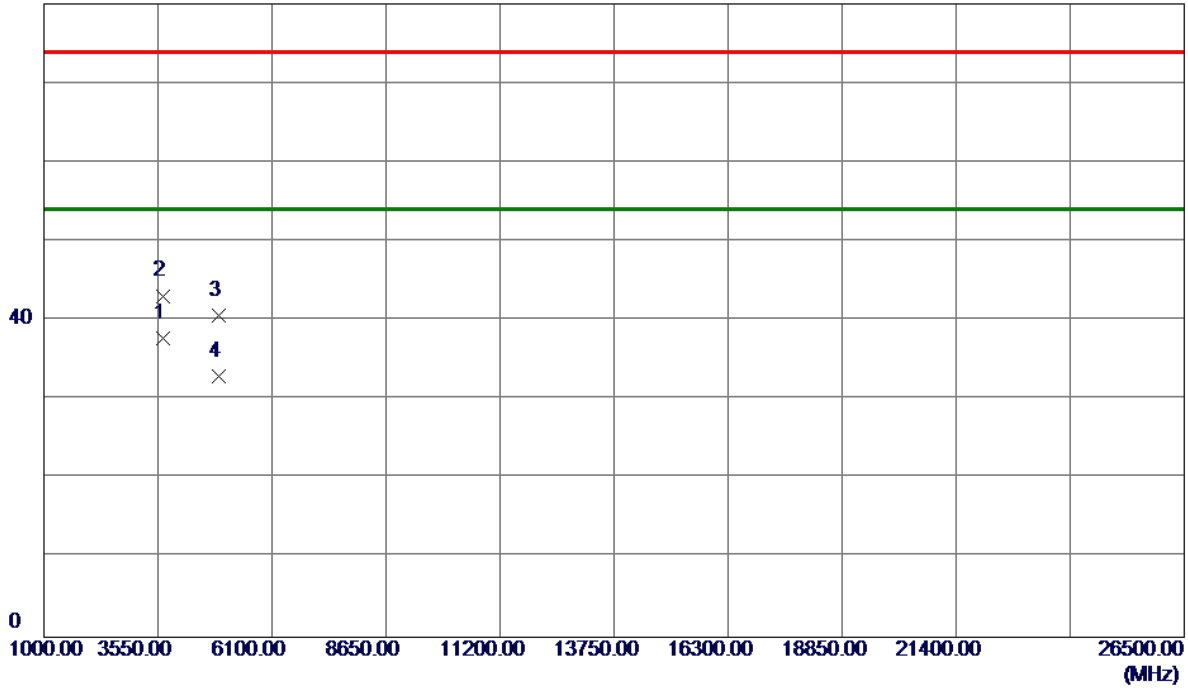

No.	Freq. MHz	Reading Level dBuV/m	Correct Factor dB	Measure ment dBuV/m	Limit dBuV/m	Margin dB	Detector	Comment
1 *	3666.6400	50.62	-12.88	37.74	54.00	-16.26	AVG	
2	3666.7200	56.00	-12.88	43.12	74.00	-30.88	Peak	
3	4916.5000	49.23	-8.63	40.60	74.00	-33.40	Peak	
4	4921.8000	41.57	-8.61	32.96	54.00	-21.04	AVG	

**REMARKS:**

(1) Measurement Value = Reading Level + Correct Factor.

(2) Margin Level = Measurement Value - Limit Value.

Test Mode: TX N-20M Mode 2412 MHz

Vertical

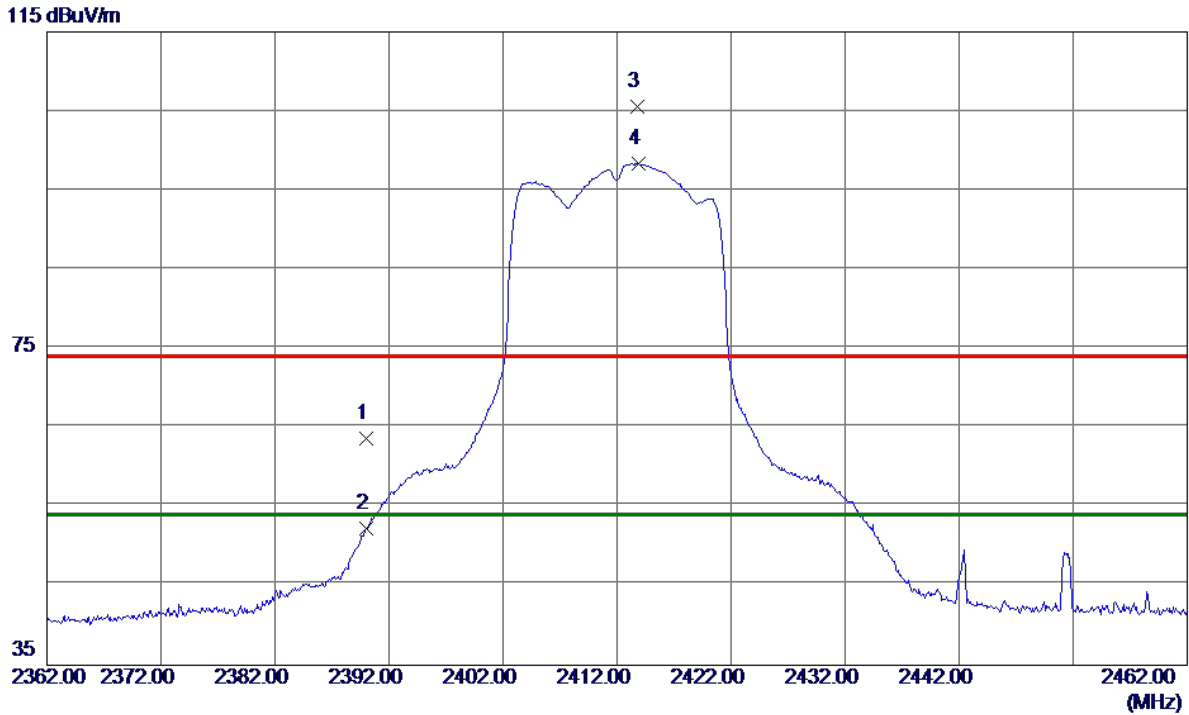

No.	Freq. MHz	Reading Level dBuV/m	Correct Factor dB	Measure ment dBuV/m	Limit dBuV/m	Margin dB	Detector	Comment
1	2390.0000	30.39	33.25	63.64	74.00	-10.36	Peak	
2	2390.0000	19.06	33.25	52.31	54.00	-1.69	AVG	
3	2413.8000	72.25	33.32	105.57	74.00	31.57	Peak	No limit
4 *	2413.9000	65.04	33.32	98.36	54.00	44.36	AVG	No limit

REMARKS:

(1) Measurement Value = Reading Level + Correct Factor.

(2) Margin Level = Measurement Value - Limit Value.



Test Mode: TX N-20M Mode 2412 MHz

**Vertical**

80 dBuV/m

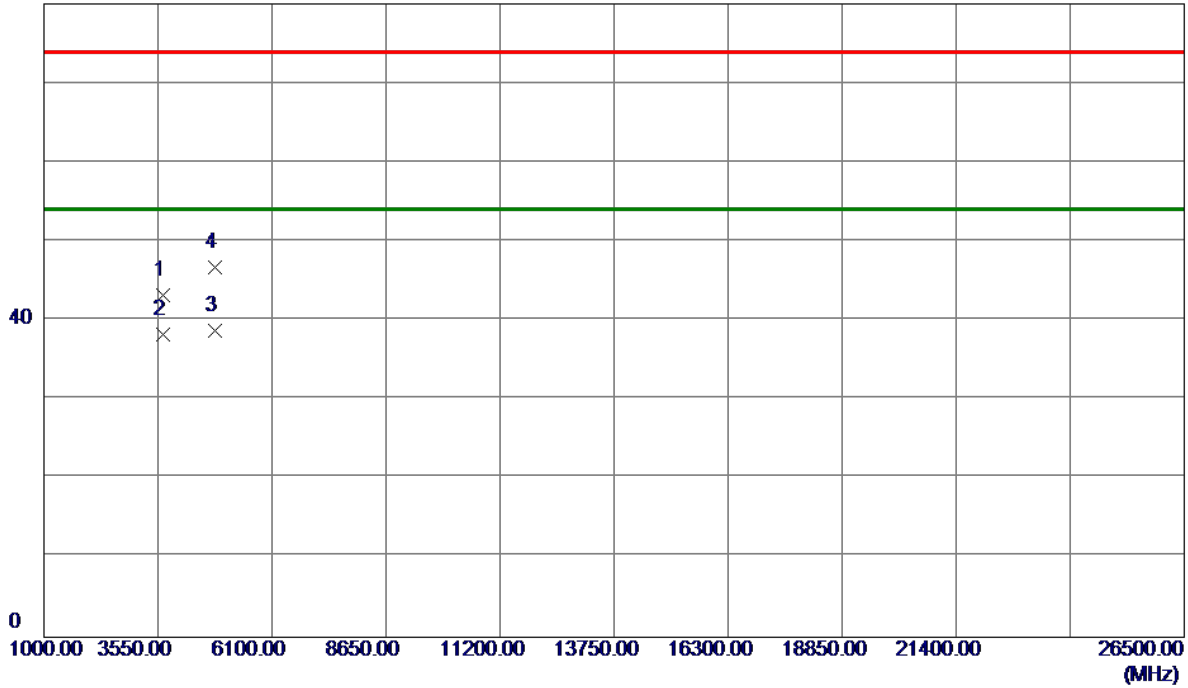

No.	Freq. MHz	Reading Level dBuV/m	Correct Factor dB	Measure ment dBuV/m	Limit dBuV/m	Margin dB	Detector	Comment
1	3666.5850	56.14	-12.88	43.26	74.00	-30.74	Peak	
2	3666.6450	51.08	-12.88	38.20	54.00	-15.80	AVG	
3 *	4822.3300	47.68	-9.00	38.68	54.00	-15.32	AVG	
4	4823.8300	55.76	-8.99	46.77	74.00	-27.23	Peak	

**REMARKS:**

(1) Measurement Value = Reading Level + Correct Factor.

(2) Margin Level = Measurement Value - Limit Value.

Test Mode: TX N-20M Mode 2412 MHz

Horizontal

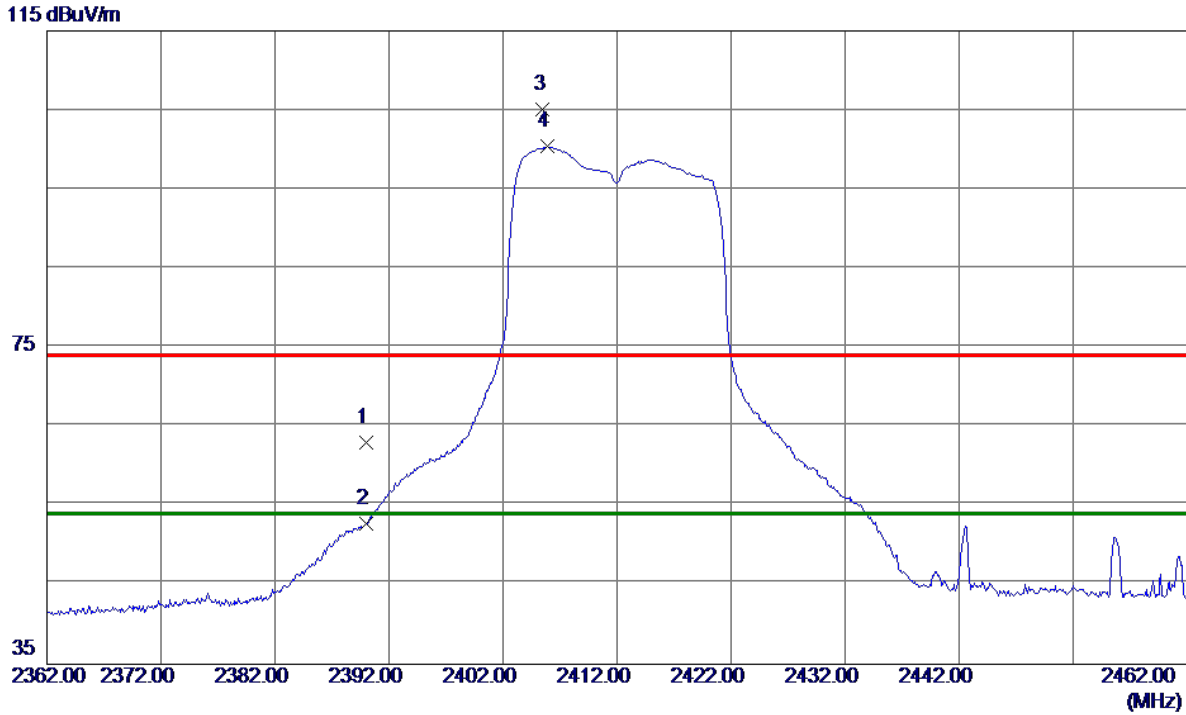

No.	Freq. MHz	Reading Level dBuV/m	Correct Factor dB	Measure ment dBuV/m	Limit dBuV/m	Margin dB	Detector	Comment
1	2390.0000	29.69	33.25	62.94	74.00	-11.06	Peak	
2	2390.0000	19.47	33.25	52.72	54.00	-1.28	AVG	
3	2405.5000	71.84	33.29	105.13	74.00	31.13	Peak	No limit
4 *	2405.9000	67.12	33.29	100.41	54.00	46.41	AVG	No limit

REMARKS:

(1) Measurement Value = Reading Level + Correct Factor.

(2) Margin Level = Measurement Value - Limit Value.

Test Mode: TX N-20M Mode 2412 MHz

**Horizontal**

80 dBuV/m

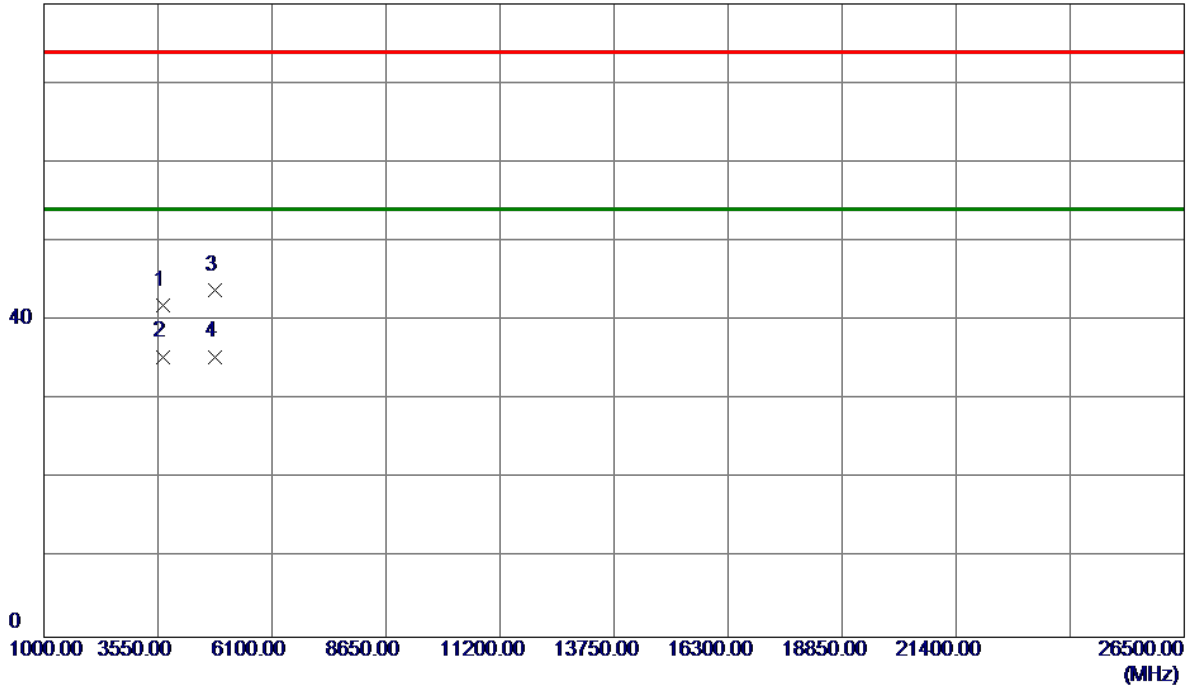

No.	Freq. MHz	Reading Level dBuV/m	Correct Factor dB	Measure ment dBuV/m	Limit dBuV/m	Margin dB	Detector	Comment
1	3666.4050	54.73	-12.88	41.85	74.00	-32.15	Peak	
2 *	3666.6350	48.32	-12.88	35.44	54.00	-18.56	AVG	
3	4819.2000	52.82	-9.01	43.81	74.00	-30.19	Peak	
4	4820.8000	44.45	-9.01	35.44	54.00	-18.56	AVG	

**REMARKS:**

(1) Measurement Value = Reading Level + Correct Factor.

(2) Margin Level = Measurement Value - Limit Value.

Test Mode: TX N-20M Mode 2437 MHz

**Vertical**

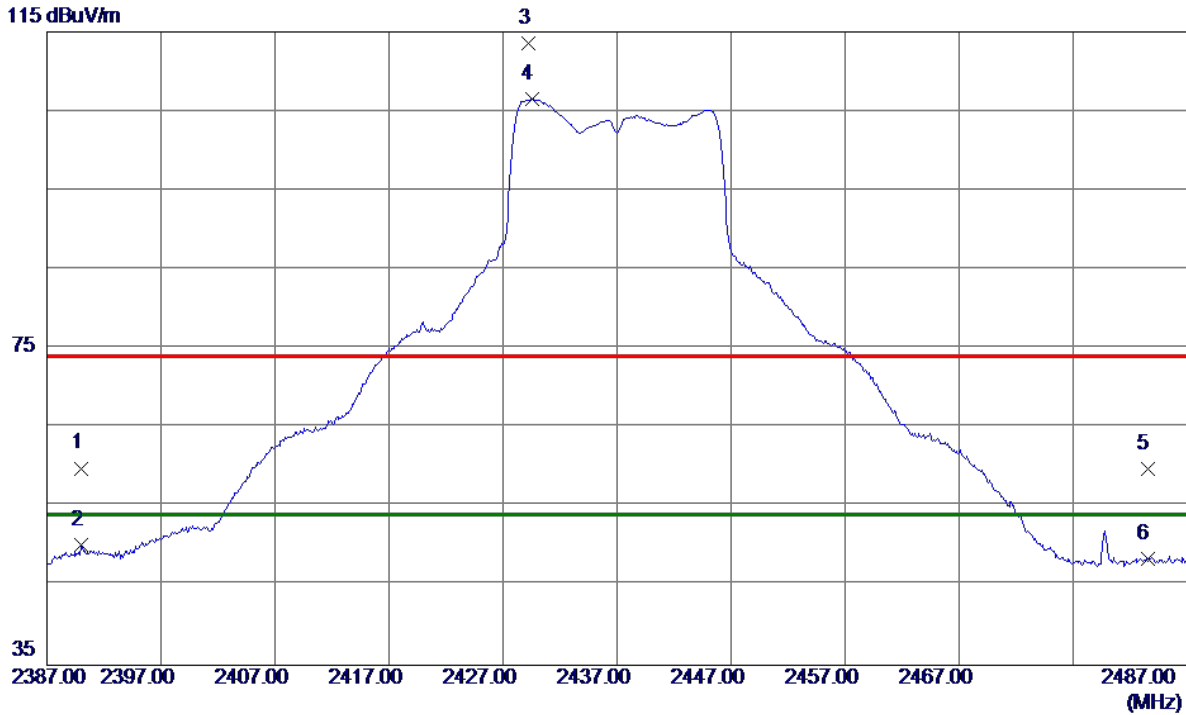

No.	Freq. MHz	Reading Level dBuV/m	Correct Factor dB	Measure ment dBuV/m	Limit dBuV/m	Margin dB	Detector	Comment
1	2390.0000	26.63	33.25	59.88	74.00	-14.12	Peak	
2	2390.0000	16.95	33.25	50.20	54.00	-3.80	AVG	
3	2429.2000	80.24	33.36	113.60	74.00	39.60	Peak	No limit
4 *	2429.5000	73.21	33.36	106.57	54.00	52.57	AVG	No limit
5	2483.5000	26.29	33.51	59.80	74.00	-14.20	Peak	
6	2483.5000	14.97	33.51	48.48	54.00	-5.52	AVG	

**REMARKS:**

- (1) Measurement Value = Reading Level + Correct Factor.
- (2) Margin Level = Measurement Value - Limit Value.

Test Mode: TX N-20M Mode 2437 MHz

**Vertical**

80 dBuV/m

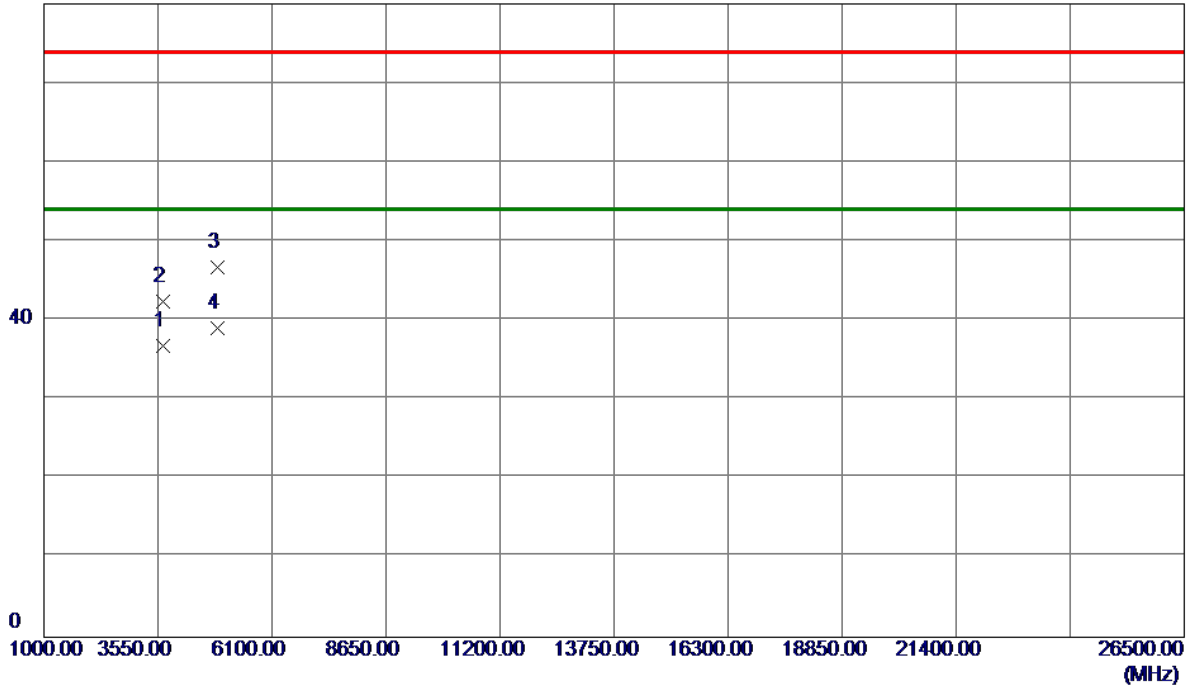

No.	Freq. MHz	Reading Level dBuV/m	Correct Factor dB	Measure ment dBuV/m	Limit dBuV/m	Margin dB	Detector	Comment
1	3666.5750	49.62	-12.88	36.74	54.00	-17.26	AVG	
2	3666.6850	55.31	-12.88	42.43	74.00	-31.57	Peak	
3	4873.9850	55.56	-8.80	46.76	74.00	-27.24	Peak	
4 *	4874.0160	47.81	-8.80	39.01	54.00	-14.99	AVG	

**REMARKS:**

(1) Measurement Value = Reading Level + Correct Factor.

(2) Margin Level = Measurement Value - Limit Value.

Test Mode: TX N-20M Mode 2437 MHz

**Horizontal**

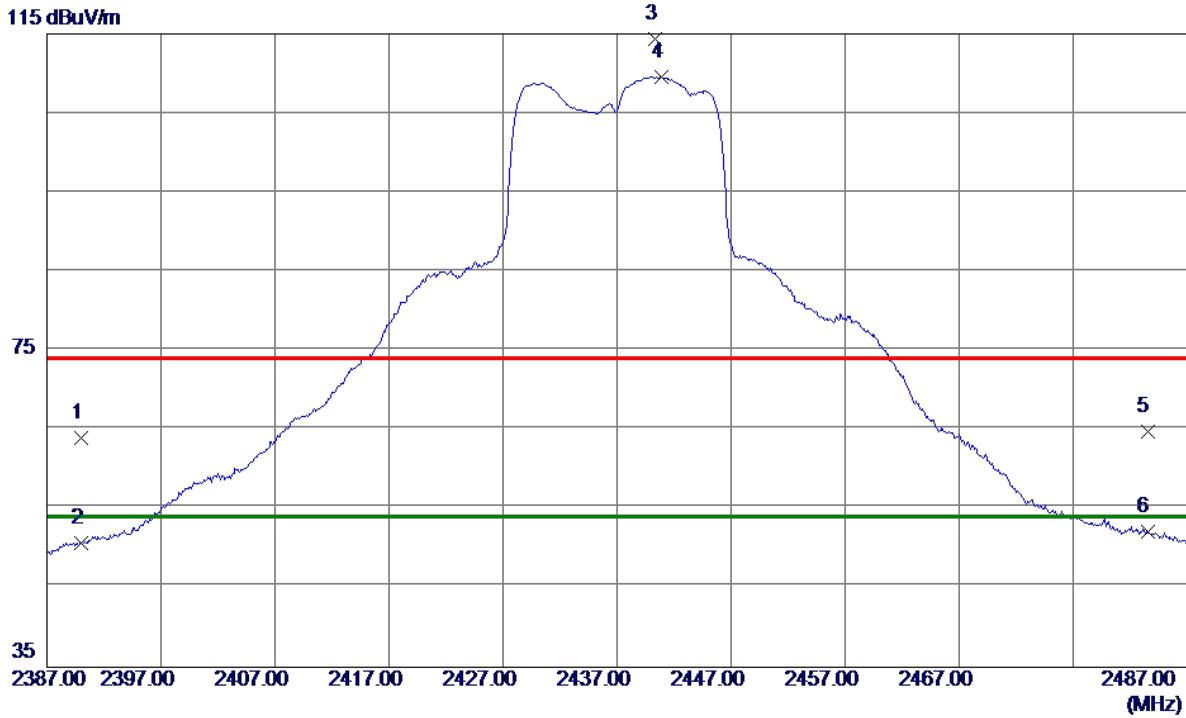

No.	Freq. MHz	Reading Level dBuV/m	Correct Factor dB	Measure ment dBuV/m	Limit dBuV/m	Margin dB	Detector	Comment
1	2390.0000	30.70	33.25	63.95	74.00	-10.05	Peak	
2	2390.0000	17.37	33.25	50.62	54.00	-3.38	AVG	
3	2440.3000	81.04	33.39	114.43	74.00	40.43	Peak	No limit
4 *	2440.9000	76.19	33.39	109.58	54.00	55.58	AVG	No limit
5	2483.5000	31.23	33.51	64.74	74.00	-9.26	Peak	
6	2483.5000	18.58	33.51	52.09	54.00	-1.91	AVG	

**REMARKS:**

(1) Measurement Value = Reading Level + Correct Factor.

(2) Margin Level = Measurement Value - Limit Value.

Test Mode: TX N-20M Mode 2437 MHz

**Horizontal**

80 dBuV/m

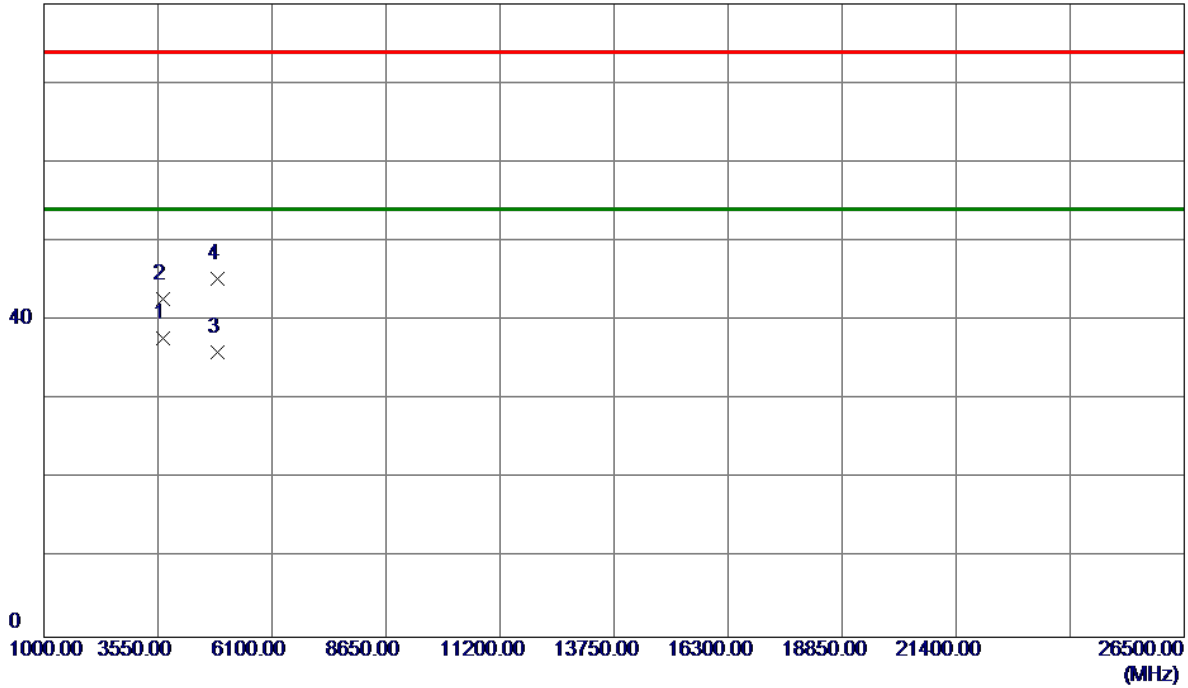

No.	Freq. MHz	Reading Level dBuV/m	Correct Factor dB	Measure ment dBuV/m	Limit dBuV/m	Margin dB	Detector	Comment
1 *	3666.5350	50.58	-12.88	37.70	54.00	-16.30	AVG	
2	3666.5540	55.66	-12.88	42.78	74.00	-31.22	Peak	
3	4873.0179	44.87	-8.80	36.07	54.00	-17.93	AVG	
4	4873.9190	54.13	-8.80	45.33	74.00	-28.67	Peak	

**REMARKS:**

(1) Measurement Value = Reading Level + Correct Factor.

(2) Margin Level = Measurement Value - Limit Value.

Test Mode: TX N-20M Mode 2462 MHz

Vertical

115 dBuV/m

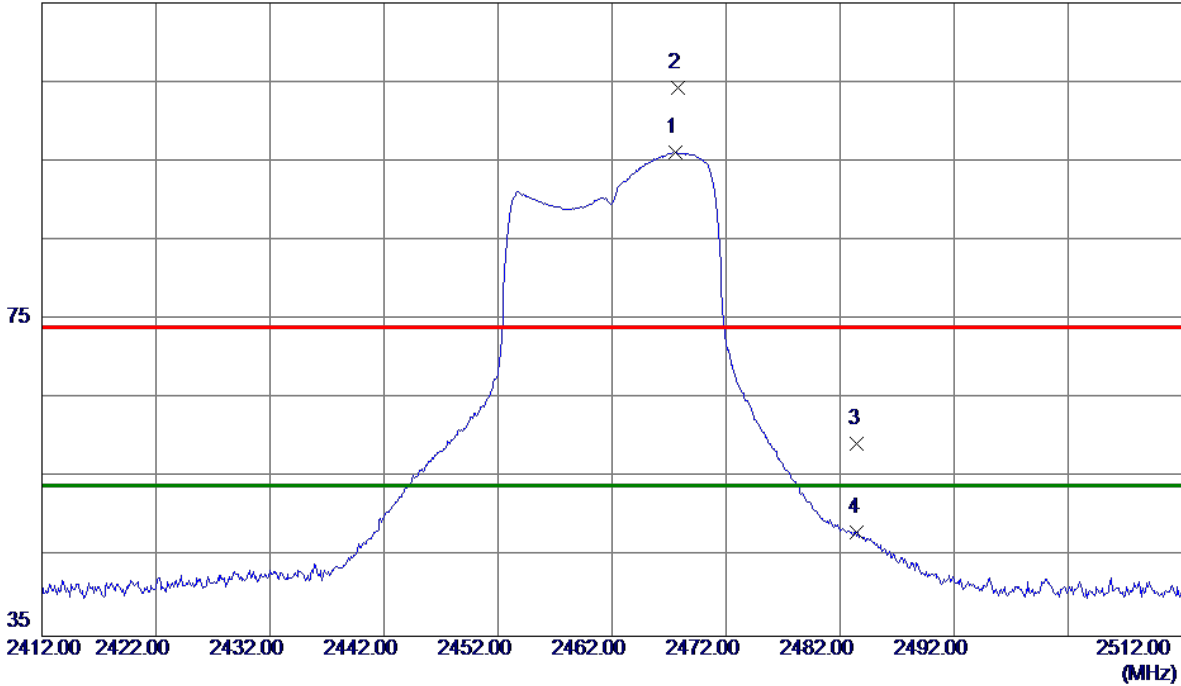

No.	Freq. MHz	Reading Level dBuV/m	Correct Factor dB	Measure ment dBuV/m	Limit dBuV/m	Margin dB	Detector	Comment
1 *	2467.6000	62.62	33.47	96.09	54.00	42.09	AVG	No limit
2	2467.8000	70.83	33.47	104.30	74.00	30.30	Peak	No limit
3	2483.5000	25.80	33.51	59.31	74.00	-14.69	Peak	
4	2483.5000	14.58	33.51	48.09	54.00	-5.91	AVG	

REMARKS:

- (1) Measurement Value = Reading Level + Correct Factor.
- (2) Margin Level = Measurement Value - Limit Value.



Test Mode: TX N-20M Mode 2462 MHz

**Vertical**

80 dBuV/m

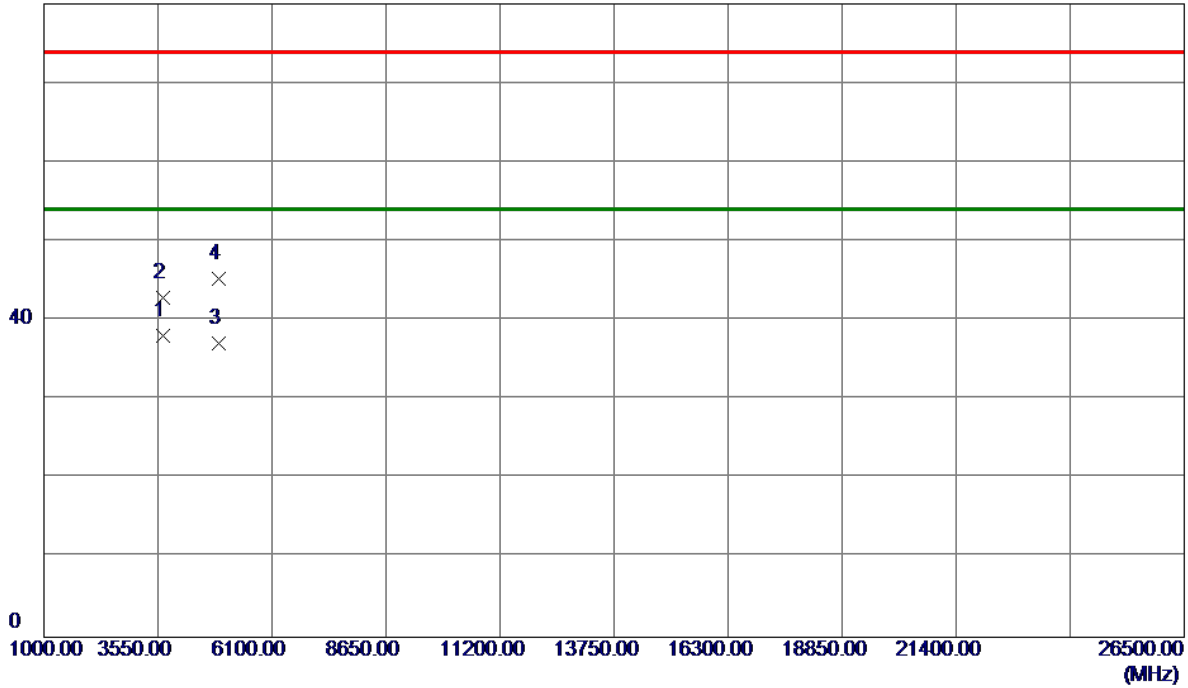

No.	Freq. MHz	Reading Level dBuV/m	Correct Factor dB	Measure ment dBuV/m	Limit dBuV/m	Margin dB	Detector	Comment
1 *	3666.6300	51.00	-12.88	38.12	54.00	-15.88	AVG	
2	3666.7750	55.81	-12.88	42.93	74.00	-31.07	Peak	
3	4921.7500	45.69	-8.61	37.08	54.00	-16.92	AVG	
4	4922.9000	53.94	-8.61	45.33	74.00	-28.67	Peak	

**REMARKS:**

(1) Measurement Value = Reading Level + Correct Factor.

(2) Margin Level = Measurement Value - Limit Value.

Test Mode: TX N-20M Mode 2462 MHz

**Horizontal**

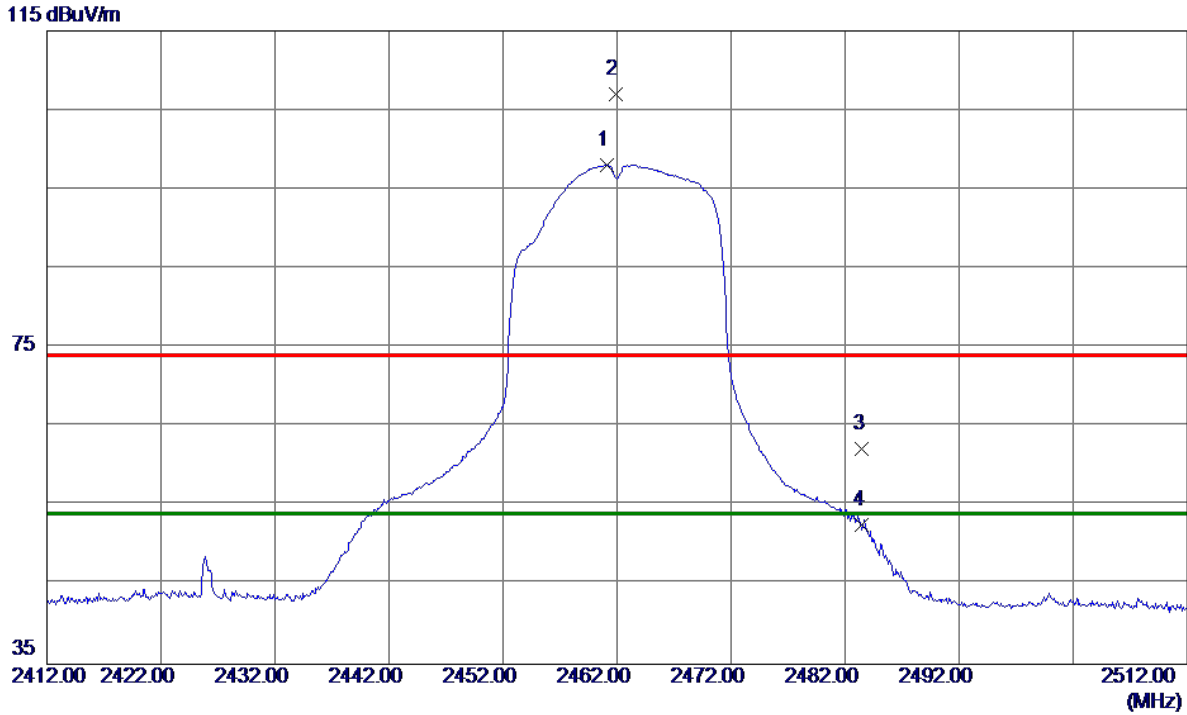

No.	Freq. MHz	Reading Level dBuV/m	Correct Factor dB	Measure ment dBuV/m	Limit dBuV/m	Margin dB	Detector	Comment
1 *	2461.1000	64.66	33.45	98.11	54.00	44.11	AVG	No limit
2	2461.9000	73.52	33.45	106.97	74.00	32.97	Peak	No limit
3	2483.5000	28.73	33.51	62.24	74.00	-11.76	Peak	
4	2483.5000	19.09	33.51	52.60	54.00	-1.40	AVG	

**REMARKS:**

(1) Measurement Value = Reading Level + Correct Factor.

(2) Margin Level = Measurement Value - Limit Value.

Test Mode: TX N-20M Mode 2462 MHz

**Horizontal**

80 dBuV/m

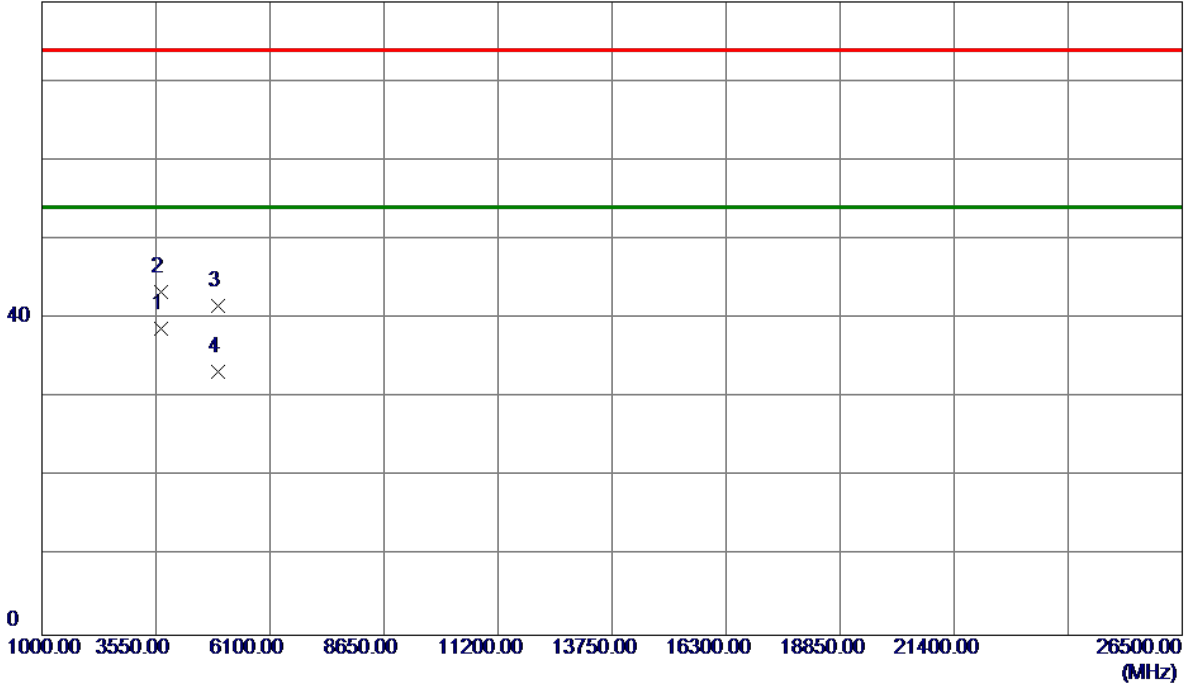

No.	Freq. MHz	Reading Level dBuV/m	Correct Factor dB	Measure ment dBuV/m	Limit dBuV/m	Margin dB	Detector	Comment
1 *	3666.6150	51.53	-12.88	38.65	54.00	-15.35	AVG	
2	3666.6550	56.19	-12.88	43.31	74.00	-30.69	Peak	
3	4927.0000	50.26	-8.59	41.67	74.00	-32.33	Peak	
4	4927.1500	41.81	-8.59	33.22	54.00	-20.78	AVG	

**REMARKS:**

(1) Measurement Value = Reading Level + Correct Factor.

(2) Margin Level = Measurement Value - Limit Value.

Test Mode: TX N-40M Mode 2422MHz

Vertical

115 dBuV/m

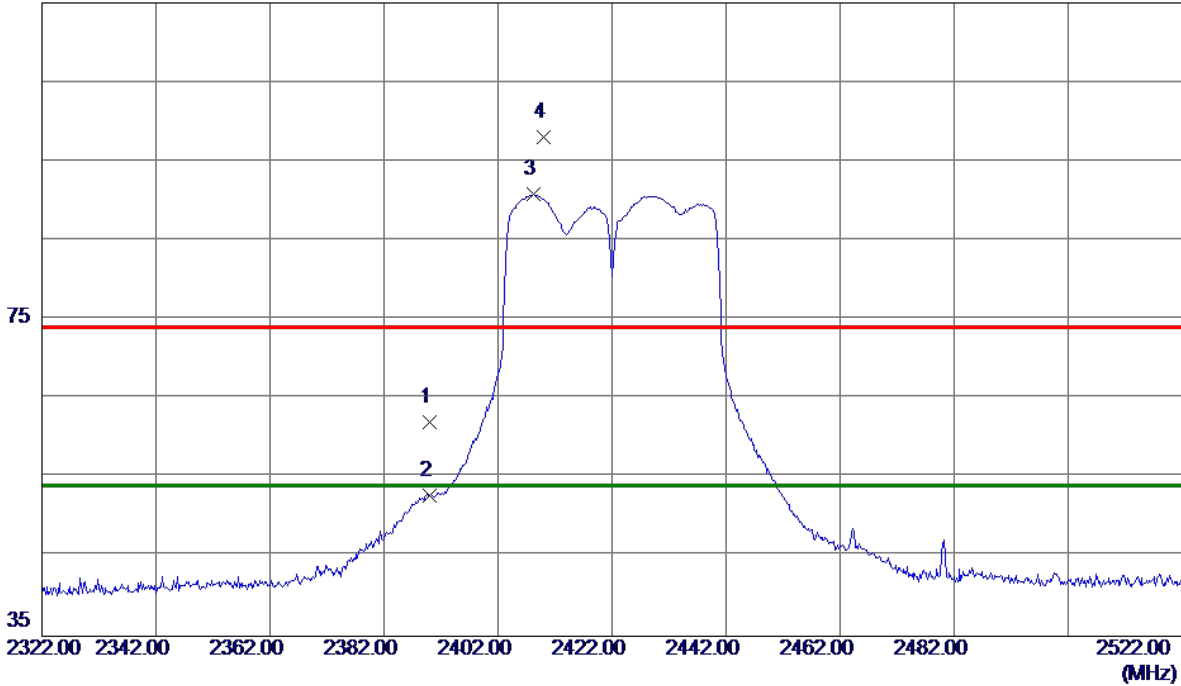

No.	Freq. MHz	Reading Level dBuV/m	Correct Factor dB	Measure ment dBuV/m	Limit dBuV/m	Margin dB	Detector	Comment
1	2390.0000	28.77	33.25	62.02	74.00	-11.98	Peak	
2	2390.0000	19.50	33.25	52.75	54.00	-1.25	AVG	
3 *	2408.2000	57.49	33.30	90.79	54.00	36.79	AVG	No limit
4	2410.0000	64.72	33.30	98.02	74.00	24.02	Peak	No limit

REMARKS:

- (1) Measurement Value = Reading Level + Correct Factor.
- (2) Margin Level = Measurement Value - Limit Value.

Test Mode: TX N-40M Mode 2422MHz

**Vertical**

80 dBuV/m



No.	Freq. MHz	Reading Level dBuV/m	Correct Factor dB	Measure ment dBuV/m	Limit dBuV/m	Margin dB	Detector	Comment
1	3666.5450	55.90	-12.88	43.02	74.00	-30.98	Peak	
2 *	3666.6600	50.61	-12.88	37.73	54.00	-16.27	AVG	
3	4861.6000	44.33	-8.85	35.48	54.00	-18.52	AVG	
4	4862.0000	52.92	-8.85	44.07	74.00	-29.93	Peak	

**REMARKS:**

(1) Measurement Value = Reading Level + Correct Factor.

(2) Margin Level = Measurement Value - Limit Value.

Test Mode: TX N-40M Mode 2422MHz

Horizontal

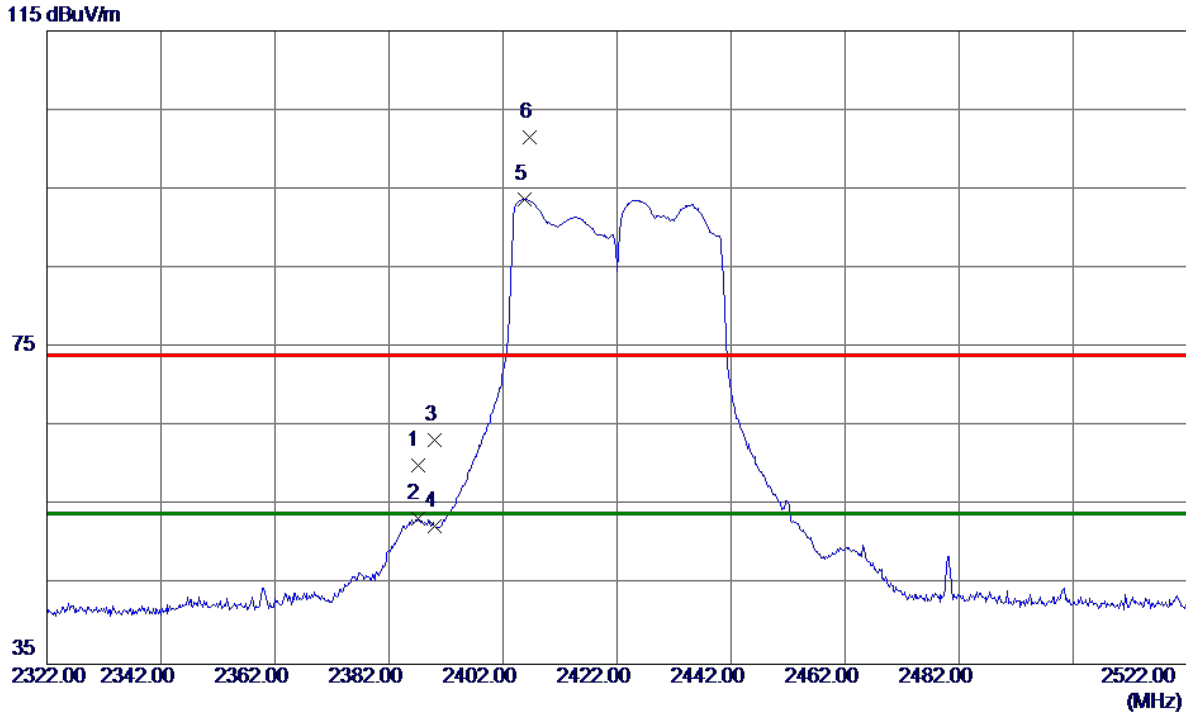

No.	Freq. MHz	Reading Level dBuV/m	Correct Factor dB	Measure ment dBuV/m	Limit dBuV/m	Margin dB	Detector	Comment
1	2387.0000	26.90	33.24	60.14	74.00	-13.86	Peak	
2	2387.0000	20.10	33.24	53.34	54.00	-0.66	AVG	
3	2390.0000	30.09	33.25	63.34	74.00	-10.66	Peak	
4	2390.0000	19.18	33.25	52.43	54.00	-1.57	AVG	
5 *	2405.8000	60.48	33.29	93.77	54.00	39.77	AVG	No limit
6	2406.6000	68.25	33.29	101.54	74.00	27.54	Peak	No limit

REMARKS:

- (1) Measurement Value = Reading Level + Correct Factor.
- (2) Margin Level = Measurement Value - Limit Value.

Test Mode: TX N-40M Mode 2422MHz

**Horizontal**

80 dBuV/m

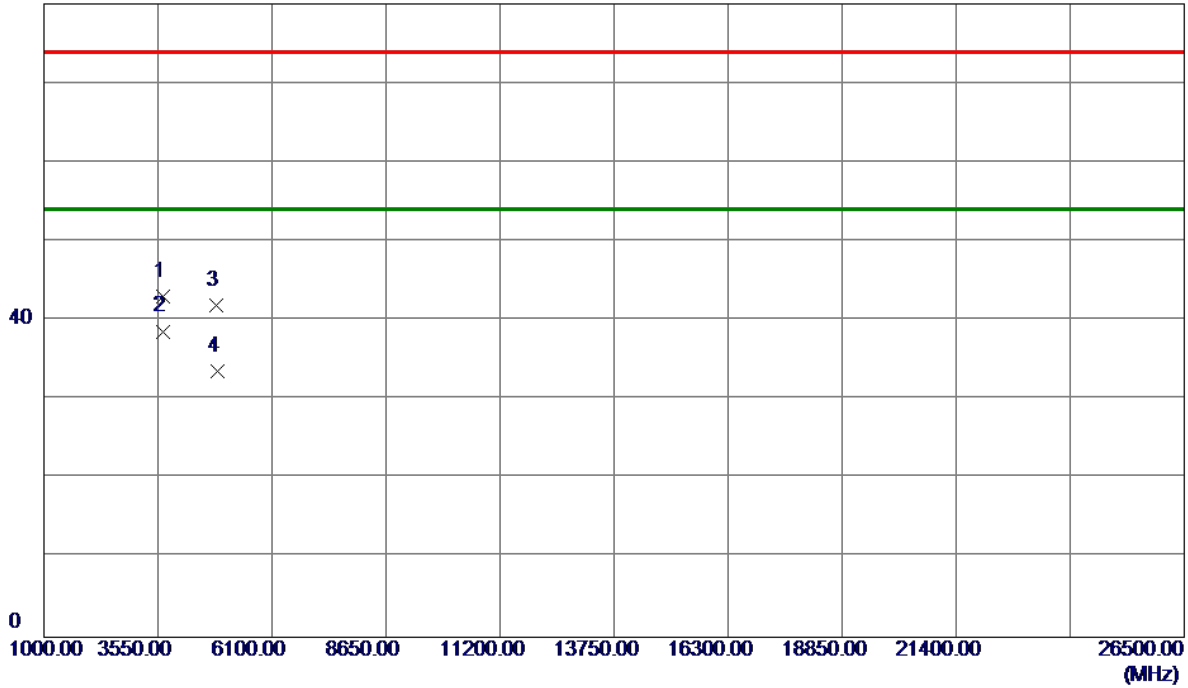

No.	Freq. MHz	Reading Level dBuV/m	Correct Factor dB	Measure ment dBuV/m	Limit dBuV/m	Margin dB	Detector	Comment
1	3666.6100	55.85	-12.88	42.97	74.00	-31.03	Peak	
2 *	3666.6700	51.52	-12.88	38.64	54.00	-15.36	AVG	
3	4859.6000	50.76	-8.85	41.91	74.00	-32.09	Peak	
4	4868.6000	42.42	-8.82	33.60	54.00	-20.40	AVG	

**REMARKS:**

(1) Measurement Value = Reading Level + Correct Factor.

(2) Margin Level = Measurement Value - Limit Value.

Test Mode: TX N-40M Mode 2437 MHz

**Vertical**

115 dBuV/m

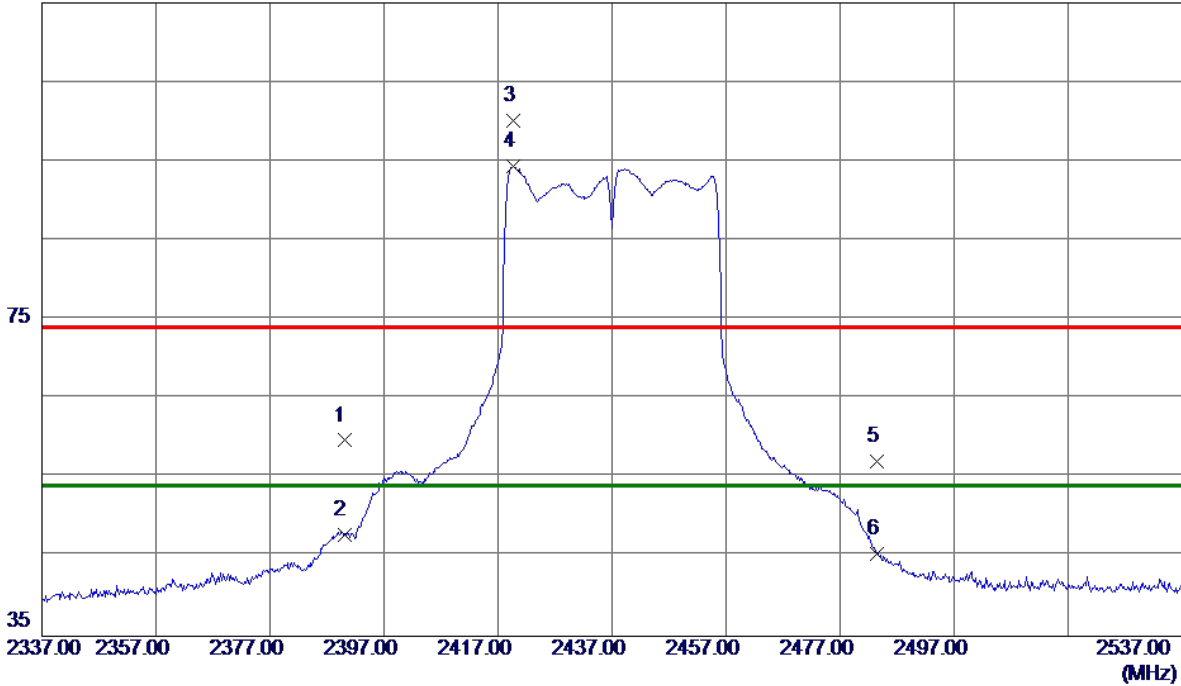

No.	Freq. MHz	Reading Level dBuV/m	Correct Factor dB	Measure ment dBuV/m	Limit dBuV/m	Margin dB	Detector	Comment
1	2390.0000	26.47	33.25	59.72	74.00	-14.28	Peak	
2	2390.0000	14.56	33.25	47.81	54.00	-6.19	AVG	
3	2419.6000	66.77	33.33	100.10	74.00	26.10	Peak	No limit
4 *	2419.6000	61.03	33.33	94.36	54.00	40.36	AVG	No limit
5	2483.5000	23.52	33.51	57.03	74.00	-16.97	Peak	
6	2483.5000	11.83	33.51	45.34	54.00	-8.66	AVG	

**REMARKS:**

- (1) Measurement Value = Reading Level + Correct Factor.
- (2) Margin Level = Measurement Value - Limit Value.



Test Mode: TX N-40M Mode 2437 MHz

**Vertical**

80 dBuV/m

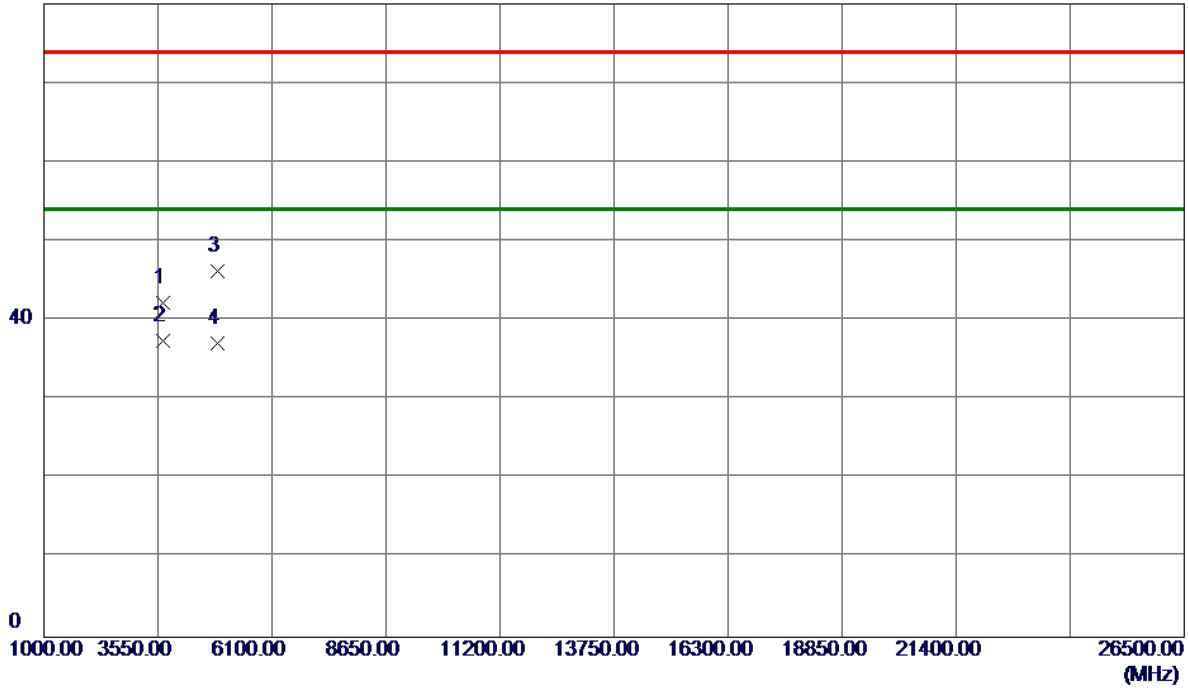

No.	Freq. MHz	Reading Level dBuV/m	Correct Factor dB	Measure ment dBuV/m	Limit dBuV/m	Margin dB	Detector	Comment
1	3666.5450	55.18	-12.88	42.30	74.00	-31.70	Peak	
2 *	3666.5540	50.31	-12.88	37.43	54.00	-16.57	AVG	
3	4874.0240	55.07	-8.80	46.27	74.00	-27.73	Peak	
4	4874.0600	45.87	-8.80	37.07	54.00	-16.93	AVG	

**REMARKS:**

(1) Measurement Value = Reading Level + Correct Factor.

(2) Margin Level = Measurement Value - Limit Value.

Test Mode: TX N-40M Mode 2437 MHz

**Horizontal**

115 dBuV/m

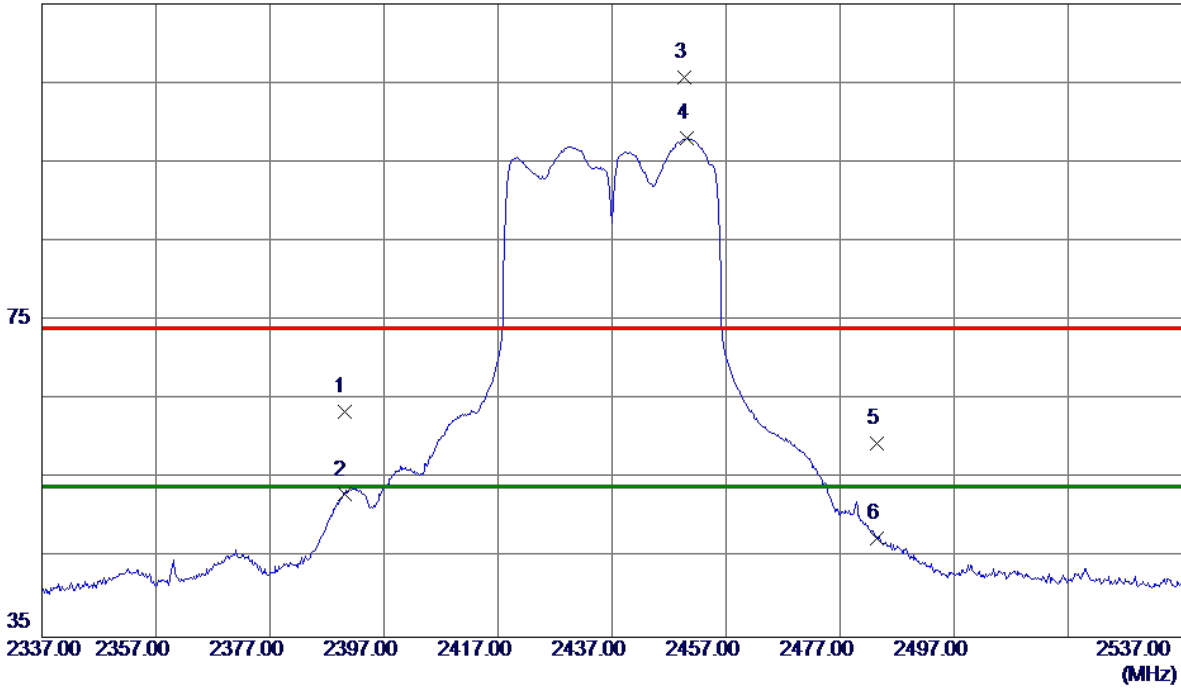

No.	Freq. MHz	Reading Level dBuV/m	Correct Factor dB	Measure ment dBuV/m	Limit dBuV/m	Margin dB	Detector	Comment
1	2390.0000	30.28	33.25	63.53	74.00	-10.47	Peak	
2	2390.0000	19.75	33.25	53.00	54.00	-1.00	AVG	
3	2449.6000	72.34	33.42	105.76	74.00	31.76	Peak	No limit
4 *	2450.2000	64.65	33.42	98.07	54.00	44.07	AVG	No limit
5	2483.5000	25.91	33.51	59.42	74.00	-14.58	Peak	
6	2483.5000	13.95	33.51	47.46	54.00	-6.54	AVG	

**REMARKS:**

(1) Measurement Value = Reading Level + Correct Factor.

(2) Margin Level = Measurement Value - Limit Value.

Test Mode: TX N-40M Mode 2437 MHz

**Horizontal**

80 dBuV/m

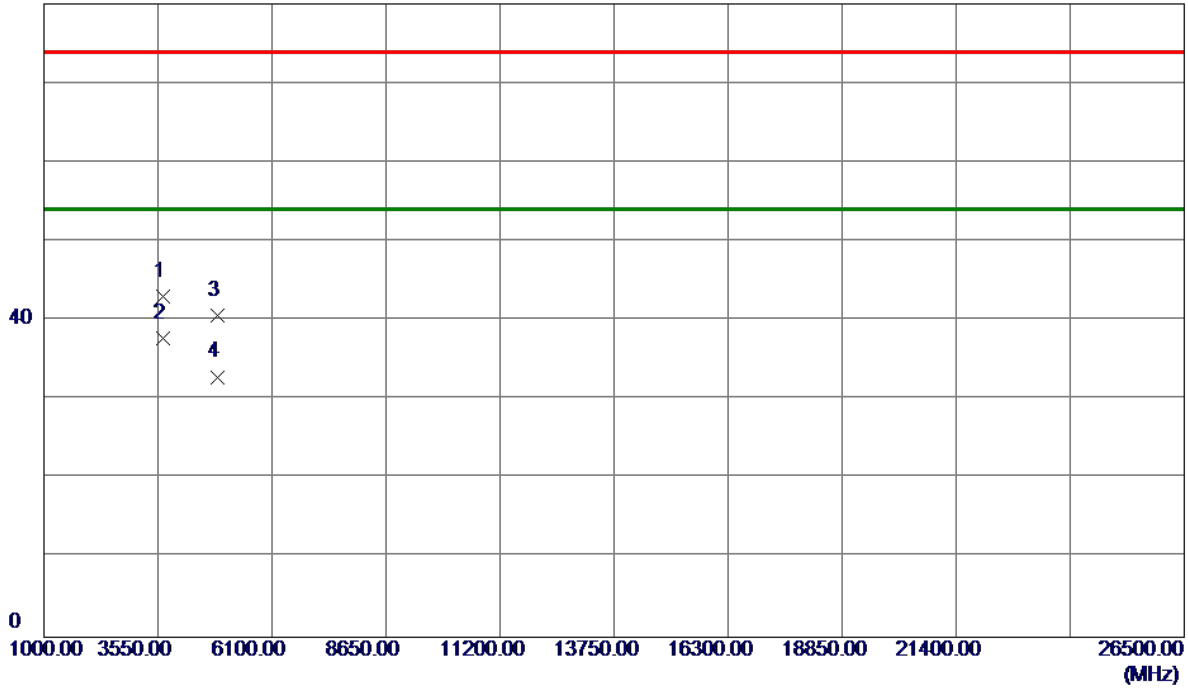

No.	Freq. MHz	Reading Level dBuV/m	Correct Factor dB	Measure ment dBuV/m	Limit dBuV/m	Margin dB	Detector	Comment
1	3666.6450	55.96	-12.88	43.08	74.00	-30.92	Peak	
2 *	3666.6500	50.58	-12.88	37.70	54.00	-16.30	AVG	
3	4874.1200	49.45	-8.80	40.65	74.00	-33.35	Peak	
4	4874.2500	41.68	-8.80	32.88	54.00	-21.12	AVG	

**REMARKS:**

(1) Measurement Value = Reading Level + Correct Factor.

(2) Margin Level = Measurement Value - Limit Value.

Test Mode: TX N-40M Mode 2452 MHz

**Vertical**

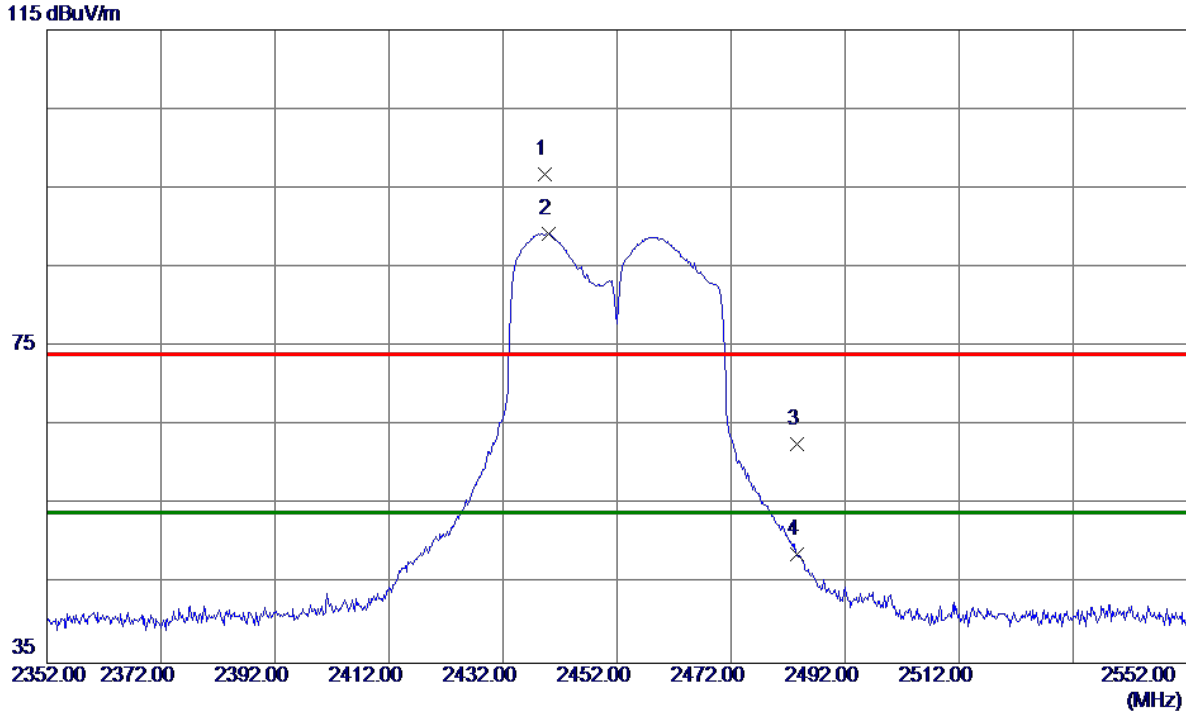

No.	Freq. MHz	Reading Level dBuV/m	Correct Factor dB	Measure ment dBuV/m	Limit dBuV/m	Margin dB	Detector	Comment
1	2439.4000	63.33	33.39	96.72	74.00	22.72	Peak	No limit
2 *	2440.0000	55.81	33.39	89.20	54.00	35.20	AVG	No limit
3	2483.5000	29.14	33.51	62.65	74.00	-11.35	Peak	
4	2483.5000	15.24	33.51	48.75	54.00	-5.25	AVG	

**REMARKS:**

- (1) Measurement Value = Reading Level + Correct Factor.
- (2) Margin Level = Measurement Value - Limit Value.

Test Mode: TX N-40M Mode 2452 MHz

**Vertical**

80 dBuV/m

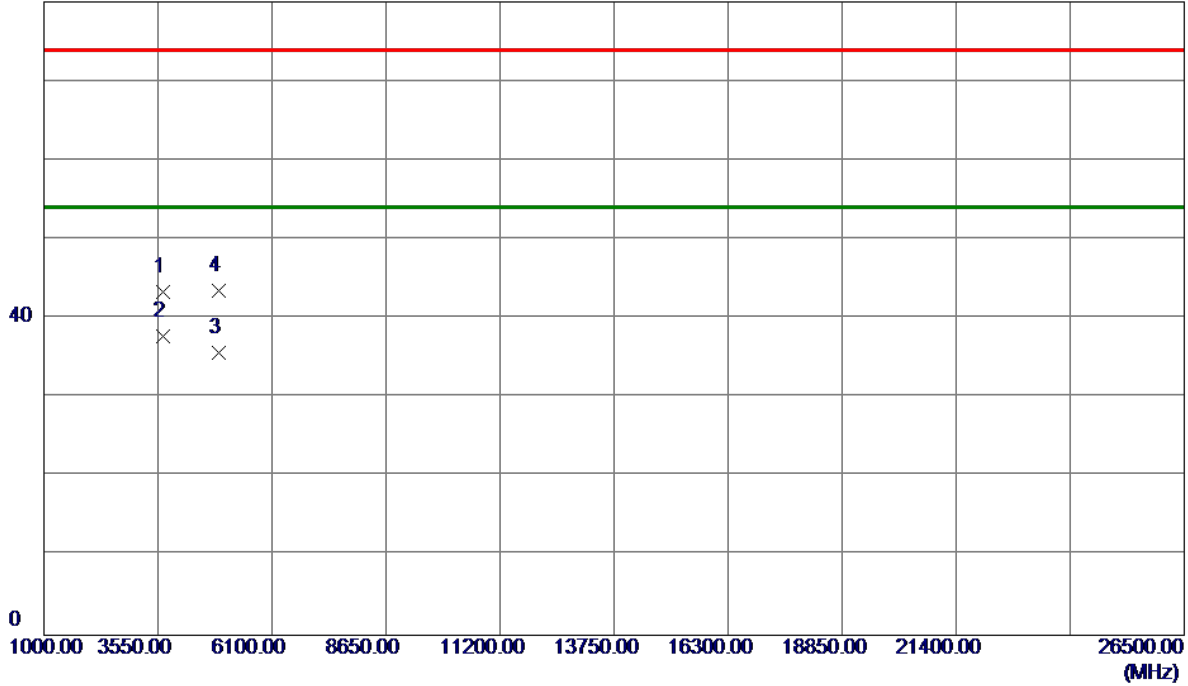

No.	Freq. MHz	Reading Level dBuV/m	Correct Factor dB	Measure ment dBuV/m	Limit dBuV/m	Margin dB	Detector	Comment
1	3666.5400	56.17	-12.88	43.29	74.00	-30.71	Peak	
2 *	3666.6400	50.68	-12.88	37.80	54.00	-16.20	AVG	
3	4902.0000	44.30	-8.69	35.61	54.00	-18.39	AVG	
4	4922.4000	52.13	-8.61	43.52	74.00	-30.48	Peak	

**REMARKS:**

(1) Measurement Value = Reading Level + Correct Factor.

(2) Margin Level = Measurement Value - Limit Value.

Test Mode: TX N-40M Mode 2452 MHz

**Horizontal**

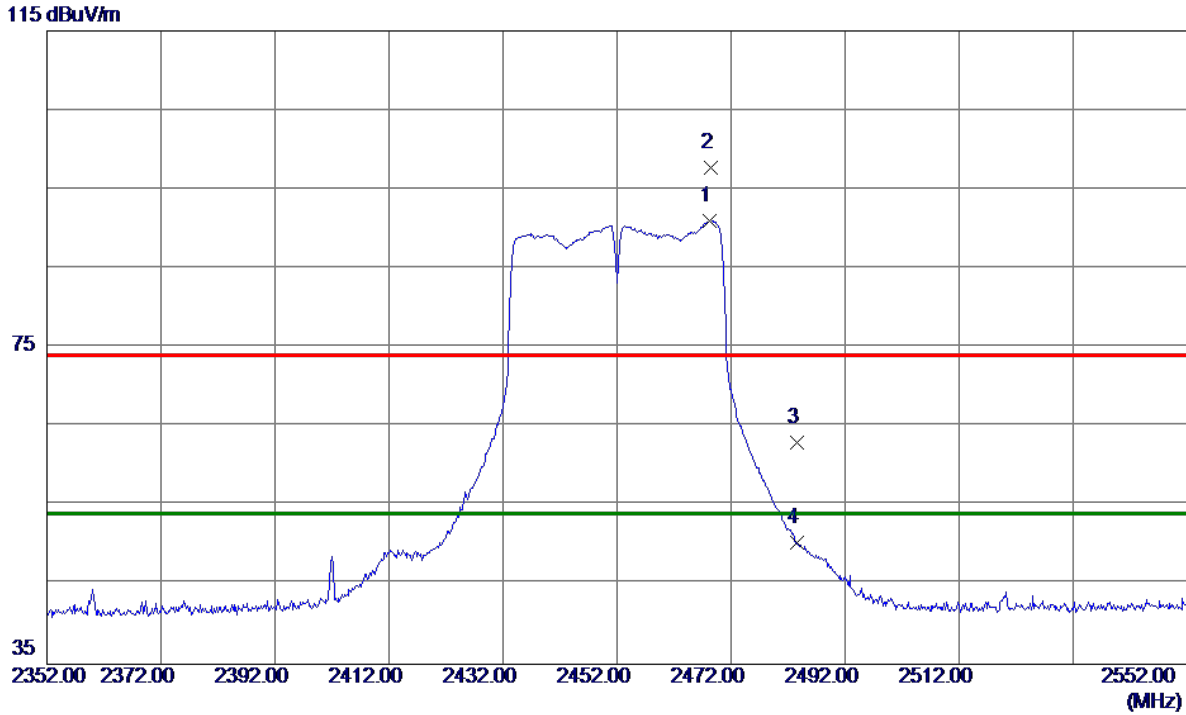

No.	Freq. MHz	Reading Level dBuV/m	Correct Factor dB	Measure ment dBuV/m	Limit dBuV/m	Margin dB	Detector	Comment
1 *	2468.2000	57.49	33.47	90.96	54.00	36.96	AVG	No limit
2	2468.4000	64.18	33.47	97.65	74.00	23.65	Peak	No limit
3	2483.5000	29.45	33.51	62.96	74.00	-11.04	Peak	
4	2483.5000	16.91	33.51	50.42	54.00	-3.58	AVG	

**REMARKS:**

(1) Measurement Value = Reading Level + Correct Factor.

(2) Margin Level = Measurement Value - Limit Value.

Test Mode: TX N-40M Mode 2452 MHz

**Horizontal**

80 dBuV/m

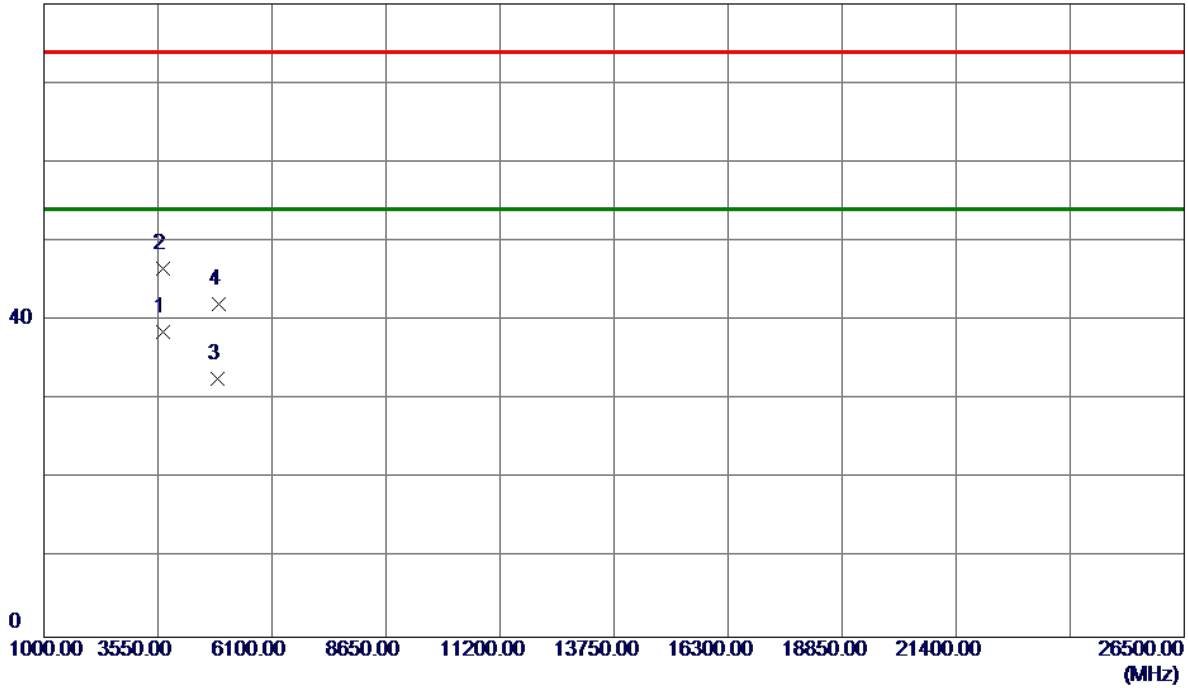

No.	Freq. MHz	Reading Level dBuV/m	Correct Factor dB	Measure ment dBuV/m	Limit dBuV/m	Margin dB	Detector	Comment
1 *	3666.5500	51.43	-12.88	38.55	54.00	-15.45	AVG	
2	3666.6300	59.46	-12.88	46.58	74.00	-27.42	Peak	
3	4888.9000	41.43	-8.74	32.69	54.00	-21.31	AVG	
4	4908.1000	50.78	-8.67	42.11	74.00	-31.89	Peak	

**REMARKS:**

(1) Measurement Value = Reading Level + Correct Factor.

(2) Margin Level = Measurement Value - Limit Value.

## APPENDIX E - BANDWIDTH



### Non-Beamforming

<b>Test Mode</b>	<b>TX B Mode</b>
------------------	------------------

Channel	Frequency (MHz)	6 dB Bandwidth (MHz)	99 % Emission Bandwidth (MHz)	6 dB Bandwidth Min. Limit (kHz)	Result
01	2412	10.09	13.92	500	Complies
06	2437	10.10	14.32	500	Complies
11	2462	10.10	13.84	500	Complies

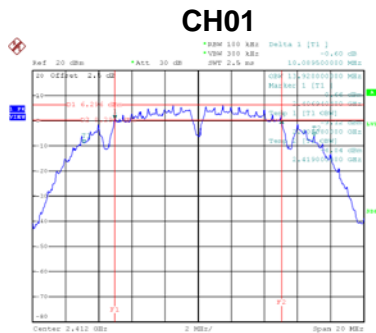

Date: 29\_JUL\_2019 11:08:10

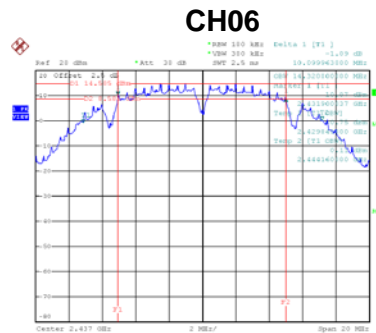

Date: 29\_JUL\_2019 11:17:23

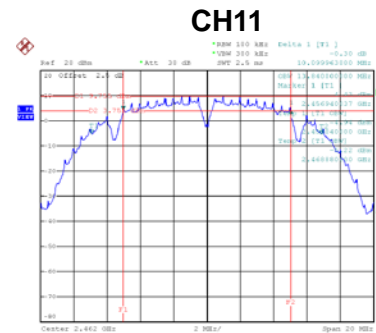

Date: 29\_JUL\_2019 11:18:54

<b>Test Mode</b>	<b>TX G Mode</b>
------------------	------------------

Channel	Frequency (MHz)	6 dB Bandwidth (MHz)	99 % Emission Bandwidth (MHz)	6 dB Bandwidth Min. Limit (kHz)	Result
01	2412	16.34	16.52	500	Complies
06	2437	16.37	16.64	500	Complies
11	2462	16.42	16.48	500	Complies

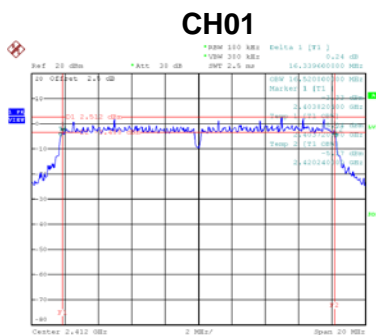

Date: 29\_JUL\_2019 11:27:19

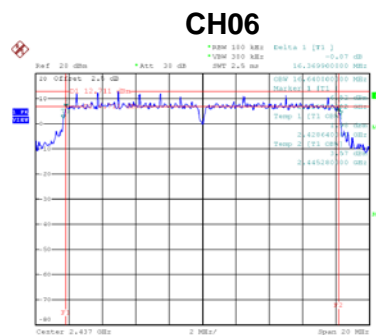

Date: 29\_JUL\_2019 11:29:01

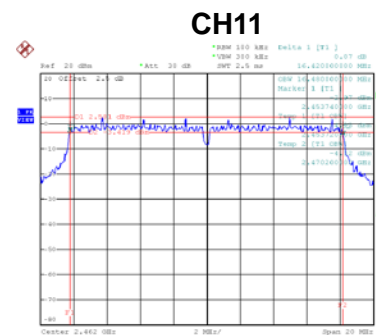

Date: 29\_JUL\_2019 11:36:30

Test Mode	TX N-20M Mode
-----------	---------------

Channel	Frequency (MHz)	6 dB Bandwidth (MHz)	99 % Emission Bandwidth (MHz)	6 dB Bandwidth Min. Limit (kHz)	Result
01	2412	17.68	17.68	500	Complies
06	2437	17.58	17.72	500	Complies
11	2462	17.63	17.68	500	Complies

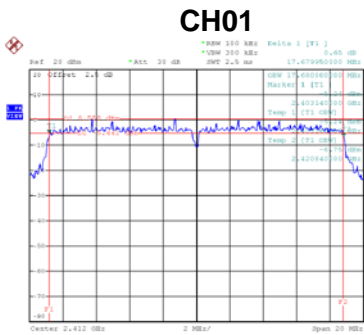

Date: 29\_JUL\_2019 11:17:58

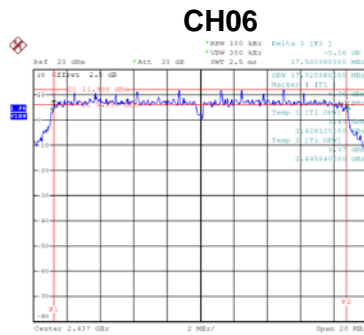

Date: 29\_JUL\_2019 11:14:22

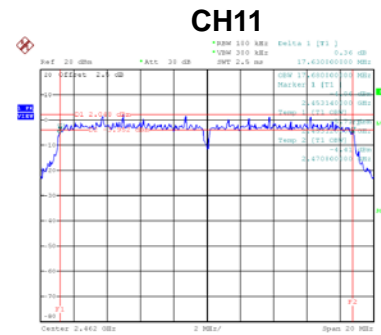

Date: 29\_JUL\_2019 11:14:50

Test Mode	TX N-40M Mode
-----------	---------------

Channel	Frequency (MHz)	6 dB Bandwidth (MHz)	99 % Emission Bandwidth (MHz)	6 dB Bandwidth Min. Limit (kHz)	Result
03	2422	36.41	36.32	500	Complies
06	2437	36.44	36.32	500	Complies
09	2452	36.44	36.40	500	Complies

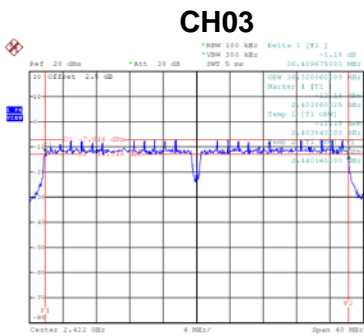

Date: 29\_JUL\_2019 11:53:39

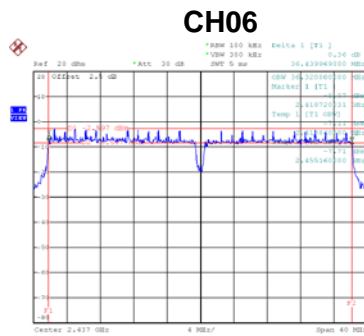

Date: 29\_JUL\_2019 11:55:04

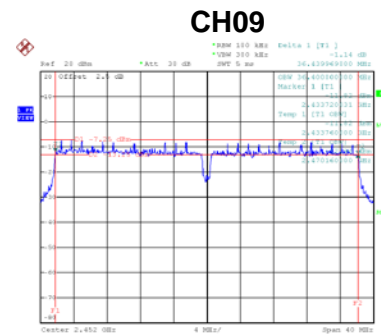

Date: 29\_JUL\_2019 12:00:57

## APPENDIX F - MAXIMUM OUTPUT POWER

### Non-Beamforming

Test Mode	TX B Mode_Ant. 1
-----------	------------------

Channel	Frequency (MHz)	Output Power (dBm)	Output Power (W)	Max. Limit (dBm)	Max. Limit (W)	Result
01	2412	14.72	0.0296	30.00	1.0000	Complies
06	2437	24.38	0.2742	30.00	1.0000	Complies
11	2462	18.11	0.0647	30.00	1.0000	Complies

Test Mode	TX B Mode_Ant. 2
-----------	------------------

Channel	Frequency (MHz)	Output Power (dBm)	Output Power (W)	Max. Limit (dBm)	Max. Limit (W)	Result
01	2412	14.84	0.0305	30.00	1.0000	Complies
06	2437	23.83	0.2415	30.00	1.0000	Complies
11	2462	18.59	0.0723	30.00	1.0000	Complies

Test Mode	TX B Mode_Ant. 3
-----------	------------------

Channel	Frequency (MHz)	Output Power (dBm)	Output Power (W)	Max. Limit (dBm)	Max. Limit (W)	Result
01	2412	15.25	0.0335	30.00	1.0000	Complies
06	2437	24.42	0.2767	30.00	1.0000	Complies
11	2462	19.48	0.0887	30.00	1.0000	Complies

Test Mode	TX B Mode_Total
-----------	-----------------

Channel	Frequency (MHz)	Output Power (dBm)	Output Power (W)	Max. Limit (dBm)	Max. Limit (W)	Result
01	2412	19.71	0.0936	30.00	1.0000	Complies
06	2437	28.99	0.7924	30.00	1.0000	Complies
11	2462	23.54	0.2257	30.00	1.0000	Complies

Test Mode	TX G Mode_Ant. 1
-----------	------------------

Channel	Frequency (MHz)	Output Power (dBm)	Output Power (W)	Max. Limit (dBm)	Max. Limit (W)	Result
01	2412	12.62	0.0183	30.00	1.0000	Complies
06	2437	21.81	0.1517	30.00	1.0000	Complies
11	2462	14.43	0.0277	30.00	1.0000	Complies

Test Mode	TX G Mode_Ant. 2
-----------	------------------

Channel	Frequency (MHz)	Output Power (dBm)	Output Power (W)	Max. Limit (dBm)	Max. Limit (W)	Result
01	2412	12.99	0.0199	30.00	1.0000	Complies
06	2437	21.96	0.1570	30.00	1.0000	Complies
11	2462	14.77	0.0300	30.00	1.0000	Complies

Test Mode	TX G Mode_Ant. 3
-----------	------------------

Channel	Frequency (MHz)	Output Power (dBm)	Output Power (W)	Max. Limit (dBm)	Max. Limit (W)	Result
01	2412	12.57	0.0181	30.00	1.0000	Complies
06	2437	22.21	0.1663	30.00	1.0000	Complies
11	2462	15.25	0.0335	30.00	1.0000	Complies

Test Mode	TX G Mode_Total
-----------	-----------------

Channel	Frequency (MHz)	Output Power (dBm)	Output Power (W)	Max. Limit (dBm)	Max. Limit (W)	Result
01	2412	17.50	0.0563	30.00	1.0000	Complies
06	2437	26.77	0.4751	30.00	1.0000	Complies
11	2462	19.60	0.0912	30.00	1.0000	Complies

Test Mode	TX N-20M Mode_Ant. 1
-----------	----------------------

Channel	Frequency (MHz)	Output Power (dBm)	Output Power (W)	Max. Limit (dBm)	Max. Limit (W)	Result
01	2412	11.63	0.0146	30.00	1.0000	Complies
06	2437	21.78	0.1507	30.00	1.0000	Complies
11	2462	11.97	0.0157	30.00	1.0000	Complies

Test Mode	TX N-20M Mode_Ant. 2
-----------	----------------------

Channel	Frequency (MHz)	Output Power (dBm)	Output Power (W)	Max. Limit (dBm)	Max. Limit (W)	Result
01	2412	11.76	0.0150	30.00	1.0000	Complies
06	2437	21.97	0.1574	30.00	1.0000	Complies
11	2462	12.45	0.0176	30.00	1.0000	Complies

Test Mode	TX N-20M Mode_Ant. 3
-----------	----------------------

Channel	Frequency (MHz)	Output Power (dBm)	Output Power (W)	Max. Limit (dBm)	Max. Limit (W)	Result
01	2412	12.52	0.0179	30.00	1.0000	Complies
06	2437	22.46	0.1762	30.00	1.0000	Complies
11	2462	12.83	0.0192	30.00	1.0000	Complies

Test Mode	TX N-20M Mode_Total
-----------	---------------------

Channel	Frequency (MHz)	Output Power (dBm)	Output Power (W)	Max. Limit (dBm)	Max. Limit (W)	Result
01	2412	16.76	0.0474	30.00	1.0000	Complies
06	2437	26.85	0.4843	30.00	1.0000	Complies
11	2462	17.20	0.0525	30.00	1.0000	Complies

Test Mode	TX N-40M Mode_Ant. 1
-----------	----------------------

Channel	Frequency (MHz)	Output Power (dBm)	Output Power (W)	Max. Limit (dBm)	Max. Limit (W)	Result
03	2422	7.25	0.0053	30.00	1.0000	Complies
06	2437	10.75	0.0119	30.00	1.0000	Complies
09	2452	7.20	0.0053	30.00	1.0000	Complies

Test Mode	TX N-40M Mode_Ant. 2
-----------	----------------------

Channel	Frequency (MHz)	Output Power (dBm)	Output Power (W)	Max. Limit (dBm)	Max. Limit (W)	Result
03	2422	7.81	0.0060	30.00	1.0000	Complies
06	2437	12.01	0.0159	30.00	1.0000	Complies
09	2452	7.93	0.0062	30.00	1.0000	Complies

Test Mode	TX N-40M Mode_Ant. 3
-----------	----------------------

Channel	Frequency (MHz)	Output Power (dBm)	Output Power (W)	Max. Limit (dBm)	Max. Limit (W)	Result
03	2422	8.54	0.0072	30.00	1.0000	Complies
06	2437	12.55	0.0180	30.00	1.0000	Complies
09	2452	8.50	0.0071	30.00	1.0000	Complies

Test Mode	TX N-40M Mode_Total
-----------	---------------------

Channel	Frequency (MHz)	Output Power (dBm)	Output Power (W)	Max. Limit (dBm)	Max. Limit (W)	Result
03	2422	12.67	0.0185	30.00	1.0000	Complies
06	2437	16.61	0.0458	30.00	1.0000	Complies
09	2452	12.68	0.0186	30.00	1.0000	Complies

## APPENDIX G - CONDUCTED SPURIOUS EMISSIONS



## Non-Beamforming

Test Mode TX B Mode\_Ant. 1

### Bandedge-CH01

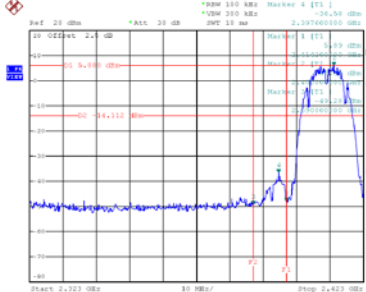

Date: 29\_JUL\_2019 11:08:34

### Bandedge-CH11

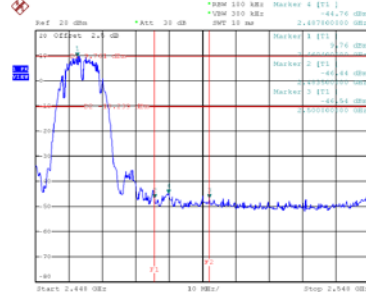

Date: 29\_JUL\_2019 11:19:02

### CH01 – 10th Harmonic of the fundamental frequency

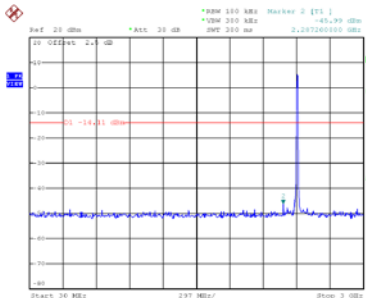

Date: 29\_JUL\_2019 11:08:47

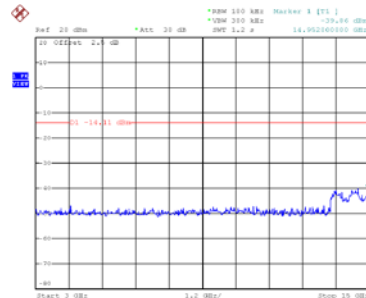

Date: 29\_JUL\_2019 11:08:54

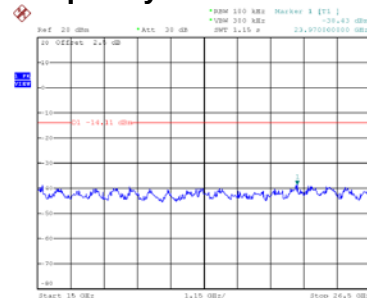

Date: 29\_JUL\_2019 11:09:01

### CH06 – 10th Harmonic of the fundamental frequency

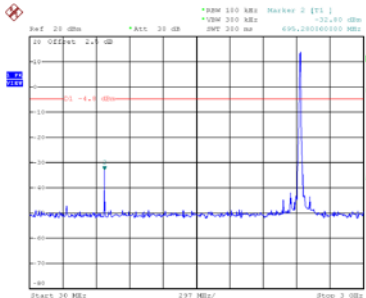

Date: 29\_JUL\_2019 11:17:44

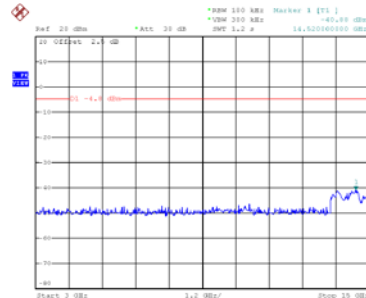

Date: 29\_JUL\_2019 11:17:51

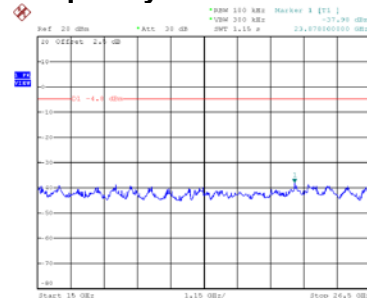

Date: 29\_JUL\_2019 11:17:58

### CH11 – 10th Harmonic of the fundamental frequency

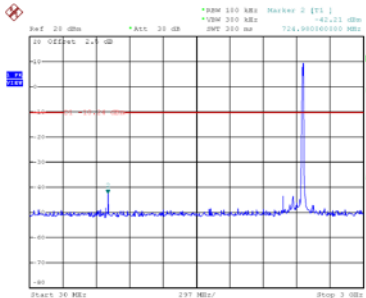

Date: 29\_JUL\_2019 11:19:15

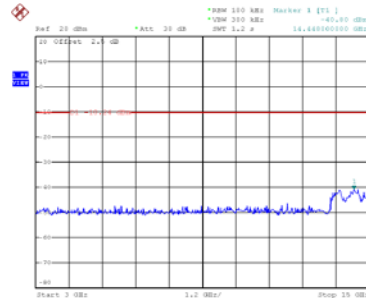

Date: 29\_JUL\_2019 11:19:22

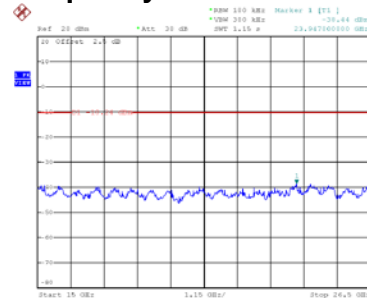

Date: 29\_JUL\_2019 11:19:29

Test Mode TX B Mode\_Ant. 2

**Bandedge-CH01**

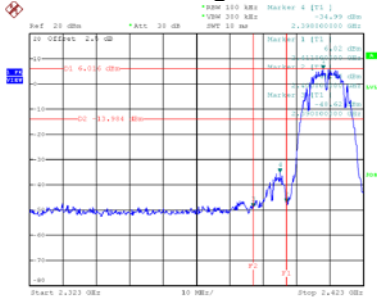

Date: 29\_JUL.2019 11:10:26

**Bandedge-CH11**

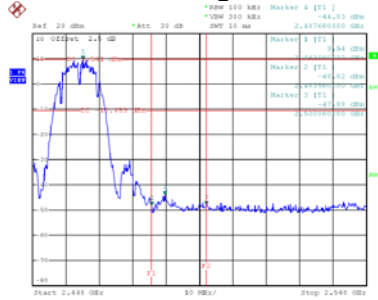

Date: 29\_JUL.2019 11:21:14

**CH01 – 10th Harmonic of the fundamental frequency**

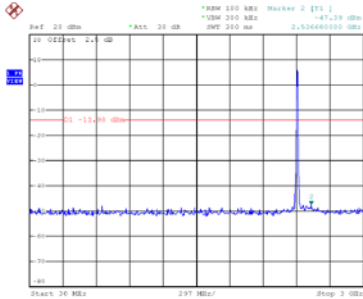

Date: 29\_JUL.2019 11:10:39

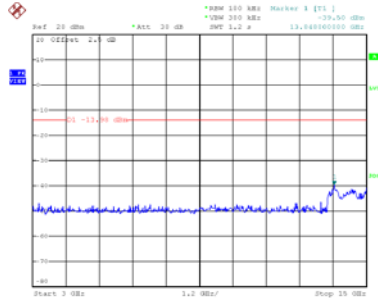

Date: 29\_JUL.2019 11:10:46

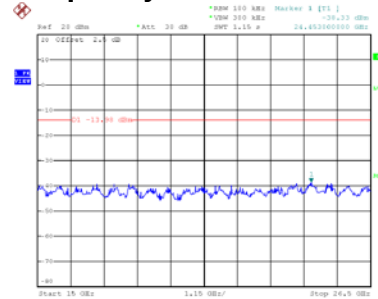

Date: 29\_JUL.2019 11:10:53

**CH06 – 10th Harmonic of the fundamental frequency**

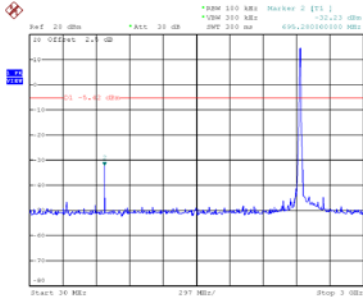

Date: 29\_JUL.2019 11:15:38

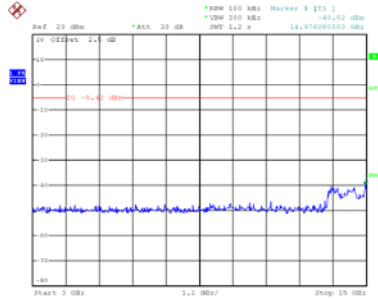

Date: 29\_JUL.2019 11:15:46

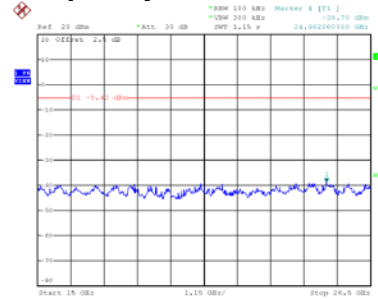

Date: 29\_JUL.2019 11:15:53

**CH11 – 10th Harmonic of the fundamental frequency**

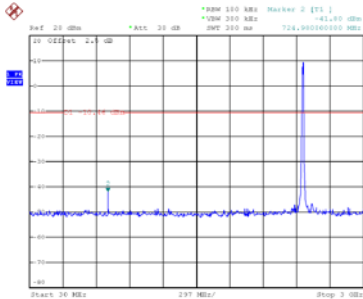

Date: 29\_JUL.2019 11:21:27

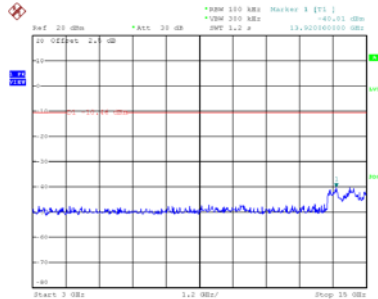

Date: 29\_JUL.2019 11:21:34

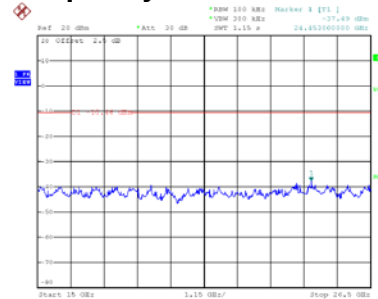

Date: 29\_JUL.2019 11:21:42

Test Mode TX B Mode\_Ant. 3

**Bandedge-CH01**

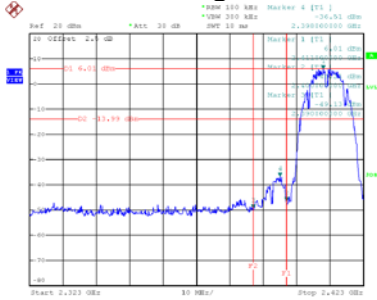

**Bandedge-CH11**

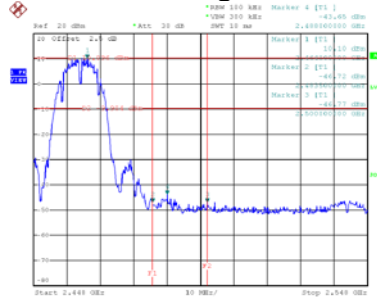

**CH01 – 10th Harmonic of the fundamental frequency**

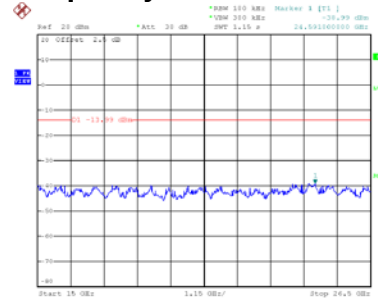
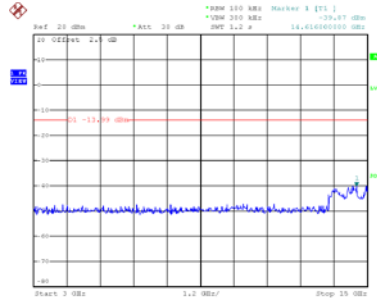
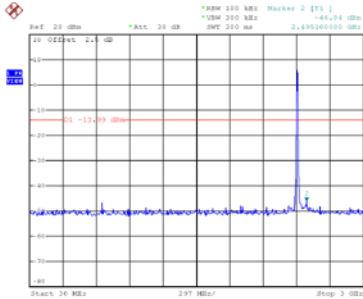

**CH06 – 10th Harmonic of the fundamental frequency**

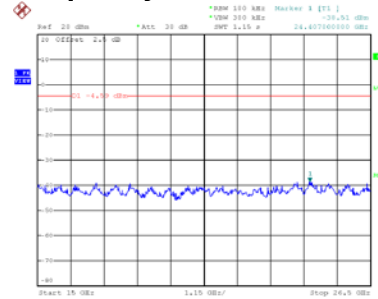
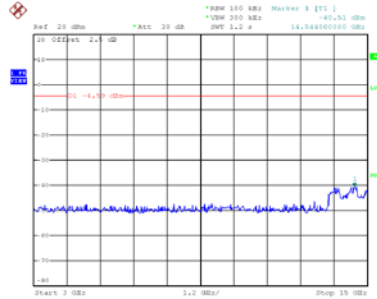
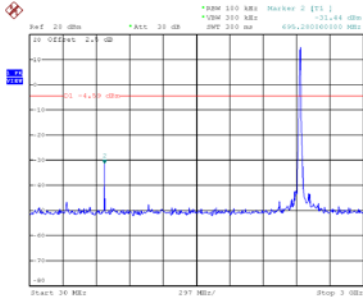

**CH11 – 10th Harmonic of the fundamental frequency**

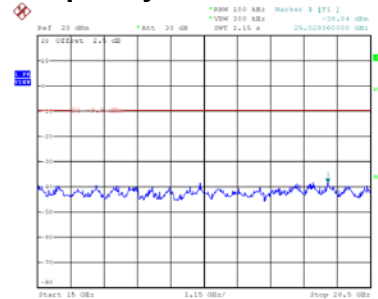
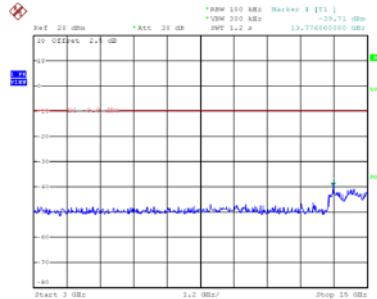
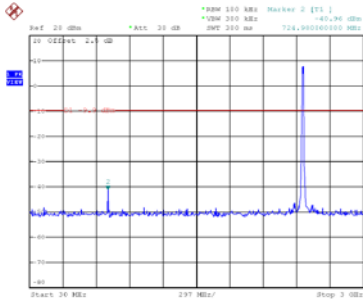

Test Mode TX G Mode\_Ant. 1

**Bandedge-CH01**

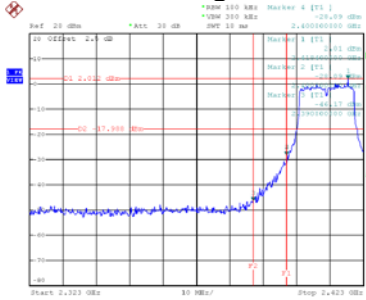

Date: 29\_JUL.2019 11:27:43

**Bandedge-CH11**

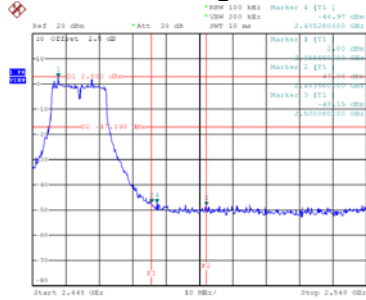

Date: 29\_JUL.2019 11:13:637

**CH01 – 10th Harmonic of the fundamental frequency**

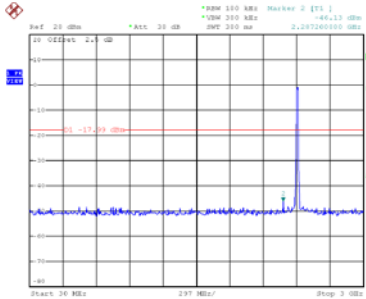

Date: 29\_JUL.2019 11:27:56

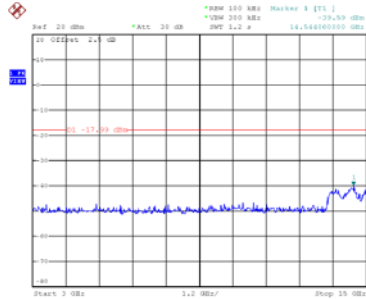

Date: 29\_JUL.2019 11:28:03

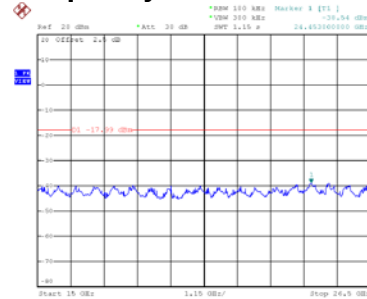

Date: 29\_JUL.2019 11:28:10

**CH06 – 10th Harmonic of the fundamental frequency**

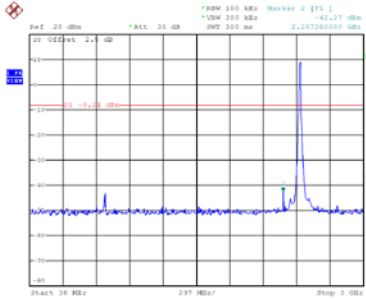

Date: 29\_JUL.2019 11:29:37

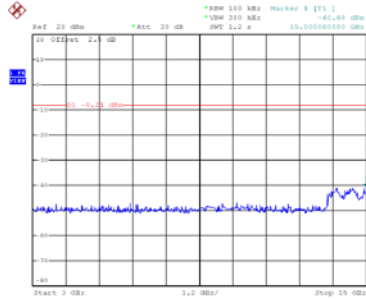

Date: 29\_JUL.2019 11:29:45

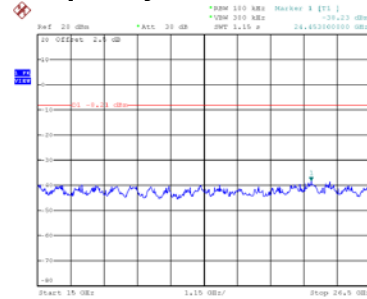

Date: 29\_JUL.2019 11:29:52

**CH11 – 10th Harmonic of the fundamental frequency**

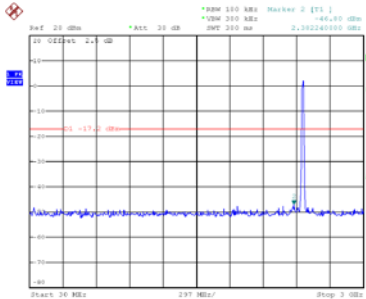

Date: 29\_JUL.2019 11:13:650

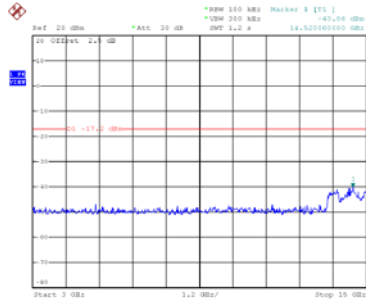

Date: 29\_JUL.2019 11:13:657

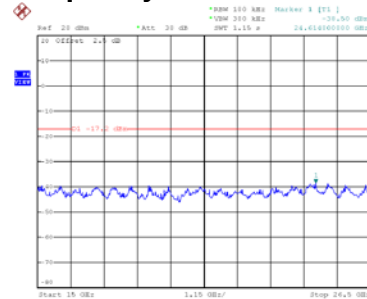

Date: 29\_JUL.2019 11:13:704

Test Mode TX G Mode\_Ant. 2

### Bandedge-CH01

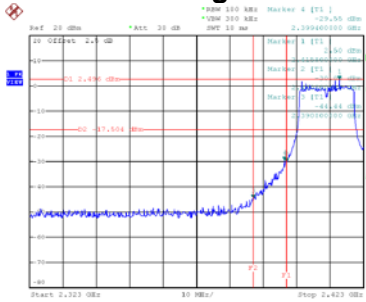

Date: 29\_JUL.2019 11:26:07

### Bandedge-CH11

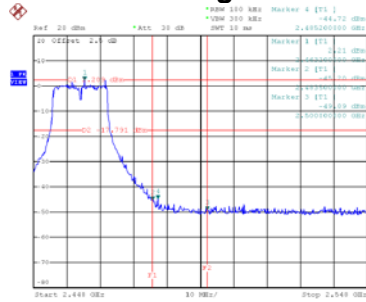

Date: 29\_JUL.2019 11:13:05

### CH01 – 10th Harmonic of the fundamental frequency

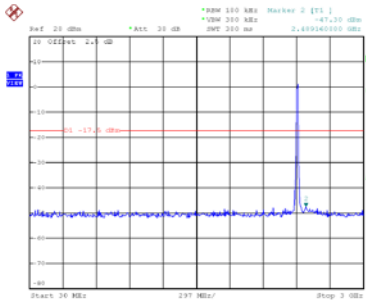

Date: 29\_JUL.2019 11:26:20

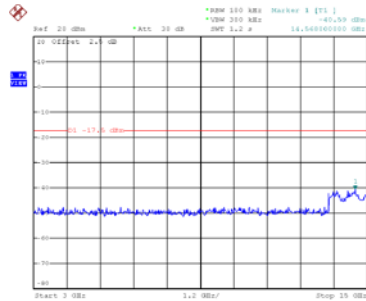

Date: 29\_JUL.2019 11:26:27

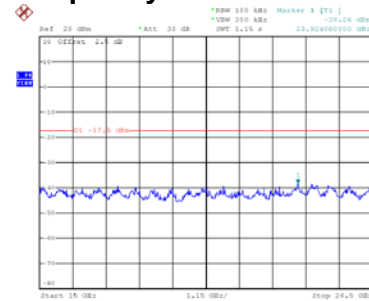

Date: 29\_JUL.2019 11:26:34

### CH06 – 10th Harmonic of the fundamental frequency

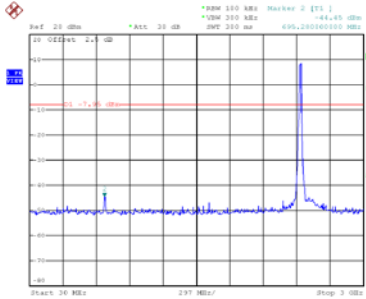

Date: 29\_JUL.2019 11:13:07

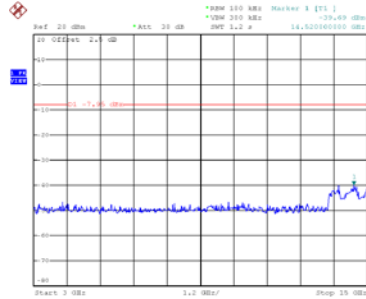

Date: 29\_JUL.2019 11:13:14

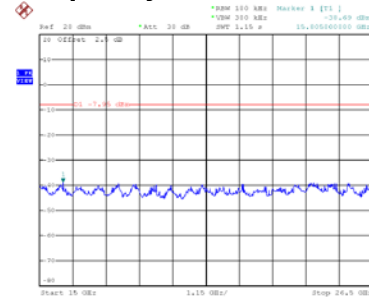

Date: 29\_JUL.2019 11:13:21

### CH11 – 10th Harmonic of the fundamental frequency

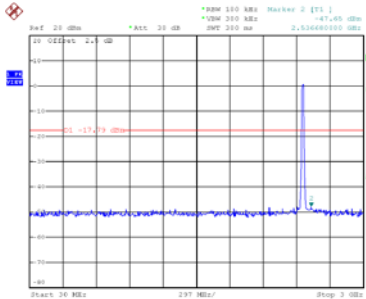

Date: 29\_JUL.2019 11:13:18

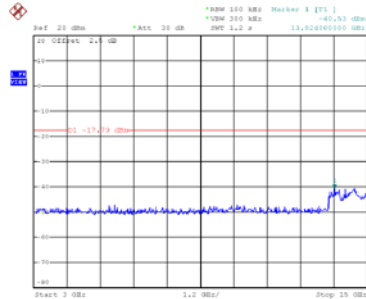

Date: 29\_JUL.2019 11:13:25

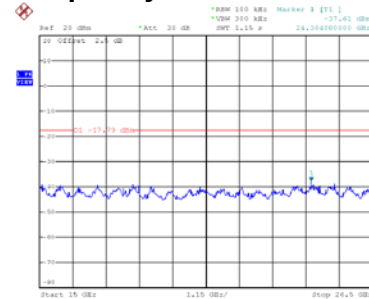

Date: 29\_JUL.2019 11:13:32

Test Mode TX G Mode\_Ant. 3

### Bandedge-CH01

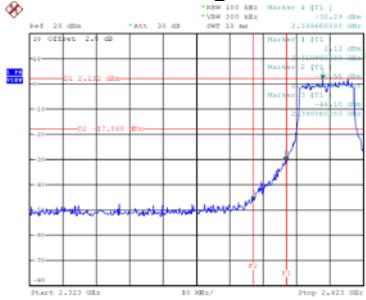

Date: 29\_JUL.2019 11:24:38

### Bandedge-CH11

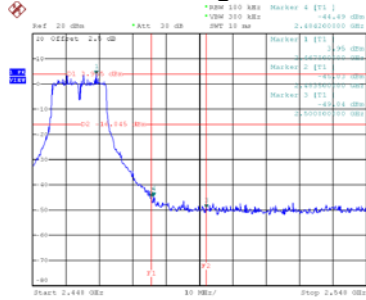

Date: 29\_JUL.2019 11:33:40

### CH01 – 10th Harmonic of the fundamental frequency

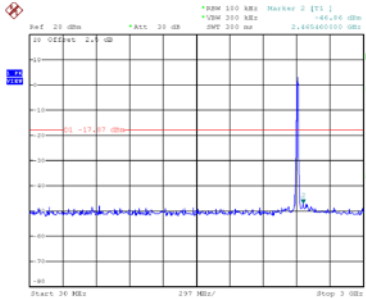

Date: 29\_JUL.2019 11:24:51

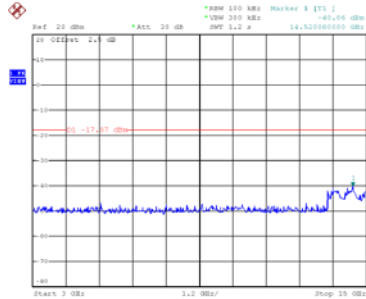

Date: 29\_JUL.2019 11:24:58

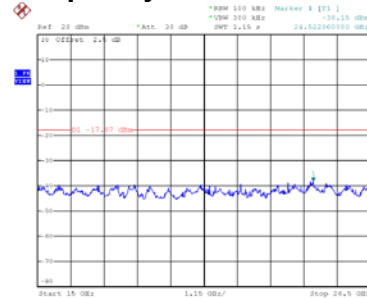

Date: 29\_JUL.2019 11:25:05

### CH06 – 10th Harmonic of the fundamental frequency

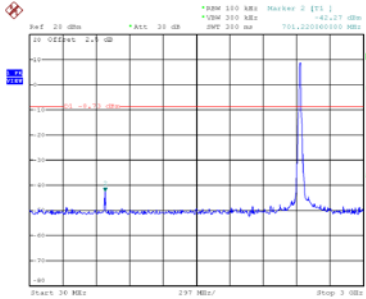

Date: 29\_JUL.2019 11:32:21

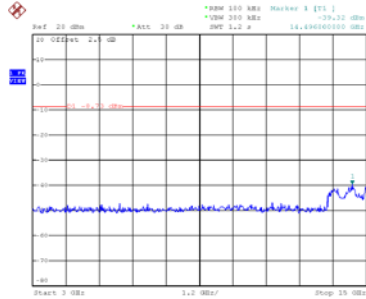

Date: 29\_JUL.2019 11:32:28

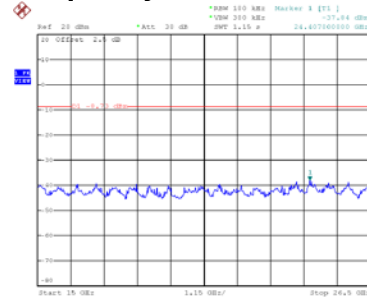

Date: 29\_JUL.2019 11:32:35

### CH11 – 10th Harmonic of the fundamental frequency

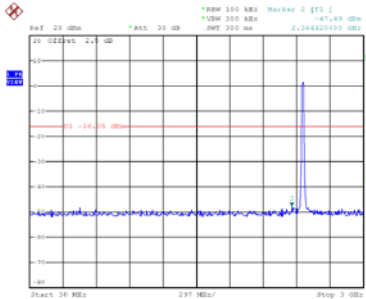

Date: 29\_JUL.2019 11:33:54

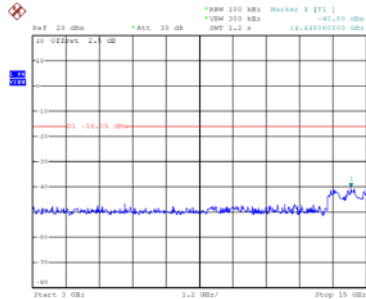

Date: 29\_JUL.2019 11:34:01

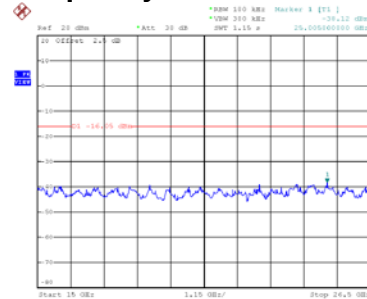

Date: 29\_JUL.2019 11:34:08

Test Mode TX N-20M Mode\_Ant. 1

### Bandedge-CH01

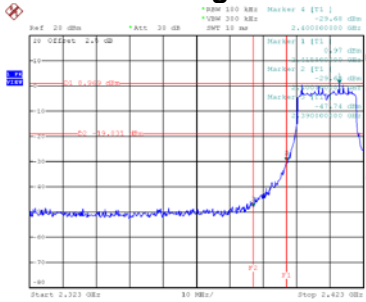

Date: 29\_JUL.2019 11:38:22

### Bandedge-CH11

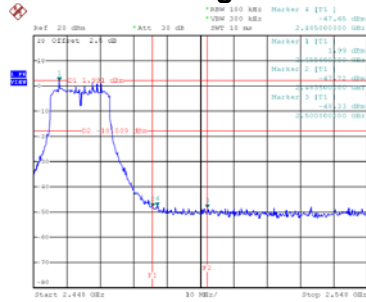

Date: 29\_JUL.2019 11:45:37

### CH01 – 10th Harmonic of the fundamental frequency

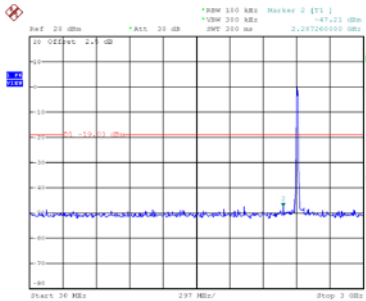

Date: 29\_JUL.2019 11:38:35

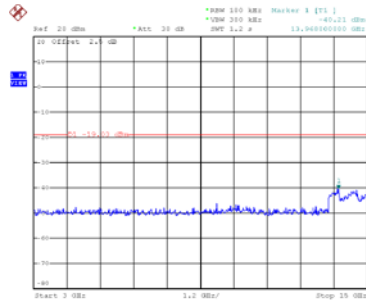

Date: 29\_JUL.2019 11:38:42

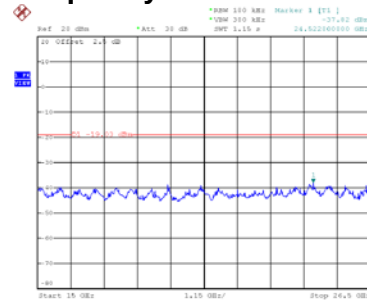

Date: 29\_JUL.2019 11:38:49

### CH06 – 10th Harmonic of the fundamental frequency

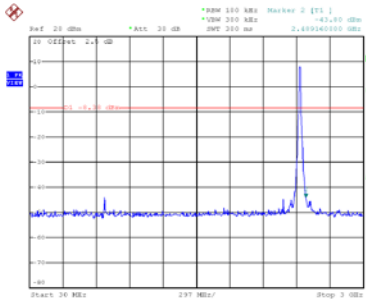

Date: 29\_JUL.2019 11:44:42

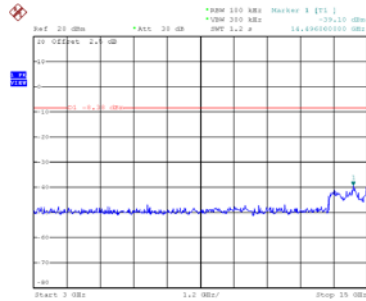

Date: 29\_JUL.2019 11:44:49

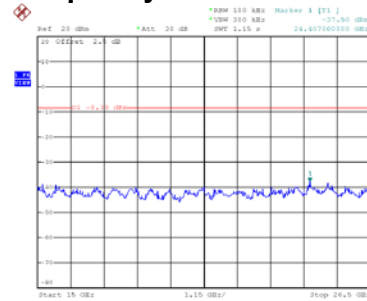

Date: 29\_JUL.2019 11:44:56

### CH11 – 10th Harmonic of the fundamental frequency

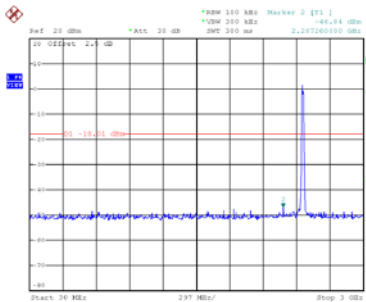

Date: 29\_JUL.2019 11:45:50

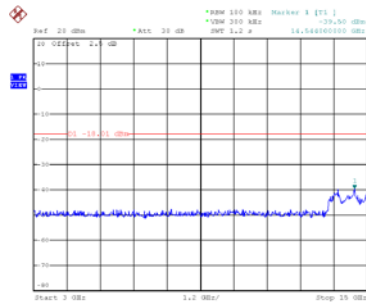

Date: 29\_JUL.2019 11:45:57

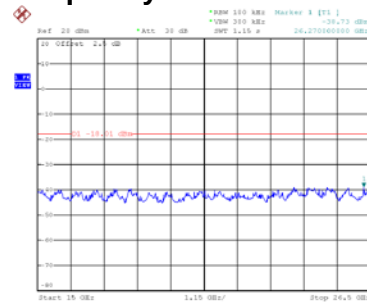

Date: 29\_JUL.2019 11:46:04

Test Mode TX N-20M Mode\_Ant. 2

**Bandedge-CH01**

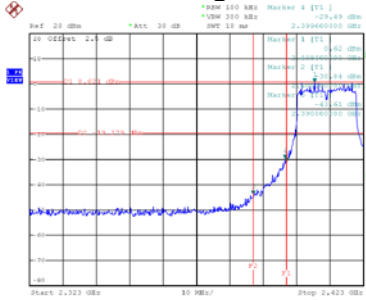

Date: 29\_JUL\_2019 11:39:42

**Bandedge-CH11**

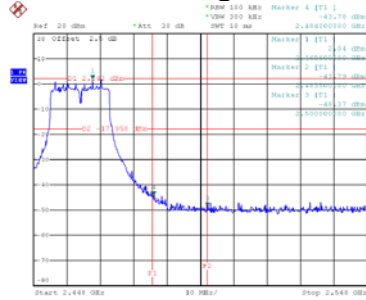

Date: 29\_JUL\_2019 11:48:01

**CH01 – 10th Harmonic of the fundamental frequency**

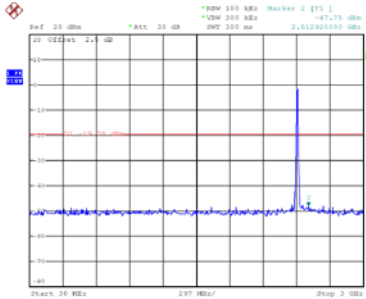

Date: 29\_JUL\_2019 11:39:55

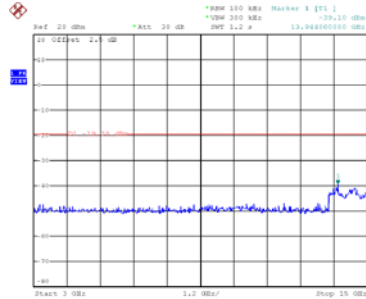

Date: 29\_JUL\_2019 11:40:02

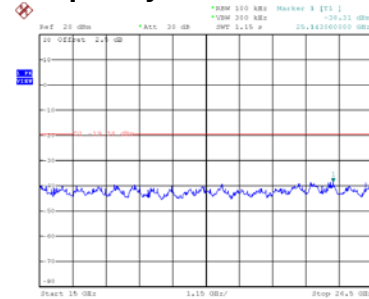

Date: 29\_JUL\_2019 11:40:09

**CH06 – 10th Harmonic of the fundamental frequency**

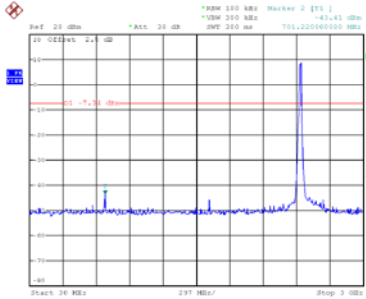

Date: 29\_JUL\_2019 11:43:26

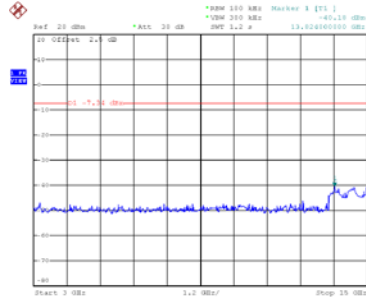

Date: 29\_JUL\_2019 11:43:43

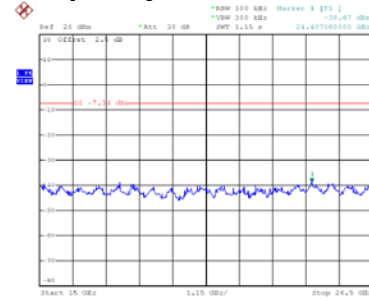

Date: 29\_JUL\_2019 11:43:51

**CH11 – 10th Harmonic of the fundamental frequency**

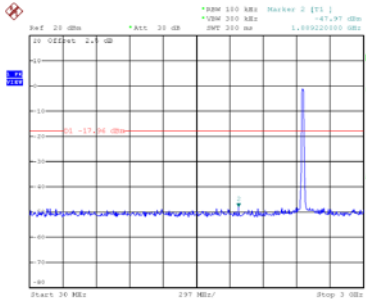

Date: 29\_JUL\_2019 11:48:14

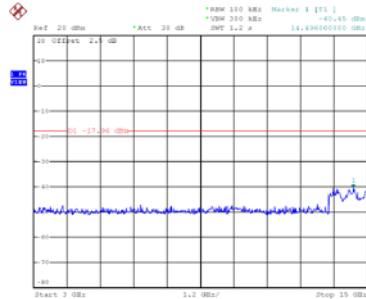

Date: 29\_JUL\_2019 11:48:21

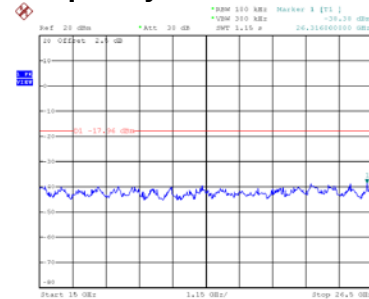

Date: 29\_JUL\_2019 11:48:29



Test Mode TX N-20M Mode\_Ant. 3

**Bandedge-CH01**

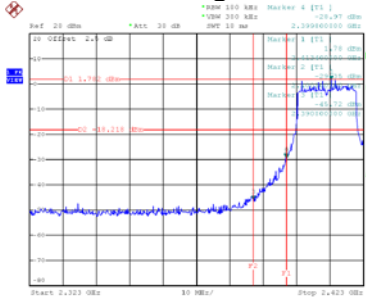

Date: 29\_JUL\_2019 11:49:54

**Bandedge-CH11**

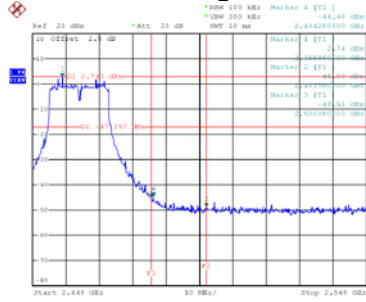

Date: 29\_JUL\_2019 11:49:10

**CH01 – 10th Harmonic of the fundamental frequency**

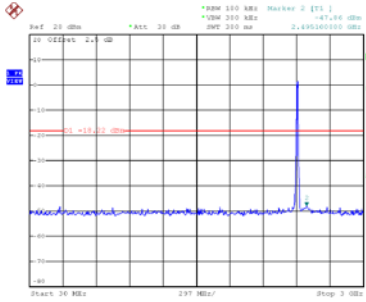

Date: 29\_JUL\_2019 11:41:07

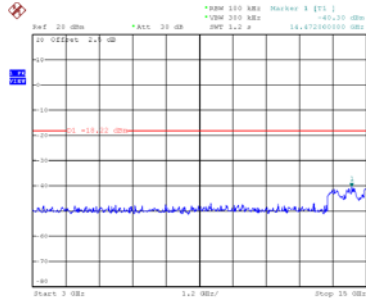

Date: 29\_JUL\_2019 11:41:14

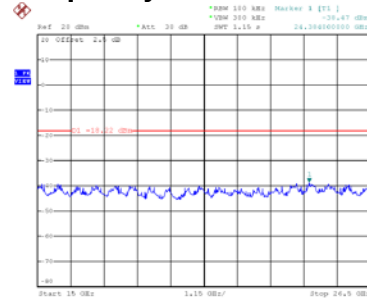

Date: 29\_JUL\_2019 11:41:21

**CH06 – 10th Harmonic of the fundamental frequency**

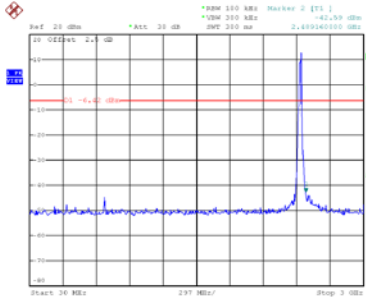

Date: 29\_JUL\_2019 11:42:33

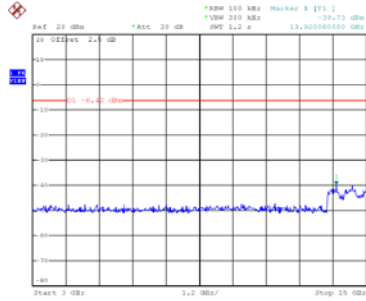

Date: 29\_JUL\_2019 11:42:38

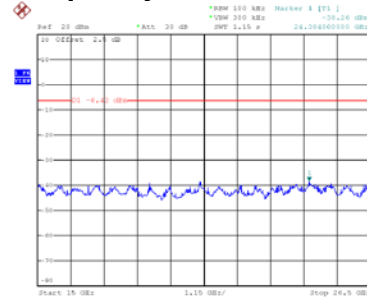

Date: 29\_JUL\_2019 11:42:45

**CH11 – 10th Harmonic of the fundamental frequency**

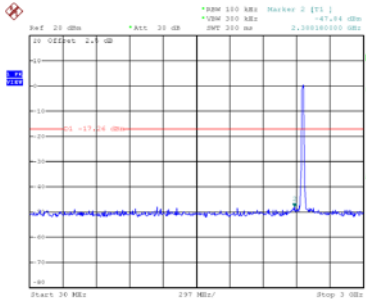

Date: 29\_JUL\_2019 11:49:23

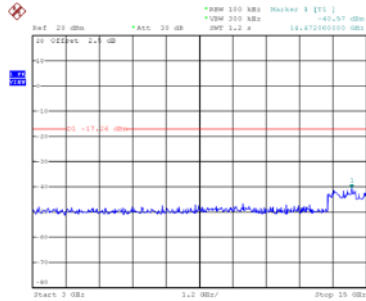

Date: 29\_JUL\_2019 11:49:30

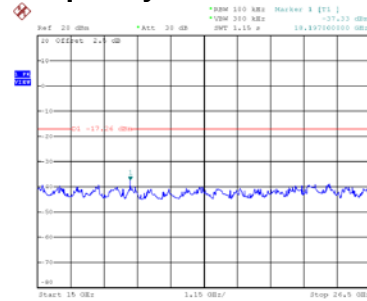

Date: 29\_JUL\_2019 11:49:37

Test Mode TX N-40M Mode\_Ant. 1

### Bandedge-CH03

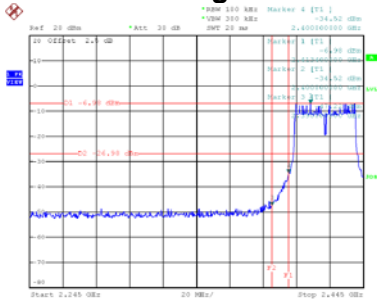

Date: 29\_JUL.2019 11:54:03

### Bandedge-CH09

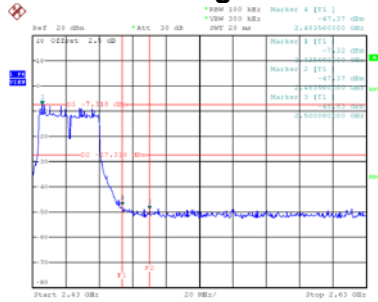

Date: 29\_JUL.2019 12:01:04

### CH03 – 10th Harmonic of the fundamental frequency

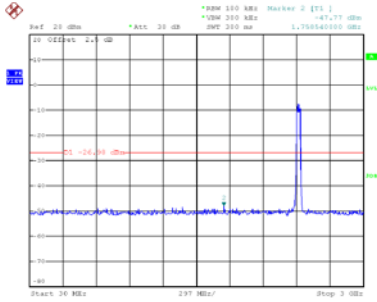

Date: 29\_JUL.2019 11:54:16

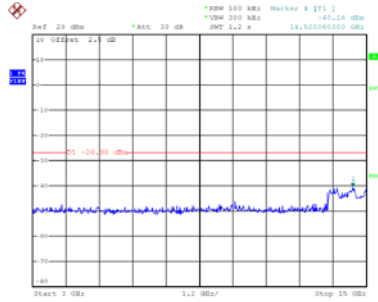

Date: 29\_JUL.2019 11:54:23

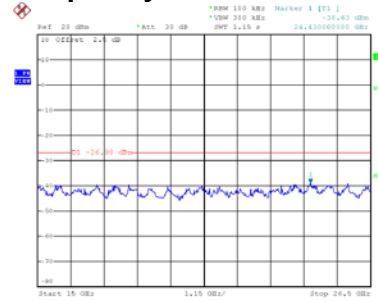

Date: 29\_JUL.2019 11:54:30

### CH06 – 10th Harmonic of the fundamental frequency

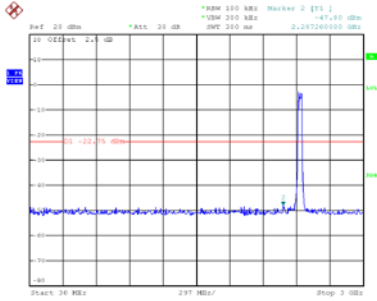

Date: 29\_JUL.2019 11:55:41

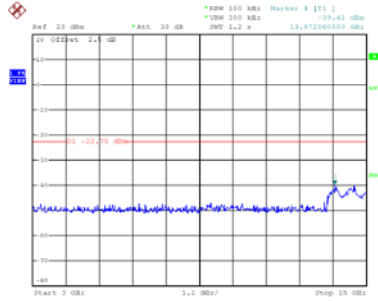

Date: 29\_JUL.2019 11:55:48

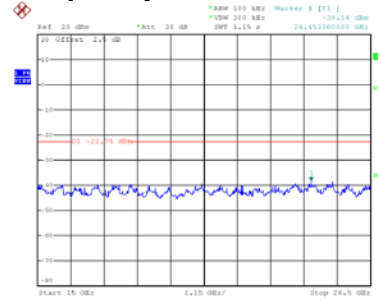

Date: 29\_JUL.2019 11:55:55

### CH09 – 10th Harmonic of the fundamental frequency

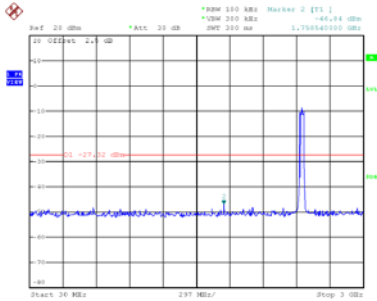

Date: 29\_JUL.2019 12:01:17

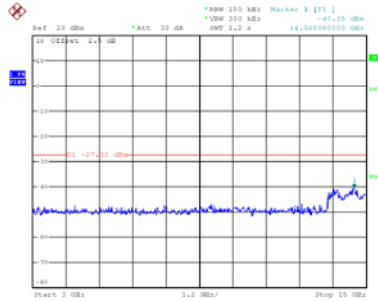

Date: 29\_JUL.2019 12:01:24

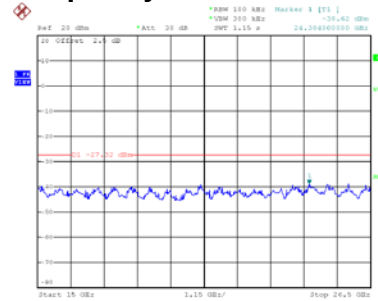

Date: 29\_JUL.2019 12:01:31

Test Mode TX N-40M Mode\_Ant. 2

**Bandedge-CH03**

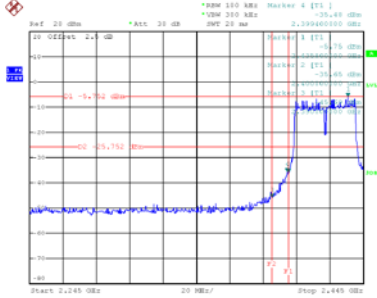

**Bandedge-CH09**

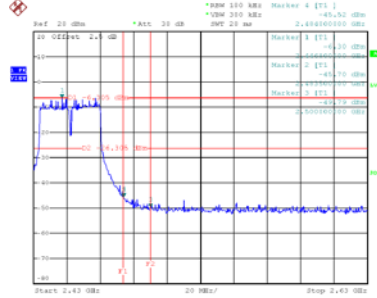

**CH03 – 10th Harmonic of the fundamental frequency**

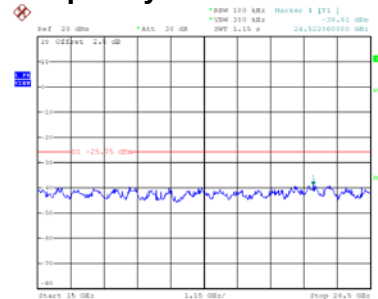
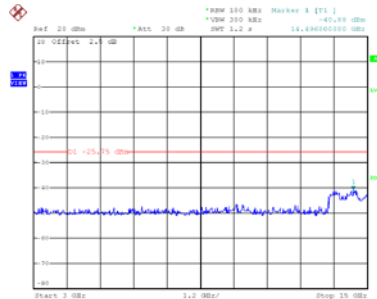
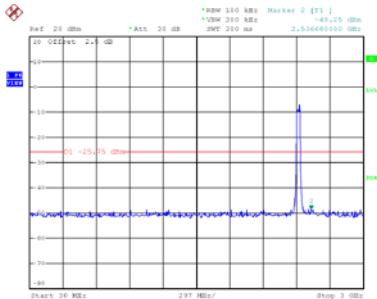

**CH06 – 10th Harmonic of the fundamental frequency**

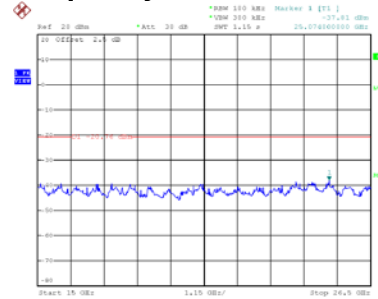
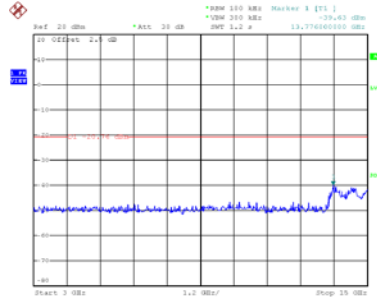
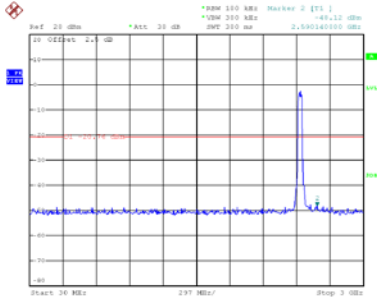

**CH09 – 10th Harmonic of the fundamental frequency**

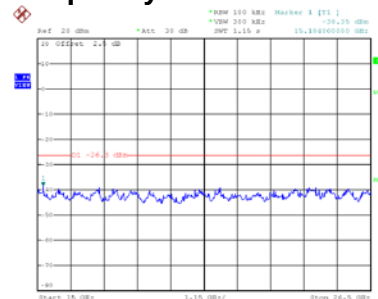
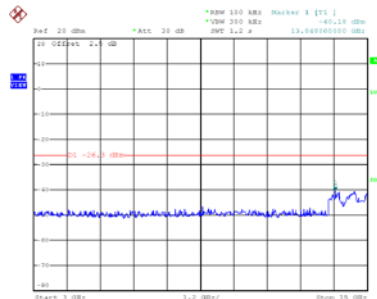
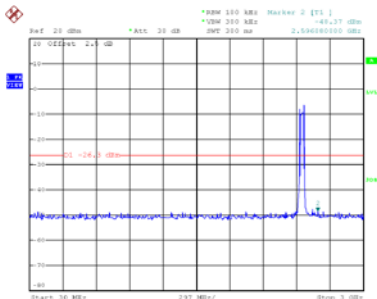

Test Mode TX N-40M Mode\_Ant. 3

Bandedge-CH03

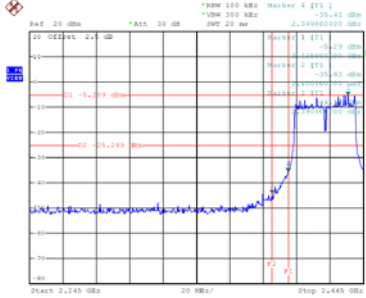

Date: 29\_JUL.2019 11:51:14

Bandedge-CH09

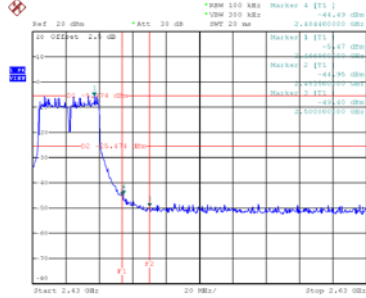

Date: 29\_JUL.2019 11:58:17

CH03 – 10th Harmonic of the fundamental frequency

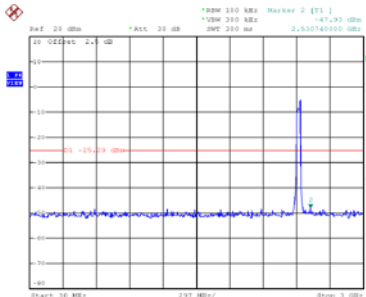

Date: 29\_JUL.2019 11:51:28

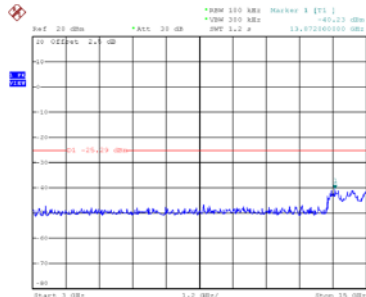

Date: 29\_JUL.2019 11:51:35

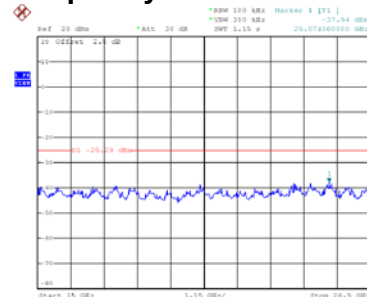

Date: 29\_JUL.2019 11:51:42

CH06 – 10th Harmonic of the fundamental frequency

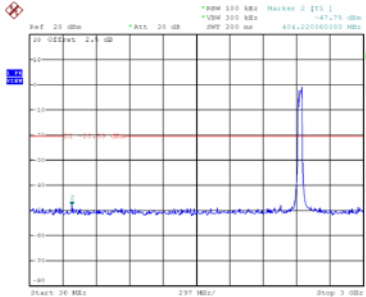

Date: 29\_JUL.2019 11:57:45

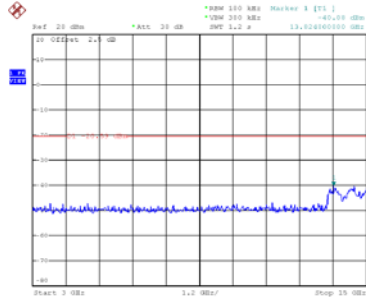

Date: 29\_JUL.2019 11:57:52

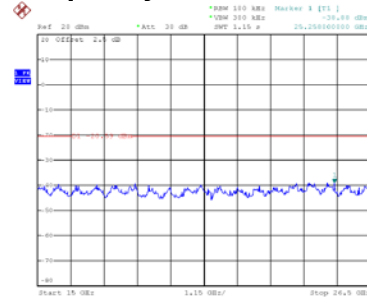

Date: 29\_JUL.2019 11:57:59

CH09 – 10th Harmonic of the fundamental frequency

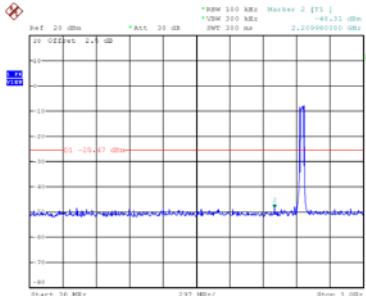

Date: 29\_JUL.2019 11:58:50

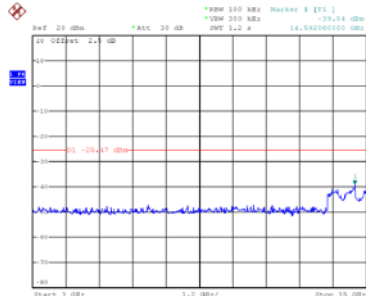

Date: 29\_JUL.2019 11:58:57

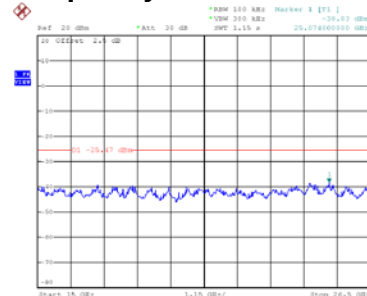

Date: 29\_JUL.2019 11:59:04

## APPENDIX H - POWER SPECTRAL DENSITY

### Non-Beamforming

<b>Test Mode</b>	<b>TX B Mode_Ant. 1</b>
------------------	-------------------------

Channel	Frequency (MHz)	Power Spectral Density (dBm/3kHz)	Max. Limit (dBm/3kHz)	Result
01	2412	-1.01	8	Complies
06	2437	-1.08	8	Complies
11	2462	-0.51	8	Complies

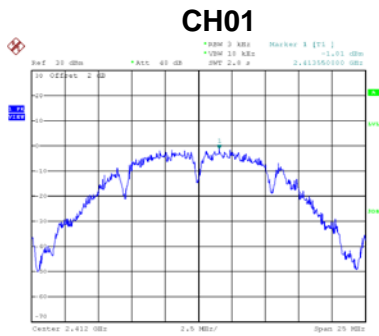

Date: 3.JUL.2019 10:58:41

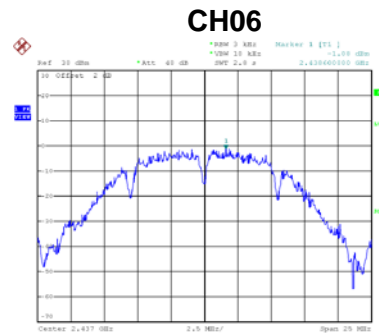

Date: 3.JUL.2019 11:00:37

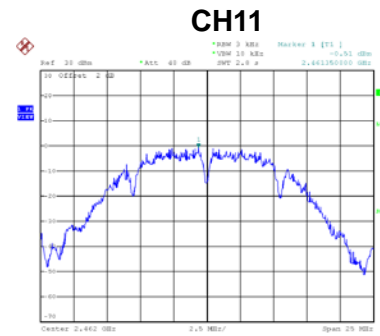

Date: 3.JUL.2019 11:05:03

<b>Test Mode</b>	<b>TX B Mode_Ant. 2</b>
------------------	-------------------------

Channel	Frequency (MHz)	Power Spectral Density (dBm/3kHz)	Max. Limit (dBm/3kHz)	Result
01	2412	-0.58	8	Complies
06	2437	-1.22	8	Complies
11	2462	-1.57	8	Complies

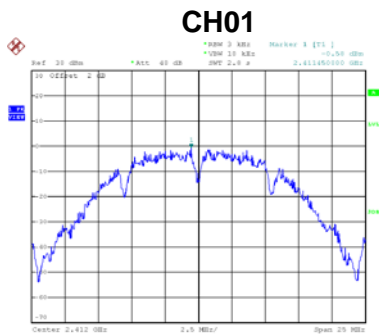

Date: 3.JUL.2019 10:58:11

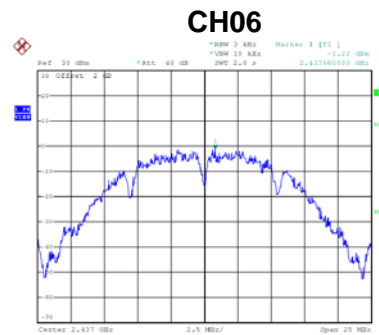

Date: 3.JUL.2019 11:06:17

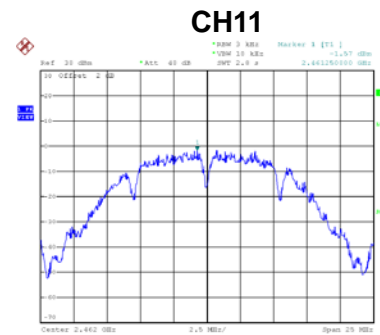

Date: 3.JUL.2019 11:04:30

Test Mode	TX B Mode_Ant. 3
-----------	------------------

Channel	Frequency (MHz)	Power Spectral Density (dBm/3kHz)	Max. Limit (dBm/3kHz)	Result
01	2412	-1.22	8	Complies
06	2437	-0.26	8	Complies
11	2462	-0.50	8	Complies

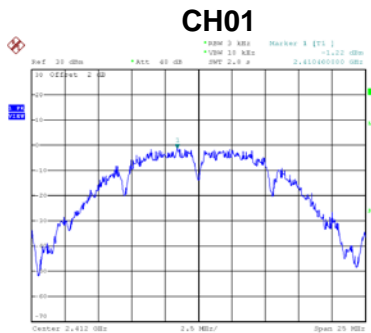

Date: 3\_JUL-2019 10:57:08

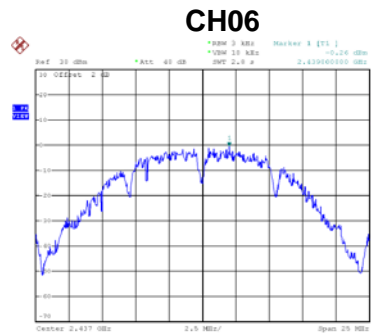

Date: 3\_JUL-2019 11:02:48

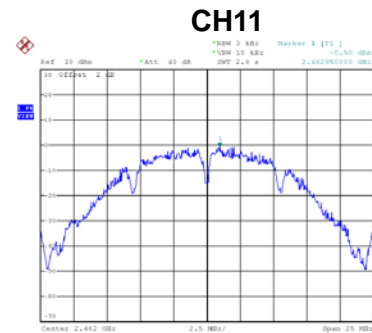

Date: 3\_JUL-2019 11:03:51

Test Mode	TX B Mode_Total
-----------	-----------------

Channel	Frequency (MHz)	Power Spectral Density (dBm/3kHz)	Max. Limit (dBm/3kHz)	Result
01	2412	3.84	8	Complies
06	2437	3.94	8	Complies
11	2462	3.94	8	Complies

Test Mode	TX G Mode_Ant. 1
-----------	------------------

Channel	Frequency (MHz)	Power Spectral Density (dBm/3kHz)	Max. Limit (dBm/3kHz)	Result
01	2412	-1.50	8	Complies
06	2437	-0.80	8	Complies
11	2462	-1.14	8	Complies

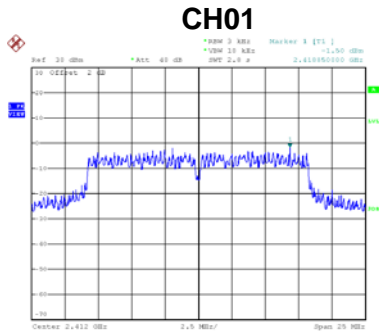

Date: 3.JUL.2019 11:08:29

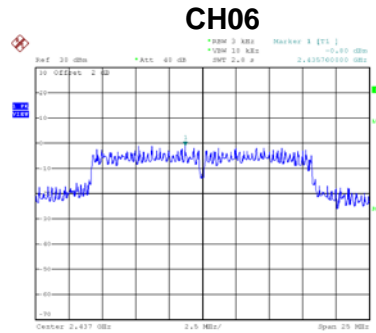

Date: 3.JUL.2019 11:11:36

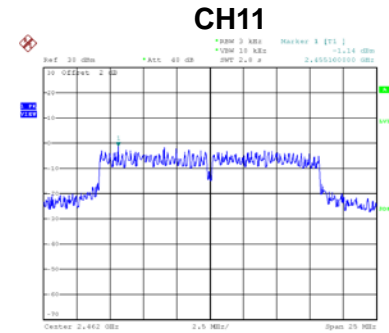

Date: 3.JUL.2019 11:12:32

Test Mode	TX G Mode_Ant. 2
-----------	------------------

Channel	Frequency (MHz)	Power Spectral Density (dBm/3kHz)	Max. Limit (dBm/3kHz)	Result
01	2412	-2.07	8	Complies
06	2437	-1.10	8	Complies
11	2462	-2.51	8	Complies

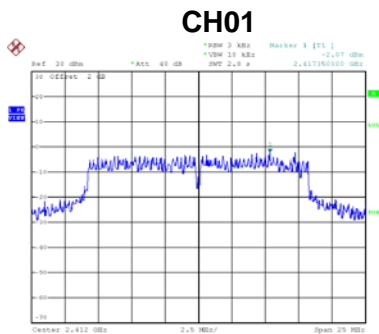

Date: 3.JUL.2019 11:07:52

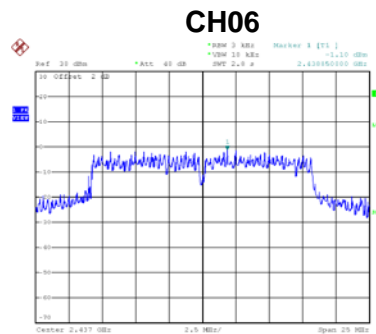

Date: 3.JUL.2019 11:10:39

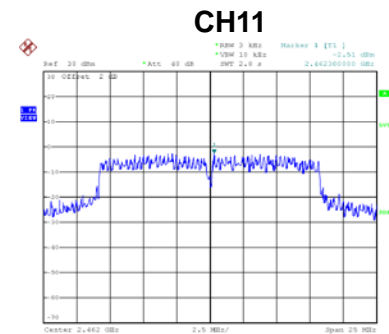

Date: 3.JUL.2019 11:10:47



Test Mode	TX G Mode_Ant. 3
-----------	------------------

Channel	Frequency (MHz)	Power Spectral Density (dBm/3kHz)	Max. Limit (dBm/3kHz)	Result
01	2412	-1.78	8	Complies
06	2437	-0.28	8	Complies
11	2462	-1.58	8	Complies

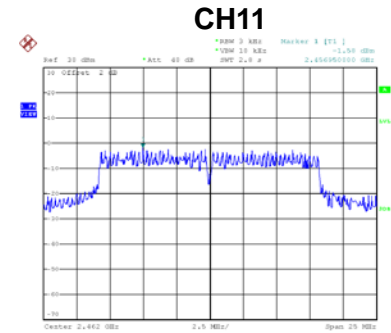
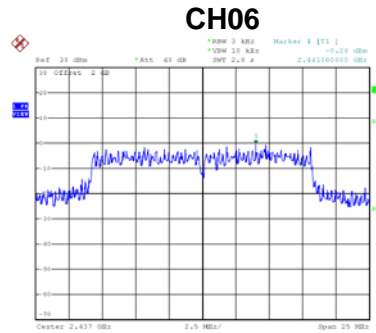
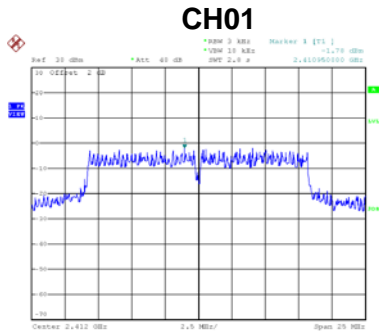

Test Mode	TX G Mode_Total
-----------	-----------------

Channel	Frequency (MHz)	Power Spectral Density (dBm/3kHz)	Max. Limit (dBm/3kHz)	Result
01	2412	2.99	8	Complies
06	2437	4.06	8	Complies
11	2462	3.06	8	Complies

Test Mode	TX N-20M Mode_Ant. 1
-----------	----------------------

Channel	Frequency (MHz)	Power Spectral Density (dBm/3kHz)	Max. Limit (dBm/3kHz)	Result
01	2412	-1.63	8	Complies
06	2437	-0.51	8	Complies
11	2462	-2.15	8	Complies

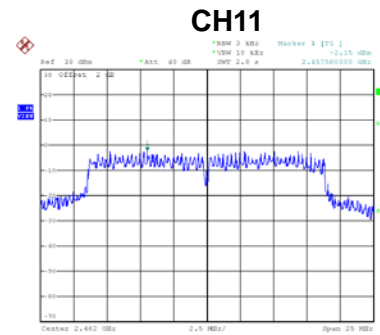
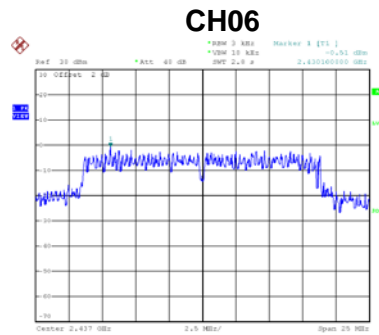
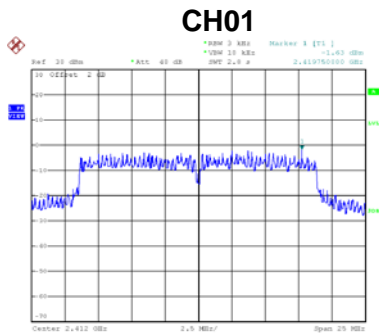

Test Mode	TX N-20M Mode_Ant. 2
-----------	----------------------

Channel	Frequency (MHz)	Power Spectral Density (dBm/3kHz)	Max. Limit (dBm/3kHz)	Result
01	2412	-2.14	8	Complies
06	2437	-1.68	8	Complies
11	2462	-2.43	8	Complies

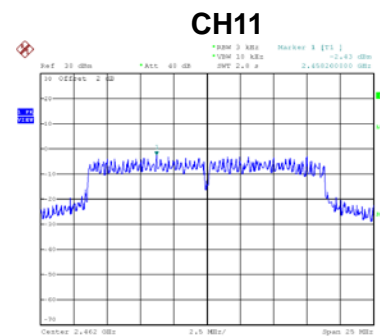
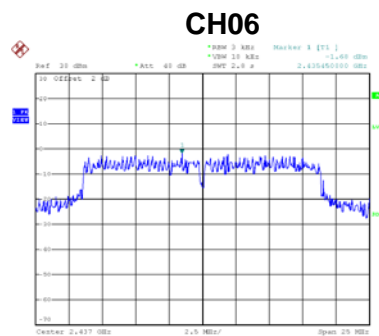
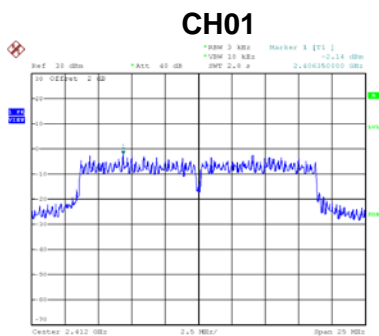

Test Mode	TX N-20M Mode_Ant. 3
-----------	----------------------

Channel	Frequency (MHz)	Power Spectral Density (dBm/3kHz)	Max. Limit (dBm/3kHz)	Result
01	2412	-2.92	8	Complies
06	2437	-2.80	8	Complies
11	2462	-3.66	8	Complies

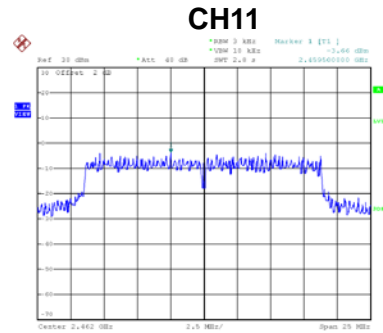
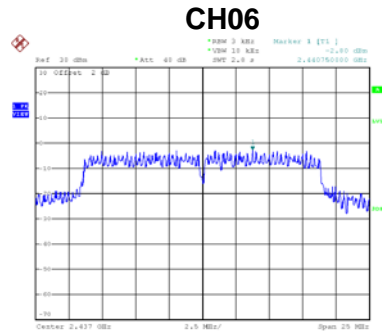
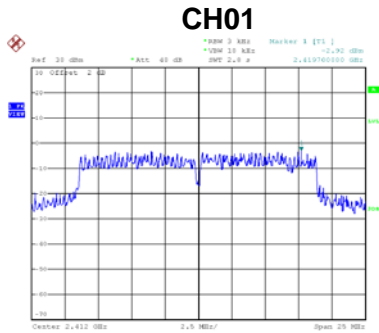

Test Mode	TX N-20M Mode_Total
-----------	---------------------

Channel	Frequency (MHz)	Power Spectral Density (dBm/3kHz)	Max. Limit (dBm/3kHz)	Result
01	2412	2.57	8	Complies
06	2437	3.21	8	Complies
11	2462	2.07	8	Complies

Test Mode	TX N-40M Mode_Ant. 1
-----------	----------------------

Channel	Frequency (MHz)	Power Spectral Density (dBm/3kHz)	Max. Limit (dBm/3kHz)	Result
03	2422	-5.43	8	Complies
06	2437	-5.19	8	Complies
09	2452	-5.59	8	Complies

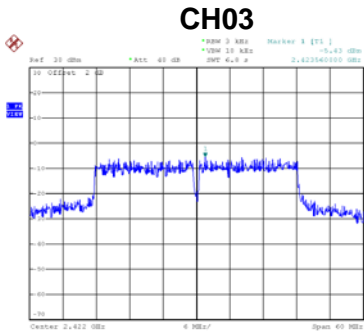

Date: 3.JUL.2019 11:29:20

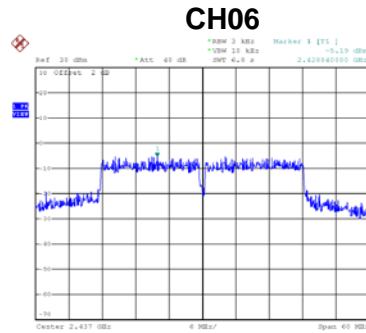

Date: 3.JUL.2019 11:31:58

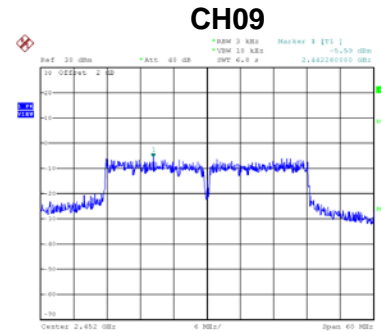

Date: 3.JUL.2019 11:36:04

Test Mode	TX N-40M Mode_Ant. 2
-----------	----------------------

Channel	Frequency (MHz)	Power Spectral Density (dBm/3kHz)	Max. Limit (dBm/3kHz)	Result
03	2422	-5.61	8	Complies
06	2437	-4.07	8	Complies
09	2452	-3.67	8	Complies

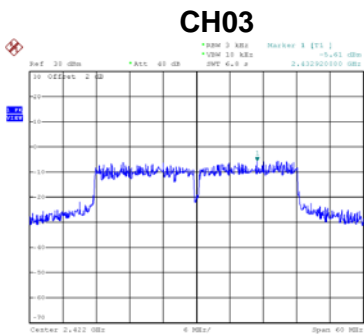

Date: 3.JUL.2019 11:28:44

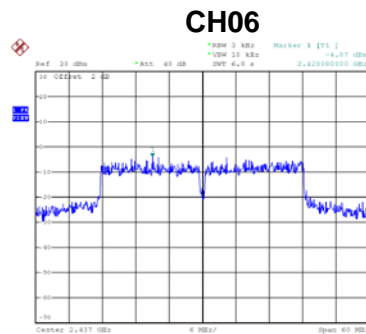

Date: 3.JUL.2019 11:32:42

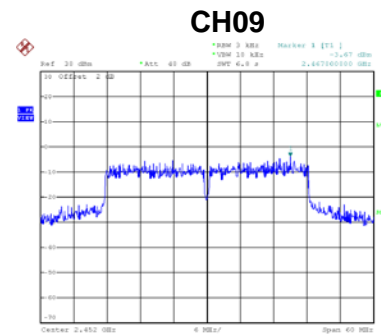

Date: 3.JUL.2019 11:35:42

Test Mode	TX N-40M Mode_Ant. 3
-----------	----------------------

Channel	Frequency (MHz)	Power Spectral Density (dBm/3kHz)	Max. Limit (dBm/3kHz)	Result
03	2422	-6.26	8	Complies
06	2437	-3.77	8	Complies
09	2452	-3.81	8	Complies

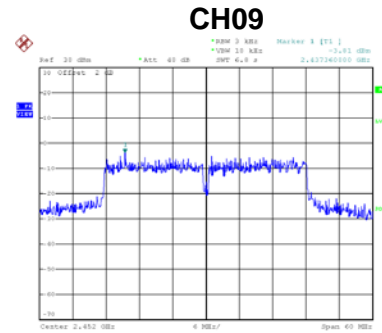
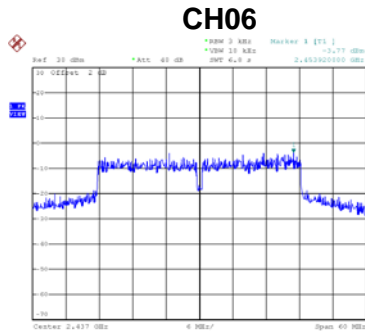
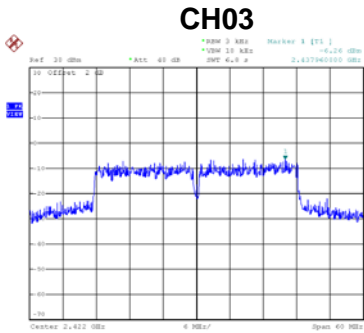

Date: 3\_JUL-2019 11:28:07

Date: 3\_JUL-2019 11:33:18

Date: 3\_JUL-2019 11:34:59

Test Mode	TX N-40M Mode_Total
-----------	---------------------

Channel	Frequency (MHz)	Power Spectral Density (dBm/3kHz)	Max. Limit (dBm/3kHz)	Result
03	2422	-0.98	8	Complies
06	2437	0.47	8	Complies
09	2452	0.50	8	Complies

End of Test Report