



# RADIO TEST REPORT

**Test Report No. : 13716647H-A**

**Applicant** : OMRON HEALTHCARE Co., Ltd.  
**Type of EUT** : Scale  
**Model Number of EUT** : SC-150  
**FCC ID** : Q6ZHN300T2  
**Test regulation** : FCC Part 15 Subpart C: 2021  
**Test Result** : Complied (Refer to SECTION 3)

1. This test report shall not be reproduced in full or partial, without the written approval of UL Japan, Inc.
2. The results in this report apply only to the sample tested.
3. This sample tested is in compliance with the limits of the above regulation.
4. The test results in this test report are traceable to the national or international standards.
5. This test report must not be used by the customer to claim product certification, approval, or endorsement by the A2LA accreditation body.
6. This test report covers Radio technical requirements.  
It does not cover administrative issues such as Manual or non-Radio test related Requirements. (if applicable)
7. The all test items in this test report are conducted by UL Japan, Inc. Ise EMC Lab.
8. The opinions and the interpretations to the result of the description in this report are outside scopes where UL Japan has been accredited.
9. The information provided from the customer for this report is identified in Section 1.

**Date of test:** March 18 to 30, 2021

**Representative test engineer:** Kiyo  
Kiyoshiro Okazaki  
Engineer

**Approved by:** Takayuki Shimada  
Takayuki Shimada  
Leader



CERTIFICATE 5107.02

- The testing in which "Non-accreditation" is displayed is outside the accreditation scopes in UL Japan.  
 There is no testing item of "Non-accreditation".

**UL Japan, Inc.**  
**Ise EMC Lab.**

4383-326 Asama-cho, Ise-shi, Mie-ken 516-0021 JAPAN  
Telephone : +81 596 24 8999  
Facsimile : +81 596 24 8124

## **REVISION HISTORY**

**Original Test Report No.: 13716647H-A**

Revision	Test report No.	Date	Page revised	Contents
- (Original)	13716647H-A	May 27, 2021	-	-

---

**UL Japan, Inc.**

**Ise EMC Lab.**

4383-326 Asama-cho, Ise-shi, Mie-ken 516-0021 JAPAN

Telephone : +81 596 24 8999

Facsimile : +81 596 24 8124

## Reference: Abbreviations (Including words undescribed in this report)

A2LA	The American Association for Laboratory Accreditation	MCS	Modulation and Coding Scheme
AC	Alternating Current	MRA	Mutual Recognition Arrangement
AFH	Adaptive Frequency Hopping	N/A	Not Applicable
AM	Amplitude Modulation	NIST	National Institute of Standards and Technology
Amp, AMP	Amplifier	NS	No signal detect.
ANSI	American National Standards Institute	NSA	Normalized Site Attenuation
Ant, ANT	Antenna	NVLAP	National Voluntary Laboratory Accreditation Program
AP	Access Point	OBW	Occupied Band Width
ASK	Amplitude Shift Keying	OFDM	Orthogonal Frequency Division Multiplexing
Atten., ATT	Attenuator	P/M	Power meter
AV	Average	PCB	Printed Circuit Board
BPSK	Binary Phase-Shift Keying	PER	Packet Error Rate
BR	Bluetooth Basic Rate	PHY	Physical Layer
BT	Bluetooth	PK	Peak
BT LE	Bluetooth Low Energy	PN	Pseudo random Noise
BW	BandWidth	PRBS	Pseudo-Random Bit Sequence
Cal Int	Calibration Interval	PSD	Power Spectral Density
CCK	Complementary Code Keying	QAM	Quadrature Amplitude Modulation
Ch., CH	Channel	QP	Quasi-Peak
CISPR	Comite International Special des Perturbations Radioelectriques	QPSK	Quadri-Phase Shift Keying
CW	Continuous Wave	RBW	Resolution Band Width
DBPSK	Differential BPSK	RDS	Radio Data System
DC	Direct Current	RE	Radio Equipment
D-factor	Distance factor	RF	Radio Frequency
DFS	Dynamic Frequency Selection	RMS	Root Mean Square
DQPSK	Differential QPSK	RSS	Radio Standards Specifications
DSSS	Direct Sequence Spread Spectrum	Rx	Receiving
EDR	Enhanced Data Rate	SA, S/A	Spectrum Analyzer
EIRP, e.i.r.p.	Equivalent Isotropically Radiated Power	SG	Signal Generator
EMC	ElectroMagnetic Compatibility	SVSWR	Site-Voltage Standing Wave Ratio
EMI	ElectroMagnetic Interference	TR	Test Receiver
EN	European Norm	Tx	Transmitting
ERP, e.r.p.	Effective Radiated Power	VBW	Video BandWidth
EU	European Union	Vert.	Vertical
EUT	Equipment Under Test	WLAN	Wireless LAN
Fac.	Factor		
FCC	Federal Communications Commission		
FHSS	Frequency Hopping Spread Spectrum		
FM	Frequency Modulation		
Freq.	Frequency		
FSK	Frequency Shift Keying		
GFSK	Gaussian Frequency-Shift Keying		
GNSS	Global Navigation Satellite System		
GPS	Global Positioning System		
Hori.	Horizontal		
ICES	Interference-Causing Equipment Standard		
IEC	International Electrotechnical Commission		
IEEE	Institute of Electrical and Electronics Engineers		
IF	Intermediate Frequency		
ILAC	International Laboratory Accreditation Conference		
ISED	Innovation, Science and Economic Development Canada		
ISO	International Organization for Standardization		
JAB	Japan Accreditation Board		
LAN	Local Area Network		
LIMS	Laboratory Information Management System		

**UL Japan, Inc.**

**Ise EMC Lab.**

4383-326 Asama-cho, Ise-shi, Mie-ken 516-0021 JAPAN

Telephone : +81 596 24 8999

Facsimile : +81 596 24 8124

<b>CONTENTS</b>	<b>PAGE</b>
<b>SECTION 1: Customer information.....</b>	<b>5</b>
<b>SECTION 2: Equipment under test (EUT).....</b>	<b>5</b>
<b>SECTION 3: Test specification, procedures &amp; results.....</b>	<b>6</b>
<b>SECTION 4: Operation of EUT during testing.....</b>	<b>9</b>
<b>SECTION 5: Radiated Spurious Emission .....</b>	<b>9</b>
<b>SECTION 6: Antenna Terminal Conducted Tests.....</b>	<b>13</b>
<b>APPENDIX 1: Test data .....</b>	<b>14</b>
6 dB Bandwidth and 99 % Occupied Bandwidth.....	14
Maximum Peak Output Power .....	17
Average Output Power .....	18
Radiated Spurious Emission .....	20
Conducted Spurious Emission .....	26
Power Density .....	29
<b>APPENDIX 2: Test instruments .....</b>	<b>31</b>
<b>APPENDIX 3: Photographs of test setup .....</b>	<b>32</b>
Radiated Spurious Emission .....	32
Worst Case Position .....	33
Antenna Terminal Conducted Tests.....	34

## **SECTION 1: Customer information**

Company Name : OMRON HEALTHCARE Co., Ltd.  
Address : 53, Kunotsubo, Terado-cho, Muko, KYOTO, 617-0002 Japan  
Telephone Number : 075-925-2045  
Facsimile Number : 075-925-2046  
Contact Person : Mitsunori Hara

The information provided from the customer is as follows;

- Applicant, Type of EUT, Model Number of EUT, FCC ID on the cover and other relevant pages
- Operating/Test Mode(s) (Mode(s)) on all the relevant pages
- SECTION 1: Customer information
- SECTION 2: Equipment under test (EUT) other than the Receipt Date
- SECTION 4: Operation of EUT during testing

\* The laboratory is exempted from liability of any test results affected from the above information in SECTION 2 and 4.

## **SECTION 2: Equipment under test (EUT)**

### **2.1 Identification of EUT**

Type : Scale  
Model Number : SC-150  
Serial Number : Refer to SECTION 4.2  
Rating : DC 6.0V  
Receipt Date : March 17, 2021  
Country of Mass-production : Japan  
Condition : Production prototype  
(Not for Sale: This sample is equivalent to mass-produced items.)  
Modification : No Modification by the test lab.

### **2.2 Product Description**

Model: SC-150 (referred to as the EUT in this report) is a Scale.

### **Radio Specification**

Radio Type : Transceiver  
Frequency of Operation : 2402 MHz - 2480 MHz  
Modulation : GFSK  
Antenna type : Pattern Antenna  
Antenna Gain : -2.37 dBi  
Clock frequency (Maximum) : 32 MHz

## **SECTION 3: Test specification, procedures & results**

### **3.1 Test Specification**

Test Specification : FCC Part 15 Subpart C  
FCC Part 15 final revised on May 3, 2021 and effective July 2, 2021

Title : FCC 47 CFR Part 15 Radio Frequency Device Subpart C Intentional Radiators  
Section 15.207 Conducted limits  
Section 15.247 Operation within the bands 902-928 MHz, 2400-2483.5 MHz,  
and 5725-5850 MHz

\* The revision does not affect the test result conducted before its effective date.

\*The customer has declared that the EUT has complies with FCC Part 15 Subpart B as SDoC.

### **3.2 Procedures and results**

Item	Test Procedure	Specification	Worst margin	Results	Remarks
Conducted Emission	FCC: ANSI C63.10-2013 6. Standard test methods ISED: RSS-Gen 8.8	FCC: Section 15.207 ----- ISED: RSS-Gen 8.8	N/A	N/A	*1)
6dB Bandwidth	FCC: KDB 558074 D01 15.247 Meas Guidance v05r02 ISED: -	FCC: Section 15.247(a)(2) ----- ISED: RSS-247 5.2(a)	See data.	Complied a)	Conducted
Maximum Peak Output Power	FCC: KDB 558074 D01 15.247 Meas Guidance v05r02 ISED: RSS-Gen 6.12	FCC: Section 15.247(b)(3) ----- ISED: RSS-247 5.4(d)		Complied b)	Conducted
Power Density	FCC: KDB 558074 D01 15.247 Meas Guidance v05r02 ISED: -	FCC: Section 15.247(e) ----- ISED: RSS-247 5.2(b)		Complied c)	Conducted
Spurious Emission Restricted Band Edges	FCC: KDB 558074 D01 15.247 Meas Guidance v05r02 ISED: RSS-Gen 6.13	FCC: Section 15.247(d) ----- ISED: RSS-247 5.5 RSS-Gen 8.9 RSS-Gen 8.10	17.4 dB 2390.000 MHz, Vertical, AV	Complied d), e)	Conducted (below 30 MHz)/ Radiated (above 30 MHz) *2)

Note: UL Japan, Inc.'s EMI Work Procedures No. 13-EM-W0420 and 13-EM-W0422.

\*1) The test was not performed since the EUT does not have AC port.

\*2) Radiated test was selected over 30 MHz based on section 15.247(d) and KDB 558074 D01 15.247 Meas Guidance v05r02 8.5 and 8.6.

a) Refer to APPENDIX 1 (data of 6 dB Bandwidth and 99 % Occupied Bandwidth)

b) Refer to APPENDIX 1 (data of Maximum Peak Output Power)

c) Refer to APPENDIX 1 (data of Power Density)

d) Refer to APPENDIX 1 (data of Conducted Spurious Emission)

e) Refer to APPENDIX 1 (data of Radiated Spurious Emission)

Symbols:

Complied The data of this test item has enough margin, more than the measurement uncertainty.

Complied# The data of this test item meets the limits unless the measurement uncertainty is taken into consideration.

\* In case any questions arise about test procedure, ANSI C63.10: 2013 is also referred.

#### **FCC Part 15.31 (e)**

The test was performed with the New Battery and the stable voltage was supplied to the EUT RF module during the tests. Therefore, the EUT complies with the requirement.

#### **FCC Part 15.203 Antenna requirement**

It is impossible for end users to replace the antenna, because the antenna is mounted inside of the EUT. Therefore, the equipment complies with the antenna requirement of Section 15.203.

**UL Japan, Inc.**

**Ise EMC Lab.**

4383-326 Asama-cho, Ise-shi, Mie-ken 516-0021 JAPAN

Telephone : +81 596 24 8999

Facsimile : +81 596 24 8124

### 3.3 Addition to standard

Item	Test Procedure	Specification	Worst margin	Results	Remarks
99% Occupied Bandwidth	ISED: RSS-Gen 6.7	ISED: -	N/A	-	Conducted

Other than above, no addition, exclusion nor deviation has been made from the standard.

### 3.4 Uncertainty

There is no applicable rule of uncertainty in this applied standard. Therefore, the results are derived depending on whether or not laboratory uncertainty is applied.

The following uncertainties have been calculated to provide a confidence level of 95 % using a coverage factor  $k=2$ .  
Ise EMC Lab.

#### Antenna Terminal test

Test Item	Uncertainty (+/-)
20 dB Bandwidth / 99 % Occupied Bandwidth	0.96 %
Maximum Peak Output Power / Average Output Power	1.4 dB
Carrier Frequency Separation	0.42 %
Dwell time / Burst rate	0.10 %
Conducted Spurious Emission	2.6 dB

#### Radiated emission

Measurement distance	Frequency range	Uncertainty (+/-)
3 m	9 kHz to 30 MHz	3.3 dB
10 m		3.2 dB
3 m	30 MHz to 200 MHz (Horizontal) (Vertical)	4.8 dB
		5.0 dB
	200 MHz to 1000 MHz (Horizontal) (Vertical)	5.2 dB
		6.3 dB
10 m	30 MHz to 200 MHz (Horizontal) (Vertical)	4.8 dB
		4.8 dB
	200 MHz to 1000 MHz (Horizontal) (Vertical)	5.0 dB
		5.0 dB
3 m	1 GHz to 6 GHz	4.9 dB
	6 GHz to 18 GHz	5.2 dB
1 m	10 GHz to 26.5 GHz	5.5 dB
	26.5 GHz to 40 GHz	5.5 dB
10 m	1 GHz to 18 GHz	5.2 dB

### 3.5 Test Location

UL Japan, Inc. Ise EMC Lab.

\*A2LA Certificate Number: 5107.02 / FCC Test Firm Registration Number: 199967

ISED Lab Company Number: 2973C / CAB identifier: JP0002

4383-326 Asama-cho, Ise-shi, Mie-ken 516-0021 JAPAN

Telephone: +81 596 24 8999, Facsimile: +81 596 24 8124

Test site	Width x Depth x Height (m)	Size of reference ground plane (m) / horizontal conducting plane	Other rooms	Maximum measurement distance
No.1 semi-anechoic chamber	19.2 x 11.2 x 7.7	7.0 x 6.0	No.1 Power source room	10 m
No.2 semi-anechoic chamber	7.5 x 5.8 x 5.2	4.0 x 4.0	-	3 m
No.3 semi-anechoic chamber	12.0 x 8.5 x 5.9	6.8 x 5.75	No.3 Preparation room	3 m
No.3 shielded room	4.0 x 6.0 x 2.7	N/A	-	-
No.4 semi-anechoic chamber	12.0 x 8.5 x 5.9	6.8 x 5.75	No.4 Preparation room	3 m
No.4 shielded room	4.0 x 6.0 x 2.7	N/A	-	-
No.5 semi-anechoic chamber	6.0 x 6.0 x 3.9	6.0 x 6.0	-	-
No.5 measurement room	6.4 x 6.4 x 3.0	6.4 x 6.4	-	-
No.6 shielded room	4.0 x 4.5 x 2.7	4.0 x 4.5	-	-
No.6 measurement room	4.75 x 5.4 x 3.0	4.75 x 4.15	-	-
No.7 shielded room	4.7 x 7.5 x 2.7	4.7 x 7.5	-	-
No.8 measurement room	3.1 x 5.0 x 2.7	3.1 x 5.0	-	-
No.9 measurement room	8.8 x 4.6 x 2.8	2.4 x 2.4	-	-
No.11 measurement room	6.2 x 4.7 x 3.0	4.8 x 4.6	-	-

\* Size of vertical conducting plane (for Conducted Emission test) : 2.0 x 2.0 m for No.1, No.2, No.3, and No.4 semi-anechoic chambers and No.3 and No.4 shielded rooms.

### 3.6 Test data, Test instruments, and Test set up

Refer to APPENDIX.



## **SECTION 4: Operation of EUT during testing**

### **4.1 Operating Mode(s)**

<b>Mode</b>	<b>Remarks*</b>
Bluetooth Low Energy (BT LE)	Payload: PRBS9 Uncoded 1M-PHY
<p>*Power of the EUT was set by the software as follows;</p> <ul style="list-style-type: none"> <li>- Power settings: 0dBm</li> <li>- Software<sup>*1)</sup>: &lt;Radiated emission test&gt;  prod_test (Radiated TxMode 2402) for Low CH test  prod_test (Radiated TxMode 2440) for Mid CH test  prod_test (Radiated TxMode 2480) for High CH test</li> </ul> <p>&lt;Antenna Terminal Conducted test&gt;  OPM_Communication_Tool Version 1.0.0.0</p> <p>(Date: 2019/09/25, Storage location: Driven by connected PC )</p> <p>*This setting of software is the worst case.  Any conditions under the normal use do not exceed the condition of setting.  In addition, end users cannot change the settings of the output power of the product.</p>	

\*1) There is no difference in RF characteristics for each software.

\*The details of Operating mode(s)

<b>Test Item</b>	<b>Operating Mode</b>	<b>Tested frequency</b>
6dB Bandwidth and 99% Occupied Bandwidth	Tx BT LE	2402 MHz
Maximum Peak Output Power		2440 MHz
Spurious Emission (Radiated / Conducted)		2480 MHz
Power Density		

### **4.2 Configuration and peripherals**

**[Radiated emission test]**

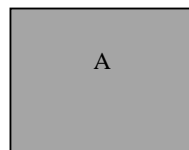

#### **Description of EUT**

<b>No.</b>	<b>Item</b>	<b>Model number</b>	<b>Serial number</b>	<b>Manufacturer</b>	<b>Remarks</b>
A	Scale	SC-150	EPR-003 *1) EPR-004 *2) EPR-005 *3)	OMRON HEALTHCARE Co., Ltd.	EUT

\*1) Used for Low CH test

\*2) Used for Mid CH test

\*3) Used for High CH test

**UL Japan, Inc.**

**Ise EMC Lab.**

4383-326 Asama-cho, Ise-shi, Mie-ken 516-0021 JAPAN

Telephone : +81 596 24 8999

Facsimile : +81 596 24 8124

[Antenna Terminal conducted test]

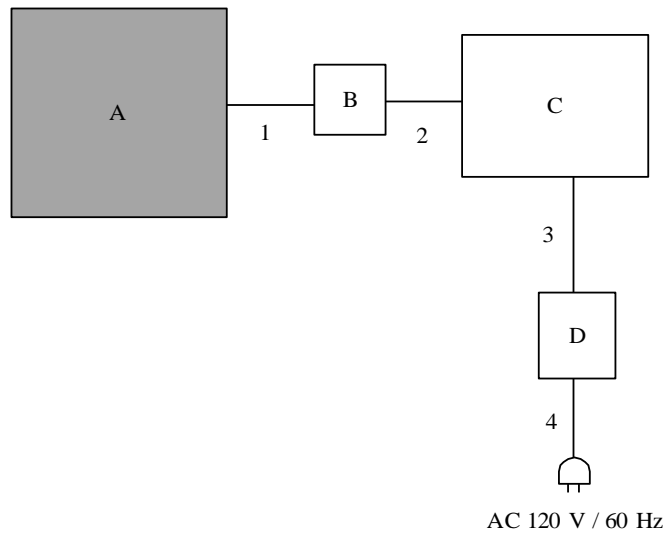

\* Cabling and setup(s) were taken into consideration and test data was taken under worse case conditions.

**Description of EUT and Support equipment**

No.	Item	Model number	Serial number	Manufacturer	Remarks
A	Scale	SC-150	202102F	OMRON HEALTHCARE Co., Ltd.	EUT
B	Jig	-	-	-	-
C	Laptop PC	P24T	10412714342	DELL	-
D	AC adapter	LA45NM140	0KXTTW	DELL	-

**List of cables used**

No.	Name	Length (m)	Shield		Remarks
			Cable	Connector	
1	Signal Cable	0.2	Unshielded	Unshielded	-
2	USB Cable	1.0	Shielded	Shielded	-
3	DC Cable	1.8	Unshielded	Unshielded	-
4	AC Cable	0.3	Unshielded	Unshielded	-

**UL Japan, Inc.**

**Ise EMC Lab.**

4383-326 Asama-cho, Ise-shi, Mie-ken 516-0021 JAPAN

Telephone : +81 596 24 8999

Facsimile : +81 596 24 8124

## **SECTION 5: Radiated Spurious Emission**

### **Test Procedure**

It was measured based on "8.5 and 8.6 of KDB 558074 D01 15.247 Meas Guidance v05r02".

[For below 1 GHz]

EUT was placed on a urethane platform of nominal size, 0.5 m by 1.0 m, raised 0.8 m above the conducting ground plane. The Radiated Electric Field Strength has been measured in a Semi Anechoic Chamber with a ground plane.

[For above 1 GHz]

EUT was placed on a urethane platform of nominal size, 0.5 m by 0.5 m, raised 1.5 m above the conducting ground plane. The Radiated Electric Field Strength has been measured in a Semi Anechoic Chamber with absorbent materials lined on a ground plane.

The height of the measuring antenna varied between 1 m and 4 m and EUT was rotated a full revolution in order to obtain the maximum value of the electric field strength.

Test antenna was aimed at the EUT for receiving the maximum signal and always kept within the illumination area of the 3 dB beamwidth of the antenna.

The measurements were performed for both vertical and horizontal antenna polarization with the Test Receiver, or the Spectrum Analyzer.

The measurements were made with the following detector function of the test receiver and the Spectrum analyzer (in linear mode).

The test was made with the detector (RBW/VBW) in the following table.

When using Spectrum analyzer, the test was made with adjusting span to zero by using peak hold.

### **Test Antennas are used as below;**

Frequency	30 MHz to 200 MHz	200 MHz to 1 GHz	Above 1 GHz
Antenna Type	Biconical	Logperiodic	Horn

In any 100 kHz bandwidth outside the restricted band in which the spread spectrum intentional radiator is operating, the radio frequency power that is produced by the intentional radiator confirmed 20 dB below that in the 100 kHz bandwidth within the band that contains the highest level of the desired power, based on a radiated measurement.

### **20 dBc was applied to the frequency over the limit of FCC 15.209 / Table 4 of RSS-Gen 8.9(ISED) and outside the restricted band of FCC15.205 / Table 6 of RSS-Gen 8.10 (ISED).**

Frequency	Below 1 GHz	Above 1 GHz		20 dBc
Instrument used	Test Receiver	Spectrum Analyzer		Spectrum Analyzer
Detector	QP	PK	AV *1)	PK
IF Bandwidth	BW 120 kHz	RBW: 1 MHz VBW: 3 MHz	<u>11.12.2.5.1</u> RBW: 1 MHz VBW: 3 MHz Detector: Power Averaging (RMS) Trace: 100 traces <u>11.12.2.5.2</u> The duty cycle was less than 98% for detected noise, a duty factor was added to the 11.12.2.5.1 results.	RBW: 100 kHz VBW: 300 kHz

\*1) Average Power Measurement was performed based on ANSI C63.10-2013.

**UL Japan, Inc.**

**Ise EMC Lab.**

4383-326 Asama-cho, Ise-shi, Mie-ken 516-0021 JAPAN

Telephone : +81 596 24 8999

Facsimile : +81 596 24 8124

**Figure 2: Test Setup**

Below 1 GHz

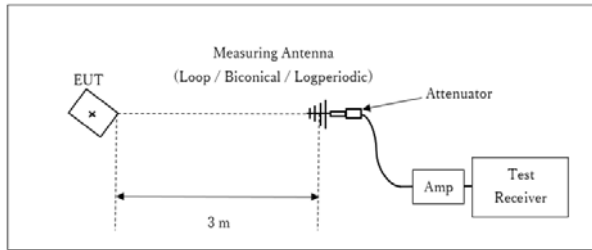

× : Center of turn table

Test Distance: 3 m

1 GHz - 10 GHz

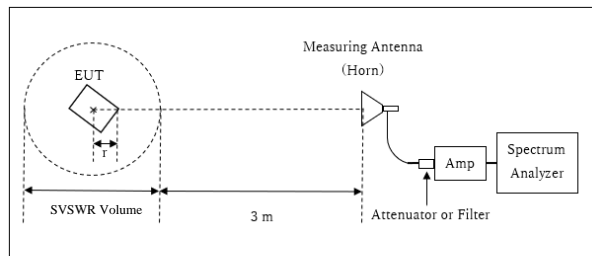

r : Radius of an outer periphery of EUT  
 × : Center of turn table

Distance Factor:  $20 \times \log(3.9 \text{ m} / 3.0 \text{ m}) = 2.28 \text{ dB}$   
 \* Test Distance:  $(3 + \text{SVSWR Volume} / 2) - r = 3.9 \text{ m}$

SVSWR Volume : 2.0 m  
 (SVSWR Volume has been calibrated based on CISPR 16-1-4.)  
 r = 0.1 m

10 GHz – 26.5 GHz

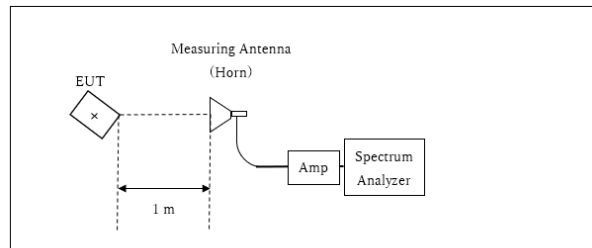

× : Center of turn table

Distance Factor:  $20 \times \log(1.0 \text{ m} / 3.0 \text{ m}) = -9.5 \text{ dB}$   
 \*Test Distance: 1 m

- The carrier level and noise levels were confirmed at each position of X, Y and Z axes of EUT to see the position of maximum noise, and the test was made at the position that has the maximum noise.

The test results and limit are rounded off to one decimal place, so some differences might be observed.

**Measurement range** : 30 MHz - 26.5 GHz  
**Test data** : APPENDIX  
**Test result** : Pass

## **SECTION 6: Antenna Terminal Conducted Tests**

### **Test Procedure**

The tests were made with below setting connected to the antenna port.

Test	Span	RBW	VBW	Sweep time	Detector	Trace	Instrument used
6dB Bandwidth	3 MHz	100 kHz	300 kHz	Auto	Peak	Max Hold	Spectrum Analyzer
99% Occupied Bandwidth *1)	Enough width to display emission skirts	1 to 5 % of OBW	Three times of RBW	Auto	Peak	Max Hold	Spectrum Analyzer
Maximum Peak Output Power	-	-	-	Auto	Peak/Average *2)	-	Power Meter (Sensor: 50 MHz BW)
Peak Power Density	1.5 times the 6dB Bandwidth	3 kHz	10 kHz	Auto	Peak	Max Hold	Spectrum Analyzer *3)
Conducted Spurious Emission *4) *5)	9kHz to 150kHz	200 Hz	620 Hz	Auto	Peak	Max Hold	Spectrum Analyzer
	150kHz to 30MHz	9.1 kHz	27 kHz				

\*1) Peak hold was applied as Worst-case measurement.  
\*2) Reference data  
\*3) Section 11.10.2 Method PKPSD (peak PSD) of "ANSI C63.10-2013".  
\*4) In the frequency range below 30MHz, RBW was narrowed to separate the noise contents.  
Then, wide-band noise near the limit was checked separately, however the noise was not detected as shown in the chart.  
(9 kHz - 150 kHz: RBW = 200 Hz, 150 kHz - 30 MHz: RBW = 9.1 kHz)  
\*5) The limits in CFR 47, Part 15, Subpart C, paragraph 15.209(a), are identical to those in RSS-Gen section 8.9, Table 6, since the measurements are performed in terms of magnetic field strength and converted to electric field strength levels (as reported in the table) using the free space impedance of 377 Ohms. For example, the measurement at frequency 9 kHz resulted in a level of 45.5 dBuV/m, which is equivalent to  $45.5 - 51.5 = -6.0$  dBuA/m, which has the same margin, 3 dB, to the corresponding RSS-Gen Table 6 limit as it has to 15.209(a) limit.

The test results and limit are rounded off to two decimals place, so some differences might be observed.  
The equipment and cables were not used for factor 0 dB of the data sheets.

**Test data : APPENDIX**  
**Test result : Pass**

## APPENDIX 1: Test data

### 6 dB Bandwidth and 99 % Occupied Bandwidth

Report No. 13716647H  
Test place Ise EMC Lab. No.3 Measurement Room  
Date March 18, 2021  
Temperature / Humidity 23 deg. C / 34 % RH  
Engineer Yuta Moriya  
Mode Tx BT LE

Mode	Frequency [MHz]	99% Occupied Bandwidth [kHz]	6dB Bandwidth [MHz]	Limit for 6dB Bandwidth [MHz]
BT LE	2402	1058.2	0.671	> 0.5000
	2440	1060.4	0.689	> 0.5000
	2480	1052.1	0.666	> 0.5000

## 99% Occupied Bandwidth

### BT LE

#### 2402 MHz

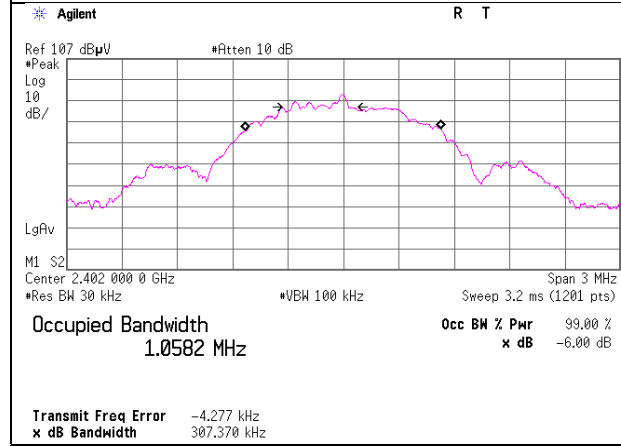

#### 2440 MHz

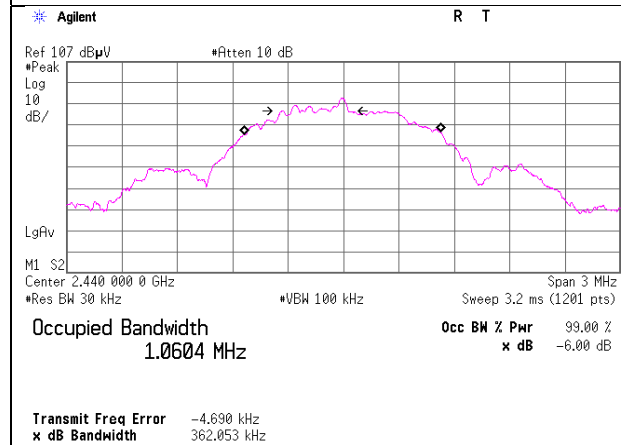

#### 2480 MHz

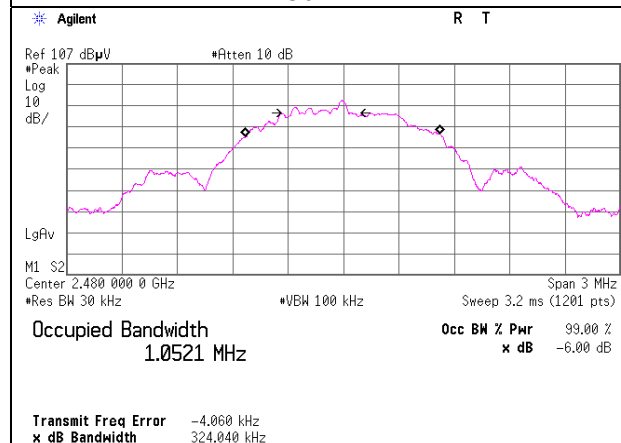

## 6dB Bandwidth

### BT LE

#### 2402 MHz

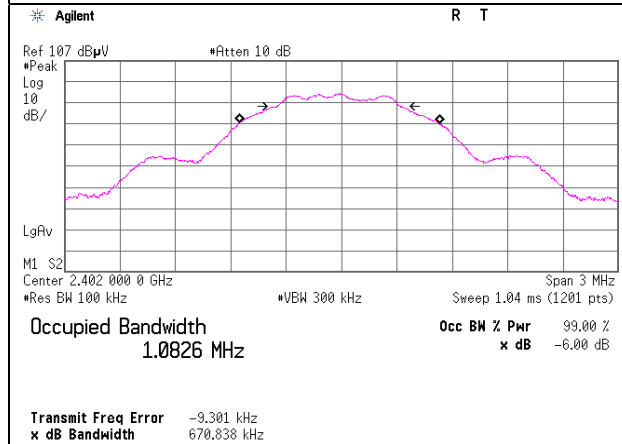

#### 2440 MHz

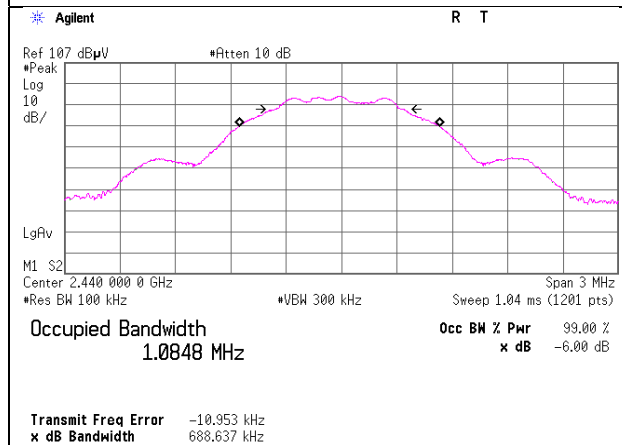

#### 2480 MHz

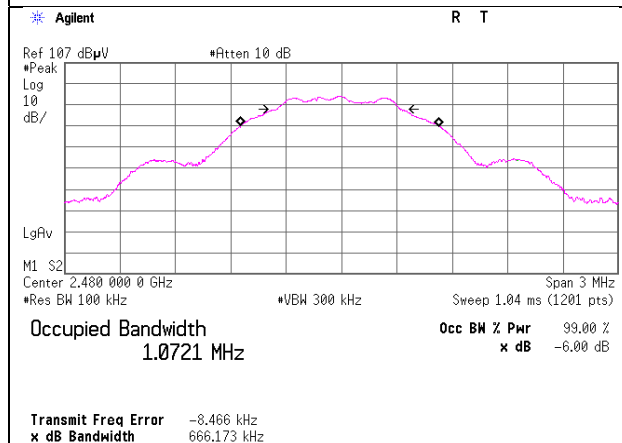



## Maximum Peak Output Power

Report No. 13716647H  
 Test place Ise EMC Lab. No.3 Measurement Room  
 Date March 18, 2021  
 Temperature / Humidity 23 deg. C / 34 % RH  
 Engineer Yuta Moriya  
 Mode Tx BT LE

Freq. [MHz]	Reading [dBm]	Cable Loss [dB]	Atten. Loss [dB]	Conducted Power					e.i.r.p. for RSS-247					
				Result		Limit		Margin [dB]	Antenna Gain [dBi]	Result		Limit		Margin [dB]
				[dBm]	[mW]	[dBm]	[mW]			[dBm]	[mW]	[dBm]	[mW]	
2402	-15.27	1.33	10.02	-3.92	0.41	30.00	1000	33.92	-2.37	-6.29	0.23	36.02	4000	42.31
2440	-15.55	1.34	10.02	-4.19	0.38	30.00	1000	34.19	-2.37	-6.56	0.22	36.02	4000	42.58
2480	-15.59	1.35	10.02	-4.22	0.38	30.00	1000	34.22	-2.37	-6.59	0.22	36.02	4000	42.61

Sample Calculation:

Result = Reading + Cable Loss (including the cable(s) customer supplied) + Attenuator Loss

e.i.r.p. Result = Conducted Power Result + Antenna Gain

\*The equipment and cables were not used for factor 0 dB of the data sheets.

**UL Japan, Inc.**

**Ise EMC Lab.**

4383-326 Asama-cho, Ise-shi, Mie-ken 516-0021 JAPAN

Telephone : +81 596 24 8999

Facsimile : +81 596 24 8124

**Average Output Power**  
**(Reference data for RF Exposure)**

Report No. 13716647H  
Test place Ise EMC Lab. No.3 Measurement Room  
Date March 18, 2021  
Temperature / Humidity 23 deg. C / 34 % RH  
Engineer Yuta Moriya  
Mode Tx BT LE

Freq. [MHz]	Reading [dBm]	Cable Loss [dB]	Atten. Loss [dB]	Result (Time average)		Duty factor [dB]	Result (Burst power average)	
				[dBm]	[mW]		[dBm]	[mW]
2402	-17.62	1.33	10.02	-6.27	0.24	1.68	-4.59	0.35
2440	-18.00	1.34	10.02	-6.64	0.22	1.68	-4.96	0.32
2480	-18.90	1.35	10.02	-7.53	0.18	1.68	-5.85	0.26

Sample Calculation:

Result (Time average) = Reading + Cable Loss (including the cable(s) customer supplied) + Attenuator Loss

Result (Burst power average) = Time average + Duty factor

### Burst rate confirmation

Report No. 13716647H  
 Test place Ise EMC Lab. No.3 Measurement Room  
 Date March 18, 2021  
 Temperature / Humidity 23 deg. C / 34 % RH  
 Engineer Yuta Moriya  
 Mode Tx BT LE

#### BT LE

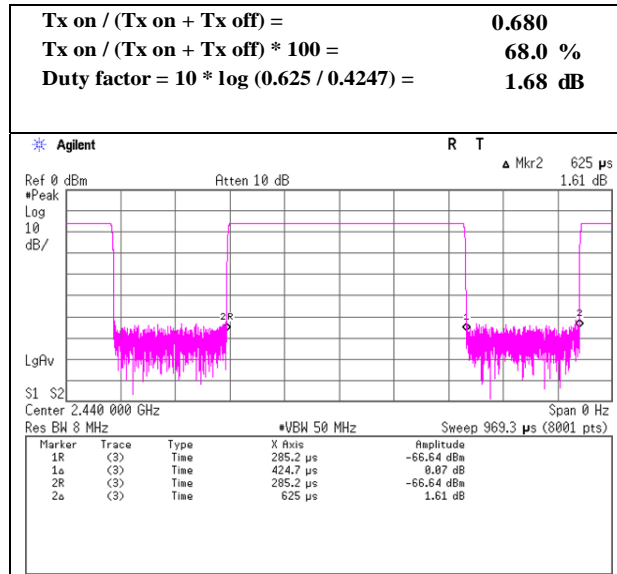

\* Since the burst rate is not different between the channels, the data has been obtained on the representative channel.

## Radiated Spurious Emission

Report No. 13716647H  
Test place Ise EMC Lab.  
Semi Anechoic Chamber No.3  
Date March 21, 2021  
Temperature / Humidity 20 deg. C / 30 % RH  
Engineer Kiyoshiro Okazaki  
(30 MHz - 26.5 GHz)  
Mode Tx BT LE 2402 MHz

Polarity	Frequency [MHz]	Detector	Reading [dBuV]	Ant.Fac. [dB/m]	Loss [dB]	Gain [dB]	Duty Factor [dB]	Result [dBuV/m]	Limit [dBuV/m]	Margin [dB]	Remark
Hori.	32.053	QP	22.5	17.7	7.2	32.2	-	15.2	40.0	24.8	
Hori.	105.480	QP	21.7	10.9	8.2	32.2	-	8.6	43.5	34.9	
Hori.	121.122	QP	22.5	12.9	8.4	32.2	-	11.6	43.5	31.9	
Hori.	142.539	QP	22.2	14.8	8.7	32.2	-	13.5	43.5	30.0	
Hori.	190.466	QP	21.9	16.6	9.1	32.1	-	15.5	43.5	28.0	
Hori.	590.418	QP	21.5	18.9	12.0	32.0	-	20.4	46.0	25.6	
Hori.	2390.000	PK	46.2	27.5	5.4	32.6	-	46.6	73.9	27.3	
Hori.	4804.000	PK	40.7	31.7	7.6	31.7	-	48.4	73.9	25.6	Floor noise
Hori.	7206.000	PK	42.6	36.1	9.1	32.6	-	55.1	73.9	18.8	Floor noise
Hori.	9608.000	PK	42.8	38.7	9.5	33.0	-	58.0	73.9	15.9	Floor noise
Hori.	2390.000	AV	34.4	27.5	5.4	32.6	1.7	36.4	53.9	17.5	*1)
Hori.	4804.000	AV	32.5	31.7	7.6	31.7	-	40.1	53.9	13.8	Floor noise
Hori.	7206.000	AV	30.2	36.1	9.1	32.6	-	42.8	53.9	11.1	Floor noise
Hori.	9608.000	AV	29.0	38.7	9.5	33.0	-	44.2	53.9	9.7	Floor noise
Vert.	32.081	QP	22.0	17.7	7.2	32.2	-	14.7	40.0	25.4	
Vert.	105.723	QP	22.5	10.9	8.2	32.2	-	9.4	43.5	34.1	
Vert.	121.183	QP	21.5	12.9	8.4	32.2	-	10.7	43.5	32.9	
Vert.	142.283	QP	22.5	14.8	8.6	32.2	-	13.8	43.5	29.7	
Vert.	190.278	QP	22.3	16.6	9.1	32.1	-	15.9	43.5	27.6	
Vert.	590.418	QP	22.4	18.9	12.0	32.0	-	21.3	46.0	24.7	
Vert.	2390.000	PK	45.2	27.5	5.4	32.6	-	45.5	73.9	28.4	
Vert.	4804.000	PK	41.4	31.7	7.6	31.7	-	49.0	73.9	24.9	Floor noise
Vert.	7206.000	PK	42.4	36.1	9.1	32.6	-	54.9	73.9	19.0	Floor noise
Vert.	9608.000	PK	42.5	38.7	9.5	33.0	-	57.7	73.9	16.3	Floor noise
Vert.	2390.000	AV	34.4	27.5	5.4	32.6	1.7	36.5	53.9	17.4	*1)
Vert.	4804.000	AV	32.5	31.7	7.6	31.7	-	40.1	53.9	13.8	Floor noise
Vert.	7206.000	AV	30.2	36.1	9.1	32.6	-	42.8	53.9	11.1	Floor noise
Vert.	9608.000	AV	29.1	38.7	9.5	33.0	-	44.3	53.9	9.6	Floor noise

Result = Reading + Ant Factor + Loss (Cable+Attenuator+Filter+Distance factor(above 1 GHz)) - Gain(Amplifier) + Duty factor

\*Other frequency noises omitted in this report were not seen or had enough margin (more than 20 dB).

Distance factor: 1 GHz - 10 GHz  $20\log(3.9\text{ m} / 3.0\text{ m}) = 2.28\text{ dB}$

10 GHz - 26.5 GHz  $20\log(1.0\text{ m} / 3.0\text{ m}) = -9.5\text{ dB}$

\*1) Not Out of Band emission(Leakage Power)

### 20dBc Data Sheet

Polarity	Frequency [MHz]	Detector	Reading [dBuV]	Ant Factor [dB/m]	Loss [dB]	Gain [dB]	Result [dBuV/m]	Limit [dBuV/m]	Margin [dB]	Remark
Hori.	2402.000	PK	89.4	27.5	5.4	32.6	89.8	-	-	Carrier
Hori.	2400.000	PK	46.2	27.5	5.4	32.6	46.5	69.8	23.2	
Vert.	2402.000	PK	88.3	27.5	5.4	32.6	88.6	-	-	Carrier
Vert.	2400.000	PK	45.4	27.5	5.4	32.6	45.7	68.6	22.9	

Result = Reading + Ant Factor + Loss (Cable+Attenuator+Filter+Distance factor(above 1 GHz)) - Gain(Amplifier)

Distance factor: 1 GHz - 10 GHz  $20\log(3.9\text{ m} / 3.0\text{ m}) = 2.28\text{ dB}$

10 GHz - 26.5 GHz  $20\log(1.0\text{ m} / 3.0\text{ m}) = -9.5\text{ dB}$

**Radiated Spurious Emission**  
**(Reference Plot for band-edge)**

Report No. 13716647H  
Test place Ise EMC Lab.  
Semi Anechoic Chamber No.3  
Date March 21, 2021  
Temperature / Humidity 20 deg. C / 30 % RH  
Engineer Kiyoshiro Okazaki  
(1 GHz - 10 GHz)  
Mode Tx BT LE 2402 MHz

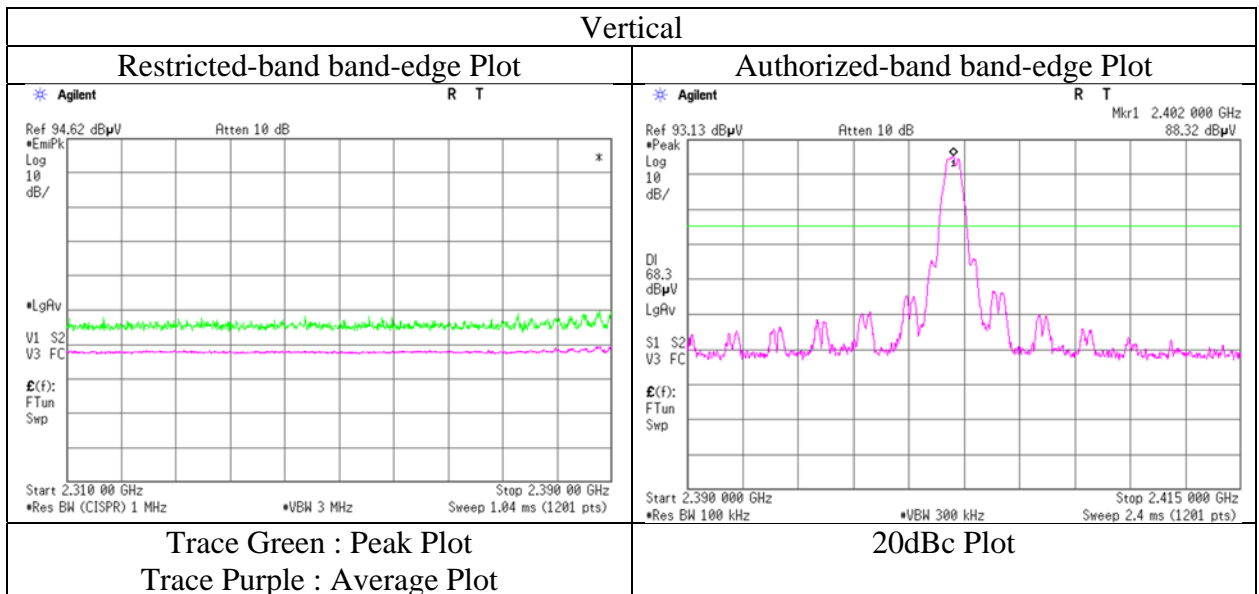
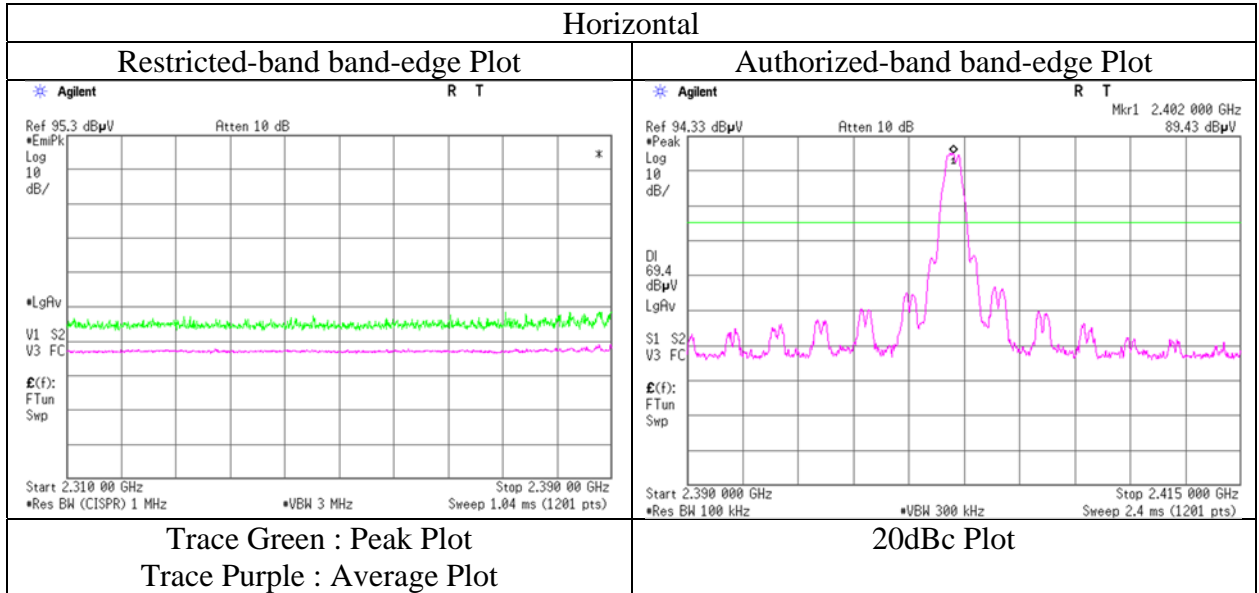

\* The measurement was conducted for a sufficiently long enough time to detect any possible spurious emissions. Final result of restricted band edge was shown in tabular data.

## Radiated Spurious Emission

Report No. 13716647H  
Test place Ise EMC Lab.  
Semi Anechoic Chamber No.3  
Date March 21, 2021  
Temperature / Humidity 20 deg. C / 30 % RH  
Engineer Kiyoshiro Okazaki  
(30 MHz - 26.5 GHz)  
Mode Tx BT LE 2440 MHz

Polarity	Frequency [MHz]	Detector	Reading [dBuV]	Ant.Fac. [dB/m]	Loss [dB]	Gain [dB]	Duty Factor [dB]	Result [dBuV/m]	Limit [dBuV/m]	Margin [dB]	Remark
Hori.	56.860	QP	23.2	8.6	7.6	32.2	-	7.2	40.0	32.8	
Hori.	66.723	QP	24.1	6.6	7.7	32.2	-	6.2	40.0	33.8	
Hori.	94.609	QP	22.3	9.3	8.1	32.2	-	7.5	43.5	36.0	
Hori.	102.778	QP	21.7	10.5	8.2	32.2	-	8.2	43.5	35.3	
Hori.	105.815	QP	22.4	10.9	8.2	32.2	-	9.4	43.5	34.1	
Hori.	590.527	QP	22.2	18.9	12.0	32.0	-	21.1	46.0	24.9	
Hori.	4880.000	PK	40.3	31.5	7.6	31.6	-	47.7	73.9	26.2	Floor noise
Hori.	7320.000	PK	41.2	36.2	9.1	32.7	-	53.9	73.9	20.0	Floor noise
Hori.	9760.000	PK	41.3	39.0	9.6	33.1	-	56.8	73.9	17.2	Floor noise
Hori.	4880.000	AV	31.0	31.5	7.6	31.6	-	38.4	53.9	15.5	Floor noise
Hori.	7320.000	AV	30.1	36.2	9.1	32.7	-	42.7	53.9	11.2	Floor noise
Hori.	9760.000	AV	30.0	39.0	9.6	33.1	-	45.5	53.9	8.4	Floor noise
Vert.	56.792	QP	23.5	8.7	7.6	32.2	-	7.5	40.0	32.5	
Vert.	66.723	QP	24.5	6.6	7.7	32.2	-	6.6	40.0	33.4	
Vert.	94.609	QP	22.5	9.3	8.1	32.2	-	7.7	43.5	35.8	
Vert.	102.778	QP	21.5	10.5	8.2	32.2	-	8.0	43.5	35.5	
Vert.	105.815	QP	22.3	10.9	8.2	32.2	-	9.3	43.5	34.2	
Vert.	590.527	QP	22.3	18.9	12.0	32.0	-	21.2	46.0	24.8	
Vert.	4880.000	PK	40.3	31.5	7.6	31.6	-	47.8	73.9	26.2	Floor noise
Vert.	7320.000	PK	41.3	36.2	9.1	32.7	-	53.9	73.9	20.0	Floor noise
Vert.	9760.000	PK	41.8	39.0	9.6	33.1	-	57.2	73.9	16.7	Floor noise
Vert.	4880.000	AV	31.3	31.5	7.6	31.6	-	38.7	53.9	15.2	Floor noise
Vert.	7320.000	AV	30.2	36.2	9.1	32.7	-	42.8	53.9	11.1	Floor noise
Vert.	9760.000	AV	29.9	39.0	9.6	33.1	-	45.4	53.9	8.5	Floor noise

Result = Reading + Ant Factor + Loss (Cable+Attenuator+Filter+Distance factor(above 1 GHz)) - Gain(Amplifier)

\*Other frequency noises omitted in this report were not seen or had enough margin (more than 20 dB).

Distance factor: 1 GHz - 10 GHz  $20\log(3.9\text{ m} / 3.0\text{ m}) = 2.28\text{ dB}$   
10 GHz - 26.5 GHz  $20\log(1.0\text{ m} / 3.0\text{ m}) = -9.5\text{ dB}$

## Radiated Spurious Emission

Report No. 13716647H  
Test place Ise EMC Lab.  
Semi Anechoic Chamber No.3  
Date March 21, 2021  
Temperature / Humidity 20 deg. C / 30 % RH  
Engineer Kiyoshiro Okazaki  
(30 MHz - 26.5 GHz)  
Mode Tx BT LE 2480 MHz

Polarity	Frequency [MHz]	Detector	Reading [dBuV]	Ant.Fac. [dB/m]	Loss [dB]	Gain [dB]	Duty Factor [dB]	Result [dBuV/m]	Limit [dBuV/m]	Margin [dB]	Remark
Hori.	34.630	QP	22.3	16.8	7.2	32.2	-	14.1	40.0	25.9	
Hori.	104.486	QP	21.3	10.7	8.2	32.2	-	8.0	43.5	35.5	
Hori.	122.651	QP	22.6	13.1	8.4	32.2	-	11.9	43.5	31.6	
Hori.	151.729	QP	22.5	15.3	8.8	32.1	-	14.4	43.5	29.1	
Hori.	187.420	QP	22.0	16.5	9.1	32.1	-	15.5	43.5	28.0	
Hori.	468.810	QP	22.5	16.9	11.2	32.0	-	18.6	46.0	27.4	
Hori.	2483.500	PK	45.8	27.3	5.5	32.5	-	46.1	73.9	27.8	
Hori.	4960.000	PK	40.4	31.5	7.6	31.6	-	47.8	73.9	26.1	Floor noise
Hori.	7440.000	PK	41.0	36.3	9.1	32.7	-	53.7	73.9	20.3	Floor noise
Hori.	9920.000	PK	41.4	38.8	9.6	33.2	-	56.6	73.9	17.3	Floor noise
Hori.	2483.500	AV	34.1	27.3	5.5	32.5	1.7	36.0	53.9	17.9	*1)
Hori.	4960.000	AV	31.4	31.5	7.6	31.6	-	38.8	53.9	15.1	Floor noise
Hori.	7440.000	AV	30.3	36.3	9.1	32.7	-	42.9	53.9	11.0	Floor noise
Hori.	9920.000	AV	30.0	38.8	9.6	33.2	-	45.2	53.9	8.7	Floor noise
Vert.	34.630	QP	22.1	16.8	7.2	32.2	-	13.9	40.0	26.1	
Vert.	104.486	QP	22.4	10.7	8.2	32.2	-	9.1	43.5	34.4	
Vert.	122.651	QP	21.4	13.1	8.4	32.2	-	10.7	43.5	32.8	
Vert.	151.729	QP	22.7	15.3	8.8	32.1	-	14.6	43.5	28.9	
Vert.	187.420	QP	22.1	16.5	9.1	32.1	-	15.6	43.5	27.9	
Vert.	468.810	QP	22.3	16.9	11.2	32.0	-	18.4	46.0	27.6	
Vert.	2483.500	PK	45.2	27.3	5.5	32.5	-	45.5	73.9	28.4	
Vert.	4960.000	PK	40.2	31.5	7.6	31.6	-	47.7	73.9	26.2	Floor noise
Vert.	7440.000	PK	41.2	36.3	9.1	32.7	-	53.8	73.9	20.1	Floor noise
Vert.	9920.000	PK	41.7	38.8	9.6	33.2	-	56.9	73.9	17.0	Floor noise
Vert.	2483.500	AV	34.4	27.3	5.5	32.5	1.7	36.4	53.9	17.5	*1)
Vert.	4960.000	AV	31.0	31.5	7.6	31.6	-	38.5	53.9	15.4	Floor noise
Vert.	7440.000	AV	30.9	36.3	9.1	32.7	-	43.5	53.9	10.4	Floor noise
Vert.	9920.000	AV	30.0	38.8	9.6	33.2	-	45.3	53.9	8.6	Floor noise

Result = Reading + Ant Factor + Loss (Cable+Attenuator+Filter+Distance factor(above 1 GHz)) - Gain(Amplifier) + Duty factor

\*Other frequency noises omitted in this report were not seen or had enough margin (more than 20 dB).

Distance factor: 1 GHz - 10 GHz 20log(3.9 m / 3.0 m) = 2.28 dB  
10 GHz - 26.5 GHz 20log(1.0 m / 3.0 m) = -9.5 dB

\*1) Not Out of Band emission(Leakage Power)

**Radiated Spurious Emission**  
**(Reference Plot for band-edge)**

Report No. 13716647H  
Test place Ise EMC Lab.  
Semi Anechoic Chamber No.3  
Date March 21, 2021  
Temperature / Humidity 20 deg. C / 30 % RH  
Engineer Kiyoshiro Okazaki  
(1 GHz - 10 GHz)  
Mode Tx BT LE 2480 MHz

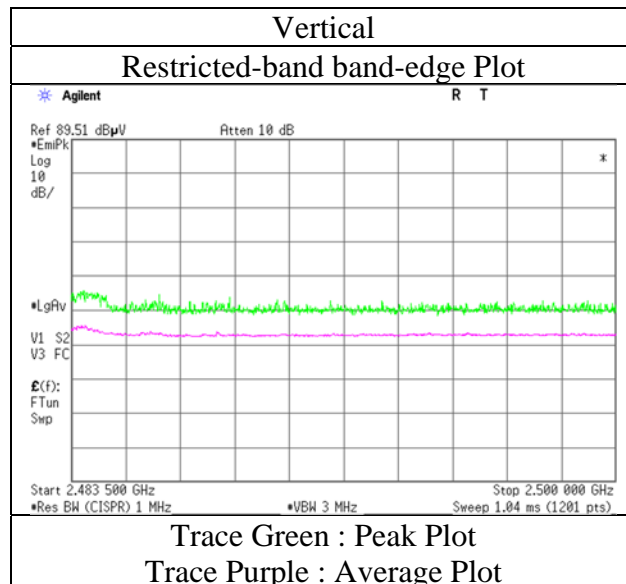
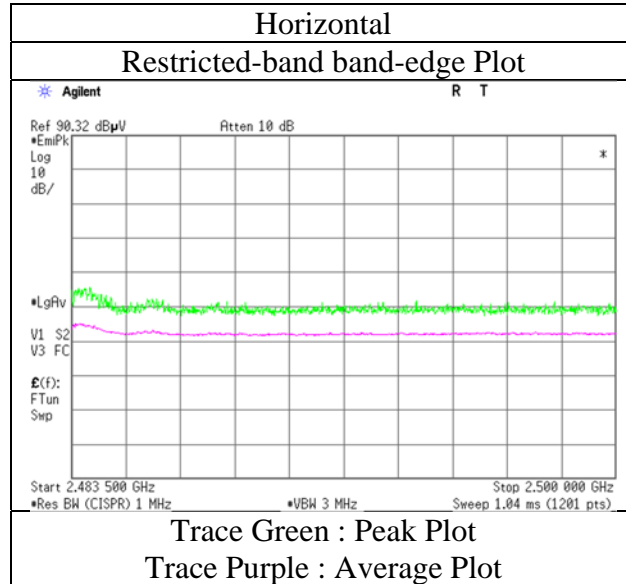

\* The measurement was conducted for a sufficiently long enough time to detect any possible spurious emissions. Final result of restricted band edge was shown in tabular data.



**Radiated Spurious Emission**  
**(Plot data, Worst case)**

Report No.	13716647H
Test place	Ise EMC Lab.
Semi Anechoic Chamber	No.3
Date	March 21, 2021
Temperature / Humidity	20 deg. C / 30 % RH
Engineer	Kiyoshiro Okazaki (30 MHz – 26.5 GHz)
Mode	Tx BT LE 2402 MHz

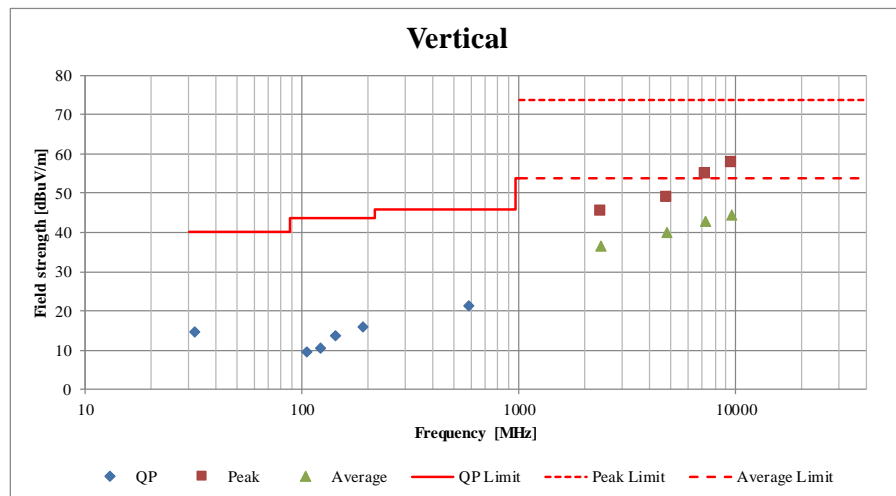
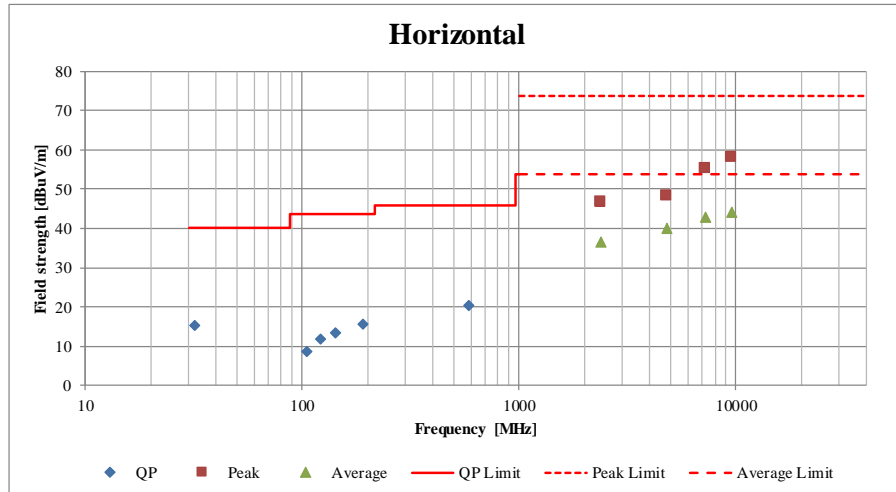

\*These plots data contains sufficient number to show the trend of characteristic features for EUT.

## Conducted Spurious Emission

Report No. 13716647H  
 Test place Ise EMC Lab. No.3 Measurement Room  
 Date March 18, 2021  
 Temperature / Humidity 23 deg. C / 34 % RH  
 Engineer Yuta Moriya  
 Mode Tx BT LE 2402 MHz

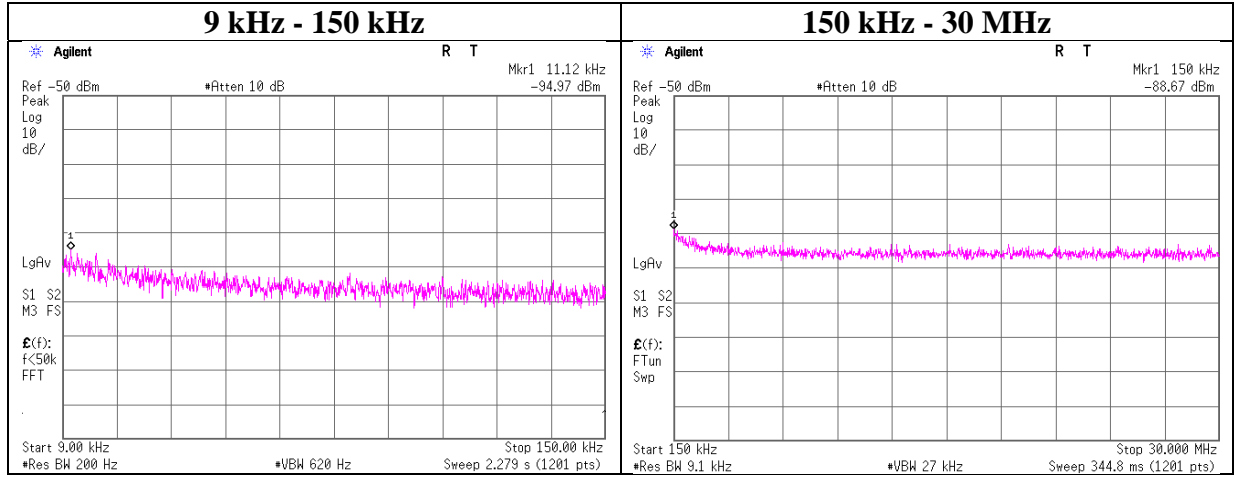

Frequency [kHz]	Reading [dBm]	Cable Loss [dB]	Attenuator Loss [dB]	Antenna Gain* [dBi]	N (Number of Output)	EIRP [dBm]	Distance [m]	Ground bounce [dB]	E (field strength) [dBuV/m]	Limit [dBuV/m]	Margin [dB]	Remark
11.12	-94.97	1.33	10.02	2.0	1	-81.6	300	6.0	-20.4	46.6	67.0	
150.00	-88.67	1.33	10.02	2.0	1	-75.3	300	6.0	-14.1	24.0	38.1	

$$E \text{ [dBuV/m]} = \text{EIRP [dBm]} - 20 \log(\text{Distance [m]}) + \text{Ground bounce [dB]} + 104.8 \text{ [dBuV/m]}$$

$$\text{EIRP [dBm]} = \text{Reading [dBm]} + \text{Cable loss [dB]} + \text{Attenuator Loss [dB]} + \text{Antenna gain [dBi]} + 10 * \log(N)$$

N: Number of output

\*2.0 dBi was applied to the test result based on ANSI C63.10 since antenna gain was less than 2.0 dBi.

**UL Japan, Inc.**

**Ise EMC Lab.**

4383-326 Asama-cho, Ise-shi, Mie-ken 516-0021 JAPAN

Telephone : +81 596 24 8999

Facsimile : +81 596 24 8124

## Conducted Spurious Emission

Report No. 13716647H  
 Test place Ise EMC Lab. No.3 Measurement Room  
 Date March 18, 2021  
 Temperature / Humidity 23 deg. C / 34 % RH  
 Engineer Yuta Moriya  
 Mode Tx BT LE 2440 MHz

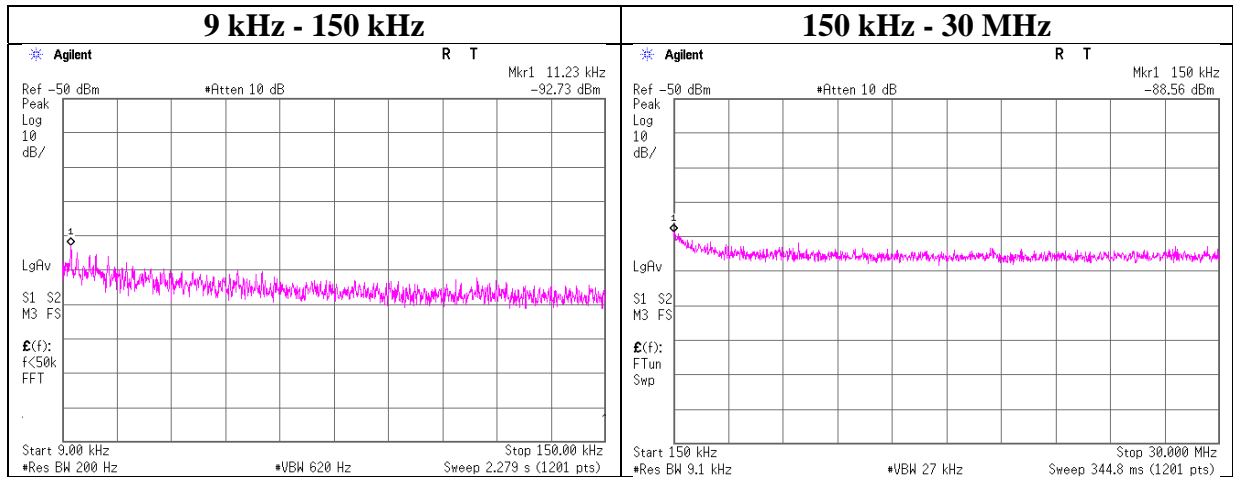

Frequency [kHz]	Reading [dBm]	Cable Loss [dB]	Attenuator Loss [dB]	Antenna Gain* [dBi]	N (Number of Output)	EIRP [dBm]	Distance [m]	Ground bounce [dB]	E (field strength) [dBuV/m]	Limit [dBuV/m]	Margin [dB]	Remark
11.23	-92.73	1.33	10.02	2.0	1	-79.4	300	6.0	-18.1	46.5	64.6	
150.00	-88.56	1.33	10.02	2.0	1	-75.2	300	6.0	-14.0	24.0	38.0	

$$E \text{ [dBuV/m]} = \text{EIRP [dBm]} - 20 \log(\text{Distance [m]}) + \text{Ground bounce [dB]} + 104.8 \text{ [dBuV/m]}$$

$$\text{EIRP [dBm]} = \text{Reading [dBm]} + \text{Cable loss [dB]} + \text{Attenuator Loss [dB]} + \text{Antenna gain [dBi]} + 10 * \log(N)$$

N: Number of output

\*2.0 dBi was applied to the test result based on ANSI C63.10 since antenna gain was less than 2.0 dBi.

## Conducted Spurious Emission

Report No. 13716647H  
 Test place Ise EMC Lab. No.3 Measurement Room  
 Date March 18, 2021  
 Temperature / Humidity 23 deg. C / 34 % RH  
 Engineer Yuta Moriya  
 Mode Tx BT LE 2480 MHz

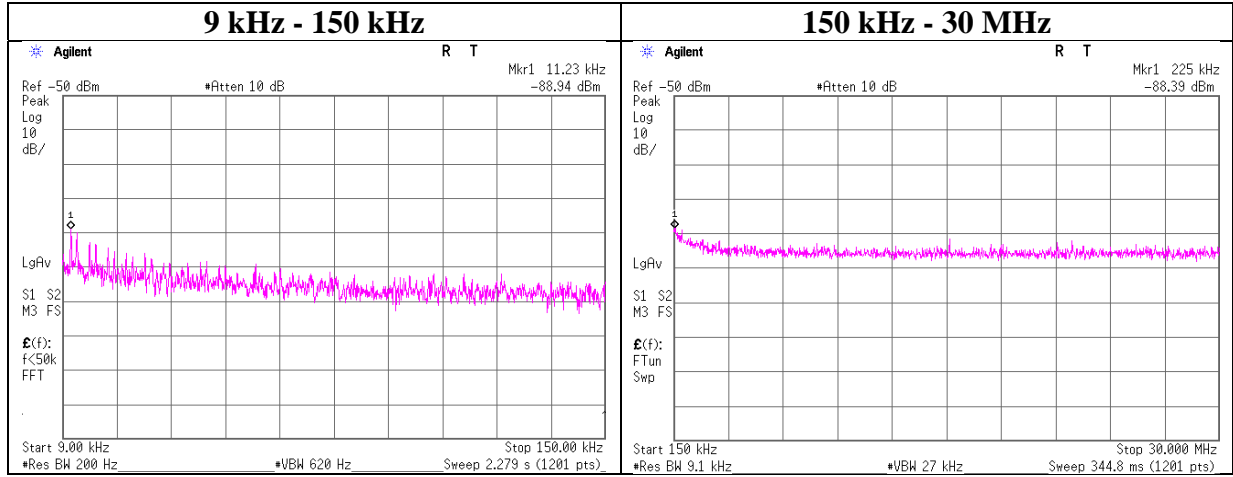

Frequency [kHz]	Reading [dBm]	Cable Loss [dB]	Attenuator Loss [dB]	Antenna Gain* [dBi]	N (Number of Output)	EIRP [dBm]	Distance [m]	Ground bounce [dB]	E (field strength) [dBuV/m]	Limit [dBuV/m]	Margin [dB]	Remark
11.23	-88.94	1.33	10.02	2.0	1	-75.6	300	6.0	-14.3	46.5	60.8	
225.00	-88.39	1.33	10.02	2.0	1	-75.0	300	6.0	-13.8	20.5	34.3	

$$E \text{ [dBuV/m]} = \text{EIRP [dBm]} - 20 \log(\text{Distance [m]}) + \text{Ground bounce [dB]} + 104.8 \text{ [dBuV/m]}$$

$$\text{EIRP [dBm]} = \text{Reading [dBm]} + \text{Cable loss [dB]} + \text{Attenuator Loss [dB]} + \text{Antenna gain [dBi]} + 10 * \log(N)$$

N: Number of output

\*2.0 dBi was applied to the test result based on ANSI C63.10 since antenna gain was less than 2.0 dBi.

### Power Density

Report No. 13716647H  
Test place Ise EMC Lab. No.3 Measurement Room  
Date March 30, 2021  
Temperature / Humidity 23 deg. C / 36 % RH  
Engineer Kiyoshiro Okazaki  
Mode Tx BT LE

Freq. [MHz]	Reading [dBm]	Cable Loss [dB]	Atten. Loss [dB]	Result [dBm]	Limit [dBm]	Margin [dB]
2402	-31.74	1.33	10.02	-20.39	8.00	28.39
2440	-31.80	1.34	10.02	-20.44	8.00	28.44
2480	-32.14	1.35	10.02	-20.77	8.00	28.77

Sample Calculation:

Result = Reading + Cable Loss (including the cable(s) customer supplied) + Attenuator Loss

\*The equipment and cables were not used for factor 0 dB of the data sheets.

**Power Density**

**BT LE**

**2402 MHz**

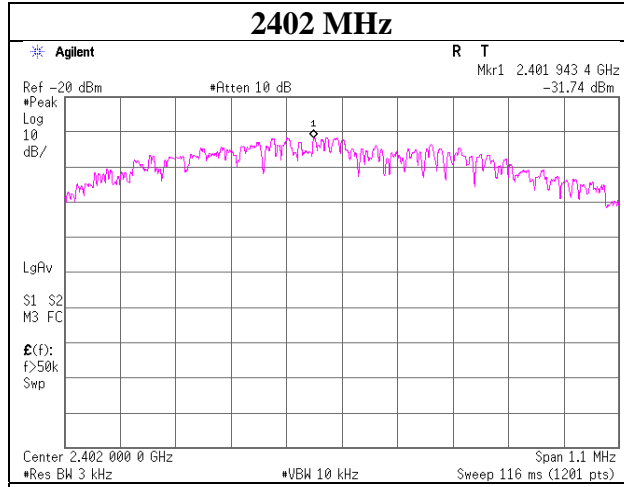

**2440 MHz**

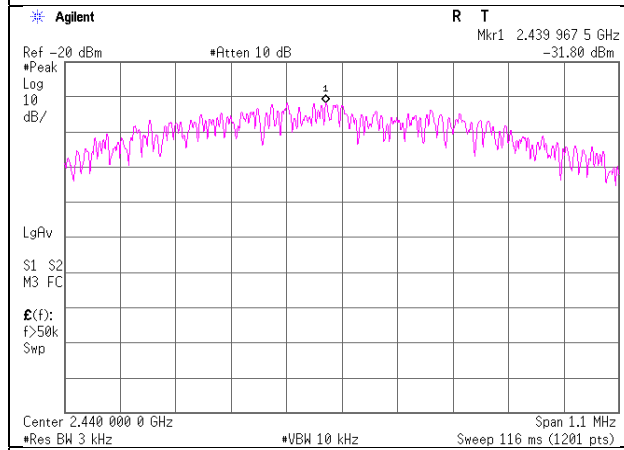

**2480 MHz**

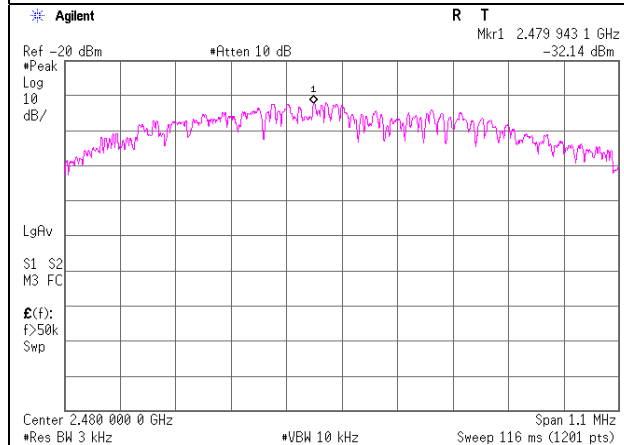

## **APPENDIX 2: Test instruments**

### **Test equipment**

Test Item	Local ID	LIMS ID	Description	Manufacturer	Model	Serial	Last Calibration Date	Cal Int
RE	MAEC-03	142008	Semi Anechoic Chamber(NSA)	TDK	Semi Anechoic Chamber 3m	DA-10005	05/22/2020	24
RE	MOS-13	141554	Thermo-Hygrometer	CUSTOM	CTH-180	1301	01/15/2021	12
RE	MMM-08	141532	DIGITAL HiTESTER	HIOKI	3805	51201197	01/07/2021	12
RE	MJM-16	142183	Measure	KOMELON	KMC-36	-	-	-
RE	COTS-MEMI-02	178648	EMI measurement program	TSJ (Techno Science Japan)	TEPTO-DV	-	-	-
RE	MAEC-03-SVSWR	142013	Semi Anechoic Chamber(SVSWR)	TDK	Semi Anechoic Chamber 3m	DA-10005	04/08/2020	12
RE	MAT-95	142314	Attenuator	Pasternack	PE7390-6	D/C 1504	06/17/2020	12
RE	MBA-03	141424	Biconical Antenna	Schwarzbeck	BBA9106	1915	08/13/2020	12
RE	MCC-51	141323	Coaxial cable	UL Japan	-	-	07/06/2020	12
RE	MLA-22	141266	Logperiodic Antenna (200-1000MHz)	Schwarzbeck	VUSLP9111B	911B-191	08/13/2020	12
RE	MPA-13	141582	Pre Amplifier	SONOMA INSTRUMENT	11/5/1900	260834	02/03/2021	12
RE	MTR-03	141942	Test Receiver	Rohde & Schwarz	ESCI	100300	08/18/2020	12
RE	MHA-20	141507	Horn Antenna 1-18GHz	Schwarzbeck	BBHA9120D	258	10/31/2020	12
RE	MPA-11	141580	MicroWave System Amplifier	AGILENT	83017A	MY39500779	03/24/2020	12
RE	MCC-231	177964	Microwave Cable	Junkosha INC.	MMX221	1901S329(1m)/1902S579(5m)	03/04/2021	12
RE	MHA-16	141513	Horn Antenna 15-40GHz	Schwarzbeck	BBHA9170	BBHA9170306	05/21/2020	12
RE	MSA-03	141884	Spectrum Analyzer	AGILENT	E4448A	MY44020357	03/04/2020	12
AT	MSA-04	141885	Spectrum Analyzer	Keysight Technologies Inc	E4448A	US44300523	11/09/2020	12
AT	MPM-12	141809	Power Meter	Anritsu Corporation	ML2495A	825002	05/07/2020	12
AT	MPSE-17	141830	Power sensor	Anritsu Corporation	MA2411B	738285	05/07/2020	12
AT	MCC-66	141328	Microwave Cable 1G-40GHz	Suhner	SUCOFLEX102	28636/2	04/02/2020	12
AT	MAT-58	141334	Attenuator(10dB)	Suhner	6810.19.A	-	12/07/2020	12
AT	MOS-13	141554	Thermo-Hygrometer	CUSTOM. Inc	CTH-201	1301	01/15/2021	12
AT	MMM-08	141532	DIGITAL HiTESTER	HIOKI E.E. CORPORATION	3805	51201197	01/07/2021	12
AT	MJM-16	142183	Measure	KOMELON	KMC-36	-	-	-

\*Hyphens for Last Calibration Date and Cal Int (month) are instruments that Calibration is not required (e.g. software), or instruments checked in advance before use.

The expiration date of the calibration is the end of the expired month.

As for some calibrations performed after the tested dates, those test equipment have been controlled by means of an unbroken chains of calibrations.

All equipment is calibrated with valid calibrations. Each measurement data is traceable to the national or international standards.

Test item: RE: Radiated Emission test  
AT: Antenna Terminal Conducted test

**UL Japan, Inc.**

**Ise EMC Lab.**

4383-326 Asama-cho, Ise-shi, Mie-ken 516-0021 JAPAN

Telephone : +81 596 24 8999

Facsimile : +81 596 24 8124