

FCC RADIO TEST REPORT

FCC ID: Q6WLWCLLRCC

Product: Carlink

Trade Name: Light Wave

Model Name: CLLRCC

Serial Model: N/A

Report No.: UNIA19101050ER-01

Prepared for

Steelmate Co., Ltd.

Steelmate Industrial Park, Heping Street, Dongfu Road, Dongfeng
Town, Zhongshan City, Guangdong, P.R. China 528425

Prepared by

Shenzhen United Testing Technology Co., Ltd.

2F, Annex Bldg, Jiahuangyuan Tech Park, #365 Baotian 1 Rd, Tiegang
Community, Xixiang Str, Bao'an District, Shenzhen, China

TEST RESULT CERTIFICATION

Applicant's name.....: Steelmate Co., Ltd.

Address.....: Steelmate Industrial Park, Heping Street, Dongfu Road, Dongfeng Town, Zhongshan City, Guangdong, P.R. China 528425

Manufacture's Name.....: Steelmate Co., Ltd.

Address.....: Steelmate Industrial Park, Heping Street, Dongfu Road, Dongfeng Town, Zhongshan City, Guangdong, P.R. China 528425

Product description

Product name.....: Carlink

Trade Mark.....: Light Wave

Model and/or type reference : CLLRCC

Standards.....: FCC Rules and Regulations Part 15 Subpart C Section 15.249
ANSI C63.10: 2013

This device described above has been tested by Shenzhen United Testing Technology Co., Ltd., and the test results show that the equipment under test (EUT) is in compliance with the FCC requirements. And it is applicable only to the tested sample identified in the report.

This report shall not be reproduced except in full, without the written approval of UNI, this document may be altered or revised by Shenzhen United Testing Technology Co., Ltd., personnel only, and shall be noted in the revision of the document.

Date of Test.....:

Date (s) of performance of tests.....: Oct. 10, 2019 ~ Dec. 05, 2019

Date of Issue.....: Dec. 05, 2019

Test Result.....: Pass

Prepared by:

Bob Liao

Bob Liao/Editor

Reviewer:

Kahn Yang
Kahn yang/Supervisor

Approved & Authorized Signer:

Liuze
Liuze/Manager

Table of Contents

Page

1 TEST SUMMARY.....	4
2 GENERAL INFORMATION.....	5
GENERAL DESCRIPTION OF EUT.....	5
Carrier Frequency of Channels.....	6
Operation of EUT during testing.....	6
DESCRIPTION OF TEST SETUP.....	6
MEASUREMENT INSTRUMENTS LIST.....	7
3 CONDUCTED EMISSION TEST.....	8
3.1 Test Limit.....	8
3.2 Test Setup.....	8
3.3 Test Procedure.....	8
3.4 Test Result.....	8
4 RADIATED EMISSION TEST.....	11
4.1 Test Limit.....	11
4.2 Test Setup.....	12
4.3 Test Procedure.....	14
4.4 Test Result.....	14
5 OCCUPIED BANDWIDTH TEST.....	18
5.1 Test Setup.....	18
5.2 Rules and specifications.....	18
5.3 Test Procedure.....	18
5.4 Test Result.....	19
6 ANTENNA REQUIREMENT.....	20
7 PHOTOGRAPH OF TEST.....	21
7.1 Radiated Emission.....	21
7.2 Conducted Emission.....	22

1 TEST SUMMARY

TEST PROCEDURES AND RESULTS

DESCRIPTION OF TEST	RESULT	
AC Power Line Conducted Emission	COMPLIANT	FCC Part 15.207
Field Strength of Fundamental	COMPLIANT	FCC Part 15.209/15.249
Spurious Emissions	COMPLIANT	FCC Part 15.209/15.249
Band Edge	COMPLIANT	FCC Part 15.249(d)
20dB Occupied Bandwidth	COMPLIANT	FCC Part 15.215
Antenna requirement	COMPLIANT	FCC Part 15.203

TEST FACILITY

Test Firm : Shenzhen United Testing Technology Co., Ltd.
 Address : 2F, Annex Bldg, Jiahuangyuan Tech Park, #365 Baotian 1 Rd, Tiegang Community, Xixiang Str, Bao'an District, Shenzhen, China

The testing quality ability of our laboratory meet with "Quality Law of People's Republic of China" Clause 19. The testing quality system of our laboratory meets with ISO/IEC-17025 requirements. This approval result is accepted by MRA of APLAC.

Our test facility is recognized, certified, or accredited by the following organizations:

A2LA Certificate Number: 4747.01

The EMC Laboratory has been accredited by A2LA, and in compliance with ISO/IEC 17025:2017 General Requirements for testing Laboratories.

FCC Registration Number: 674885

The EMC Laboratory has been registered and fully described in a report filed with the (FCC) Federal Communications commission.

IC Registration Number: 21947

The EMC Laboratory has been registered and fully described in a report filed with the (IC) Industry Canada.

MEASUREMENT UNCERTAINTY

Measurement Uncertainty

Conducted Emission Expanded Uncertainty	=	2.23dB, k=2
Radiated emission expanded uncertainty(9kHz-30MHz)	=	3.08dB, k=2
Radiated emission expanded uncertainty(30MHz-1000MHz)	=	4.42dB, k=2
Radiated emission expanded uncertainty(Above 1GHz)	=	4.06dB, k=2

2 GENERAL INFORMATION

GENERAL DESCRIPTION OF EUT

Equipment	Carlink
Trade Mark	Light Wave
Model Name	CLLRCC
Serial No.	N/A
Model Difference	N/A
FCC ID	Q6WLWCLLRCC
Antenna Type	PCB Antenna
Antenna Gain	0dBi
Operation frequency	911.85MHz
Number of Channels	1CH
Modulation Type	LORA
Battery	DC 3.7V 200mAh
Adapter Model	AC 100-240V~50/60Hz

Carrier Frequency of Channels

Operation Frequency each of channel	
Channel	Frequency
01	911.85MHz

Operation of EUT during testing

Operating Mode

The mode is used: Transmitting mode

DESCRIPTION OF TEST SETUP

Operation of EUT during testing:

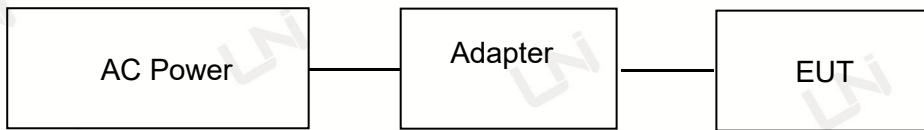

Setup: Transmission mode

Table for auxiliary equipment:

Equipment Description	Manufacturer	Model	Calibration Due Date
HuaWei	Adapter	HW-050200C01	N/A

MEASUREMENT INSTRUMENTS LIST

Item	Equipment	Manufacturer	Model No.	Serial No.	Calibrated until
CONDUCTED EMISSIONS TEST					
1	AMN	Schwarzbeck	NNLK8121	8121370	2020.09.06
2	AMN	ETS	3810/2	00020199	2020.09.06
3	EMI TEST RECEIVER	Rohde&Schwarz	ESCI	101210	2020.09.06
4	AAN	TESEQ	T8-Cat6	38888	2020.09.06
RADIATED EMISSION TEST					
1	Horn Antenna	Sunol	DRH-118	A101415	2020.09.06
2	BicoNILog Antenna	Sunol	JB1 Antenna	A090215	2020.09.06
3	PREAMP	HP	8449B	3008A00160	2020.09.06
4	PREAMP	HP	8447D	2944A07999	2020.09.06
5	EMI TEST RECEIVER	Rohde&Schwarz	ESR3	101891	2020.09.06
6	VECTOR Signal Generator	Rohde&Schwarz	SMU200A	101521	2020.09.06
7	Signal Generator	Agilent	E4421B	MY4335105	2020.09.06
8	MXA Signal Analyzer	Agilent	N9020A	MY50510140	2020.09.06
9	MXA Signal Analyzer	Agilent	N9020A	MY51110104	2020.09.06
10	ANT Tower&Turn table Controller	Champro	EM 1000	60764	2020.09.06
11	Anechoic Chamber	Taihe Maorui	9m*6m*6m	966A0001	2020.09.06
12	Shielding Room	Taihe Maorui	6.4m*4m*3m	643A0001	2020.09.06
13	RF Power sensor	DARE	RPR3006W	15I00041SNO88	2020.3.14
14	RF Power sensor	DARE	RPR3006W	15I00041SNO89	2020.3.14
15	RF power divider	Anritsu	K241B	992289	2020.09.06
16	Wideband radio communication tester	Rohde&Schwarz	CMW500	154987	2020.09.06
17	Biconical antenna	Schwarzbeck	VHA 9103	91032360	2020.09.06
18	Biconical antenna	Schwarzbeck	VHA 9103	91032361	2020.09.06
19	Broadband Hybrid Antennas	Schwarzbeck	VULB9163	VULB9163#958	2020.09.06
20	Horn Antenna	Schwarzbeck	BBHA9120D	9120D-1680	2020.1.12
21	Active Receive Loop Antenna	Schwarzbeck	FMZB 1919B	00023	2020.09.06
22	Horn Antenna	Schwarzbeck	BBHA 9170	BBHA9170651	2020.09.06
23	Microwave Broadband Pre-amplifier	Schwarzbeck	BBV 9721	100472	2020.09.06
24	Active Loop Antenna	Com-Power	AL-130R	10160009	2020.09.06
25	Power Meter	KEYSIGHT	N1911A	MY50520168	2020.09.06

3 CONDUCTED EMISSION TEST

3.1 Test Limit

For unintentional device, according to § 15.107(a) Line Conducted Emission Limits is as following

Frequency (MHz)	Maximum RF Line Voltage(dB μ V)			
	CLASS A		CLASS B	
	Q.P.	Ave.	Q.P.	Ave.
0.15~0.50	79	66	66~56*	56~46*
0.50~5.00	73	60	56	46
5.00~30.0	73	60	60	50

* Decreasing linearly with the logarithm of the frequency

For intentional device, according to §15.207(a) Line Conducted Emission Limit is same as above table.

3.2 Test Setup

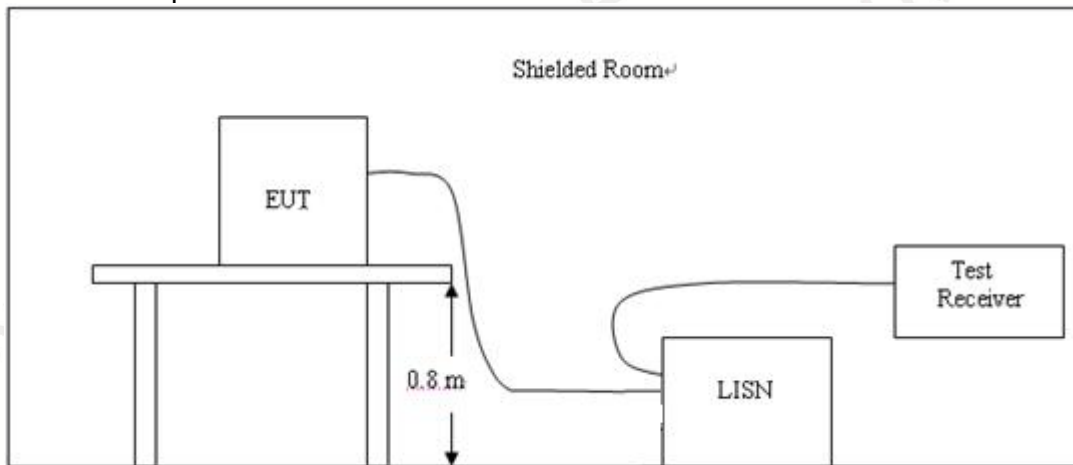

3.3 Test Procedure

1. The equipment was set up as per the test configuration to simulate typical actual usage per the user's manual. A wooden table with a height of 0.8 meters is used and is placed on the ground plane as per ANSI C63.10.
2. Support equipment, if needed, was placed as per ANSI C63.10.
3. All I/O cables were positioned to simulate typical actual usage as per ANSI C63.10.
4. If a EUT received DC power from the USB Port of Notebook PC, the PC's adapter received AC120V/60Hz power through a Line Impedance Stabilization Network (LISN) which supplied power source and was grounded to the ground plane.
5. All support equipments received AC power from a second LISN, if any.
6. The EUT test program was started. Emissions were measured on each current carrying line of the EUT using a spectrum Analyzer / Receiver connected to the LISN powering the EUT. The LISN has two monitoring points: Line 1 (Hot Side) and Line 2 (Neutral Side). Two scans were taken: one with Line 1 connected to Analyzer / Receiver and Line 2 connected to a 50 ohm load; the second scan had Line 1 connected to a 50 ohm load and Line 2 connected to the Analyzer / Receiver.
7. Analyzer/Receiver scanned from 150 KHz to 30MHz for emissions in each of the test modes.

3.4 Test Result

PSSS

Temperature:	26°C	Relative Humidity:	40%
Test Date:	Nov. 12, 2019	Pressure:	1010hPa
Test Voltage:	AC 120V, 60Hz	Phase:	Line
Test Mode:	Transmitting mode		

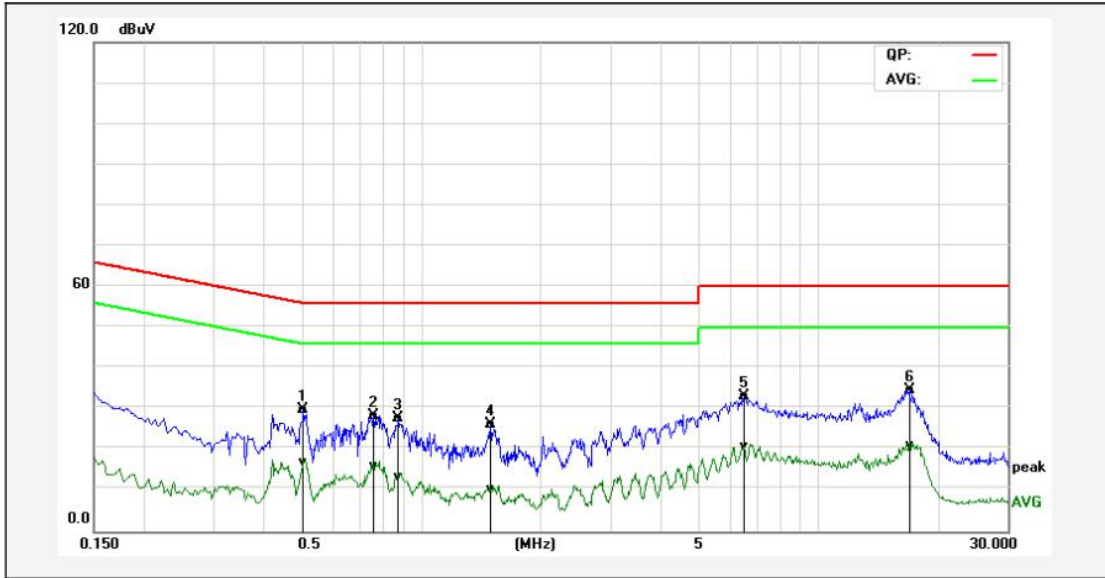

No.	Frequency (MHz)	QuasiPeak reading (dBuV)	Average reading (dBuV)	Correction factor (dB)	QuasiPeak result (dBuV)	Average result (dBuV)	QuasiPeak limit (dBuV)	Average limit (dBuV)	QuasiPeak margin (dB)	Average margin (dB)	Remark
1P	0.5060	20.12	7.36	9.69	29.81	17.05	56.00	46.00	-26.19	-28.95	Pass
2P	0.7620	18.74	6.22	9.73	28.47	15.95	56.00	46.00	-27.53	-30.05	Pass
3P	0.8780	18.10	3.54	9.74	27.84	13.28	56.00	46.00	-28.16	-32.72	Pass
4P	1.4980	16.44	0.65	9.77	26.21	10.42	56.00	46.00	-29.79	-35.58	Pass
5P	6.4899	23.16	11.08	9.85	33.01	20.93	60.00	50.00	-26.99	-29.07	Pass
6*	17.0140	34.27	20.77	0.39	34.66	21.16	60.00	50.00	-25.34	-28.84	Pass

Remark: Factor = Insertion Loss + Cable Loss, Result = Reading + Factor, Margin = Result – Limit.

Temperature:	26°C	Relative Humidity:	40%
Test Date:	Nov. 12, 2019	Pressure:	1010hPa
Test Voltage:	AC 120V, 60Hz	Phase:	Neutral
Test Mode:	Transmitting mode		

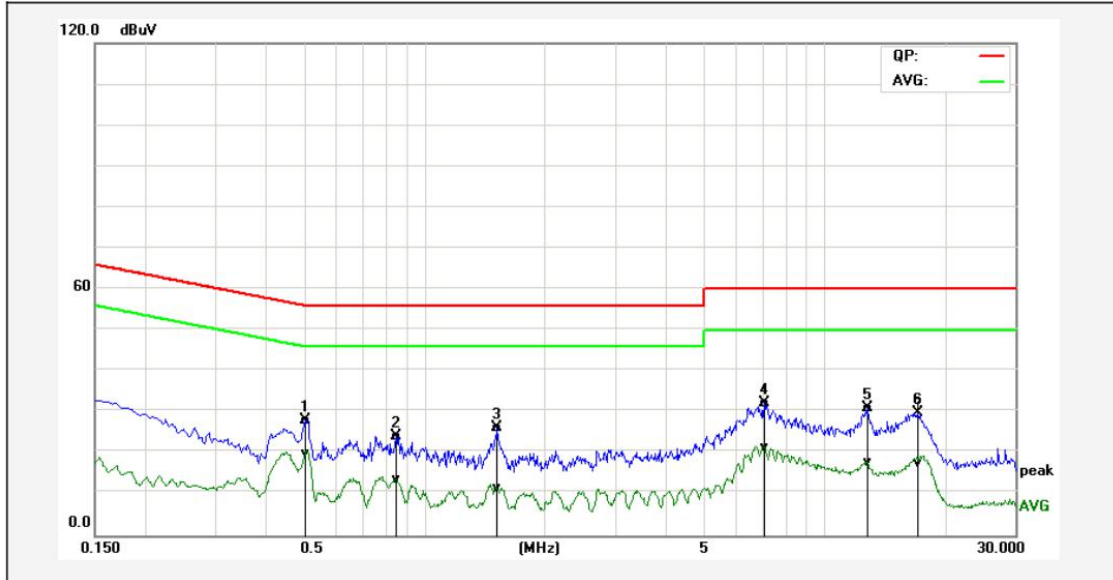

No.	Frequency (MHz)	QuasiPeak reading (dBuV)	Average reading (dBuV)	Correction factor (dB)	QuasiPeak result (dBuV)	Average result (dBuV)	QuasiPeak limit (dBuV)	Average limit (dBuV)	QuasiPeak margin (dB)	Average margin (dB)	Remark
1*	0.5020	18.29	10.31	9.68	27.97	19.99	56.00	46.00	-28.03	-26.01	Pass
2P	0.8500	14.31	3.94	9.75	24.06	13.69	56.00	46.00	-31.94	-32.31	Pass
3P	1.5220	16.57	1.70	9.76	26.33	11.46	56.00	46.00	-29.67	-34.54	Pass
4P	7.0860	22.35	11.70	9.85	32.20	21.55	60.00	50.00	-27.80	-28.45	Pass
5P	12.8100	30.93	17.62	0.24	31.17	17.86	60.00	50.00	-28.83	-32.14	Pass
6P	17.1180	32.54	17.20	0.39	32.93	17.59	60.00	50.00	-27.07	-32.41	Pass

Remark: Factor = Insertion Loss + Cable Loss, Result = Reading + Factor, Margin = Result – Limit.

4 RADIATED EMISSION TEST

4.1 Test Limit

1. Limit (Field strength of the fundamental signal):

Frequency	Limit(dBuV/m@3m)	Remark
902MHz-928MHz	94.00	Average Value
	114.00	Peak Value

2. Limit (Spurious Emissions):

Frequency	Limit(dBuV/m@3m)	Remark
0.009-0.490	2400/F(KHz)	Quasi-peak Value
0.490-1.705	24000/F(KHz)	Quasi-peak Value
1.705-30	30	Quasi-peak Value
30MHz-88MHz	40.0	Quasi-peak Value
88MHz-216MHz	43.5	Quasi-peak Value
216MHz-960MHz	46.0	Quasi-peak Value
960MHz-1GHz	54.0	Quasi-peak Value
Above 1GHz	54.0	Average Value
	74.0	Peak Value

3. Limit (Band edge):

Emissions radiated outside of the specified frequency bands, except for harmonics, shall be attenuated by at least 50 dB below the level of the fundamental or to the general radiated emission limits in Section 15.209, whichever is the lesser attenuation.

4.2 Test Setup

1. Radiated Emission Test-Up Frequency Below 30MHz

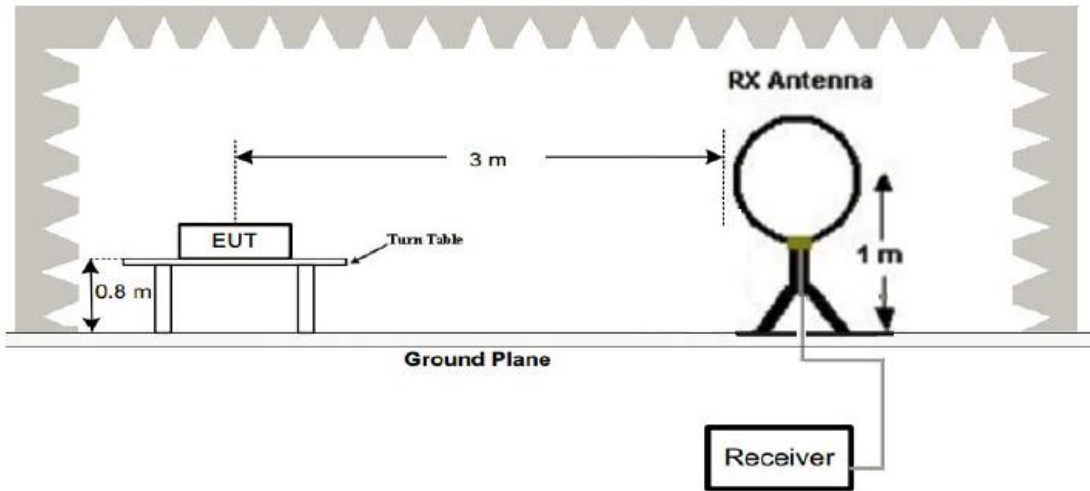

2. Radiated Emission Test-Up Frequency 30MHz~1GHz

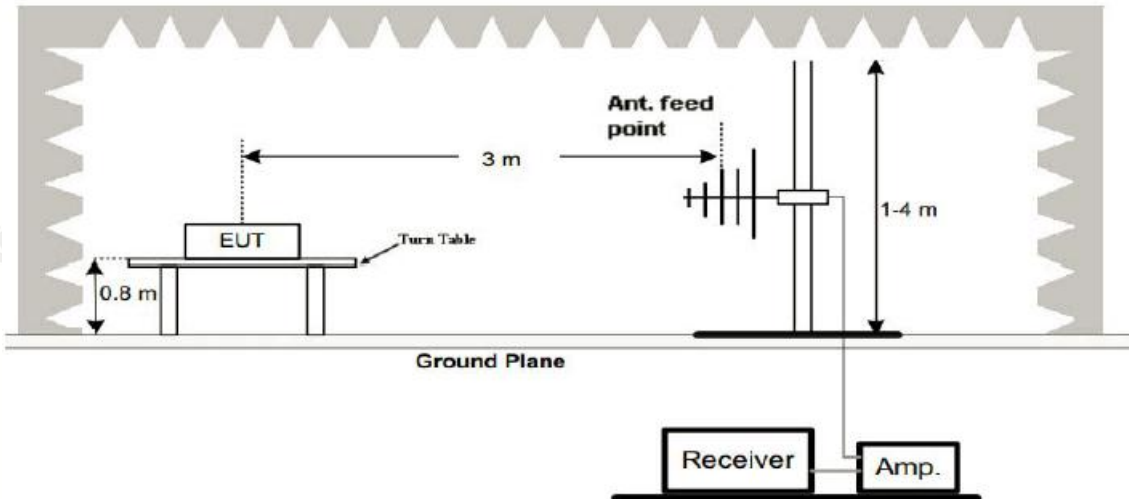

3. Radiated Emission Test-Up Frequency Above 1GHz

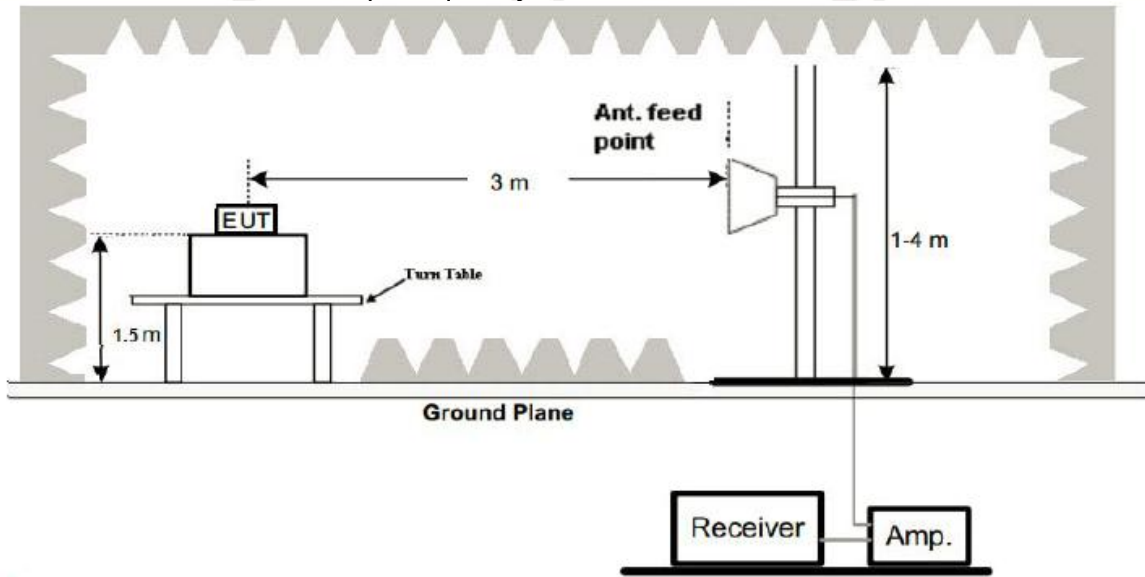

4. Receiver Setup:

Frequency	Detector	RBW	VBW	Remark
9kHz- 150kHz	Quasi-peak	200Hz	1kHz	Quasi-peak Value
150kHz-30MHz	Quasi-peak	9kHz	30kHz	Quasi-peak Value
30MHz-1GHz	Quasi-peak	120kHz	300kHz	Quasi-peak Value
Above 1GHz	Peak	1MHz	3MHz	Peak Value
	Peak	1MHz	10Hz	Average Value

4.3 Test Procedure

1. The EUT was placed on the top of a rotating table 0.8 meters above the ground at a 3 meter chamber in below 1GHz, 1.5m above the ground in above 1GHz. The table was rotated 360 degrees to determine the position of the highest radiation.
2. The EUT was set 3 meters away from the interference-receiving antenna, which was mounted on the top of a variable-height antenna tower.
3. The antenna height is varied from one meter to four meters above the ground to determine the maximum value of the field strength. Both horizontal and vertical polarizations of the antenna are set to make the measurement.
4. For each suspected emission, the EUT was arranged to its worst case and then the antenna was tuned to heights from 1 meter to 4 meters and the rotatable table was turned from 0 degrees to 360 degrees to find the maximum reading.
5. The test-receiver system was set to Peak Detect Function and Specified Bandwidth with Maximum Hold Mode.
6. If the emission level of the EUT in peak mode was 10dB lower than the limit specified, then testing could be stopped and the peak values of the EUT would be reported. Otherwise the emissions that did not have 10dB margin would be re-tested one by one using peak, quasi-peak or average method as specified and then reported in a data sheet.

4.4 Test Result

Field Strength of Fundamental:

Frequency (MHz)	Emission PK/AV (dBuV/m)	Ant. Pol.	Limits PK/AV (dBuV/m)	Margin (dB)
911.85	105.53(PK)	H	114/94	-8.47
911.85	87.61(AV)	H	114/94	-6.39
911.85	73.91(PK)	V	114/94	-30.09
911.85	67.96(AV)	V	114/94	-26.04

Spurious Emissions:

For 9 kHz-30MHz Test Results:

Note: The emission levels are 20 dB below the limit value, which are not reported. It is deemed to comply with the requirement.

For 30MHz-1GHz Test Results:

Temperature:	22°C	Relative Humidity:	46%
Test Date:	Nov. 12, 2019	Pressure:	1010hPa
Test Voltage:	AC 120V, 60Hz	Polarization:	Horizontal
Test Mode:	Transmitting mode		

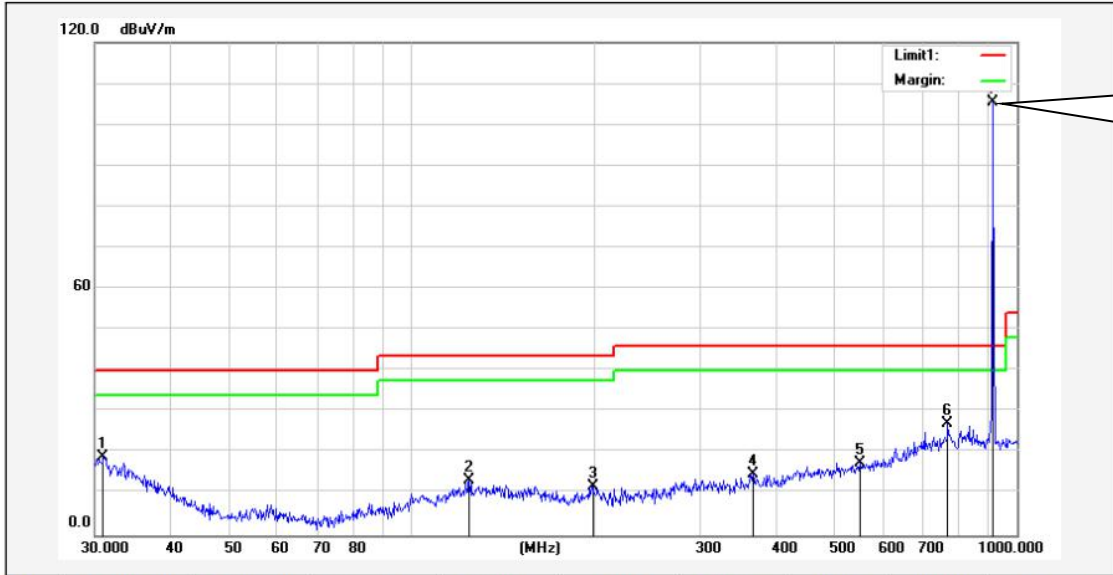

No.	Frequency (MHz)	Reading (dBuV)	Correction factor(dB/m)	Result (dBuV/m)	Limit (dBuV/m)	Margin (dB)	Degree (deg.)	Height (cm)	Remark
1	30.9620	27.05	-8.03	19.02	40.00	-20.98	150	100	peak
2	124.5690	28.99	-15.69	13.30	43.50	-30.20	180	100	peak
3	199.2855	27.48	-15.52	11.96	43.50	-31.54	300	100	peak
4	366.8231	28.69	-13.69	15.00	46.00	-31.00	240	100	peak
5	550.9480	28.93	-11.43	17.50	46.00	-28.50	120	100	peak
6	768.7481	35.18	-8.00	27.18	46.00	-18.82	300	100	peak
7*	912.8620	111.89	-6.36	105.53	46.00	59.53	150	100	peak

Remark: Absolute Level = Reading Level + Factor, Margin = Absolute Level – Limit
 Factor = Ant. Factor + Cable Loss – Pre-amplifier

Temperature:	22°C	Relative Humidity:	46%
Test Date:	Nov. 12, 2019	Pressure:	1010hPa
Test Voltage:	AC 120V, 60Hz	Polarization:	Vertical
Test Mode:	Transmitting mode		

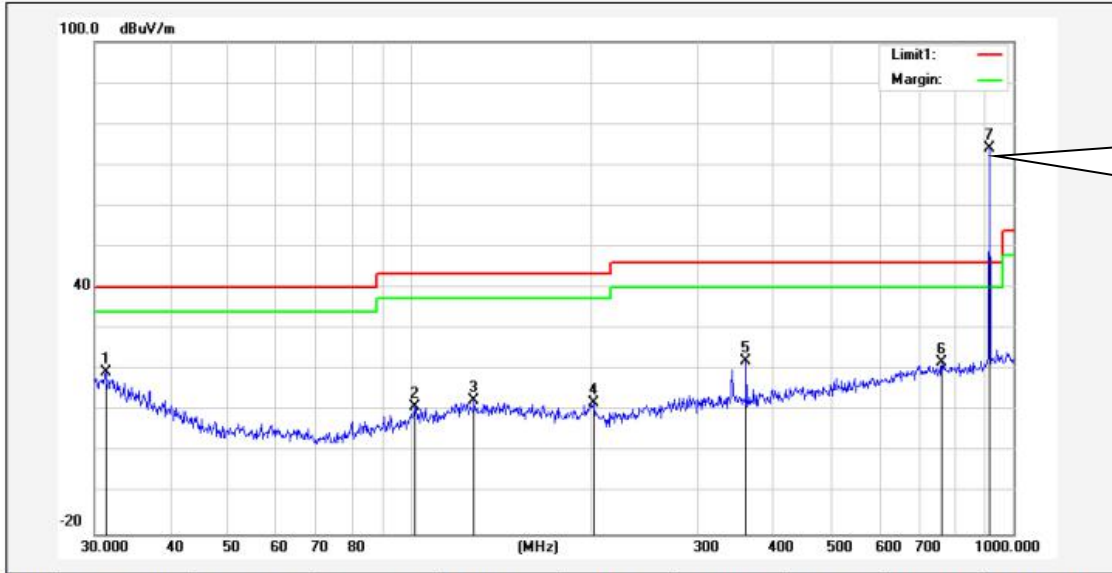

No.	Frequency (MHz)	Reading (dBuV)	Correction factor(dB/m)	Result (dBuV/m)	Limit (dBuV/m)	Margin (dB)	Degree (deg.)	Height (cm)	Remark
1	31.2893	27.88	-8.34	19.54	40.00	-20.46	240	100	peak
2	101.6443	29.17	-17.97	11.20	43.50	-32.30	120	100	peak
3	127.6645	28.16	-15.46	12.70	43.50	-30.80	60	100	peak
4	201.3930	27.62	-15.70	11.92	43.50	-31.58	120	100	peak
5	360.4476	35.93	-13.80	22.13	46.00	-23.87	150	100	peak
6	760.7036	29.98	-8.14	21.84	46.00	-24.16	90	100	peak
7*	912.8620	80.27	-6.36	73.91	46.00	27.91	300	100	peak

Remark: Absolute Level = Reading Level + Factor, Margin = Absolute Level – Limit
 Factor = Ant. Factor + Cable Loss – Pre-amplifier

For Above 1GHz Test Results:

Frequency (MHz)	Ant. Pol.	PK Reading (dBμV)	AV Reading (dBμV)	Correction Factor (dB/m)	Emission Level		Peak limit (dBμV/m)	AV limit (dBμV/m)	Margin Peak(dB)	Margin AV(dB)
					Peak (dBμV/m)	AV (dBμV/m)				
1823.7	H	51.67	---	-4.12	47.55	---	74.00	54.00	-26.45	---
2735.6	H	41.64	---	-0.58	41.06	---	74.00	54.00	-32.94	---
1823.7	V	52.36	---	-4.17	48.19	---	74.00	54.00	-25.81	---
2735.6	V	42.42	---	-0.58	41.84	---	74.00	54.00	-32.16	---

Note:

1. Emission Level = Peak Reading + Correction Factor; Correction Factor = Antenna Factor + Cable loss – Pre-amplifier
2. Margin = Emission - Limit
3. The emission levels of other frequencies are very lower than the limit and not show in test report.
4. Measurements were conducted from 1 GHz to the 10th harmonic of highest fundamental frequency.
5. Data of measurement shown “---” in the above table mean that the reading of emissions is attenuated more than 20dB below the limits or the field strength is too small to be measured.

Band Edge Requirement:

Frequency (MHz)	Ant. Pol.	PK Reading (dBμV)	AV Reading (dBμV)	Correction Factor (dB/m)	Emission Level		Peak limit (dBμV/m)	AV limit (dBμV/m)	Margin Peak(dB)	Margin AV(dB)
					Peak (dBμV/m)	AV (dBμV/m)				
902	H	53.24	---	-3.8	49.44	---	74	54	-24.56	---
928	H	54.12	---	-3.7	50.42	---	74	54	-23.58	---
902	V	52.79	---	-3.8	48.99	---	74	54	-25.01	---
928	V	51.96	---	-4.3	47.66	---	74	54	-26.34	---

Note:

1. Emission Level = Peak Reading + Correction Factor; Correction Factor = Antenna Factor + Cable loss – Pre-amplifier
2. Margin = Emission - Limit
3. The emission levels of other frequencies are very lower than the limit and not show in test report.
4. Measurements were conducted from 1 GHz to the 10th harmonic of highest fundamental frequency.
5. Data of measurement shown “---” in the above table mean that the reading of emissions is attenuated more than 20dB below the limits or the field strength is too small to be measured.

5 OCCUPIED BANDWIDTH TEST

5.1 Test Setup

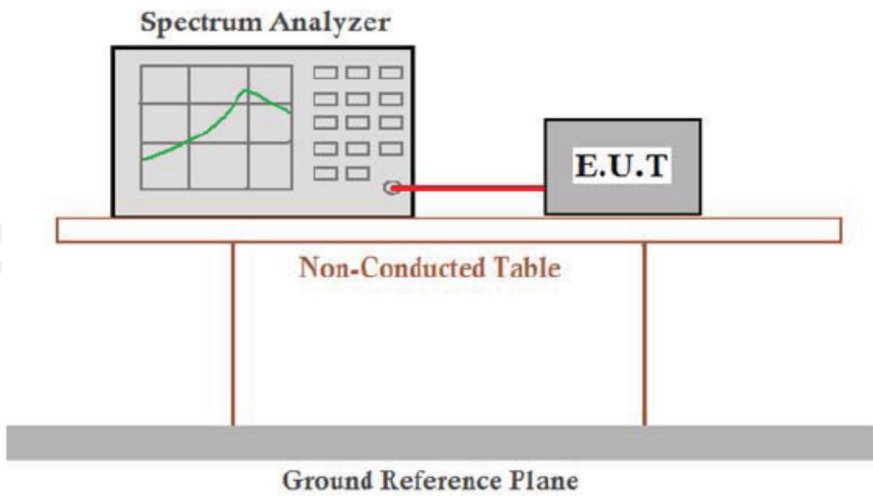

5.2 Rules and specifications

CFR 47 Part 15.215(c)

ANSI C63.10: 2013

5.3 Test Procedure

1. According to the follow Test-setup, keep the relative position between the artificial antenna and the EUT.
2. Set to the maximum power setting and enable the EUT transmit continuously.
3. Use the following spectrum analyzer settings for 20dB Bandwidth measurement.
Span = approximately 2 to 3 times the 20 dB bandwidth, centered on a hopping channel; $RBW \geq 1\%$ of the 20dB bandwidth; $VBW \geq RBW$; Sweep = auto; Detector function = peak; Trace = max hold.
4. Measure and record the results in the test report.

5.4 Test Result

PASS

Mode	Frequency(MHz)	20dB Bandwidth (KHz)	Limit (kHz)	Conclusion
TX	911.85	707.8	/	PASS



6 ANTENNA REQUIREMENT

Standard Applicable:

For intentional device, according to FCC 47 CFR Section 15.203, an intentional radiator shall be designed to ensure that no antenna other than that furnished by the responsible party shall be used with the device.

Antenna Connected Construction

The antenna used in this product is a PCB Antenna, The directional gains of antenna used for transmitting is 0dBi.

ANTENNA

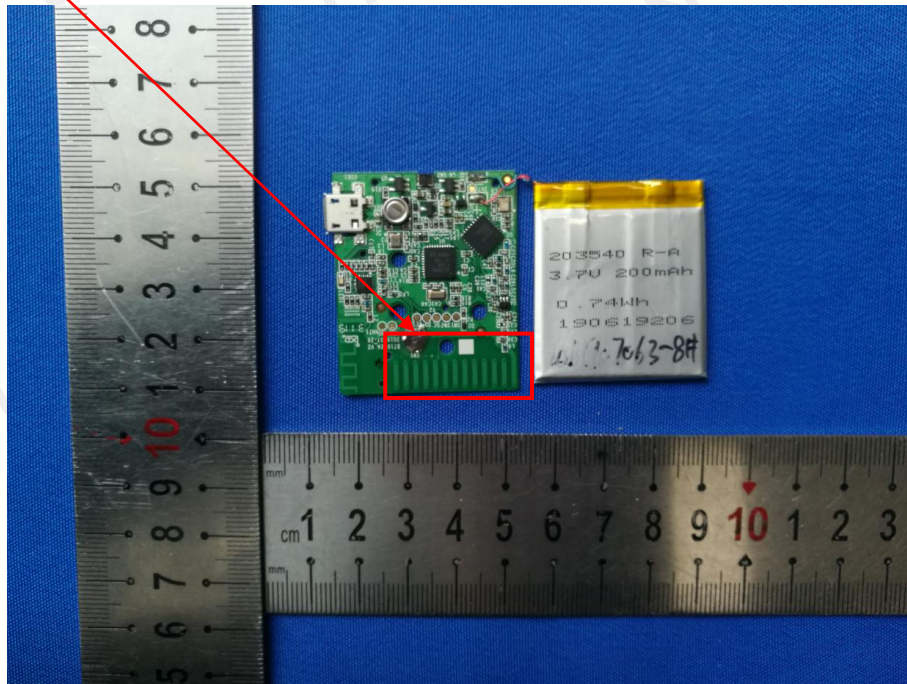

7 PHOTOGRAPH OF TEST

7.1 Radiated Emission



7.2 Conducted Emission



End of Report