

## FCC Test Report

**Report No.:** RFBDYS-WTW-P20100843-1

**FCC ID:** Q6G-AP330

**Test Model:** AP330

**Received Date:** Nov. 01, 2020

**Test Date:** Nov. 12 ~ Dec. 29, 2020

**Issued Date:** Jan. 13, 2021

**Applicant:** WatchGuard Technologies, Inc.

**Address:** 505 Fifth Avenue South, Suite 500 Seattle WA United States 98104

**Issued By:** Bureau Veritas Consumer Products Services (H.K.) Ltd., Taoyuan Branch  
Lin Kou Laboratories

**Lab Address:** No. 47-2, 14th Ling, Chia Pau Vil., Lin Kou Dist., New Taipei City, Taiwan

**Test Location:** No. 19, Hwa Ya 2nd Rd., Wen Hwa Vil., Kwei Shan Dist., Taoyuan City  
33383, TAIWAN

**FCC Registration /  
Designation Number:** 788550 / TW0003



This report is for your exclusive use. Any copying or replication of this report to or for any other person or entity, or use of our name or trademark, is permitted only with our prior written permission. This report sets forth our findings solely with respect to the test samples identified herein. The results set forth in this report are not indicative or representative of the quality or characteristics of the lot from which a test sample was taken or any similar or identical product unless specifically and expressly noted. Our report includes all of the tests requested by you and the results thereof based upon the information that you provided to us. You have 60 days from date of issuance of this report to notify us of any material error or omission caused by our negligence, provided, however, that such notice shall be in writing and shall specifically address the issue you wish to raise. A failure to raise such issue within the prescribed time shall constitute your unqualified acceptance of the completeness of this report, the tests conducted and the correctness of the report contents. Unless specifically mentioned, the uncertainty of measurement has been explicitly taken into account to declare the compliance or non-compliance to the specification.

## Table of Contents

<b>Release Control Record</b> .....	<b>4</b>
<b>1 Certificate of Conformity</b> .....	<b>5</b>
<b>2 Summary of Test Results</b> .....	<b>6</b>
2.1 Measurement Uncertainty.....	6
2.2 Modification Record.....	6
<b>3 General Information</b> .....	<b>7</b>
3.1 General Description of EUT.....	7
3.2 Description of Test Modes.....	10
3.2.1 Test Mode Applicability and Tested Channel Detail.....	11
3.3 Duty Cycle of Test Signal.....	13
3.4 Description of Support Units.....	15
3.4.1 Configuration of System under Test.....	15
3.5 General Description of Applied Standards and References.....	16
<b>4 Test Types and Results</b> .....	<b>17</b>
4.1 Radiated Emission and Bandedge Measurement.....	17
4.1.1 Limits of Radiated Emission and Bandedge Measurement.....	17
4.1.2 Test Instruments.....	18
4.1.3 Test Procedures.....	19
4.1.4 Deviation from Test Standard.....	20
4.1.5 Test Setup.....	20
4.1.6 EUT Operating Conditions.....	21
4.1.7 Test Results.....	22
4.2 Conducted Emission Measurement.....	66
4.2.1 Limits of Conducted Emission Measurement.....	66
4.2.2 Test Instruments.....	66
4.2.3 Test Procedures.....	67
4.2.4 Deviation from Test Standard.....	67
4.2.5 Test Setup.....	67
4.2.6 EUT Operating Conditions.....	67
4.2.7 Test Results.....	68
4.3 Transmit Power Measurement.....	76
4.3.1 Limits of Transmit Power Measurement.....	76
4.3.2 Test Setup.....	76
4.3.3 Test Instruments.....	76
4.3.4 Test Procedure.....	76
4.3.5 Deviation from Test Standard.....	76
4.3.6 EUT Operating Conditions.....	76
4.3.7 Test Result.....	77
4.4 Occupied Bandwidth Measurement.....	80
4.4.1 Test Setup.....	80
4.4.2 Test Instruments.....	80
4.4.3 Test Procedure.....	80
4.4.4 Test Result.....	81
4.5 Peak Power Spectral Density Measurement.....	89
4.5.1 Limits of Peak Power Spectral Density Measurement.....	89
4.5.2 Test Setup.....	89
4.5.3 Test Instruments.....	89
4.5.4 Test Procedures.....	89
4.5.5 Deviation from Test Standard.....	90
4.5.6 EUT Operating Conditions.....	90
4.5.7 Test Results.....	91
4.6 Frequency Stability.....	101
4.6.1 Limits of Frequency Stability Measurement.....	101

4.6.2	Test Setup.....	101
4.6.3	Test Instruments .....	101
4.6.4	Test Procedure .....	101
4.6.5	Deviation from Test Standard .....	102
4.6.6	EUT Operating Condition .....	102
4.6.7	Test Results .....	102
4.7	6dB Bandwidth Measurement.....	104
4.7.1	Limits of 6dB Bandwidth Measurement.....	104
4.7.2	Test Setup.....	104
4.7.3	Test Instruments .....	104
4.7.4	Test Procedure .....	104
4.7.5	Deviation from Test Standard .....	104
4.7.6	EUT Operating Condition .....	104
4.7.7	Test Results .....	105
<b>5</b>	<b>Pictures of Test Arrangements.....</b>	<b>109</b>
	<b>Annex A- Radiated Out of Band Emission (OOBE) Measurement (For U-NII-3 band).....</b>	<b>110</b>
	<b>Annex B- Band Edge Measurement.....</b>	<b>116</b>
	<b>Appendix – Information of the Testing Laboratories .....</b>	<b>124</b>

### Release Control Record

Issue No.	Description	Date Issued
RFBDYS-WTW-P20100843-1	Original release.	Jan. 13, 2021

## 1 Certificate of Conformity

**Product:** Wireless Access Point

**Brand:** WatchGuard

**Test Model:** AP330

**Sample Status:** Engineering sample

**Applicant:** WatchGuard Technologies, Inc.

**Test Date:** Nov. 12 ~ Dec. 29, 2020

**Standards:** 47 CFR FCC Part 15, Subpart E (Section 15.407)  
ANSI C63.10:2013

The above equipment has been tested by **Bureau Veritas Consumer Products Services (H.K.) Ltd., Taoyuan Branch**, and found compliance with the requirement of the above standards. The test record, data evaluation & Equipment Under Test (EUT) configurations represented herein are true and accurate accounts of the measurements of the sample's RF characteristics under the conditions specified in this report.

**Prepared by :** , **Date:** Jan. 13, 2021  
Polly Chien / Specialist

**Approved by :** , **Date:** Jan. 13, 2021  
Bruce Chen / Senior Project Engineer

## 2 Summary of Test Results

47 CFR FCC Part 15, Subpart E (Section 15.407)			
FCC Clause	Test Item	Result	Remarks
15.407(b)(6)	AC Power Conducted Emissions	Pass	Meet the requirement of limit. Minimum passing margin is -14.65dB at 0.51879MHz.
15.407(b)(1/2/3/4(i/ii)/6)	Radiated Emissions & Band Edge Measurement	Pass	Meet the requirement of limit. Minimum passing margin is -1.0dB at 5150.00MHz.
15.407(a)(1/2/3)	Max Average Transmit Power	Pass	Meet the requirement of limit.
---	Occupied Bandwidth Measurement	Pass	Meet the requirement of limit.
15.407(a)(1/2/3)	Peak Power Spectral Density	Pass	Meet the requirement of limit.
15.407(e)	6dB bandwidth	Pass	Meet the requirement of limit. (U-NII-3 Band only)
15.407(g)	Frequency Stability	Pass	Meet the requirement of limit.
15.203	Antenna Requirement	Pass	Antenna connector are IPEX not a standard connector.

Note:

1. For U-NII-3 band compliance with rule part 15.407(b)(4)(i), the OOB test plots were recorded in Annex A.
2. For U-NII-1 band compliance with rule 15.407(b) of the band-edge items, the test plots were recorded in Annex B. Test Procedures refer to report 4.1.3.
3. Determining compliance based on the results of the compliance measurement, not taking into account measurement instrumentation uncertainty.

### 2.1 Measurement Uncertainty

Where relevant, the following measurement uncertainty levels have been estimated for tests performed on the EUT as specified in CISPR 16-4-2:

Measurement	Frequency	Expanded Uncertainty (k=2) ( $\pm$ )
Conducted Emissions at mains ports	150kHz ~ 30MHz	2.79 dB
Radiated Emissions up to 1 GHz	9kHz ~ 30MHz	3.04 dB
	30MHz ~ 200MHz	3.86 dB
	200MHz ~ 1000MHz	3.87 dB
Radiated Emissions above 1 GHz	1GHz ~ 18GHz	2.29 dB
	18GHz ~ 40GHz	2.29 dB

### 2.2 Modification Record

There were no modifications required for compliance.

### 3 General Information

#### 3.1 General Description of EUT

Product	Wireless Access Point
Brand	WatchGuard
Test Model	AP330
Sample Status	Engineering sample
Power Supply rating	12Vdc from Adapter 54Vdc from PoE
Modulation Type	802.11a: BPSK, QPSK, 16QAM, 64QAM 802.11ac: BPSK, QPSK, 16QAM, 64QAM, 256QAM 802.11ax: BPSK, QPSK, 16QAM, 64QAM, 256QAM, 1024QAM
Modulation Technology	OFDM, OFDMA
Transfer Rate	802.11a: 54/48/36/24/18/12/9/6Mbps 802.11n: up to 300Mbps 802.11ac: up to 866.7Mbps 802.11ax: up to 1201Mbps
Operating Frequency	5180~5240MHz, 5745~5825MHz
Number of Channel	<u>5GHz traffic radio:</u> 5180 ~ 5240MHz: 802.11a, 802.11n (HT20), 802.11ac (VHT20), 802.11ax (HE20): 4 802.11n (HT40), 802.11ac (VHT40), 802.11ax (HE40): 2 802.11ac (VHT80), 802.11ax (HE80): 1 5745 ~ 5825MHz: 802.11a, 802.11n (HT20), 802.11ac (VHT20), 802.11ax (HE20): 5 802.11n (HT40), 802.11ac (VHT40), 802.11ax (HE40): 2 802.11ac (VHT80), 802.11ax (HE80): 1 <u>Scanning radio:</u> 5180 ~ 5240MHz: 802.11a, 802.11n (HT20), 802.11ac (VHT20): 4 802.11n (HT40), 802.11ac (VHT40): 2 802.11ac (VHT80): 1 5745 ~ 5825MHz: 802.11a, 802.11n (HT20), 802.11ac (VHT20): 5 802.11n (HT40), 802.11ac (VHT40): 2 802.11ac (VHT80): 1

Output Power	CDD Mode: 5180 ~ 5240MHz: 5G traffic radio: 265.637mW Scanning radio: 213.324mW 5745 ~ 5825MHz: 5G traffic radio: 205.900mW Scanning radio: 246.096mW Beamforming Mode: 5180 ~ 5240MHz: 5G traffic radio: 104.365mW 5745 ~ 5825MHz: 5G traffic radio: 102.957mW
Antenna Type	Refer to note
Antenna Connector	Refer to note
Accessory Device	NA
Cable Supplied	NA

Note:

1. The EUT incorporates a MIMO function. Physically, the EUT provides 2 completed transmitters and 2 receivers.

Modulation Mode	CDD Mode	Beamforming Mode	TX Function	Radio
802.11a	Support	Not Support	2TX	5G traffic radio (Radio 2)
802.11n (HT20)	Support	Not Support	2TX	
802.11n (HT40)	Support	Not Support	2TX	
802.11ac (VHT20)	Support	Support	2TX	
802.11ac (VHT40)	Support	Support	2TX	
802.11ac (VHT80)	Support	Support	2TX	
802.11ax (HE20)	Support	Support	2TX	
802.11ax (HE40)	Support	Support	2TX	
802.11ax (HE80)	Support	Support	2TX	
802.11a	Support	Not Support	2TX	
802.11n (HT20)	Support	Not Support	2TX	
802.11n (HT40)	Support	Not Support	2TX	
802.11ac (VHT20)	Support	Not Support	2TX	
802.11ac (VHT40)	Support	Not Support	2TX	
802.11ac (VHT80)	Support	Not Support	2TX	

\* The bandwidth and modulation are similar for HT20/HT40 on 802.11n mode and VHT20/VHT40/VHT80 on 802.11n mode and HE20/HE40/HE80 on 802.11ax mode. Therefore the investigated worst case is the representative mode in test report. (Final test mode refer section 3.2.1)

\* For 802.11ax, CDD mode and Beamforming mode are presented in power output test item. For other test items, CDD mode is the worst case for final tests after pretesting.



2. The EUT consumes power from the following POE and adapter.

POE (support unit only)	
Brand	EnGenius
Model	EPA5006GAT
Input Power	100-240Vac, 50-60Hz, 0.8A
Output Power	54Vdc, 0.6A

Adapter (support unit only)	
Brand	APD
Model	WA-30J12R
Input Power	100-240Vac, 50-60Hz, 0.9A
Output Power	12.0Vdc, 2.5A, 30.0W
Power Cord	1.45m power cable w/o core

3. The following antennas were provided to the EUT.

Antenna Type	PIFA					
Antenna Connector	IPEX					
Antenna No.	Gain (dBi)					
	2400MHz	2450MHz	2500MHz	5150MHz	5500MHz	5850MHz
2G1	2.82	2.12	2.02	-	-	-
2G2	3.31	3.67	2.68	-	-	-
5G1	-	-	-	4.41	4.21	4.96
5G2	-	-	-	4.93	4.19	3.35
Scan1	4.54	3.95	4.48	5.67	5.61	6.15
Scan2	4.34	4.25	4.83	4.78	4.26	4.40
BLE/Zigbee	2.41	2.21	2.01	-	-	-

\*The above Antenna information is declared by manufacturer and for more detailed features description, please refer to the manufacturer's specifications, the laboratory shall not be held responsible.

4. 2G traffic radio, 5G traffic radio, Scanning radio (5G) and BT LE technologies can transmit at same time.

\*2G traffic radio, 5G traffic radio, Scanning radio (5G) and Zigbee technologies can transmit at same time.

\*5GHz traffic radio and Scanning radio (5G) cannot transmit in the same band at same time.

\* BT LE and Zigbee cannot transmit in the same band at same time.

5. Spurious emission of the simultaneous operation (WLAN, BLE and Zigbee) has been evaluated and no non-compliance was found.

### 3.2 Description of Test Modes

#### For 5180 ~ 5240MHz:

4 channels are provided for 802.11a, 802.11n (HT20), 802.11ac (VHT20), 802.11ax (HE20):

Channel	Frequency	Channel	Frequency
36	5180 MHz	44	5220 MHz
40	5200 MHz	48	5240 MHz

2 channels are provided for 802.11n (HT40), 802.11ac (VHT40), 802.11ax (HE40):

Channel	Frequency	Channel	Frequency
38	5190 MHz	46	5230 MHz

1 channel is provided for 802.11ac (VHT80), 802.11ax (HE80):

Channel	Frequency
42	5210MHz

#### For 5745 ~ 5825MHz:

5 channels are provided for 802.11a, 802.11n (HT20), 802.11ac (VHT20), 802.11ax (HE20):

Channel	Frequency	Channel	Frequency
149	5745MHz	161	5805MHz
153	5765MHz	165	5825MHz
157	5785MHz		

2 channels are provided for 802.11n (HT40), 802.11ac (VHT40), 802.11ax (HE40):

Channel	Frequency	Channel	Frequency
151	5755MHz	159	5795MHz

1 channel is provided for 802.11ac (VHT80), 802.11ax (HE80):

Channel	Frequency
155	5775MHz

### 3.2.1 Test Mode Applicability and Tested Channel Detail

EUT Configure Mode	Applicable to				Description
	RE $\geq$ 1G	RE<1G	PLC	APCM	
A	√	√	√	√	Power from adapter
B	-	√	√	-	Power from PoE

Where RE $\geq$ 1G: Radiated Emission above 1GHz & Bandedge Measurement  
 RE<1G: Radiated Emission below 1GHz  
 PLC: Power Line Conducted Emission  
 APCM: Antenna Port Conducted Measurement

Note:

- The EUT had been pre-tested on the positioned of each 3 axis. The worst case was found when positioned on **Y-plane**.
- "-" means no effect.

#### Radiated Emission Test (Above 1GHz):

- Pre-Scan has been conducted to determine the worst-case mode from all possible combinations between available modulations, data rates and antenna ports (if EUT with antenna diversity architecture).
- Following channel(s) was (were) selected for the final test as listed below.

EUT Configure Mode	Mode	Frequency Band (MHz)	Available Channel	Tested Channel	Modulation Technology	Data Rate (Mbps)	Remark	
A	802.11a	5180-5240	36 to 48	36, 40, 48	OFDM	6.0	5G traffic radio	
A	802.11ax (HE20)		36 to 48	36, 40, 48	OFDMA	MCS0		
A	802.11ax (HE40)		38 to 46	38, 46	OFDMA	MCS0		
A	802.11ax (HE80)		42	42	OFDMA	MCS0		
A	802.11a		36 to 48	36, 40, 48	OFDM	6.0	Scanning radio	
A	802.11ac (VHT20)		36 to 48	36, 40, 48	OFDM	7.2		
A	802.11ac (VHT40)		38 to 46	38, 46	OFDM	15.0		
A	802.11ac (VHT80)		42	42	OFDM	29.3		
A	802.11a		5745-5825	149 to 165	149, 157, 165	OFDM	6.0	5G traffic radio
A	802.11ax (HE20)			149 to 165	149, 157, 165	OFDMA	MCS0	
A	802.11ax (HE40)	151 to 159		151, 159	OFDMA	MCS0		
A	802.11ax (HE80)	155		155	OFDMA	MCS0		
A	802.11a	149 to 165		149, 157, 165	OFDM	6.0	Scanning radio	
A	802.11ac (VHT20)	149 to 165		149, 157, 165	OFDM	7.2		
A	802.11ac (VHT40)	151 to 159		151, 159	OFDM	15.0		
A	802.11ac (VHT80)	155	155	OFDM	29.3			

#### Radiated Emission Test (Below 1GHz):

- Pre-Scan has been conducted to determine the worst-case mode from all possible combinations between available modulations, data rates and antenna ports (if EUT with antenna diversity architecture).
- Following channel(s) was (were) selected for the final test as listed below.

EUT Configure Mode	Mode	Frequency Band (MHz)	Available Channel	Tested Channel	Modulation Technology	Data Rate (Mbps)	Remark
A, B	802.11ax (HE20)	5180-5240	36 to 48	40	OFDMA	MCS0	5G traffic radio
		5745-5825	149 to 165				
A, B	802.11a	5180-5240	36 to 48	149	OFDM	6.0	Scanning radio
		5745-5825	149 to 165				

**Power Line Conducted Emission Test:**

- Pre-Scan has been conducted to determine the worst-case mode from all possible combinations between available modulations, data rates and antenna ports (if EUT with antenna diversity architecture).
- Following channel(s) was (were) selected for the final test as listed below.

EUT Configure Mode	Mode	Frequency Band (MHz)	Available Channel	Tested Channel	Modulation Technology	Data Rate (Mbps)	Remark
A, B	802.11ax (HE20)	5180-5240	36 to 48	40	OFDMA	MCS0	5G traffic radio
		5745-5825	149 to 165				
A, B	802.11a	5180-5240	36 to 48	149	OFDM	6.0	Scanning radio
		5745-5825	149 to 165				

**Antenna Port Conducted Measurement:**

- This item includes all test value of each mode, but only includes spectrum plot of worst value of each mode.
- Pre-Scan has been conducted to determine the worst-case mode from all possible combinations between available modulations, data rates and antenna ports (if EUT with antenna diversity architecture).
- Following channel(s) was (were) selected for the final test as listed below.

EUT Configure Mode	Mode	Frequency Band (MHz)	Available Channel	Tested Channel	Modulation Technology	Data Rate (Mbps)	Remark	
A	802.11a	5180-5240	36 to 48	36, 40, 48	OFDM	6.0	5G traffic radio	
A	802.11ax (HE20)		36 to 48	36, 40, 48	OFDMA	MCS0		
A	802.11ax (HE40)		38 to 46	38, 46	OFDMA	MCS0		
A	802.11ax (HE80)		42	42	OFDMA	MCS0		
A	802.11a		36 to 48	36, 40, 48	OFDM	6.0	Scanning radio	
A	802.11ac (VHT20)		36 to 48	36, 40, 48	OFDM	7.2		
A	802.11ac (VHT40)		38 to 46	38, 46	OFDM	15.0		
A	802.11ac (VHT80)		42	42	OFDM	29.3		
A	802.11a		5745-5825	149 to 165	149, 157, 165	OFDM	6.0	5G traffic radio
A	802.11ax (HE20)			149 to 165	149, 157, 165	OFDMA	MCS0	
A	802.11ax (HE40)	151 to 159		151, 159	OFDMA	MCS0		
A	802.11ax (HE80)	155		155	OFDMA	MCS0		
A	802.11a	149 to 165		149, 157, 165	OFDM	6.0	Scanning radio	
A	802.11ac (VHT20)	149 to 165		149, 157, 165	OFDM	7.2		
A	802.11ac (VHT40)	151 to 159		151, 159	OFDM	15.0		
A	802.11ac (VHT80)	155		155	OFDM	29.3		

**Test Condition:**

Applicable to	Environmental Conditions	Input Power	Tested by
RE $\geq$ 1G	23 deg. C, 66% RH 23 deg. C, 68% RH	120Vac, 60Hz	Titan Hsu, Willy Cheng
RE<1G	22 deg. C, 68% RH	120Vac, 60Hz 54Vdc	Edison Lee
PLC	23 deg. C, 66% RH	120Vac, 60Hz 54Vdc	Greg Lin
APCM	25 deg. C, 60% RH	120Vac, 60Hz	Alan Wu, Ted Chang

### 3.3 Duty Cycle of Test Signal

Duty cycle of test signal is < 98%, duty factor shall be considered.

#### 5G traffic radio:

802.11a: Duty cycle = 1.970/2.098 = 0.939, Duty factor =  $10 * \log(1/0.939) = 0.27$

802.11ax (HE20): Duty cycle = 5.440/5.695 = 0.955, Duty factor =  $10 * \log(1/0.955) = 0.20$

802.11ax (HE40): Duty cycle = 5.430/6.425 = 0.845, Duty factor =  $10 * \log(1/0.845) = 0.73$

802.11ax (HE80): Duty cycle = 5.415/5.705 = 0.949, Duty factor =  $10 * \log(1/0.949) = 0.23$

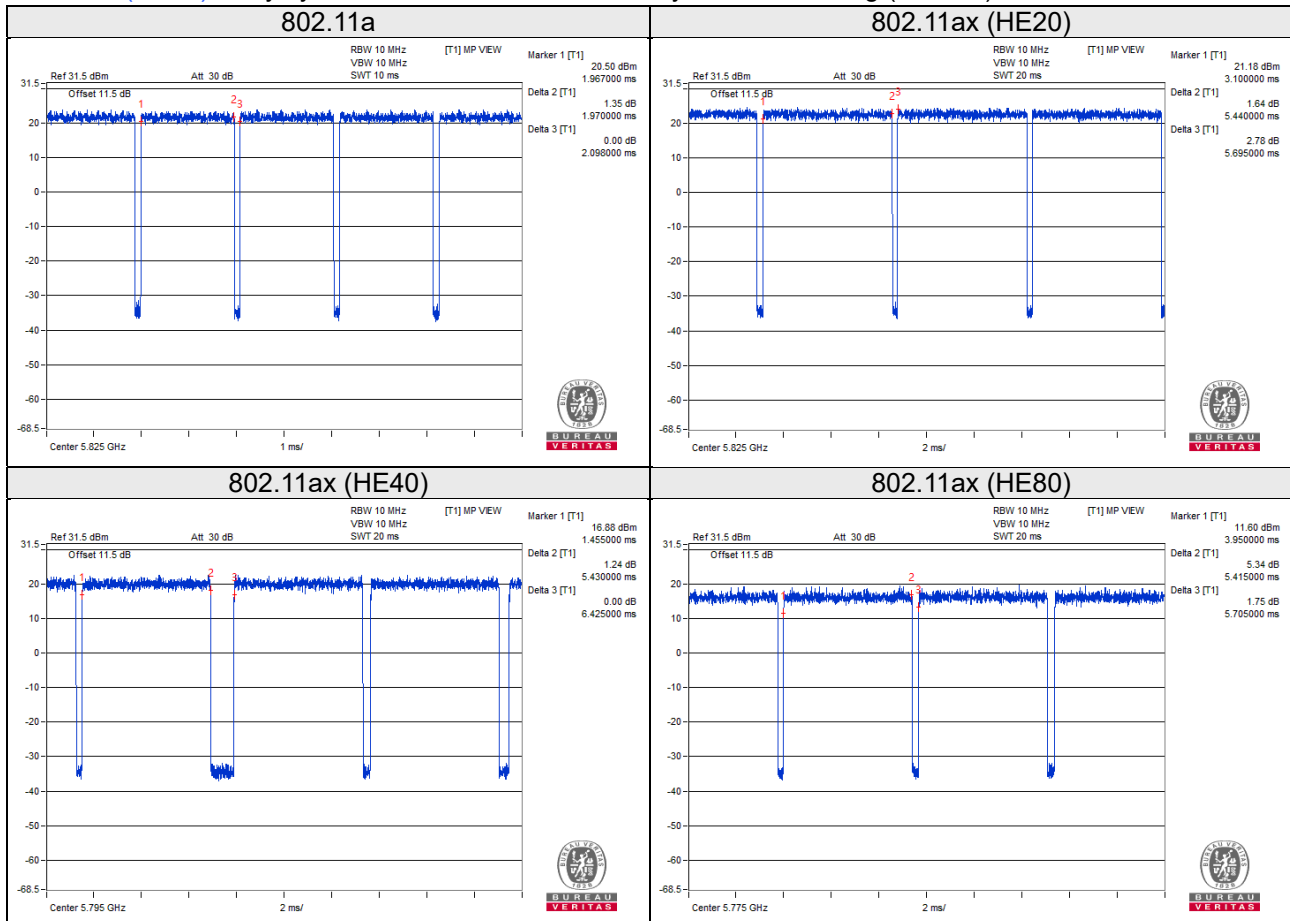

**Scanning radio:**

802.11a: Duty cycle =  $2.022/2.107 = 0.960$ , Duty factor =  $10 * \log(1/0.960) = 0.18$

802.11ac (VHT20): Duty cycle =  $1.882/1.962 = 0.959$ , Duty factor =  $10 * \log(1/0.959) = 0.18$

802.11ac (VHT40): Duty cycle =  $0.926/1.006 = 0.920$ , Duty factor =  $10 * \log(1/0.920) = 0.36$

802.11ac (VHT80): Duty cycle =  $0.454/0.541 = 0.839$ , Duty factor =  $10 * \log(1/0.839) = 0.76$

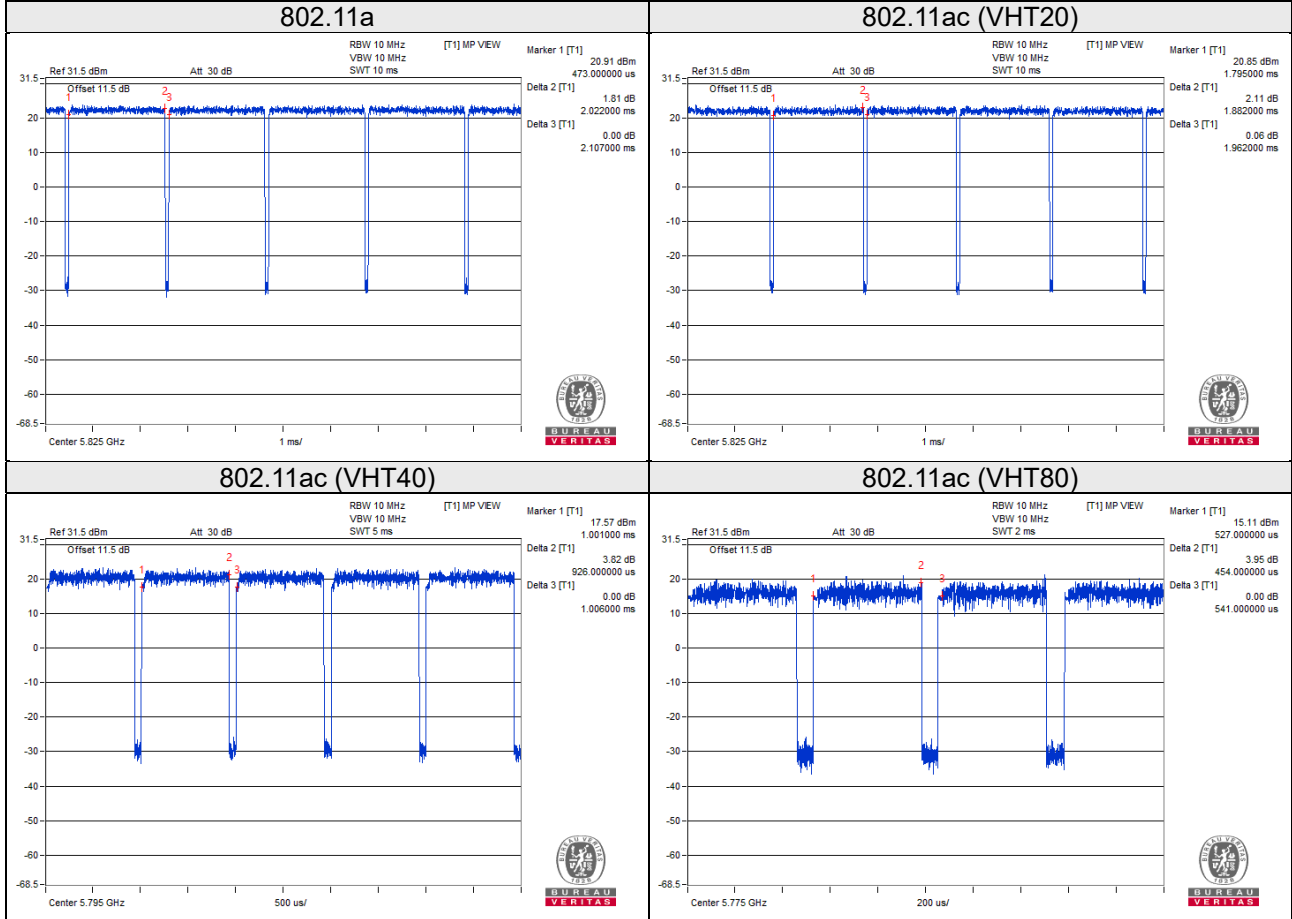

### 3.4 Description of Support Units

The EUT has been tested as an independent unit together with other necessary accessories or support units. The following support units or accessories were used to form a representative test configuration during the tests.

ID	Product	Brand	Model No.	Serial No.	FCC ID	Remarks
A.	Notebook	DELL	E5410	1HC2XM1	FCC DoC Approved	-
B.	Adapter	APD	WA-30J12R	NA	NA	Provided by client
C.	USB Flash	Sandisk	SDDDC-032G	NA	NA	-
D.	POE	EnGenius	EPA5006GAT	NA	NA	Provided by client

Note:

- All power cords of the above support units are non-shielded (1.8m).
- Item A acted as a communication partner to transfer data.

ID	Cable Descriptions	Qty.	Length (m)	Shielding (Yes/No)	Cores (Qty.)	Remarks
1.	LAN	1	7.0	N	0	RJ45, Cat5e
2.	Console cable	1	1.45	N	0	Provided by client
3.	Power cable	1	1.8	-	0	Provided by client
4.	LAN	1	1.5	N	0	RJ45, Cat5e

#### 3.4.1 Configuration of System under Test

Mode A

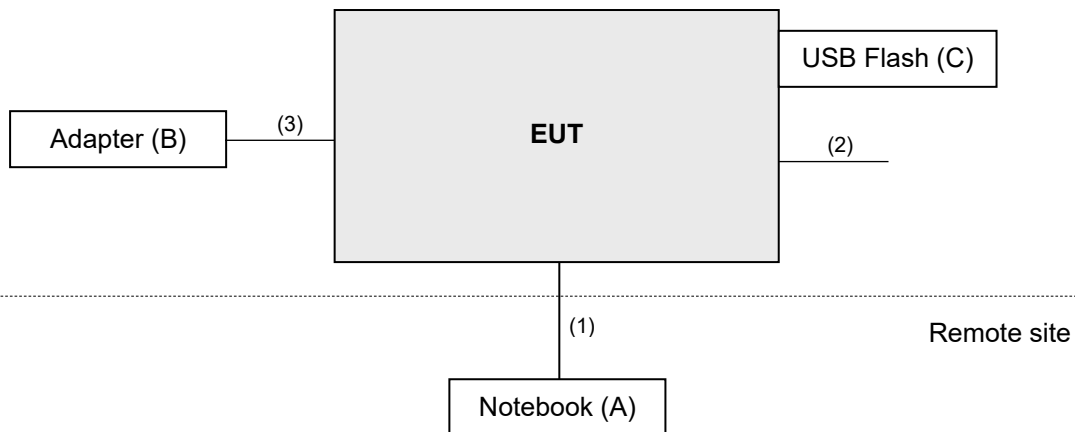

Mode B

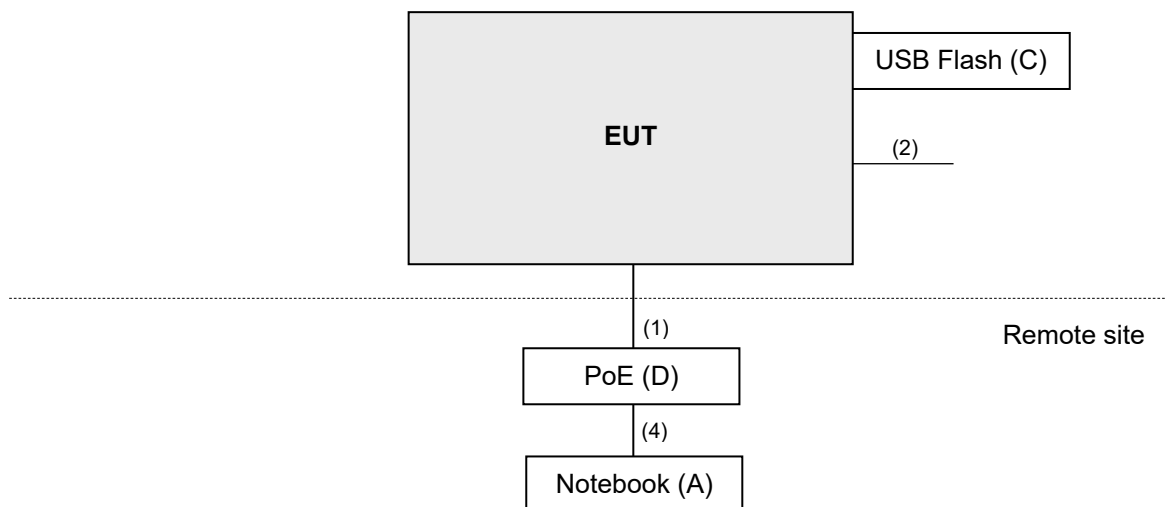

### **3.5 General Description of Applied Standards and References**

The EUT is a RF Product. According to the specifications of the manufacturer, it must comply with the requirements of the following standards and references:

**Test standard:**

**FCC Part 15, Subpart E (15.407)**

ANSI C63.10:2013

All test items have been performed and recorded as per the above standards.

**References Test Guidance:**

**KDB 789033 D02 General UNII Test Procedure New Rules v02r01**

**KDB 662911 D01 Multiple Transmitter Output v02r01**

All test items have been performed as a reference to the above KDB test guidance.



## 4 Test Types and Results

### 4.1 Radiated Emission and Bandedge Measurement

#### 4.1.1 Limits of Radiated Emission and Bandedge Measurement

Radiated emissions which fall in the restricted bands must comply with the radiated emission limits specified as below table.

Frequencies (MHz)	Field Strength (microvolts/meter)	Measurement Distance (meters)
0.009 ~ 0.490	2400/F(kHz)	300
0.490 ~ 1.705	24000/F(kHz)	30
1.705 ~ 30.0	30	30
30 ~ 88	100	3
88 ~ 216	150	3
216 ~ 960	200	3
Above 960	500	3

**NOTE:**

- The lower limit shall apply at the transition frequencies.
- Emission level (dBuV/m) = 20 log Emission level (uV/m).
- For frequencies above 1000MHz, the field strength limits are based on average detector, however, the peak field strength of any emission shall not exceed the maximum permitted average limits, specified above by more than 20dB under any condition of modulation.

**Limits of unwanted emission out of the restricted bands**

Applicable To		Limit	
789033 D02 General UNII Test Procedure New Rules v02r01		Field Strength at 3m	
		PK: 74 (dBµV/m)	AV: 54 (dBµV/m)
Frequency Band	Applicable To	EIRP Limit	Equivalent Field Strength at 3m
5150~5250 MHz	15.407(b)(1)	PK: -27 (dBm/MHz)	PK: 68.2(dBµV/m)
5250~5350 MHz	15.407(b)(2)		
5470~5725 MHz	15.407(b)(3)		
5725~5850 MHz	<input checked="" type="checkbox"/> 15.407(b)(4)(i)	PK: -27 (dBm/MHz) <sup>*1</sup> PK: 10 (dBm/MHz) <sup>*2</sup> PK: 15.6 (dBm/MHz) <sup>*3</sup> PK: 27 (dBm/MHz) <sup>*4</sup>	PK: 68.2 (dBµV/m) <sup>*1</sup> PK: 105.2 (dBµV/m) <sup>*2</sup> PK: 110.8 (dBµV/m) <sup>*3</sup> PK: 122.2 (dBµV/m) <sup>*4</sup>
	<input type="checkbox"/> 15.407(b)(4)(ii)	Emission limits in section 15.247(d)	
<sup>*1</sup> beyond 75 MHz or more above of the band edge. <sup>*3</sup> below the band edge increasing linearly to a level of 15.6 dBm/MHz at 5 MHz above.		<sup>*2</sup> below the band edge increasing linearly to 10 dBm/MHz at 25 MHz above. <sup>*4</sup> from 5 MHz above or below the band edge increasing linearly to a level of 27 dBm/MHz at the band edge.	

Note: The following formula is used to convert the equipment isotropic radiated power (eirp) to field strength:

$$E = \frac{1000000 \sqrt{30 P}}{3} \mu\text{V/m, where P is the eirp (Watts).$$

#### 4.1.2 Test Instruments

Description & Manufacturer	Model No.	Serial No.	Cal. Date	Cal. Due
Test Receiver ROHDE & SCHWARZ	ESR3	102579	Jul. 07, 2020	Jul. 06, 2021
Spectrum Analyzer ROHDE & SCHWARZ	FSP40	100269	Jun. 09, 2020	Jun. 08, 2021
BILOG Antenna SCHWARZBECK	VULB9168	9168-171	Nov. 04, 2020	Nov. 03, 2021
HORN Antenna SCHWARZBECK	9120D	209	Nov. 24, 2019	Nov. 23, 2020
			Nov. 22, 2020	Nov. 21, 2021
HORN Antenna SCHWARZBECK	BBHA 9170	BBHA9170241	Nov. 24, 2019	Nov. 23, 2020
			Nov. 22, 2020	Nov. 21, 2021
Loop Antenna TESEQ	HLA 6121	45745	Jul. 06, 2020	Jul. 05, 2021
Preamplifier Agilent (Below 1GHz)	8447D	2944A10738	Aug. 16, 2020	Aug. 15, 2021
Preamplifier Agilent (Above 1GHz)	8449B	3008A02465	Mar. 23, 2020	Mar. 22, 2021
RF Coaxial Cable WOKEN With 5dB PAD	8D-FB	Cable-CH3-01	Aug. 16, 2020	Aug. 15, 2021
RF signal cable HUBER+SUHNER	SUCOFLEX 104	Cable-CH3-03 (223653/4)	Aug. 16, 2020	Aug. 15, 2021
RF signal cable HUBER+SUHNER& EMCI	SUCOFLEX 104&EMC104-SM-S M-8000	Cable-CH3-03 (309224+170907)	Aug. 16, 2020	Aug. 15, 2021
Software BV ADT	ADT_Radiated_ V7.6.15.9.5	NA	NA	NA
Antenna Tower inn-co GmbH	MA 4000	013303	NA	NA
Antenna Tower Controller BV ADT	AT100	AT93021702	NA	NA
Turn Table BV ADT	TT100	TT93021702	NA	NA
Turn Table Controller BV ADT	SC100	SC93021702	NA	NA
Boresight Antenna Fixture	FBA-01	FBA-SIP01	NA	NA
Pre-amplifier (18GHz-40GHz) EMC	EMC184045B	980175	Sep. 04, 2020	Sep. 03, 2021
USB Wideband Power Sensor KEYSIGHT	U2021XA	MY55050005/MY5519 0004/MY55190007/MY 55210005	Jul. 13, 2020	Jul. 12, 2021

Note: 1. The calibration interval of the above test instruments is 12 months and the calibrations are traceable to NML/ROC and NIST/USA.  
2. The test was performed in HwaYa Chamber 3.

### 4.1.3 Test Procedures

#### For Radiated emission below 30MHz

- a. The EUT was placed on the top of a rotating table 0.8 meters above the ground at a 3 meter chamber room. The table was rotated 360 degrees to determine the position of the highest radiation.
- b. The EUT was set 3 meters away from the interference-receiving antenna, which was mounted on the top of a variable-height antenna tower.
- c. Parallel, perpendicular, and ground-parallel orientations of the antenna are set to make the measurement.
- d. For each suspected emission, the EUT was arranged to its worst case and the rotatable table was turned from 0 degrees to 360 degrees to find the maximum reading.
- e. The test-receiver system was set to Quasi-Peak Detect Function and Specified Bandwidth with Maximum Hold Mode.

#### Note:

1. The resolution bandwidth and video bandwidth of test receiver/spectrum analyzer is 9kHz at frequency below 30MHz.

#### For Radiated emission above 30MHz

- a. The EUT was placed on the top of a rotating table 0.8 meters (for 30MHz ~ 1GHz) / 1.5 meters (for above 1GHz) above the ground at 3 meter chamber room for test. The table was rotated 360 degrees to determine the position of the highest radiation.
- b. The EUT was set 3 meters away from the interference-receiving antenna, which was mounted on the top of a variable-height antenna tower.
- c. The height of antenna is varied from one meter to four meters above the ground to determine the maximum value of the field strength. Both horizontal and vertical polarizations of the antenna are set to make the measurement.
- d. For each suspected emission, the EUT was arranged to its worst case and then the antenna was tuned to heights from 1 meter to 4 meters and the rotatable table was turned from 0 degrees to 360 degrees to find the maximum reading.
- e. The test-receiver system was set to quasi-peak detect function and specified bandwidth with maximum hold mode when the test frequency is below 1 GHz.
- f. The test-receiver system was set to peak and average detect function and specified bandwidth with maximum hold mode when the test frequency is above 1 GHz. If the peak reading value also meets average limit, measurement with the average detector is unnecessary.

#### Note:

1. The resolution bandwidth and video bandwidth of test receiver/spectrum analyzer is 120kHz for Quasi-peak detection (QP) at frequency below 1GHz.
2. The resolution bandwidth of test receiver/spectrum analyzer is 1 MHz and the video bandwidth is 3 MHz for Peak detection (PK) at frequency above 1GHz.
3. The resolution bandwidth of test receiver/spectrum analyzer is 1MHz and the video bandwidth is  $\geq 1/T$  (Duty cycle < 98%) or 10Hz (Duty cycle  $\geq 98\%$ ) for Average detection (AV) at frequency above 1GHz.  
**5G traffic radio:** 802.11a: RBW = 1MHz, VBW = 1kHz; 802.11ax (HE20): RBW = 1MHz, VBW = 1kHz; 802.11ax (HE40): RBW = 1MHz, VBW = 1kHz; 802.11ax (HE80): RBW = 1MHz, VBW = 1kHz;  
**Scanning radio:** 802.11a: RBW = 1MHz, VBW = 1kHz; 802.11ac (VHT20): RBW = 1MHz, VBW = 1kHz; 802.11ac (VHT40): RBW = 1MHz, VBW = 3kHz; 802.11ac (VHT80): RBW = 1MHz, VBW = 3kHz
4. All modes of operation were investigated and the worst-case emissions are reported.

#### 4.1.4 Deviation from Test Standard

No deviation.

#### 4.1.5 Test Setup

##### For Radiated emission below 30MHz

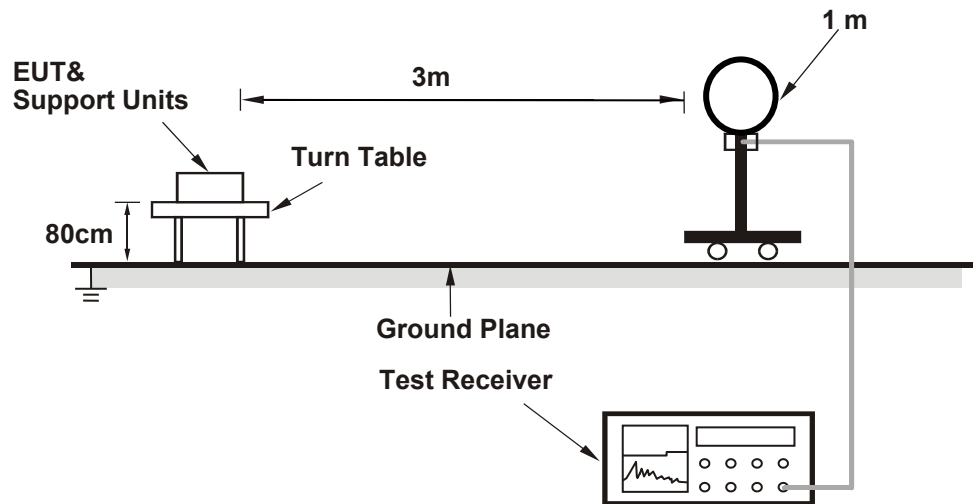

##### For Radiated emission 30MHz to 1GHz

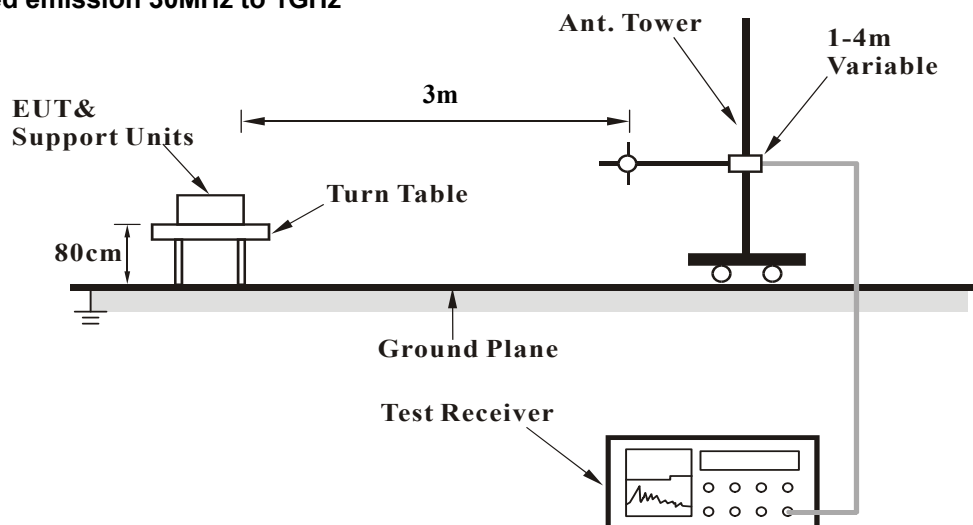

### For Radiated emission above 1GHz

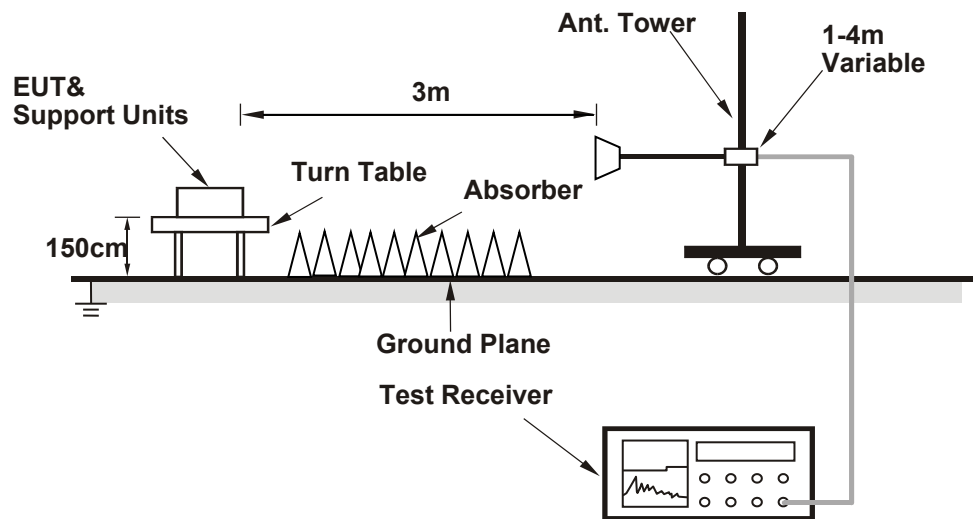

For the actual test configuration, please refer to the attached file (Test Setup Photo).

#### 4.1.6 EUT Operating Conditions

- Placed the EUT on the testing table.
- Prepared a notebook to act as a communication partner and placed it outside of testing area.
- The communication partner connected with EUT via a RJ45 cable and ran a test program (provided by manufacturer) to enable EUT under transmission condition continuously at specific channel frequency.
- The communication partner sent data to EUT by command "PING".

#### 4.1.7 Test Results

Above 1GHz data:

**5G traffic radio:**

802.11a

CHANNEL	TX Channel 36	DETECTOR FUNCTION	Peak (PK)
FREQUENCY RANGE	1GHz ~ 40GHz		Average (AV)

Antenna Polarity & Test Distance : Horizontal at 3 m								
No	Frequency (MHz)	Emission Level (dBuV/m)	Limit (dBuV/m)	Margin (dB)	Antenna Height (m)	Table Angle (Degree)	Raw Value (dBuV)	Correction Factor (dB/m)
1	5150.00	70.4 PK	74.0	-3.6	1.17 H	324	63.9	6.5
2	<b>5150.00</b>	<b>53.0 AV</b>	<b>54.0</b>	<b>-1.0</b>	<b>1.17 H</b>	<b>324</b>	<b>46.5</b>	<b>6.5</b>
3	*5180.00	120.5 PK			1.65 H	323	78.4	42.1
4	*5180.00	109.4 AV			1.65 H	323	67.3	42.1
5	#10360.00	59.9 PK	68.2	-8.3	1.38 H	317	43.3	16.6
Antenna Polarity & Test Distance : Vertical at 3 m								
No	Frequency (MHz)	Emission Level (dBuV/m)	Limit (dBuV/m)	Margin (dB)	Antenna Height (m)	Table Angle (Degree)	Raw Value (dBuV)	Correction Factor (dB/m)
1	5150.00	70.2 PK	74.0	-3.8	1.27 V	288	63.7	6.5
2	5150.00	52.5 AV	54.0	-1.5	1.27 V	288	46.0	6.5
3	*5180.00	119.4 PK			1.08 V	290	77.3	42.1
4	*5180.00	108.5 AV			1.08 V	290	66.4	42.1
5	#10360.00	60.3 PK	68.2	-7.9	1.00 V	281	43.7	16.6

Remarks:

1. Emission Level(dBuV/m) = Raw Value(dBuV) + Correction Factor(dB/m)
2. Correction Factor(dB/m) = Antenna Factor(dB/m) + Cable Factor(dB) – Pre-Amplifier Factor(dB)
3. The other emission levels were very low against the limit.
4. Margin value = Emission Level – Limit value
5. " \* ": Fundamental frequency.
6. " # ": The radiated frequency is out of the restricted band.

CHANNEL	TX Channel 40	DETECTOR	Peak (PK)
FREQUENCY RANGE	1GHz ~ 40GHz	FUNCTION	Average (AV)

Antenna Polarity & Test Distance : Horizontal at 3 m								
No	Frequency (MHz)	Emission Level (dBuV/m)	Limit (dBuV/m)	Margin (dB)	Antenna Height (m)	Table Angle (Degree)	Raw Value (dBuV)	Correction Factor (dB/m)
1	*5200.00	121.6 PK			1.22 H	326	79.5	42.1
2	*5200.00	110.9 AV			1.22 H	326	68.8	42.1
3	#10400.00	60.1 PK	68.2	-8.1	1.43 H	317	43.2	16.9
Antenna Polarity & Test Distance : Vertical at 3 m								
No	Frequency (MHz)	Emission Level (dBuV/m)	Limit (dBuV/m)	Margin (dB)	Antenna Height (m)	Table Angle (Degree)	Raw Value (dBuV)	Correction Factor (dB/m)
1	*5200.00	120.0 PK			1.16 V	290	77.9	42.1
2	*5200.00	110.1 AV			1.16 V	290	68.0	42.1
3	#10400.00	60.3 PK	68.2	-7.9	1.48 V	294	43.4	16.9

Remarks:

1. Emission Level(dBuV/m) = Raw Value(dBuV) + Correction Factor(dB/m)
2. Correction Factor(dB/m) = Antenna Factor(dB/m) + Cable Factor(dB) – Pre-Amplifier Factor(dB)
3. The other emission levels were very low against the limit.
4. Margin value = Emission Level – Limit value
5. " \* ": Fundamental frequency.
6. " # ": The radiated frequency is out of the restricted band.

CHANNEL	TX Channel 48	DETECTOR	Peak (PK)
FREQUENCY RANGE	1GHz ~ 40GHz	FUNCTION	Average (AV)

Antenna Polarity & Test Distance : Horizontal at 3 m								
No	Frequency (MHz)	Emission Level (dBuV/m)	Limit (dBuV/m)	Margin (dB)	Antenna Height (m)	Table Angle (Degree)	Raw Value (dBuV)	Correction Factor (dB/m)
1	*5240.00	120.4 PK			1.51 H	299	78.5	41.9
2	*5240.00	109.3 AV			1.51 H	299	67.4	41.9
3	5350.00	58.2 PK	74.0	-15.8	1.65 H	302	51.9	6.3
4	5350.00	45.7 AV	54.0	-8.3	1.65 H	302	39.4	6.3
5	#10480.00	59.9 PK	68.2	-8.3	1.00 H	261	42.4	17.5

Antenna Polarity & Test Distance : Vertical at 3 m								
No	Frequency (MHz)	Emission Level (dBuV/m)	Limit (dBuV/m)	Margin (dB)	Antenna Height (m)	Table Angle (Degree)	Raw Value (dBuV)	Correction Factor (dB/m)
1	*5240.00	118.6 PK			1.16 V	296	76.7	41.9
2	*5240.00	108.1 AV			1.16 V	296	66.2	41.9
3	5350.00	58.7 PK	74.0	-15.3	1.28 V	284	52.4	6.3
4	5350.00	45.5 AV	54.0	-8.5	1.28 V	284	39.2	6.3
5	#10480.00	59.7 PK	68.2	-8.5	1.46 V	281	42.2	17.5

Remarks:

1. Emission Level(dBuV/m) = Raw Value(dBuV) + Correction Factor(dB/m)
2. Correction Factor(dB/m) = Antenna Factor(dB/m) + Cable Factor(dB) – Pre-Amplifier Factor(dB)
3. The other emission levels were very low against the limit.
4. Margin value = Emission Level – Limit value
5. " \* ": Fundamental frequency.
6. " # ": The radiated frequency is out of the restricted band.



CHANNEL	TX Channel 149	DETECTOR FUNCTION	Peak (PK)
FREQUENCY RANGE	1GHz ~ 40GHz		Average (AV)

Antenna Polarity & Test Distance : Horizontal at 3 m								
No	Frequency (MHz)	Emission Level (dBuV/m)	Limit (dBuV/m)	Margin (dB)	Antenna Height (m)	Table Angle (Degree)	Raw Value (dBuV)	Correction Factor (dB/m)
1	#5635.26	58.8 PK	68.2	-9.4	1.25 H	330	52.6	6.2
2	*5745.00	117.9 PK			1.25 H	330	75.9	42.0
3	*5745.00	107.4 AV			1.25 H	330	65.4	42.0
4	#5942.31	59.3 PK	68.2	-8.9	1.25 H	330	52.3	7.0
5	11490.00	60.2 PK	74.0	-13.8	1.00 H	299	42.2	18.0
6	11490.00	48.3 AV	54.0	-5.7	1.00 H	299	30.3	18.0

Antenna Polarity & Test Distance : Vertical at 3 m								
No	Frequency (MHz)	Emission Level (dBuV/m)	Limit (dBuV/m)	Margin (dB)	Antenna Height (m)	Table Angle (Degree)	Raw Value (dBuV)	Correction Factor (dB/m)
1	#5642.31	58.3 PK	68.2	-9.9	1.30 V	283	52.1	6.2
2	*5745.00	117.3 PK			1.30 V	283	75.3	42.0
3	*5745.00	106.6 AV			1.30 V	283	64.6	42.0
4	#5966.67	59.6 PK	68.2	-8.6	1.30 V	283	52.7	6.9
5	11490.00	60.2 PK	74.0	-13.8	1.39 V	77	42.2	18.0
6	11490.00	47.0 AV	54.0	-7.0	1.39 V	77	29.0	18.0

Remarks:

1. Emission Level(dBuV/m) = Raw Value(dBuV) + Correction Factor(dB/m)
2. Correction Factor(dB/m) = Antenna Factor(dB/m) + Cable Factor(dB) – Pre-Amplifier Factor(dB)
3. The other emission levels were very low against the limit.
4. Margin value = Emission Level – Limit value
5. " \* ": Fundamental frequency.
6. " # ": The radiated frequency is out of the restricted band.

CHANNEL	TX Channel 157	DETECTOR FUNCTION	Peak (PK)
FREQUENCY RANGE	1GHz ~ 40GHz		Average (AV)

Antenna Polarity & Test Distance : Horizontal at 3 m								
No	Frequency (MHz)	Emission Level (dBuV/m)	Limit (dBuV/m)	Margin (dB)	Antenna Height (m)	Table Angle (Degree)	Raw Value (dBuV)	Correction Factor (dB/m)
1	#5620.51	58.3 PK	68.2	-9.9	1.33 H	304	52.2	6.1
2	*5785.00	118.1 PK			1.33 H	304	76.2	41.9
3	*5785.00	107.6 AV			1.33 H	304	65.7	41.9
4	#5960.26	60.2 PK	68.2	-8.0	1.33 H	304	53.2	7.0
5	11570.00	60.1 PK	74.0	-13.9	1.01 H	302	42.5	17.6
6	11570.00	48.4 AV	54.0	-5.6	1.01 H	302	30.8	17.6

Antenna Polarity & Test Distance : Vertical at 3 m								
No	Frequency (MHz)	Emission Level (dBuV/m)	Limit (dBuV/m)	Margin (dB)	Antenna Height (m)	Table Angle (Degree)	Raw Value (dBuV)	Correction Factor (dB/m)
1	#5610.26	58.0 PK	68.2	-10.2	1.47 V	280	51.9	6.1
2	*5785.00	117.6 PK			1.47 V	280	75.7	41.9
3	*5785.00	107.2 AV			1.47 V	280	65.3	41.9
4	#5994.23	58.4 PK	68.2	-9.8	1.47 V	280	51.5	6.9
5	11570.00	59.7 PK	74.0	-14.3	1.52 V	78	42.1	17.6
6	11570.00	46.8 AV	54.0	-7.2	1.52 V	78	29.2	17.6

Remarks:

1. Emission Level(dBuV/m) = Raw Value(dBuV) + Correction Factor(dB/m)
2. Correction Factor(dB/m) = Antenna Factor(dB/m) + Cable Factor(dB) – Pre-Amplifier Factor(dB)
3. The other emission levels were very low against the limit.
4. Margin value = Emission Level – Limit value
5. " \* ": Fundamental frequency.
6. " # ": The radiated frequency is out of the restricted band.

CHANNEL	TX Channel 165	DETECTOR FUNCTION	Peak (PK)
FREQUENCY RANGE	1GHz ~ 40GHz		Average (AV)

Antenna Polarity & Test Distance : Horizontal at 3 m								
No	Frequency (MHz)	Emission Level (dBuV/m)	Limit (dBuV/m)	Margin (dB)	Antenna Height (m)	Table Angle (Degree)	Raw Value (dBuV)	Correction Factor (dB/m)
1	#5620.51	58.3 PK	68.2	-9.9	1.33 H	304	52.2	6.1
2	*5825.00	118.8 PK			1.36 H	307	76.6	42.2
3	*5825.00	108.2 AV			1.36 H	307	66.0	42.2
4	#5960.26	60.2 PK	68.2	-8.0	1.33 H	304	53.2	7.0
5	11650.00	60.4 PK	74.0	-13.6	1.00 H	301	42.7	17.7
6	11650.00	47.9 AV	54.0	-6.1	1.00 H	301	30.2	17.7

Antenna Polarity & Test Distance : Vertical at 3 m								
No	Frequency (MHz)	Emission Level (dBuV/m)	Limit (dBuV/m)	Margin (dB)	Antenna Height (m)	Table Angle (Degree)	Raw Value (dBuV)	Correction Factor (dB/m)
1	#5610.26	58.0 PK	68.2	-10.2	1.47 V	280	51.9	6.1
2	*5825.00	117.9 PK			1.53 V	283	75.7	42.2
3	*5825.00	107.6 AV			1.53 V	283	65.4	42.2
4	#5994.23	58.4 PK	68.2	-9.8	1.47 V	280	51.5	6.9
5	11650.00	60.3 PK	74.0	-13.7	1.44 V	68	42.6	17.7
6	11650.00	46.7 AV	54.0	-7.3	1.44 V	68	29.0	17.7

Remarks:

1. Emission Level(dBuV/m) = Raw Value(dBuV) + Correction Factor(dB/m)
2. Correction Factor(dB/m) = Antenna Factor(dB/m) + Cable Factor(dB) – Pre-Amplifier Factor(dB)
3. The other emission levels were very low against the limit.
4. Margin value = Emission Level – Limit value
5. " \* ": Fundamental frequency.
6. " # ": The radiated frequency is out of the restricted band.

802.11ax (HE20)

CHANNEL	TX Channel 36	DETECTOR FUNCTION	Peak (PK)
FREQUENCY RANGE	1GHz ~ 40GHz		Average (AV)

Antenna Polarity & Test Distance : Horizontal at 3 m								
No	Frequency (MHz)	Emission Level (dBuV/m)	Limit (dBuV/m)	Margin (dB)	Antenna Height (m)	Table Angle (Degree)	Raw Value (dBuV)	Correction Factor (dB/m)
1	5150.00	70.1 PK	74.0	-3.9	1.60 H	322	63.6	6.5
2	5150.00	52.4 AV	54.0	-1.6	1.60 H	322	45.9	6.5
3	*5180.00	121.2 PK			1.06 H	324	79.1	42.1
4	*5180.00	107.5 AV			1.06 H	324	65.4	42.1
5	#10360.00	59.0 PK	68.2	-9.2	2.04 H	283	42.4	16.6

Antenna Polarity & Test Distance : Vertical at 3 m								
No	Frequency (MHz)	Emission Level (dBuV/m)	Limit (dBuV/m)	Margin (dB)	Antenna Height (m)	Table Angle (Degree)	Raw Value (dBuV)	Correction Factor (dB/m)
1	5150.00	70.5 PK	74.0	-3.5	1.29 V	291	64.0	6.5
2	5150.00	50.9 AV	54.0	-3.1	1.29 V	291	44.4	6.5
3	*5180.00	120.7 PK			1.13 V	287	78.6	42.1
4	*5180.00	107.1 AV			1.13 V	287	65.0	42.1
5	#10360.00	59.8 PK	68.2	-8.4	1.49 V	278	43.2	16.6

Remarks:

1. Emission Level(dBuV/m) = Raw Value(dBuV) + Correction Factor(dB/m)
2. Correction Factor(dB/m) = Antenna Factor(dB/m) + Cable Factor(dB) – Pre-Amplifier Factor(dB)
3. The other emission levels were very low against the limit.
4. Margin value = Emission Level – Limit value
5. " \* ": Fundamental frequency.
6. " # ": The radiated frequency is out of the restricted band.

CHANNEL	TX Channel 40	DETECTOR	Peak (PK)
FREQUENCY RANGE	1GHz ~ 40GHz	FUNCTION	Average (AV)

Antenna Polarity & Test Distance : Horizontal at 3 m

No	Frequency (MHz)	Emission Level (dBuV/m)	Limit (dBuV/m)	Margin (dB)	Antenna Height (m)	Table Angle (Degree)	Raw Value (dBuV)	Correction Factor (dB/m)
1	*5200.00	122.5 PK			1.48 H	302	80.4	42.1
2	*5200.00	109.1 AV			1.48 H	302	67.0	42.1
3	#10400.00	59.9 PK	68.2	-8.3	1.00 H	264	43.0	16.9

Antenna Polarity & Test Distance : Vertical at 3 m

No	Frequency (MHz)	Emission Level (dBuV/m)	Limit (dBuV/m)	Margin (dB)	Antenna Height (m)	Table Angle (Degree)	Raw Value (dBuV)	Correction Factor (dB/m)
1	*5200.00	121.8 PK			1.19 V	297	79.7	42.1
2	*5200.00	108.1 AV			1.19 V	297	66.0	42.1
3	#10400.00	59.8 PK	68.2	-8.4	1.48 V	282	42.9	16.9

Remarks:

1. Emission Level(dBuV/m) = Raw Value(dBuV) + Correction Factor(dB/m)
2. Correction Factor(dB/m) = Antenna Factor(dB/m) + Cable Factor(dB) – Pre-Amplifier Factor(dB)
3. The other emission levels were very low against the limit.
4. Margin value = Emission Level – Limit value
5. " \* ": Fundamental frequency.
6. " # ": The radiated frequency is out of the restricted band.

CHANNEL	TX Channel 48	DETECTOR	Peak (PK)
FREQUENCY RANGE	1GHz ~ 40GHz	FUNCTION	Average (AV)

## Antenna Polarity &amp; Test Distance : Horizontal at 3 m

No	Frequency (MHz)	Emission Level (dBuV/m)	Limit (dBuV/m)	Margin (dB)	Antenna Height (m)	Table Angle (Degree)	Raw Value (dBuV)	Correction Factor (dB/m)
1	*5240.00	121.3 PK			1.39 H	324	79.4	41.9
2	*5240.00	107.9 AV			1.39 H	324	66.0	41.9
3	5350.00	57.6 PK	74.0	-16.4	1.46 H	302	51.3	6.3
4	5350.00	44.8 AV	54.0	-9.2	1.46 H	302	38.5	6.3
5	#10480.00	60.3 PK	68.2	-7.9	1.00 H	347	42.8	17.5

## Antenna Polarity &amp; Test Distance : Vertical at 3 m

No	Frequency (MHz)	Emission Level (dBuV/m)	Limit (dBuV/m)	Margin (dB)	Antenna Height (m)	Table Angle (Degree)	Raw Value (dBuV)	Correction Factor (dB/m)
1	*5240.00	120.3 PK			1.18 V	297	78.4	41.9
2	*5240.00	106.6 AV			1.18 V	297	64.7	41.9
3	5350.00	57.9 PK	74.0	-16.1	1.35 V	298	51.6	6.3
4	5350.00	45.7 AV	54.0	-8.3	1.35 V	298	39.4	6.3
5	#10480.00	59.9 PK	68.2	-8.3	1.40 V	286	42.4	17.5

## Remarks:

1. Emission Level(dBuV/m) = Raw Value(dBuV) + Correction Factor(dB/m)
2. Correction Factor(dB/m) = Antenna Factor(dB/m) + Cable Factor(dB) – Pre-Amplifier Factor(dB)
3. The other emission levels were very low against the limit.
4. Margin value = Emission Level – Limit value
5. " \* ": Fundamental frequency.
6. " # ": The radiated frequency is out of the restricted band.

CHANNEL	TX Channel 149	DETECTOR FUNCTION	Peak (PK)
FREQUENCY RANGE	1GHz ~ 40GHz		Average (AV)

Antenna Polarity & Test Distance : Horizontal at 3 m								
No	Frequency (MHz)	Emission Level (dBuV/m)	Limit (dBuV/m)	Margin (dB)	Antenna Height (m)	Table Angle (Degree)	Raw Value (dBuV)	Correction Factor (dB/m)
1	#5628.21	57.0 PK	68.2	-11.2	1.25 H	329	50.9	6.1
2	*5745.00	121.0 PK			1.25 H	329	79.0	42.0
3	*5745.00	107.0 AV			1.25 H	329	65.0	42.0
4	#5962.18	58.5 PK	68.2	-9.7	1.25 H	329	51.5	7.0
5	11490.00	60.0 PK	74.0	-14.0	1.24 H	301	42.0	18.0
6	11490.00	47.8 AV	54.0	-6.2	1.24 H	301	29.8	18.0

Antenna Polarity & Test Distance : Vertical at 3 m								
No	Frequency (MHz)	Emission Level (dBuV/m)	Limit (dBuV/m)	Margin (dB)	Antenna Height (m)	Table Angle (Degree)	Raw Value (dBuV)	Correction Factor (dB/m)
1	#5642.95	58.5 PK	68.2	-9.7	1.31 V	284	52.3	6.2
2	*5745.00	120.5 PK			1.31 V	284	78.5	42.0
3	*5745.00	106.4 AV			1.31 V	284	64.4	42.0
4	#5970.51	59.1 PK	68.2	-9.1	1.31 V	284	52.2	6.9
5	11490.00	60.3 PK	74.0	-13.7	1.86 V	349	42.3	18.0
6	11490.00	46.2 AV	54.0	-7.8	1.86 V	349	28.2	18.0

Remarks:

1. Emission Level(dBuV/m) = Raw Value(dBuV) + Correction Factor(dB/m)
2. Correction Factor(dB/m) = Antenna Factor(dB/m) + Cable Factor(dB) – Pre-Amplifier Factor(dB)
3. The other emission levels were very low against the limit.
4. Margin value = Emission Level – Limit value
5. " \* ": Fundamental frequency.
6. " # ": The radiated frequency is out of the restricted band.

CHANNEL	TX Channel 157	DETECTOR FUNCTION	Peak (PK)
FREQUENCY RANGE	1GHz ~ 40GHz		Average (AV)

## Antenna Polarity &amp; Test Distance : Horizontal at 3 m

No	Frequency (MHz)	Emission Level (dBuV/m)	Limit (dBuV/m)	Margin (dB)	Antenna Height (m)	Table Angle (Degree)	Raw Value (dBuV)	Correction Factor (dB/m)
1	#5650.00	57.7 PK	68.2	-10.5	1.32 H	305	51.6	6.1
2	*5785.00	121.8 PK			1.32 H	305	79.9	41.9
3	*5785.00	107.5 AV			1.32 H	305	65.6	41.9
4	#5960.26	59.1 PK	68.2	-9.1	1.32 H	305	52.1	7.0
5	11570.00	59.7 PK	74.0	-14.3	1.21 H	306	42.1	17.6
6	11570.00	47.5 AV	54.0	-6.5	1.21 H	306	29.9	17.6

## Antenna Polarity &amp; Test Distance : Vertical at 3 m

No	Frequency (MHz)	Emission Level (dBuV/m)	Limit (dBuV/m)	Margin (dB)	Antenna Height (m)	Table Angle (Degree)	Raw Value (dBuV)	Correction Factor (dB/m)
1	#5625.00	58.4 PK	68.2	-9.8	1.46 V	282	52.3	6.1
2	*5785.00	120.7 PK			1.46 V	282	78.8	41.9
3	*5785.00	107.4 AV			1.46 V	282	65.5	41.9
4	#5928.21	59.0 PK	68.2	-9.2	1.46 V	282	52.0	7.0
5	11570.00	60.0 PK	74.0	-14.0	1.83 V	199	42.4	17.6
6	11570.00	45.9 AV	54.0	-8.1	1.83 V	199	28.3	17.6

## Remarks:

1. Emission Level(dBuV/m) = Raw Value(dBuV) + Correction Factor(dB/m)
2. Correction Factor(dB/m) = Antenna Factor(dB/m) + Cable Factor(dB) – Pre-Amplifier Factor(dB)
3. The other emission levels were very low against the limit.
4. Margin value = Emission Level – Limit value
5. " \* ": Fundamental frequency.
6. " # ": The radiated frequency is out of the restricted band.



CHANNEL	TX Channel 165	DETECTOR FUNCTION	Peak (PK)
FREQUENCY RANGE	1GHz ~ 40GHz		Average (AV)

Antenna Polarity & Test Distance : Horizontal at 3 m								
No	Frequency (MHz)	Emission Level (dBuV/m)	Limit (dBuV/m)	Margin (dB)	Antenna Height (m)	Table Angle (Degree)	Raw Value (dBuV)	Correction Factor (dB/m)
1	#5630.13	57.8 PK	68.2	-10.4	1.38 H	308	51.7	6.1
2	*5825.00	121.8 PK			1.38 H	308	79.6	42.2
3	*5825.00	108.2 AV			1.38 H	308	66.0	42.2
4	#5932.05	59.1 PK	68.2	-9.1	1.38 H	308	52.1	7.0
5	11650.00	59.8 PK	74.0	-14.2	1.06 H	321	42.1	17.7
6	11650.00	47.9 AV	54.0	-6.1	1.06 H	321	30.2	17.7

Antenna Polarity & Test Distance : Vertical at 3 m								
No	Frequency (MHz)	Emission Level (dBuV/m)	Limit (dBuV/m)	Margin (dB)	Antenna Height (m)	Table Angle (Degree)	Raw Value (dBuV)	Correction Factor (dB/m)
1	#5630.13	58.3 PK	68.2	-9.9	1.52 V	280	52.2	6.1
2	*5825.00	120.9 PK			1.52 V	280	78.7	42.2
3	*5825.00	107.2 AV			1.52 V	280	65.0	42.2
4	#5954.49	58.7 PK	68.2	-9.5	1.52 V	280	51.7	7.0
5	11650.00	59.9 PK	74.0	-14.1	1.88 V	342	42.2	17.7
6	11650.00	45.8 AV	54.0	-8.2	1.88 V	342	28.1	17.7

Remarks:

1. Emission Level(dBuV/m) = Raw Value(dBuV) + Correction Factor(dB/m)
2. Correction Factor(dB/m) = Antenna Factor(dB/m) + Cable Factor(dB) – Pre-Amplifier Factor(dB)
3. The other emission levels were very low against the limit.
4. Margin value = Emission Level – Limit value
5. " \* ": Fundamental frequency.
6. " # ": The radiated frequency is out of the restricted band.

802.11ax (HE40)

CHANNEL	TX Channel 38	DETECTOR FUNCTION	Peak (PK)
FREQUENCY RANGE	1GHz ~ 40GHz		Average (AV)

Antenna Polarity & Test Distance : Horizontal at 3 m

No	Frequency (MHz)	Emission Level (dBuV/m)	Limit (dBuV/m)	Margin (dB)	Antenna Height (m)	Table Angle (Degree)	Raw Value (dBuV)	Correction Factor (dB/m)
1	5150.00	71.0 PK	74.0	-3.0	1.07 H	324	64.5	6.5
2	5150.00	52.3 AV	54.0	-1.7	1.07 H	324	45.8	6.5
3	*5190.00	118.0 PK			1.51 H	300	75.9	42.1
4	*5190.00	104.8 AV			1.51 H	300	62.7	42.1
5	#10380.00	59.7 PK	68.2	-8.5	1.00 H	346	42.9	16.8

Antenna Polarity & Test Distance : Vertical at 3 m

No	Frequency (MHz)	Emission Level (dBuV/m)	Limit (dBuV/m)	Margin (dB)	Antenna Height (m)	Table Angle (Degree)	Raw Value (dBuV)	Correction Factor (dB/m)
1	5150.00	71.0 PK	74.0	-3.0	1.27 V	288	64.5	6.5
2	5150.00	51.6 AV	54.0	-2.4	1.27 V	288	45.1	6.5
3	*5190.00	81.2 PK			1.20 V	294	74.9	6.3
4	*5190.00	68.3 AV			1.20 V	294	62.0	6.3
5	#10380.00	59.6 PK	68.2	-8.6	1.42 V	288	42.8	16.8

Remarks:

1. Emission Level(dBuV/m) = Raw Value(dBuV) + Correction Factor(dB/m)
2. Correction Factor(dB/m) = Antenna Factor(dB/m) + Cable Factor(dB) – Pre-Amplifier Factor(dB)
3. The other emission levels were very low against the limit.
4. Margin value = Emission Level – Limit value
5. " \* ": Fundamental frequency.
6. " # ": The radiated frequency is out of the restricted band.

CHANNEL	TX Channel 46	DETECTOR	Peak (PK)
FREQUENCY RANGE	1GHz ~ 40GHz	FUNCTION	Average (AV)

## Antenna Polarity &amp; Test Distance : Horizontal at 3 m

No	Frequency (MHz)	Emission Level (dBuV/m)	Limit (dBuV/m)	Margin (dB)	Antenna Height (m)	Table Angle (Degree)	Raw Value (dBuV)	Correction Factor (dB/m)
1	*5230.00	118.8 PK			1.52 H	300	76.9	41.9
2	*5230.00	105.2 AV			1.52 H	300	63.3	41.9
3	5350.00	58.5 PK	74.0	-15.5	1.43 H	305	52.2	6.3
4	5350.00	45.4 AV	54.0	-8.6	1.43 H	305	39.1	6.3
5	#10460.00	60.6 PK	68.2	-7.6	1.00 H	311	43.3	17.3

## Antenna Polarity &amp; Test Distance : Vertical at 3 m

No	Frequency (MHz)	Emission Level (dBuV/m)	Limit (dBuV/m)	Margin (dB)	Antenna Height (m)	Table Angle (Degree)	Raw Value (dBuV)	Correction Factor (dB/m)
1	*5230.00	117.7 PK			1.21 V	291	75.8	41.9
2	*5230.00	104.3 AV			1.21 V	291	62.4	41.9
3	5350.00	57.8 PK	74.0	-16.2	1.39 V	303	51.5	6.3
4	5350.00	45.3 AV	54.0	-8.7	1.39 V	303	39.0	6.3
5	#10460.00	59.6 PK	68.2	-8.6	1.45 V	282	42.3	17.3

## Remarks:

1. Emission Level(dBuV/m) = Raw Value(dBuV) + Correction Factor(dB/m)
2. Correction Factor(dB/m) = Antenna Factor(dB/m) + Cable Factor(dB) – Pre-Amplifier Factor(dB)
3. The other emission levels were very low against the limit.
4. Margin value = Emission Level – Limit value
5. " \* ": Fundamental frequency.
6. " # ": The radiated frequency is out of the restricted band.

CHANNEL	TX Channel 151	DETECTOR FUNCTION	Peak (PK)
FREQUENCY RANGE	1GHz ~ 40GHz		Average (AV)

Antenna Polarity & Test Distance : Horizontal at 3 m								
No	Frequency (MHz)	Emission Level (dBuV/m)	Limit (dBuV/m)	Margin (dB)	Antenna Height (m)	Table Angle (Degree)	Raw Value (dBuV)	Correction Factor (dB/m)
1	#5649.36	61.3 PK	68.2	-6.9	1.25 H	306	55.1	6.2
2	*5755.00	117.7 PK			1.25 H	306	75.7	42.0
3	*5755.00	104.8 AV			1.25 H	306	62.8	42.0
4	#5982.05	61.1 PK	68.2	-7.1	1.25 H	306	54.2	6.9
5	11510.00	59.7 PK	74.0	-14.3	1.00 H	296	41.8	17.9
6	11510.00	46.8 AV	54.0	-7.2	1.00 H	296	28.9	17.9

Antenna Polarity & Test Distance : Vertical at 3 m								
No	Frequency (MHz)	Emission Level (dBuV/m)	Limit (dBuV/m)	Margin (dB)	Antenna Height (m)	Table Angle (Degree)	Raw Value (dBuV)	Correction Factor (dB/m)
1	#5643.59	59.6 PK	68.2	-8.6	1.39 V	280	53.4	6.2
2	*5755.00	117.2 PK			1.39 V	280	75.2	42.0
3	*5755.00	104.5 AV			1.39 V	280	62.5	42.0
4	#5964.10	59.0 PK	68.2	-9.2	1.39 V	280	52.0	7.0
5	11510.00	59.4 PK	74.0	-14.6	1.84 V	196	41.5	17.9
6	11510.00	45.6 AV	54.0	-8.4	1.84 V	196	27.7	17.9

Remarks:

1. Emission Level(dBuV/m) = Raw Value(dBuV) + Correction Factor(dB/m)
2. Correction Factor(dB/m) = Antenna Factor(dB/m) + Cable Factor(dB) – Pre-Amplifier Factor(dB)
3. The other emission levels were very low against the limit.
4. Margin value = Emission Level – Limit value
5. " \* " : Fundamental frequency.
6. " # " : The radiated frequency is out of the restricted band.

CHANNEL	TX Channel 159	DETECTOR	Peak (PK)
FREQUENCY RANGE	1GHz ~ 40GHz	FUNCTION	Average (AV)

Antenna Polarity & Test Distance : Horizontal at 3 m								
No	Frequency (MHz)	Emission Level (dBuV/m)	Limit (dBuV/m)	Margin (dB)	Antenna Height (m)	Table Angle (Degree)	Raw Value (dBuV)	Correction Factor (dB/m)
1	#5644.87	56.5 PK	68.2	-11.7	1.32 H	306	50.3	6.2
2	*5795.00	117.8 PK			1.32 H	306	75.8	42.0
3	*5795.00	105.1 AV			1.32 H	306	63.1	42.0
4	#5941.67	60.1 PK	68.2	-8.1	1.32 H	306	53.1	7.0
5	11590.00	59.0 PK	74.0	-15.0	1.00 H	303	41.5	17.5
6	11590.00	46.2 AV	54.0	-7.8	1.00 H	303	28.7	17.5

Antenna Polarity & Test Distance : Vertical at 3 m								
No	Frequency (MHz)	Emission Level (dBuV/m)	Limit (dBuV/m)	Margin (dB)	Antenna Height (m)	Table Angle (Degree)	Raw Value (dBuV)	Correction Factor (dB/m)
1	#5641.67	58.2 PK	68.2	-10.0	1.44 V	283	52.0	6.2
2	*5795.00	117.0 PK			1.44 V	283	75.0	42.0
3	*5795.00	104.3 AV			1.44 V	283	62.3	42.0
4	#5992.95	58.5 PK	68.2	-9.7	1.44 V	283	51.6	6.9
5	11590.00	59.7 PK	74.0	-14.3	1.86 V	211	42.2	17.5
6	11590.00	45.5 AV	54.0	-8.5	1.86 V	211	28.0	17.5

Remarks:

1. Emission Level(dBuV/m) = Raw Value(dBuV) + Correction Factor(dB/m)
2. Correction Factor(dB/m) = Antenna Factor(dB/m) + Cable Factor(dB) – Pre-Amplifier Factor(dB)
3. The other emission levels were very low against the limit.
4. Margin value = Emission Level – Limit value
5. " \* ": Fundamental frequency.
6. " # ": The radiated frequency is out of the restricted band.

802.11ax (HE80)

CHANNEL	TX Channel 42	DETECTOR FUNCTION	Peak (PK)
FREQUENCY RANGE	1GHz ~ 40GHz		Average (AV)

Antenna Polarity & Test Distance : Horizontal at 3 m								
No	Frequency (MHz)	Emission Level (dBuV/m)	Limit (dBuV/m)	Margin (dB)	Antenna Height (m)	Table Angle (Degree)	Raw Value (dBuV)	Correction Factor (dB/m)
1	5150.00	71.1 PK	74.0	-2.9	1.74 H	324	64.6	6.5
2	5150.00	52.8 AV	54.0	-1.2	1.74 H	324	46.3	6.5
3	*5210.00	116.0 PK			1.81 H	323	74.0	42.0
4	*5210.00	102.6 AV			1.81 H	323	60.6	42.0
5	5350.00	64.9 PK	74.0	-9.1	1.35 H	326	58.6	6.3
6	5350.00	47.7 AV	54.0	-6.3	1.35 H	326	41.4	6.3
7	#10420.00	59.4 PK	68.2	-8.8	2.09 H	279	42.2	17.2
Antenna Polarity & Test Distance : Vertical at 3 m								
No	Frequency (MHz)	Emission Level (dBuV/m)	Limit (dBuV/m)	Margin (dB)	Antenna Height (m)	Table Angle (Degree)	Raw Value (dBuV)	Correction Factor (dB/m)
1	5150.00	71.9 PK	74.0	-2.1	1.22 V	289	65.4	6.5
2	5150.00	52.3 AV	54.0	-1.7	1.22 V	289	45.8	6.5
3	*5210.00	114.2 PK			1.27 V	287	72.2	42.0
4	*5210.00	101.0 AV			1.27 V	287	59.0	42.0
5	5350.00	61.9 PK	74.0	-12.1	3.77 V	306	55.6	6.3
6	5350.00	46.3 AV	54.0	-7.7	3.77 V	306	40.0	6.3
7	#10420.00	59.7 PK	68.2	-8.5	1.44 V	285	42.5	17.2

Remarks:

1. Emission Level(dBuV/m) = Raw Value(dBuV) + Correction Factor(dB/m)
2. Correction Factor(dB/m) = Antenna Factor(dB/m) + Cable Factor(dB) – Pre-Amplifier Factor(dB)
3. The other emission levels were very low against the limit.
4. Margin value = Emission Level – Limit value
5. " \* ": Fundamental frequency.
6. " # ": The radiated frequency is out of the restricted band.

CHANNEL	TX Channel 155	DETECTOR FUNCTION	Peak (PK)
FREQUENCY RANGE	1GHz ~ 40GHz		Average (AV)

Antenna Polarity & Test Distance : Horizontal at 3 m								
No	Frequency (MHz)	Emission Level (dBuV/m)	Limit (dBuV/m)	Margin (dB)	Antenna Height (m)	Table Angle (Degree)	Raw Value (dBuV)	Correction Factor (dB/m)
1	#5649.36	61.4 PK	68.2	-6.8	1.24 H	305	55.2	6.2
2	#5650.00	65.5 PK	68.2	-2.7	1.05 H	330	59.4	6.1
3	*5775.00	114.6 PK			1.24 H	305	72.6	42.0
4	*5775.00	101.0 AV			1.24 H	305	59.0	42.0
5	#5925.00	66.9 PK	68.2	-1.3	1.39 H	310	59.9	7.0
6	#5929.49	64.2 PK	68.2	-4.0	1.24 H	305	57.2	7.0
7	11550.00	59.7 PK	74.0	-14.3	1.00 H	287	41.9	17.8
8	11550.00	45.8 AV	54.0	-8.2	1.00 H	287	28.0	17.8
Antenna Polarity & Test Distance : Vertical at 3 m								
No	Frequency (MHz)	Emission Level (dBuV/m)	Limit (dBuV/m)	Margin (dB)	Antenna Height (m)	Table Angle (Degree)	Raw Value (dBuV)	Correction Factor (dB/m)
1	#5648.72	62.0 PK	68.2	-6.2	1.49 V	280	55.8	6.2
2	#5650.00	65.1 PK	68.2	-3.1	1.37 V	279	59.0	6.1
3	*5775.00	114.1 PK			1.49 V	280	72.1	42.0
4	*5775.00	101.4 AV			1.49 V	280	59.4	42.0
5	#5925.00	64.8 PK	68.2	-3.4	1.54 V	284	57.8	7.0
6	#5957.05	60.3 PK	68.2	-7.9	1.49 V	280	53.3	7.0
7	11550.00	60.0 PK	74.0	-14.0	1.64 V	216	42.2	17.8
8	11550.00	45.7 AV	54.0	-8.3	1.64 V	216	27.9	17.8

Remarks:

1. Emission Level(dBuV/m) = Raw Value(dBuV) + Correction Factor(dB/m)
2. Correction Factor(dB/m) = Antenna Factor(dB/m) + Cable Factor(dB) – Pre-Amplifier Factor(dB)
3. The other emission levels were very low against the limit.
4. Margin value = Emission Level – Limit value
5. " \* ": Fundamental frequency.
6. " # ": The radiated frequency is out of the restricted band.

**Scanning radio:**

802.11a

CHANNEL	TX Channel 36	DETECTOR FUNCTION	Peak (PK)
FREQUENCY RANGE	1GHz ~ 40GHz		Average (AV)

**Antenna Polarity & Test Distance : Horizontal at 3 m**

No	Frequency (MHz)	Emission Level (dBuV/m)	Limit (dBuV/m)	Margin (dB)	Antenna Height (m)	Table Angle (Degree)	Raw Value (dBuV)	Correction Factor (dB/m)
1	5150.00	61.1 PK	74.0	-12.9	1.14 H	336	59.0	2.1
2	5150.00	46.2 AV	54.0	-7.8	1.14 H	336	44.1	2.1
3	*5180.00	108.0 PK			1.24 H	337	71.7	36.3
4	*5180.00	97.9 AV			1.24 H	337	61.6	36.3
5	#10360.00	60.4 PK	68.2	-7.8	1.02 H	52	45.3	15.1

**Antenna Polarity & Test Distance : Vertical at 3 m**

No	Frequency (MHz)	Emission Level (dBuV/m)	Limit (dBuV/m)	Margin (dB)	Antenna Height (m)	Table Angle (Degree)	Raw Value (dBuV)	Correction Factor (dB/m)
1	5150.00	68.5 PK	74.0	-5.5	1.03 V	30	66.4	2.1
2	5150.00	52.8 AV	54.0	-1.2	1.03 V	30	50.7	2.1
3	*5180.00	114.5 PK			1.00 V	27	78.2	36.3
4	*5180.00	104.4 AV			1.00 V	27	68.1	36.3
5	#10360.00	61.5 PK	68.2	-6.7	1.48 V	17	46.4	15.1

**Remarks:**

1. Emission Level(dBuV/m) = Raw Value(dBuV) + Correction Factor(dB/m)
2. Correction Factor(dB/m) = Antenna Factor(dB/m) + Cable Factor(dB) – Pre-Amplifier Factor(dB)
3. The other emission levels were very low against the limit.
4. Margin value = Emission Level – Limit value
5. " \* " : Fundamental frequency.
6. " # " : The radiated frequency is out of the restricted band.



CHANNEL	TX Channel 40	DETECTOR	Peak (PK)
FREQUENCY RANGE	1GHz ~ 40GHz	FUNCTION	Average (AV)

Antenna Polarity & Test Distance : Horizontal at 3 m								
No	Frequency (MHz)	Emission Level (dBuV/m)	Limit (dBuV/m)	Margin (dB)	Antenna Height (m)	Table Angle (Degree)	Raw Value (dBuV)	Correction Factor (dB/m)
1	*5200.00	108.4 PK			1.37 H	331	72.2	36.2
2	*5200.00	98.2 AV			1.37 H	331	62.0	36.2
3	#10400.00	61.5 PK	68.2	-6.7	1.13 H	64	46.3	15.2
Antenna Polarity & Test Distance : Vertical at 3 m								
No	Frequency (MHz)	Emission Level (dBuV/m)	Limit (dBuV/m)	Margin (dB)	Antenna Height (m)	Table Angle (Degree)	Raw Value (dBuV)	Correction Factor (dB/m)
1	*5200.00	114.9 PK			1.07 V	38	78.7	36.2
2	*5200.00	104.8 AV			1.07 V	38	68.6	36.2
3	#10400.00	62.5 PK	68.2	-5.7	1.53 V	24	47.3	15.2

Remarks:

1. Emission Level(dBuV/m) = Raw Value(dBuV) + Correction Factor(dB/m)
2. Correction Factor(dB/m) = Antenna Factor(dB/m) + Cable Factor(dB) – Pre-Amplifier Factor(dB)
3. The other emission levels were very low against the limit.
4. Margin value = Emission Level – Limit value
5. " \* ": Fundamental frequency.
6. " # ": The radiated frequency is out of the restricted band.

CHANNEL	TX Channel 48	DETECTOR	Peak (PK)
FREQUENCY RANGE	1GHz ~ 40GHz	FUNCTION	Average (AV)

## Antenna Polarity &amp; Test Distance : Horizontal at 3 m

No	Frequency (MHz)	Emission Level (dBuV/m)	Limit (dBuV/m)	Margin (dB)	Antenna Height (m)	Table Angle (Degree)	Raw Value (dBuV)	Correction Factor (dB/m)
1	*5240.00	107.6 PK			1.35 H	343	71.5	36.1
2	*5240.00	97.5 AV			1.35 H	343	61.4	36.1
3	5350.00	54.4 PK	74.0	-19.6	1.28 H	337	52.4	2.0
4	5350.00	41.8 AV	54.0	-12.2	1.28 H	337	39.8	2.0
5	#10480.00	61.2 PK	68.2	-7.0	1.14 H	58	46.1	15.1

## Antenna Polarity &amp; Test Distance : Vertical at 3 m

No	Frequency (MHz)	Emission Level (dBuV/m)	Limit (dBuV/m)	Margin (dB)	Antenna Height (m)	Table Angle (Degree)	Raw Value (dBuV)	Correction Factor (dB/m)
1	*5240.00	114.3 PK			1.02 V	54	78.2	36.1
2	*5240.00	104.2 AV			1.02 V	54	68.1	36.1
3	5350.00	55.4 PK	74.0	-18.6	1.13 V	61	53.4	2.0
4	5350.00	42.6 AV	54.0	-11.4	1.13 V	61	40.6	2.0
5	#10480.00	61.8 PK	68.2	-6.4	1.59 V	28	46.7	15.1

## Remarks:

1. Emission Level(dBuV/m) = Raw Value(dBuV) + Correction Factor(dB/m)
2. Correction Factor(dB/m) = Antenna Factor(dB/m) + Cable Factor(dB) – Pre-Amplifier Factor(dB)
3. The other emission levels were very low against the limit.
4. Margin value = Emission Level – Limit value
5. " \* ": Fundamental frequency.
6. " # ": The radiated frequency is out of the restricted band.

CHANNEL	TX Channel 149	DETECTOR FUNCTION	Peak (PK)
FREQUENCY RANGE	1GHz ~ 40GHz		Average (AV)

Antenna Polarity & Test Distance : Horizontal at 3 m								
No	Frequency (MHz)	Emission Level (dBuV/m)	Limit (dBuV/m)	Margin (dB)	Antenna Height (m)	Table Angle (Degree)	Raw Value (dBuV)	Correction Factor (dB/m)
1	#5640.80	54.7 PK	68.2	-13.5	2.32 H	77	52.0	2.7
2	*5745.00	111.4 PK			2.32 H	77	74.1	37.3
3	*5745.00	101.0 AV			2.32 H	77	63.7	37.3
4	#5996.80	56.1 PK	68.2	-12.1	2.32 H	77	52.8	3.3
5	11490.00	54.9 PK	74.0	-19.1	1.37 H	105	39.4	15.5
6	11490.00	41.3 AV	54.0	-12.7	1.37 H	105	25.8	15.5

Antenna Polarity & Test Distance : Vertical at 3 m								
No	Frequency (MHz)	Emission Level (dBuV/m)	Limit (dBuV/m)	Margin (dB)	Antenna Height (m)	Table Angle (Degree)	Raw Value (dBuV)	Correction Factor (dB/m)
1	#5644.00	56.9 PK	68.2	-11.3	1.00 V	72	54.2	2.7
2	*5745.00	116.2 PK			1.00 V	72	78.9	37.3
3	*5745.00	105.7 AV			1.00 V	72	68.4	37.3
4	#5984.80	56.4 PK	68.2	-11.8	1.00 V	72	53.1	3.3
5	11490.00	56.2 PK	74.0	-17.8	1.64 V	29	40.7	15.5
6	11490.00	42.1 AV	54.0	-11.9	1.64 V	29	26.6	15.5

Remarks:

1. Emission Level(dBuV/m) = Raw Value(dBuV) + Correction Factor(dB/m)
2. Correction Factor(dB/m) = Antenna Factor(dB/m) + Cable Factor(dB) – Pre-Amplifier Factor(dB)
3. The other emission levels were very low against the limit.
4. Margin value = Emission Level – Limit value
5. " \* ": Fundamental frequency.
6. " # ": The radiated frequency is out of the restricted band.

CHANNEL	TX Channel 157	DETECTOR FUNCTION	Peak (PK)
FREQUENCY RANGE	1GHz ~ 40GHz		Average (AV)

Antenna Polarity & Test Distance : Horizontal at 3 m								
No	Frequency (MHz)	Emission Level (dBuV/m)	Limit (dBuV/m)	Margin (dB)	Antenna Height (m)	Table Angle (Degree)	Raw Value (dBuV)	Correction Factor (dB/m)
1	#5610.40	55.0 PK	68.2	-13.2	2.37 H	73	52.4	2.6
2	*5785.00	110.9 PK			2.37 H	73	73.4	37.5
3	*5785.00	100.3 AV			2.37 H	73	62.8	37.5
4	#5964.00	55.2 PK	68.2	-13.0	2.37 H	73	52.0	3.2
5	11570.00	54.7 PK	74.0	-19.3	1.42 H	107	39.5	15.2
6	11570.00	41.1 AV	54.0	-12.9	1.42 H	107	25.9	15.2

Antenna Polarity & Test Distance : Vertical at 3 m								
No	Frequency (MHz)	Emission Level (dBuV/m)	Limit (dBuV/m)	Margin (dB)	Antenna Height (m)	Table Angle (Degree)	Raw Value (dBuV)	Correction Factor (dB/m)
1	#5620.80	57.5 PK	68.2	-10.7	1.04 V	73	54.9	2.6
2	*5785.00	115.4 PK			1.04 V	73	77.9	37.5
3	*5785.00	105.0 AV			1.04 V	73	67.5	37.5
4	#5994.40	55.3 PK	68.2	-12.9	1.04 V	73	52.0	3.3
5	11570.00	55.8 PK	74.0	-18.2	1.39 V	35	40.6	15.2
6	11570.00	41.7 AV	54.0	-12.3	1.39 V	35	26.5	15.2

Remarks:

1. Emission Level(dBuV/m) = Raw Value(dBuV) + Correction Factor(dB/m)
2. Correction Factor(dB/m) = Antenna Factor(dB/m) + Cable Factor(dB) – Pre-Amplifier Factor(dB)
3. The other emission levels were very low against the limit.
4. Margin value = Emission Level – Limit value
5. " \* ": Fundamental frequency.
6. " # ": The radiated frequency is out of the restricted band.

CHANNEL	TX Channel 165	DETECTOR	Peak (PK)
FREQUENCY RANGE	1GHz ~ 40GHz	FUNCTION	Average (AV)

## Antenna Polarity &amp; Test Distance : Horizontal at 3 m

No	Frequency (MHz)	Emission Level (dBuV/m)	Limit (dBuV/m)	Margin (dB)	Antenna Height (m)	Table Angle (Degree)	Raw Value (dBuV)	Correction Factor (dB/m)
1	#5605.60	55.8 PK	68.2	-12.4	2.31 H	75	53.2	2.6
2	*5825.00	110.8 PK			2.31 H	75	73.4	37.4
3	*5825.00	100.3 AV			2.31 H	75	62.9	37.4
4	#5964.00	55.0 PK	68.2	-13.2	2.31 H	75	51.8	3.2
5	11650.00	54.9 PK	74.0	-19.1	1.41 H	102	39.7	15.2
6	11650.00	41.3 AV	54.0	-12.7	1.41 H	102	26.1	15.2

## Antenna Polarity &amp; Test Distance : Vertical at 3 m

No	Frequency (MHz)	Emission Level (dBuV/m)	Limit (dBuV/m)	Margin (dB)	Antenna Height (m)	Table Angle (Degree)	Raw Value (dBuV)	Correction Factor (dB/m)
1	#5604.00	58.6 PK	68.2	-9.6	1.06 V	72	56.0	2.6
2	*5825.00	115.7 PK			1.06 V	72	78.3	37.4
3	*5825.00	105.1 AV			1.06 V	72	67.7	37.4
4	#5988.80	55.5 PK	68.2	-12.7	1.06 V	72	52.2	3.3
5	11650.00	55.9 PK	74.0	-18.1	1.29 V	31	40.7	15.2
6	11650.00	41.8 AV	54.0	-12.2	1.29 V	31	26.6	15.2

## Remarks:

1. Emission Level(dBuV/m) = Raw Value(dBuV) + Correction Factor(dB/m)
2. Correction Factor(dB/m) = Antenna Factor(dB/m) + Cable Factor(dB) – Pre-Amplifier Factor(dB)
3. The other emission levels were very low against the limit.
4. Margin value = Emission Level – Limit value
5. " \* ": Fundamental frequency.
6. " # ": The radiated frequency is out of the restricted band.

802.11ac (VHT20)

CHANNEL	TX Channel 36	DETECTOR FUNCTION	Peak (PK)
FREQUENCY RANGE	1GHz ~ 40GHz		Average (AV)

Antenna Polarity & Test Distance : Horizontal at 3 m

No	Frequency (MHz)	Emission Level (dBuV/m)	Limit (dBuV/m)	Margin (dB)	Antenna Height (m)	Table Angle (Degree)	Raw Value (dBuV)	Correction Factor (dB/m)
1	5150.00	62.5 PK	74.0	-11.5	1.27 H	334	60.4	2.1
2	5150.00	46.9 AV	54.0	-7.1	1.27 H	334	44.8	2.1
3	*5180.00	107.6 PK			1.36 H	329	71.3	36.3
4	*5180.00	97.1 AV			1.36 H	329	60.8	36.3
5	#10360.00	58.9 PK	68.2	-9.3	1.13 H	67	43.8	15.1

Antenna Polarity & Test Distance : Vertical at 3 m

No	Frequency (MHz)	Emission Level (dBuV/m)	Limit (dBuV/m)	Margin (dB)	Antenna Height (m)	Table Angle (Degree)	Raw Value (dBuV)	Correction Factor (dB/m)
1	5150.00	68.2 PK	74.0	-5.8	1.00 V	30	66.1	2.1
2	5150.00	52.6 AV	54.0	-1.4	1.00 V	30	50.5	2.1
3	*5180.00	114.1 PK			1.06 V	31	77.8	36.3
4	*5180.00	103.7 AV			1.06 V	31	67.4	36.3
5	#10360.00	59.6 PK	68.2	-8.6	1.47 V	16	44.5	15.1

Remarks:

1. Emission Level(dBuV/m) = Raw Value(dBuV) + Correction Factor(dB/m)
2. Correction Factor(dB/m) = Antenna Factor(dB/m) + Cable Factor(dB) – Pre-Amplifier Factor(dB)
3. The other emission levels were very low against the limit.
4. Margin value = Emission Level – Limit value
5. " \* ": Fundamental frequency.
6. " # ": The radiated frequency is out of the restricted band.

CHANNEL	TX Channel 40	DETECTOR	Peak (PK)
FREQUENCY RANGE	1GHz ~ 40GHz	FUNCTION	Average (AV)

Antenna Polarity & Test Distance : Horizontal at 3 m								
No	Frequency (MHz)	Emission Level (dBuV/m)	Limit (dBuV/m)	Margin (dB)	Antenna Height (m)	Table Angle (Degree)	Raw Value (dBuV)	Correction Factor (dB/m)
1	*5200.00	108.4 PK			1.31 H	341	72.2	36.2
2	*5200.00	97.9 AV			1.31 H	341	61.7	36.2
3	#10400.00	59.0 PK	68.2	-9.2	1.06 H	69	43.8	15.2
Antenna Polarity & Test Distance : Vertical at 3 m								
No	Frequency (MHz)	Emission Level (dBuV/m)	Limit (dBuV/m)	Margin (dB)	Antenna Height (m)	Table Angle (Degree)	Raw Value (dBuV)	Correction Factor (dB/m)
1	*5200.00	114.9 PK			1.09 V	43	78.7	36.2
2	*5200.00	104.6 AV			1.09 V	43	68.4	36.2
3	#10400.00	60.4 PK	68.2	-7.8	1.53 V	23	45.2	15.2

Remarks:

1. Emission Level(dBuV/m) = Raw Value(dBuV) + Correction Factor(dB/m)
2. Correction Factor(dB/m) = Antenna Factor(dB/m) + Cable Factor(dB) – Pre-Amplifier Factor(dB)
3. The other emission levels were very low against the limit.
4. Margin value = Emission Level – Limit value
5. " \* ": Fundamental frequency.
6. " # ": The radiated frequency is out of the restricted band.

CHANNEL	TX Channel 48	DETECTOR	Peak (PK)
FREQUENCY RANGE	1GHz ~ 40GHz	FUNCTION	Average (AV)

## Antenna Polarity &amp; Test Distance : Horizontal at 3 m

No	Frequency (MHz)	Emission Level (dBuV/m)	Limit (dBuV/m)	Margin (dB)	Antenna Height (m)	Table Angle (Degree)	Raw Value (dBuV)	Correction Factor (dB/m)
1	*5240.00	107.8 PK			1.35 H	338	71.7	36.1
2	*5240.00	97.4 AV			1.35 H	338	61.3	36.1
3	5350.00	52.8 PK	74.0	-21.2	1.31 H	331	50.8	2.0
4	5350.00	41.7 AV	54.0	-12.3	1.31 H	331	39.7	2.0
5	#10480.00	58.9 PK	68.2	-9.3	1.06 H	59	43.8	15.1

## Antenna Polarity &amp; Test Distance : Vertical at 3 m

No	Frequency (MHz)	Emission Level (dBuV/m)	Limit (dBuV/m)	Margin (dB)	Antenna Height (m)	Table Angle (Degree)	Raw Value (dBuV)	Correction Factor (dB/m)
1	*5240.00	114.5 PK			1.04 V	60	78.4	36.1
2	*5240.00	104.0 AV			1.04 V	60	67.9	36.1
3	5350.00	54.7 PK	74.0	-19.3	1.08 V	57	52.7	2.0
4	5350.00	42.3 AV	54.0	-11.7	1.08 V	57	40.3	2.0
5	#10480.00	60.0 PK	68.2	-8.2	1.57 V	24	44.9	15.1

## Remarks:

1. Emission Level(dBuV/m) = Raw Value(dBuV) + Correction Factor(dB/m)
2. Correction Factor(dB/m) = Antenna Factor(dB/m) + Cable Factor(dB) – Pre-Amplifier Factor(dB)
3. The other emission levels were very low against the limit.
4. Margin value = Emission Level – Limit value
5. " \* ": Fundamental frequency.
6. " # ": The radiated frequency is out of the restricted band.



CHANNEL	TX Channel 149	DETECTOR FUNCTION	Peak (PK)
FREQUENCY RANGE	1GHz ~ 40GHz		Average (AV)

Antenna Polarity & Test Distance : Horizontal at 3 m								
No	Frequency (MHz)	Emission Level (dBuV/m)	Limit (dBuV/m)	Margin (dB)	Antenna Height (m)	Table Angle (Degree)	Raw Value (dBuV)	Correction Factor (dB/m)
1	#5627.20	55.2 PK	68.2	-13.0	2.38 H	82	52.6	2.6
2	*5745.00	111.0 PK			2.38 H	82	73.7	37.3
3	*5745.00	100.5 AV			2.38 H	82	63.2	37.3
4	#5997.60	55.3 PK	68.2	-12.9	2.38 H	82	52.0	3.3
5	11490.00	55.0 PK	74.0	-19.0	1.39 H	102	39.5	15.5
6	11490.00	41.2 AV	54.0	-12.8	1.39 H	102	25.7	15.5

Antenna Polarity & Test Distance : Vertical at 3 m								
No	Frequency (MHz)	Emission Level (dBuV/m)	Limit (dBuV/m)	Margin (dB)	Antenna Height (m)	Table Angle (Degree)	Raw Value (dBuV)	Correction Factor (dB/m)
1	#5607.20	58.3 PK	68.2	-9.9	1.03 V	74	55.7	2.6
2	*5745.00	115.5 PK			1.03 V	74	78.2	37.3
3	*5745.00	105.1 AV			1.03 V	74	67.8	37.3
4	#5977.60	56.3 PK	68.2	-11.9	1.03 V	74	53.0	3.3
5	11490.00	56.0 PK	74.0	-18.0	1.32 V	33	40.5	15.5
6	11490.00	41.9 AV	54.0	-12.1	1.32 V	33	26.4	15.5

Remarks:

1. Emission Level(dBuV/m) = Raw Value(dBuV) + Correction Factor(dB/m)
2. Correction Factor(dB/m) = Antenna Factor(dB/m) + Cable Factor(dB) – Pre-Amplifier Factor(dB)
3. The other emission levels were very low against the limit.
4. Margin value = Emission Level – Limit value
5. " \* ": Fundamental frequency.
6. " # ": The radiated frequency is out of the restricted band.

CHANNEL	TX Channel 157	DETECTOR FUNCTION	Peak (PK)
FREQUENCY RANGE	1GHz ~ 40GHz		Average (AV)

Antenna Polarity & Test Distance : Horizontal at 3 m								
No	Frequency (MHz)	Emission Level (dBuV/m)	Limit (dBuV/m)	Margin (dB)	Antenna Height (m)	Table Angle (Degree)	Raw Value (dBuV)	Correction Factor (dB/m)
1	#5620.80	55.0 PK	68.2	-13.2	2.31 H	88	52.4	2.6
2	*5785.00	110.2 PK			2.31 H	88	72.7	37.5
3	*5785.00	99.8 AV			2.31 H	88	62.3	37.5
4	#5996.80	54.8 PK	68.2	-13.4	2.31 H	88	51.5	3.3
5	11570.00	55.0 PK	74.0	-19.0	1.43 H	101	39.8	15.2
6	11570.00	40.9 AV	54.0	-13.1	1.43 H	101	25.7	15.2

Antenna Polarity & Test Distance : Vertical at 3 m								
No	Frequency (MHz)	Emission Level (dBuV/m)	Limit (dBuV/m)	Margin (dB)	Antenna Height (m)	Table Angle (Degree)	Raw Value (dBuV)	Correction Factor (dB/m)
1	#5610.40	57.8 PK	68.2	-10.4	1.05 V	70	55.2	2.6
2	*5785.00	115.0 PK			1.05 V	70	77.5	37.5
3	*5785.00	104.6 AV			1.05 V	70	67.1	37.5
4	#5978.40	56.3 PK	68.2	-11.9	1.05 V	70	53.0	3.3
5	11570.00	55.8 PK	74.0	-18.2	1.28 V	34	40.6	15.2
6	11570.00	41.6 AV	54.0	-12.4	1.28 V	34	26.4	15.2

Remarks:

1. Emission Level(dBuV/m) = Raw Value(dBuV) + Correction Factor(dB/m)
2. Correction Factor(dB/m) = Antenna Factor(dB/m) + Cable Factor(dB) – Pre-Amplifier Factor(dB)
3. The other emission levels were very low against the limit.
4. Margin value = Emission Level – Limit value
5. " \* ": Fundamental frequency.
6. " # ": The radiated frequency is out of the restricted band.

CHANNEL	TX Channel 165	DETECTOR FUNCTION	Peak (PK)
FREQUENCY RANGE	1GHz ~ 40GHz		Average (AV)

Antenna Polarity & Test Distance : Horizontal at 3 m								
No	Frequency (MHz)	Emission Level (dBuV/m)	Limit (dBuV/m)	Margin (dB)	Antenna Height (m)	Table Angle (Degree)	Raw Value (dBuV)	Correction Factor (dB/m)
1	#5603.20	55.6 PK	68.2	-12.6	2.32 H	86	53.0	2.6
2	*5825.00	110.2 PK			2.32 H	86	72.8	37.4
3	*5825.00	99.8 AV			2.32 H	86	62.4	37.4
4	#5991.20	54.9 PK	68.2	-13.3	2.32 H	86	51.6	3.3
5	11650.00	54.7 PK	74.0	-19.3	1.41 H	97	39.5	15.2
6	11650.00	40.9 AV	54.0	-13.1	1.41 H	97	25.7	15.2

Antenna Polarity & Test Distance : Vertical at 3 m								
No	Frequency (MHz)	Emission Level (dBuV/m)	Limit (dBuV/m)	Margin (dB)	Antenna Height (m)	Table Angle (Degree)	Raw Value (dBuV)	Correction Factor (dB/m)
1	#5616.80	58.7 PK	68.2	-9.5	1.03 V	71	56.1	2.6
2	*5825.00	115.1 PK			1.03 V	71	77.7	37.4
3	*5825.00	104.6 AV			1.03 V	71	67.2	37.4
4	#5940.00	56.2 PK	68.2	-12.0	1.03 V	71	52.9	3.3
5	11650.00	55.6 PK	74.0	-18.4	1.33 V	36	40.4	15.2
6	11650.00	41.5 AV	54.0	-12.5	1.33 V	36	26.3	15.2

Remarks:

1. Emission Level(dBuV/m) = Raw Value(dBuV) + Correction Factor(dB/m)
2. Correction Factor(dB/m) = Antenna Factor(dB/m) + Cable Factor(dB) – Pre-Amplifier Factor(dB)
3. The other emission levels were very low against the limit.
4. Margin value = Emission Level – Limit value
5. " \* ": Fundamental frequency.
6. " # ": The radiated frequency is out of the restricted band.

802.11ac (VHT40)

CHANNEL	TX Channel 38	DETECTOR FUNCTION	Peak (PK)
FREQUENCY RANGE	1GHz ~ 40GHz		Average (AV)

Antenna Polarity & Test Distance : Horizontal at 3 m

No	Frequency (MHz)	Emission Level (dBuV/m)	Limit (dBuV/m)	Margin (dB)	Antenna Height (m)	Table Angle (Degree)	Raw Value (dBuV)	Correction Factor (dB/m)
1	5150.00	61.5 PK	74.0	-12.5	1.27 H	339	59.4	2.1
2	5150.00	46.4 AV	54.0	-7.6	1.27 H	339	44.3	2.1
3	*5190.00	99.0 PK			1.32 H	346	62.8	36.2
4	*5190.00	89.0 AV			1.32 H	346	52.8	36.2
5	#10380.00	56.4 PK	68.2	-11.8	1.07 H	49	41.2	15.2

Antenna Polarity & Test Distance : Vertical at 3 m

No	Frequency (MHz)	Emission Level (dBuV/m)	Limit (dBuV/m)	Margin (dB)	Antenna Height (m)	Table Angle (Degree)	Raw Value (dBuV)	Correction Factor (dB/m)
1	5150.00	67.6 PK	74.0	-6.4	1.02 V	32	65.5	2.1
2	5150.00	52.7 AV	54.0	-1.3	1.02 V	32	50.6	2.1
3	*5190.00	105.5 PK			1.00 V	33	69.3	36.2
4	*5190.00	95.6 AV			1.00 V	33	59.4	36.2
5	#10380.00	57.5 PK	68.2	-10.7	1.52 V	19	42.3	15.2

Remarks:

1. Emission Level(dBuV/m) = Raw Value(dBuV) + Correction Factor(dB/m)
2. Correction Factor(dB/m) = Antenna Factor(dB/m) + Cable Factor(dB) – Pre-Amplifier Factor(dB)
3. The other emission levels were very low against the limit.
4. Margin value = Emission Level – Limit value
5. " \* ": Fundamental frequency.
6. " # ": The radiated frequency is out of the restricted band.

CHANNEL	TX Channel 46	DETECTOR	Peak (PK)
FREQUENCY RANGE	1GHz ~ 40GHz	FUNCTION	Average (AV)

## Antenna Polarity &amp; Test Distance : Horizontal at 3 m

No	Frequency (MHz)	Emission Level (dBuV/m)	Limit (dBuV/m)	Margin (dB)	Antenna Height (m)	Table Angle (Degree)	Raw Value (dBuV)	Correction Factor (dB/m)
1	*5230.00	105.0 PK			1.29 H	327	68.8	36.2
2	*5230.00	94.8 AV			1.29 H	327	58.6	36.2
3	5350.00	53.7 PK	74.0	-20.3	1.22 H	335	51.7	2.0
4	5350.00	42.2 AV	54.0	-11.8	1.22 H	335	40.2	2.0
5	#10460.00	58.5 PK	68.2	-9.7	1.17 H	61	43.4	15.1

## Antenna Polarity &amp; Test Distance : Vertical at 3 m

No	Frequency (MHz)	Emission Level (dBuV/m)	Limit (dBuV/m)	Margin (dB)	Antenna Height (m)	Table Angle (Degree)	Raw Value (dBuV)	Correction Factor (dB/m)
1	*5230.00	111.6 PK			1.00 V	62	75.4	36.2
2	*5230.00	101.3 AV			1.00 V	62	65.1	36.2
3	5350.00	55.7 PK	74.0	-18.3	1.06 V	57	53.7	2.0
4	5350.00	43.2 AV	54.0	-10.8	1.06 V	57	41.2	2.0
5	#10460.00	59.3 PK	68.2	-8.9	1.51 V	14	44.2	15.1

## Remarks:

1. Emission Level(dBuV/m) = Raw Value(dBuV) + Correction Factor(dB/m)
2. Correction Factor(dB/m) = Antenna Factor(dB/m) + Cable Factor(dB) – Pre-Amplifier Factor(dB)
3. The other emission levels were very low against the limit.
4. Margin value = Emission Level – Limit value
5. " \* ": Fundamental frequency.
6. " # ": The radiated frequency is out of the restricted band.

CHANNEL	TX Channel 151	DETECTOR FUNCTION	Peak (PK)
FREQUENCY RANGE	1GHz ~ 40GHz		Average (AV)

Antenna Polarity & Test Distance : Horizontal at 3 m								
No	Frequency (MHz)	Emission Level (dBuV/m)	Limit (dBuV/m)	Margin (dB)	Antenna Height (m)	Table Angle (Degree)	Raw Value (dBuV)	Correction Factor (dB/m)
1	#5612.00	54.5 PK	68.2	-13.7	2.31 H	84	51.9	2.6
2	*5755.00	108.5 PK			2.31 H	84	71.2	37.3
3	*5755.00	98.1 AV			2.31 H	84	60.8	37.3
4	#5996.00	54.2 PK	68.2	-14.0	2.31 H	84	50.9	3.3
5	11510.00	54.9 PK	74.0	-19.1	1.39 H	111	39.6	15.3
6	11510.00	40.9 AV	54.0	-13.1	1.39 H	111	25.6	15.3

Antenna Polarity & Test Distance : Vertical at 3 m								
No	Frequency (MHz)	Emission Level (dBuV/m)	Limit (dBuV/m)	Margin (dB)	Antenna Height (m)	Table Angle (Degree)	Raw Value (dBuV)	Correction Factor (dB/m)
1	#5616.80	56.9 PK	68.2	-11.3	1.04 V	74	54.3	2.6
2	*5755.00	113.0 PK			1.04 V	74	75.7	37.3
3	*5755.00	102.8 AV			1.04 V	74	65.5	37.3
4	#5996.00	56.6 PK	68.2	-11.6	1.04 V	74	53.3	3.3
5	11510.00	55.6 PK	74.0	-18.4	1.45 V	46	40.3	15.3
6	11510.00	41.5 AV	54.0	-12.5	1.45 V	46	26.2	15.3

Remarks:

1. Emission Level(dBuV/m) = Raw Value(dBuV) + Correction Factor(dB/m)
2. Correction Factor(dB/m) = Antenna Factor(dB/m) + Cable Factor(dB) – Pre-Amplifier Factor(dB)
3. The other emission levels were very low against the limit.
4. Margin value = Emission Level – Limit value
5. " \* ": Fundamental frequency.
6. " # ": The radiated frequency is out of the restricted band.

CHANNEL	TX Channel 159	DETECTOR FUNCTION	Peak (PK)
FREQUENCY RANGE	1GHz ~ 40GHz		Average (AV)

Antenna Polarity & Test Distance : Horizontal at 3 m								
No	Frequency (MHz)	Emission Level (dBuV/m)	Limit (dBuV/m)	Margin (dB)	Antenna Height (m)	Table Angle (Degree)	Raw Value (dBuV)	Correction Factor (dB/m)
1	#5604.80	54.7 PK	68.2	-13.5	2.39 H	79	52.1	2.6
2	*5795.00	108.3 PK			2.39 H	79	70.8	37.5
3	*5795.00	98.1 AV			2.39 H	79	60.6	37.5
4	#5947.20	54.3 PK	68.2	-13.9	2.39 H	79	51.0	3.3
5	11590.00	54.7 PK	74.0	-19.3	1.49 H	104	39.6	15.1
6	11590.00	40.6 AV	54.0	-13.4	1.49 H	104	25.5	15.1

Antenna Polarity & Test Distance : Vertical at 3 m								
No	Frequency (MHz)	Emission Level (dBuV/m)	Limit (dBuV/m)	Margin (dB)	Antenna Height (m)	Table Angle (Degree)	Raw Value (dBuV)	Correction Factor (dB/m)
1	#5609.60	56.4 PK	68.2	-11.8	1.01 V	73	53.8	2.6
2	*5795.00	112.8 PK			1.01 V	73	75.3	37.5
3	*5795.00	102.8 AV			1.01 V	73	65.3	37.5
4	#5958.40	55.2 PK	68.2	-13.0	1.01 V	73	51.9	3.3
5	11590.00	55.5 PK	74.0	-18.5	1.28 V	43	40.4	15.1
6	11590.00	41.4 AV	54.0	-12.6	1.28 V	43	26.3	15.1

Remarks:

1. Emission Level(dBuV/m) = Raw Value(dBuV) + Correction Factor(dB/m)
2. Correction Factor(dB/m) = Antenna Factor(dB/m) + Cable Factor(dB) – Pre-Amplifier Factor(dB)
3. The other emission levels were very low against the limit.
4. Margin value = Emission Level – Limit value
5. " \* ": Fundamental frequency.
6. " # ": The radiated frequency is out of the restricted band.

802.11ac (VHT80)

CHANNEL	TX Channel 42	DETECTOR FUNCTION	Peak (PK)
FREQUENCY RANGE	1GHz ~ 40GHz		Average (AV)

Antenna Polarity & Test Distance : Horizontal at 3 m

No	Frequency (MHz)	Emission Level (dBuV/m)	Limit (dBuV/m)	Margin (dB)	Antenna Height (m)	Table Angle (Degree)	Raw Value (dBuV)	Correction Factor (dB/m)
1	5150.00	60.5 PK	74.0	-13.5	1.37 H	332	58.4	2.1
2	5150.00	46.7 AV	54.0	-7.3	1.37 H	332	44.6	2.1
3	*5210.00	96.3 PK			1.43 H	328	60.1	36.2
4	*5210.00	85.5 AV			1.43 H	328	49.3	36.2
5	5350.00	53.3 PK	74.0	-20.7	1.29 H	337	51.3	2.0
6	5350.00	42.2 AV	54.0	-11.8	1.29 H	337	40.2	2.0
7	#10420.00	56.4 PK	68.2	-11.8	1.14 H	59	41.2	15.2

Antenna Polarity & Test Distance : Vertical at 3 m

No	Frequency (MHz)	Emission Level (dBuV/m)	Limit (dBuV/m)	Margin (dB)	Antenna Height (m)	Table Angle (Degree)	Raw Value (dBuV)	Correction Factor (dB/m)
1	5150.00	66.1 PK	74.0	-7.9	1.04 V	49	64.0	2.1
2	5150.00	52.7 AV	54.0	-1.3	1.04 V	49	50.6	2.1
3	*5210.00	102.6 PK			1.10 V	62	66.4	36.2
4	*5210.00	92.1 AV			1.10 V	62	55.9	36.2
5	5350.00	54.7 PK	74.0	-19.3	1.05 V	53	52.7	2.0
6	5350.00	43.2 AV	54.0	-10.8	1.05 V	53	41.2	2.0
7	#10420.00	57.4 PK	68.2	-10.8	1.54 V	23	42.2	15.2

Remarks:

1. Emission Level(dBuV/m) = Raw Value(dBuV) + Correction Factor(dB/m)
2. Correction Factor(dB/m) = Antenna Factor(dB/m) + Cable Factor(dB) – Pre-Amplifier Factor(dB)
3. The other emission levels were very low against the limit.
4. Margin value = Emission Level – Limit value
5. " \* ": Fundamental frequency.
6. " # ": The radiated frequency is out of the restricted band.



CHANNEL	TX Channel 155	DETECTOR FUNCTION	Peak (PK)
FREQUENCY RANGE	1GHz ~ 40GHz		Average (AV)

Antenna Polarity & Test Distance : Horizontal at 3 m								
No	Frequency (MHz)	Emission Level (dBuV/m)	Limit (dBuV/m)	Margin (dB)	Antenna Height (m)	Table Angle (Degree)	Raw Value (dBuV)	Correction Factor (dB/m)
1	#5634.40	59.4 PK	68.2	-8.8	2.38 H	84	56.8	2.6
2	#5650.00	62.3 PK	68.2	-5.9	2.43 H	87	59.6	2.7
3	*5775.00	106.3 PK			2.38 H	84	68.8	37.5
4	*5775.00	95.9 AV			2.38 H	84	58.4	37.5
5	#5925.00	59.7 PK	68.2	-8.5	2.33 H	81	56.4	3.3
6	#5936.80	56.4 PK	68.2	-11.8	2.38 H	84	53.1	3.3
7	11550.00	54.7 PK	74.0	-19.3	1.46 H	113	39.4	15.3
8	11550.00	40.9 AV	54.0	-13.1	1.46 H	113	25.6	15.3
Antenna Polarity & Test Distance : Vertical at 3 m								
No	Frequency (MHz)	Emission Level (dBuV/m)	Limit (dBuV/m)	Margin (dB)	Antenna Height (m)	Table Angle (Degree)	Raw Value (dBuV)	Correction Factor (dB/m)
1	#5646.40	63.3 PK	68.2	-4.9	1.00 V	74	60.6	2.7
2	#5650.00	66.0 PK	68.2	-2.2	1.03 V	74	63.3	2.7
3	*5775.00	111.4 PK			1.00 V	74	73.9	37.5
4	*5775.00	100.7 AV			1.00 V	74	63.2	37.5
5	#5925.00	62.0 PK	68.2	-6.2	1.05 V	76	58.7	3.3
6	#5936.80	58.1 PK	68.2	-10.1	1.00 V	74	54.8	3.3
7	11550.00	55.5 PK	74.0	-18.5	1.23 V	32	40.2	15.3
8	11550.00	41.4 AV	54.0	-12.6	1.23 V	32	26.1	15.3

Remarks:

1. Emission Level(dBuV/m) = Raw Value(dBuV) + Correction Factor(dB/m)
2. Correction Factor(dB/m) = Antenna Factor(dB/m) + Cable Factor(dB) – Pre-Amplifier Factor(dB)
3. The other emission levels were very low against the limit.
4. Margin value = Emission Level – Limit value
5. " \* ": Fundamental frequency.
6. " # ": The radiated frequency is out of the restricted band.

Below 1GHz Worst-Case:

**5G traffic radio:**

802.11ax (HE20)

CHANNEL	TX Channel 40	DETECTOR FUNCTION	Quasi-Peak (QP)
FREQUENCY RANGE	9kHz ~ 1GHz	TEST MODE	A

ANTENNA POLARITY & TEST DISTANCE: HORIZONTAL AT 3 M

NO.	FREQ. (MHz)	EMISSION LEVEL (dBuV/m)	LIMIT (dBuV/m)	MARGIN (dB)	ANTENNA HEIGHT (m)	TABLE ANGLE (Degree)	RAW VALUE (dBuV)	CORRECTION FACTOR (dB/m)
1	77.80	28.6 QP	40.0	-11.4	1.00 H	127	41.4	-12.8
2	145.28	28.7 QP	43.5	-14.8	1.00 H	77	37.4	-8.7
3	215.57	28.5 QP	43.5	-15.0	2.00 H	111	39.2	-10.7
4	337.87	25.4 QP	46.0	-20.6	1.50 H	122	31.2	-5.8
5	571.23	31.4 QP	46.0	-14.6	1.00 H	5	32.2	-0.8
6	683.70	34.3 QP	46.0	-11.7	2.00 H	5	32.5	1.8

Remarks:

1. Emission Level(dBuV/m) = Raw Value(dBuV) + Correction Factor(dB/m).
2. Correction Factor(dB/m) = Antenna Factor(dB/m) + Cable Factor(dB) – Pre-Amplifier Factor(dB).
3. The other emission levels were very low against the limit of frequency range 30MHz ~ 1000MHz.
4. Margin value = Emission Level – Limit value.
5. The emission levels were very low against the limit of frequency range 9kHz ~ 30MHz: the amplitude of spurious emissions attenuated more than 20 dB below the permissible value to be report.

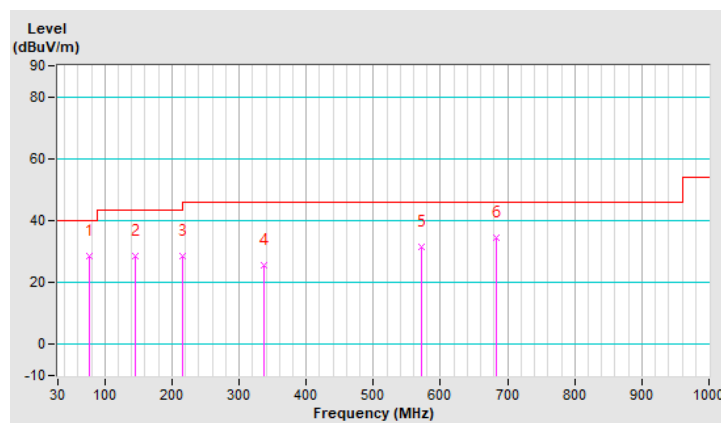

CHANNEL	TX Channel 40	DETECTOR FUNCTION	Quasi-Peak (QP)
FREQUENCY RANGE	9kHz ~ 1GHz	TEST MODE	A

ANTENNA POLARITY & TEST DISTANCE: VERTICAL AT 3 M								
NO.	FREQ. (MHz)	EMISSION LEVEL (dBuV/m)	LIMIT (dBuV/m)	MARGIN (dB)	ANTENNA HEIGHT (m)	TABLE ANGLE (Degree)	RAW VALUE (dBuV)	CORRECTION FACTOR (dB/m)
1	62.33	37.8 QP	40.0	-2.2	2.00 V	7	47.5	-9.7
2	104.51	29.4 QP	43.5	-14.1	1.50 V	78	41.9	-12.5
3	134.03	27.1 QP	43.5	-16.4	1.50 V	16	36.6	-9.5
4	215.57	22.8 QP	43.5	-20.7	1.00 V	172	33.5	-10.7
5	485.48	30.3 QP	46.0	-15.7	1.00 V	16	32.9	-2.6
6	596.54	31.7 QP	46.0	-14.3	1.00 V	181	31.5	0.2

Remarks:

1. Emission Level(dBuV/m) = Raw Value(dBuV) + Correction Factor(dB/m).
2. Correction Factor(dB/m) = Antenna Factor(dB/m) + Cable Factor(dB) – Pre-Amplifier Factor(dB).
3. The other emission levels were very low against the limit of frequency range 30MHz ~ 1000MHz.
4. Margin value = Emission Level – Limit value.
5. The emission levels were very low against the limit of frequency range 9kHz ~ 30MHz: the amplitude of spurious emissions attenuated more than 20 dB below the permissible value to be report.

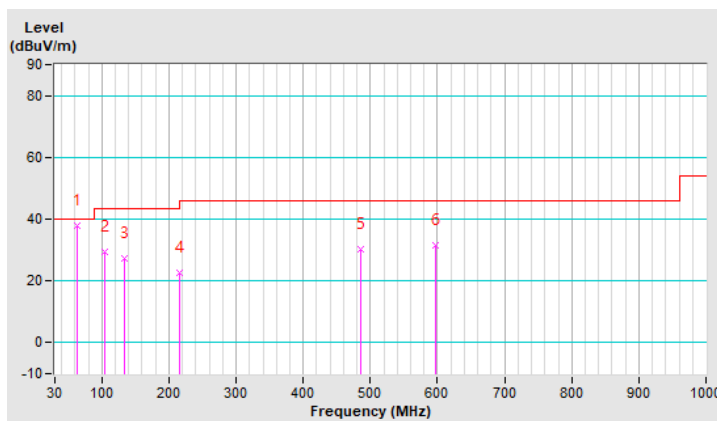

CHANNEL	TX Channel 40	DETECTOR FUNCTION	Quasi-Peak (QP)
FREQUENCY RANGE	9kHz ~ 1GHz	TEST MODE	B

**ANTENNA POLARITY & TEST DISTANCE: HORIZONTAL AT 3 M**

NO.	FREQ. (MHz)	EMISSION LEVEL (dBuV/m)	LIMIT (dBuV/m)	MARGIN (dB)	ANTENNA HEIGHT (m)	TABLE ANGLE (Degree)	RAW VALUE (dBuV)	CORRECTION FACTOR (dB/m)
1	77.80	28.2 QP	40.0	-11.8	2.00 H	250	41.0	-12.8
2	174.80	34.0 QP	43.5	-9.5	1.00 H	91	43.2	-9.2
3	263.36	44.5 QP	46.0	-1.5	2.00 H	136	52.3	-7.8
4	357.55	32.9 QP	46.0	-13.1	1.50 H	146	38.3	-5.4
5	656.99	34.8 QP	46.0	-11.2	1.00 H	145	33.5	1.3
6	746.96	40.0 QP	46.0	-6.0	1.00 H	276	36.8	3.2

**Remarks:**

1. Emission Level(dBuV/m) = Raw Value(dBuV) + Correction Factor(dB/m).
2. Correction Factor(dB/m) = Antenna Factor(dB/m) + Cable Factor(dB) – Pre-Amplifier Factor(dB).
3. The other emission levels were very low against the limit of frequency range 30MHz ~ 1000MHz.
4. Margin value = Emission Level – Limit value.
5. The emission levels were very low against the limit of frequency range 9kHz ~ 30MHz: the amplitude of spurious emissions attenuated more than 20 dB below the permissible value to be report.

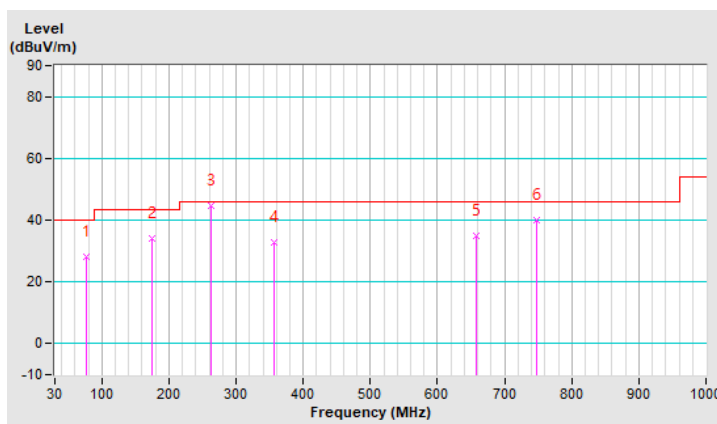

CHANNEL	TX Channel 40	DETECTOR FUNCTION	Quasi-Peak (QP)
FREQUENCY RANGE	9kHz ~ 1GHz	TEST MODE	B

**ANTENNA POLARITY & TEST DISTANCE: VERTICAL AT 3 M**

NO.	FREQ. (MHz)	EMISSION LEVEL (dBuV/m)	LIMIT (dBuV/m)	MARGIN (dB)	ANTENNA HEIGHT (m)	TABLE ANGLE (Degree)	RAW VALUE (dBuV)	CORRECTION FACTOR (dB/m)
1	35.62	37.9 QP	40.0	-2.1	1.50 V	204	48.2	-10.3
2	74.99	35.0 QP	40.0	-5.0	1.00 V	169	47.0	-12.0
3	138.25	31.3 QP	43.5	-12.2	1.50 V	72	40.4	-9.1
4	261.96	41.9 QP	46.0	-4.1	1.00 V	183	49.9	-8.0
5	496.72	33.6 QP	46.0	-12.4	2.00 V	166	35.9	-2.3
6	730.09	38.9 QP	46.0	-7.1	1.00 V	5	36.3	2.6

**Remarks:**

1. Emission Level(dBuV/m) = Raw Value(dBuV) + Correction Factor(dB/m).
2. Correction Factor(dB/m) = Antenna Factor(dB/m) + Cable Factor(dB) – Pre-Amplifier Factor(dB).
3. The other emission levels were very low against the limit of frequency range 30MHz ~ 1000MHz.
4. Margin value = Emission Level – Limit value.
5. The emission levels were very low against the limit of frequency range 9kHz ~ 30MHz: the amplitude of spurious emissions attenuated more than 20 dB below the permissible value to be report.

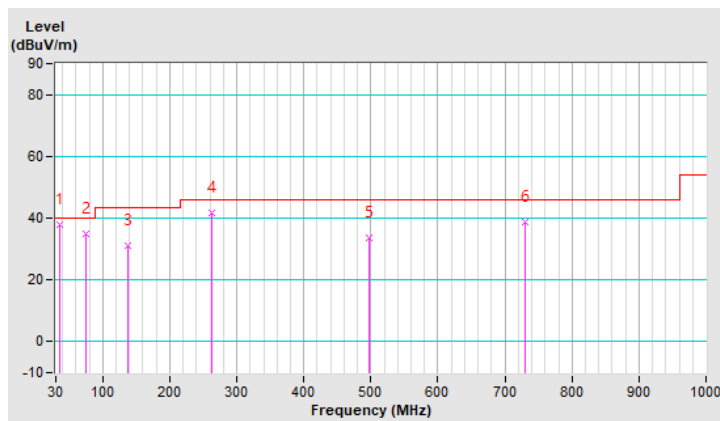

**Scanning radio:**

802.11a

CHANNEL	TX Channel 149	DETECTOR FUNCTION	Quasi-Peak (QP)
FREQUENCY RANGE	9kHz ~ 1GHz	TEST MODE	A

**ANTENNA POLARITY & TEST DISTANCE: HORIZONTAL AT 3 M**

NO.	FREQ. (MHz)	EMISSION LEVEL (dBuV/m)	LIMIT (dBuV/m)	MARGIN (dB)	ANTENNA HEIGHT (m)	TABLE ANGLE (Degree)	RAW VALUE (dBuV)	CORRECTION FACTOR (dB/m)
1	76.39	29.5 QP	40.0	-10.5	2.00 H	154	42.0	-12.5
2	105.91	28.4 QP	43.5	-15.1	1.51 H	122	40.8	-12.4
3	174.80	31.5 QP	43.5	-12.0	1.00 H	67	40.7	-9.2
4	491.10	31.6 QP	46.0	-14.4	1.51 H	155	34.1	-2.5
5	612.00	33.3 QP	46.0	-12.7	1.00 H	223	32.6	0.7
6	730.09	36.5 QP	46.0	-9.5	2.00 H	349	33.9	2.6

**Remarks:**

1. Emission Level(dBuV/m) = Raw Value(dBuV) + Correction Factor(dB/m).
2. Correction Factor(dB/m) = Antenna Factor(dB/m) + Cable Factor(dB) – Pre-Amplifier Factor(dB).
3. The other emission levels were very low against the limit of frequency range 30MHz ~ 1000MHz.
4. Margin value = Emission Level – Limit value.
5. The emission levels were very low against the limit of frequency range 9kHz ~ 30MHz: the amplitude of spurious emissions attenuated more than 20 dB below the permissible value to be report.

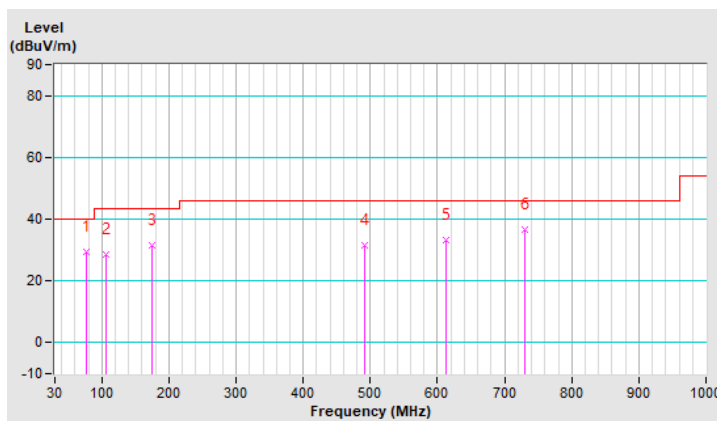

CHANNEL	TX Channel 149	DETECTOR FUNCTION	Quasi-Peak (QP)
FREQUENCY RANGE	9kHz ~ 1GHz	TEST MODE	A

**ANTENNA POLARITY & TEST DISTANCE: VERTICAL AT 3 M**

NO.	FREQ. (MHz)	EMISSION LEVEL (dBuV/m)	LIMIT (dBuV/m)	MARGIN (dB)	ANTENNA HEIGHT (m)	TABLE ANGLE (Degree)	RAW VALUE (dBuV)	CORRECTION FACTOR (dB/m)
1	62.33	37.9 QP	40.0	-2.1	1.50 V	340	47.6	-9.7
2	138.25	29.7 QP	43.5	-13.8	1.00 V	66	38.8	-9.1
3	176.20	25.9 QP	43.5	-17.6	2.00 V	7	35.2	-9.3
4	242.28	23.9 QP	46.0	-22.1	1.00 V	15	32.9	-9.0
5	559.99	31.2 QP	46.0	-14.8	2.00 V	164	32.3	-1.1
6	680.88	34.5 QP	46.0	-11.5	1.50 V	159	32.6	1.9

**Remarks:**

1. Emission Level(dBuV/m) = Raw Value(dBuV) + Correction Factor(dB/m).
2. Correction Factor(dB/m) = Antenna Factor(dB/m) + Cable Factor(dB) – Pre-Amplifier Factor(dB).
3. The other emission levels were very low against the limit of frequency range 30MHz ~ 1000MHz.
4. Margin value = Emission Level – Limit value.
5. The emission levels were very low against the limit of frequency range 9kHz ~ 30MHz: the amplitude of spurious emissions attenuated more than 20 dB below the permissible value to be report.

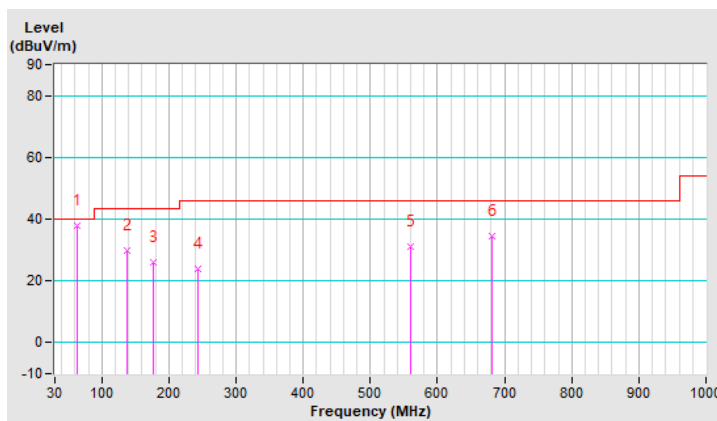

CHANNEL	TX Channel 149	DETECTOR FUNCTION	Quasi-Peak (QP)
FREQUENCY RANGE	9kHz ~ 1GHz	TEST MODE	B

ANTENNA POLARITY & TEST DISTANCE: HORIZONTAL AT 3 M								
NO.	FREQ. (MHz)	EMISSION LEVEL (dBuV/m)	LIMIT (dBuV/m)	MARGIN (dB)	ANTENNA HEIGHT (m)	TABLE ANGLE (Degree)	RAW VALUE (dBuV)	CORRECTION FACTOR (dB/m)
1	77.80	31.8 QP	40.0	-8.2	1.50 H	42	44.6	-12.8
2	122.78	28.4 QP	43.5	-15.1	2.00 H	73	39.0	-10.6
3	176.20	34.3 QP	43.5	-9.2	1.00 H	251	43.6	-9.3
4	260.55	41.2 QP	46.0	-4.8	1.00 H	216	49.2	-8.0
5	357.55	27.4 QP	46.0	-18.6	2.00 H	93	32.8	-5.4
6	443.30	34.7 QP	46.0	-11.3	1.00 H	103	38.1	-3.4

Remarks:

1. Emission Level(dBuV/m) = Raw Value(dBuV) + Correction Factor(dB/m).
2. Correction Factor(dB/m) = Antenna Factor(dB/m) + Cable Factor(dB) – Pre-Amplifier Factor(dB).
3. The other emission levels were very low against the limit of frequency range 30MHz ~ 1000MHz.
4. Margin value = Emission Level – Limit value.
5. The emission levels were very low against the limit of frequency range 9kHz ~ 30MHz: the amplitude of spurious emissions attenuated more than 20 dB below the permissible value to be report.

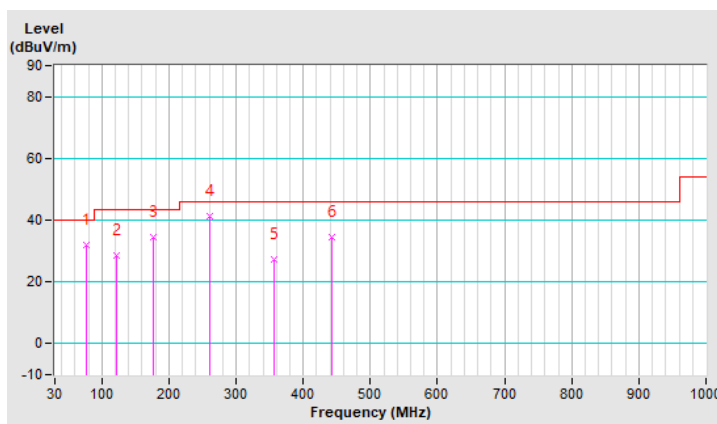



CHANNEL	TX Channel 149	DETECTOR FUNCTION	Quasi-Peak (QP)
FREQUENCY RANGE	9kHz ~ 1GHz	TEST MODE	B

**ANTENNA POLARITY & TEST DISTANCE: VERTICAL AT 3 M**

NO.	FREQ. (MHz)	EMISSION LEVEL (dBuV/m)	LIMIT (dBuV/m)	MARGIN (dB)	ANTENNA HEIGHT (m)	TABLE ANGLE (Degree)	RAW VALUE (dBuV)	CORRECTION FACTOR (dB/m)
1	49.68	35.9 QP	40.0	-4.1	1.50 V	273	45.0	-9.1
2	138.25	29.1 QP	43.5	-14.4	1.00 V	47	38.2	-9.1
3	261.96	43.9 QP	46.0	-2.1	2.00 V	132	51.9	-8.0
4	360.36	27.5 QP	46.0	-18.5	1.00 V	184	32.9	-5.4
5	493.91	31.6 QP	46.0	-14.4	2.00 V	307	34.1	-2.5
6	718.84	34.3 QP	46.0	-11.7	1.50 V	10	32.1	2.2

**Remarks:**

1. Emission Level(dBuV/m) = Raw Value(dBuV) + Correction Factor(dB/m).
2. Correction Factor(dB/m) = Antenna Factor(dB/m) + Cable Factor(dB) – Pre-Amplifier Factor(dB).
3. The other emission levels were very low against the limit of frequency range 30MHz ~ 1000MHz.
4. Margin value = Emission Level – Limit value.
5. The emission levels were very low against the limit of frequency range 9kHz ~ 30MHz: the amplitude of spurious emissions attenuated more than 20 dB below the permissible value to be report.

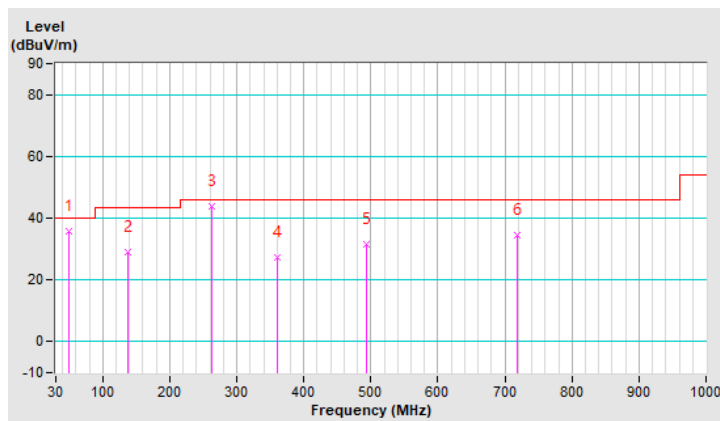

## 4.2 Conducted Emission Measurement

### 4.2.1 Limits of Conducted Emission Measurement

Frequency (MHz)	Conducted Limit (dBuV)	
	Quasi-peak	Average
0.15 - 0.5	66 - 56	56 - 46
0.50 - 5.0	56	46
5.0 - 30.0	60	50

Note: 1. The lower limit shall apply at the transition frequencies.

2. The limit decreases in line with the logarithm of the frequency in the range of 0.15 to 0.50MHz.

### 4.2.2 Test Instruments

Tested date: Dec. 16, 2020

Description & Manufacturer	Model No.	Serial No.	Cal. Date	Cal. Due
Test Receiver ROHDE & SCHWARZ	ESR3	102412	Feb. 17, 2020	Feb. 16, 2021
RF signal cable (with 10dB PAD) Woken	5D-FB	Cable-cond2-01	Sep. 04, 2020	Sep. 03, 2021
LISN ROHDE & SCHWARZ (EUT)	ESH2-Z5	100100	Jan. 20, 2020	Jan. 19, 2021
V-LISN ROHDE & SCHWARZ (Peripheral)	ESH3-Z5	100312	Aug. 18, 2020	Aug. 17, 2021
Software ADT	BV ADT_Cond_ V7.3.7.4	NA	NA	NA

Note: 1. The calibration interval of the above test instruments is 12 months and the calibrations are traceable to NML/ROC and NIST/USA.

2. The test was performed in HwaYa Shielded Room 2 (Conduction 2).

3. The VCCI Site Registration No. is C-12047.

#### 4.2.3 Test Procedures

- The EUT was placed 0.4 meters from the conducting wall of the shielded room with EUT being connected to the power mains through a line impedance stabilization network (LISN). Other support units were connected to the power mains through another LISN. The two LISNs provide 50 ohm/ 50uH of coupling impedance for the measuring instrument.
- Both lines of the power mains connected to the EUT were checked for maximum conducted interference.
- The frequency range from 150kHz to 30MHz was searched. Emission levels under (Limit - 20dB) was not recorded.

NOTE: The resolution bandwidth and video bandwidth of test receiver is 9kHz for quasi-peak detection (QP) and average detection (AV) at frequency 0.15MHz-30MHz.

#### 4.2.4 Deviation from Test Standard

No deviation.

#### 4.2.5 Test Setup

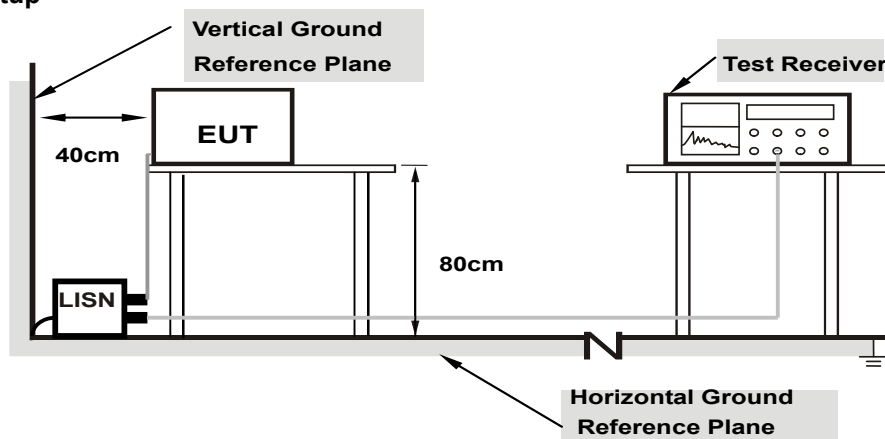

**Note: 1.Support units were connected to second LISN.**

For the actual test configuration, please refer to the attached file (Test Setup Photo).

#### 4.2.6 EUT Operating Conditions

Same as 4.1.6.

## 4.2.7 Test Results

### 5G traffic radio:

Worst-case data: 802.11a

Phase	Line (L)	Detector Function	Quasi-Peak (QP) / Average (AV)
Test Mode	A		

No	Freq. [MHz]	Corr. Factor (dB)	Reading Value [dB (uV)]		Emission Level [dB (uV)]		Limit [dB (uV)]		Margin (dB)	
			Q.P.	AV.	Q.P.	AV.	Q.P.	AV.	Q.P.	AV.
			1	0.15800	0.13	36.09	24.93	36.22	25.06	65.57
2	0.18037	0.14	33.11	21.11	33.25	21.25	64.47	54.47	-31.22	-33.22
3	0.36600	0.15	35.26	28.57	35.41	28.72	58.59	48.59	-23.18	-19.87
4	0.59400	0.16	19.88	13.95	20.04	14.11	56.00	46.00	-35.96	-31.89
5	4.89400	0.29	15.84	7.61	16.13	7.90	56.00	46.00	-39.87	-38.10
6	9.09000	0.33	19.16	13.94	19.49	14.27	60.00	50.00	-40.51	-35.73

#### Remarks:

1. Q.P. and AV. are abbreviations of quasi-peak and average individually.
2. The emission levels of other frequencies were very low against the limit.
3. Margin value = Emission level - Limit value
4. Correction factor = Insertion loss + Cable loss
5. Emission Level = Correction Factor + Reading Value.

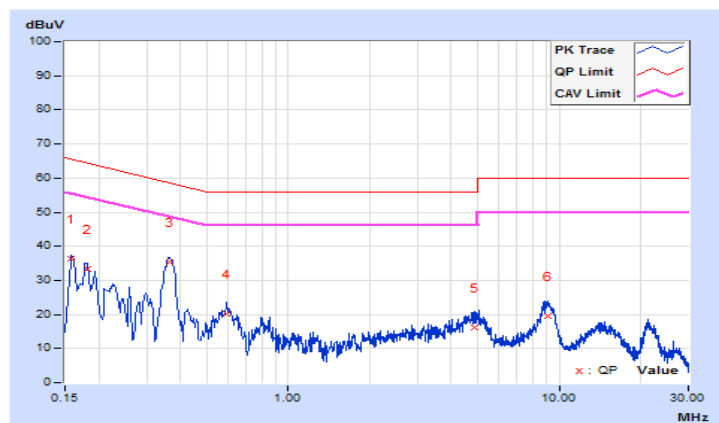

Phase	Neutral (N)	Detector Function	Quasi-Peak (QP) / Average (AV)
Test Mode	A		

No	Freq. [MHz]	Corr. Factor (dB)	Reading Value [dB (uV)]		Emission Level [dB (uV)]		Limit [dB (uV)]		Margin (dB)	
			Q.P.	AV.	Q.P.	AV.	Q.P.	AV.	Q.P.	AV.
			1	0.15800	0.10	35.00	24.49	35.10	24.59	65.57
2	0.19367	0.11	30.18	20.15	30.29	20.26	63.88	53.88	-33.59	-33.62
3	0.36448	0.13	31.03	23.80	31.16	23.93	58.63	48.63	-27.47	-24.70
4	0.59400	0.14	19.44	13.24	19.58	13.38	56.00	46.00	-36.42	-32.62
5	4.94200	0.30	15.08	7.22	15.38	7.52	56.00	46.00	-40.62	-38.48
6	9.02600	0.41	18.41	12.48	18.82	12.89	60.00	50.00	-41.18	-37.11

Remarks:

1. Q.P. and AV. are abbreviations of quasi-peak and average individually.
2. The emission levels of other frequencies were very low against the limit.
3. Margin value = Emission level - Limit value
4. Correction factor = Insertion loss + Cable loss
5. Emission Level = Correction Factor + Reading Value.

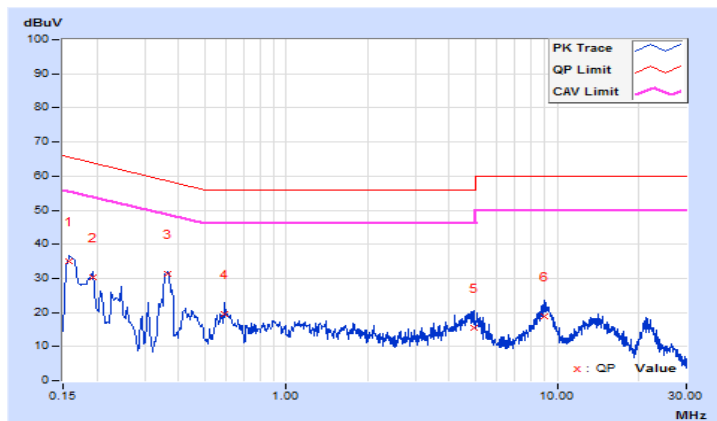

Phase	Line (L)	Detector Function	Quasi-Peak (QP) / Average (AV)
Test Mode	B		

No	Freq. [MHz]	Corr. Factor (dB)	Reading Value [dB (uV)]		Emission Level [dB (uV)]		Limit [dB (uV)]		Margin (dB)	
			Q.P.	AV.	Q.P.	AV.	Q.P.	AV.	Q.P.	AV.
			1	0.15400	0.08	37.59	22.64	37.67	22.72	65.78
2	0.17000	0.09	34.75	18.94	34.84	19.03	64.96	54.96	-30.12	-35.93
3	0.51800	0.13	34.87	30.53	35.00	30.66	56.00	46.00	-21.00	-15.34
4	2.45400	0.20	23.73	18.68	23.93	18.88	56.00	46.00	-32.07	-27.12
5	4.82600	0.25	23.05	17.55	23.30	17.80	56.00	46.00	-32.70	-28.20
6	11.85000	0.35	28.43	23.21	28.78	23.56	60.00	50.00	-31.22	-26.44

Remarks:

1. Q.P. and AV. are abbreviations of quasi-peak and average individually.
2. The emission levels of other frequencies were very low against the limit.
3. Margin value = Emission level - Limit value
4. Correction factor = Insertion loss + Cable loss
5. Emission Level = Correction Factor + Reading Value.

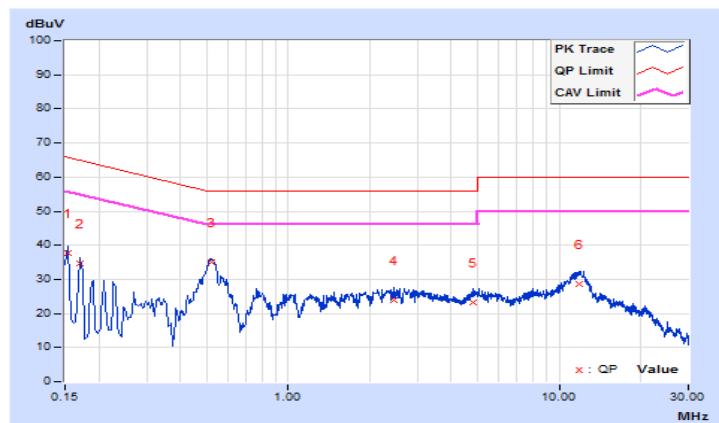

Phase	Neutral (N)	Detector Function	Quasi-Peak (QP) / Average (AV)
Test Mode	B		

No	Freq. [MHz]	Corr. Factor (dB)	Reading Value [dB (uV)]		Emission Level [dB (uV)]		Limit [dB (uV)]		Margin (dB)	
			Q.P.	AV.	Q.P.	AV.	Q.P.	AV.	Q.P.	AV.
			1	0.15400	0.07	37.43	22.17	37.50	22.24	65.78
2	0.17000	0.07	34.55	18.09	34.62	18.16	64.96	54.96	-30.34	-36.80
<b>3</b>	<b>0.51879</b>	<b>0.11</b>	<b>36.59</b>	<b>31.24</b>	<b>36.70</b>	<b>31.35</b>	<b>56.00</b>	<b>46.00</b>	<b>-19.30</b>	<b>-14.65</b>
4	1.05000	0.14	20.78	15.43	20.92	15.57	56.00	46.00	-35.08	-30.43
5	7.57400	0.32	19.49	14.04	19.81	14.36	60.00	50.00	-40.19	-35.64
6	12.02200	0.42	27.15	21.78	27.57	22.20	60.00	50.00	-32.43	-27.80

Remarks:

1. Q.P. and AV. are abbreviations of quasi-peak and average individually.
2. The emission levels of other frequencies were very low against the limit.
3. Margin value = Emission level - Limit value
4. Correction factor = Insertion loss + Cable loss
5. Emission Level = Correction Factor + Reading Value.

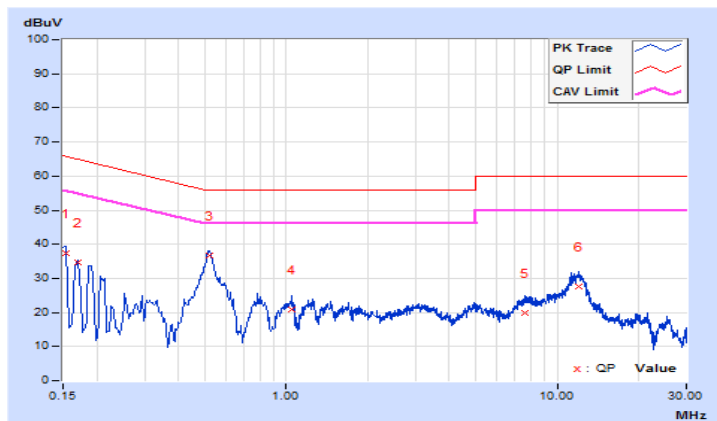

### Scanning radio:

Worst-case data: 802.11a

Phase	Line (L)	Detector Function	Quasi-Peak (QP) / Average (AV)
Test Mode	A		

No	Freq. [MHz]	Corr. Factor (dB)	Reading Value [dB (uV)]		Emission Level [dB (uV)]		Limit [dB (uV)]		Margin (dB)	
			Q.P.	AV.	Q.P.	AV.	Q.P.	AV.	Q.P.	AV.
			1	0.16148	0.13	35.41	24.57	35.54	24.70	65.39
2	0.19800	0.15	31.38	19.51	31.53	19.66	63.69	53.69	-32.16	-34.03
3	0.35971	0.15	35.24	27.68	35.39	27.83	58.74	48.74	-23.35	-20.91
4	0.59000	0.16	18.81	13.31	18.97	13.47	56.00	46.00	-37.03	-32.53
5	4.95800	0.29	16.05	7.72	16.34	8.01	56.00	46.00	-39.66	-37.99
6	8.95400	0.33	19.30	13.48	19.63	13.81	60.00	50.00	-40.37	-36.19

#### Remarks:

1. Q.P. and AV. are abbreviations of quasi-peak and average individually.
2. The emission levels of other frequencies were very low against the limit.
3. Margin value = Emission level - Limit value
4. Correction factor = Insertion loss + Cable loss
5. Emission Level = Correction Factor + Reading Value.

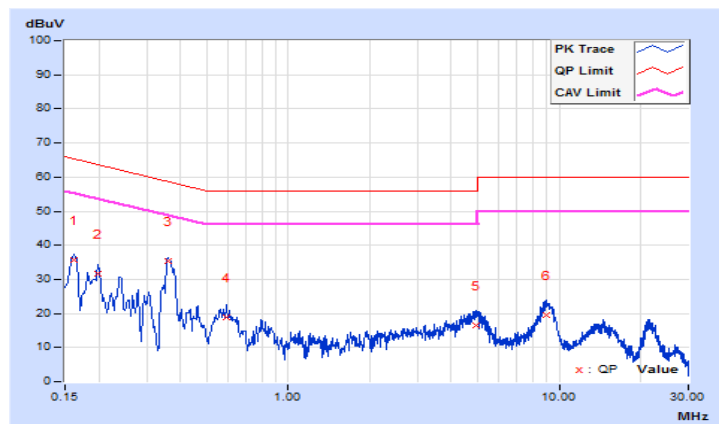



Phase	Neutral (N)	Detector Function	Quasi-Peak (QP) / Average (AV)
Test Mode	A		

No	Freq. [MHz]	Corr. Factor (dB)	Reading Value [dB (uV)]		Emission Level [dB (uV)]		Limit [dB (uV)]		Margin (dB)	
			Q.P.	AV.	Q.P.	AV.	Q.P.	AV.	Q.P.	AV.
			1	0.15000	0.10	31.72	15.87	31.82	15.97	66.00
2	0.17400	0.10	29.41	16.38	29.51	16.48	64.77	54.77	-35.26	-38.29
3	0.35594	0.13	30.81	22.31	30.94	22.44	58.82	48.82	-27.88	-26.38
4	0.58563	0.14	18.97	13.43	19.11	13.57	56.00	46.00	-36.89	-32.43
5	4.74600	0.30	15.07	7.52	15.37	7.82	56.00	46.00	-40.63	-38.18
6	9.08600	0.41	17.89	12.52	18.30	12.93	60.00	50.00	-41.70	-37.07

Remarks:

1. Q.P. and AV. are abbreviations of quasi-peak and average individually.
2. The emission levels of other frequencies were very low against the limit.
3. Margin value = Emission level - Limit value
4. Correction factor = Insertion loss + Cable loss
5. Emission Level = Correction Factor + Reading Value.

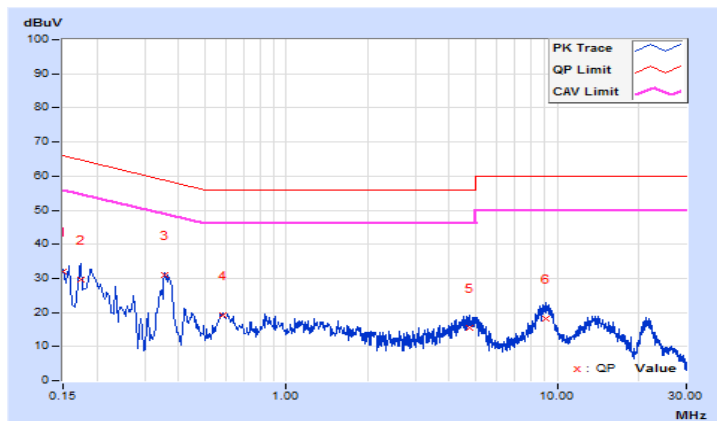

Phase	Line (L)	Detector Function	Quasi-Peak (QP) / Average (AV)
Test Mode	B		

No	Freq. [MHz]	Corr. Factor (dB)	Reading Value [dB (uV)]		Emission Level [dB (uV)]		Limit [dB (uV)]		Margin (dB)	
			Q.P.	AV.	Q.P.	AV.	Q.P.	AV.	Q.P.	AV.
			1	0.15400	0.08	37.58	22.66	37.66	22.74	65.78
2	0.17800	0.09	33.71	18.61	33.80	18.70	64.58	54.58	-30.78	-35.88
3	0.51000	0.13	34.35	29.50	34.48	29.63	56.00	46.00	-21.52	-16.37
4	2.62600	0.21	23.79	18.48	24.00	18.69	56.00	46.00	-32.00	-27.31
5	5.16600	0.26	23.11	17.65	23.37	17.91	60.00	50.00	-36.63	-32.09
6	11.53800	0.35	28.12	22.90	28.47	23.25	60.00	50.00	-31.53	-26.75

Remarks:

1. Q.P. and AV. are abbreviations of quasi-peak and average individually.
2. The emission levels of other frequencies were very low against the limit.
3. Margin value = Emission level - Limit value
4. Correction factor = Insertion loss + Cable loss
5. Emission Level = Correction Factor + Reading Value.

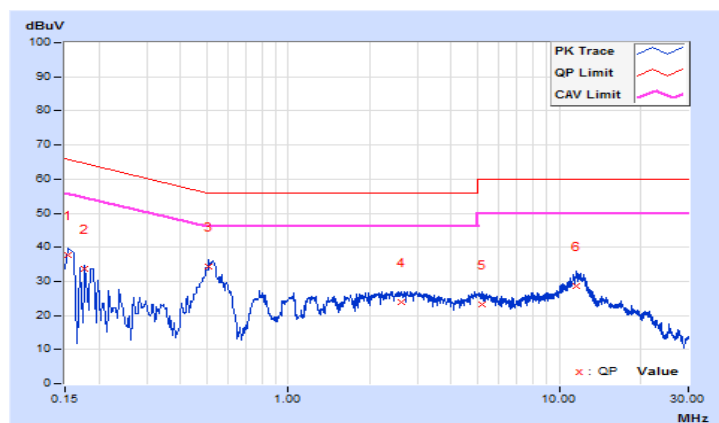

Phase	Neutral (N)	Detector Function	Quasi-Peak (QP) / Average (AV)
Test Mode	B		

No	Freq. [MHz]	Corr. Factor (dB)	Reading Value [dB (uV)]		Emission Level [dB (uV)]		Limit [dB (uV)]		Margin (dB)	
			Q.P.	AV.	Q.P.	AV.	Q.P.	AV.	Q.P.	AV.
			1	0.15000	0.07	37.39	20.89	37.46	20.96	66.00
2	0.16600	0.07	36.06	18.98	36.13	19.05	65.16	55.16	-29.03	-36.11
3	0.52016	0.11	36.70	31.09	36.81	31.20	56.00	46.00	-19.19	-14.80
4	1.45400	0.16	19.38	14.93	19.54	15.09	56.00	46.00	-36.46	-30.91
5	7.37400	0.32	19.43	13.79	19.75	14.11	60.00	50.00	-40.25	-35.89
6	11.75800	0.41	26.98	21.67	27.39	22.08	60.00	50.00	-32.61	-27.92

Remarks:

1. Q.P. and AV. are abbreviations of quasi-peak and average individually.
2. The emission levels of other frequencies were very low against the limit.
3. Margin value = Emission level - Limit value
4. Correction factor = Insertion loss + Cable loss
5. Emission Level = Correction Factor + Reading Value.

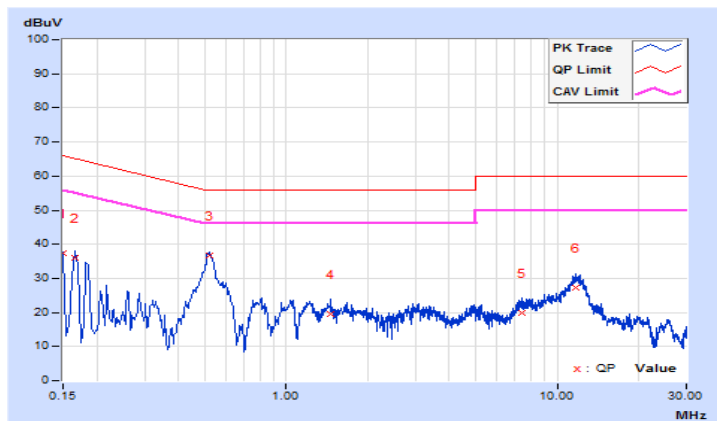

### 4.3 Transmit Power Measurement

#### 4.3.1 Limits of Transmit Power Measurement

Operation Band	EUT Category		LIMIT
U-NII-1	-	Outdoor Access Point	1 Watt (30 dBm) (Max. e.i.r.p $\leq$ 125mW(21 dBm) at any elevation angle above 30 degrees as measured from the horizon)
	-	Fixed point-to-point Access Point	1 Watt (30 dBm)
	√	Indoor Access Point	1 Watt (30 dBm)
	-	Mobile and Portable client device	250mW (24 dBm)
U-NII-2A	-		250mW (24 dBm) or 11 dBm+10 log B*
U-NII-2C	-		250mW (24 dBm) or 11 dBm+10 log B*
U-NII-3	√		1 Watt (30 dBm)

\*B is the 26 dB emission bandwidth in megahertz

Per KDB 662911 Method of conducted output power measurement on IEEE 802.11 devices,

Array Gain = 0 dB (i.e., no array gain) for  $N_{ANT} \leq 4$ ;

Array Gain = 0 dB (i.e., no array gain) for channel widths  $\geq 40$  MHz for any  $N_{ANT}$ ;

Array Gain =  $5 \log(N_{ANT}/N_{SS})$  dB or 3 dB, whichever is less for 20-MHz channel widths with  $N_{ANT} \geq 5$ .

For power measurements on all other devices: Array Gain =  $10 \log(N_{ANT}/N_{SS})$  dB.

#### 4.3.2 Test Setup

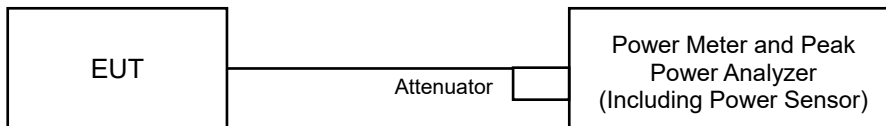

#### 4.3.3 Test Instruments

Refer to section 4.1.2 to get information of above instrument.

#### 4.3.4 Test Procedure

Method PM is used to perform output power measurement, trigger and gating function of wide band power meter is enabled to measure max output power of TX on burst and set the detector to average. Duty factor is not added to measured value.

#### 4.3.5 Deviation from Test Standard

No deviation.

#### 4.3.6 EUT Operating Conditions

The software provided by client to enable the EUT under transmission condition continuously at lowest, middle and highest channel frequencies individually.

#### 4.3.7 Test Result

Power Output:

**5G traffic radio:**

CDD Mode

802.11a

Chan.	Freq. (MHz)	Maximum Conducted Power (dBm)		Total Power (mW)	Total Power (dBm)	Power Limit (dBm)	Pass / Fail
		Chain 0	Chain 1				
36	5180	20.32	20.02	208.108	23.18	30.00	Pass
40	5200	21.38	21.08	<b>265.637</b>	24.24	30.00	Pass
48	5240	21.27	21.01	260.150	24.15	30.00	Pass
149	5745	20.17	20.08	205.851	23.14	30.00	Pass
157	5785	19.92	19.79	193.454	22.87	30.00	Pass
165	5825	19.94	19.57	189.201	22.77	30.00	Pass

802.11ax (HE20)

Chan.	Freq. (MHz)	Maximum Conducted Power (dBm)		Total Power (mW)	Total Power (dBm)	Power Limit (dBm)	Pass / Fail
		Chain 0	Chain 1				
36	5180	19.76	19.59	185.615	22.69	30.00	Pass
40	5200	20.23	20.14	208.715	23.20	30.00	Pass
48	5240	20.15	20.01	203.745	23.09	30.00	Pass
149	5745	20.13	20.07	204.663	23.11	30.00	Pass
157	5785	20.23	20.02	<b>205.900</b>	23.14	30.00	Pass
165	5825	20.12	20.02	203.263	23.08	30.00	Pass

802.11ax (HE40)

Chan.	Freq. (MHz)	Maximum Conducted Power (dBm)		Total Power (mW)	Total Power (dBm)	Power Limit (dBm)	Pass / Fail
		Chain 0	Chain 1				
38	5190	19.05	18.99	159.603	22.03	30.00	Pass
46	5230	19.82	19.57	186.513	22.71	30.00	Pass
151	5755	19.96	19.82	195.023	22.90	30.00	Pass
159	5795	19.77	19.73	188.814	22.76	30.00	Pass

802.11ax (HE80)

Chan.	Freq. (MHz)	Maximum Conducted Power (dBm)		Total Power (mW)	Total Power (dBm)	Power Limit (dBm)	Pass / Fail
		Chain 0	Chain 1				
42	5210	18.91	18.73	152.449	21.83	30.00	Pass
155	5775	18.69	18.56	145.740	21.64	30.00	Pass

### Beamforming Mode

#### 802.11ax (HE20)

Chan.	Freq. (MHz)	Maximum Conducted Power (dBm)		Total Power (mW)	Total Power (dBm)	Power Limit (dBm)	Pass / Fail
		Chain 0	Chain 1				
36	5180	16.75	16.58	92.814	19.68	28.06	Pass
40	5200	17.22	17.13	<b>104.365</b>	20.19	28.06	Pass
48	5240	17.14	17.00	101.879	20.08	28.06	Pass
149	5745	17.12	17.06	102.339	20.10	28.03	Pass
157	5785	17.22	17.01	<b>102.957</b>	20.13	28.03	Pass
165	5825	17.11	17.01	101.639	20.07	28.03	Pass

Note:

U-NII-1 Band: Beamforming Directional gain =  $4.93\text{dBi} + 10\log(2) = 7.94\text{dBi} > 6\text{dBi}$ , so the limit shall be reduced to  $30 - (7.94 - 6) = 28.06\text{dBm}$ .

U-NII-3 Band: Beamforming Directional gain =  $4.96\text{dBi} + 10\log(2) = 7.97\text{dBi} > 6\text{dBi}$ , so the limit shall be reduced to  $30 - (7.97 - 6) = 28.03\text{dBm}$ .

#### 802.11ax (HE40)

Chan.	Freq. (MHz)	Maximum Conducted Power (dBm)		Total Power (mW)	Total Power (dBm)	Power Limit (dBm)	Pass / Fail
		Chain 0	Chain 1				
38	5190	16.04	15.98	79.807	19.02	28.06	Pass
46	5230	16.81	16.56	93.263	19.70	28.06	Pass
151	5755	16.95	16.81	97.518	19.89	28.03	Pass
159	5795	16.76	16.72	94.414	19.75	28.03	Pass

Note:

U-NII-1 Band: Beamforming Directional gain =  $4.93\text{dBi} + 10\log(2) = 7.94\text{dBi} > 6\text{dBi}$ , so the limit shall be reduced to  $30 - (7.94 - 6) = 28.06\text{dBm}$ .

U-NII-3 Band: Beamforming Directional gain =  $4.96\text{dBi} + 10\log(2) = 7.97\text{dBi} > 6\text{dBi}$ , so the limit shall be reduced to  $30 - (7.97 - 6) = 28.03\text{dBm}$ .

#### 802.11ax (HE80)

Chan.	Freq. (MHz)	Maximum Conducted Power (dBm)		Total Power (mW)	Total Power (dBm)	Power Limit (dBm)	Pass / Fail
		Chain 0	Chain 1				
42	5210	15.90	15.72	76.230	18.82	28.06	Pass
155	5775	15.68	15.55	72.875	18.63	28.03	Pass

Note:

U-NII-1 Band: Beamforming Directional gain =  $4.93\text{dBi} + 10\log(2) = 7.94\text{dBi} > 6\text{dBi}$ , so the limit shall be reduced to  $30 - (7.94 - 6) = 28.06\text{dBm}$ .

U-NII-3 Band: Beamforming Directional gain =  $4.96\text{dBi} + 10\log(2) = 7.97\text{dBi} > 6\text{dBi}$ , so the limit shall be reduced to  $30 - (7.97 - 6) = 28.03\text{dBm}$ .

### Scanning radio:

#### 802.11a

Chan.	Freq. (MHz)	Maximum Conducted Power (dBm)		Total Power (mW)	Total Power (dBm)	Power Limit (dBm)	Pass / Fail
		Chain 0	Chain 1				
36	5180	17.84	17.89	122.331	20.88	30.00	Pass
40	5200	17.69	17.65	116.959	20.68	30.00	Pass
48	5240	17.12	17.04	102.105	20.09	30.00	Pass
149	5745	20.76	20.02	219.586	23.42	29.85	Pass
157	5785	20.57	20.03	214.718	23.32	29.85	Pass
165	5825	20.58	20.08	216.147	23.35	29.85	Pass

Note: U-NII-3: Antenna Gain = 6.15dBi > 6dBi, so the limit shall be reduced to  $30-(6.15-6) = 29.85$ dBm.

#### 802.11ac (VHT20)

Chan.	Freq. (MHz)	Maximum Conducted Power (dBm)		Total Power (mW)	Total Power (dBm)	Power Limit (dBm)	Pass / Fail
		Chain 0	Chain 1				
36	5180	18.01	17.79	<b>123.359</b>	20.91	30.00	Pass
40	5200	17.52	17.40	111.448	20.47	30.00	Pass
48	5240	17.49	17.50	112.339	20.51	30.00	Pass
149	5745	20.66	20.25	222.338	23.47	29.85	Pass
157	5785	20.55	20.12	216.303	23.35	29.85	Pass
165	5825	20.64	20.07	217.503	23.37	29.85	Pass

Note: U-NII-3: Antenna Gain = 6.15dBi > 6dBi, so the limit shall be reduced to  $30-(6.15-6) = 29.85$ dBm.

#### 802.11ac (VHT40)

Chan.	Freq. (MHz)	Maximum Conducted Power (dBm)		Total Power (mW)	Total Power (dBm)	Power Limit (dBm)	Pass / Fail
		Chain 0	Chain 1				
38	5190	14.55	14.41	56.116	17.49	30.00	Pass
46	5230	20.25	20.31	213.324	23.29	30.00	Pass
151	5755	20.94	20.77	243.564	23.87	29.85	Pass
159	5795	20.92	20.68	240.545	23.81	29.85	Pass

Note: U-NII-3: Antenna Gain = 6.15dBi > 6dBi, so the limit shall be reduced to  $30-(6.15-6) = 29.85$ dBm.

#### 802.11ac (VHT80)

Chan.	Freq. (MHz)	Maximum Conducted Power (dBm)		Total Power (mW)	Total Power (dBm)	Power Limit (dBm)	Pass / Fail
		Chain 0	Chain 1				
42	5210	13.84	14.02	49.445	16.94	30.00	Pass
155	5775	20.98	20.82	<b>246.096</b>	23.91	29.85	Pass

Note: U-NII-3: Antenna Gain = 6.15dBi > 6dBi, so the limit shall be reduced to  $30-(6.15-6) = 29.85$ dBm.

## 4.4 Occupied Bandwidth Measurement

### 4.4.1 Test Setup

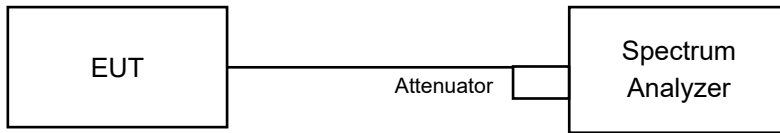

### 4.4.2 Test Instruments

Refer to section 4.1.2 to get information of above instrument.

### 4.4.3 Test Procedure

The transmitter output was connected to the spectrum analyzer through an attenuator. The bandwidth of the fundamental frequency was measured by spectrum analyzer with resolution bandwidth in the range of 1% to 5% of the anticipated emission bandwidth, and a video bandwidth at least 3x the resolution bandwidth and set the detector to sampling. The width of a frequency band such that, below the lower and above the upper frequency limits, the mean powers emitted are each equal to a specified percentage 0.5 %of the total mean power of a given emission.



#### 4.4.4 Test Result

##### 5G traffic radio:

##### 802.11a

Channel	Frequency (MHz)	Occupied Bandwidth (MHz)	
		Chain 0	Chain 1
36	5180	16.44	16.44
40	5200	16.44	16.44
48	5240	16.44	16.44
149	5745	16.44	16.44
157	5785	16.44	16.44
165	5825	16.44	16.44

##### 802.11ax (HE20)

Channel	Frequency (MHz)	Occupied Bandwidth (MHz)	
		Chain 0	Chain 1
36	5180	19.08	18.96
40	5200	19.08	18.96
48	5240	18.96	19.08
149	5745	18.96	19.08
157	5785	19.08	18.96
165	5825	19.08	18.96

##### 802.11ax (HE40)

Channel	Frequency (MHz)	Occupied Bandwidth (MHz)	
		Chain 0	Chain 1
38	5190	38.04	38.04
46	5230	37.92	37.92
151	5755	38.04	38.04
159	5795	37.92	38.04

##### 802.11ax (HE80)

Channel	Frequency (MHz)	Occupied Bandwidth (MHz)	
		Chain 0	Chain 1
42	5210	77.04	77.28
155	5775	77.28	77.04

### Spectrum Plot of Worst Value

#### 802.11a

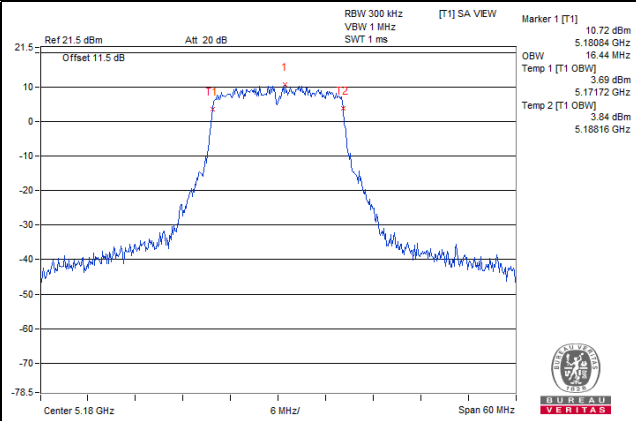

#### 802.11ax (HE20)

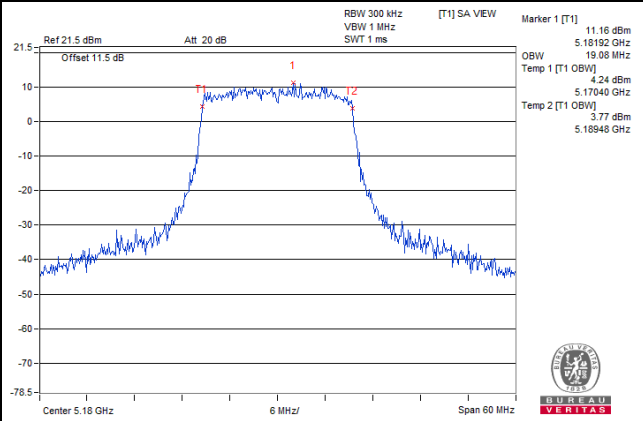

#### 802.11ax (HE40)

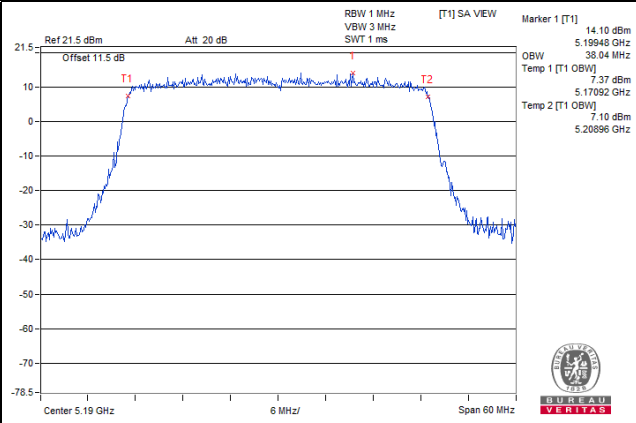

#### 802.11ax (HE80)

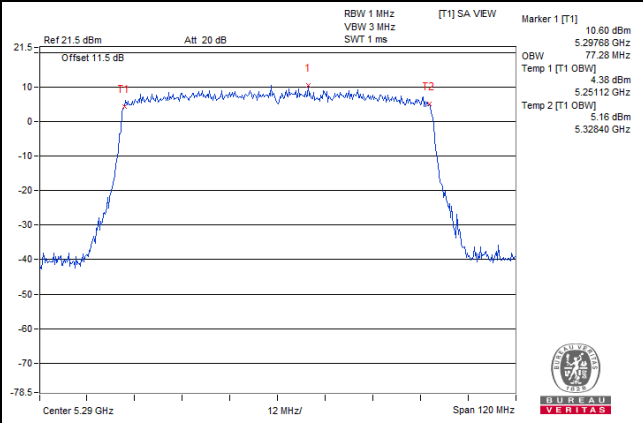

Spectrum Plot for near By DFS Band

802.11a / Chain 0 / CH 48

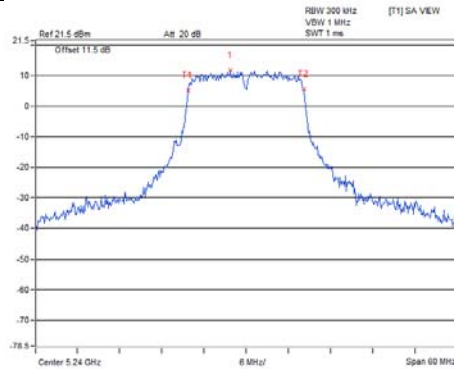

802.11a / Chain 1 / CH 48

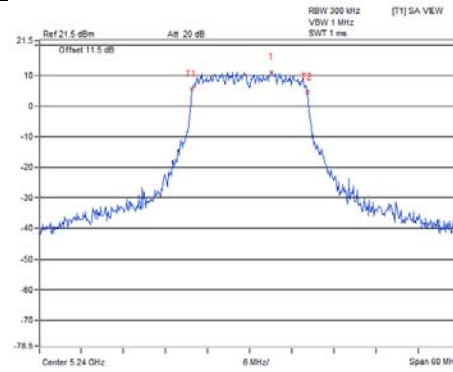

802.11ax (HE20) / Chain 0 / CH 48

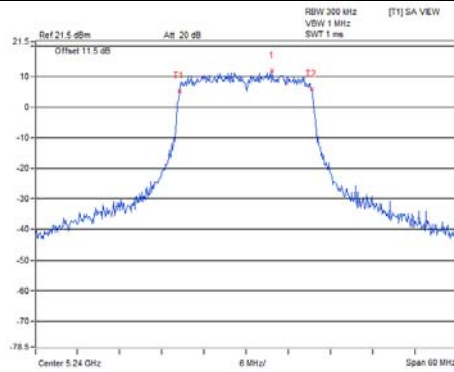

802.11ax (HE20) / Chain 1 / CH 48

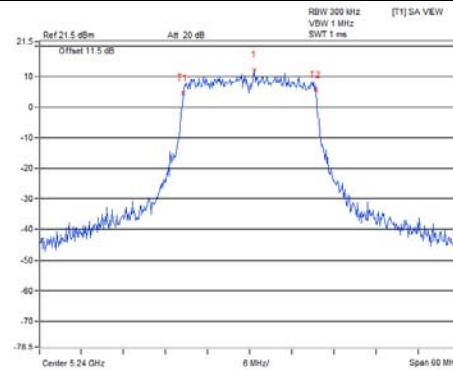

802.11ax (HE40) / Chain 0 / CH 46

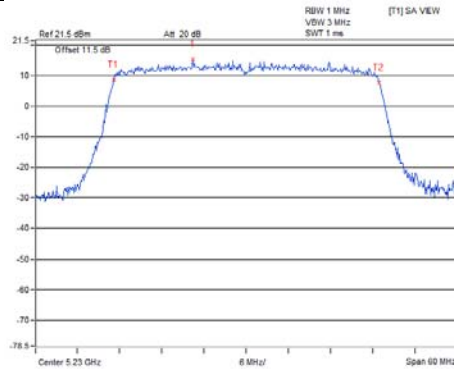

802.11ax (HE40) / Chain 1 / CH 46

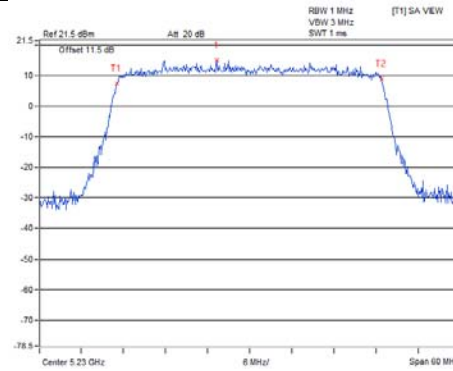

802.11ax (HE80) / Chain 0 / CH 42

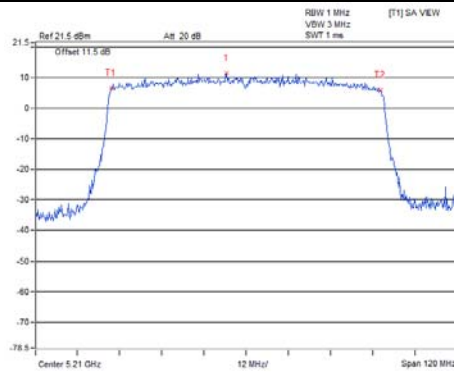

802.11ax (HE80) / Chain 1 / CH 42

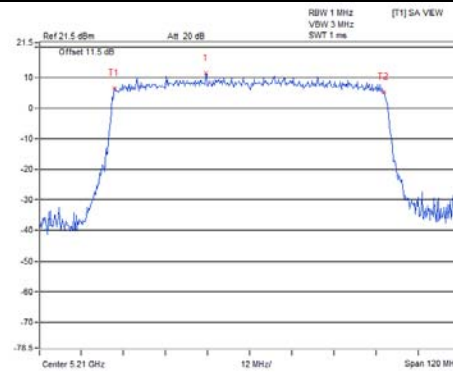

**Spectrum Plot for near By DFS Band**

**802.11a / Chain 0 / CH 149**

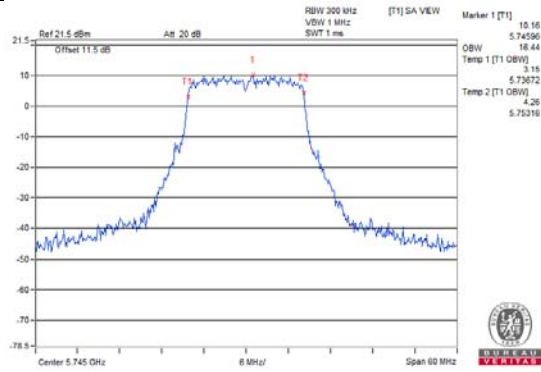

**802.11a / Chain 1 / CH 149**

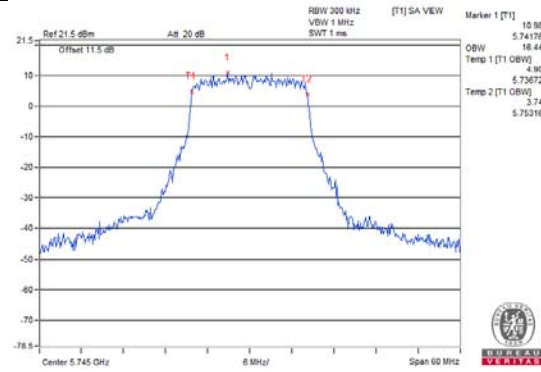

**802.11ax (HE20) / Chain 0 / CH 149**

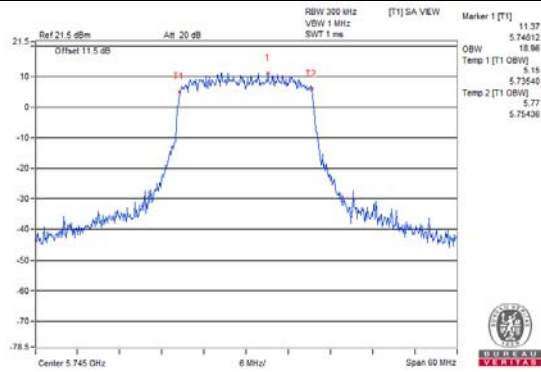

**802.11ax (HE20) / Chain 1 / CH 149**

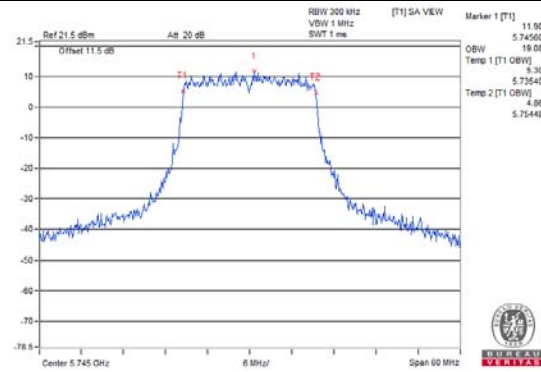

**802.11ax (HE40) / Chain 0 / CH 151**

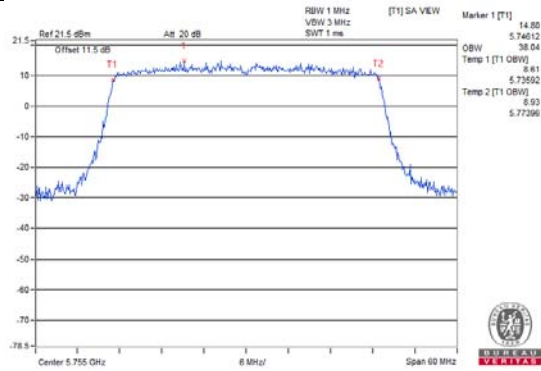

**802.11ax (HE40) / Chain 1 / CH 151**

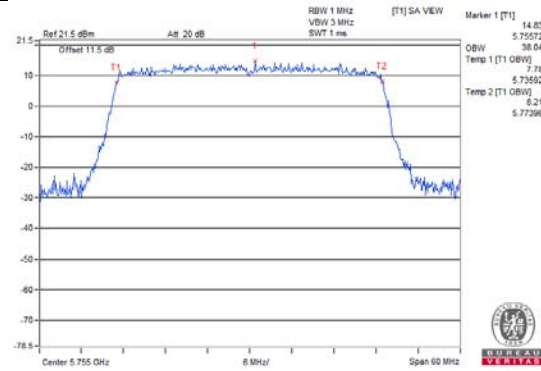

**802.11ax (HE80) / Chain 0 / CH 155**

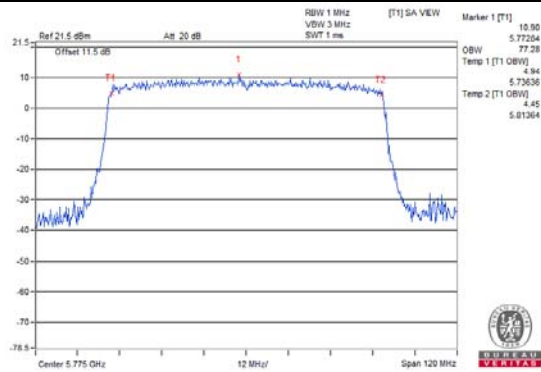

**802.11ax (HE80) / Chain 1 / CH 155**

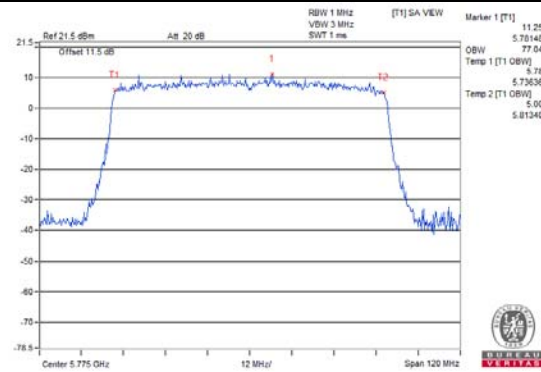

**Scanning radio:**

## 802.11a

Channel	Frequency (MHz)	Occupied Bandwidth (MHz)	
		Chain 0	Chain 1
36	5180	17.04	16.80
40	5200	17.04	16.80
48	5240	17.04	16.92
149	5745	17.64	17.65
157	5785	18.00	17.76
165	5825	17.52	17.76

## 802.11ac (VHT20)

Channel	Frequency (MHz)	Occupied Bandwidth (MHz)	
		Chain 0	Chain 1
36	5180	18.12	18.00
40	5200	18.12	18.12
48	5240	18.12	18.12
149	5745	18.96	18.96
157	5785	18.96	18.72
165	5825	18.48	18.72

## 802.11ac (VHT40)

Channel	Frequency (MHz)	Occupied Bandwidth (MHz)	
		Chain 0	Chain 1
38	5190	36.96	36.96
46	5230	38.04	37.92
151	5755	38.40	38.28
159	5795	38.52	38.16

## 802.11ac (VHT80)

Channel	Frequency (MHz)	Occupied Bandwidth (MHz)	
		Chain 0	Chain 1
42	5210	76.08	76.32
155	5775	77.76	77.22

### Spectrum Plot of Worst Value

#### 802.11a

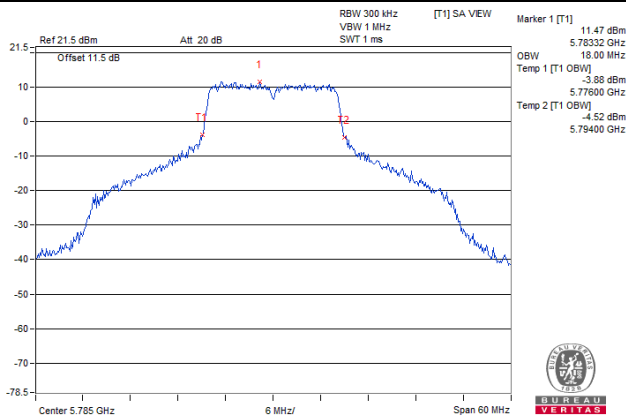

#### 802.11ac (VHT20)

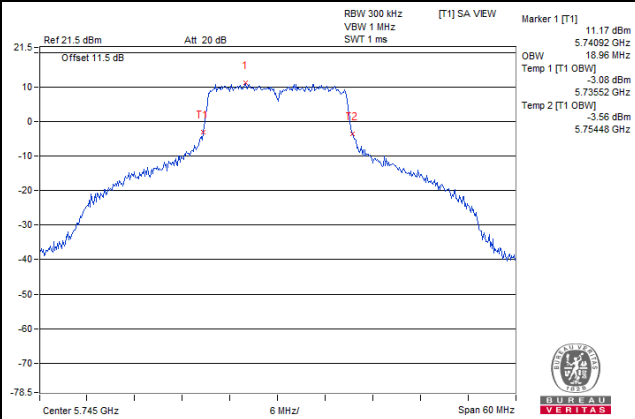

#### 802.11ac (VHT40)

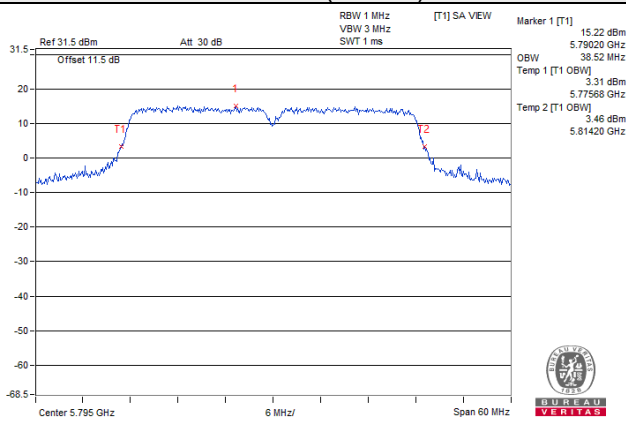

#### 802.11ac (VHT80)

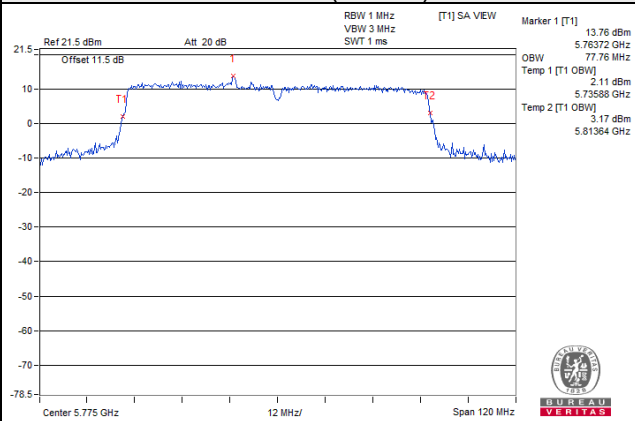

**Spectrum Plot for near By DFS Band**

**802.11a / Chain 0 / CH 48**

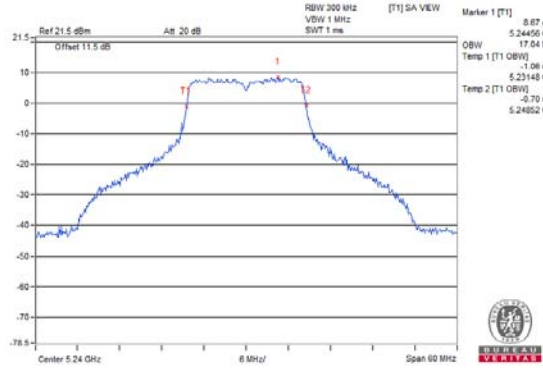

**802.11a / Chain 1 / CH 48**

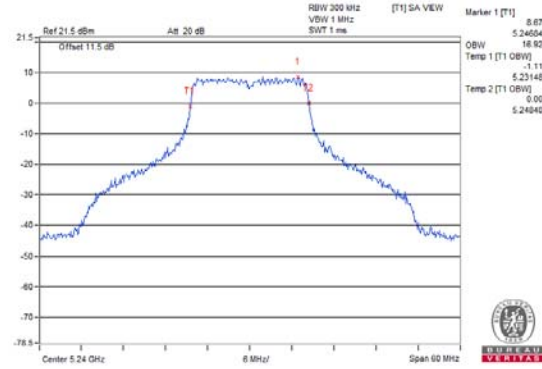

**802.11ac (VHT20) / Chain 0 / CH 48**

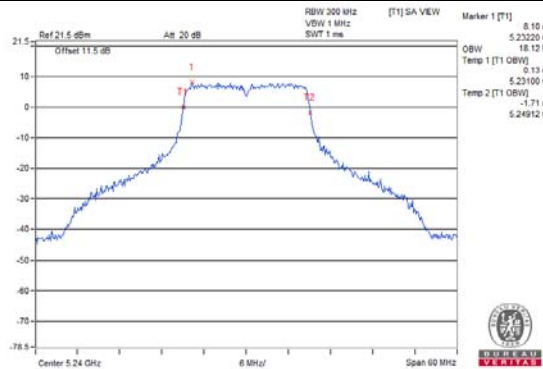

**802.11ac (VHT20) / Chain 1 / CH 48**

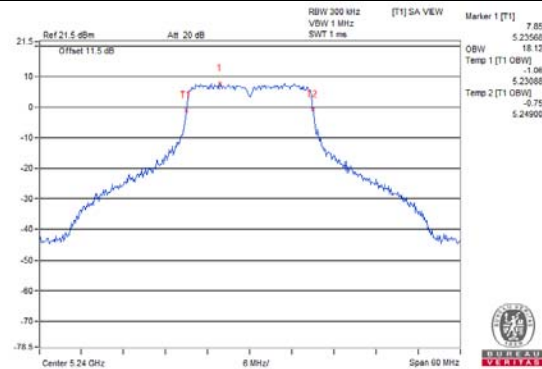

**802.11ac (VHT40) / Chain 0 / CH 46**

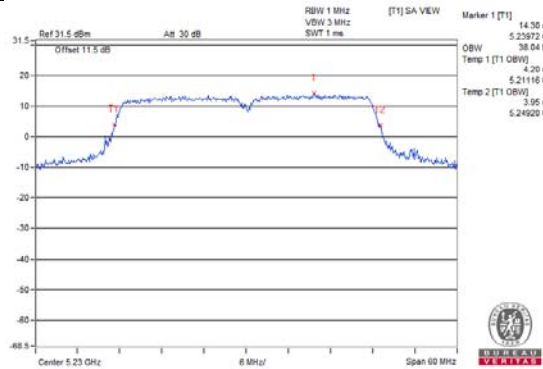

**802.11ac (VHT40) / Chain 1 / CH 46**

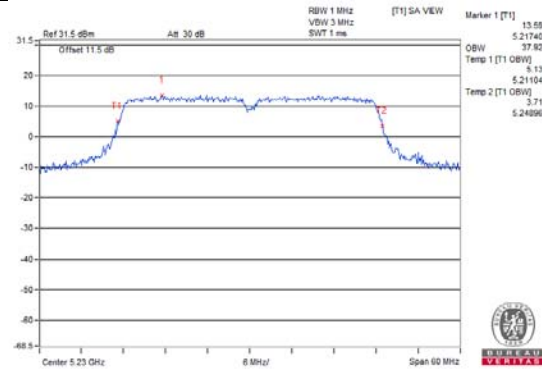

**802.11ac (VHT80) / Chain 0 / CH 42**

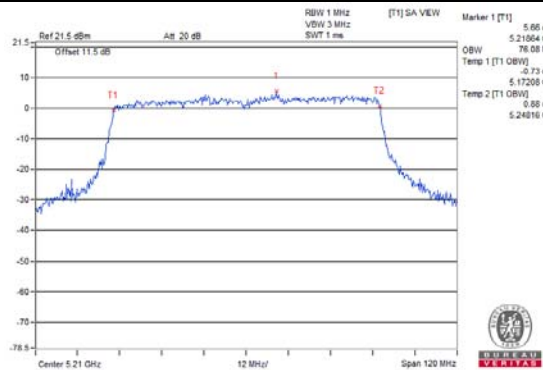

**802.11ac (VHT80) / Chain 1 / CH 42**

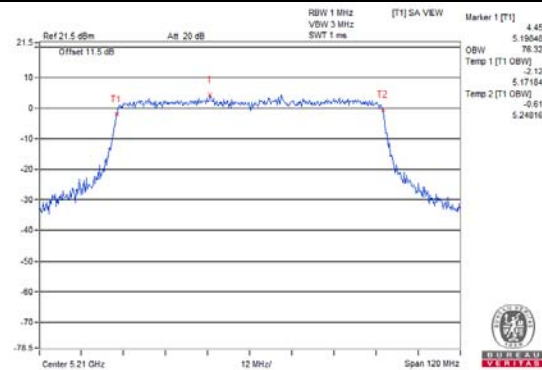



**Spectrum Plot for near By DFS Band**

**802.11a / Chain 0 / CH 149**

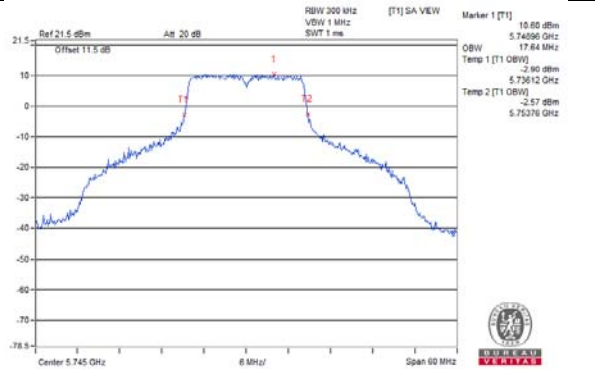

**802.11a / Chain 1 / CH 149**

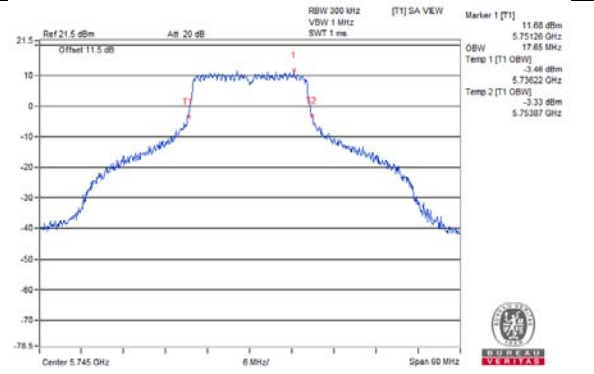

**802.11ac (VHT20) / Chain 0 / CH 149**

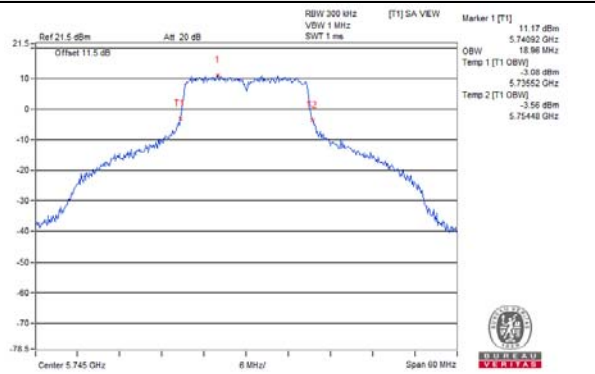

**802.11ac (VHT20) / Chain 1 / CH 149**

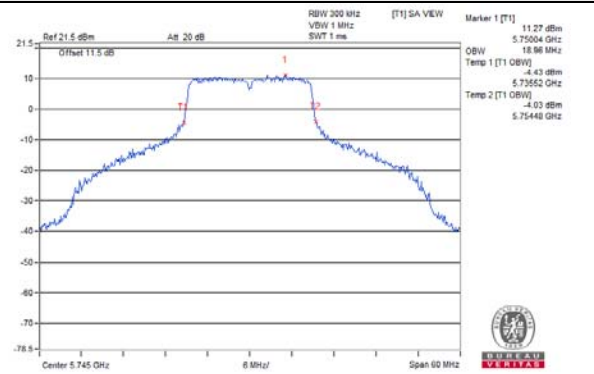

**802.11ac (VHT40) / Chain 0 / CH 151**

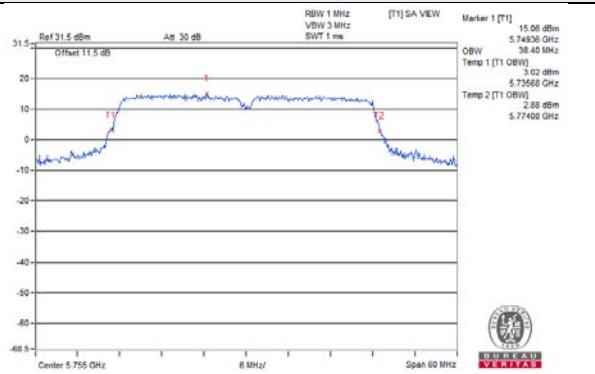

**802.11ac (VHT40) / Chain 1 / CH 151**

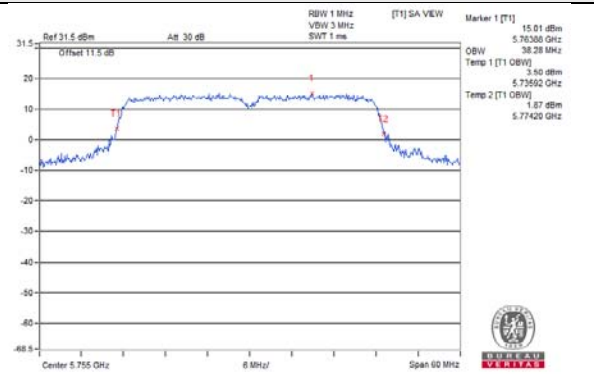

**802.11ac (VHT80) / Chain 0 / CH 155**

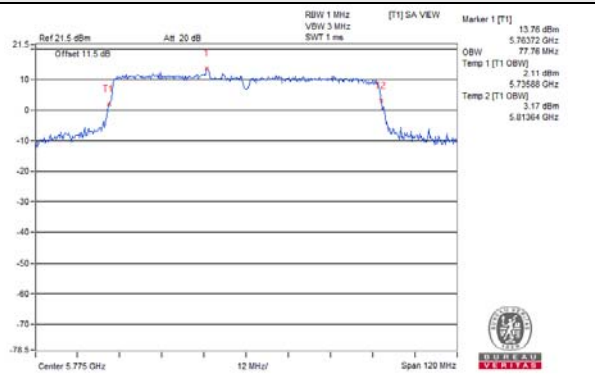

**802.11ac (VHT80) / Chain 1 / CH 155**

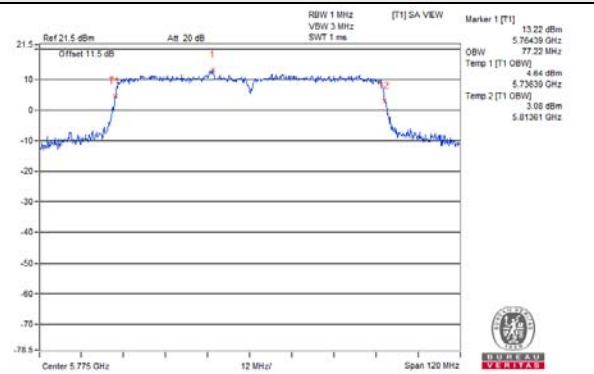



## 4.5 Peak Power Spectral Density Measurement

### 4.5.1 Limits of Peak Power Spectral Density Measurement

Operation Band	EUT Category		LIMIT
U-NII-1		Outdoor Access Point	17dBm/ MHz
		Fixed point-to-point Access Point	
	√	Indoor Access Point	11dBm/ MHz
		Mobile and Portable client device	
U-NII-2A	-		11dBm/ MHz
U-NII-2C	-		11dBm/ MHz
U-NII-3	√		30dBm/ 500kHz

### 4.5.2 Test Setup

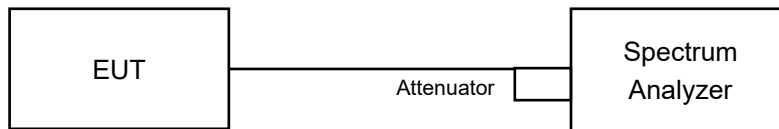

### 4.5.3 Test Instruments

Refer to section 4.1.2 to get information of above instrument.

### 4.5.4 Test Procedures

#### For U-NII-1 band:

Duty cycle of test signal is < 98%

Using method SA-2

- 1) Set span to encompass the entire emission bandwidth (EBW) of the signal.
- 2) Set RBW = 1MHz, Set VBW ≥ 3 MHz, Detector = RMS.
- 3) Set Channel power measure = 1MHz.
- 4) Sweep time = auto, trigger set to “free run”.
- 5) Trace average at least 100 traces in power averaging mode.
- 6) Record the max value and add 10 log (1/duty cycle).

#### For U-NII-3 band:

Duty cycle of test signal is < 98%

- 1) Set span to encompass the entire emission bandwidth (EBW) of the signal.
- 2) Set RBW = 300 kHz, Set VBW ≥ 1 MHz, Detector = RMS.
- 3) Use the peak marker function to determine the maximum power level in any 300 kHz band segment within the fundamental EBW.
- 4) Scale the observed power level to an equivalent value in 500 kHz by adjusting (Increasing) the measured power by a bandwidth correction factor (BWCF) where  $BWCF = 10\log(500 \text{ kHz} / 300 \text{ kHz})$ .
- 5) Sweep time = auto, trigger set to “free run”.
- 6) Trace average at least 100 traces in power averaging mode.
- 7) Record the max value and add 10 log (1/duty cycle).

#### **4.5.5 Deviation from Test Standard**

No deviation.

#### **4.5.6 EUT Operating Conditions**

Same as 4.3.6.

#### 4.5.7 Test Results

##### 5G traffic radio:

For U-NII-1 band:

##### 802.11a

Chan.	Freq. (MHz)	PSD W/O Duty Factor (dBm/MHz)		Duty Factor (dB)	Total PSD With Duty Factor (dBm/MHz)	Max. Limit (dBm/MHz)	Pass / Fail
		Chain 0	Chain 1				
36	5180	6.26	6.00	0.27	9.42	15.06	Pass
40	5200	7.20	6.95	0.27	10.36	15.06	Pass
48	5240	7.05	6.81	0.27	10.22	15.06	Pass

Note:

- Method E) 2) a) of power density measurement of KDB 662911 is using for calculating total power density. Total power density is summing entire spectra across corresponding frequency bins on the various outputs by computer.
- Directional Gain =  $4.93\text{dBi} + 10\log(2) = 7.94\text{dBi} > 6\text{dBi}$ , so the limit shall be reduced to  $17-(7.94-6) = 15.06\text{dBm}$ .
- Refer to section 3.3 for duty cycle spectrum plot.

##### 802.11ax (HE20)

Chan.	Freq. (MHz)	PSD W/O Duty Factor (dBm/MHz)		Duty Factor (dB)	Total PSD With Duty Factor (dBm/MHz)	Max. Limit (dBm/MHz)	Pass / Fail
		Chain 0	Chain 1				
36	5180	5.05	4.86	0.20	8.17	15.06	Pass
40	5200	5.75	5.50	0.20	8.84	15.06	Pass
48	5240	5.59	5.26	0.20	8.64	15.06	Pass

Note:

- Method E) 2) a) of power density measurement of KDB 662911 is using for calculating total power density. Total power density is summing entire spectra across corresponding frequency bins on the various outputs by computer.
- Directional Gain =  $4.93\text{dBi} + 10\log(2) = 7.94\text{dBi} > 6\text{dBi}$ , so the limit shall be reduced to  $17-(7.94-6) = 15.06\text{dBm}$ .
- Refer to section 3.3 for duty cycle spectrum plot.

##### 802.11ax (HE40)

Chan.	Freq. (MHz)	PSD W/O Duty Factor (dBm/MHz)		Duty Factor (dB)	Total PSD With Duty Factor (dBm/MHz)	Max. Limit (dBm/MHz)	Pass / Fail
		Chain 0	Chain 1				
38	5190	1.80	0.83	0.73	5.08	15.06	Pass
46	5230	1.82	2.04	0.73	5.67	15.06	Pass

Note:

- Method E) 2) a) of power density measurement of KDB 662911 is using for calculating total power density. Total power density is summing entire spectra across corresponding frequency bins on the various outputs by computer.
- Directional Gain =  $4.93\text{dBi} + 10\log(2) = 7.94\text{dBi} > 6\text{dBi}$ , so the limit shall be reduced to  $17-(7.94-6) = 15.06\text{dBm}$ .
- Refer to section 3.3 for duty cycle spectrum plot.

802.11ax (HE80)

Chan.	Freq. (MHz)	PSD W/O Duty Factor (dBm/MHz)		Duty Factor (dB)	Total PSD With Duty Factor (dBm/MHz)	Max. Limit (dBm/MHz)	Pass / Fail
		Chain 0	Chain 1				
42	5210	-3.17	-1.61	0.23	0.92	15.06	Pass

Note:

- Method E) 2) a) of power density measurement of KDB 662911 is using for calculating total power density. Total power density is summing entire spectra across corresponding frequency bins on the various outputs by computer.
- Directional Gain =  $4.93\text{dBi} + 10\log(2) = 7.94\text{dBi} > 6\text{dBi}$ , so the limit shall be reduced to  $17 - (7.94 - 6) = 15.06\text{dBm}$ .
- Refer to section 3.3 for duty cycle spectrum plot.

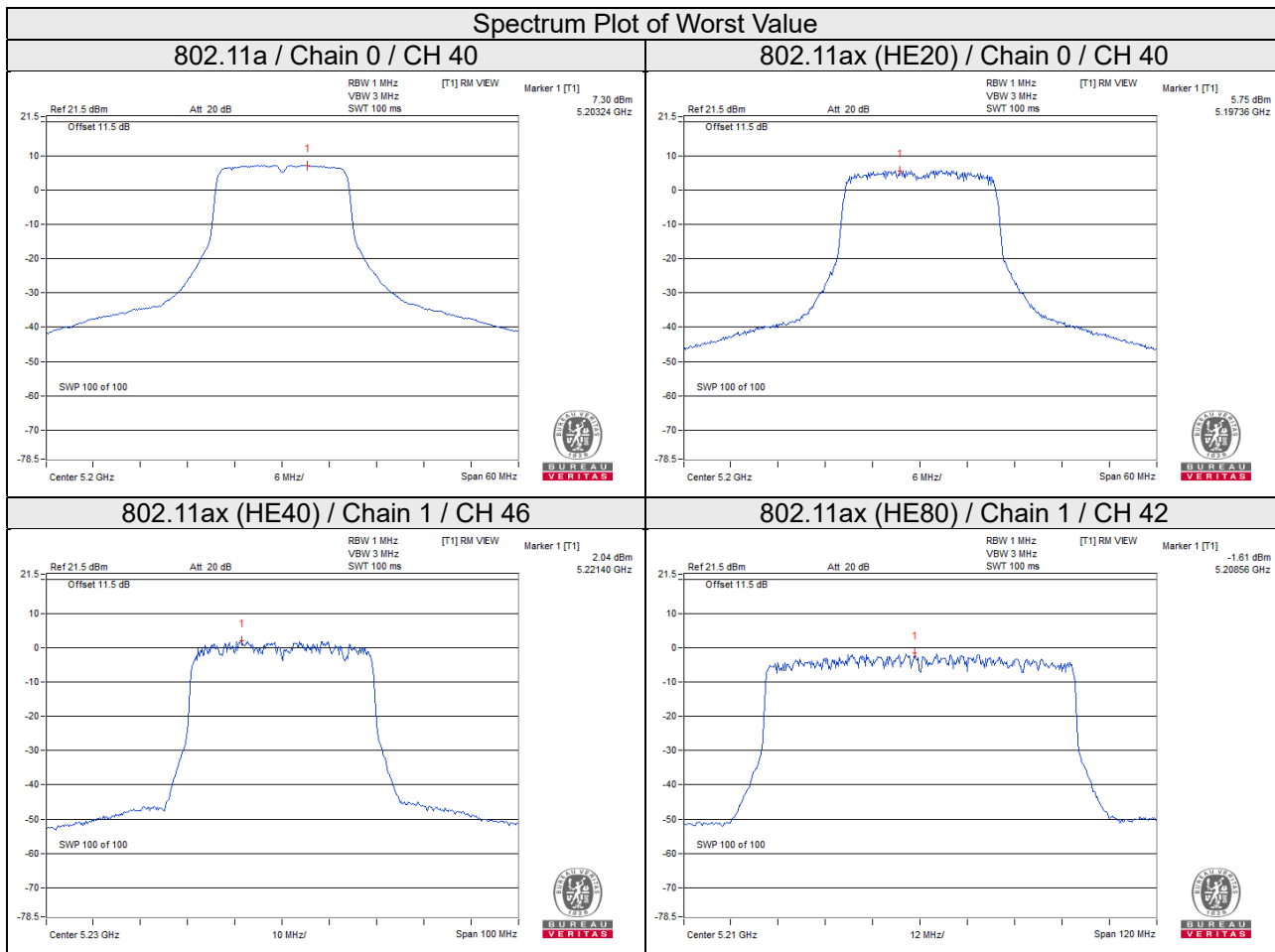

For U-NII-3 band:

802.11a

TX chain	Chan.	Freq. (MHz)	PSD W/O Duty Factor		10 log (N=2) dB	Duty Factor (dB)	Total PSD With Duty Factor (dBm/500kHz)	Limit (dBm/500kHz)	Pass / Fail
			(dBm/300kHz)	(dBm/500kHz)					
0	149	5745	-2.39	-0.17	3.01	0.27	3.11	28.03	Pass
	157	5785	-2.59	-0.37	3.01	0.27	2.91	28.03	Pass
	165	5825	-2.82	-0.60	3.01	0.27	2.68	28.03	Pass
1	149	5745	-2.20	0.02	3.01	0.27	3.30	28.03	Pass
	157	5785	-2.91	-0.69	3.01	0.27	2.59	28.03	Pass
	165	5825	-2.77	-0.55	3.01	0.27	2.73	28.03	Pass

Note:

1. Method E) 2) c) of power density measurement of KDB 662911 is using for calculating total power density.
2. Directional Gain =  $4.96\text{dBi} + 10\log(2) = 7.97\text{dBi} > 6\text{dBi}$ , so the limit shall be reduced to  $30 - (7.97 - 6) = 28.03\text{dBm}$ .
3. Refer to section 3.3 for duty cycle spectrum plot.

802.11ax (HE20)

TX chain	Chan.	Freq. (MHz)	PSD W/O Duty Factor		10 log (N=2) dB	Duty Factor (dB)	Total PSD With Duty Factor (dBm/500kHz)	Limit (dBm/500kHz)	Pass / Fail
			(dBm/300kHz)	(dBm/500kHz)					
0	149	5745	-3.48	-1.26	3.01	0.20	1.95	28.03	Pass
	157	5785	-3.37	-1.15	3.01	0.20	2.06	28.03	Pass
	165	5825	-3.64	-1.42	3.01	0.20	1.79	28.03	Pass
1	149	5745	-3.40	-1.18	3.01	0.20	2.03	28.03	Pass
	157	5785	-3.72	-1.50	3.01	0.20	1.71	28.03	Pass
	165	5825	-3.73	-1.51	3.01	0.20	1.70	28.03	Pass

Note:

1. Method E) 2) c) of power density measurement of KDB 662911 is using for calculating total power density.
2. Directional Gain =  $4.96\text{dBi} + 10\log(2) = 7.97\text{dBi} > 6\text{dBi}$ , so the limit shall be reduced to  $30 - (7.97 - 6) = 28.03\text{dBm}$ .
3. Refer to section 3.3 for duty cycle spectrum plot.

### 802.11ax (HE40)

TX chain	Chan.	Freq. (MHz)	PSD W/O Duty Factor		10 log (N=2) dB	Duty Factor (dB)	Total PSD With Duty Factor (dBm/500kHz)	Limit (dBm/500kHz)	Pass / Fail
			(dBm/300kHz)	(dBm/500kHz)					
0	151	5755	-6.83	-4.61	3.01	0.73	-0.87	28.03	Pass
	159	5795	-6.90	-4.68	3.01	0.73	-0.94	28.03	Pass
1	151	5755	-6.84	-4.62	3.01	0.73	-0.88	28.03	Pass
	159	5795	-6.96	-4.74	3.01	0.73	-1.00	28.03	Pass

Note:

1. Method E) 2) c) of power density measurement of KDB 662911 is using for calculating total power density.
2. Directional Gain = 4.96dBi + 10log(2) = 7.97dBi > 6dBi, so the limit shall be reduced to 30-(7.97-6) = 28.03dBm.
3. Refer to section 3.3 for duty cycle spectrum plot.

### 802.11ax (HE80)

TX chain	Chan.	Freq. (MHz)	PSD W/O Duty Factor		10 log (N=2) dB	Duty Factor (dB)	Total PSD With Duty Factor (dBm/500kHz)	Limit (dBm/500kHz)	Pass / Fail
			(dBm/300kHz)	(dBm/500kHz)					
0	155	5775	-10.99	-8.77	3.01	0.23	-5.53	28.03	Pass
1	155	5775	-11.08	-8.86	3.01	0.23	-5.62	28.03	Pass

Note:

1. Method E) 2) c) of power density measurement of KDB 662911 is using for calculating total power density.
2. Directional Gain = 4.96dBi + 10log(2) = 7.97dBi > 6dBi, so the limit shall be reduced to 30-(7.97-6) = 28.03dBm.
3. Refer to section 3.3 for duty cycle spectrum plot.

Spectrum Plot of Worst Value

802.11a

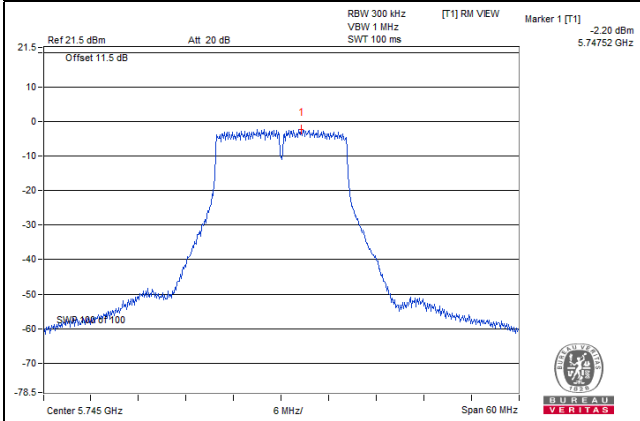

802.11ax (HE20)

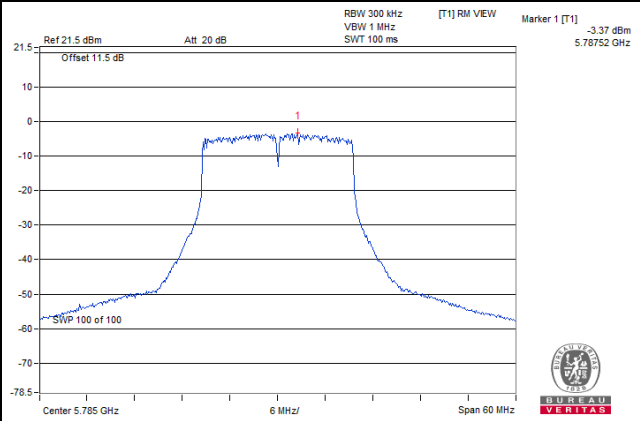

802.11ax (HE40)

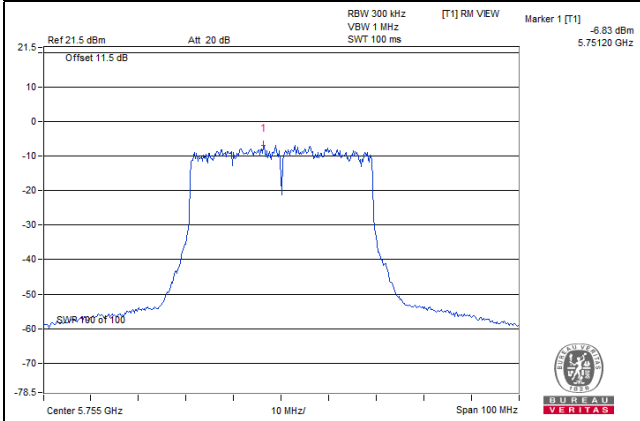

802.11ax (HE80)

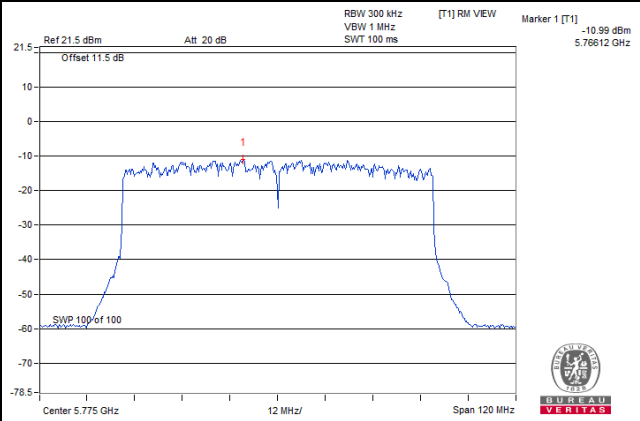

**Scanning radio:**

For U-NII-1 band:

802.11a

Chan.	Freq. (MHz)	PSD W/O Duty Factor (dBm/MHz)		Duty Factor (dB)	Total PSD With Duty Factor (dBm/MHz)	Max. Limit (dBm/MHz)	Pass / Fail
		Chain 0	Chain 1				
36	5180	4.64	4.56	0.18	7.79	14.32	Pass
40	5200	4.53	4.50	0.18	7.70	14.32	Pass
48	5240	4.62	4.37	0.18	7.69	14.32	Pass

Note:

- Method E) 2) a) of power density measurement of KDB 662911 is using for calculating total power density. Total power density is summing entire spectra across corresponding frequency bins on the various outputs by computer.
- Directional Gain =  $5.67\text{dBi} + 10\log(2) = 8.68\text{dBi} > 6\text{dBi}$ , so the limit shall be reduced to  $17 - (8.68 - 6) = 14.32\text{dBm}$ .
- Refer to section 3.3 for duty cycle spectrum plot.

802.11ac (VHT20)

Chan.	Freq. (MHz)	PSD W/O Duty Factor (dBm/MHz)		Duty Factor (dB)	Total PSD With Duty Factor (dBm/MHz)	Max. Limit (dBm/MHz)	Pass / Fail
		Chain 0	Chain 1				
36	5180	4.97	4.80	0.18	8.08	14.32	Pass
40	5200	4.60	4.55	0.18	7.77	14.32	Pass
48	5240	4.66	4.51	0.18	7.78	14.32	Pass

Note:

- Method E) 2) a) of power density measurement of KDB 662911 is using for calculating total power density. Total power density is summing entire spectra across corresponding frequency bins on the various outputs by computer.
- Directional Gain =  $5.67\text{dBi} + 10\log(2) = 8.68\text{dBi} > 6\text{dBi}$ , so the limit shall be reduced to  $17 - (8.68 - 6) = 14.32\text{dBm}$ .
- Refer to section 3.3 for duty cycle spectrum plot.

802.11ac (VHT40)

Chan.	Freq. (MHz)	PSD W/O Duty Factor (dBm/MHz)		Duty Factor (dB)	Total PSD With Duty Factor (dBm/MHz)	Max. Limit (dBm/MHz)	Pass / Fail
		Chain 0	Chain 1				
38	5190	-2.15	-3.07	0.36	0.78	14.32	Pass
46	5230	3.50	2.90	0.36	6.58	14.32	Pass

Note:

- Method E) 2) a) of power density measurement of KDB 662911 is using for calculating total power density. Total power density is summing entire spectra across corresponding frequency bins on the various outputs by computer.
- Directional Gain =  $5.67\text{dBi} + 10\log(2) = 8.68\text{dBi} > 6\text{dBi}$ , so the limit shall be reduced to  $17 - (8.68 - 6) = 14.32\text{dBm}$ .
- Refer to section 3.3 for duty cycle spectrum plot.



802.11ac (VHT80)

Chan.	Freq. (MHz)	PSD W/O Duty Factor (dBm/MHz)		Duty Factor (dB)	Total PSD With Duty Factor (dBm/MHz)	Max. Limit (dBm/MHz)	Pass / Fail
		Chain 0	Chain 1				
42	5210	-5.80	-7.05	0.76	-2.61	14.32	Pass

Note:

- Method E) 2) a) of power density measurement of KDB 662911 is using for calculating total power density. Total power density is summing entire spectra across corresponding frequency bins on the various outputs by computer.
- Directional Gain =  $5.67\text{dBi} + 10\log(2) = 8.68\text{dBi} > 6\text{dBi}$ , so the limit shall be reduced to  $17 - (8.68 - 6) = 14.32\text{dBm}$ .
- Refer to section 3.3 for duty cycle spectrum plot.

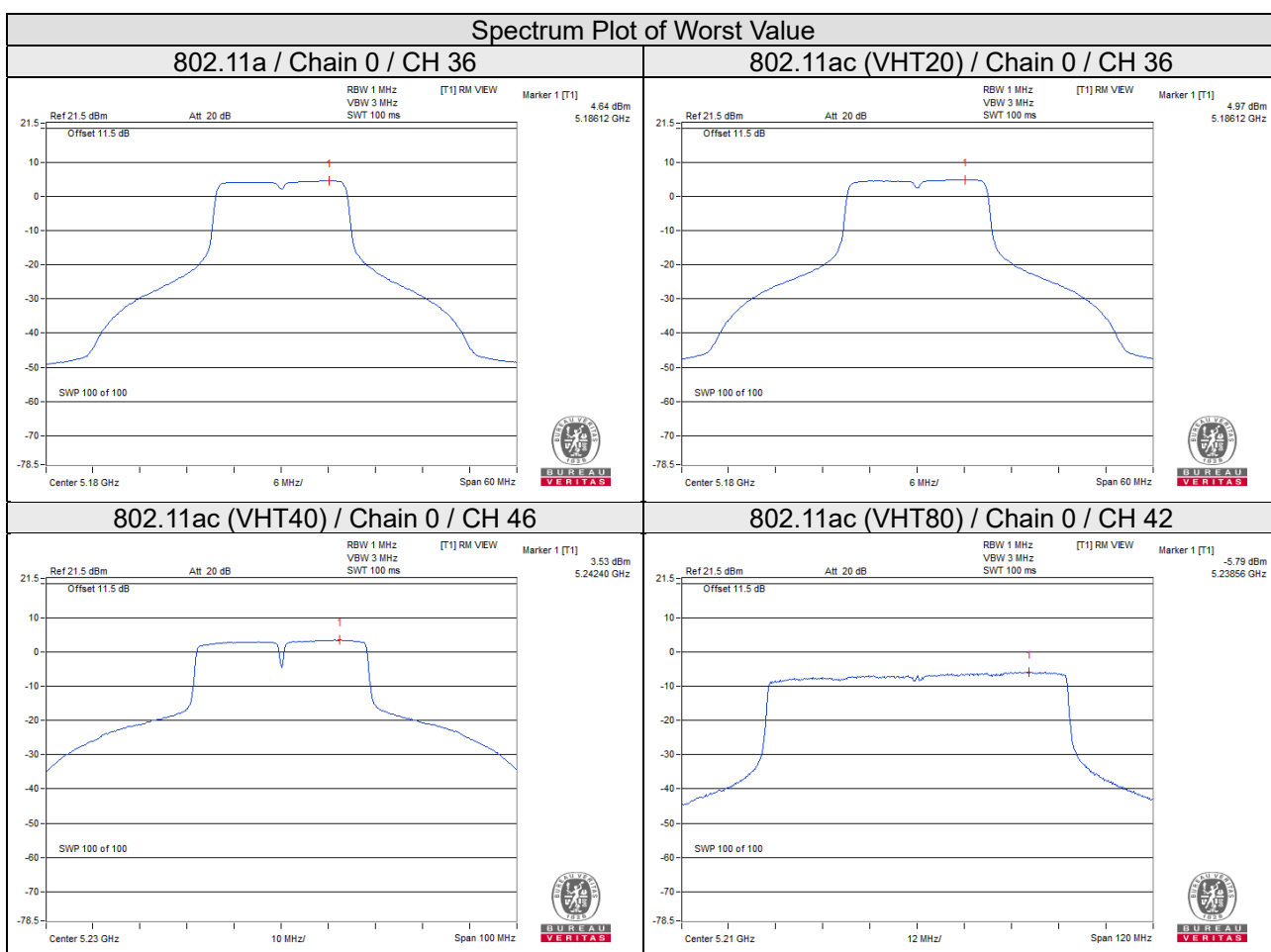

For U-NII-3 band:

802.11a

TX chain	Chan.	Freq. (MHz)	PSD W/O Duty Factor		10 log (N=2) dB	Duty Factor (dB)	Total PSD With Duty Factor (dBm/500kHz)	Limit (dBm/500kHz)	Pass / Fail
			(dBm/300kHz)	(dBm/500kHz)					
0	149	5745	-1.73	0.49	3.01	0.18	3.68	26.84	Pass
	157	5785	-1.31	0.91	3.01	0.18	4.10	26.84	Pass
	165	5825	-1.64	0.58	3.01	0.18	3.77	26.84	Pass
1	149	5745	-1.96	0.26	3.01	0.18	3.45	26.84	Pass
	157	5785	-1.41	0.81	3.01	0.18	4.00	26.84	Pass
	165	5825	-1.51	0.71	3.01	0.18	3.90	26.84	Pass

Note:

1. Method E) 2) c) of power density measurement of KDB 662911 is using for calculating total power density.
2. Directional Gain =  $6.15\text{dBi} + 10\log(2) = 9.16\text{dBi} > 6\text{dBi}$ , so the limit shall be reduced to  $30 - (9.16 - 6) = 26.84\text{dBm}$ .
3. Refer to section 3.3 for duty cycle spectrum plot.

802.11ac (VHT20)

TX chain	Chan.	Freq. (MHz)	PSD W/O Duty Factor		10 log (N=2) dB	Duty Factor (dB)	Total PSD With Duty Factor (dBm/500kHz)	Limit (dBm/500kHz)	Pass / Fail
			(dBm/300kHz)	(dBm/500kHz)					
0	149	5745	-1.87	0.35	3.01	0.18	3.54	26.84	Pass
	157	5785	-1.58	0.64	3.01	0.18	3.83	26.84	Pass
	165	5825	-1.97	0.25	3.01	0.18	3.44	26.84	Pass
1	149	5745	-1.73	0.49	3.01	0.18	3.68	26.84	Pass
	157	5785	-1.78	0.44	3.01	0.18	3.63	26.84	Pass
	165	5825	-1.65	0.57	3.01	0.18	3.76	26.84	Pass

Note:

1. Method E) 2) c) of power density measurement of KDB 662911 is using for calculating total power density.
2. Directional Gain =  $6.15\text{dBi} + 10\log(2) = 9.16\text{dBi} > 6\text{dBi}$ , so the limit shall be reduced to  $30 - (9.16 - 6) = 26.84\text{dBm}$ .
3. Refer to section 3.3 for duty cycle spectrum plot.

### 802.11ac (VHT40)

TX chain	Chan.	Freq. (MHz)	PSD W/O Duty Factor		10 log (N=2) dB	Duty Factor (dB)	Total PSD With Duty Factor (dBm/500kHz)	Limit (dBm/500kHz)	Pass / Fail
			(dBm/300kHz)	(dBm/500kHz)					
0	151	5755	-4.20	-1.98	3.01	0.36	1.39	26.84	Pass
	159	5795	-3.97	-1.75	3.01	0.36	1.62	26.84	Pass
1	151	5755	-4.28	-2.06	3.01	0.36	1.31	26.84	Pass
	159	5795	-4.19	-1.97	3.01	0.36	1.40	26.84	Pass

**Note:**

1. Method E) 2) c) of power density measurement of KDB 662911 is using for calculating total power density.
2. Directional Gain = 6.15dBi + 10log(2) = 9.16dBi > 6dBi, so the limit shall be reduced to 30-(9.16-6) = 26.84dBm.
3. Refer to section 3.3 for duty cycle spectrum plot.

### 802.11ac (VHT80)

TX chain	Chan.	Freq. (MHz)	PSD W/O Duty Factor		10 log (N=2) dB	Duty Factor (dB)	Total PSD With Duty Factor (dBm/500kHz)	Limit (dBm/500kHz)	Pass / Fail
			(dBm/300kHz)	(dBm/500kHz)					
0	155	5775	-7.47	-5.25	3.01	0.76	-1.48	26.84	Pass
1	155	5775	-7.63	-5.41	3.01	0.76	-1.64	26.84	Pass

**Note:**

1. Method E) 2) c) of power density measurement of KDB 662911 is using for calculating total power density.
2. Directional Gain = 6.15dBi + 10log(2) = 9.16dBi > 6dBi, so the limit shall be reduced to 30-(9.16-6) = 26.84dBm.
3. Refer to section 3.3 for duty cycle spectrum plot.

### Spectrum Plot of Worst Value

#### 802.11a

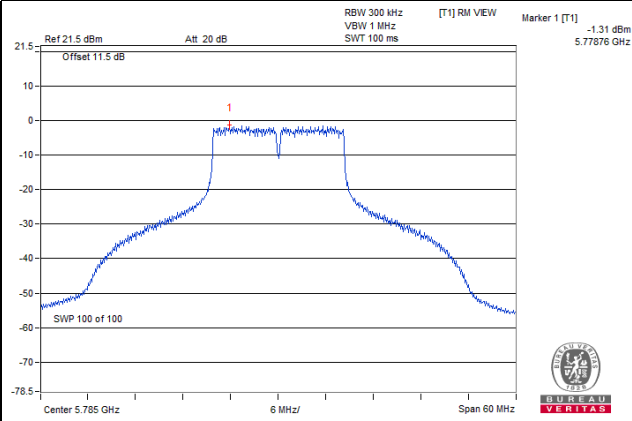

#### 802.11ac (VHT20)

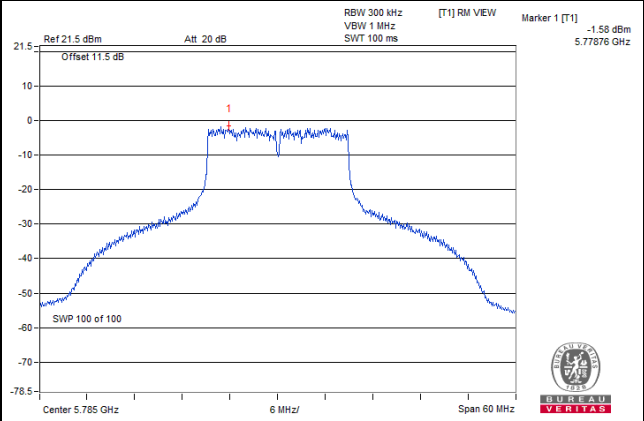

#### 802.11ac (VHT40)

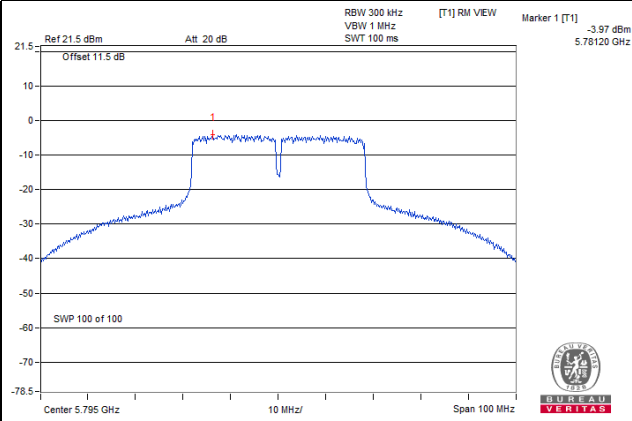

#### 802.11ac (VHT80)

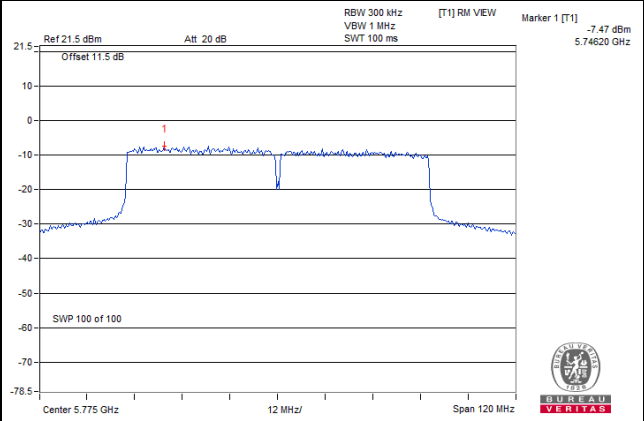

## 4.6 Frequency Stability

### 4.6.1 Limits of Frequency Stability Measurement

The frequency of the carrier signal shall be maintained within band of operation

### 4.6.2 Test Setup

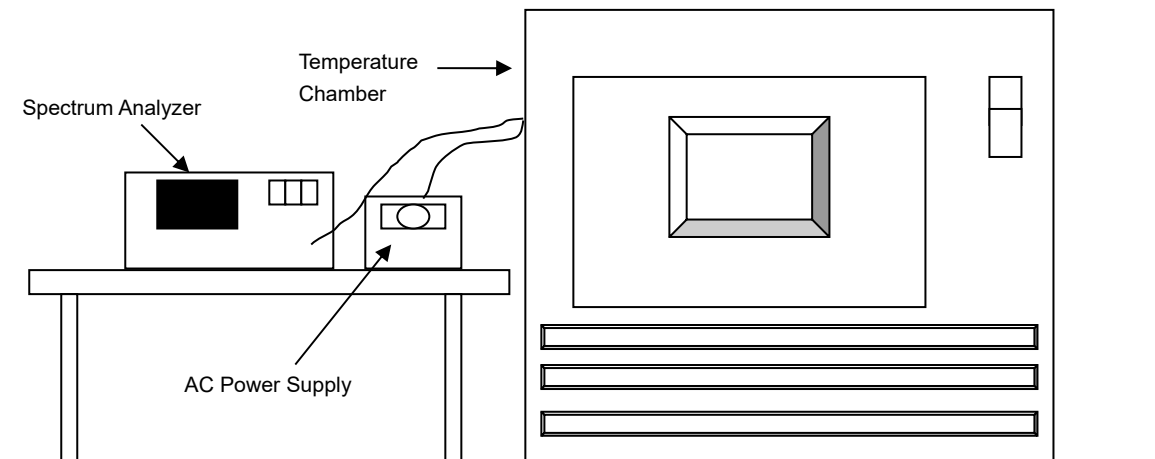

### 4.6.3 Test Instruments

Tested date: Dec. 29, 2020

Description & Manufacturer	Model No.	Serial No.	Cal. Date	Cal. Due
Spectrum Analyzer ROHDE & SCHWARZ	FSP40	100039	Jun. 12, 2020	Jun. 11, 2021
Standard Temperature And Humidity Chamber	MHU-225AU	920842	May 28, 2020	May 27, 2021
Digital Multimeter Fluke	87-III	70360742	Jun. 23, 2020	Jun. 22, 2021
AC Power Supply Exttech	CFW-105	E000603	NA	NA

Note: 1. The calibration interval of the above test instruments is 12 months and the calibrations are traceable to NML/ROC and NIST/USA.

### 4.6.4 Test Procedure

- The EUT was placed inside the environmental test chamber and powered by nominal AC voltage.
- Turn the EUT on and couple its output to a spectrum analyzer.
- Turn the EUT off and set the chamber to the highest temperature specified.
- Allow sufficient time (approximately 30 min) for the temperature of the chamber to stabilize, turn the EUT on and measure the operating frequency after 2, 5, and 10 minutes.
- Repeat step (d) with the temperature chamber set to the next desired temperature until measurements down to the lowest specified temperature have been completed.
- The test chamber was allowed to stabilize at +20 degree C for a minimum of 30 minutes. The supply voltage was then adjusted on the EUT from 85% to 115% and the frequency record.

#### 4.6.5 Deviation from Test Standard

No deviation.

#### 4.6.6 EUT Operating Condition

Set the EUT transmit at un-modulation mode to test frequency stability.

#### 4.6.7 Test Results

##### 5G traffic radio:

Frequency Stability Versus Temp.									
Operating Frequency: 5180MHz									
Temp. (°C)	Power Supply (Vac)	0 Minute		2 Minute		5 Minute		10 Minute	
		Measured Frequency (MHz)	Pass/Fail	Measured Frequency (MHz)	Pass/Fail	Measured Frequency (MHz)	Pass/Fail	Measured Frequency (MHz)	Pass/Fail
40	120	5180.0204	PASS	5180.0212	PASS	5180.0183	PASS	5180.0174	Pass
30	120	5179.9887	PASS	5179.9911	PASS	5179.9911	PASS	5179.9912	Pass
20	120	5179.9775	PASS	5179.9817	PASS	5179.98	PASS	5179.9809	Pass
10	120	5179.9927	PASS	5179.9912	PASS	5179.9932	PASS	5179.9929	Pass
0	120	5179.9983	PASS	5179.9964	PASS	5179.9986	PASS	5179.9971	Pass

Frequency Stability Versus Voltage									
Operating Frequency: 5180MHz									
Temp. (°C)	Power Supply (Vac)	0 Minute		2 Minute		5 Minute		10 Minute	
		Measured Frequency (MHz)	Pass/Fail	Measured Frequency (MHz)	Pass/Fail	Measured Frequency (MHz)	Pass/Fail	Measured Frequency (MHz)	Pass/Fail
20	138	5179.9774	PASS	5179.9824	PASS	5179.9790	PASS	5179.9805	Pass
	120	5179.9775	PASS	5179.9817	PASS	5179.9800	PASS	5179.9809	Pass
	102	5179.9785	PASS	5179.9809	PASS	5179.9799	PASS	5179.9810	Pass

**Scanning radio:**

Frequency Stability Versus Temp.									
Operating Frequency: 5180MHz									
Temp. (°C)	Power Supply (Vac)	0 Minute		2 Minute		5 Minute		10 Minute	
		Measured Frequency (MHz)	Pass/Fail	Measured Frequency (MHz)	Pass/Fail	Measured Frequency (MHz)	Pass/Fail	Measured Frequency (MHz)	Pass/Fail
40	120	5180.0098	PASS	5180.0127	PASS	5180.0094	PASS	5180.0131	Pass
30	120	5180.0030	PASS	5180.0008	PASS	5180.0023	PASS	5180.0038	Pass
20	120	5179.9830	PASS	5179.9791	PASS	5179.9815	PASS	5179.9788	Pass
10	120	5180.0166	PASS	5180.0173	PASS	5180.0210	PASS	5180.0164	Pass
0	120	5180.0233	PASS	5180.0233	PASS	5180.0204	PASS	5180.0221	Pass

Frequency Stability Versus Voltage									
Operating Frequency: 5180MHz									
Temp. (°C)	Power Supply (Vac)	0 Minute		2 Minute		5 Minute		10 Minute	
		Measured Frequency (MHz)	Pass/Fail	Measured Frequency (MHz)	Pass/Fail	Measured Frequency (MHz)	Pass/Fail	Measured Frequency (MHz)	Pass/Fail
20	138	5179.9839	PASS	5179.9790	PASS	5179.9824	PASS	5179.9781	Pass
	120	5179.9830	PASS	5179.9791	PASS	5179.9815	PASS	5179.9788	Pass
	102	5179.9828	PASS	5179.9794	PASS	5179.9824	PASS	5179.9796	Pass

## 4.7 6dB Bandwidth Measurement

### 4.7.1 Limits of 6dB Bandwidth Measurement

The minimum of 6dB Bandwidth Measurement is 0.5MHz.

### 4.7.2 Test Setup

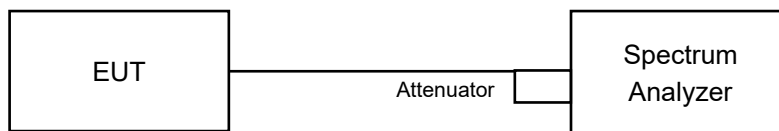

### 4.7.3 Test Instruments

Refer to section 4.1.2 to get information of above instrument.

### 4.7.4 Test Procedure

#### Measurement Procedure REF

- Set resolution bandwidth (RBW) = 100kHz
- Set the video bandwidth (VBW)  $\geq 3 \times$  RBW, Detector = Peak.
- Trace mode = max hold.
- Sweep = auto couple.
- Measure the maximum width of the emission that is constrained by the frequencies associated with the two amplitude points (upper and lower) that are attenuated by 6 dB relative to the maximum level measured in the fundamental emission

### 4.7.5 Deviation from Test Standard

No deviation.

### 4.7.6 EUT Operating Condition

The software provided by client to enable the EUT under transmission condition continuously at lowest, middle and highest channel frequencies individually.



#### 4.7.7 Test Results

##### 5G traffic radio:

##### 802.11a

Chan.	Freq. (MHz)	6dB Bandwidth (MHz)		Minimum Limit (MHz)	Pass / Fail
		Chain 0	Chain 1		
149	5745	15.75	16.34	0.5	Pass
157	5785	16.07	15.40	0.5	Pass
165	5825	15.82	15.92	0.5	Pass

##### 802.11ax (HE20)

Chan.	Freq. (MHz)	6dB Bandwidth (MHz)		Minimum Limit (MHz)	Pass / Fail
		Chain 0	Chain 1		
149	5745	18.46	18.28	0.5	Pass
157	5785	18.57	17.77	0.5	Pass
165	5825	18.55	17.68	0.5	Pass

##### 802.11ax (HE40)

Chan.	Freq. (MHz)	6dB Bandwidth (MHz)		Minimum Limit (MHz)	Pass / Fail
		Chain 0	Chain 1		
151	5755	37.82	37.29	0.5	Pass
159	5795	38.11	37.61	0.5	Pass

##### 802.11ax (HE80)

Chan.	Freq. (MHz)	6dB Bandwidth (MHz)		Minimum Limit (MHz)	Pass / Fail
		Chain 0	Chain 1		
155	5775	77.29	77.28	0.5	Pass

### Spectrum Plot of Worst Value

#### 802.11a

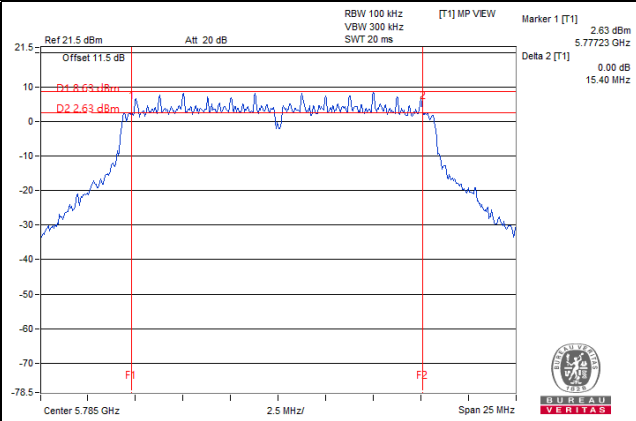

#### 802.11ax (HE20)

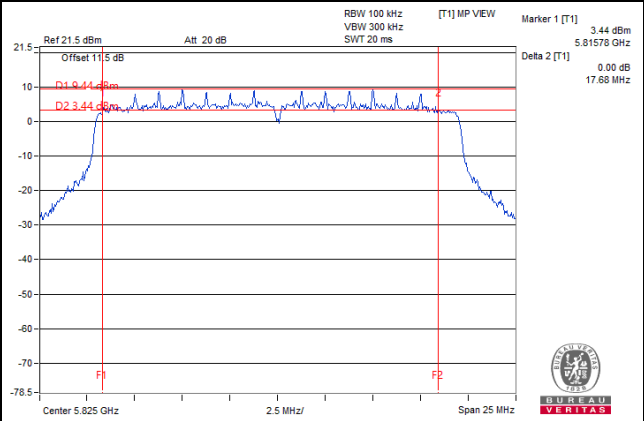

#### 802.11ax (HE40)

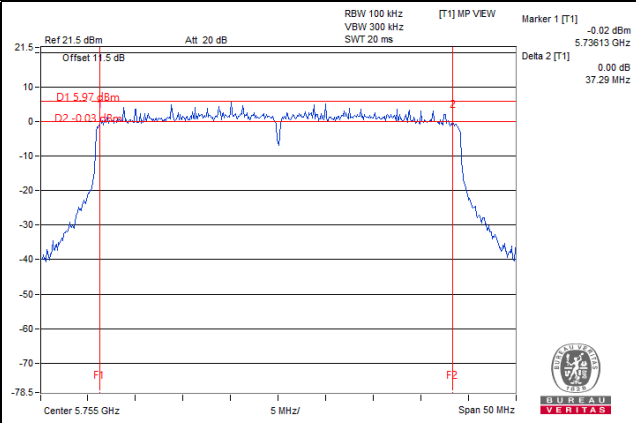

#### 802.11ax (HE80)

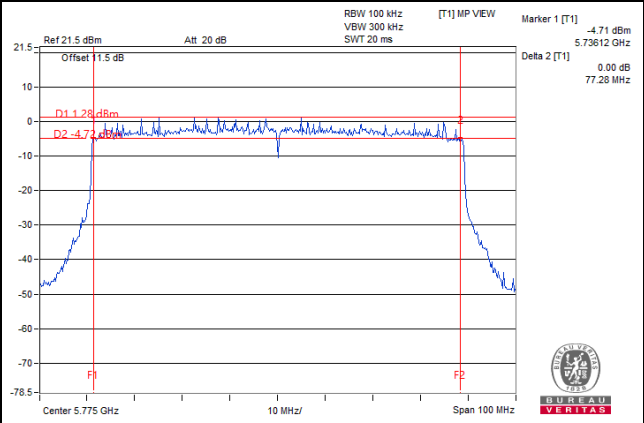

**Scanning radio:**

## 802.11a

Chan.	Freq. (MHz)	6dB Bandwidth (MHz)		Minimum Limit (MHz)	Pass / Fail
		Chain 0	Chain 1		
149	5745	16.39	16.36	0.5	Pass
157	5785	16.39	16.38	0.5	Pass
165	5825	16.40	16.40	0.5	Pass

## 802.11ac (VHT20)

Chan.	Freq. (MHz)	6dB Bandwidth (MHz)		Minimum Limit (MHz)	Pass / Fail
		Chain 0	Chain 1		
149	5745	17.61	17.36	0.5	Pass
157	5785	17.61	17.32	0.5	Pass
165	5825	17.62	17.63	0.5	Pass

## 802.11ac (VHT40)

Chan.	Freq. (MHz)	6dB Bandwidth (MHz)		Minimum Limit (MHz)	Pass / Fail
		Chain 0	Chain 1		
151	5755	36.43	36.43	0.5	Pass
159	5795	36.44	36.42	0.5	Pass

## 802.11ac (VHT80)

Chan.	Freq. (MHz)	6dB Bandwidth (MHz)		Minimum Limit (MHz)	Pass / Fail
		Chain 0	Chain 1		
155	5775	73.37	75.13	0.5	Pass

### Spectrum Plot of Worst Value

#### 802.11a

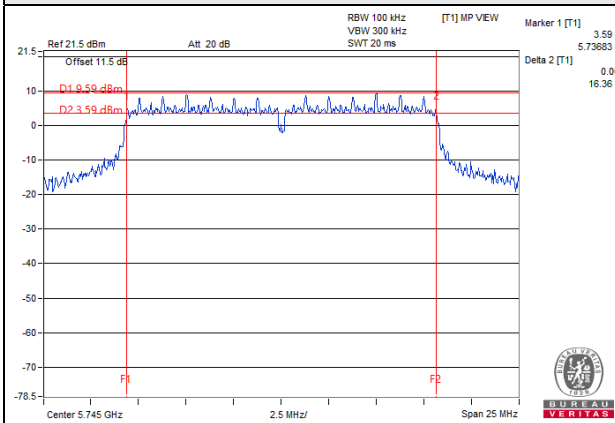

#### 802.11ac (VHT20)

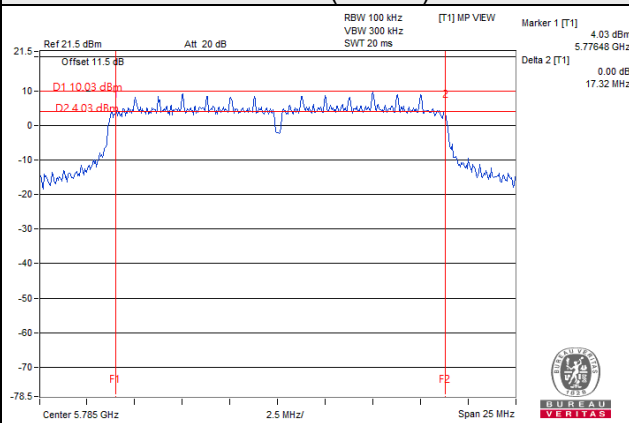

#### 802.11ac (VHT40)

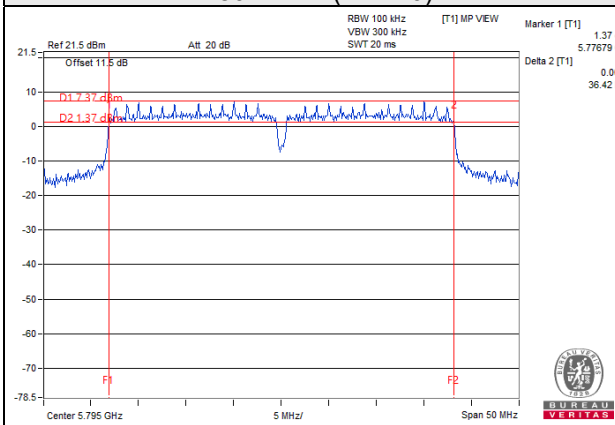

#### 802.11ac (VHT80)

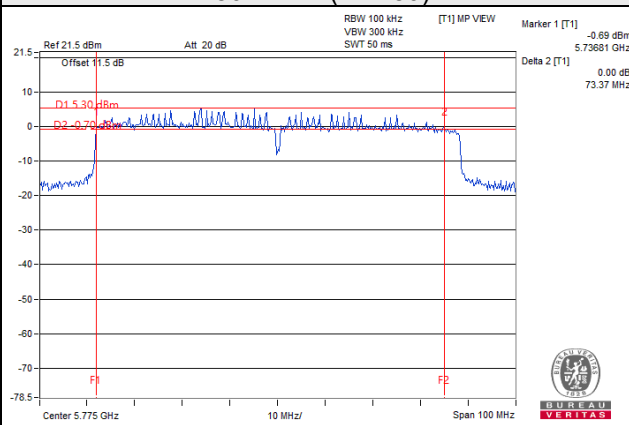

## 5 Pictures of Test Arrangements

Please refer to the attached file (Test Setup Photo).

## Annex A- Radiated Out of Band Emission (OOBE) Measurement (For U-NII-3 band)

5G traffic radio:

802.11a

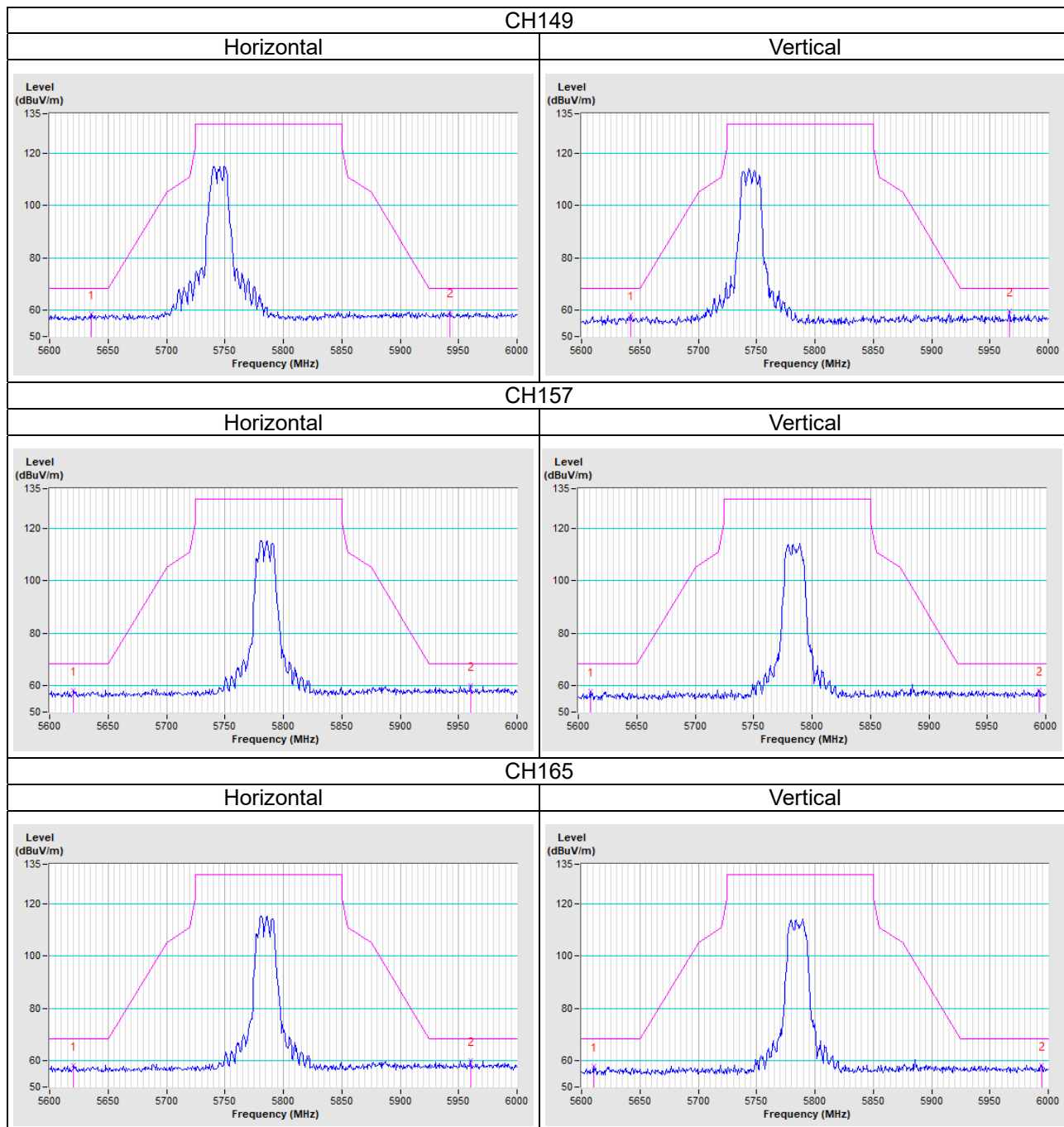

802.11ax (HE20)

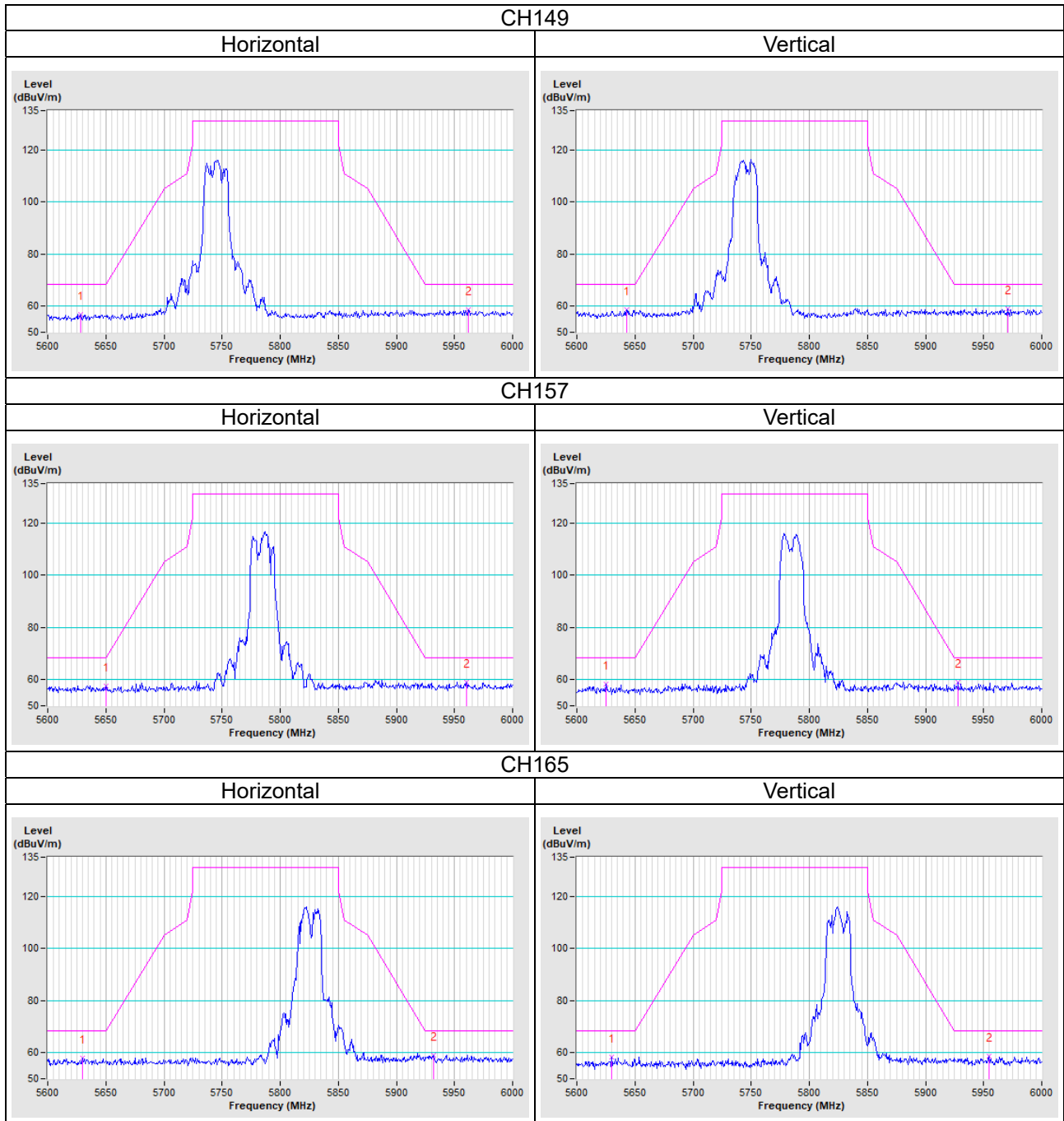

802.11ax (HE40)

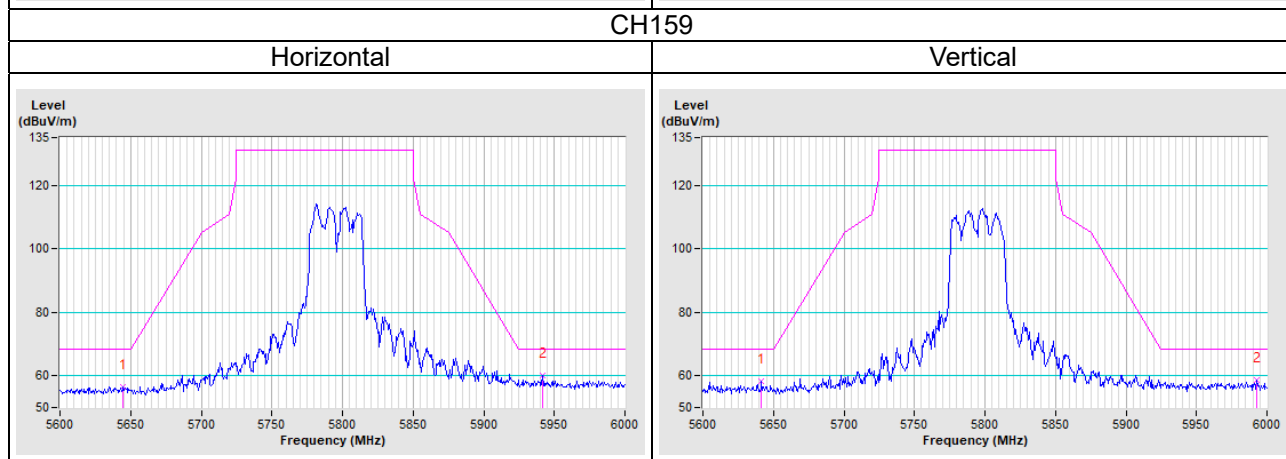
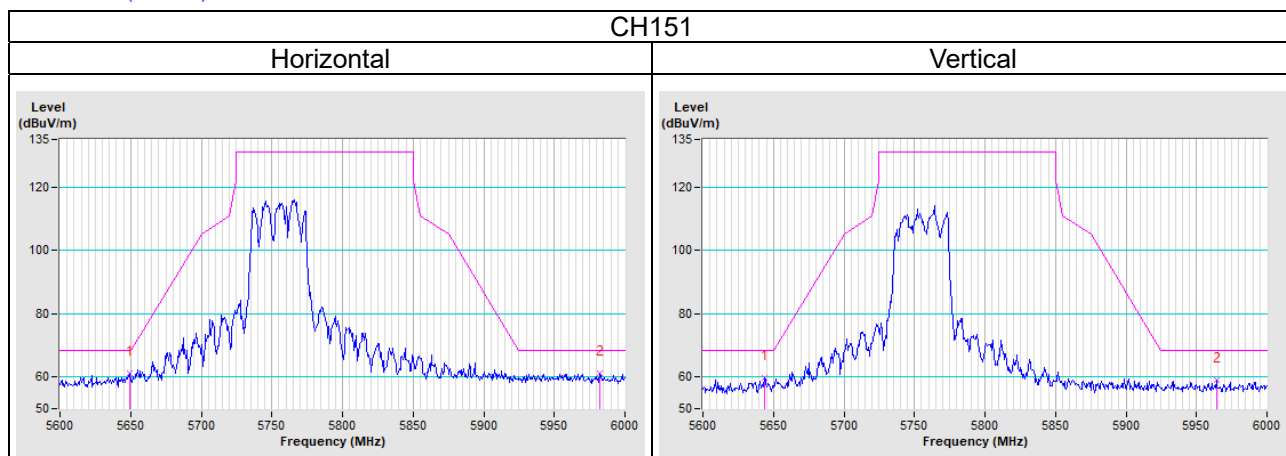

802.11ax (HE80)

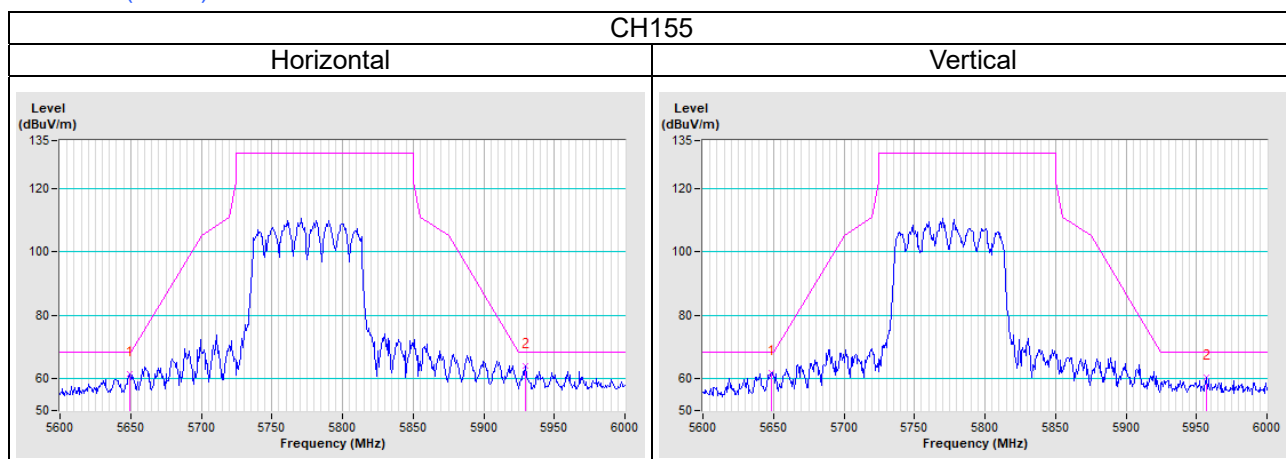



Scanning radio:  
802.11a

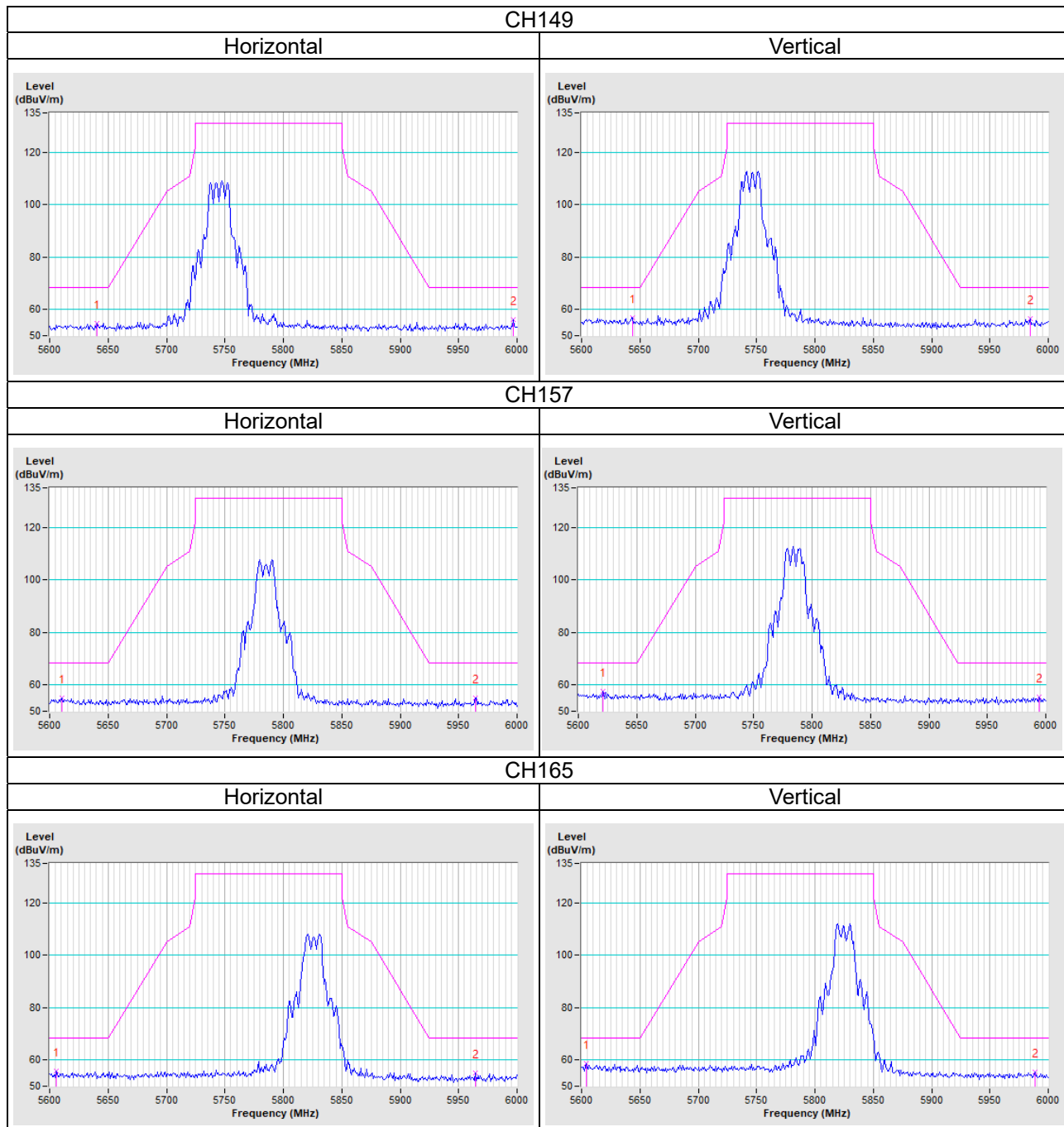

802.11ac (VHT20)

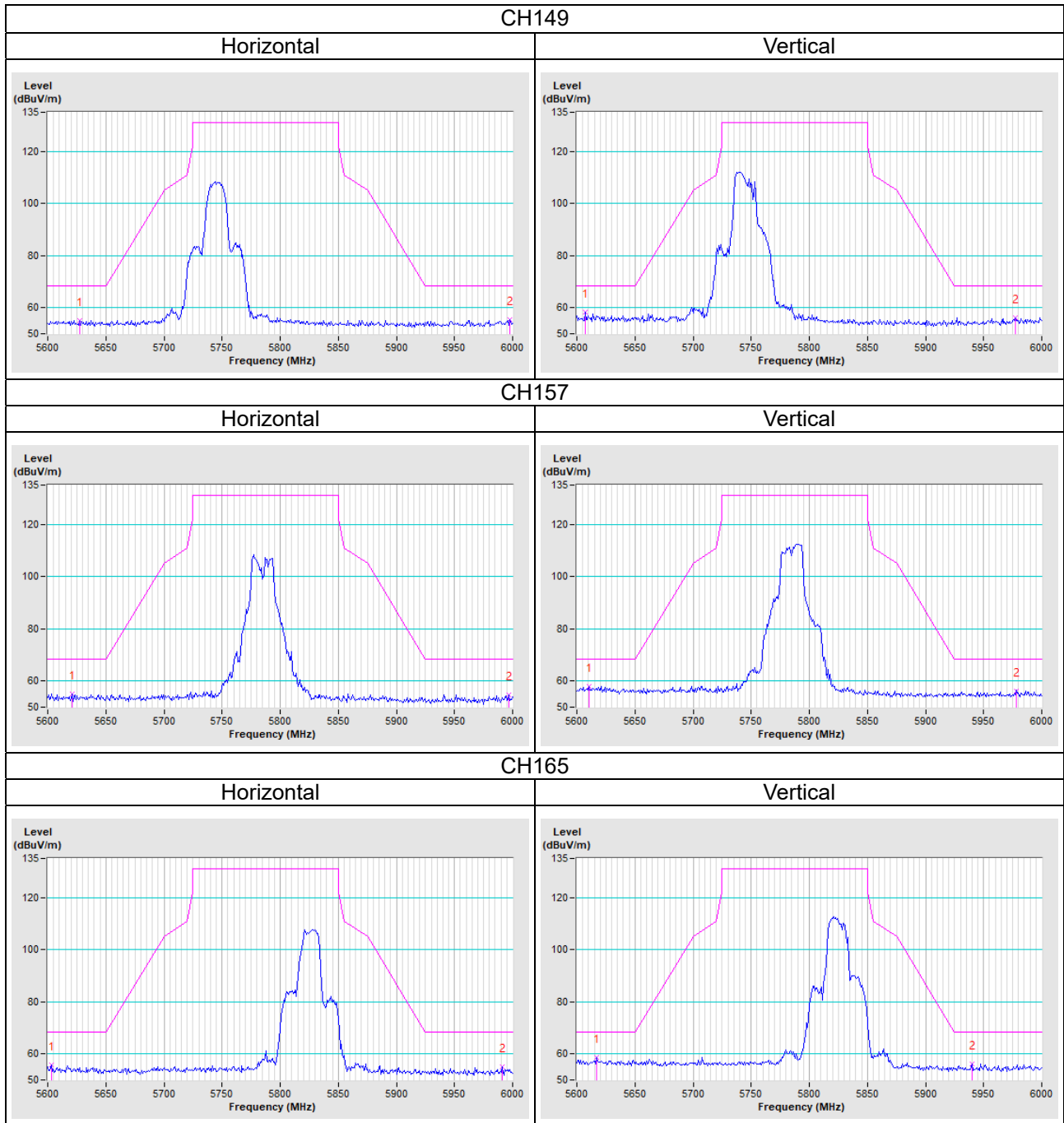

802.11ac (VHT40)

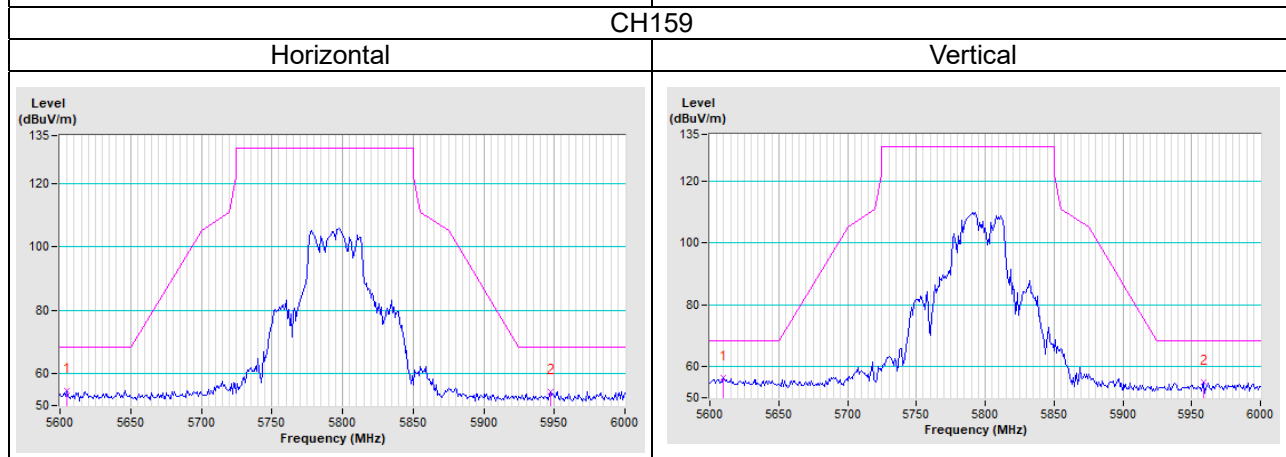
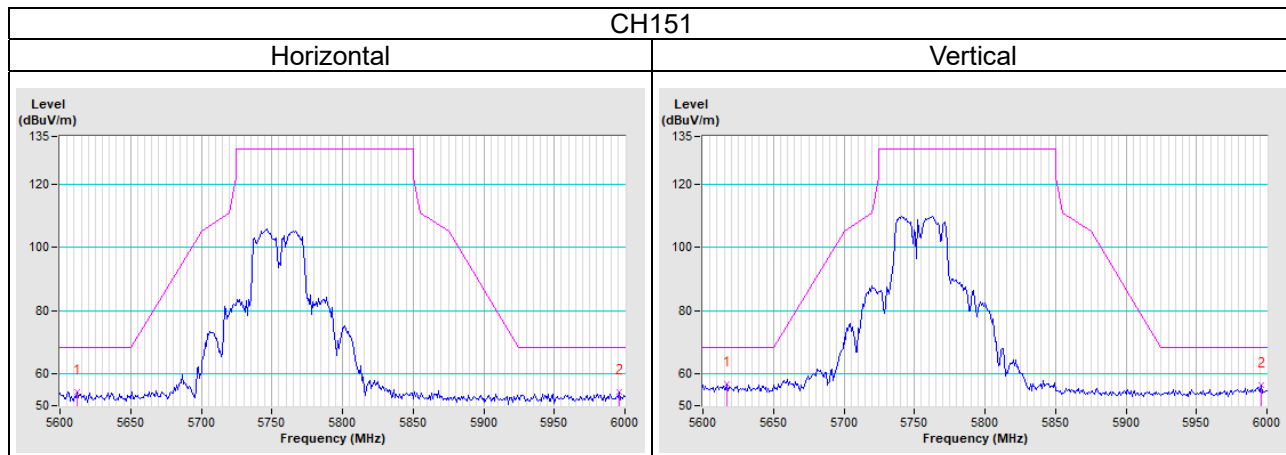

802.11ac (VHT80)

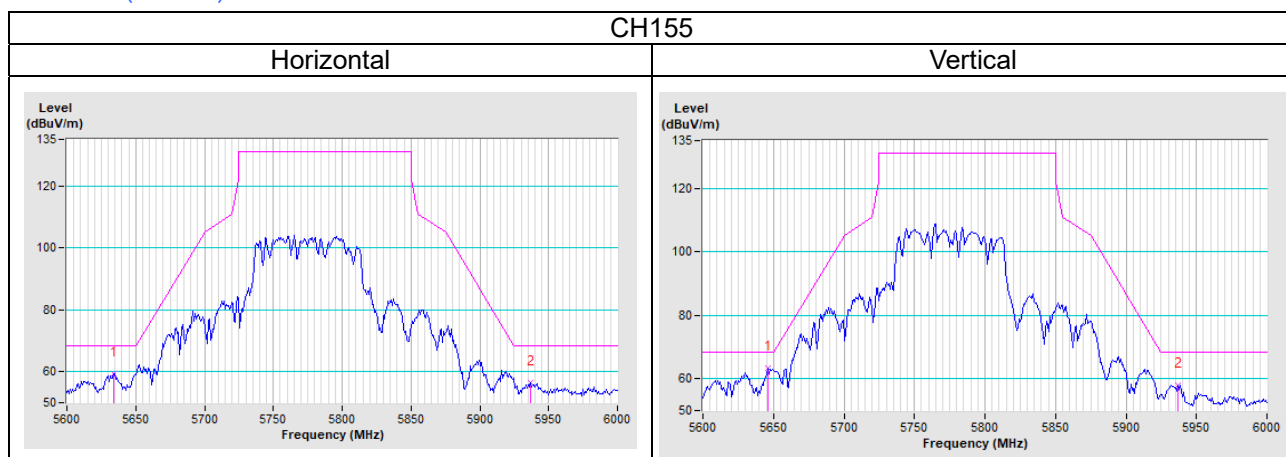

# Annex B- Band Edge Measurement

5G traffic radio:

802.11a

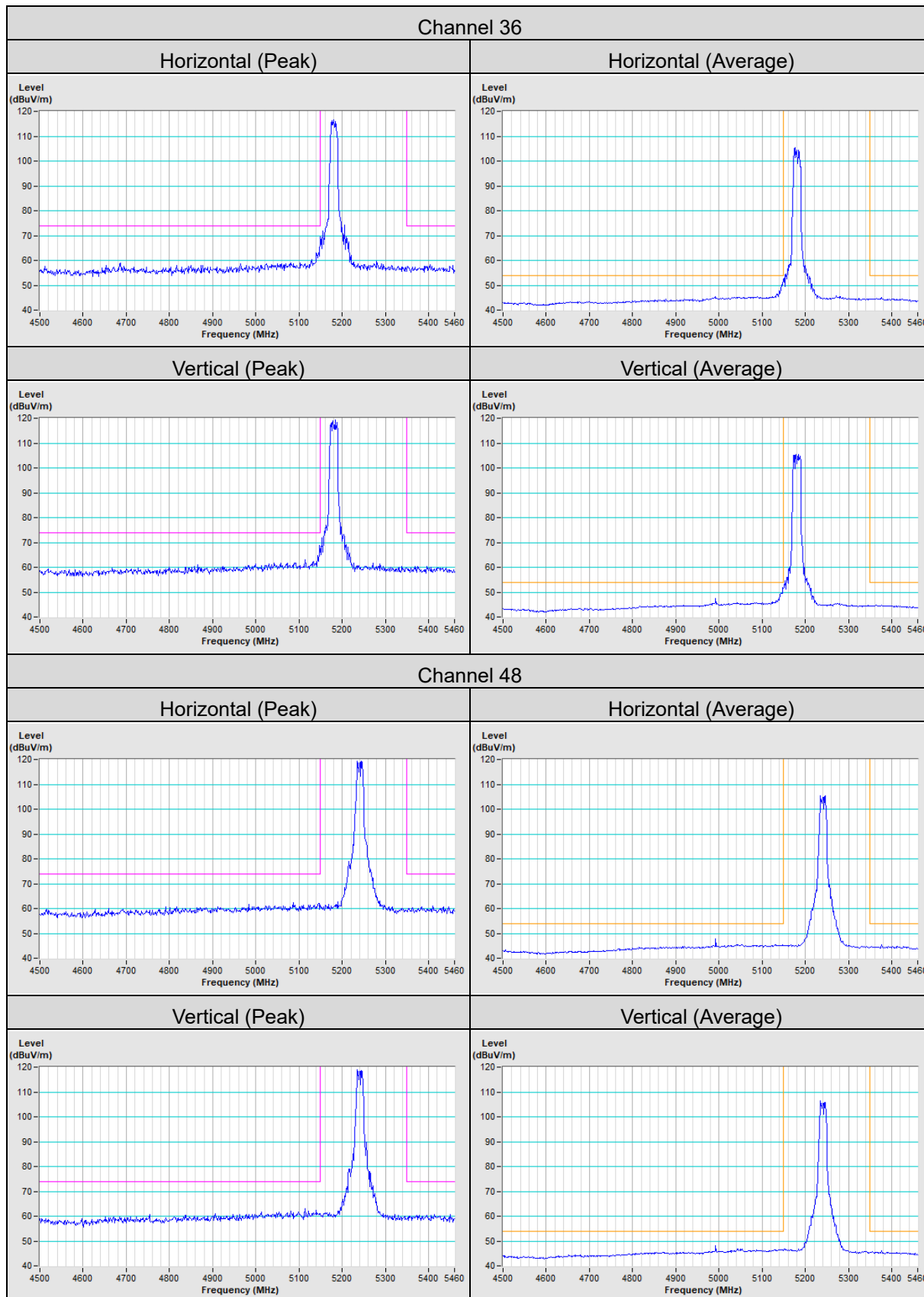

802.11ax (HE20)

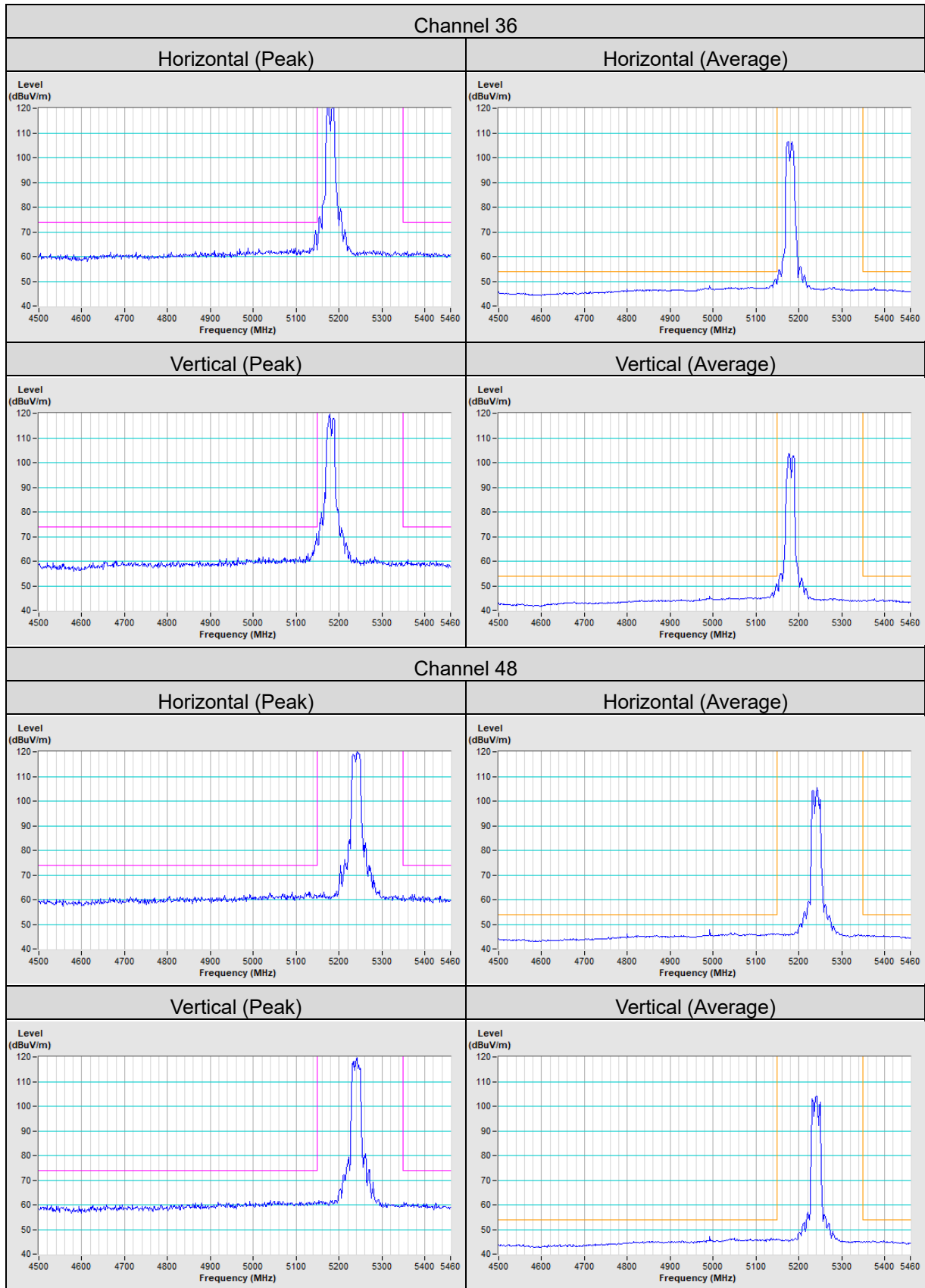

802.11ax (HE40)

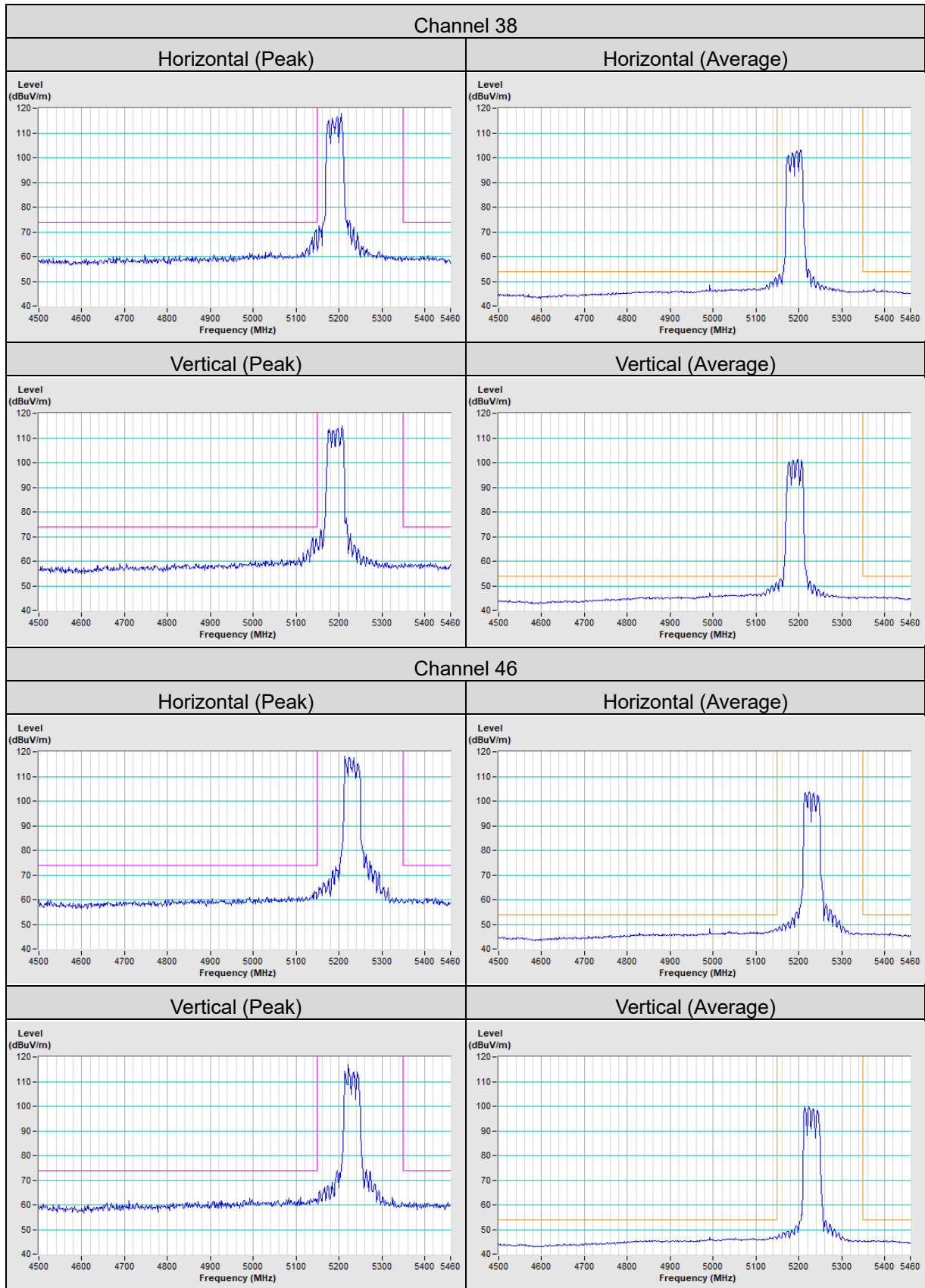

802.11ax (HE80)

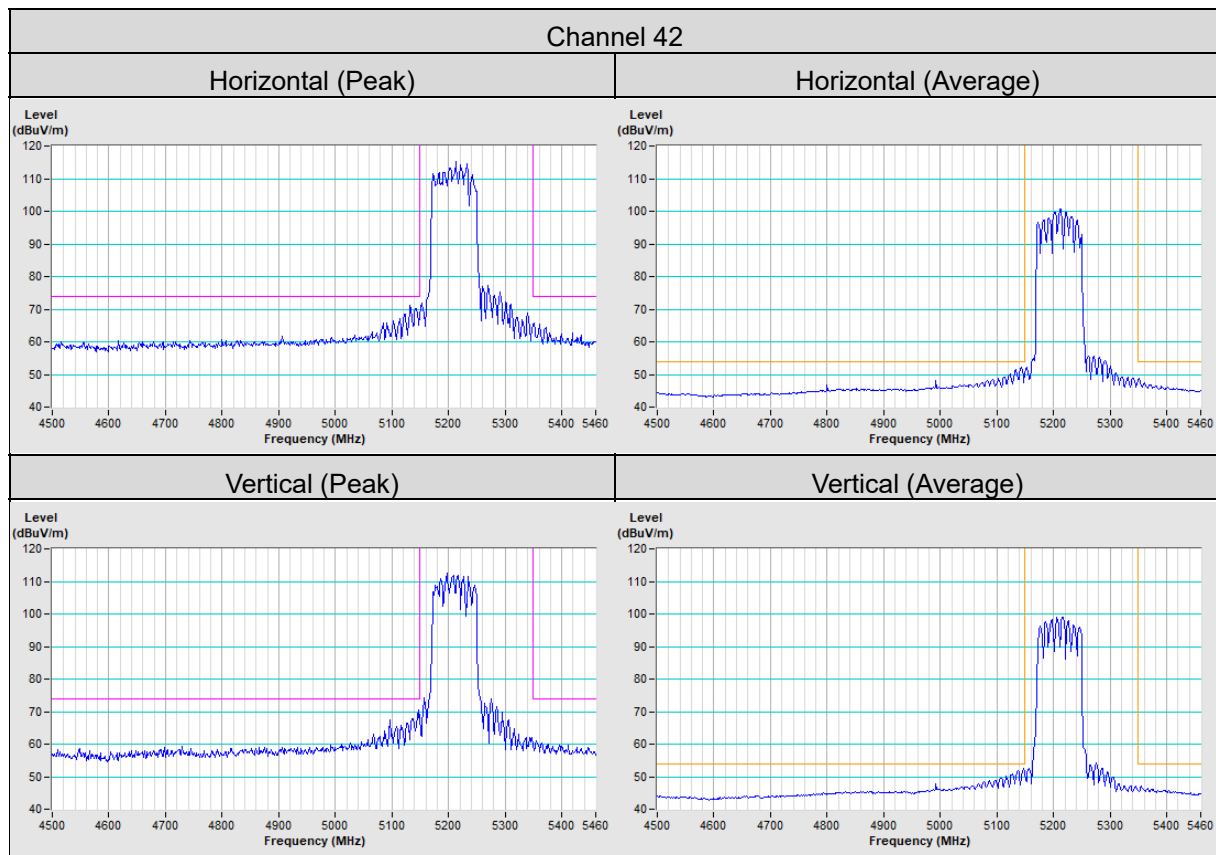

**Scanning radio:**

802.11a

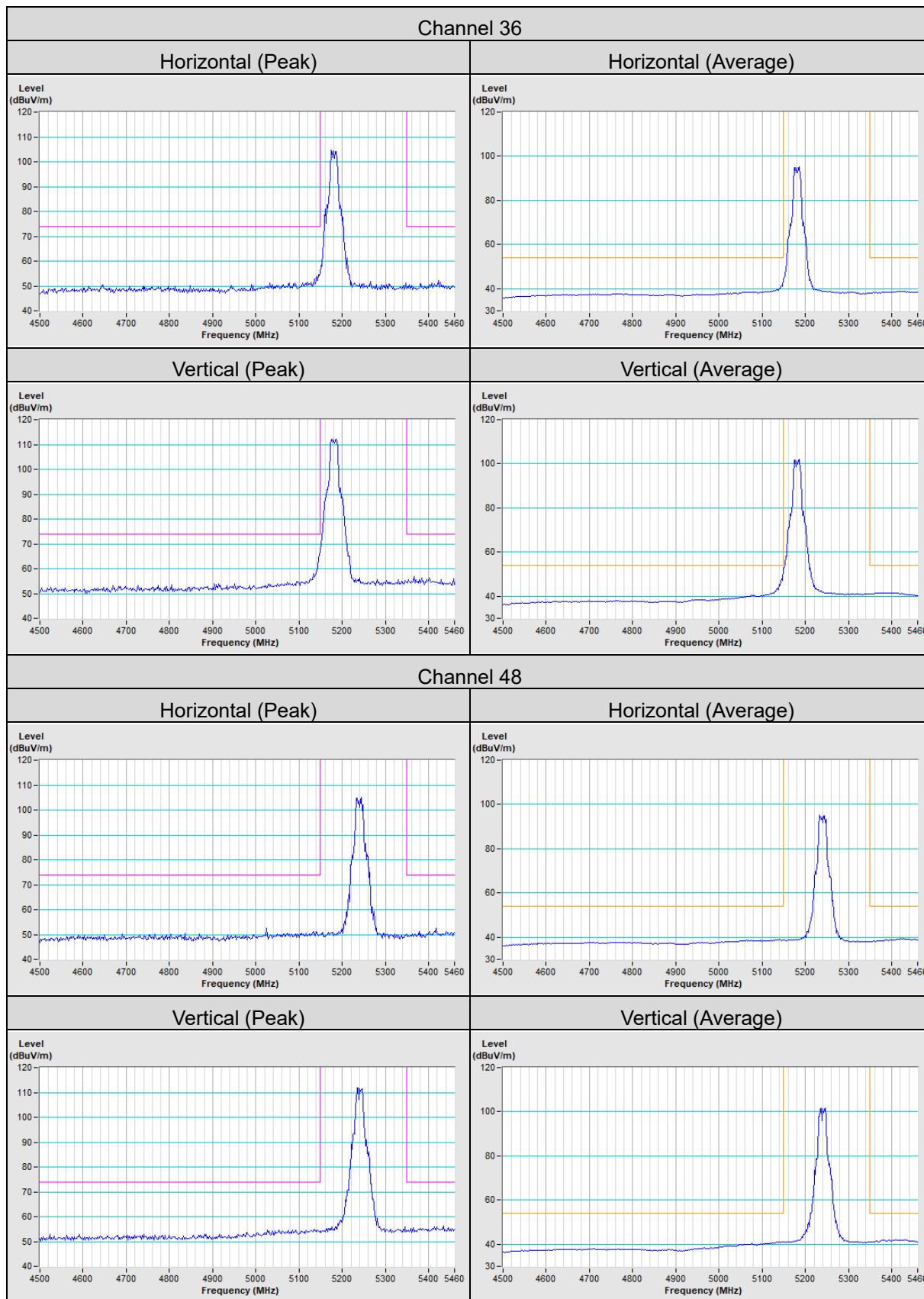



802.11ac (VHT20)

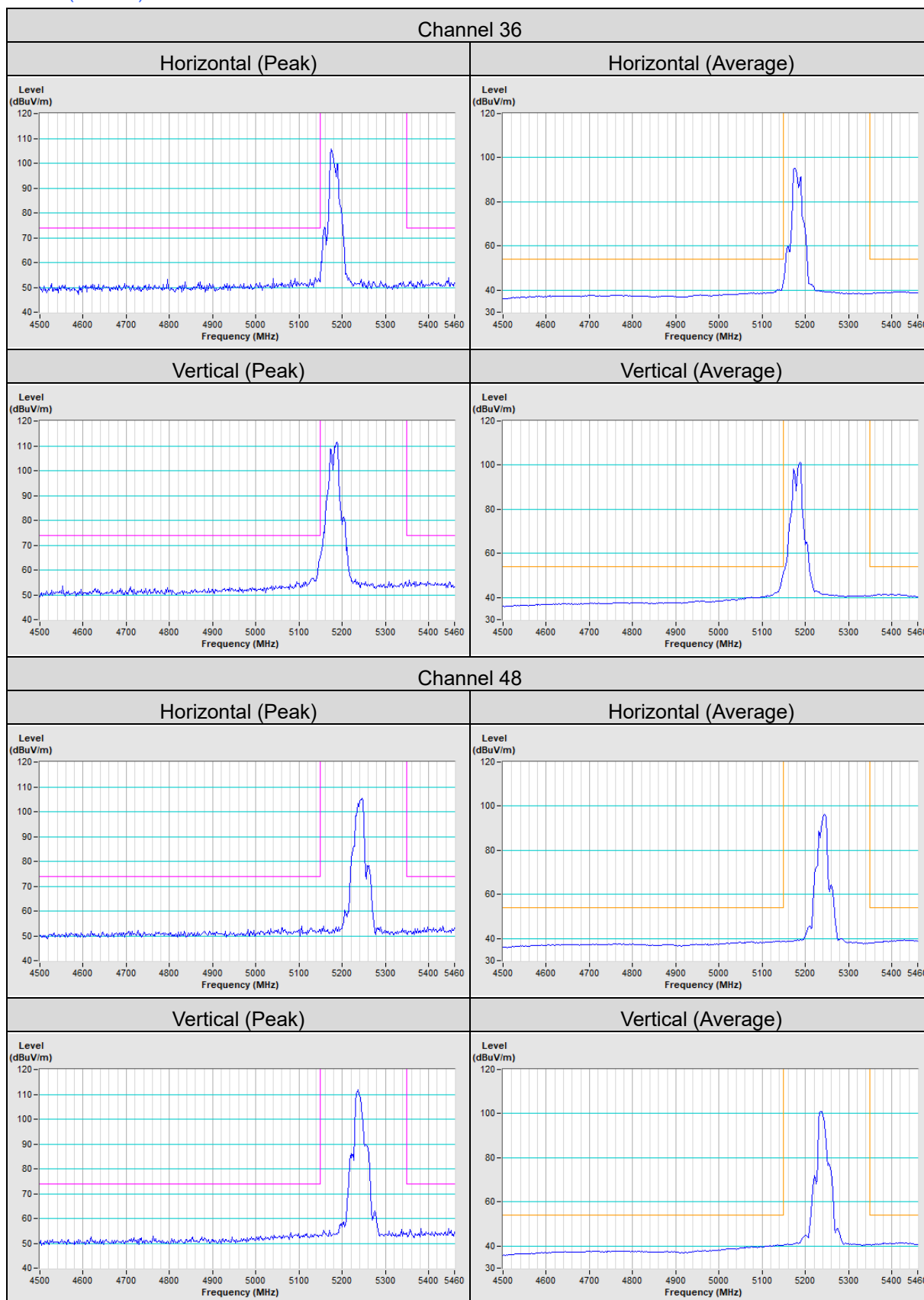

802.11ac (VHT40)

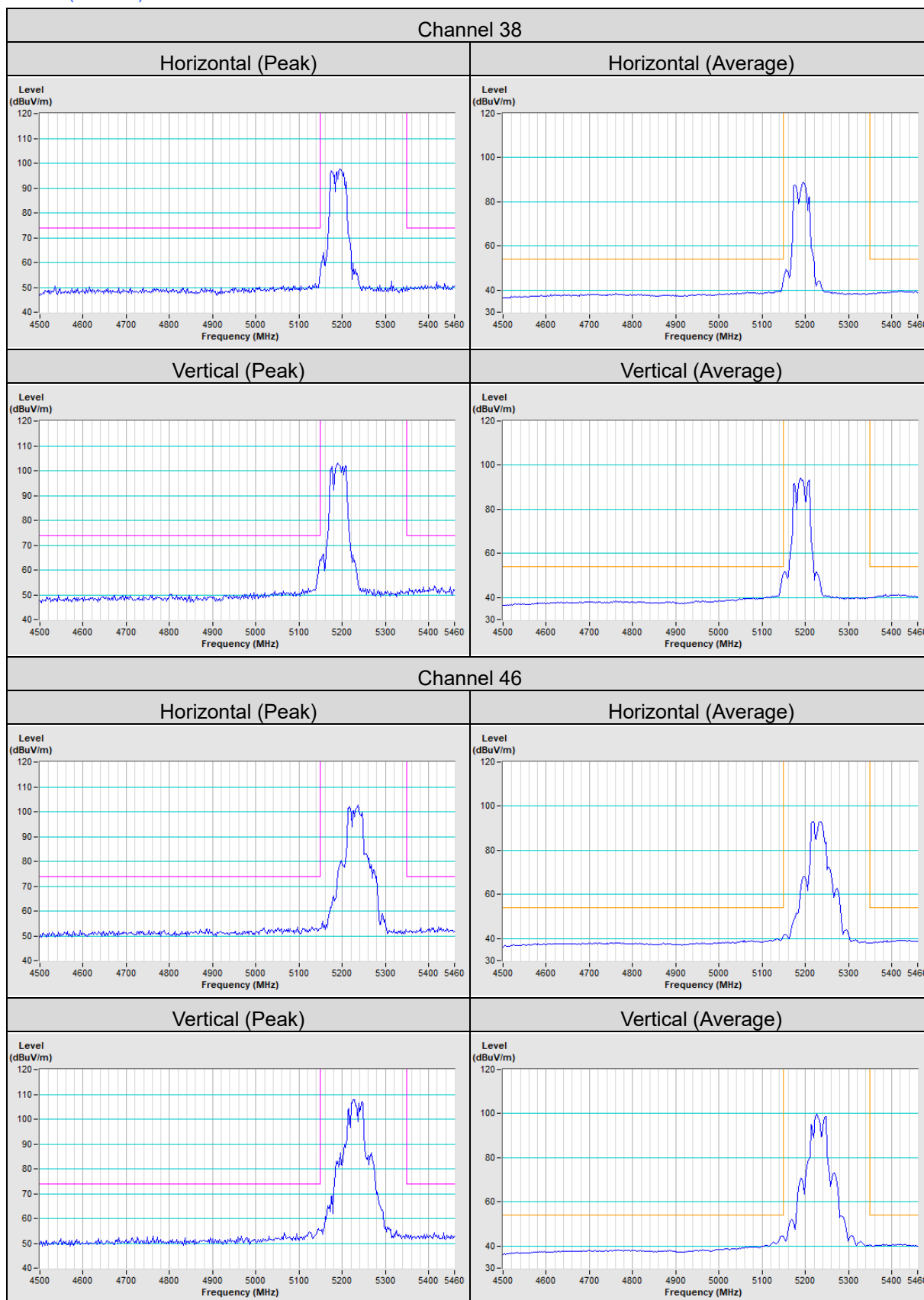

802.11ac (VHT80)

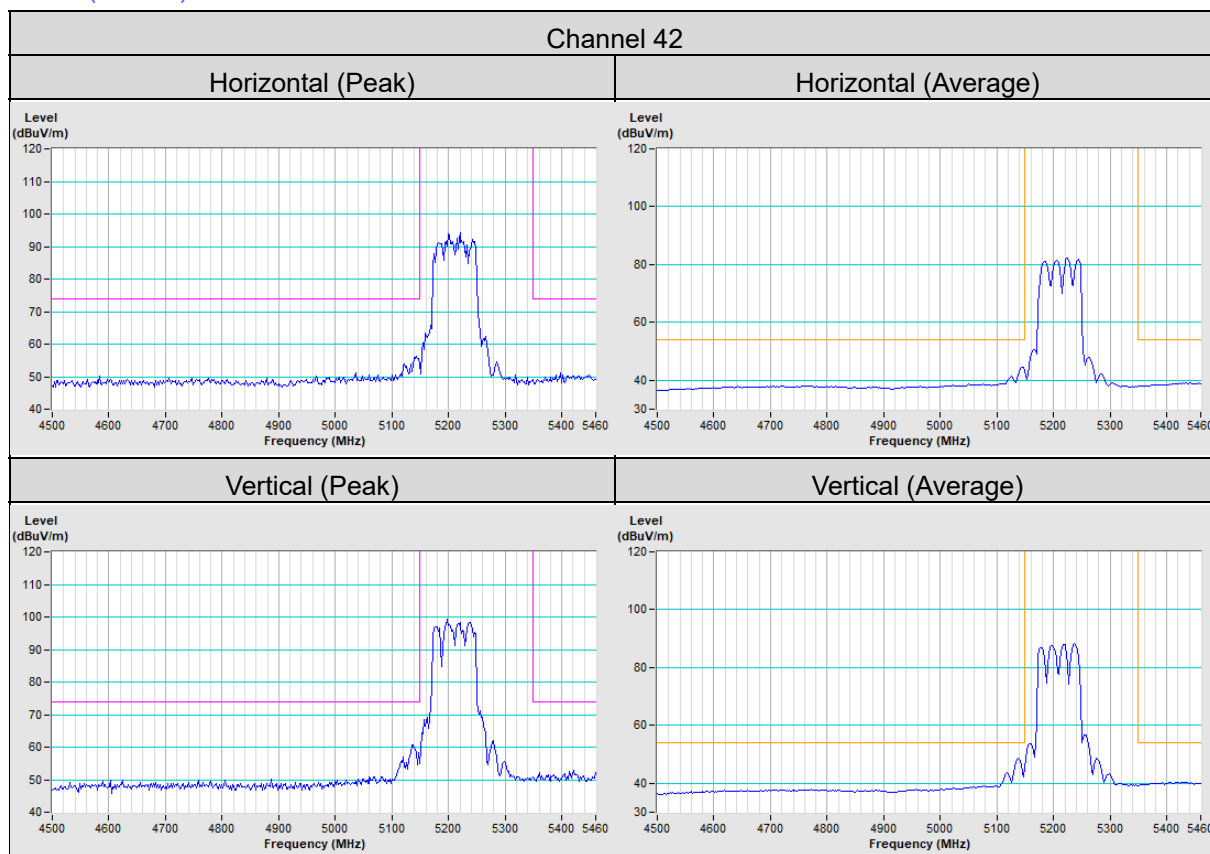

## Appendix – Information of the Testing Laboratories

We, Bureau Veritas Consumer Products Services (H.K.) Ltd., Taoyuan Branch, were founded in 1988 to provide our best service in EMC, Radio, Telecom and Safety consultation. Our laboratories are FCC recognized accredited test firms and accredited and approved according to ISO/IEC 17025.

If you have any comments, please feel free to contact us at the following:

**Lin Kou EMC/RF Lab**

Tel: 886-2-26052180

Fax: 886-2-26051924

**Hsin Chu EMC/RF/Telecom Lab**

Tel: 886-3-6668565

Fax: 886-3-6668323

**Hwa Ya EMC/RF/Safety Lab**

Tel: 886-3-3183232

Fax: 886-3-3270892

**Email:** [service.adt@tw.bureauveritas.com](mailto:service.adt@tw.bureauveritas.com)

**Web Site:** [www.bureauveritas-adt.com](http://www.bureauveritas-adt.com)

The address and road map of all our labs can be found in our web site also.

--- END ---