



Test report No.: 2380869R-RFNAV02S-D

TEST REPORT

Product Name	Wireless Access Point
Trademark	WatchGuard
Model and /or type reference	AP230W
FCC ID	Q6G-AP230W
Applicant's name / address	WatchGuard Technologies, Inc. 255 S. King St. Suite 1100, Seattle, WA, United States 98104
Manufacturer's name	WatchGuard Technologies, Inc.
Test method requested, standard	FCC CFR Title 47 Part 15 Subpart E ANSI C63.4: 2014, ANSI C63.10: 2013 KDB Publication 789033
Verdict Summary	IN COMPLIANCE
Documented By (Senior Project Specialist / Ida Tung)	<i>Ida Tung</i>
Tested By (Senior Engineer / Ivan Chuang)	<i>Ivan Chuang</i>
Approved By (Senior Engineer / Jack Hsu)	<i>Jack Hsu</i>
Date of Receipt	2023/08/18
Date of Issue	2024/03/11
Report Version	V1.0

INDEX

	Page
1. General Information.....	6
1.1. EUT Description.....	6
1.2. Tested System Details.....	8
1.3. Configuration of tested System	8
1.4. EUT Exercise Software	8
1.5. Test Facility	9
1.6. List of Test Equipment.....	10
1.7. Uncertainty	11
2. Conducted Emission	12
2.1. Test Setup	12
2.2. Limits.....	12
2.3. Test Procedure	12
2.4. Test Result of Conducted Emission.....	13
3. Maximum conducted output power	14
3.1. Test Setup	14
3.2. Limits.....	15
3.3. Test Procedure	16
3.4. Test Result of Maximum conducted output power.....	17
4. Peak Power Spectral Density	25
4.1. Test Setup	25
4.2. Limits.....	25
4.3. Test Procedure	26
4.4. Test Result of Peak Power Spectral Density.....	27
5. Radiated Emission	43
5.1. Test Setup	43
5.2. Limits.....	44
5.3. Test Procedure	45
5.4. Test Result of Radiated Emission.....	47
6. Band Edge	68
6.1. Test Setup	68
6.2. Limits.....	69
6.3. Test Procedure	70

6.4.	Test Result of Band Edge	71
7.	6 dB Bandwidth	113
7.1.	Test Setup	113
7.2.	Limits.....	113
7.3.	Test Procedure	113
7.4.	Test Result of 6 dB Bandwidth.....	114
8.	99% Occupied Bandwidth	122
8.1.	Test Setup	122
8.2.	Limits.....	122
8.3.	Test Result of 99% Occupied Bandwidth.....	123
9.	Duty Cycle	131
9.1.	Test Setup	131
9.2.	Test Procedure	131
9.3.	Test Result of Duty Cycle.....	132

Appendix 1: EUT Test Photographs

Appendix 2: Product Photos-Please refer to the file: 2380869R-Product Photos

Competences and Guarantees

DEKRA is a testing laboratory competent to carry out the tests described in this report.

In order to assure the traceability to other national and international laboratories, DEKRA has a calibration and maintenance program for its measurement equipment.

DEKRA guarantees the reliability of the data presented in this report, which is the result of the measurements and the tests performed to the item under test on the date and under the conditions stated in the report and it is based on the knowledge and technical facilities available at DEKRA at the time of performance of the test.

DEKRA is liable to the client for the maintenance of the confidentiality of all information related to the item under test and the results of the test.

The results presented in this Test Report apply only to the particular item under test established in this document.

IMPORTANT: No parts of this report may be reproduced or quoted out of context, in any form or by any means, except in full, without the previous written permission of DEKRA.

General conditions

1. The test results relate only to the samples tested.
2. The test results shown in the test report are traceable to the national/international standard through the calibration report of the equipment and evaluated measurement uncertainty herein.
3. This report must not be used to claim product endorsement by TAF or any agency of the government.
4. The test report shall not be reproduced without the written approval of DEKRA Testing and Certification Co., Ltd.
5. Measurement uncertainties evaluated for each testing system and associated connections are given here to provide the system information for reference. Compliance determinations do not take into account measurement uncertainties for each testing system, but are based on the results of the compliance measurement.

Revision History

Report No.	Version	Description	Issued Date
2380869R-RFNAV02S-D	V1.0	Initial issue of report.	2024/03/11

1. General Information

1.1. EUT Description

Product Name	Wireless Access Point
Trade Name	WatchGuard
Model No.	AP230W
EUT Rated Voltage	AC 100-240V, 50-60Hz
EUT Test Voltage	AC 120V/60Hz
Frequency Range	Radio-2: 802.11a/n/ac/ax-20 MHz: 5180-5240 MHz, 5745-5825 MHz 802.11n/ac/ax-40 MHz: 5190-5230 MHz, 5755-5795 MHz 802.11ac/ax-80 MHz: 5210 MHz, 5775 MHz Radio-3: 802.11a/n/ac-20 MHz: 5180-5240 MHz, 5745-5825 MHz 802.11n/ac-40 MHz: 5190-5230 MHz, 5755-5795 MHz 802.11ac-80 MHz: 5210 MHz, 5775 MHz
Number of Channels	802.11a/n/ac/ax-20 MHz: 9CH 802.11n/ac/ax-40 MHz: 4CH 802.11ac/ax-80 MHz: 2CH
Data Rate	Radio-2: 802.11a: 6-54Mbps 802.11n: up to 300Mbps 802.11ac: up to 866.7Mbps 802.11ax: up to 1201Mbps Radio-3: 802.11a: 6-54Mbps 802.11n: up to 150Mbps 802.11ac: up to 433.3Mbps
Type of Modulation	802.11a/n/ac: OFDM (BPSK, QPSK, 16QAM, 64QAM, 256QAM) 802.11ax: OFDMA (BPSK, QPSK, 16QAM, 64QAM, 256QAM, 1024QAM)
Channel Control	Auto
Power Adapter	MFR: SENA0, M/N: EAA65A-54 Input: AC 100-240V~1.8A 50-60Hz Output: 54V=1.2A 64.8W Cable out: Non-shielded, 1.4 m with one ferrite core bonded. Power cord: Non-shielded, 1.7m

Antenna List

No.	Manufacturer	Part No.	Antenna Type	Peak Gain
1	SENA0 (Radio-2)	7016A307200u -DL1	PIFA	2.28 dBi for 5150~5250 MHz 3.19 dBi for 5725~5850 MHz
2	SENA0 (Radio-2)	7016A307200u -DL2		2.31 dBi for 5150~5250 MHz 3.77 dBi for 5725~5850 MHz
3	SENA0 (Radio-3)	7016A307200u -SCAN	Monopole	1.31 dBi for 5150~5250 MHz 1.37 dBi for 5725~5850 MHz

Note:

1. The antenna of EUT is conforming to FCC 15.203.
2. The antenna gain as by the manufacturer provided.
3. Each antenna has been evaluated and only the worst case (higher gain antenna) is presented in the report.

For Power CDD Directional gain (Radio-2)

5150MHz-5250MHz: Directional gain = 2.31 dBi
 5725MHz-5850MHz: Directional gain = 3.77 dBi
 (Directional gain = $G_{ANT\ MAX} + \text{Array Gain}$, Array Gain = 0 dB for $N_{ANT} \leq 4$)

For PSD CDD Directional gain (Radio-2)

5150MHz-5250MHz: Directional gain = 5.30 dBi
 5725MHz-5850MHz: Directional gain = 6.50 dBi
 Directional gain = $10 \log[(10^{G1/20} + 10^{G2/20})^2 / N_{ANT}]$ dBi

802.11a/n/ac/ax-20 MHz Center Working Frequency of Each Channel:

Channel	Frequency (MHz)	Channel	Frequency (MHz)	Channel	Frequency (MHz)	Channel	Frequency (MHz)
036	5180	040	5200	044	5220	048	5240
149	5745	153	5765	157	5785	161	5805
165	5825	--	--	--	--	--	--

802.11n/ac/ax-40 MHz Center Working Frequency of Each Channel:

Channel	Frequency (MHz)	Channel	Frequency (MHz)	Channel	Frequency (MHz)	Channel	Frequency (MHz)
038	5190	046	5230	151	5755	159	5795

802.11ac/ax-80 MHz Center Working Frequency of Each Channel:

Channel	Frequency (MHz)	Channel	Frequency (MHz)	Channel	Frequency (MHz)	Channel	Frequency (MHz)
042	5210	155	5775	--	--	--	--

Note:

1. This device is a Wireless Access Point with built-in WLAN and Bluetooth transceiver, this report for 5GHz WLAN.
2. Regarding to the operation frequency, the lowest, middle and highest frequency are selected to perform the test.
3. Lowest and highest data rates are tested in each mode. Only worst case is shown in the report. (802.11a is 6Mbps, 802.11ac/ax-20MHz/40MHz is HT0/MCS0)
4. The modulation and bandwidth are similar for 802.11n mode and 802.11ac/ax mode, therefore investigated worst case (802.11ac/ax) to representative mode.
5. The product includes three module cards with the following specifications:

Module	Radio-1	Radio-2	Radio-3
WLAN 2.4G	802.11 b/g/n/ax 2T2R		802.11 b/g/n/ac 1T1R
WLAN 5G		802.11 a/n/ac/ax 2T2R	802.11 a/n/ac 1T1R

6. The spectrum plot against conducted item only shows the worst case.
7. This device does not support partial RU function.
8. DEKRA has evaluated each test mode. Only the worst case is shown in the report.
9. Authorized by the original report holder, this report quotes the test data from original report number: 2380601R-RFUSV03S-A, the different is update trademark, model number and applicant information.
10. These tests were conducted on a sample of the equipment for the purpose of demonstrating compliance of transmitter with Part 15 Subpart E for Unlicensed National Information Infrastructure devices.

Test Mode	Mode 1	Transmit (802.11a)_Radio-2 Transmit (802.11ax-20 MHz)_Radio-2 Transmit (802.11ax-40 MHz)_Radio-2 Transmit (802.11ax-80 MHz)_Radio-2 Transmit (802.11a)_Radio-3 Transmit (802.11ac-20 MHz)_Radio-3 Transmit (802.11ac-40 MHz)_Radio-3 Transmit (802.11ac-80 MHz)_Radio-3
-----------	--------	--

1.2. Tested System Details

The types for all equipment, plus descriptions of all cables used in the tested system (including inserted cards) are:

Product	Manufacturer	Model No.	Serial No.	Power Cord
1 Power Adapter	SENAO	EAA65A-54	N/A	N/A
2 LAN Hub	TP-LINK	TL-SG108	2161597000471	N/A
3 Notebook PC	DELL	P62G	416FJC2	N/A

Cable Type	Cable Description
A Power Cable	Non-shielded, 1.7m with one ferrite core bonded.
B LAN Cable	Non-shielded, 2m, Six PCS.

1.3. Configuration of tested System

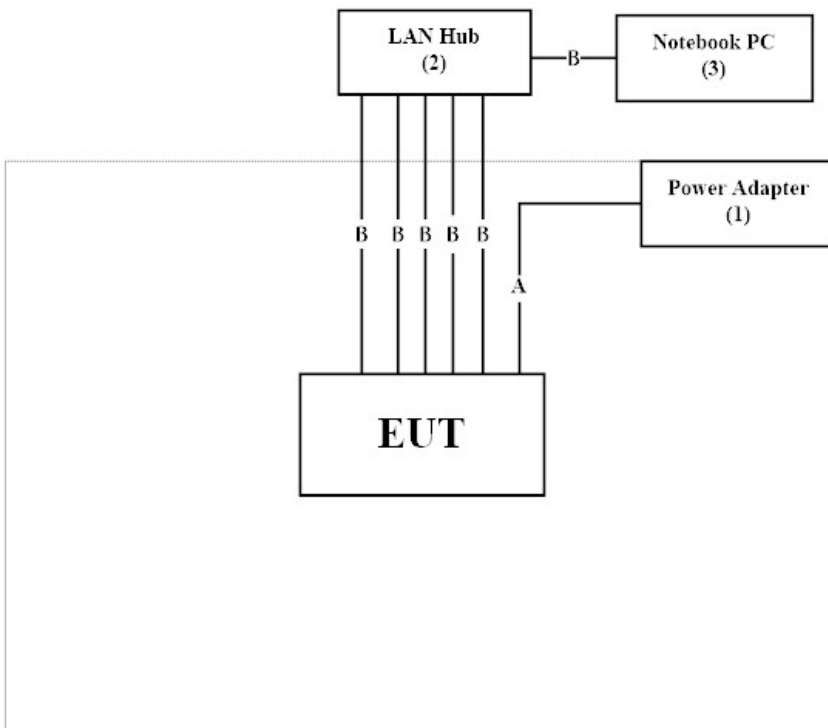

1.4. EUT Exercise Software

1	Setup the EUT as shown in Section 1.3.
2	Execute software “QSPR Version v5.0-00202” on the Notebook PC.
3	Configure the test mode, the test channel, and the data rate.
4	Press “OK” to start the continuous transmit.
5	Verify that the EUT works properly.

1.5. Test Facility

Ambient conditions in the laboratory:

Performed Item	Items	Required	Actual
Conducted Emission	Temperature (°C)	10~40 °C	23.5 °C
	Humidity (%RH)	10~90 %	56.0 %
Radiated Emission	Temperature (°C)	10~40 °C	22.5 °C
	Humidity (%RH)	10~90 %	53.0 %
Conductive	Temperature (°C)	10~40 °C	22.0 °C
	Humidity (%RH)	10~90 %	55.0 %

USA	FCC Registration Number: TW0033
Canada	CAB Identifier Number: TW3023 / Company Number: 26930

Site Description	Accredited by TAF
	Accredited Number: 3023

Test Laboratory	DEKRA Testing and Certification Co., Ltd.
	Linkou Laboratory
Address	No.5-22, Ruishukeng Linkou District, New Taipei City, 24451, Taiwan, R.O.C
Performed Location	No. 26, Huaya 1st Rd., Guishan Dist., Taoyuan City 333411, Taiwan, R.O.C.
Phone Number	+886-3-275-7255
Fax Number	+886-3-327-8031

1.6. List of Test Equipment

For Conduction Measurements / HY-SR01

	Equipment	Manufacturer	Model No.	Serial No.	Cal. Date	Due Date
V	EMI Test Receiver	R&S	ESR7	101601	2023/06/20	2024/06/19
V	Two-Line V-Network	R&S	ENV216	101306	2023/03/16	2024/03/15
V	Two-Line V-Network	R&S	ENV216	101307	2023/08/17	2024/08/16
V	Coaxial Cable	SUHNER	RG400 BNC	RF001	2023/01/10	2024/01/09

Note:

1. All equipments are calibrated every one year.
2. The test instruments marked with “V” are used to measure the final test results.
3. Test Software Version: e3 230303 dekra V9.

For Conducted Measurements / HY-SR02

	Equipment	Manufacturer	Model No.	Serial No.	Cal. Date	Due Date
V	Spectrum Analyzer	R&S	FSV30	103466	2022/12/22	2023/12/21
V	Peak Power Analyzer	KEYSIGHT	8990B	MY51000539	2023/05/15	2024/05/14
V	Power Sensor	KEYSIGHT	N1923A	MY59240002	2023/05/18	2024/05/17
V	Power Sensor	KEYSIGHT	N1923A	MY59240003	2023/05/18	2024/05/17

Note:

1. All equipments are calibrated every one year.
2. The test instruments marked with “V” are used to measure the final test results.
3. Test Software Version: RF Conducted Test Tools R3 V3.0.1.14.

For Radiated Measurements / HY-CB03

	Equipment	Manufacturer	Model No.	Serial No.	Cal. Date	Due Date
V	Loop Antenna	AMETEK	HLA6121	49611	2023/02/21	2024/02/20
V	Bi-Log Antenna	SCHWARZBECK	VULB9168	9168-0675	2023/08/09	2025/08/08
V	Horn Antenna	Com-Power	AH-840	101100	2021/10/04	2023/10/03
V	Horn Antenna	RF SPIN	DRH18-E	210507A18ES	2023/05/11	2024/05/10
V	Pre-Amplifier	SGH	0301	20211007-11	2023/01/10	2024/01/09
V	Pre-Amplifier	SGH	PRAMP118	20200701	2023/01/10	2024/01/09
V	Pre-Amplifier	EMCI	EMC05820SE	980310	2023/01/10	2024/01/09
V	Pre-Amplifier	EMCI	EMC184045SE	980369	2023/01/10	2024/01/09
	Coaxial Cable	EMCI	EMC102-KM-KM-600	1160314		
	Coaxial Cable	EMCI	EMC102-KM-KM-700	170242		
	Filter	MICRO TRONICS	BRM50702	G269	2023/01/05	2024/01/04
V	Filter	MICRO TRONICS	BRM50716	G196	2023/01/05	2024/01/04
V	EMI Test Receiver	R&S	ESR3	102793	2022/12/05	2023/12/04
V	Spectrum Analyzer	R&S	FSV3044	101113	2023/02/04	2024/02/03
V	Coaxial Cable	SGH	SGH18	2021005-1	2023/01/10	2024/01/09
	Coaxial Cable	SGH	SGH18	202108-4		
	Coaxial Cable	SGH	HA800	GD20110223-1		
	Coaxial Cable	SGH	HA800	GD20110222-3		

Note:

1. Bi-Log Antenna and Horn Antenna(AH-840) is calibrated every two years, the other equipments are calibrated every one year.
2. The test instruments marked with “V” are used to measure the final test results.

Test Software Version: e3 230303 dekra V9.

1.7. Uncertainty

Uncertainties have been calculated according to the DEKRA internal document.

The reported expanded uncertainties are based on a standard uncertainty multiplied by a coverage factor of $k=2$, providing a level of confidence of approximately 95%.

Measurement uncertainties evaluated for each testing system and associated connections are given here to provide the system information for reference. Compliance determinations do not take into account measurement uncertainties for each testing system, but are based on the results of the compliance measurement.

Test item	Uncertainty
Conducted Emission	± 3.50 dB
Maximum conducted output power	Spectrum Analyzer: ± 2.14 dB Power Meter: ± 1.05 dB
Peak Power Spectral Density	± 2.14 dB
Radiated Emission	9 kHz~30 MHz: ± 3.88 dB 30 MHz~1 GHz: ± 4.42 dB 1 GHz~18 GHz: ± 4.28 dB 18 GHz~40 GHz: ± 3.90 dB
Band Edge	9 kHz~30 MHz: ± 3.88 dB 30 MHz~1 GHz: ± 4.42 dB 1 GHz~18 GHz: ± 4.28 dB 18 GHz~40 GHz: ± 3.90 dB
Occupied Bandwidth	± 1580.61 Hz
Duty Cycle	± 0.53 %

2. Conducted Emission

2.1. Test Setup

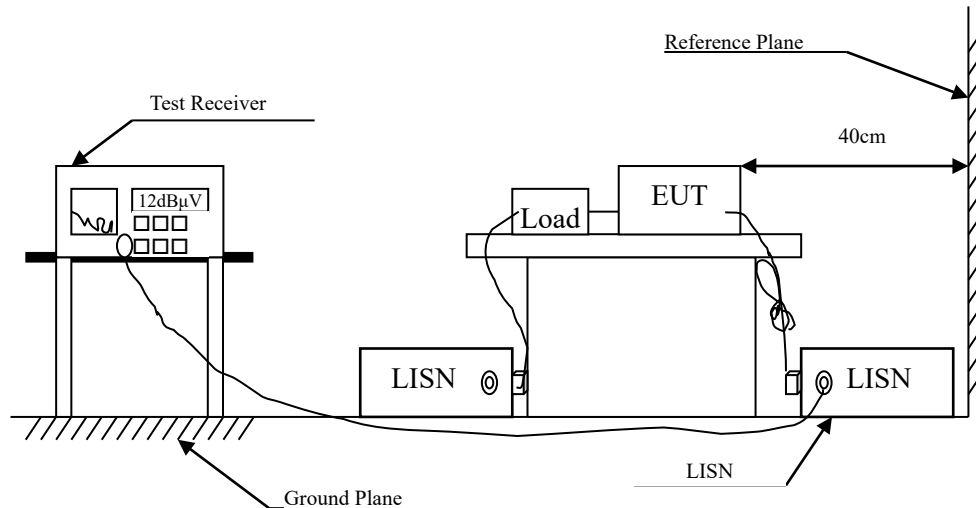

2.2. Limits

FCC Part 15 Subpart C Paragraph 15.207 (dB μ V) Limit		
Frequency MHz	Limits	
	QP	AV
0.15 - 0.50	66-56	56-46
0.50 - 5.0	56	46
5.0 - 30	60	50

Remarks: In the above table, the tighter limit applies at the band edges.

2.3. Test Procedure

The EUT and simulators are connected to the main power through a line impedance stabilization network (L.I.S.N.). This provides a 50 ohm /50uH coupling impedance for the measuring equipment. The peripheral devices are also connected to the main power through a LISN that provides a 50ohm /50uH coupling impedance with 50ohm termination. (Please refers to the block diagram of the test setup and photographs.)

Both sides of A.C. line are checked for maximum conducted interference. In order to find the maximum emission, the relative positions of equipment and all of the interface cables must be changed according to ANSI C63.4:2014 on conducted measurement.

Conducted emissions were investigated over the frequency range from 0.15 MHz to 30 MHz using a receiver bandwidth of 9 kHz.

2.4. Test Result of Conducted Emission

Radio-2

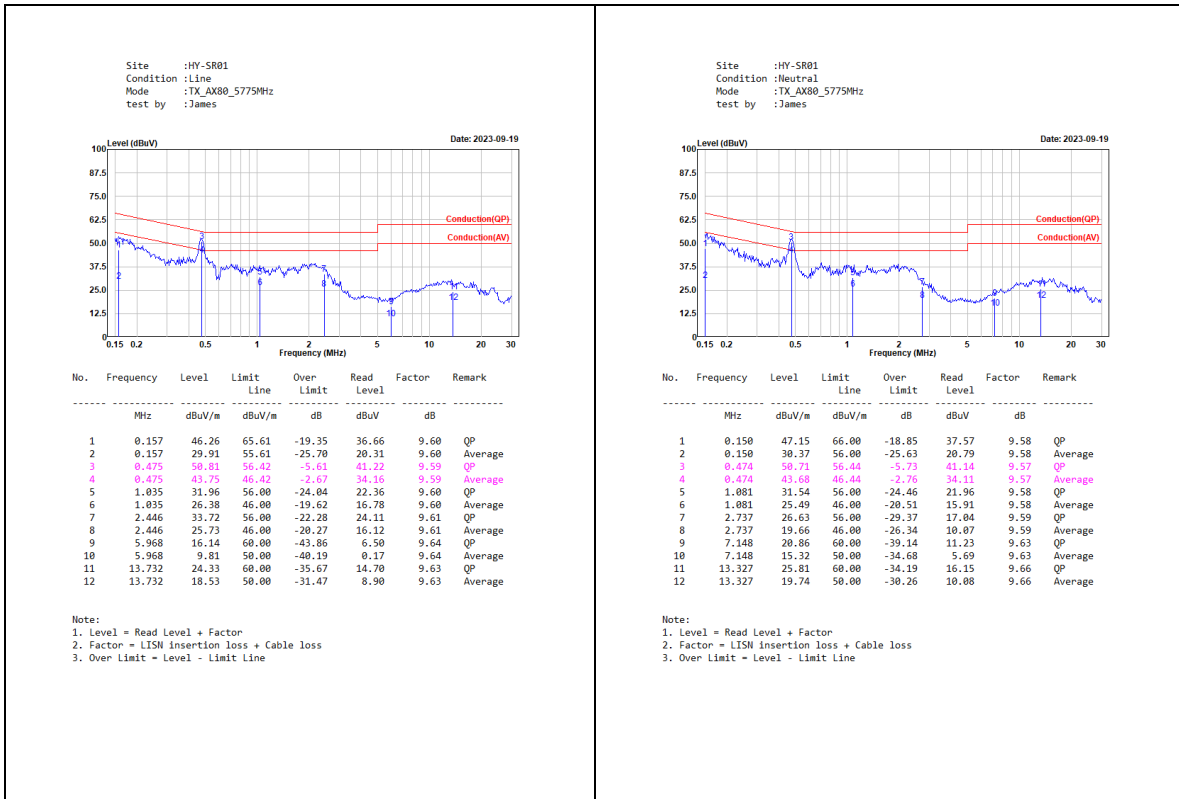

Radio-3

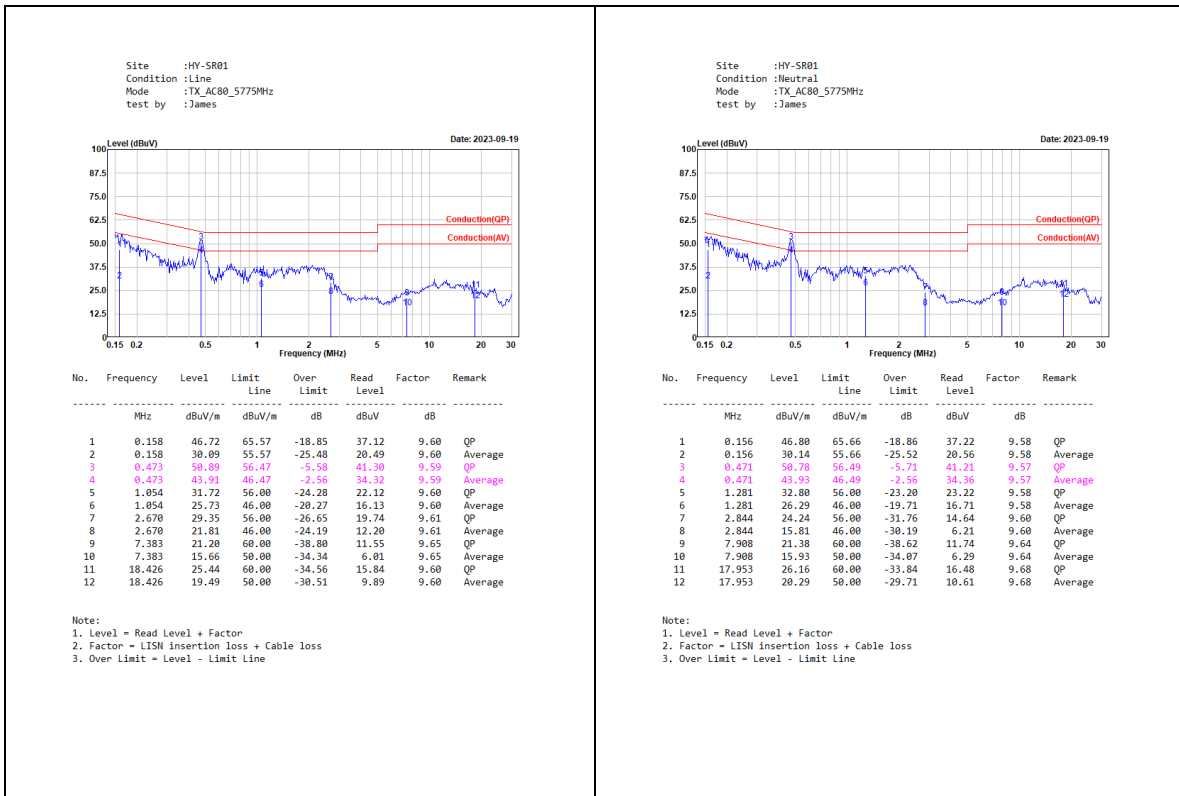

3. Maximun conducted output power

3.1. Test Setup

26dB Occupied Bandwidth

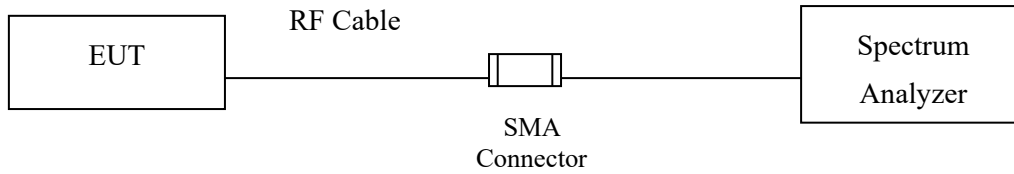

Conduction Power Measurement

Conduction Power Measurement (for 802.11an)

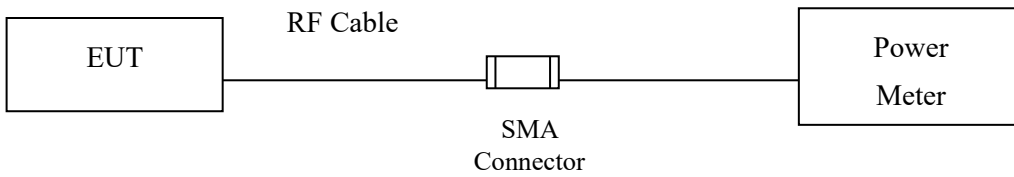

Conduction Power Measurement (for 802.11ac/ax)

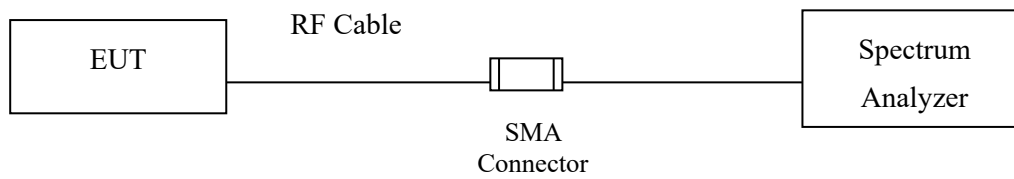

3.2. Limits

For the band 5.15-5.25 GHz,

- (i)** For an outdoor access point operating in the band 5.15-5.25 GHz, the maximum conducted output power over the frequency band of operation shall not exceed 1 W, provided the maximum antenna gain does not exceed 6 dBi. If transmitting antennas of directional gain greater than 6 dBi are used, the maximum conducted output power shall be reduced by the amount in dB that the directional gain of the antenna exceeds 6 dBi. The maximum e.i.r.p. at any elevation angle above 30 degrees as measured from the horizon must not exceed 125 mW (21 dBm).
- (ii)** For an indoor access point operating in the band 5.15-5.25 GHz, the maximum conducted output power over the frequency band of operation shall not exceed 1 W provided the maximum antenna gain does not exceed 6 dBi. In addition, if transmitting antennas of directional gain greater than 6 dBi are used, the maximum conducted output power shall be reduced by the amount in dB that the directional gain of the antenna exceeds 6 dBi.
- (iii)** For fixed point-to-point access points operating in the band 5.15-5.25 GHz, the maximum conducted output power over the frequency band of operation shall not exceed 1 W. Fixed point-to-point U-NII devices may employ antennas with directional gain up to 23 dBi without any corresponding reduction in the maximum conducted output power. For fixed point-to-point transmitters that employ a directional antenna gain greater than 23 dBi, a 1 dB reduction in maximum conducted output power is required for each 1 dB of antenna gain in excess of 23 dBi. Fixed, point-to-point operations exclude the use of point-to-multipoint systems, omnidirectional applications, and multiple collocated transmitters transmitting the same information. The operator of the U-NII device, or if the equipment is professionally installed, the installer, is responsible for ensuring that systems employing high gain directional antennas are used exclusively for fixed, point-to-point operations.
- (iv)** For mobile and portable client devices in the 5.15-5.25 GHz band, the maximum conducted output power over the frequency band of operation shall not exceed 250 mW provided the maximum antenna gain does not exceed 6 dBi. In addition, if transmitting antennas of directional gain greater than 6 dBi are used, the maximum conducted output power shall be reduced by the amount in dB that the directional gain of the antenna exceeds 6 dBi.

For the 5.25-5.35 GHz and 5.47-5.725 GHz bands, the maximum conducted output power over the frequency bands of operation shall not exceed the lesser of 250 mW or $11 \text{ dBm} + 10 \log B$, where B is the 26dB emission bandwidth in megahertz. If transmitting antennas of directional gain greater than 6 dBi are used, the maximum conducted output power shall be reduced by the amount in dB that the directional gain of the antenna exceeds 6 dBi.

For the band 5.725-5.85 GHz, the maximum conducted output power over the frequency band of operation shall not exceed 1 W. In addition. If transmitting antennas of directional gain greater than 6 dBi are used, the maximum conducted output power shall be reduced by the amount in dB that the directional gain of the antenna exceeds 6 dBi. However, fixed point-to-point UNII devices operating in this band may employ transmitting antennas with directional gain greater than 6 dBi without any corresponding reduction in transmitter conducted power. Fixed, point-to-point operations exclude the use of point-to-multipoint systems, omnidirectional applications, and multiple collocated transmitters transmitting the same information. The operator of the U-NII device, or if the equipment is professionally installed, the installer, is responsible for ensuring that systems employing high gain directional antennas are used exclusively for fixed, point-to-point operations.

The maximum conducted output power shall be reduced by the amount in dB that the directional gain of the antenna exceeds 6 dBi.

For CDD mode (Radio-2):

5150MHz-5250MHz: Directional gain = 2.31 dBi, Limit= 30dBm

5725MHz-5850MHz: Directional gain = 3.77 dBi, Limit= 30dBm

(Directional gain = $G_{ANT\ MAX} + \text{Array Gain}$, Array Gain = 0 dB for $N_{ANT} \leq 2$)

3.3. Test Procedure

As an alternative to FCC KDB-789033, the EUT maximum conducted output power was measured with an average power meter employing a video bandwidth greater the 6dB BW of the emission under test. Maximum conducted output power was read directly from the meter across all data rates, and across three channels within each sub-band. Special care was used to make sure that the EUT was transmitting in continuous mode. This method exceeds the limitations of FCC KDB-789033, and provides more accurate measurements.

802.11an (BW \leq 40MHz) Maximum conducted output power using KDB 789033 section E)3)b) Method PM-G (Measurement using a gated RF average power meter)

Note: the power meter have a video bandwidth that is greater than or equal to the measurement bandwidth, (Anritsu/ MA2411B video bandwidth: 65MHz)

802.11ac (BW=80MHz) Maximum conducted output power using KDB 789033 section E)2)b) Method SA-1 (trace averaging with the EUT transmitting at full power throughout each sweep).

When transmitted signals consist of two or more non-contiguous spectrum segments (e.g., 80+80 MHz mode) or when a single spectrum segment of a transmission crosses the boundary between two adjacent U-NII bands, KDB 644545 D03 section D) procedure is used for measurements.

3.4. Test Result of Maximum conducted output power

Product : Wireless Access Point
Test Item : Maximum conducted output power
Test Mode : Transmit (802.11a)_Radio-2
Test Date : 2023/09/13

Channel No.	Frequency (MHz)	Chain A Power (dBm)	Chain B Power (dBm)	Output Power (dBm)	Output Power Limit (dBm)
36	5180	19.64	17.43	21.68	30
44	5220	18.71	17.45	21.14	30
48	5240	19.62	18.46	22.09	30
149	5745	16.95	15.72	19.39	30
157	5785	17.81	16.72	20.31	30
165	5825	18.24	17.03	20.69	30

Product : Wireless Access Point
Test Item : Maximum conducted output power
Test Mode : Transmit (802.11ax-20 MHz)_Radio-2
Test Date : 2023/09/13

Channel No.	Frequency (MHz)	Chain A Power (dBm)	Chain B Power (dBm)	Output Power (dBm)	Output Power Limit (dBm)
36	5180	19.46	17.43	21.57	30
44	5220	19.72	18.04	21.97	30
48	5240	19.68	18.24	22.03	30
149	5745	17.81	16.64	20.27	30
157	5785	16.34	15.13	18.79	30
165	5825	16.84	15.55	19.25	30

Product : Wireless Access Point
Test Item : Maximum conducted output power
Test Mode : Transmit (802.11ax-40 MHz)_Radio-2
Test Date : 2023/09/13

Channel No.	Frequency (MHz)	Chain A Power (dBm)	Chain B Power (dBm)	Output Power (dBm)	Output Power Limit (dBm)
38	5190	18.61	16.66	20.75	30
46	5230	19.69	18.24	22.04	30
151	5755	18.75	17.65	21.25	30
159	5795	18.35	17.06	20.76	30

Product : Wireless Access Point
Test Item : Maximum conducted output power
Test Mode : Transmit (802.11ax-80 MHz)_Radio-2
Test Date : 2023/09/13

Channel No.	Frequency (MHz)	Chain A Power (dBm)	Chain B Power (dBm)	Output Power (dBm)	Output Power Limit (dBm)
42	5210	17.57	15.98	19.86	30
155	5775	19.87	18.84	22.40	30

Product : Wireless Access Point
Test Item : Maximum conducted output power
Test Mode : Transmit (802.11a)_Radio-3
Test Date : 2023/09/19

Channel No.	Frequency (MHz)	Output Power (dBm)	Output Power Limit (dBm)
36	5180	16.35	30
44	5220	16.18	30
48	5240	16.29	30
149	5745	15.81	30
157	5785	15.67	30
165	5825	15.77	30

Product : Wireless Access Point
Test Item : Maximum conducted output power
Test Mode : Transmit (802.11ac-20 MHz)_Radio-3
Test Date : 2023/09/19

Channel No.	Frequency (MHz)	Output Power (dBm)	Output Power Limit (dBm)
36	5180	16.31	30
44	5220	16.16	30
48	5240	16.26	30
149	5745	15.72	30
157	5785	15.67	30
165	5825	15.76	30

Product : Wireless Access Point
Test Item : Maximum conducted output power
Test Mode : Transmit (802.11ac-40 MHz)_Radio-3
Test Date : 2023/09/12

Channel No.	Frequency (MHz)	Output Power (dBm)	Output Power Limit (dBm)
38	5190	12.91	30
46	5230	15.72	30
151	5755	15.42	30
159	5795	15.37	30

Product : Wireless Access Point
Test Item : Maximum conducted output power
Test Mode : Transmit (802.11ac-80 MHz)_Radio-3
Test Date : 2023/09/12

Channel No.	Frequency (MHz)	Output Power (dBm)	Output Power Limit (dBm)
42	5210	10.91	30
155	5775	15.26	30

4. Peak Power Spectral Density

4.1. Test Setup

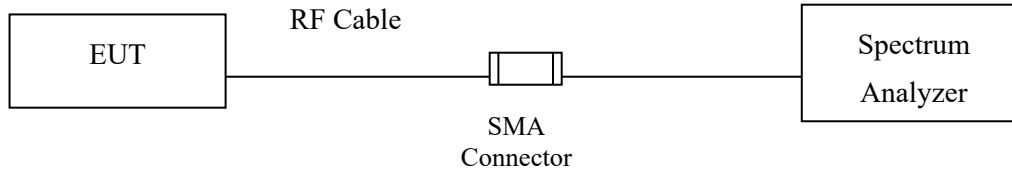

4.2. Limits

For the band 5.15-5.25 GHz,

(i) For an outdoor access point operating in the band 5.15-5.25 GHz, the maximum power spectral density shall not exceed 17 dBm in any 1 megahertz band. If transmitting antennas of directional gain greater than 6 dBi are used, the maximum power spectral density shall be reduced by the amount in dB that the directional gain of the antenna exceeds 6 dBi.

(ii) For an indoor access point operating in the band 5.15-5.25 GHz, the maximum power spectral density shall not exceed 17 dBm in any 1 megahertz band. If transmitting antennas of directional gain greater than 6 dBi are used, the maximum power spectral density shall be reduced by the amount in dB that the directional gain of the antenna exceeds 6 dBi.

(iii) For fixed point-to-point access points operating in the band 5.15-5.25 GHz, the maximum conducted output power over the frequency band of operation shall not exceed 1 W. Fixed point-to-point U-NII devices may employ antennas with directional gain up to 23 dBi without any corresponding reduction in the maximum conducted output power or maximum power spectral density. For fixed point-to-point transmitters that employ a directional antenna gain greater than 23 dBi, a 1 dB reduction in maximum conducted output power and maximum power spectral density is required for each 1 dB of antenna gain in excess of 23 dBi. Fixed, point-to-point operations exclude the use of point-to-multipoint systems, omnidirectional applications, and multiple collocated transmitters transmitting the same information. The operator of the U-NII device, or if the equipment is professionally installed, the installer, is responsible for ensuring that systems employing high gain directional antennas are used exclusively for fixed, point-to-point operations.

(iv) For mobile and portable client devices in the 5.15-5.25 GHz band, the maximum power spectral density shall not exceed 11 dBm in any 1 megahertz band. If transmitting antennas of directional gain greater than 6 dBi are used, the maximum power spectral density shall be reduced by the amount in dB that the directional gain of the antenna exceeds 6 dBi.+

For the 5.25-5.35 GHz and 5.47-5.725 GHz bands, the maximum power spectral density shall not exceed 11 dBm in any 1 megahertz band. If transmitting antennas of directional gain greater than 6 dBi are used, the maximum power spectral density shall be reduced by the amount in dB that the directional gain of the antenna exceeds 6 dBi.

For the band 5.725-5.85 GHz, the maximum power spectral density shall not exceed 30 dBm in any 500-kHz band. If transmitting antennas of directional gain greater than 6 dBi are used, the maximum power spectral density shall be reduced by the amount in dB that the directional gain of the antenna exceeds 6 dBi. However, fixed point-to-point UNII devices operating in this band may employ transmitting antennas with directional gain greater than 6 dBi without any corresponding reduction in transmitter conducted power. Fixed, point-to-point operations exclude the use of point-to-multipoint systems, omnidirectional applications, and multiple collocated transmitters transmitting the same information. The operator of the U-NII device, or if the equipment is professionally installed, the installer, is responsible for ensuring that systems employing high gain directional antennas are used exclusively for fixed, point-to-point operations.

The maximum conducted output power shall be reduced by the amount in dB that the directional gain of the antenna exceeds 6 dBi.

For CDD mode (Radio-2):

5150MHz-5250MHz: Directional gain = 5.30 dBi, Limit= 17.0dBm

5725MHz-5850MHz: Directional gain = 6.50 dBi, Limit= 29.5dBm

Directional gain = $10 \log[(10^{G1/20} + 10^{G2/20})^2 / N_{ANT}]$ dBi

4.3. Test Procedure

The EUT was setup to ANSI C63.10, 2013; tested to UNII test procedure of FCC KDB-789033 for compliance to FCC 47CFR Subpart E requirements.

The Peak Power Spectral Density using KDB 789033 section F) procedure, Create an average power spectrum for the EUT operating mode being tested by following the instructions in section E)2) for measuring maximum conducted output power using a spectrum analyzer.

SA-1 method is selected to run the test.

4.4. Test Result of Peak Power Spectral Density

Product : Wireless Access Point
 Test Item : Peak Power Spectral Density
 Test Mode : Transmit (802.11a)_Radio-2
 Test Date : 2023/09/13

Channel No.	Frequency (MHz)	Data Rate (Mbps)	Chain	PPSD/MHz (dBm)	Duty factor (dB)	Total PPSD/MHz (dBm)	Required Limit (dBm)	Result
36	5180	6	A	7.67	0.39	9.95	<17	Pass
			B	5.05				Pass
44	5220	6	A	6.71	0.39	9.44	<17	Pass
			B	5.25				Pass
48	5240	6	A	7.79	0.39	10.61	<17	Pass
			B	6.54				Pass

Note:

1. Total PPSD/MHz = PPSD/MHz + 10*log 2 (two antennas) + Duty factor.
2. The quantity 10*log 2 (two antennas) is added to the spectrum peak value according to document 662911 D01.

Channel No.	Frequency (MHz)	Data Rate (Mbps)	Chain	PPSD (dBm)	Duty factor (dB)	Total PPSD (dBm)	Required Limit (dBm)	Result
149	5745	6	A	2.36	0.39	5.12	<29.5	Pass
			B	0.97				Pass
157	5785	6	A	3.66	0.39	6.18	<29.5	Pass
			B	1.67				Pass
165	5825	6	A	3.63	0.39	6.31	<29.5	Pass
			B	2.04				Pass

Note:

1. Total PPSD = PPSD + 10*log 2 (two antennas) + Duty factor.
2. The quantity 10*log 2 (two antennas) is added to the spectrum peak value according to document 662911 D01.

Channel 48 (Chain A)

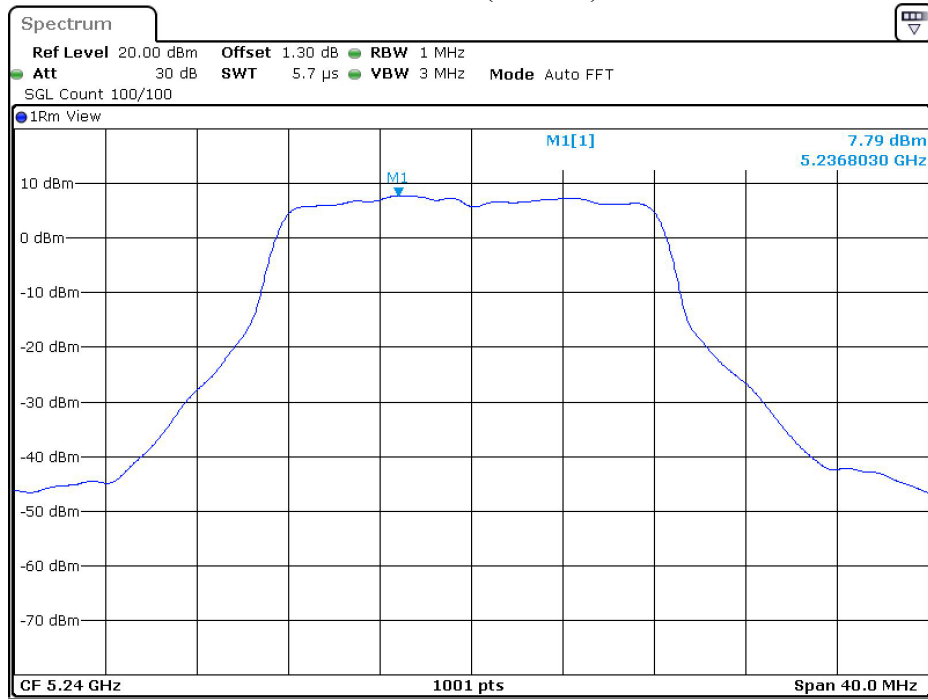

Date: 13.SEP.2023 17:42:49

Channel 157 (Chain A)

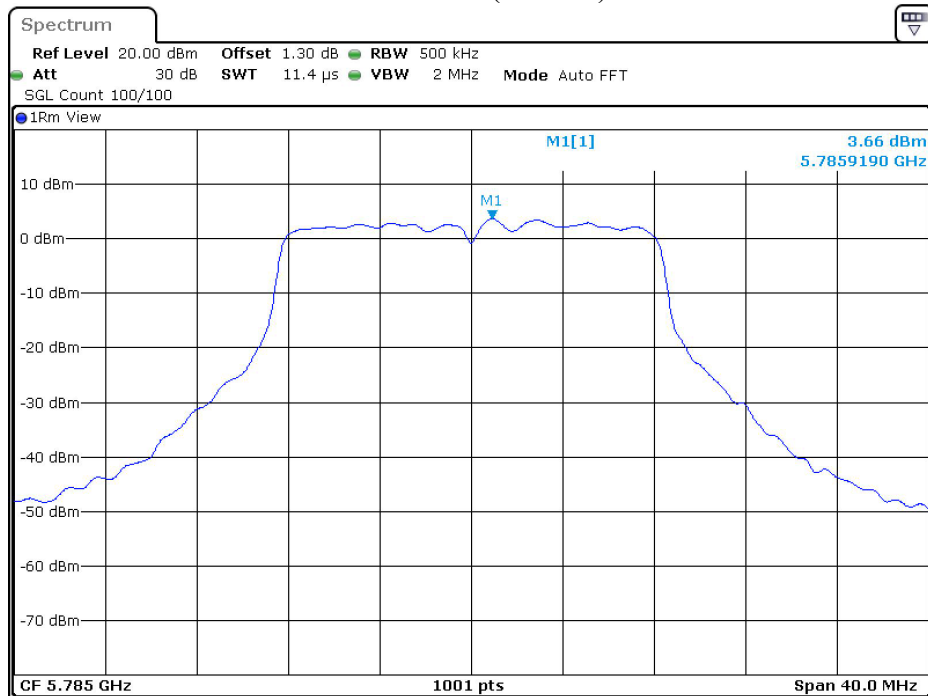

Date: 13.SEP.2023 17:47:47

Product : Wireless Access Point
 Test Item : Peak Power Spectral Density
 Test Mode : Transmit (802.11ax-20 MHz)_Radio-2
 Test Date : 2023/09/13

Channel No.	Frequency (MHz)	Data Rate	Chain	PPSD/MHz (dBm)	Duty factor (dB)	Total PPSD/MHz (dBm)	Required Limit (dBm)	Result
36	5180	MCS0	A	6.86	0.22	9.52	<17	Pass
			B	5.62				Pass
44	5220	MCS0	A	7.36	0.22	9.72	<17	Pass
			B	5.39				Pass
48	5240	MCS0	A	7.19	0.22	9.86	<17	Pass
			B	5.98				Pass

Note:

1. Total PPSD/MHz = PPSD/MHz +10*log 2 (two antennas)+Duty factor.
2. The quantity 10*log 2 (two antennas) is added to the spectrum peak value according to document 662911 D01.

Channel No.	Frequency (MHz)	Data Rate	Chain	PPSD (dBm)	Duty factor (dB)	Total PPSD (dBm)	Required Limit (dBm)	Result
149	5745	MCS0	A	2.45	0.22	5.31	<29.5	Pass
			B	1.67				Pass
157	5785	MCS0	A	1.74	0.22	4.22	<29.5	Pass
			B	0.08				Pass
165	5825	MCS0	A	1.72	0.22	4.20	<29.5	Pass
			B	0.07				Pass

Note:

1. Total PPSD = PPSD +10*log 2 (two antennas)+Duty factor.
2. The quantity 10*log 2 (two antennas) is added to the spectrum peak value according to document 662911 D01.

Channel 44 (Chain A)

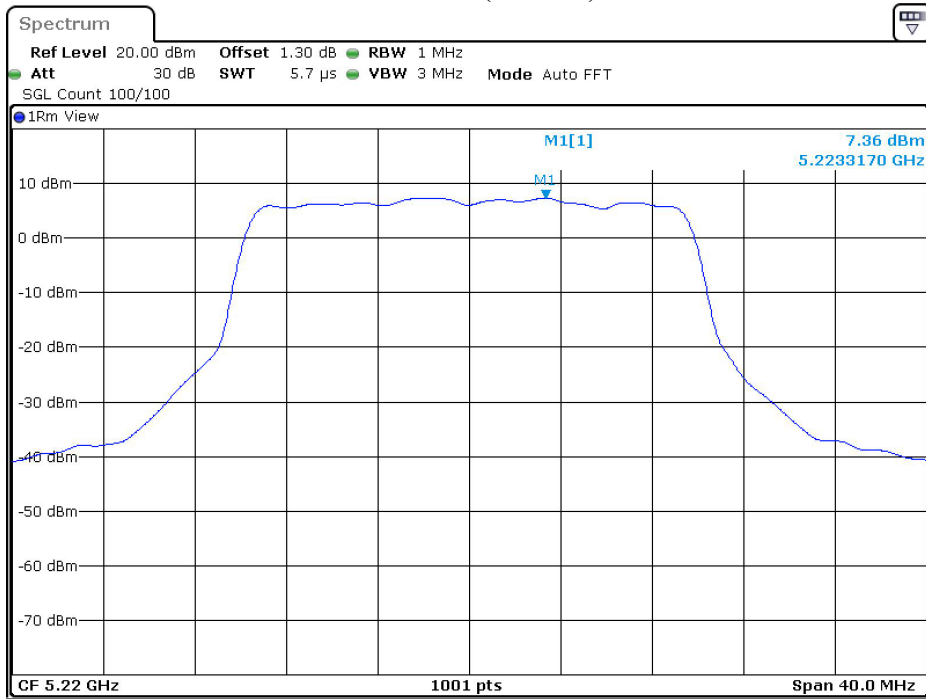

Date: 13.SEP.2023 17:59:20

Channel 149 (Chain A)

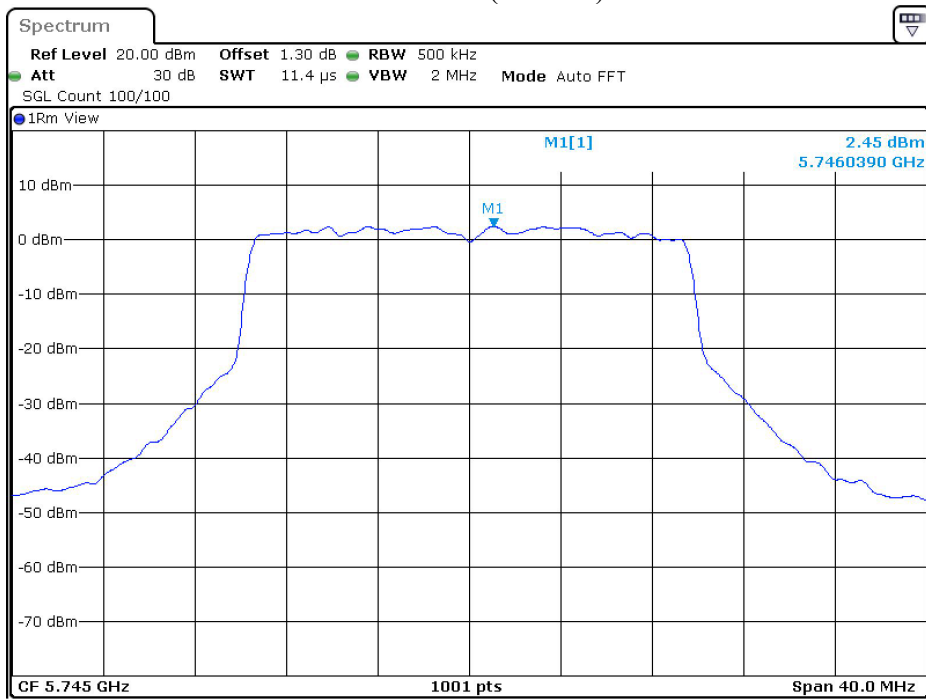

Date: 13.SEP.2023 18:46:51

Product : Wireless Access Point
 Test Item : Peak Power Spectral Density
 Test Mode : Transmit (802.11ax-40 MHz)_Radio-2
 Test Date : 2023/09/13

Channel No.	Frequency (MHz)	Data Rate	Chain	PPSD/MHz (dBm)	Duty factor (dB)	Total PPSD/MHz (dBm)	Required Limit (dBm)	Result
38	5190	MCS0	A	3.43	0.20	5.99	<17	Pass
			B	2.02				Pass
46	5230	MCS0	A	4.57	0.20	7.08	<17	Pass
			B	3.05				Pass

Note:

1. Total PPSD/MHz = PPSD/MHz +10*log 2 (two antennas)+Duty factor.
2. The quantity 10*log 2 (two antennas) is added to the spectrum peak value according to document 662911 D01.

Channel No.	Frequency (MHz)	Data Rate	Chain	PPSD (dBm)	Duty factor (dB)	Total PPSD (dBm)	Required Limit (dBm)	Result
151	5755	MCS0	A	0.92	0.20	3.74	<29.5	Pass
			B	0.11				Pass
159	5795	MCS0	A	1.06	0.20	3.56	<29.5	Pass
			B	-0.49				Pass

Note:

1. Total PPSD = PPSD +10*log 2 (two antennas)+Duty factor.
2. The quantity 10*log 2 (two antennas) is added to the spectrum peak value according to document 662911 D01.

Channel 46 (Chain A)

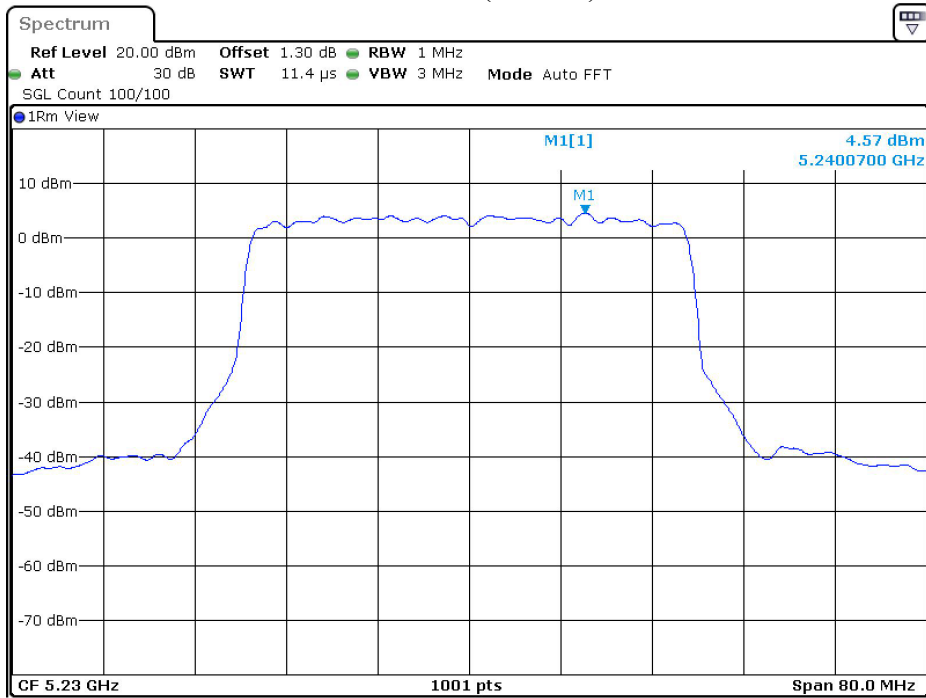

Date: 13.SEP.2023 19:02:30

Channel 159 (Chain A)

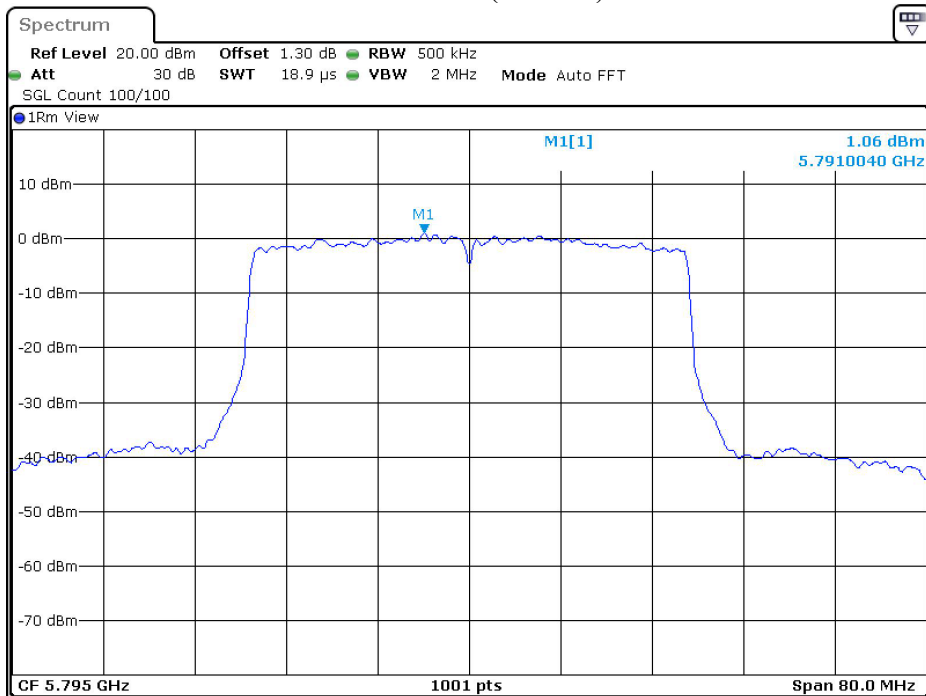

Date: 13.SEP.2023 19:48:10

Product : Wireless Access Point
 Test Item : Peak Power Spectral Density
 Test Mode : Transmit (802.11ax-80 MHz)_Radio-2
 Test Date : 2023/09/13

Channel No.	Frequency (MHz)	Data Rate	Chain	PPSD/MHz (dBm)	Duty factor (dB)	Total PPSD/MHz (dBm)	Required Limit (dBm)	Result
42	5210	MCS0	A	-0.02	0.28	2.30	<17	Pass
			B	-2.24				Pass

Note:

1. Total PPSD/MHz = PPSD/MHz +10*log 2 (two antennas)+Duty factor.
2. The quantity 10*log 2 (two antennas) is added to the spectrum peak value according to document 662911 D01.

Channel No.	Frequency (MHz)	Data Rate	Chain	PPSD (dBm)	Duty factor (dB)	Total PPSD (dBm)	Required Limit (dBm)	Result
155	5775	MCS0	A	-0.62	0.28	2.07	<29.5	Pass
			B	-1.92				Pass

Note:

1. Total PPSD = PPSD +10*log 2 (two antennas)+Duty factor.
2. The quantity 10*log 2 (two antennas) is added to the spectrum peak value according to document 662911 D01.

Channel 42 (Chain A)

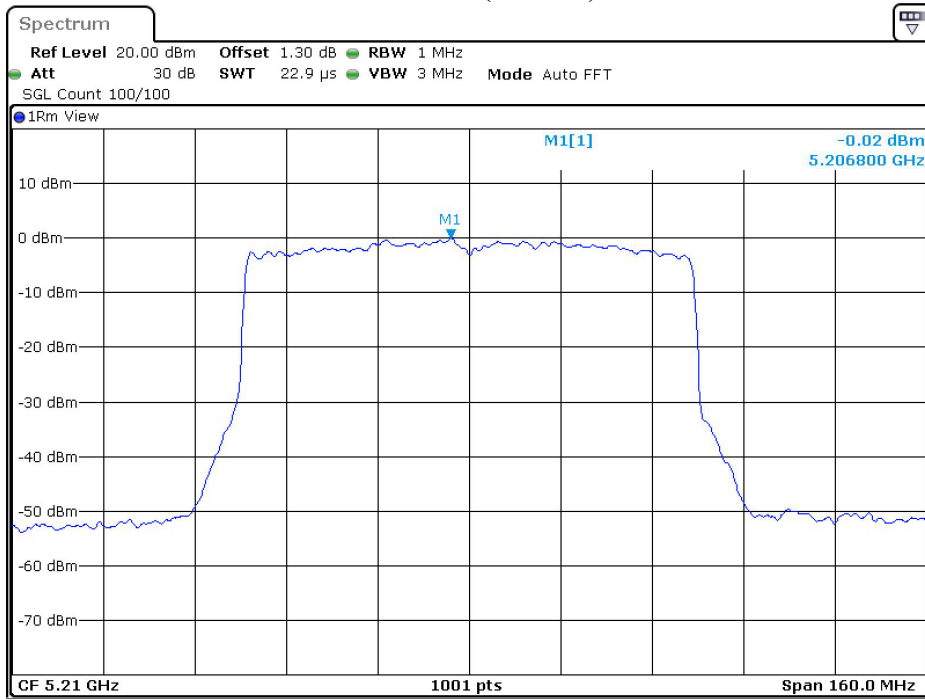

Date: 13.SEP.2023 19:51:06

Channel 155 (Chain A)

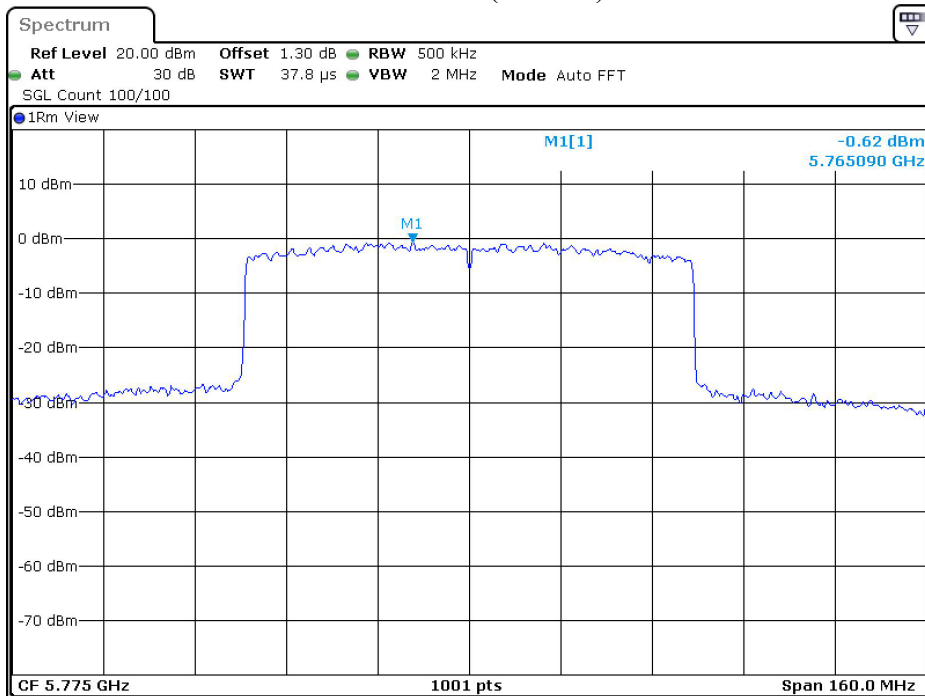

Date: 13.SEP.2023 19:53:50

Product : Wireless Access Point
 Test Item : Peak Power Spectral Density
 Test Mode : Transmit (802.11a)_Radio-3
 Test Date : 2023/09/12

Channel No.	Frequency (MHz)	Data Rate (Mbps)	PPSD/MHz (dBm)	Duty factor (dB)	Total PPSD/MHz (dBm)	Required Limit (dBm)	Result
36	5180	6	5.02	0.16	5.18	<17	Pass
44	5220	6	4.63	0.16	4.79	<17	Pass
48	5240	6	4.72	0.16	4.88	<17	Pass

Note: Total PPSD/MHz = PPSD/MHz + Duty factor.

Channel No.	Frequency (MHz)	Data Rate (Mbps)	PPSD (dBm)	Duty factor (dB)	Total PPSD (dBm)	Required Limit (dBm)	Result
149	5745	6	1.45	0.16	1.61	<30	Pass
157	5785	6	1.23	0.16	1.39	<30	Pass
165	5825	6	1.10	0.16	1.26	<30	Pass

Note: Total PPSD = PPSD + Duty factor.

Channel 36

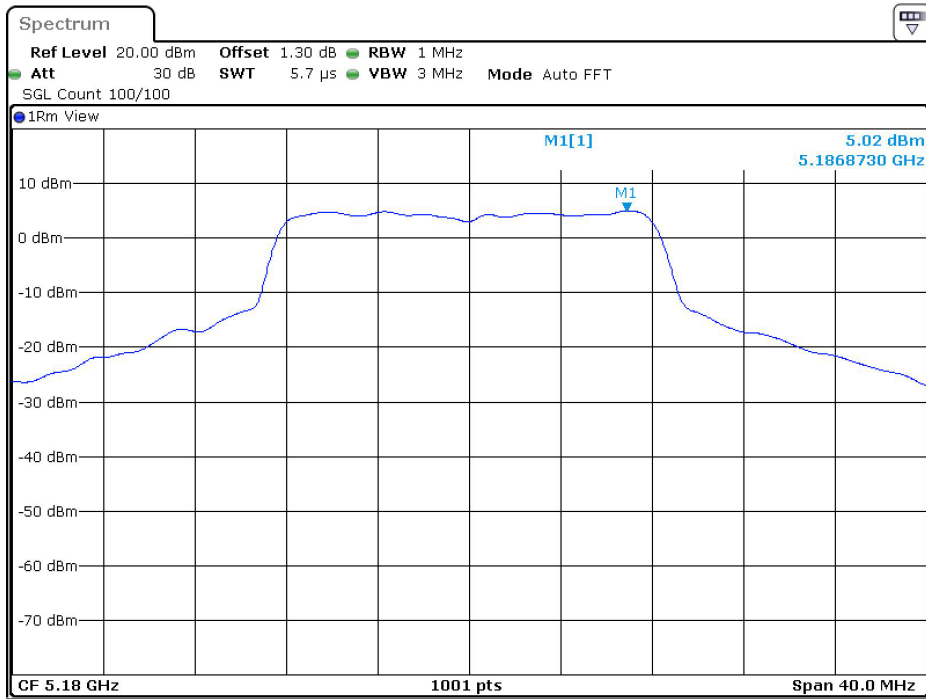

Date: 12.SEP.2023 17:05:37

Channel 149

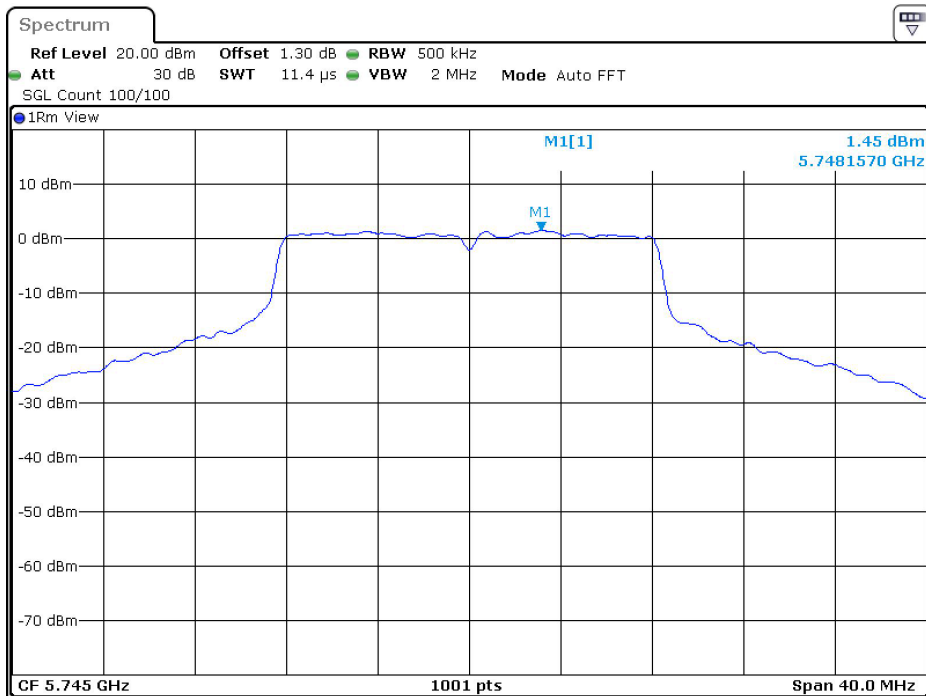

Date: 12.SEP.2023 17:12:25

Product : Wireless Access Point
 Test Item : Peak Power Spectral Density
 Test Mode : Transmit (802.11ac-20 MHz)_Radio-3
 Test Date : 2023/09/12

Channel No.	Frequency (MHz)	Data Rate	PPSD/MHz (dBm)	Duty factor (dB)	Total PPSD/MHz (dBm)	Required Limit (dBm)	Result
36	5180	HT0	4.55	0.17	4.72	<17	Pass
44	5220	HT0	4.10	0.17	4.27	<17	Pass
48	5240	HT0	4.12	0.17	4.29	<17	Pass

Note: Total PPSD/MHz = PPSD/MHz + Duty factor.

Channel No.	Frequency (MHz)	Data Rate	PPSD (dBm)	Duty factor (dB)	Total PPSD (dBm)	Required Limit (dBm)	Result
149	5745	HT0	1.21	0.17	1.38	<30	Pass
157	5785	HT0	1.16	0.17	1.33	<30	Pass
165	5825	HT0	0.86	0.17	1.03	<30	Pass

Note: Total PPSD = PPSD + Duty factor.

Channel 36

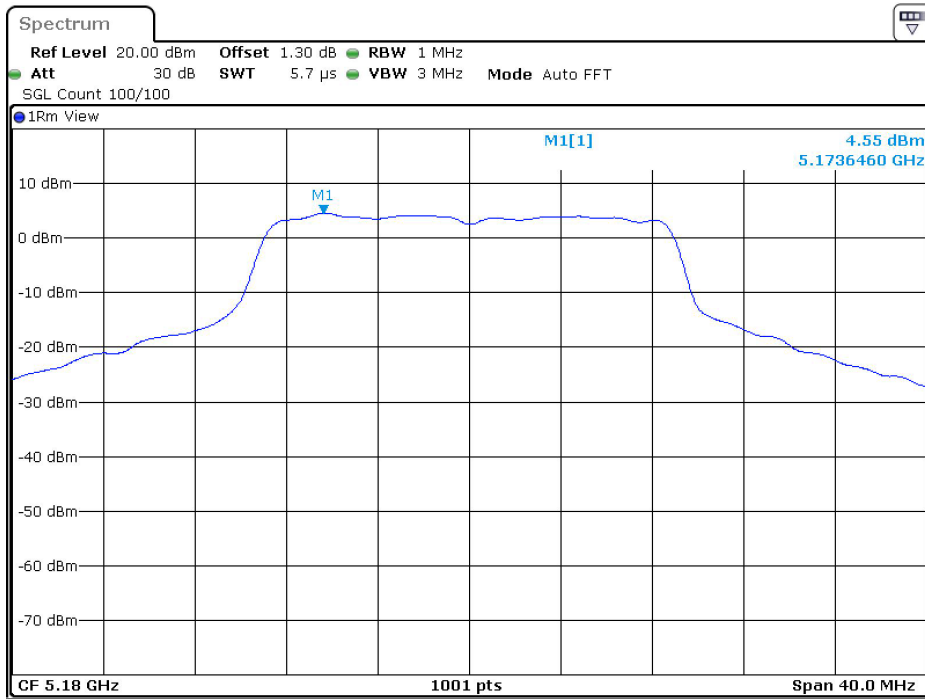

Date: 12.SEP.2023 17:20:55

Channel 149

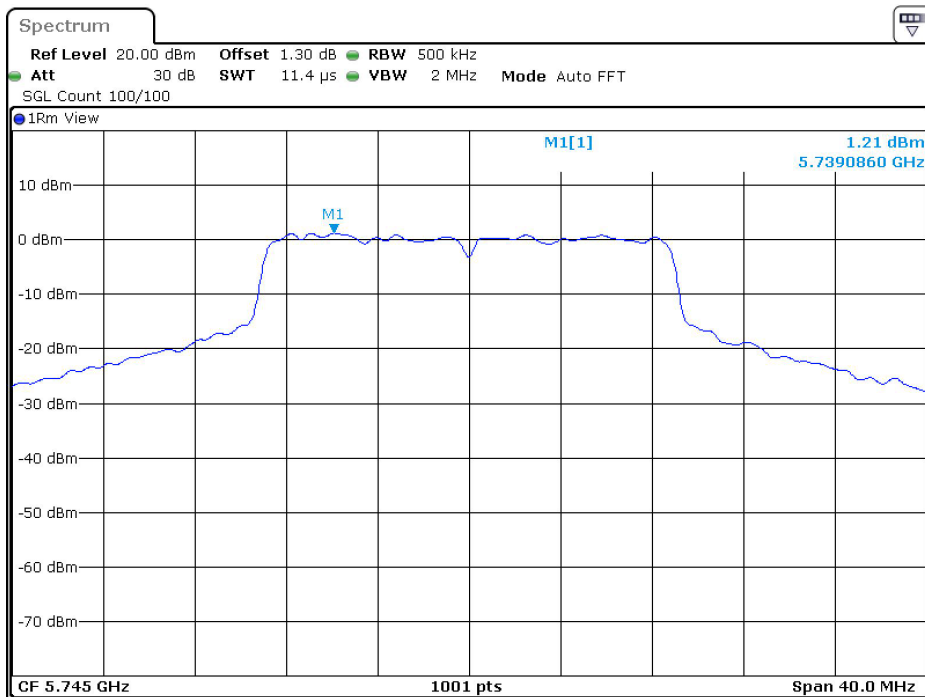

Date: 12.SEP.2023 17:23:13

Product : Wireless Access Point
 Test Item : Peak Power Spectral Density
 Test Mode : Transmit (802.11ac-40 MHz)_Radio-3
 Test Date : 2023/09/12

Channel No.	Frequency (MHz)	Data Rate	PPSD/MHz (dBm)	Duty factor (dB)	Total PPSD/MHz (dBm)	Required Limit (dBm)	Result
38	5190	HT0	-2.23	0.35	-1.88	<17	Pass
46	5230	HT0	1.03	0.35	1.38	<17	Pass

Note: Total PPSD/MHz = PPSD/MHz + Duty factor.

Channel No.	Frequency (MHz)	Data Rate	PPSD (dBm)	Duty factor (dB)	Total PPSD (dBm)	Required Limit (dBm)	Result
151	5755	HT0	-2.29	0.35	-1.94	<30	Pass
159	5795	HT0	-2.51	0.35	-2.16	<30	Pass

Note: Total PPSD = PPSD + Duty factor.

Channel 46

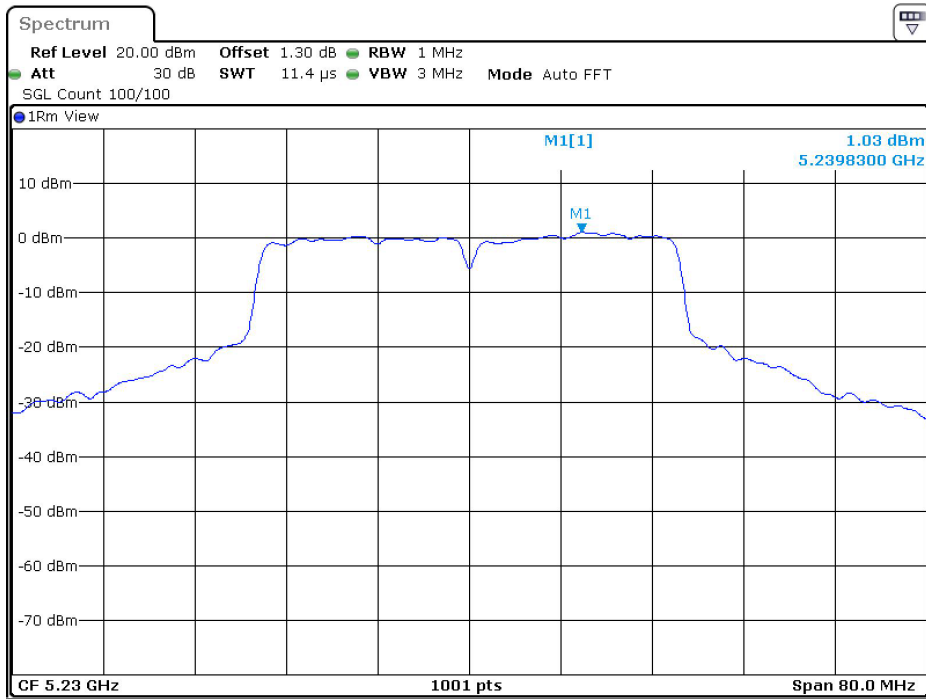

Date: 12.SEP.2023 17:27:44

Channel 151

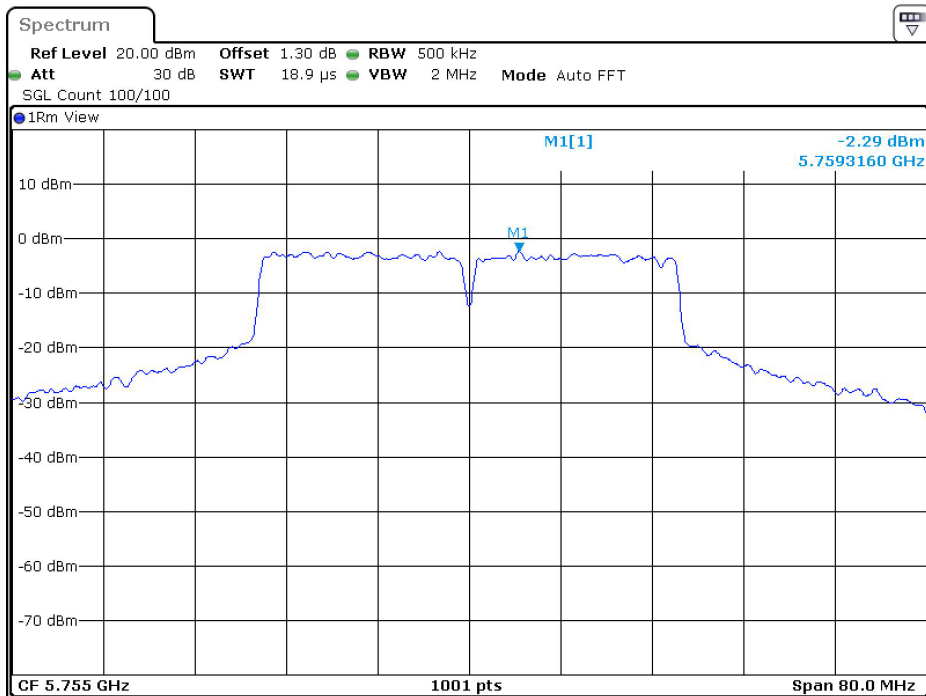

Date: 12.SEP.2023 17:28:57

Product : Wireless Access Point
 Test Item : Peak Power Spectral Density
 Test Mode : Transmit (802.11ac-80 MHz)_Radio-3
 Test Date : 2023/09/12

Channel No.	Frequency (MHz)	Data Rate	PPSD/MHz (dBm)	Duty factor (dB)	Total PPSD/MHz (dBm)	Required Limit (dBm)	Result
5210	VHT0	5210	-7.54	0.71	-6.83	<17	Pass

Note: Total PPSD/MHz = PPSD/MHz + Duty factor.

Channel No.	Frequency (MHz)	Data Rate	PPSD (dBm)	Duty factor (dB)	Total PPSD (dBm)	Required Limit (dBm)	Result
155	5775	VHT0	-5.13	0.71	-4.42	<30	Pass

Note: Total PPSD = PPSD + Duty factor.

Channel 42

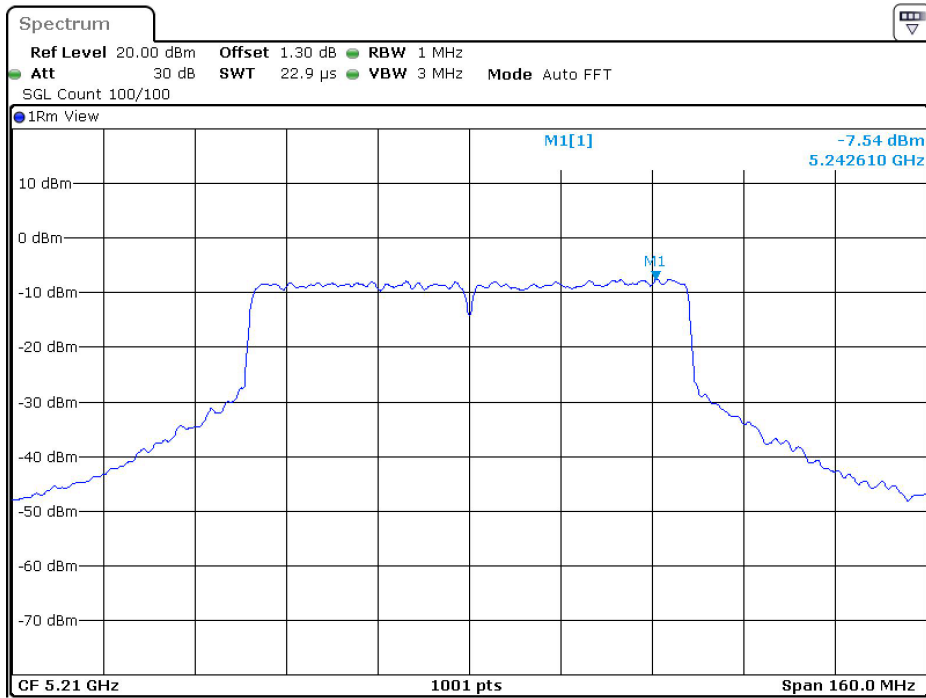

Date: 12.SEP.2023 17:48:14

Channel 155

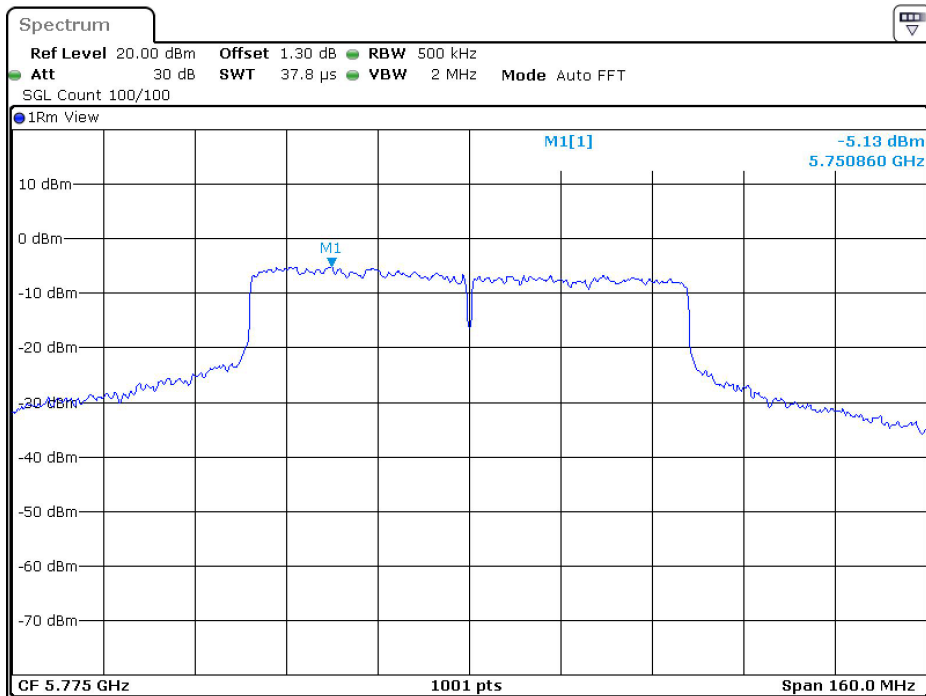

Date: 12.SEP.2023 17:49:18

5. Radiated Emission

5.1. Test Setup

Radiated Emission Under 30 MHz

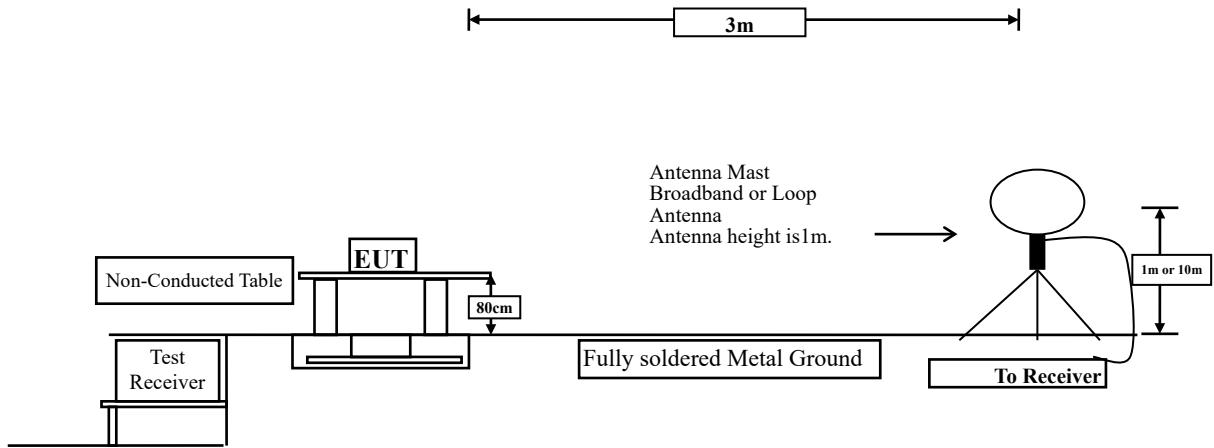

Radiated Emission Below 1 GHz

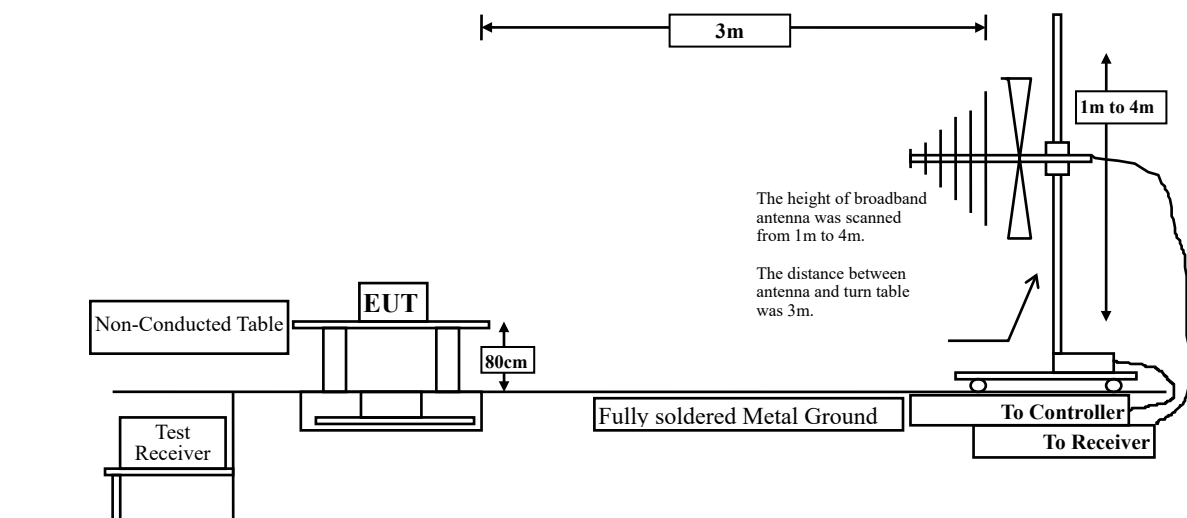

Radiated Emission Above 1 GHz

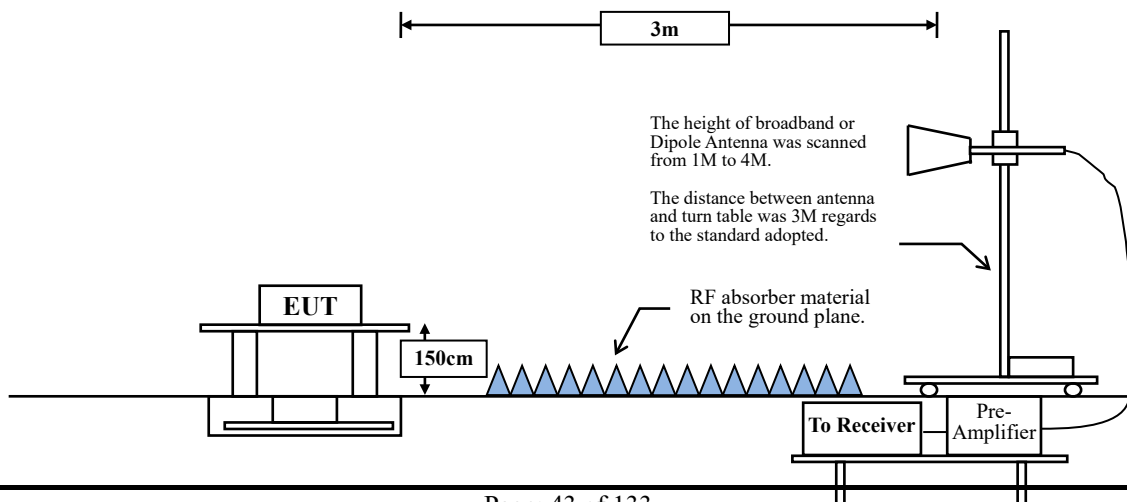

5.2. Limits

Emissions radiated outside of the specified frequency bands, except for harmonics, shall be attenuated by at least 20dB below the level of the fundamental or to the general radiated emission limits in paragraph 15.209, whichever is the lesser attenuation.

FCC Part 15 Subpart C Paragraph 15.209(a) Limits		
Frequency MHz	Field strength (microvolts/meter)	Measurement distance (meter)
0.009-0.490	2400/F(kHz)	300
0.490-1.705	24000/F(kHz)	30
1.705-30	30	30
30-88	100	3
88-216	150	3
216-960	200	3
Above 960	500	3

Remarks: E field strength (dB μ V/m) = 20 log E field strength (μ V/m)

- For transmitters operating in the 5.15-5.25 GHz band: All emissions outside of the 5.15-5.35 GHz band shall not exceed an e.i.r.p. of -27 dBm/MHz.
- For transmitters operating in the 5.25-5.35 GHz band: All emissions outside of the 5.15-5.35 GHz band shall not exceed an e.i.r.p. of -27 dBm/MHz.
- For transmitters operating in the 5.47-5.725 GHz band: All emissions outside of the 5.47-5.725 GHz band shall not exceed an e.i.r.p. of -27 dBm/MHz.
- For transmitters operating in the 5.725-5.85 GHz band:
All emissions shall be limited to a level of -27 dBm/MHz at 75 MHz or more above or below the band edge increasing linearly to 10 dBm/MHz at 25 MHz above or below the band edge, and from 25 MHz above or below the band edge increasing linearly to a level of 15.6 dBm/MHz at 5 MHz above or below the band edge, and from 5 MHz above or below the band edge increasing linearly to a level of 27 dBm/MHz at the band edge.
- For transmitters operating within the 5.925-7.125 GHz band: Any emissions outside of the 5.925-7.125 GHz band must not exceed an e.i.r.p. of -27 dBm/MHz.

Based on ANSI C63.10-2013 Section 12.7.3 d) provides the conversion formula between field strength and EIRP, if distance is 3m, -27dBm is equivalent to 68.22dBuV/m.

5.3. Test Procedure

The EUT was setup according to ANSI C63.10, 2013 and tested according to FCC KDB-789033 test procedure for compliance to FCC 47CFR 15. 407 requirements.

Measuring the frequency range below 1 GHz, the EUT is placed on a turn table which is 0.8 meter above ground, when measuring the frequency range above 1 GHz, the EUT is placed on a turn table which is 1.5 meter above ground.

The turn table is rotated 360 degrees to determine the position of the maximum emission level.

The EUT was positioned such that the distance from antenna to the EUT was 3 meters.

The antenna is scanned between 1 meter and 4 meters to find out the maximum emission level. This is repeated for both horizontal and vertical polarization of the antenna. In order to find the maximum emission, all of the interface cables were manipulated according to ANSI C63.10: 2013 on radiated measurement.

The resolution bandwidth below 30 MHz setting on the field strength meter is 9kHz and 30 MHz~1 GHz is 120 kHz and above 1 GHz is 1 MHz.

Radiated emission measurements below 30 MHz are made using Loop Antenna and 30 MHz~1 GHz are made using broadband Bilog antenna and above 1 GHz are made using Horn Antennas.

The measurement is divided into the Preliminary Measurement and the Final Measurement.

The suspected frequencies are searched for in Preliminary Measurement with the measurement antenna kept pointed at the source of the emission both in azimuth and elevation, with the polarization of the antenna oriented for maximum response. The antenna is pointed at an angle towards the source of the emission, and the EUT is rotated in both height and polarization to maximize the measured emission. The emission is kept within the illumination area of the 3 dB bandwidth of the antenna.

The measurement frequency range from 9 kHz - 10th Harmonic of fundamental was investigated.

RBW and VBW Parameter setting:

According to KDB 789033 section II.G.5 Procedure for Unwanted Maximum Emissions Measurements above 1000 MHz.

RBW = 1 MHz.

VBW \geq 3 MHz.

According to KDB 789033 section II.G.6 Procedures for Average Unwanted Emissions Measurements above 1000 MHz.

RBW = 1 MHz.

VBW = 10 Hz, when duty cycle \geq 98 %

VBW \geq 1/T, when duty cycle < 98 %

(T refers to the minimum transmission duration over which the transmitter is on and is transmitting at its maximum power control level for the tested mode of operation.)

Radio-2

5 GHz band	Duty Cycle (%)	T (ms)	1/T (Hz)	VBW (Hz)
802.11a	91.43	1.4400	694	1000
802.11ax-20 MHz	95.04	5.4600	183	200
802.11ax-40 MHz	95.54	5.4600	183	200
802.11ax-80 MHz	93.79	5.4400	184	200

Note: Duty Cycle Refer to Section 8.

Radio-3

5 GHz band	Duty Cycle (%)	T (ms)	1/T (Hz)	VBW (Hz)
802.11a	96.44	4.0600	246	300
802.11ac-20 MHz	96.19	3.7900	264	300
802.11ac-40 MHz	92.35	1.8700	535	1000
802.11ac-80 MHz	84.92	0.9120	1096	2000

Note: Duty Cycle Refer to Section 8.

5.4. Test Result of Radiated Emission

Radio-2



