



# iridium

## 9555 Handset User's Manual



**web:** [www.iridium.com](http://www.iridium.com)

**email:** [Info@iridium.com](mailto:Info@iridium.com)

**toll free:** +1.866.947.4348

**phone:** +1.480.752.5155

i





# Contents

<b>1   Introduction</b> .....	<b>1.1</b>
<b>2   Safety</b> .....	<b>2.1</b>
Exposure to Radio Frequency Signals ...	2.1
Specific Absorption Rate Data .....	2.2
Antenna Care .....	2.3
Phone Operation .....	2.3
Batteries .....	2.4
Driving .....	2.4
Electronic Devices .....	2.5
Aircraft .....	2.6
Blasting Areas .....	2.6
Potentially Explosive Atmospheres ....	2.7
For Vehicles Equipped with an Air Bag .	2.7
<b>3   Overview</b> .....	<b>3.1</b>
Guide Overview .....	3.1
Phone Overview .....	3.2
Indicators .....	3.5
Accessories .....	3.7
<b>4   Getting Started</b> .....	<b>4.1</b>
Using the SIM Card .....	4.1
SIM Card Care .....	4.1
Insert the SIM Card .....	4.2
Remove the SIM Card .....	4.2
Battery Pack Information .....	4.3
Remove and Install the Battery Pack ...	4.4
Charging the Battery .....	4.6
Checking Battery Charge Level .....	4.7
Start-up Procedure .....	4.7
Power-on Messages .....	4.8
Placing a Call .....	4.10





Receiving a Call ..... 4.14  
 Muting a Call ..... 4.20  
 Speaker Phone ..... 4.20  
 Speaker Volume ..... 4.21  
 Ringer Volume ..... 4.22  
 Unanswered Calls ..... 4.23  
 Locking and Unlocking the Keypad ..... 4.23

**5 | Using Menus and Keys ..... 5.1**

Using the Keys ..... 5.1  
 Using the Menus ..... 5.2  
 Entering Characters ..... 5.4

**6 | Using the Phonebooks ..... 6.1**

Organizing Your Phonebook ..... 6.1  
 Locating My Phonebook ..... 6.2  
 About the Phonebook Menu ..... 6.2  
 Add a New Entry ..... 6.3  
 Locating Entries ..... 6.6  
 Calling an Entry ..... 6.7  
 Using the Short Message  
 Service (SMS) Menu ..... 6.8  
 Edit an Entry in My Phonebook ..... 6.12  
 Delete an Entry ..... 6.14  
 Viewing Memory Status ..... 6.16  
 Adding Notes to a  
 Phonebook Entry ..... 6.17  
 Restricting Phonebook ..... 6.18





## **7 | Using the Messages Menu . . . . . 7.1**

Locating the Messages Menu . . . . . 7.1

About the Messages Menu . . . . . 7.1

    Create and Send a New

    Email Message to an address

    not in your phonebook . . . . . 7.2

    Creat and Send a New Email

    Message to an Address in

    My Phonebook . . . . . 7.4

About SMS Messaging . . . . . 7.8

Using the Inbox Menu . . . . . 7.9

    Read a Message . . . . . 7.9

    Reply to Sender . . . . . 7.10

    Forward a Received Message . . . . . 7.11

    Call a Number From a

    Received Message . . . . . 7.14

    Save a Number from a

    Received Message . . . . . 7.14

    Delete a Message . . . . . 7.15

Using the Drafts Menu . . . . . 7.17

Using the Settings Menu . . . . . 7.20

    Enter Service Center Number . . . . . 7.20

    Set Expiry Period . . . . . 7.21

    Select Delivery Reports . . . . . 7.22

## **8 | Using the Voicemail Menu . . . . . 8.1**

Locating the Voicemail Menu . . . . . 8.1

About the Voicemail Menu . . . . . 8.1

Voicemail Notification . . . . . 8.2

Check Your Voicemail . . . . . 8.2

Store Your Voicemail Number . . . . . 8.4

## **9 | Using the Data Modem Menu . . . . . 9.1**

Locating the Data Modem Menu . . . . . 9.1





<b>10   Using the Call History Menu.....</b>	<b>10.1</b>
Locating the Call History Menu.....	10.1
About the Call History Menu.....	10.1
Using the Call Log Menu.....	10.2
View Most Recent Received Calls ..	10.2
View Missed Calls .....	10.3
View Most Recent Dialed Calls ....	10.4
Using the Call Meters Menu.....	10.6
Show the Time of Last Call .....	10.6
Show Total Time for All Calls .....	10.7
Reset all Timers .....	10.8
Showing the Lifetime Call Timer ...	10.10
Showing the In-call Display .....	10.12
Setting Audible Call Timers.....	10.13
Set the Single Alert Timer .....	10.13
Set the Repetitive Timer.....	10.15



<b>11   Using the Setup Menu .....</b>	<b>11.1</b>
Locating the Setup Menu.....	11.1
About the Setup Menu .....	11.2
Setting Call Options.....	11.3
The Call Options menu .....	11.3
Setting Volumes and Tones.....	11.4
Adjust the Ringer Volume .....	11.4
Adjust the Speaker Volume .....	11.5
Adjust the Ring Tone.....	11.7
Setting the Call Alert Mode .....	11.9
Setting the Keypad Tone.....	11.10
Set the Phone to Ring and /or Vibrate.....	11.12
Time and Date Settings .....	11.13
Select the Time Zone .....	11.13
Select the Time Format .....	11.14





- Select the Date Format ..... 11.16
- Selecting the Display Language ..... 11.17
- Setting Backlights ..... 11.18
- Setting Contrast ..... 11.19
- Using the Key Setup Menu ..... 11.20
  - Setup the Convenience Key ..... 11.20
  - Setup the Right Soft Key ..... 11.21
  - Set Number Entry Prefix ..... 11.22
  - View Phone Information ..... 11.23
  - Reset Phone Options to  
Factory Defaults ..... 11.25
- 12 | Using the Security Menu ..... 12.1**
  - Locating the Security Menu ..... 12.1
  - About the Security menu ..... 12.2
  - Locking and Unlocking Your Phone ... 12.2
    - Enable or Disable the SIM lock ... 12.3
  - Using the Change PIN Menu ..... 12.5
    - Change the Phone PIN Code ..... 12.5
    - Change the SIM PIN Code ..... 12.7
    - Change the SIM Card Pin2 Code 12.9
    - Call Barring PIN ..... 12.11
- 13 | Troubleshooting ..... 13.1**
- 14 | Patent Information ..... 14.1**
- 15 | Declaration of Conformity ..... 15.1**





# 1 | Introduction

**Thank you** for purchasing the state of the art Iridium 9555 Handset. Iridium is the only provider of truly global satellite voice and data communications solutions with complete coverage of the entire earth including oceans, airways and even polar regions. The Iridium 9555 handset delivers reliable, secure, real-time, simultaneous high quality voice and data to the Iridium satellite network from any point on the globe.

The information presented in this document is intended to form the basis of the 9555 Handset User Guide. The information given describes the procedures for operation of the handset and the facilities available









## 2 | Safety

**Important:** Read this information before using your satellite phone.

### Exposure to Radio Frequency Signals

Your satellite telephone is a low power radio transmitter and receiver. When it is ON, it receives and also sends out radio frequency (RF) signals. Operation is subject to the following two conditions: (1) this device may not cause interference, and (2) this device must accept any interference, including interference that may cause undesired operation of the device.

International agencies have set standards and recommendations for the protection of public exposure to RF electromagnetic energy.

- International Commission on Non-Ionizing Radiation Protection (ICNIRP)
- Verband Deutscher Elektrotechniker (VDE)
- United States Federal Commission, Radio Frequency Exposure Guidelines
- National Radiological Protection Board of the United Kingdom
- American National Standards Institute (ANSI) IEEE. C95. 1-1992
- National Council on Radiation Protection and Measurements (NCRP). Report 86
- Department of Health and Welfare Canada. Safety Code 6

These updated ANSI standards are based on an extensive scientific review of the available body of research by over 120 scientists, engineers, and physicians from universities, government





health agencies and related industries. The design of your phone complies with these standards when used as described under Phone Operation on page 2.3.

This product is compliant with Industry Canada RSS-102 for RF Exposure.

## Specific Absorption Rate Data

### **This model phone meets international standards for exposure to radio waves.**

Your satellite phone is a radio transmitter and receiver. It is designed and manufactured not to exceed limits for exposure to radio frequency (RF) energy. These limits are part of comprehensive guidelines and established permitted levels of RF energy for the general population. The guidelines are based on standards that we developed by independent scientific organizations through periodic and thorough evaluation of scientific studies. The guidelines include a substantial safety margin designed to assure the safety of all persons, regardless of age and health.

The exposure standard for mobile phones employs a unit of measurement known as the Specific Absorption Rate, or SAR. Under the guidelines for this model, the SAR limit is 1.6 W/kg. \*Tests for SAR were conducted in accordance with CENELEC and FCC testing procedures using standard operating positions with the phone transmitting at its highest certified power level in all tested frequency bands. Although the SAR is determined at the highest certified power level, the actual SAR of the phone while operating can be below the maximum value. Before a phone model is available for sale to the public, it is tested to confirm compliance with the guidelines. The tests are performed





## Iridium 9555 Handset | 2 Safety

in positions and locations (e.g., at the ear and worn on the body) that conform to a uniform testing methodology determined by an expert standards body. The highest SAR level recorded from this product was 0.869 mW/g for a 1g cube which was below the uncontrolled (i.e. general population) limit. While there may be differences between the SAR levels of various phones and at various positions, they all meet the governmental requirements for safe exposure. PLEASE NOTE THAT MODIFICATIONS TO THIS PRODUCT MODEL COULD CAUSE DIFFERENCES IN THE SAR VALUE FOR LATER PRODUCTS; IN ALL CASES, PRODUCTS ARE DESIGNED TO BE WITHIN THE GUIDELINES.

### Antenna Care

Use only the supplied or an approved replacement antenna. Unauthorized antennas, modifications, or attachments could damage the phone and may violate government regulations. When using remote mount antenna, mount antenna at least 20 cm away from the user. Also when using a remote mount antenna in order to reduce potential radio interference to other users, the antenna type and its gain should be so chosen such that the equivalent isotropically radiated power (e.i.r.p.) is not more than that permitted for successful communication.

### Phone Operation

#### **Normal Operation**

Hold the phone as you would any other telephone. Fully extend the antenna then rotate the antenna to either the left or right detent. The antenna should be vertical to the ground and have a clear unobstructed view of the sky.



### Tips on Efficient Operation

For your phone to operate most efficiently:

- Fully extend your antenna then rotate into position.
- Make sure the antenna has a clear unobstructed view of the sky.
- Do not touch the antenna unnecessarily when the phone is in use.
- Contact with the antenna affects call quality and may cause the phone to operate at a higher power level than otherwise needed.
- Do not wear the phone on your body while making calls with the headset accessory. Wearing the phone on the body can interfere with proper phone operation, since the antenna requires a clear unobstructed view of the sky to access the Iridium® satellite network.

## Batteries

### **WARNING!**



All batteries can cause property damage, injury or burns if a conductive material, such as jewelry, keys or beaded chains, touches exposed terminals. The material may complete an electrical circuit and become quite hot. To protect against such unwanted current drain, exercise care in handling any charged battery, particularly when placing it inside your pocket, purse or other container with metal objects.



Risk of explosion if battery is replaced by an incorrect type. Dispose of used batteries according to instructions on page 4.5.



**Driving** Check the laws and regulations on the use of wireless telephones in the areas where you drive. Always obey them. Many local governments prohibit the use of mobile telephones while driving. Observe the following guidelines when using your phone while driving.

- Give full attention to driving—driving safely is your first responsibility.
- Use hands-free phone operation, if available.
- Pull off the road and park safely before making or answering a call.

**Electronic Devices** Most modern electronic equipment is shielded from RF signals. However, certain equipment may not be shielded against the RF signals from your wireless phone.

#### **Pacemakers**

The Health Industry Manufacturers Association recommends that a minimum separation of six inches (6") be maintained between a handheld wireless phone and a pacemaker to avoid potential interference with the pacemaker. These recommendations are consistent with the independent research by and recommendations of Wireless Technology Research.

Persons with pacemakers:

- Should ALWAYS keep the phone more than six inches from their pacemaker when the phone is turned ON
- Should not carry the phone in a breast pocket
- Should use the ear opposite the pacemaker to minimize the potential for interference
- Should turn the phone OFF immediately if you have any reason to suspect that interference is taking place





### **Hearing Aids**

Some digital wireless phones may interfere with some hearing aids. In the event of such interference, you may want to consult your hearing aid manufacturer to discuss alternatives.

### **Other Medical Devices**

If you use any other personal medical device, consult the manufacturer of your device to determine if it is adequately shielded from external RF energy. Consult your physician to determine compatibility with your medical device.

Turn your phone OFF in health care facilities when any regulations posted in these areas instruct you to do so. Hospitals or health care facilities may be using equipment that could be sensitive to external RF energy.

### **Vehicles**

RF signals may affect improperly installed or inadequately shielded electronic systems in motor vehicles. Check with the manufacturer or its representative regarding your vehicle. You should also consult the manufacturer of any equipment that has been added to your vehicle.

### **Posted Facilities**

Turn your phone OFF in any facility where posted notices so require.

**Aircraft** Airline regulations prohibit using your phone while in the air. Check and comply with the policy of your airline regarding the use of your phone while the aircraft is on the ground.

Switch OFF your phone before boarding an aircraft.





## Blasting Areas

To avoid interfering with blasting operations, turn your phone OFF when in a “blasting area” or in areas posted: “Turn off two-way radio.” Obey all signs and instructions.

## Potentially Explosive Atmospheres

Turn your phone OFF and do not remove your battery when you are in any area with a potentially explosive atmosphere. Obey all signs and instructions. Sparks from your battery in such areas could cause an explosion or fire resulting in bodily injury or even death.

Areas with a potentially explosive atmosphere are often but not always clearly marked. They include, but are not limited to: fueling areas such as gasoline stations; below deck on boats; fuel or chemical transfer or storage facilities; areas where fuel odors are present (for example, if a gas/propane leak occurs in a car or home); areas where the air contains chemicals or particles, such as grain, dust, or metal powders; and any other area where you normally would be advised to turn off your vehicle engine.

## For Vehicles Equipped with an Air Bag

An air bag inflates with great force. Do NOT place objects, including both installed or portable wireless equipment, in the area over the air bag or in the air bag deployment area. If in-vehicle wireless equipment is improperly installed, serious injury could result.









# 3 | Overview

## Guide Overview

This chapter provides a complete tour of the 9555 Handset. You will discover all the features and components that you need to operate your phone to its full potential.

For ease of use, the chapters in this manual are divided by menu options. Each section of the chapter is then divided by the same sub-menu options as your phone. Just follow the sequence of menus on your phone, the manual will follow along, making the startup process a simple one.



3.1





# Iridium 9555 Handset | 3 Overview

## Phone Front view Overview





## Iridium 9555 Handset | 3 Overview

### Side View

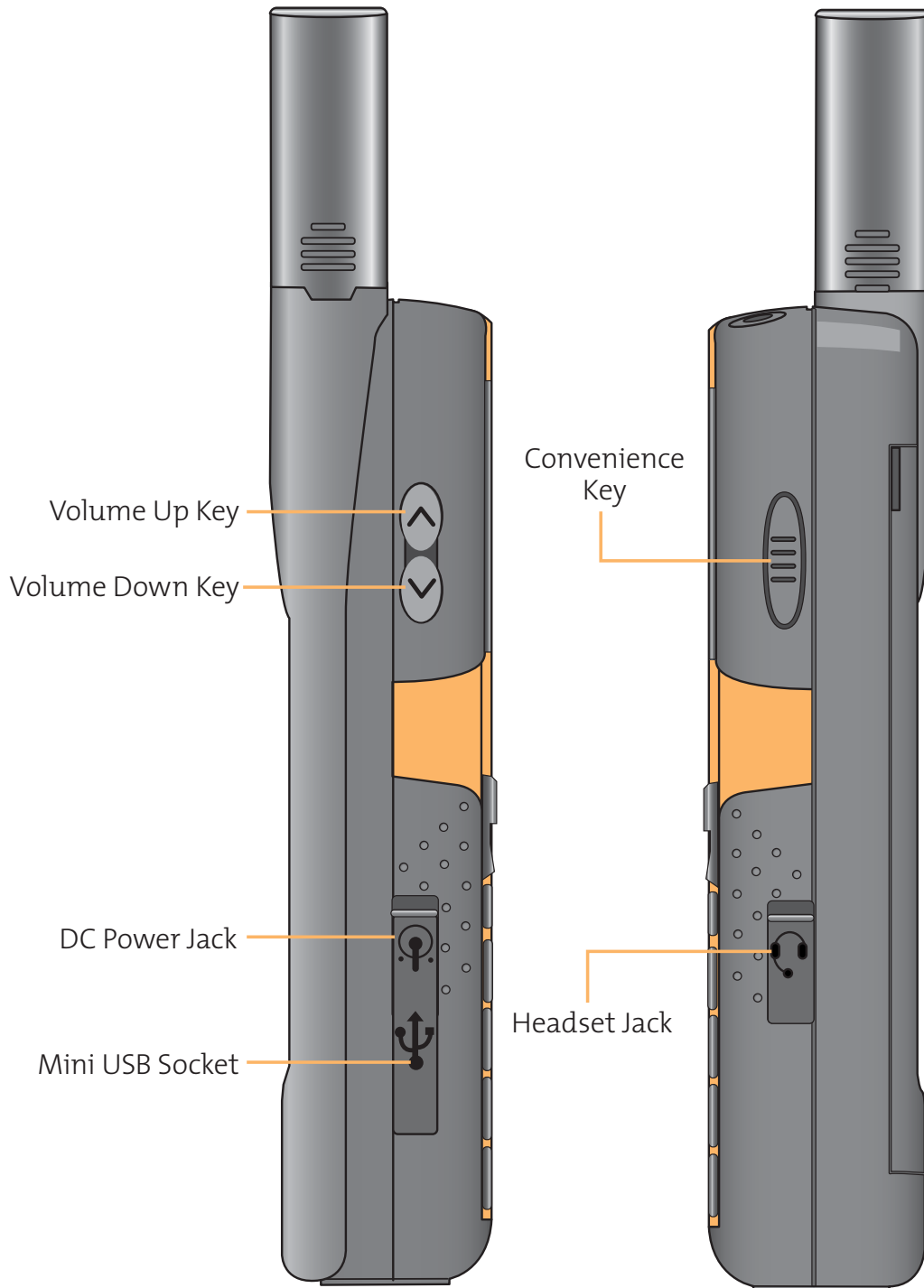



## Iridium 9555 Handset | 3 Overview

### Back View

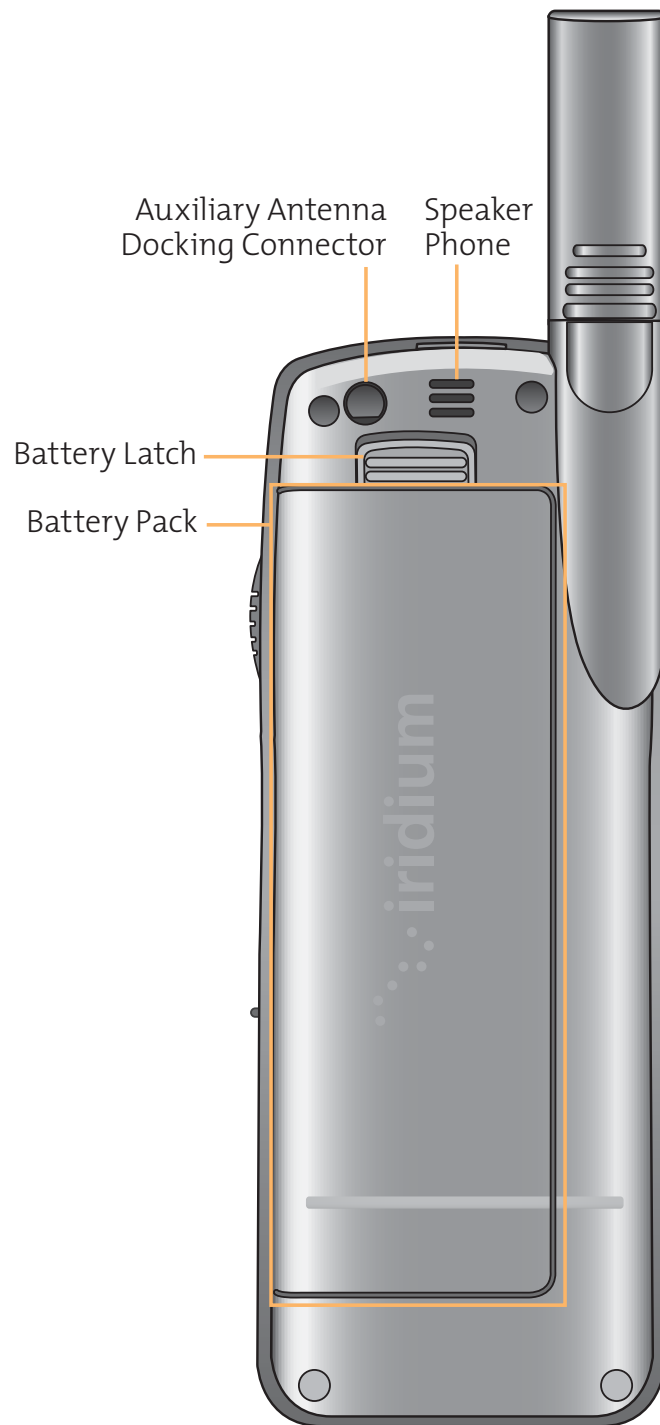



## Accessories AC Travel Charger and International Plug Kit

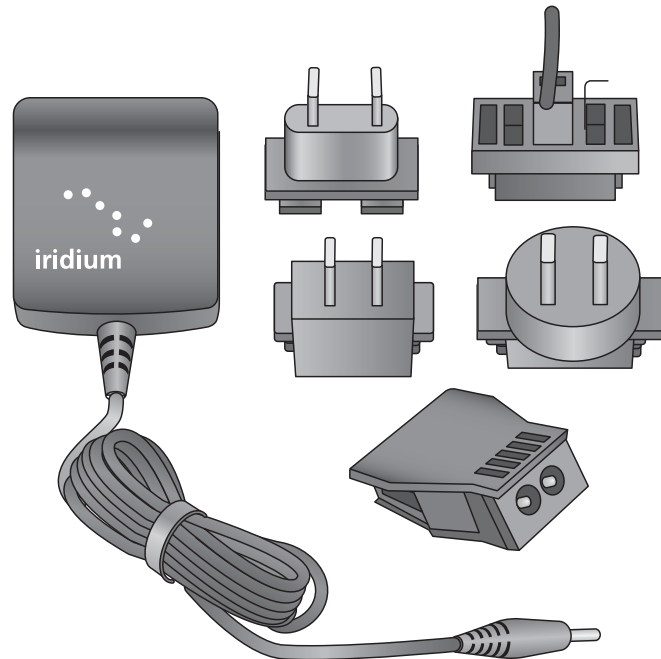

The AC Travel Charger and International Plug Kit provide rapid charge for optimal performance.

- Can be used to power the phone when the battery is depleted.
- The battery must be installed when using the charger to power the phone.
- Includes five international plug adapters for use around the world.
- Allows you to use the 9555 portable phone while recharging the battery. The battery should not be allowed to discharge fully.



## Iridium 9555 Handset | 3 Overview

### Headset

The convenient headset provides both an earphone and microphone in one small piece for simple hands-free and private telephone conversations. The headset plugs directly into the jack on the right side of your phone.

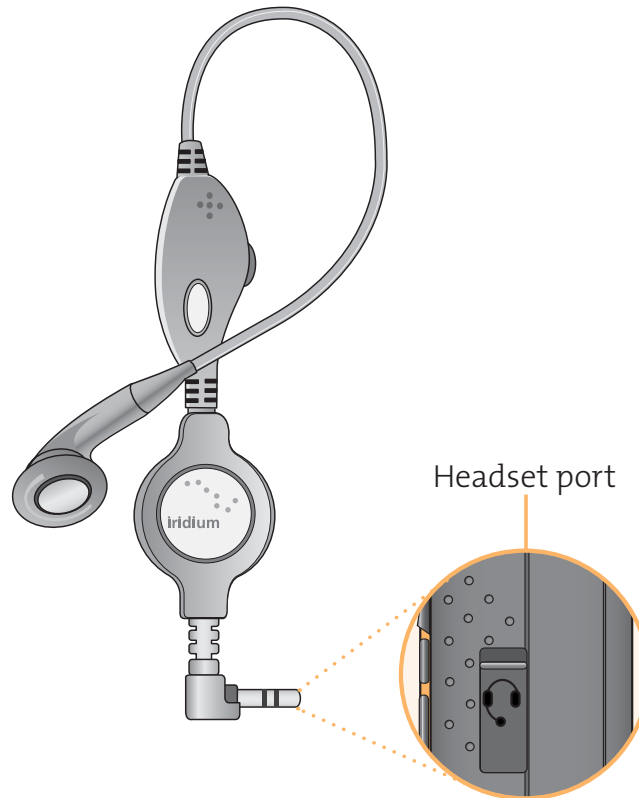

### Auto Accessory Adaptor

The AC Travel Charger and International Plug Kit provide rapid charge for optimal performance.

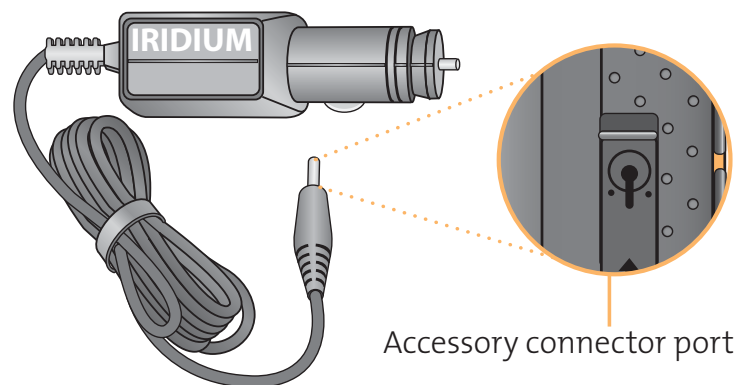



### To Install the Antenna Adaptor

**Note:** Your phone was shipped with a plug protector for the antenna connector, you must remove this prior to using the Antenna Adaptor.

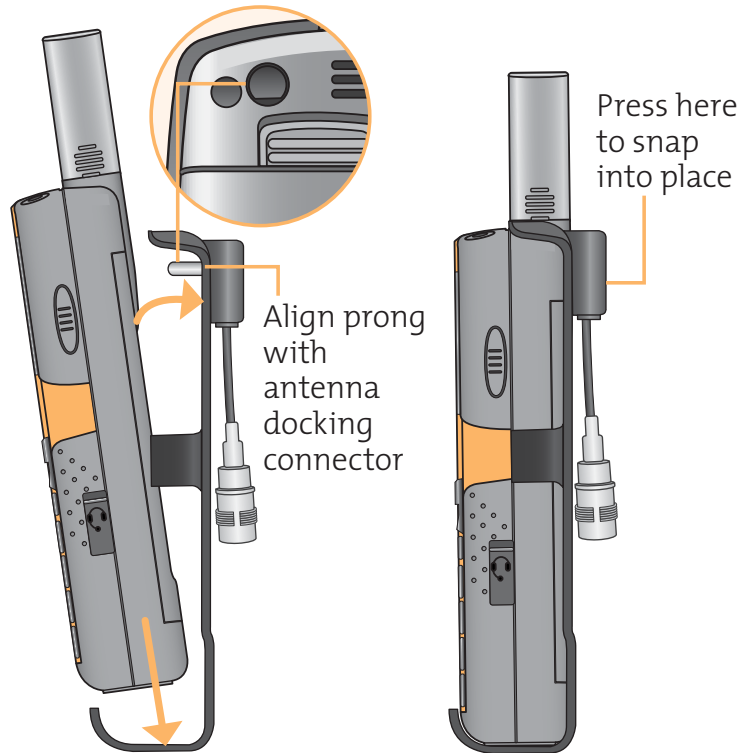

1. Slide the phone into the antenna adaptor.
2. Rotate until the back of the phone meets the adaptor.

### Auxiliary Antenna Adaptor

Allows you to easily attach the auxiliary antenna to the back of your Iridium 9555 handset. The auxiliary antenna allows for in-vehicle use of your Iridium handset.

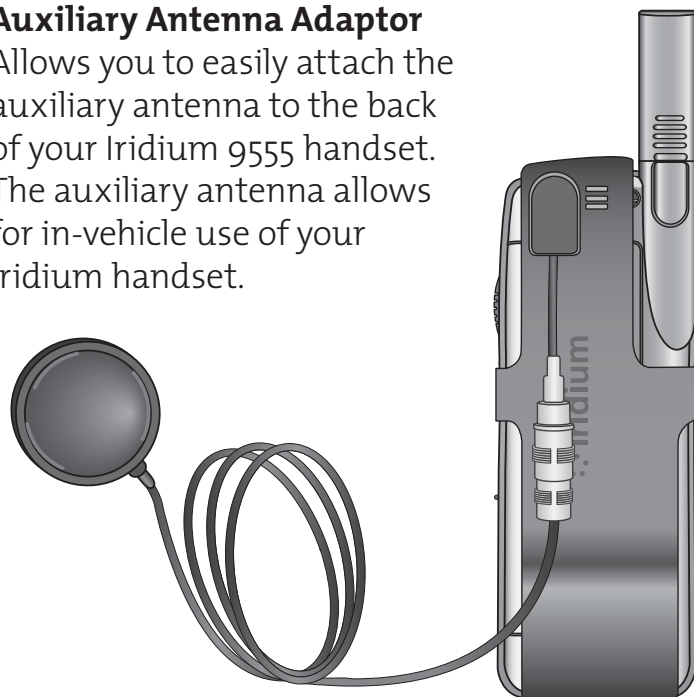

## Indicators

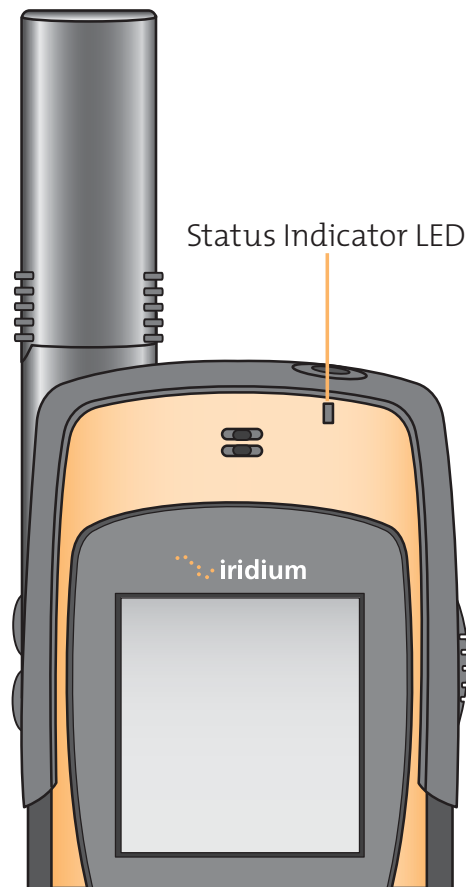

### Status Indicator LED

The status indicator at the top of the phone, has the following meanings:

LED is ...	Indicates
Alternating red and green	Call in progress; ringing, dialling or in call.
Flashing green	Network is available and SIM status okay. Phone is idle.
Flashing yellow	SIM problem; this signifies a problem with the SIM, such as; locked, missing or invalid.
Flashing red	No connection to network.



### Display Status Indicators and Icons

The following icons will appear in your display to provide you with various information about the phone's activity.

### Main Screen Components

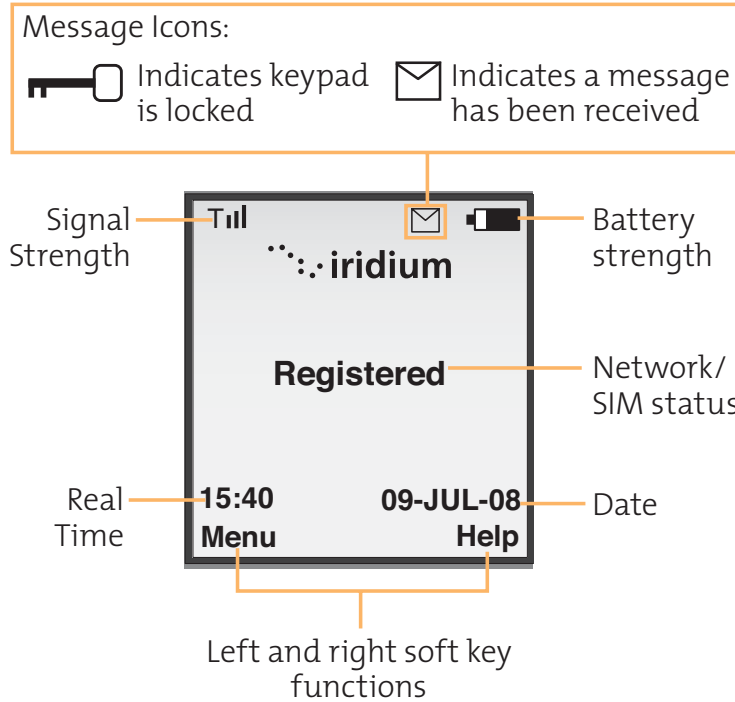

### Menu Components

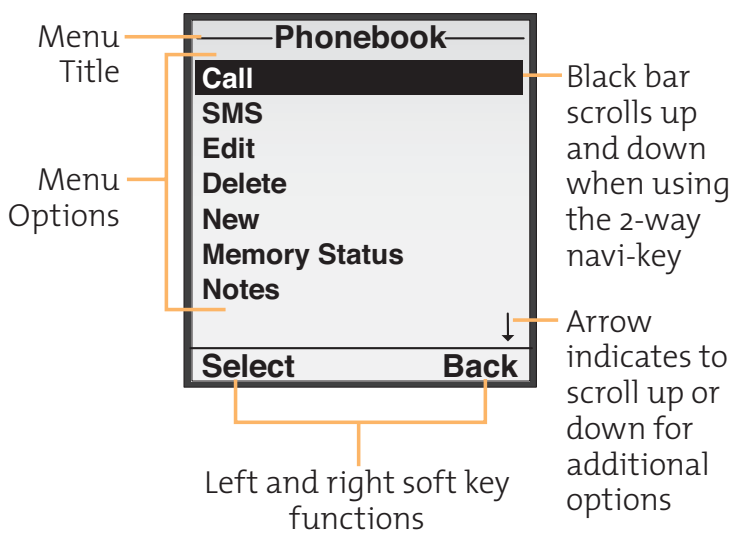





## 4 | Getting Started

### Using the SIM Card

You will receive a Subscriber Identity Module (SIM) card with your phone. The SIM card is a smart card that contains your service details and memory for storing phone book entries and messages.

Your phone has limited functionality without the SIM card, so you will want to install the card before using your phone.

#### SIM Card Care

You may want to keep your card with you when you are not using your phone. This helps keep your personal information secure and gives you access to your service even if your phone is not available.

**IMPORTANT:** Do not bend or scratch your SIM card, and avoid exposing your card to static electricity, water or dirt.

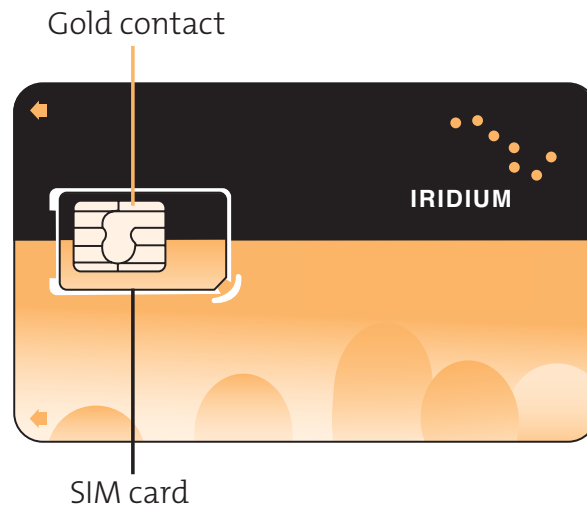

## Insert the SIM Card



1. Remove the SIM card from the larger card.

2. Remove the battery as shown on page 4.4.

3. Slide the SIM card into the SIM card slot. Follow the card orientation shown on the decal. Be sure the gold contact is facing down.

The card is held in place by a small retaining clip.

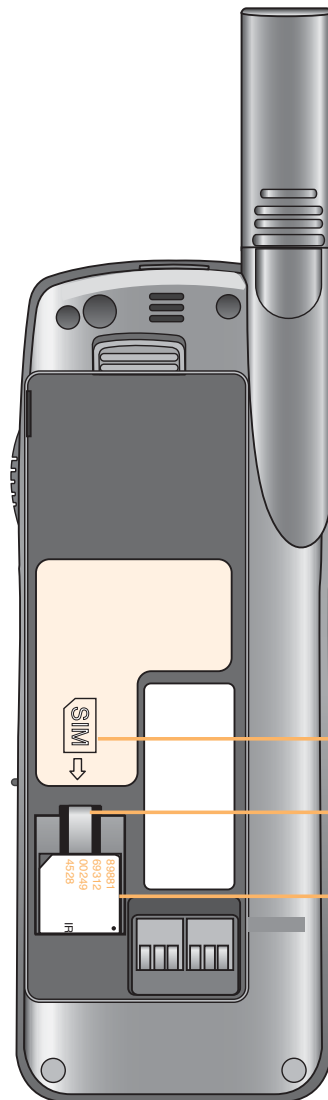

SIM Decal

Retaining Clip

SIM Card

## Remove the SIM Card

Press down on the retaining clip and slide the SIM card out of the slot.

## Battery Pack Information

### For Maximum Battery Life

#### **WARNING!**



To prevent injuries or burns, do not allow metal objects to contact or short circuit the battery terminals.

- Use Iridium approved battery chargers
- Use Iridium approved batteries
- Maintain the battery at or near room temperature when charging
- If the battery will not be used for a while, remove the battery from the phone and store in a cool, dark and dry place
- Battery life capacity is significantly reduced at extreme temperatures. Such as  $-10^{\circ}\text{C}$  ( $14^{\circ}\text{F}$ ) or above  $45^{\circ}\text{C}$  ( $113^{\circ}\text{F}$ )

### Disposing of Batteries

Check with your local recycling center for a battery recycler near you. Never dispose of batteries in fire.



## Iridium 9555 Handset | 4 Getting Started

### Remove and Install the Battery Pack

The back panel of the phone is the battery pack. You will need to remove the battery pack to insert the SIM card or replace the battery.

#### To Remove the Battery Pack:

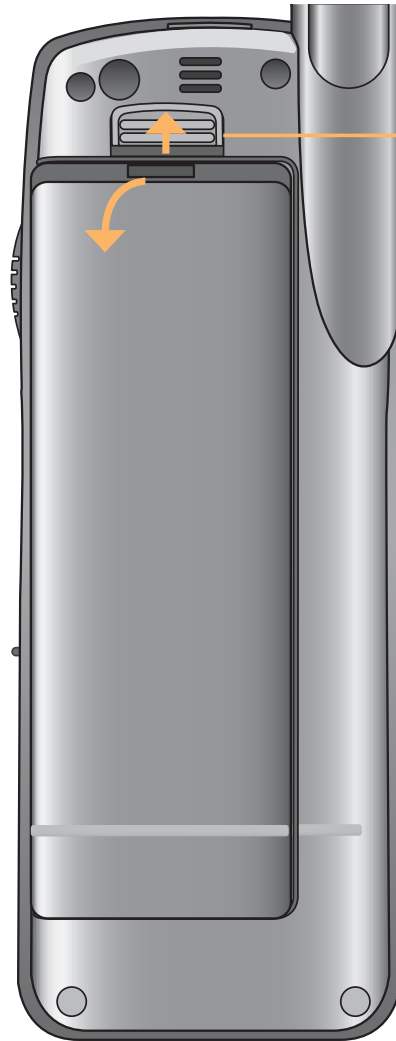

1. Push the battery latch up. The battery pack will release.
2. Lift the battery pack away from the phone.





### To Install the Battery Pack:

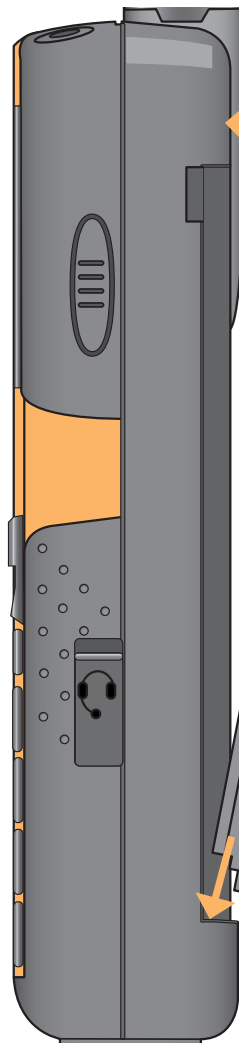

1. Align the battery pack pegs with the slots on the bottom of the battery compartment.
2. Rotate the top end of the battery pack into the handset. Press the battery until it is flush with the case.

**Note:** the battery should click into place and held securely by the battery latch.

Battery pack pegs



## Charging the Battery

Use the AC travel charger or auto accessory adapter to charge the 9555 Handset.

**Note:** The battery should only be charged in environments between 0°C(32°F) to 45°C(113°F).

### Charge the Battery Pack

1. Connect the travel charger or auto accessory adapter to the phone.

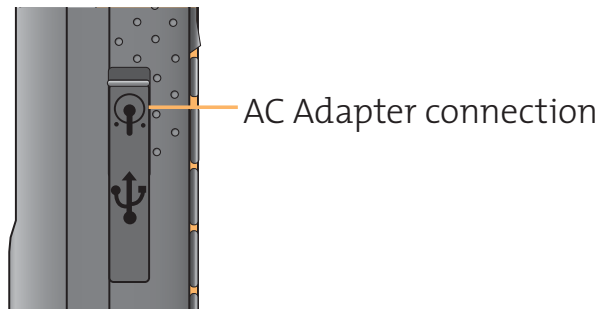

2. Plug the AC travel charger or auto accessory adapter into the appropriate power source. The phone will beep.
3. The battery symbol on the LCD display flashes.

**Note:** Calls can still be made or received while the battery is charging, however the battery will charge faster if the phone is turned off. When the handset is not in use the battery will take approximately 4 hours to fully charge.

You must wait a minimum of 5 seconds before powering on the handset after you have disconnected from the charger.





## Checking Battery Charge Level

### Low Battery Warning

When the battery is low and only a few minutes of talk time remains, your phone will indicate this in two ways:

1. The battery charge indicator appears continuously in the upper right hand corner of the display. When the battery charge is low the icon will appear empty, and **Low Battery** appears on the display,

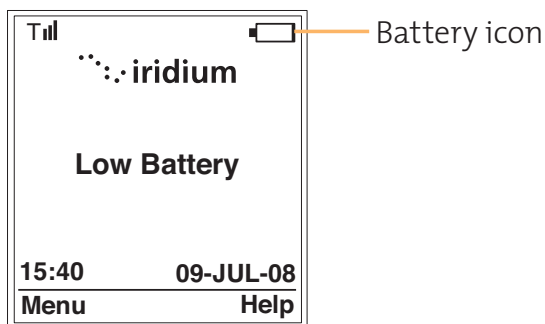

2. A warning tone (two double beeps) sounds.

**Note:** To help maintain the best battery and phone performance, recharge your battery as soon as possible after you receive the low battery warning.

## Start-up Procedure

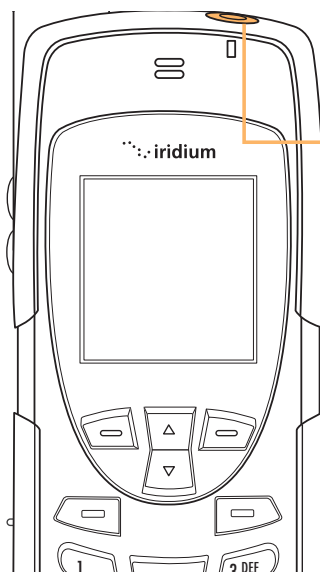

1. Insert your SIM card if necessary.

2. Turn the phone on by pressing and holding the **On/Off** button for 5 seconds.

When you turn your phone's power on, the display screen will go through a short animated sequence.





## Iridium 9555 Handset | 4 Getting Started

### Power-on Messages

Once your phone is on, one of the following messages may appear.

Message	Directive
Bad Card	See Supplier. Your SIM card has been damaged or incorrectly issued. Contact your service provider for information.
Check Card	The SIM card is damaged or inserted the wrong way.
Denied	Your phone has seen a network, but has been denied access.
SIM PIN	Enter the four- to eight-digit SIM card PIN code provided by your service provider and press OK to proceed. See Chapter 13, 'Using the Security Menu', for more information about your SIM.
Invalid Account	Contact your service provider.
Phone PIN	The phone has been locked. To unlock the phone, you must enter the correct Phone PIN number.
PIN Blocked	When the PIN number has been entered incorrectly three times in a row, the phone will automatically block the PIN. To unblock the pin, enter the PUK <sub>1</sub> code for the phone by entering <b>**05*</b> from the main screen.





## Iridium 9555 Handset | 4 Getting Started

Message	Directive
PIN 2 Blocked	<p>When the PIN2 number has been entered incorrectly three times in a row, the phone will automatically block the PIN.</p> <p>To unblock the PIN2 enter the PUK2 code for the phone by entering <b>**052*</b> from the main screen.</p>
Registered	Your phone is now registered with the network.
Searching for network...	<p>The phone is attempting to establish communications with the satellite network.</p> <p>This message appears while your phone searches for a network connection.</p>
SIM Error	There is an error with the SIM or no SIM is installed. Insert SIM card.



## Placing a Call

### Before you place a call

- The phone must be powered on
- SIM card inserted
- Phone is unlocked
- Have a clear direct view of the sky in order to be in contact with the network.
- Antenna should be extended and pointed up towards the sky

### Dial the Number

As you enter a phone number, the digits will be displayed on a single line that will scroll across the display.

1. Enter the number using the key pad. As you begin entering digits, you will see **Options** displayed above the **left** soft key and **Clear** displayed above the **right** soft key.

The phone number must be entered in international format: : oo or + [country code] [phone number].

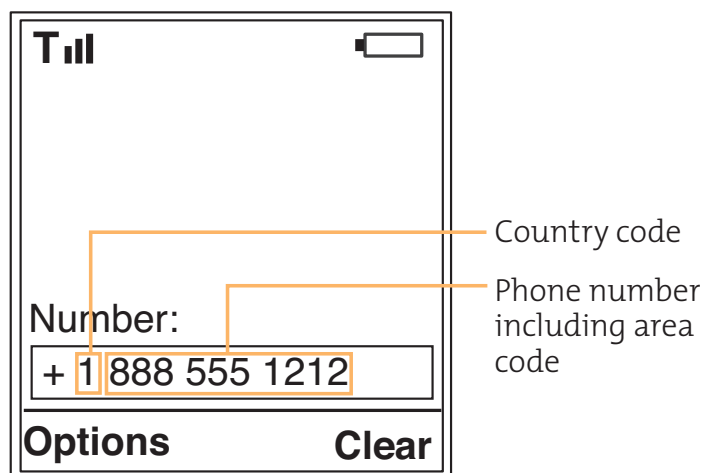

**Note:** All Iridium subscriber numbers begin with county code of **8816**.



## Iridium 955 Handset | 4 Getting Started

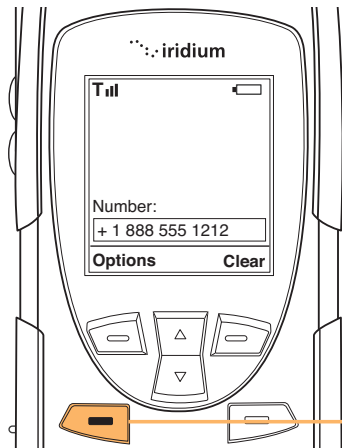

2. Press the **green** key.

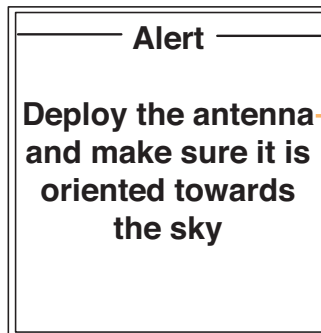

**Note:** You will receive this message when the antenna is not fully extended from the handset.

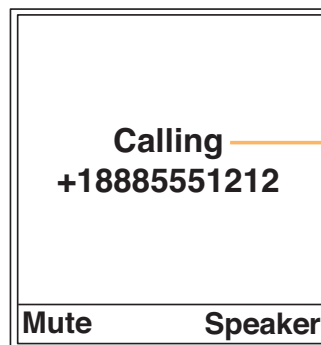

3. **Calling** followed by the number you dialed appears in the display.





## Iridium 955 Handset | 4 Getting Started

If the call does not connect, one of the following messages will appear.

Message	Directive
Busy Try Later <b>Or</b> Please Try Later	The phone is unable to access the network. Try again in a few minutes
Could not place call. No connection to the network	The phone is unable to access the network.
Restricted Area	The phone is unable to access the network. Move to an area where calls are allowed.

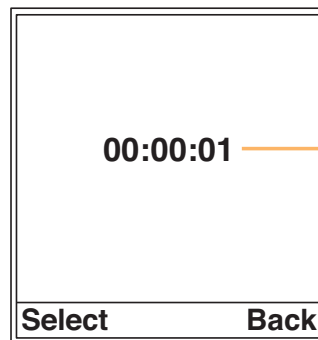

4. A timer will keep track of the duration of each call.

**Note:** If you have disabled the timer, **Connected** will display.





## Iridium 9555 Handset | 4 Getting Started

### End a Call

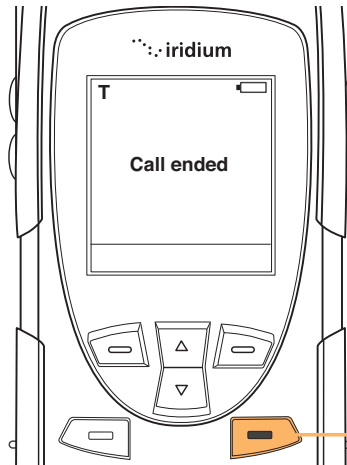

1. Press the **red** key.

### Re-dial Last Number Called

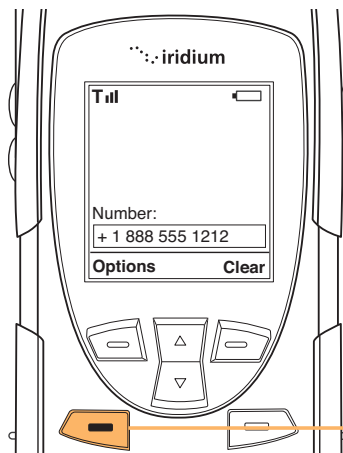

1. Press the **green** key twice.





## Receiving a Call

### Before you Receive a call:

- The phone must be powered on
- A valid SIM card must be inserted
- Phone is unlocked
- The phone must be connected with the network

There are two scenarios for receiving calls depending on the antenna position:

1. Antenna extended
2. Antenna stowed i.e. in the down position.

### Receiving a Call With the Antenna Extended

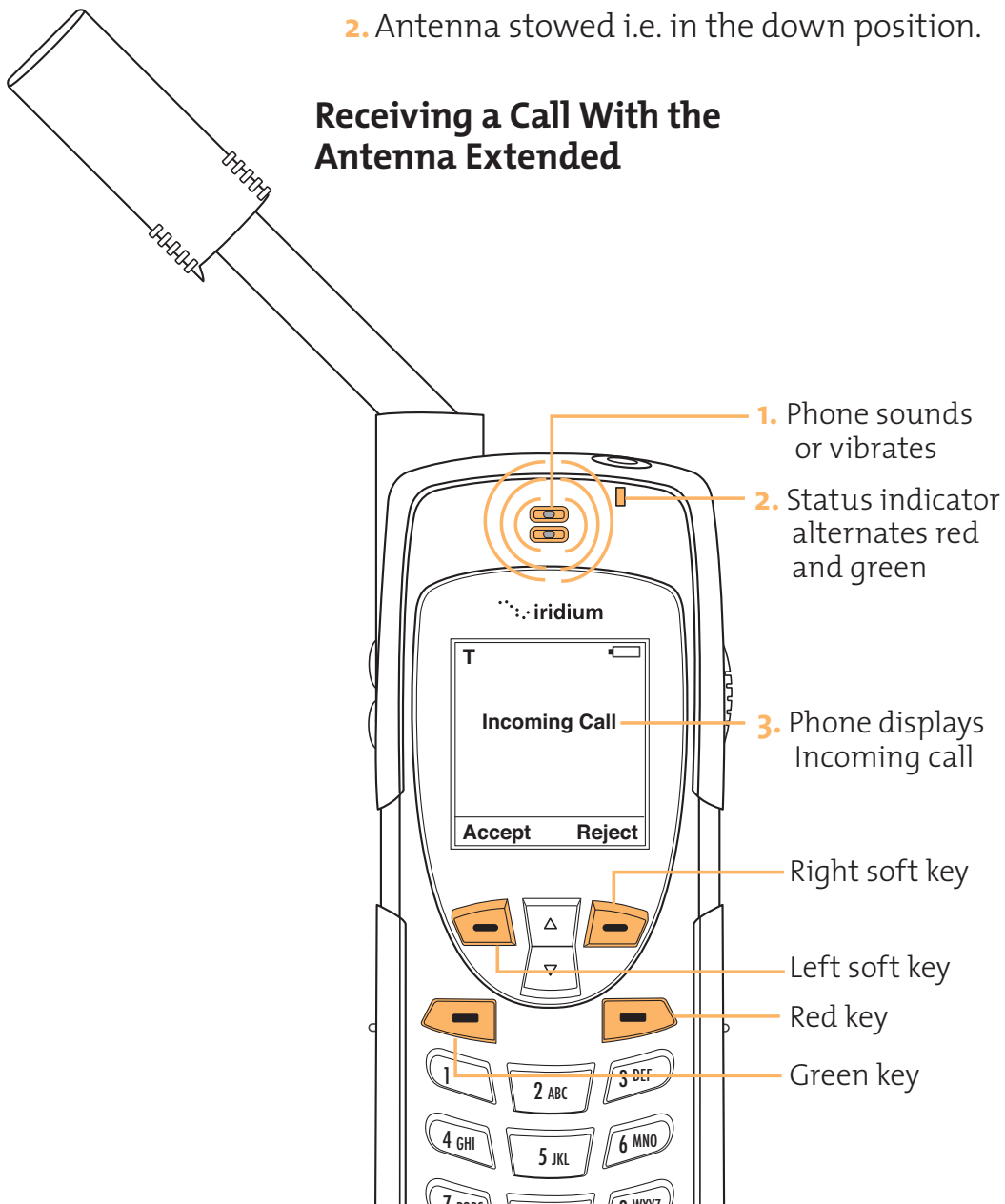





### Answering the Call With the Antenna Extended

1. Extend the antenna directly up prior to rotating left or right. When the antenna is fully extended you will see 2 lines at the base of the antenna.

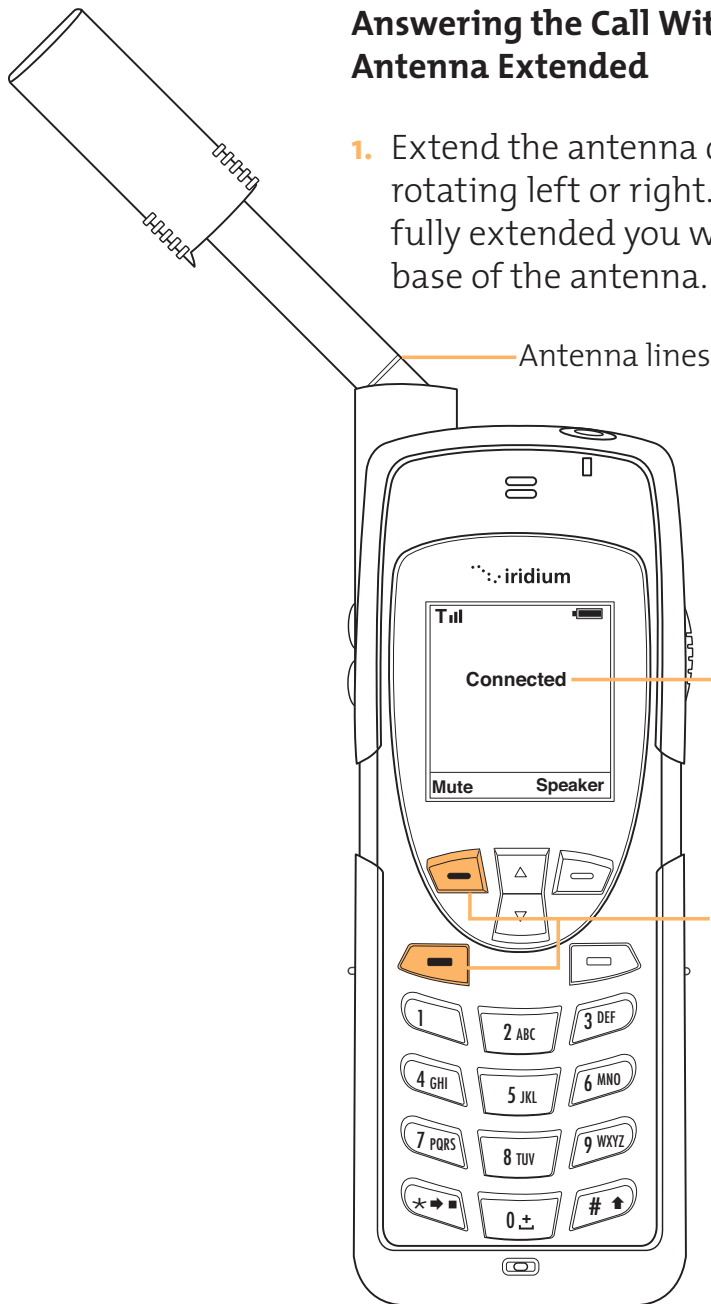

3. Phone displays **Connected**

2. Press the **left soft key** or the **green key**. **Mute** will be displayed above the left soft key and **speaker** will be displayed above the right soft key.

If the call does not connect properly, the following message will appear:

Message	Directive
Call Failed	The antenna is not properly positioned or the network signal is not strong enough.





## Receiving a Call With the Antenna Stowed

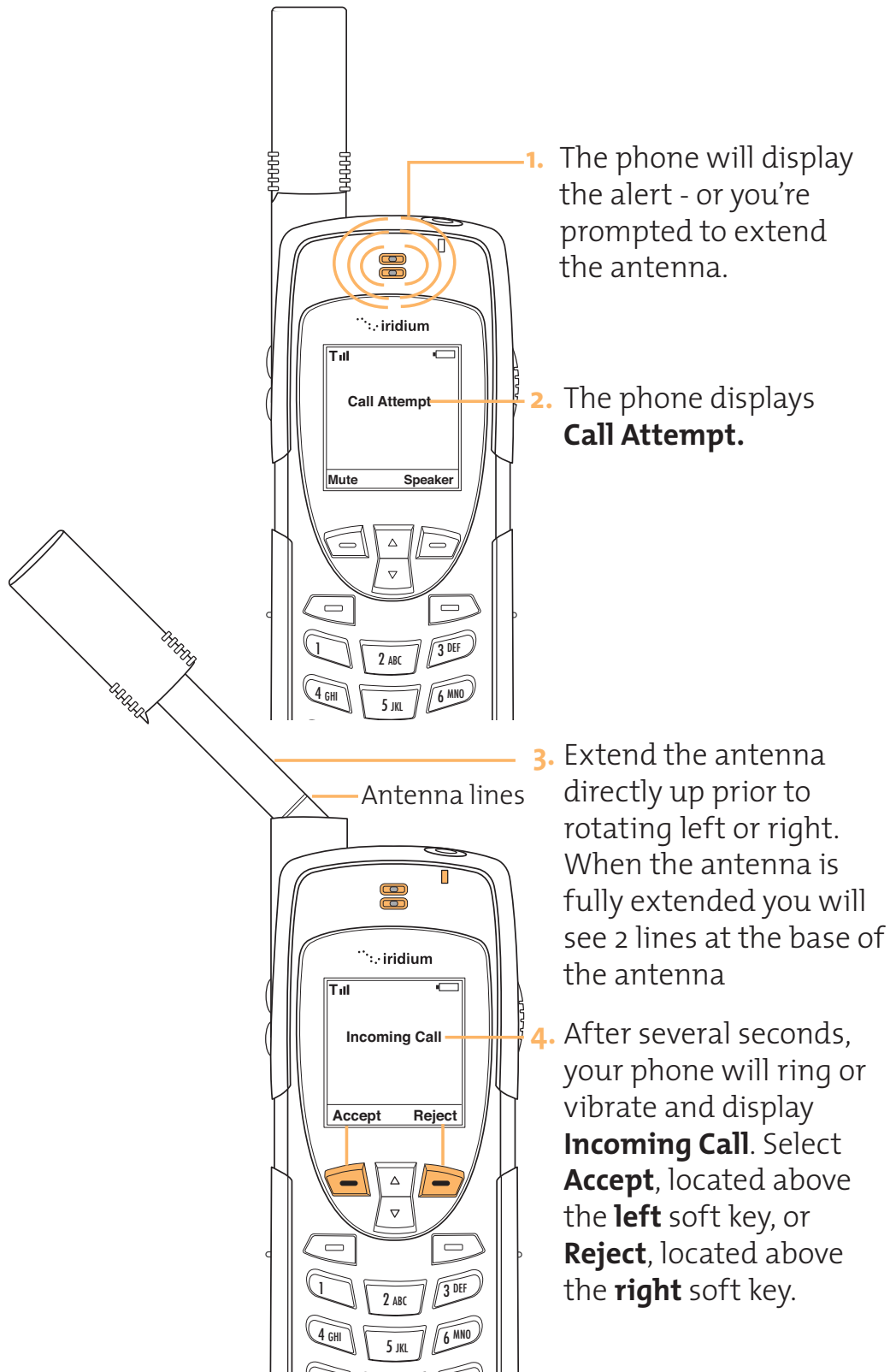



## Iridium 9555 Handset | 4 Getting Started

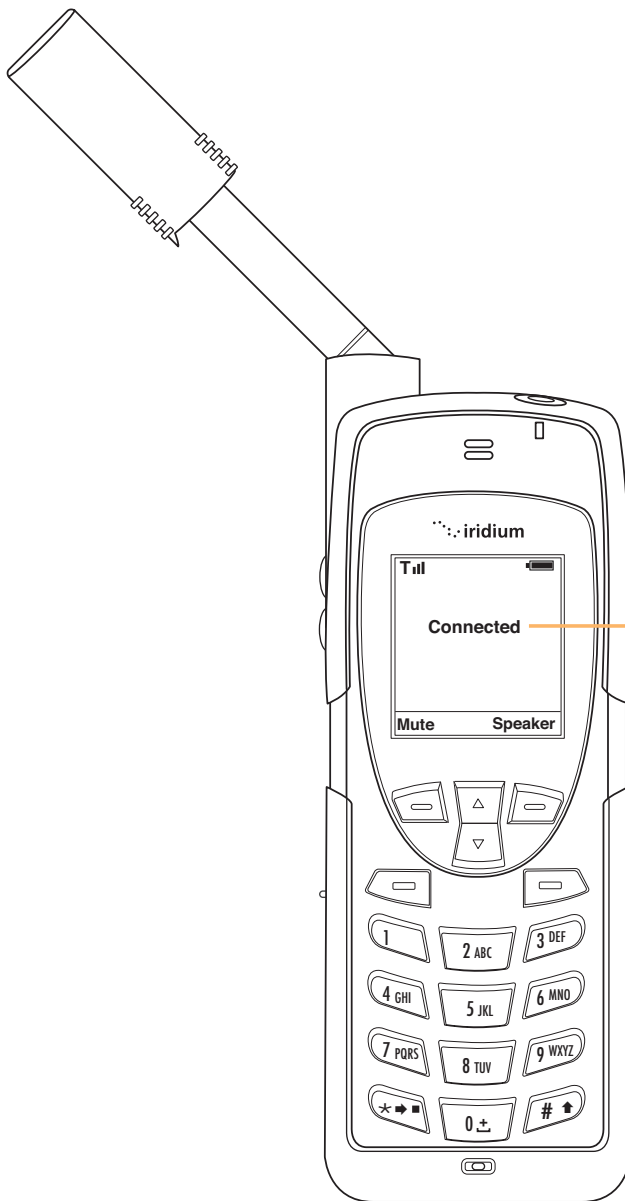

6. Phone displays **Connected**

If the call does not connect properly, the following message will appear:

Message	Directive
Call Failed	The antenna is not properly positioned or the network signal is not strong enough.





## Iridium 9555 Handset | 4 Getting Started

### Muting a Call

For privacy during a call, use the mute feature. You will hear the party on the other end, but they will not hear you.

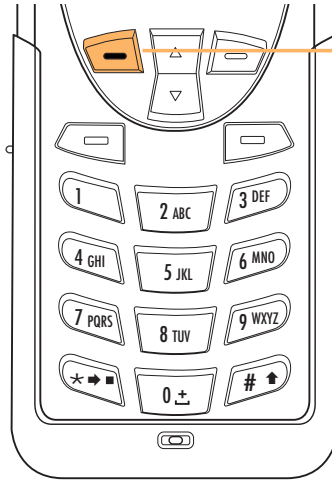

**To mute the call:**  
Press the **left** soft key.

**To un-mute the call:**  
Press the **left** soft key again.

### Speaker Phone

To allow the call to be shared with other people within close proximity to your phone, use the Speakerphone feature. In this mode the speaker in the rear of the phone is used instead of the normal earpiece/receiver.

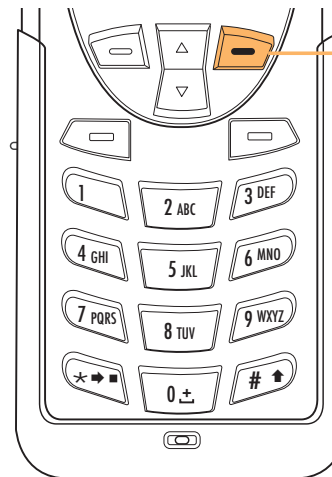

**To use speaker phone:**  
Press the **right** soft key.

**To switch back to the earpiece:** Press the **right** soft key again.





## Iridium 9555 Handset | 4 Getting Started

### Speaker Volume

The speaker volume can be adjusted either while on a call or via the Volume and Tones menu located under the Setup Menu.

- Increase the speaker volume by pressing the **upper volume control** key, during a call. Once you are satisfied with the volume press **OK**. If you would like to cancel the change to the volume press **Back**.
- Decrease the speaker volume by pressing the **lower volume control** key, during a call.

As you press the keys, you will hear the new volume level. The bar graph on the display indicates the volume level. The higher the graph, the louder the volume.

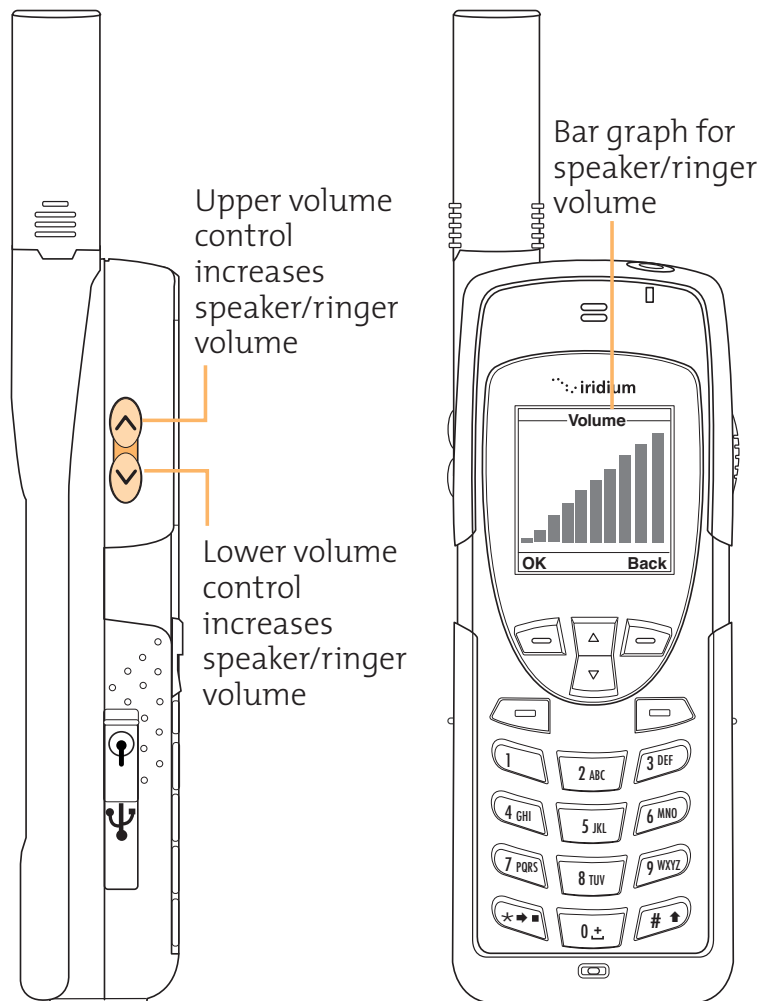

4.19





## Iridium 9555 Handset | 4 Getting Started

### Ringer Volume

The ringer volume may be adjusted via the Volume and Tones menu located under the Setup Menu.

- Increase the ringer volume by pressing the **upper volume control** key.
- Decrease the ringer volume by pressing the **lower volume control** key.
- As you press the keys, you will hear the new volume level. The bar graph on the display indicates the volume level. The higher the graph, the louder the volume.

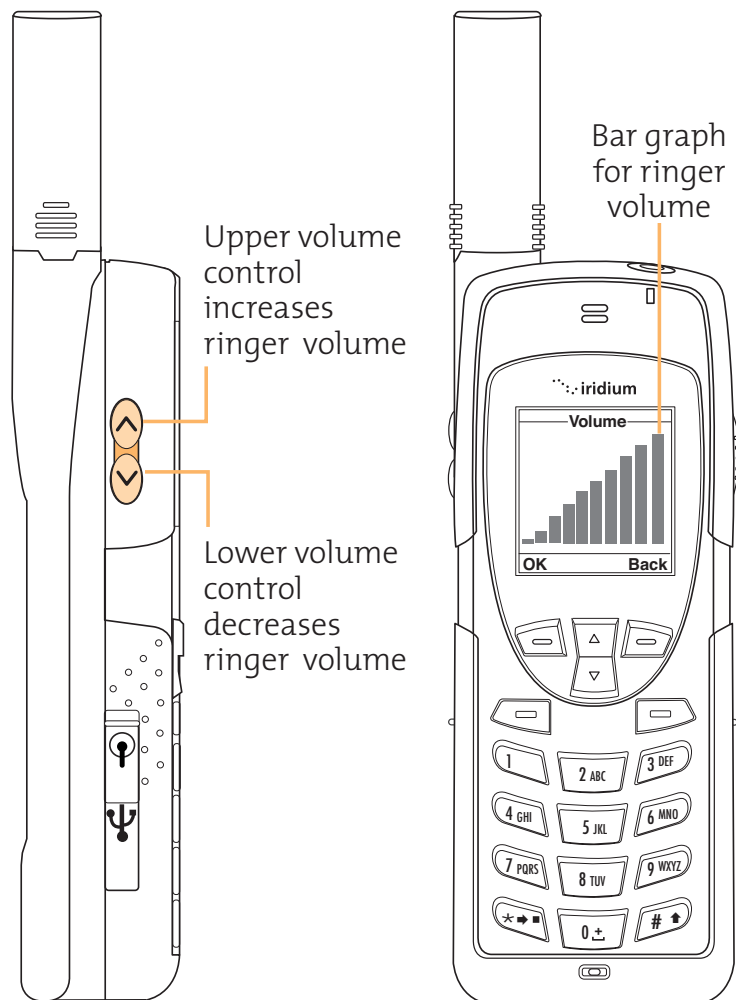

## Unanswered Calls

If you are away from your phone or choose not to answer a call the screen displays the number of missed calls.

### Messages from Missed Calls

If you are not able to answer your phone, or are not connected to the network, callers can leave you a voice message which can be accessed from the voicemail system. When connected to the network, a message icon will appear on your screen indicating a new voicemail message.

For more information on retrieving messages, see Chapter 9: Using the Voicemail Menu.

## Locking and Unlocking the Keypad

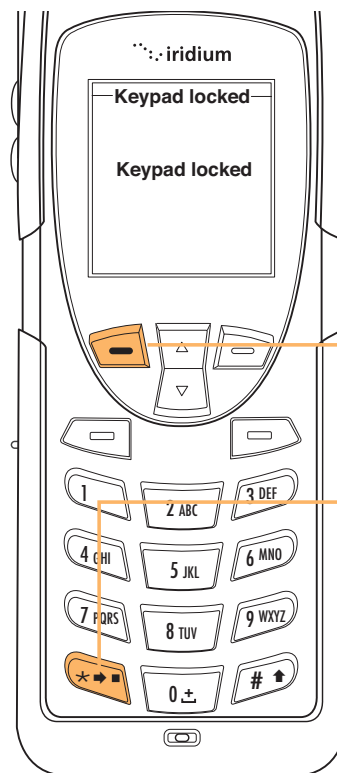

To prevent accidental phone usage you can **lock the keypad** by:

1. Press the **left soft** key, labeled **Menu**.
2. Press the **\* key** to lock the keypad. A message will flash indicating the keypad is locked.

**Note:** All keys with the exception of the power key are locked. You can still answer an incoming call by pressing the green key or the left soft key when the keypad is locked.



## Iridium 9555 Handset | 4 Getting Started

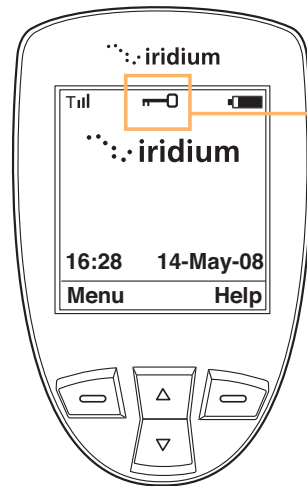

3. The main screen will now have a lock symbol.

### Unlocking the Keypad

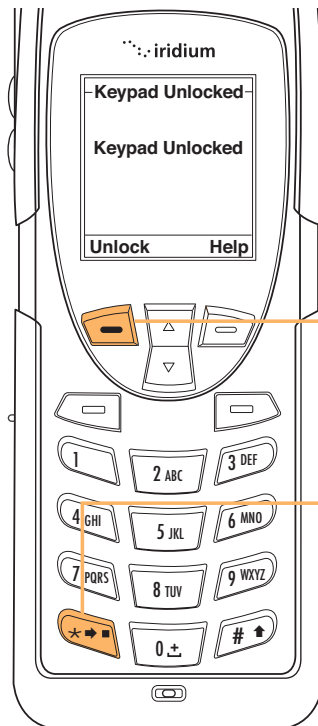

1. Press the **left soft** key labeled **Unlock**.

2. Press the **\* key**. A message will flash indicating the keypad is unlocked, and the lock symbol will no longer appear on the main screen.







# 5 | Using Menus and Keys

Many of the phone's features are organized into lists of options called menus. Use the phone keys to navigate these menus.

## Using the Keys

### The Soft Keys

When you press the soft keys the function appears above the key on the display screen. The function varies depending on the menu.

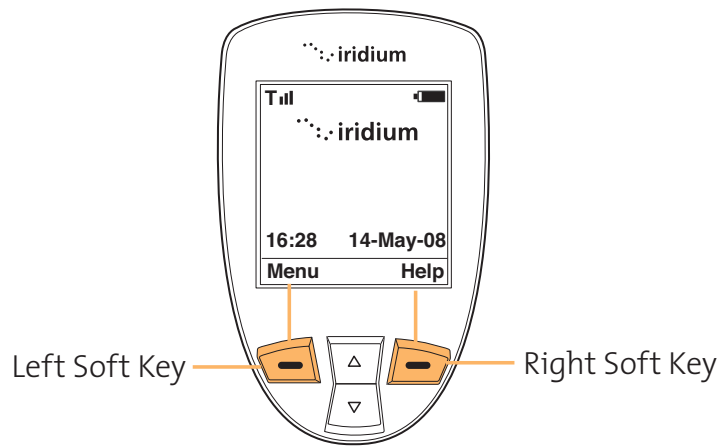

### The 2-way Navi-key

Press the 2-way navi-key up to step through the options on a menu screen.

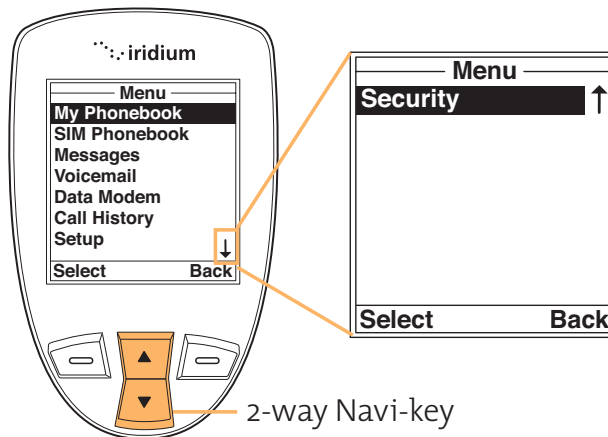

**Important:** When an arrow appears on the bottom of any menu screen it indicates more options to follow. To see all options, you must continue to press the 2-way navi-key.





## Iridium 955 Handset | 5 Using the Menus and Keys

### The Keypad

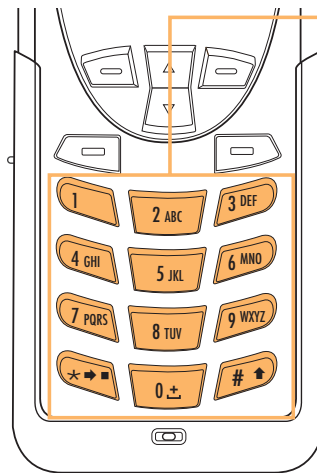

The numbered and alphabetized keys make up the **Keypad**. Use the keys to enter text, numbers and punctuation marks into various fields in display screens. See page 5.4 for more information on entering characters.

### Using the Menus

#### To Access the Main Menu

**Note:** You cannot access the menus during a call.

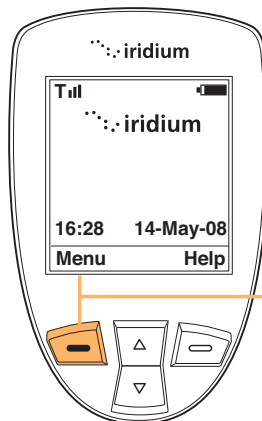

Starting from the **main screen**:

Press the **Left** soft key labeled **Menu**.

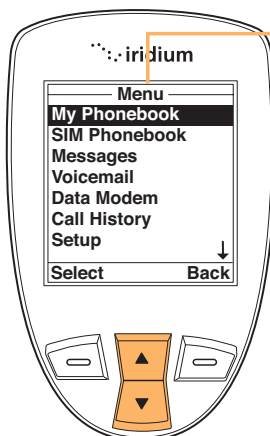

The **Main Menu** will appear. The Main Menu consists of:

- My Phonebook
- SIM Phonebook
- Messages
- Voicemail
- Data Modem
- Call History
- Setup
- Security





### To Access Main Menu Options

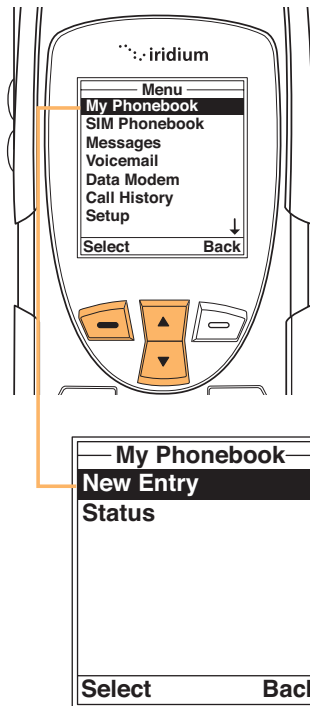

Starting from the **Main Menu**, use the **2-way navi-key** to scroll to the desired menu option until it is highlighted.

Press the **left** soft key labeled **select**. The option you selected will appear. Continue this procedure for each sub-menu.

### To Return to a Menu

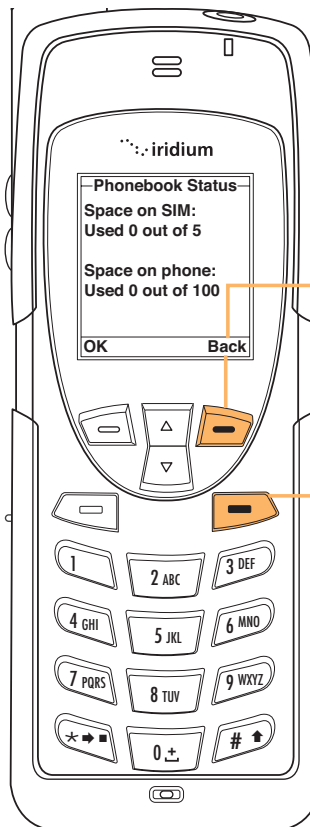

When the right soft key is labeled **Back**, the key will take you to the previous screen.

When the key is not labeled **Back** use the **red** key to return to the previous screen.

**Note:** In **all** other instances the **red** key will return you to the main screen.





## Iridium 9555 Handset | 5 Using the Menus and Keys

### Entering Characters

Many of the menu screens will have fields where you need to enter information such as names and addresses. To enter this information you will need to use the keys on the keypad. Each key represents a set of letters.

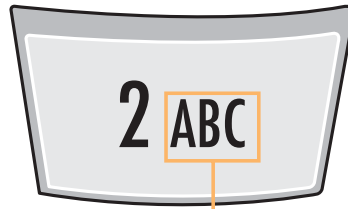

#### For Example:

Use the number 2 key for letters A, B, and C

Press 1 time for A

Press 2 times for B

Press 3 times for C

**Note:** Press the # key to toggle between caps, lowercase, first letter capitalization, and digits. The mode currently selected is displayed in the top left corner of the screen; the modes are indicated as **ABC**, **abc**, **Abc**, **123**.

When creating phonebook entries and/or composing text messages; you can use both the side volume keys and the navigation key to help navigate between characters or lines of text without deleting.

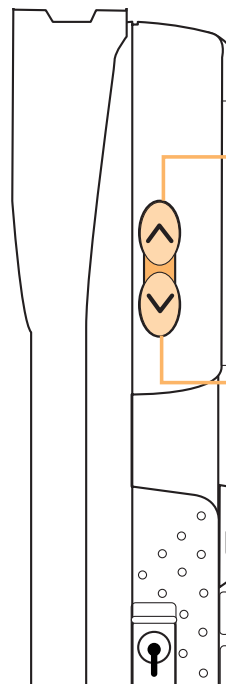

The **up** volume key will take you backwards through text.

The **down** volume key will take you forward through text.





## Iridium 9555 Handset | 5 Using the Menus and Keys

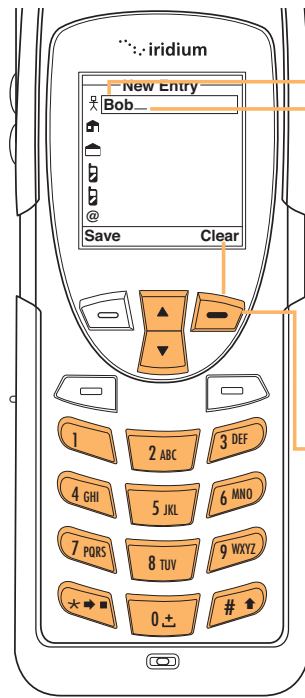

### To enter characters:

1. Enter a character by pressing the appropriate keys on the keypad. See keypad guide below.
2. The cursor will move to the next character position.
3. To delete a character press the **right** soft key, labeled **Clear**.
4. Repeat steps 1 and 2 and many times as necessary.

### Keypad Guide

#### Note:

For most of the keys, there are more characters available after additional presses.

Key	Available Characters
1	. (period)] 1
2	A/B/C/2
3	D/E/F/3
4	G/H/I/4
5	J/K/L/5
6	M/N/O/6
7	P/Q/R/S/7
8	T/U/V/8
9	W/X/Y/Z/9
0	_ (space)
*	next charactor
#	shift up
Right Soft Key	backspace / exit





## Entering Punctuation

Pressing \* (star) key will take you to a symbols menu with a list of the most commonly used punctuation marks and symbols.

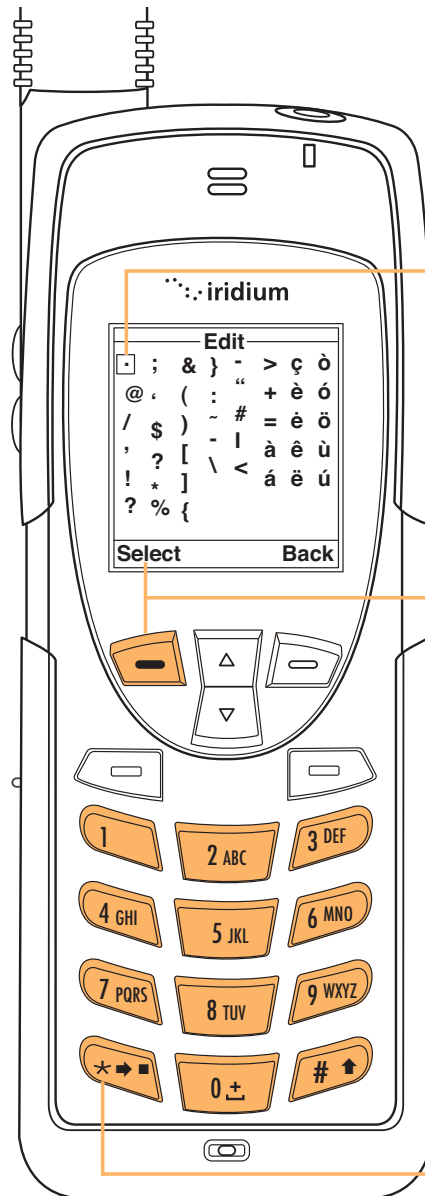

Using the **2-way navi-key** cycle through the screen until you reach the desired symbol.

Press the **left** soft key labeled **Select**.

Press the **Star** key to open the symbols menu.





## Entering Numbers and symbols into text

There may be times when you need to add numbers into a message that you are writing. For example, to send someone a phone number as part of a text message.

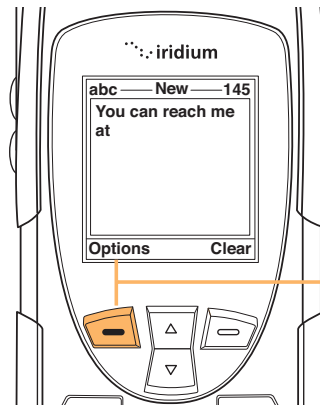

Starting from a text entry field:

1. Press the **left** soft key labeled **Options**.

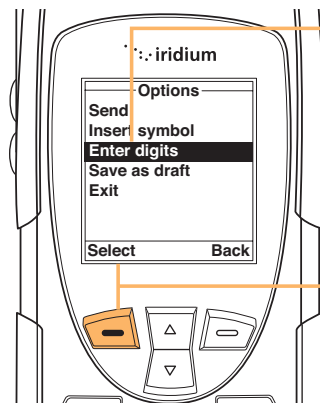

2. The **Options** screen will appear. Using the **2-way navi-key** scroll until **Enter digits** is highlighted.
3. Press the **left** soft key labeled **Select**.



4. The original text will now appear, but you will be in the number entry mode.
5. Press the **left** soft key labeled **Options**.



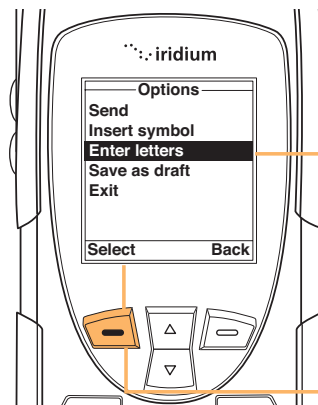

6. The **Options** screen will appear. Using the **2-way navi-key** scroll until **Enter letters** is highlighted.

7. Press the **left** soft key labeled **Options**.

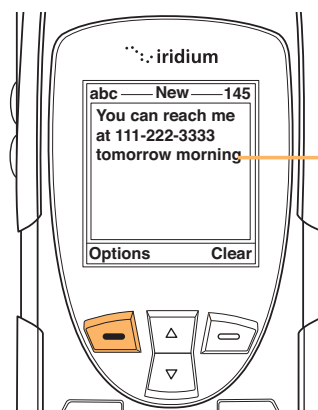

8. The original text screen will now appear and you can continue to enter text in the letter entry mode.

**Note:** Use this same procedure for entering symbols into text by choosing **Insert symbol** in the options menu. You can also press the \* key as a shortcut for accessing the symbol menu (see page 5.7).





# 6 | Using the Phonebooks

## Organizing My Phonebook

Your satellite phone has two primary phonebooks: My Phonebook and SIM Phonebook.

My Phonebook can store up to 100 names and numbers and is completely editable by you. This information is stored directly on your phone. The SIM Phonebook is provided to you by your service provider and/or organization the entries for which are stored directly on the SIM card used with your phone and are not editable.

	Phone Memory	SIM Card Memory
Personal Numbers	100 entries	155 entries
Fixed Dial Numbers	No entries	40 entries
Phone Number Digits	23	20
Name Characters	23	16

**Note:** SIM card capacity varies depending upon the card issued by your service provider.



## Locating My Phonebook

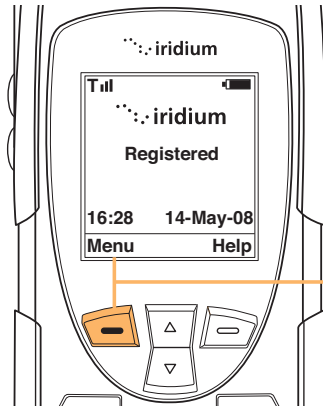

Starting from the **main screen**:

1. Press the **left** soft key, labeled **Menu**.

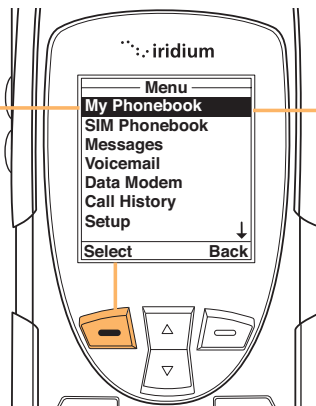

**Note:** All instructions for My Phonebook will start from the **Main Menu** as shown.

2. The **Main Menu** will now be displayed, with **My Phonebook** highlighted press the **left** soft key labeled **Select** to enter the Phonebook menu.

**Note:** To open the SIM Phonebook, use the **2-way navi-key** to scroll until the SIM Phonebook is highlighted.

## About the My Phonebook Menu

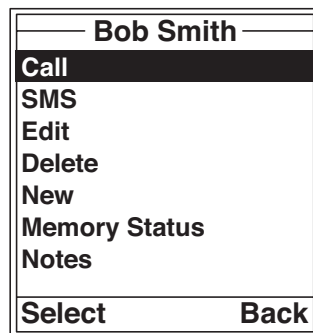

You will be able to perform the following functions using the Phonebook menu:

- Call an entry
- Create and send a text message (SMS).
- Edit an entry
- Delete an entry
- Add an entry
- Check the memory status of your phonebook
- Add notes regarding entries



## Iridium 9555 Handset | 6 Using the Phonebooks

### Add a New Entry to My Phonebook

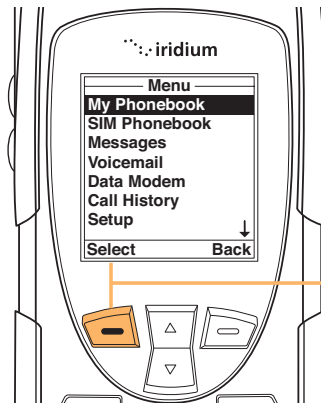

To add information to the Phonebook, use the **New** option. Start at the **Main Menu**, with **My Phonebook** highlighted:

1. Press the **left soft key** labeled **Select**.

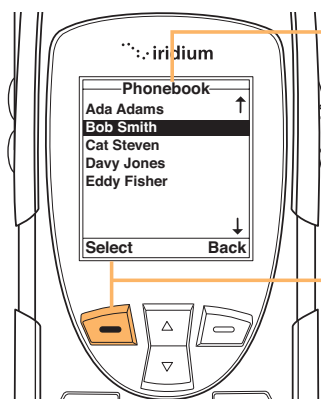

2. The **Phonebook** will now be displayed.

3. Press the **left soft key** labeled **Options**.

**Note:** If there are no entries Empty will be displayed on this screen. If entries are present press the **left soft key** while highlighting any contact.

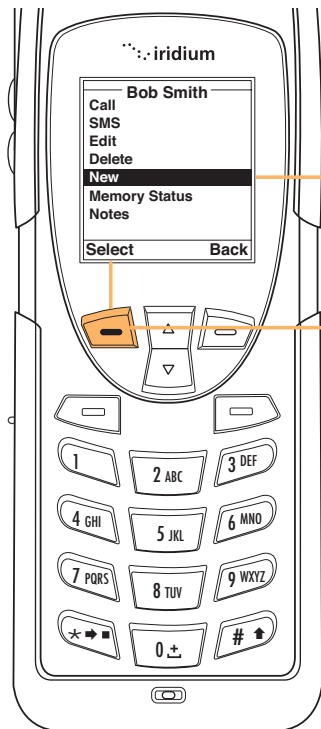

4. Use the **2-way navi-key** until the **New** option is highlighted.

5. Press the **left soft key**, labeled **Select** to proceed.





## Iridium 9555 Handset | 6 Using the Phonebooks

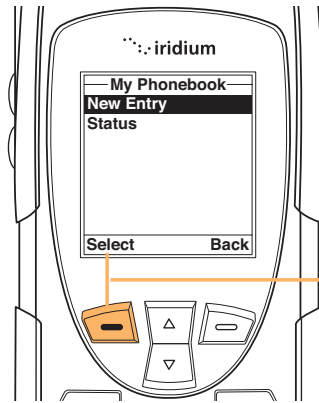

6. Press the **left** soft key, labeled **Select**.

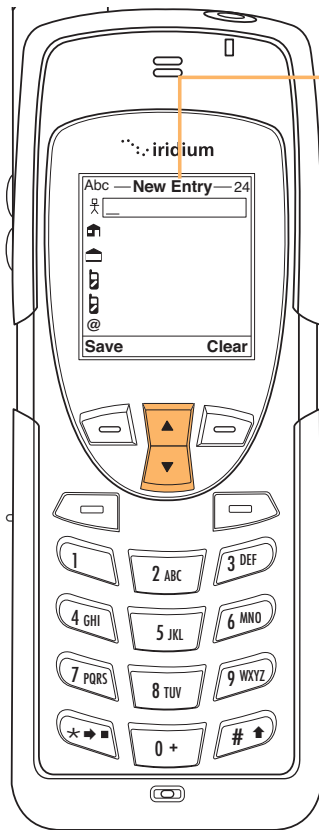

7. The **New Entry** screen will now be displayed with a list of icons which represent:



Name



Home phone



Work phone



1st cell phone



2nd cell phone



email address





## Iridium 9555 Handset | 6 Using the Phonebooks

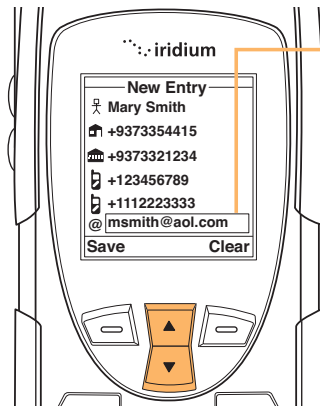

8. Use the **2-way navi-key** to scroll to each field and the **keypad** to enter information into the fields.

**Note:** While entering or editing contact information the side volume keys will allow you to move backwards and forwards without deleting.

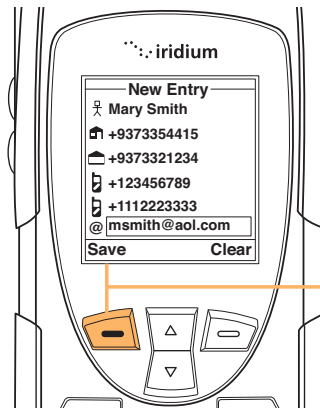

9. Press the **left** soft key labeled **Save**.

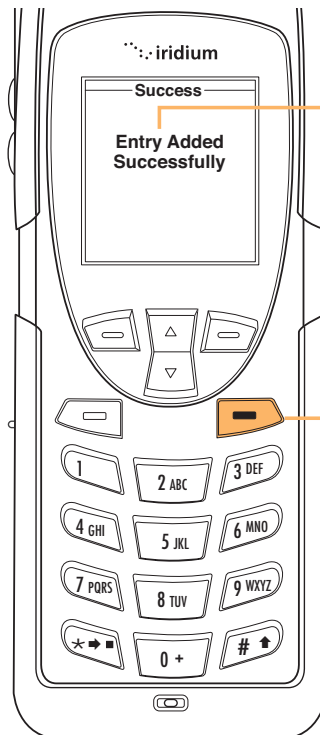

10. A message will briefly appear to indicate the contact was entered successfully. The screen will revert to the main Phonebook menu.

Press the **red** key to return to the **Main Screen**.



## Iridium 9555 Handset | 6 Using the Phonebooks

### Locating Entries

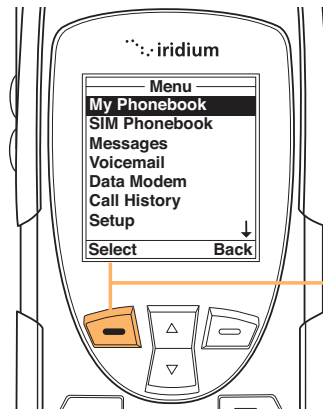

Starting at the **Main Menu**, using the **2-way navi-key**, highlight the Phonebook you wish to use.

1. Press the **left soft key**, labeled **Select**.

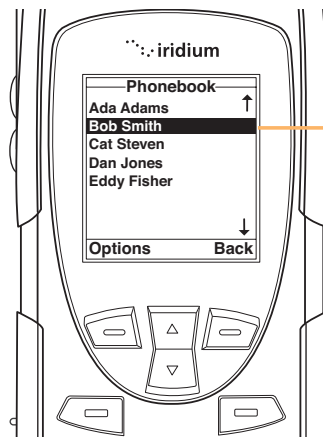

2. The Phonebook entries will now be displayed in alphabetical order.

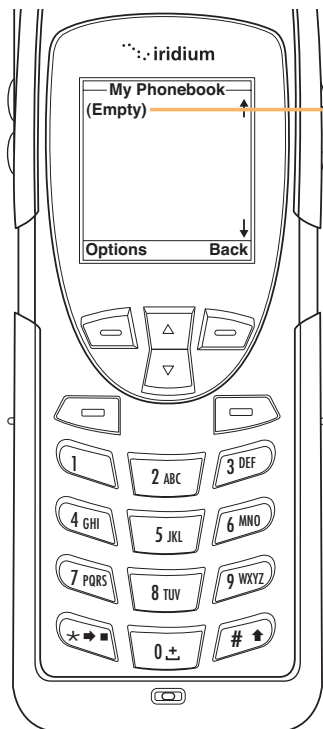

3. If there are no entries **Empty** will be displayed. See page **6.3** to add new entries into My Phonebook.



## Iridium 9555 Handset | 6 Using the Phonebooks

### Calling an Entry

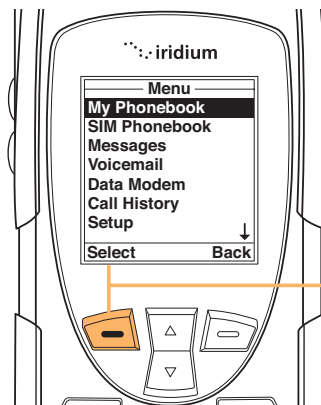

Starting at the **Main Menu**, using the **2-way navi-key**, highlight the Phonebook you wish to use.

1. Press the **left soft key**, labeled **Select**.

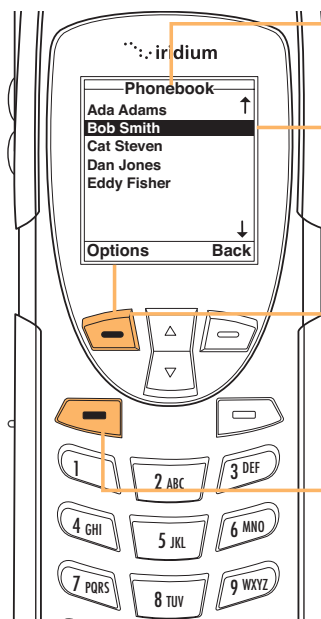

2. The **Phonebook** will now be displayed.

Use the **2-way navi-key** to scroll until the desired entry is located.

3. With the entry highlighted, press the **left soft key** labeled **Options**.

**Note:** You can also press the **green key** as a short-cut to calling an entry.

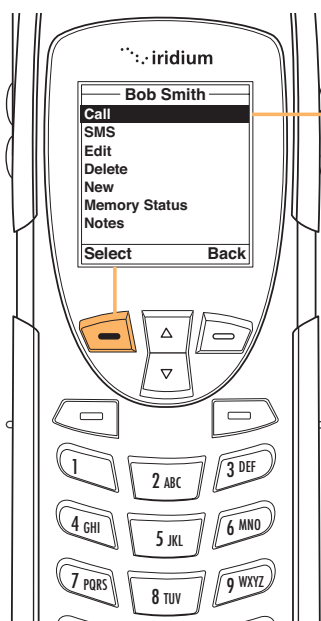

4. The **Phonebook options** will now be displayed.

5. With the **Call** option highlighted, press the **left soft key** labeled **Select**.

**Note:** If an entry has more than 1 number i.e. Home, Work and Mobile then all numbers will be displayed. Using the **2-way navi-key**, highlight the number to be called and press **Select**.





## Iridium 9555 Handset | 6 Using the Phonebooks

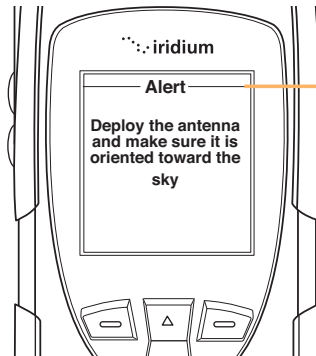

**Note:** If your antenna is not extended you will receive an alert message telling you to extend the antenna.

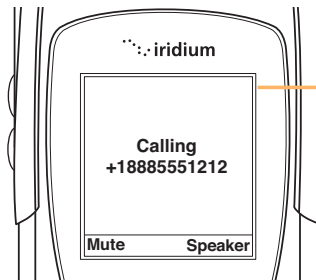

**6. Calling** followed by the number you dialed will be displayed. The call will then be connected.

### Using the Short Message Service (SMS) Menu

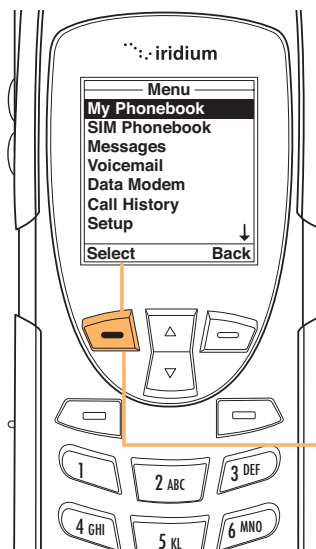

The Short Message Service (SMS) is a text messaging system. To send a text message Start at the **Main Menu**, using the **2-way navi-key**, highlight the Phonebook you wish to use.

**1.** Press the **left soft key**, labeled **Select**.

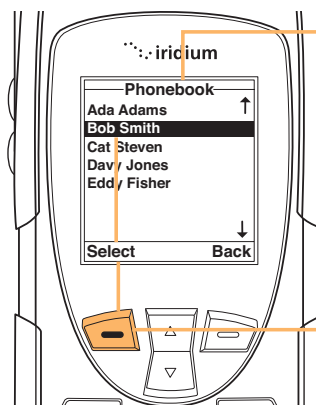

**2.** The **Phonebook** will now be displayed. Use the **2-way navi-key** to scroll until the desired entry is highlighted.

**3.** Press the **left soft key** labeled **Options**.





## Iridium 9555 Handset | 6 Using the Phonebooks

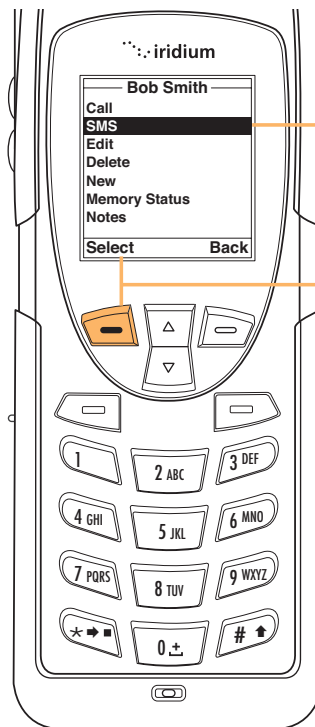

4. Use the **2-way navi-key** until **SMS** is highlighted.

5. Press the **left** soft key, labeled **Select**.

**Note:** If an entry has more than 1 number i.e. Home, Work and Mobile then all numbers will be displayed. Using the 2-way navi-key, highlight the desired number and press Select.

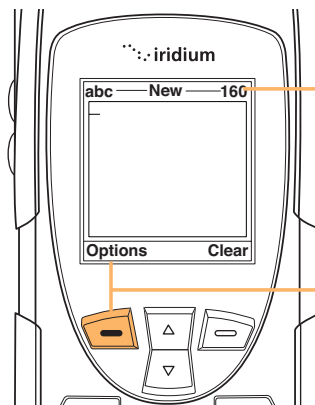

6. The **SMS screen** will now appear. You can enter as many as 160 characters.

7. Press the **left** soft key, labeled **Options**.

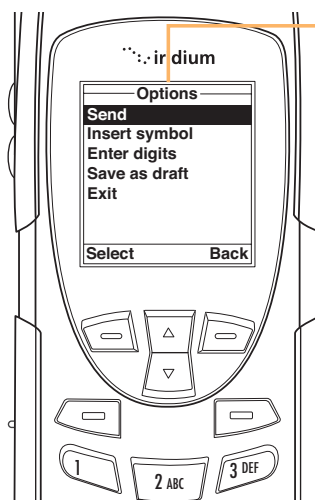

8. The **SMS Options** menu will now appear. From here you are able to:

- Send a SMS message
- Insert symbols into your message
- Enter digits
- Save as a draft to send later
- Exit the menu

## Sending an SMS

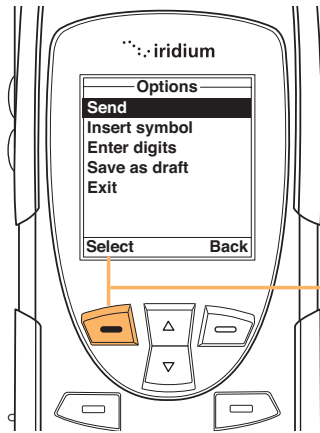

Starting at the  
**SMS Options Menu:**

1. While **Send** is highlighted press the **left** soft key, labeled **Select**.

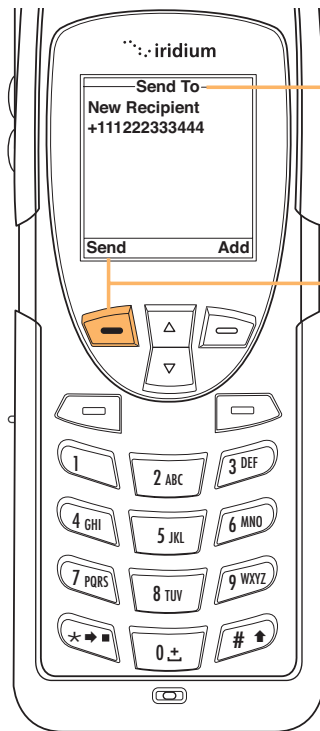

2. A **Send To** screen will now appear with the entry name and number.
3. Press the **left** soft key, labeled **Send**.

**Note:** At this time you may select to send the message to additional recipients by highlighting **New Recipient** and pressing the **right** soft key labeled **Add**.



## Adding an SMS Recipient

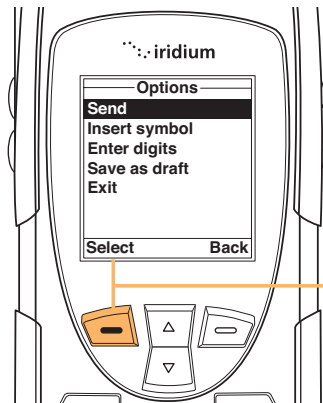

Starting at the **SMS Options Menu**:

1. While **Send** is highlighted press the **left** soft key, labeled **Select**.

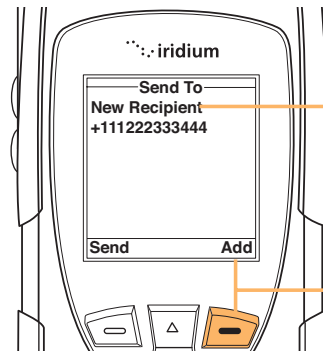

2. A **Send To** screen will now appear with **New Recipient** and the entry number.

3. Press the **right** soft key, labeled **Add**.

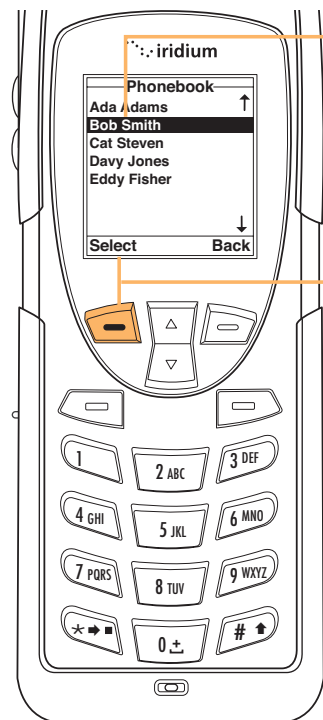

4. A list of contacts will now appear. Use the **2-way Navi-key** to scroll to the desired recipient.

5. Press the **left** soft key labeled **select** the contact is then added to your recipient list.

**Note:** Repeat this procedure if you would like to send the same message to more than one contact at a time.





## Iridium 9555 Handset | 6 Using the Phonebooks

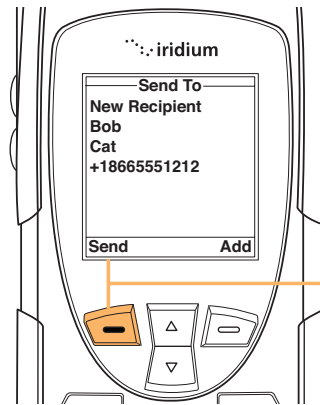

6. Once you are satisfied with the recipient(s) press **left** soft key labeled **Send**.

### Edit an Entry in My Phonebook

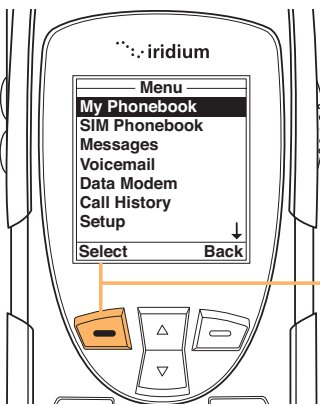

To change information in the Phonebook, use the **Edit** Option. Starting at the **Main Menu**, with **My Phonebook** highlighted:

1. Press the **left soft key**, labeled **Select**.

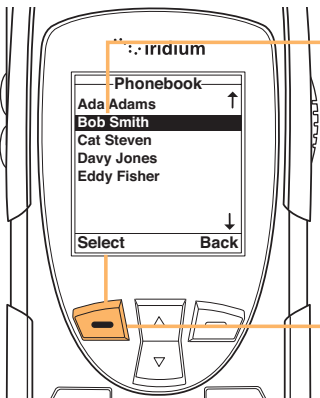

2. The **Phonebook** will now be displayed.

Use the **2-way navi-key** to scroll until the desired entry is highlighted.

3. Press the **left soft key** labeled **Options**.

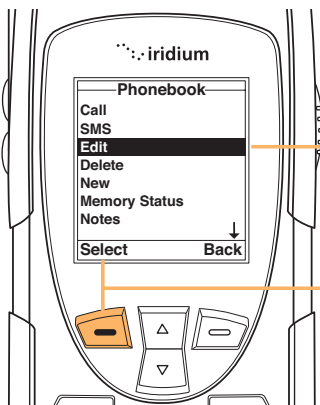

4. Use the **2-way navi-key** until the **Edit** option is highlighted,

5. Press the **left soft key**, labeled **Select** to proceed.





## Iridium 9555 Handset | 6 Using the Phonebooks

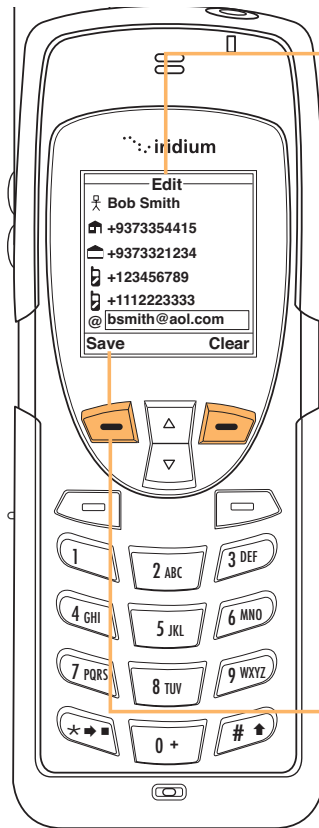

6. The **Edit** screen will appear. Edit the entry as needed by using the **2-way navi-key** to scroll to the required field(s). Use the side **volume keys** to navigate backwards (up key) and forwards (down key) without deleting and the **right soft key** labeled **clear** to delete characters. Use the **keypad** to enter new characters.
7. Press the **left** soft key, labeled **Save**.

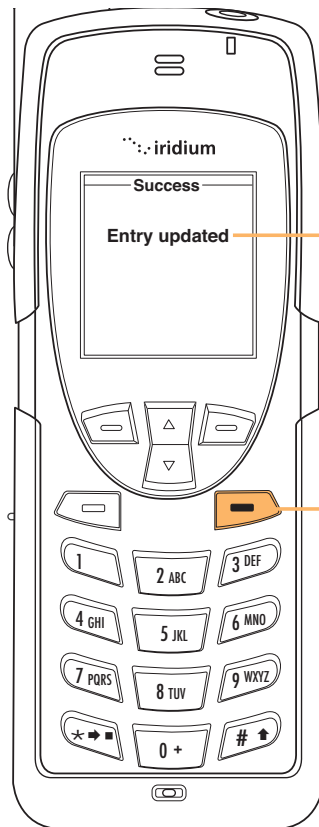

8. A message will briefly appear to indicate the entry was updated. The screen will then return to the main Phonebook menu.
9. Press the **red** key to return to the **Main** screen.



## Iridium 9555 Handset | 6 Using the Phonebooks

### Delete an Entry

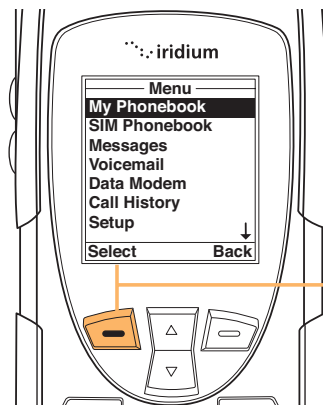

To remove an entry in the Phonebook, use the **Delete** Option. Start at the **Main Menu**:

1. Press the **left soft key**, labeled **Select**.

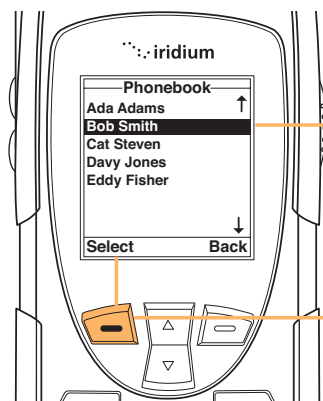

2. The **Phonebook** will now be displayed.
- Use the **2-way navi-key** to scroll until the desired entry is highlighted.
3. Press the **left soft key** labeled **Options**.

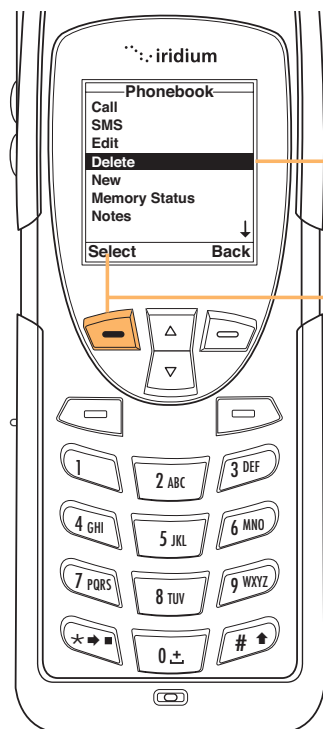

4. Use the **2-way navi-key** until the **Delete** option is highlighted.
5. Press the **left soft key**, labeled **Select** to proceed.



## Iridium 9555 Handset | 6 Using the Phonebooks

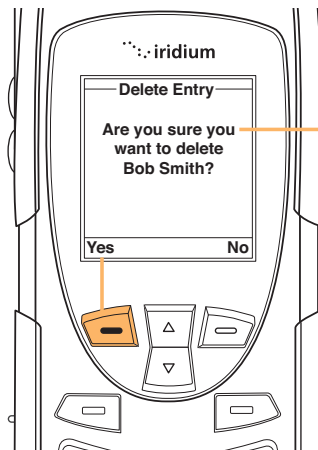

6. You will receive a message asking if you want to delete the entry. Press the **left** soft key labeled **Yes**. If you press No, the screen will revert to the previous menu.

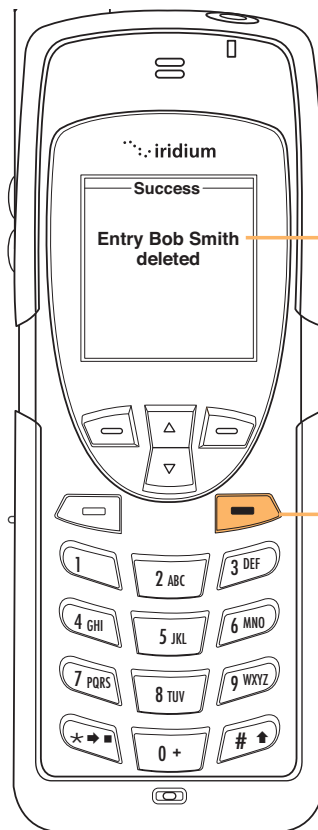

7. A message will briefly appear to indicate the entry was deleted. The main Phonebook menu will now appear.

8. Press the **red** key to return to the **Main screen**.





## Iridium 9555 Handset | 6 Using the Phonebooks

### Viewing Memory Status

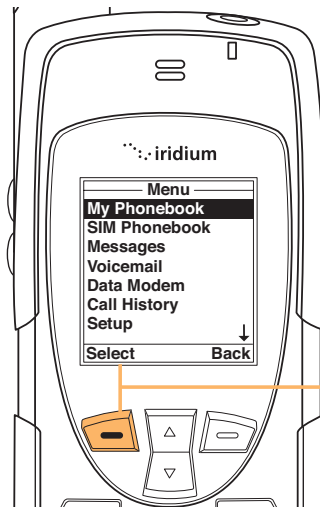

Use this feature to see how many phonebook memory locations are available in the SIM card memory and phone memory. Start at the **Main Menu**:

1. Press the **left soft** key labeled **Select**.

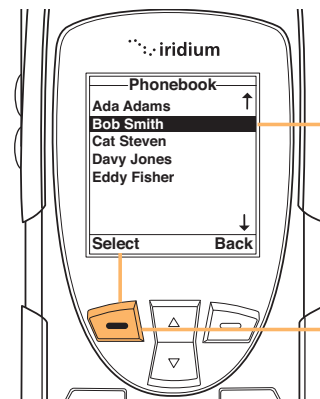

2. The **Phonebook** will now be displayed.

Use the **2-way navi-key** to scroll until any entry is highlighted.

3. Press the **left soft** key labeled **Options**.

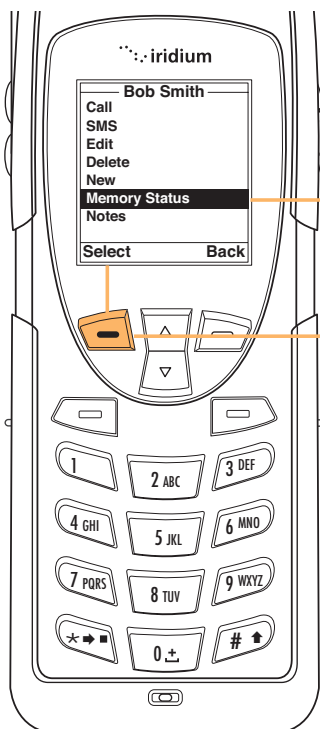

4. Use the **2-way navi-key** until **Memory Status** is highlighted.

5. Press the **left soft** key, labeled **Select** to proceed.







## Iridium 9555 Handset | 6 Using the Phonebooks

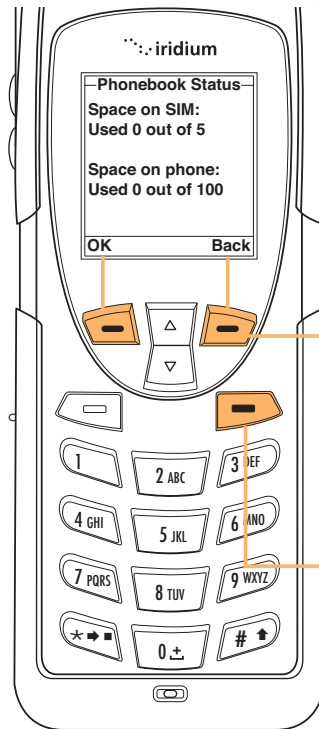

6. The **Phonebook Status** will now be displayed showing the space on the SIM and the phone memory.
7. Press the **left** soft key, labeled **OK** or the **right** soft key labeled **Back** to return to the previous screen.
- Press the **red** key to return to the **main screen**.

## Adding Notes to a Phonebook Entry

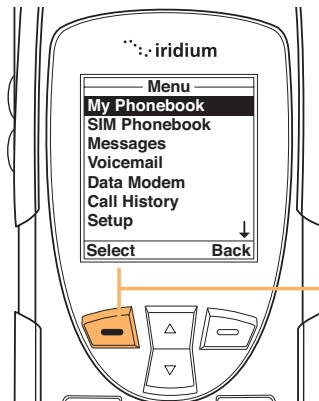

Use this feature to add information regarding an entry.

Start at the **Main Menu**:

1. Press the **left soft** key labeled **Select**.

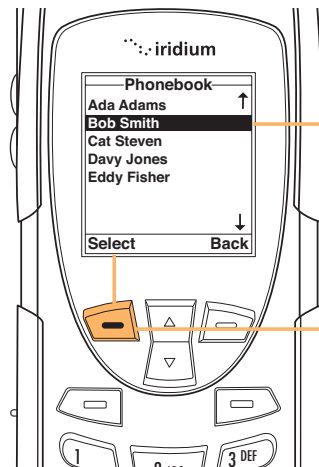

2. The **Phonebook** will now be displayed.
- Use the **2-way navi-key** to scroll until the desired entry is highlighted.
3. Press the **left** soft key labeled **Options**.



## Iridium 9555 Handset | 6 Using the Phonebooks

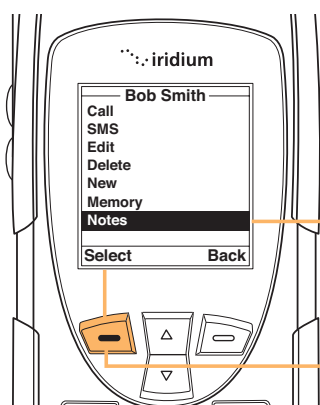

4. Use the **2-way navi-key** until **Notes** is highlighted.

5. Press the **left** soft key labeled **Select**.

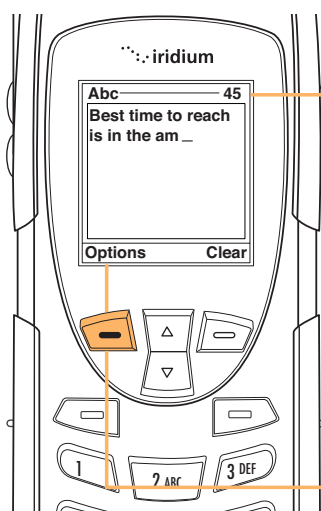

6. A text screen will now appear. Use the **Keypad** to enter your text.

**Note:** you can enter up to 64 characters. The character count in the top right corner will count down as you enter text.

7. Press the **left** soft key labeled **Options**.

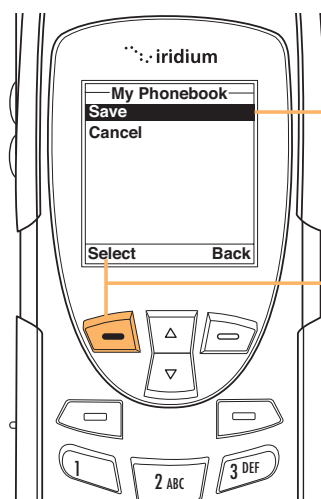

8. A My Phonebook screen will appear with **Save** highlighted.

9. Press the **left** soft key labeled **Select**.

**Note:** The text you entered will now be stored in the **Note** option for this entry.

### Restricted Phonebook

When the phonebook is restricted My Phonebook & SIM Phonebook will not appear - the main menu will display Fixed Phonebook only. The Fixed Phonebook cannot be edited.

# 7 | Using the Messages Menu

## Locating the Messages Menu

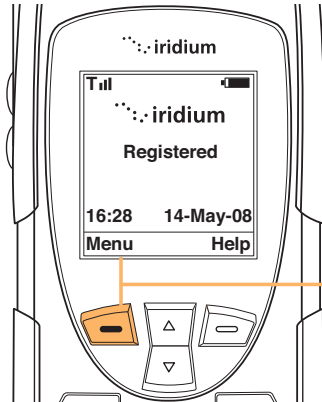

Starting from the **main screen**:

1. Press the **left** soft key labeled **Menu**.

### Note:

All instructions for the Messages Menu will start from the **Main Menu** as shown.

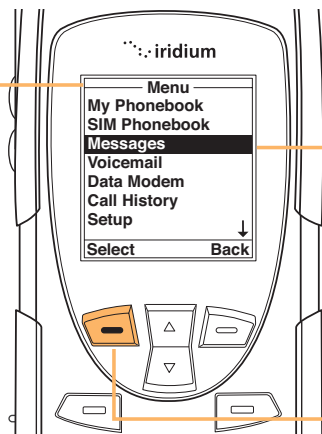

2. The **Main Menu** will now be displayed. Use the **2-way navi-key** to scroll until **Messages** is highlighted.

3. Press the **left** soft key labeled **Select**.

## About the Messages Menu

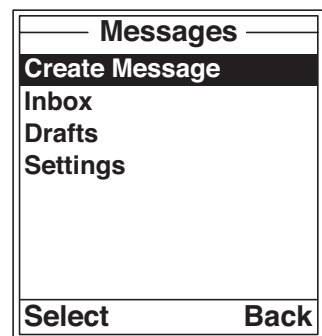

You will be able to perform the following functions using the **Messages** Menu.

- Create messages
- Read, reply, delete, call and forward messages
- Edit stored messages and send
- Enter service center number, set expiry period and enable or disable delivery reports.

## Create and Send a New Email Message to an address not in your phonebook

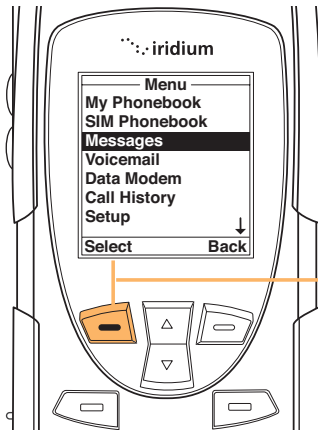

Starting at the **Main Menu** with **Messages** highlighted:

1. Press the **left soft key**, labeled **Select**.

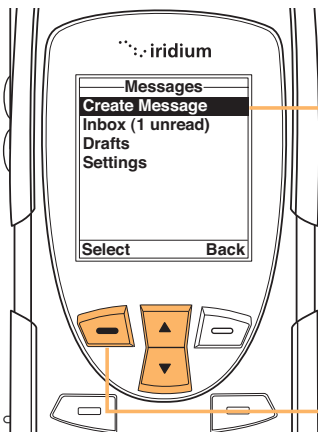

2. **Create message** option should be selected, if not then use the **2-way navi-key** to scroll until it is highlighted.

3. Press the **left soft key**, labeled **Select**.

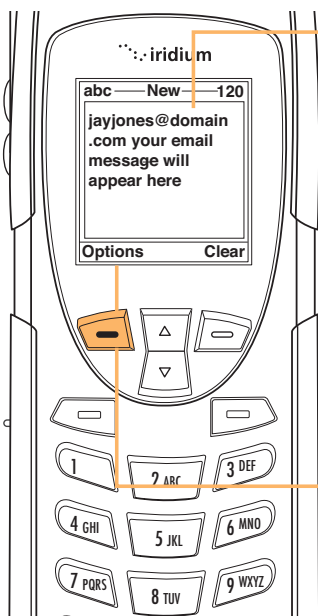

4. Enter your message.

**Note:** You must begin your text message with the recipients email address, leaving a space between the email address and the beginning of your message.

When your message is complete, press the **left soft key**, labeled **Options**.



## Iridium 9555 Handset | 7 Using the Message Menu

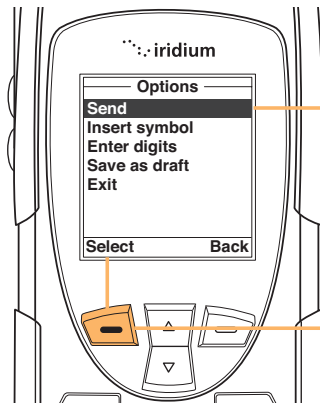

5. The **Send** option should be highlighted, if not use the 2-way navi-key to scroll until it is highlighted.

6. Press the **left** soft key, labeled **Select** to send the message.

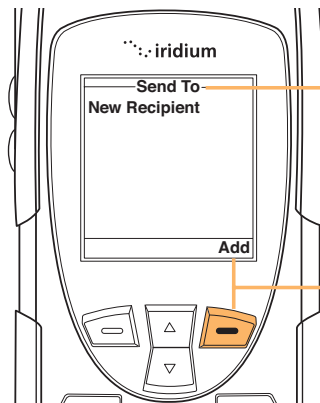

7. A **Send To** screen will now appear.

8. Press the **right** soft key, labeled **Add**.

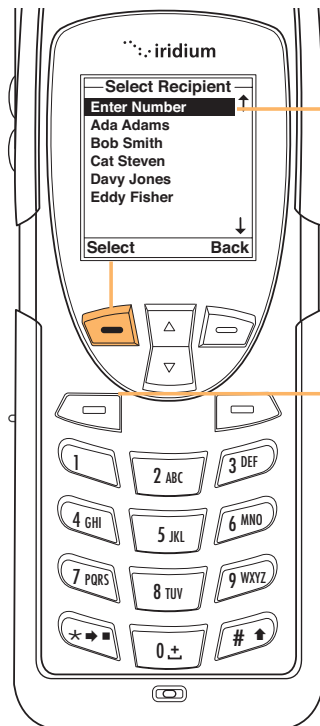

9. The Enter Number option should be highlighted, if not use the 2-way navi-key to scroll until it is highlighted.

10. Press the **left** soft key labeled **Select**.





## Iridium 9555 Handset | 7 Using the Message Menu

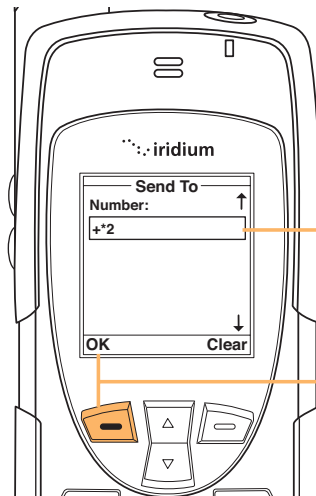

11. In the Number field, after the prefix of **00** or **+**, enter **\*2**.

12. Press the **left** soft key labeled **OK**.

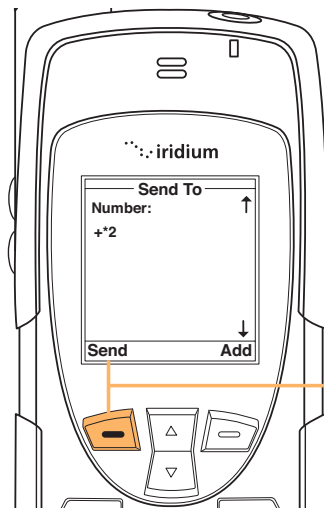

13. Press the **left** soft key labeled **Send** to send the message.

## Create and Send a New Email Message to an address in My Phonebook

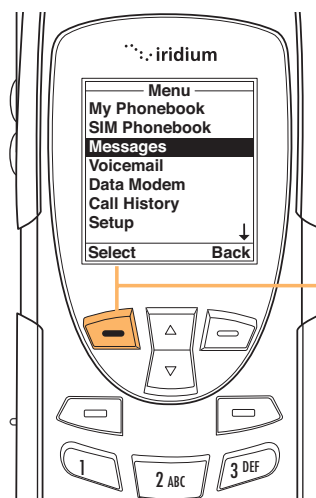

Starting at the **Main Menu** with **Messages** highlighted:

1. Press the **left soft** key, labeled **Select**.





## Iridium 9555 Handset | 7 Using the Message Menu

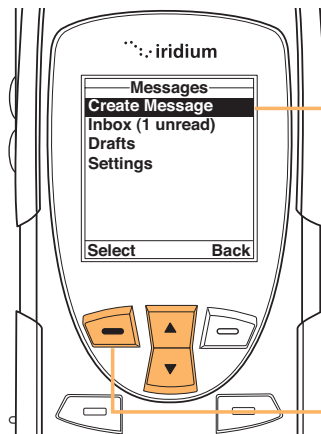

2. **Create message** option should be selected, if not then use the **2-way navi-key** to scroll until it is highlighted.

3. Press the **left** soft key, labeled **Select**.

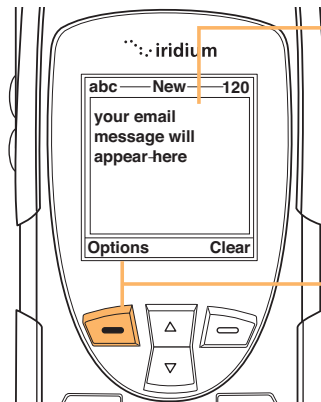

4. Enter your message.

5. When your message is complete, press the **left** soft key labeled **Options**.

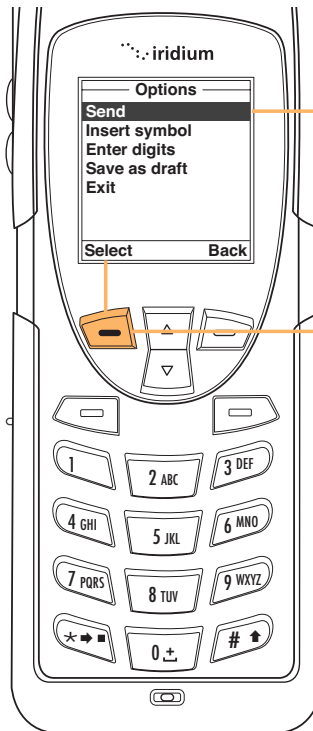

6. The **Send** option should be highlighted, if not use the **2-way navi-key** to scroll until it is highlighted.

7. Press the **left** soft key, labeled **Select** to send the message.



## Iridium 955 Handset | 7 Using the Message Menu

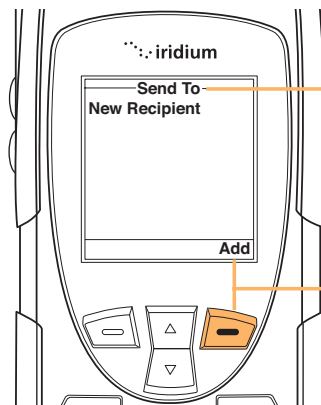

8. A **Send To** screen will now appear.

9. Press the **right** soft key, labeled **Add**.

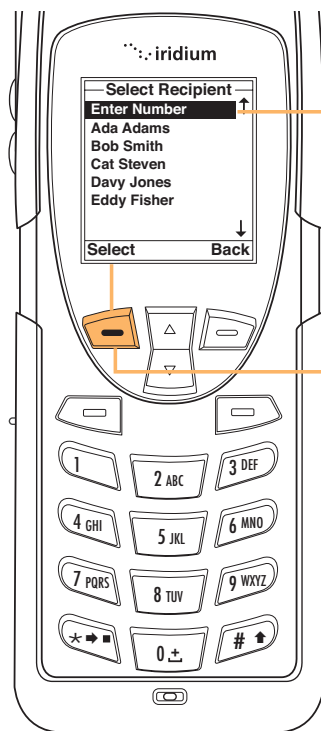

10. Use the **2-way navi-key** to highlight your selection.

11. Press the **left** soft key labeled **Select**.

**Note:** If the Contact's email address is the only information listed, the screen will return you to the **Send To** screen.

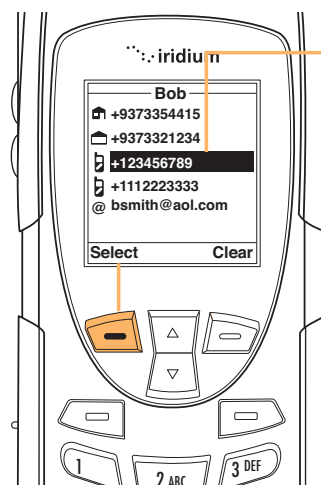

12. If the Contact has an e-mail address as well as a phone number listed you will be presented with their phonebook entry. Use the **2-way navi-key** to highlight their email address and press the **left** soft key labeled **Select**.





## Iridium 955 Handset | 7 Using the Message Menu

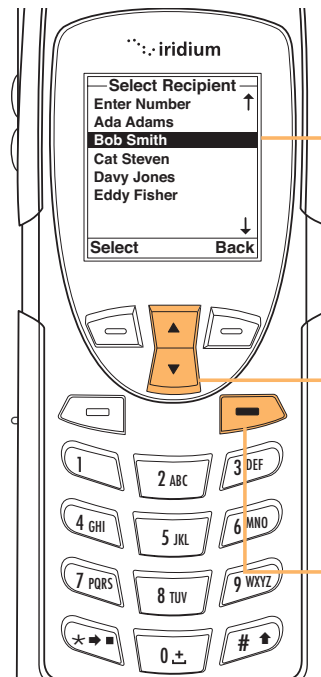

13. The Phonebook screen will appear with the recipient's name highlighted. To add another recipient, using the **two-way navi-key**, highlight the next recipient and repeat step 10.

14. Once all recipients have been selected, press the **right** soft key **Back**.

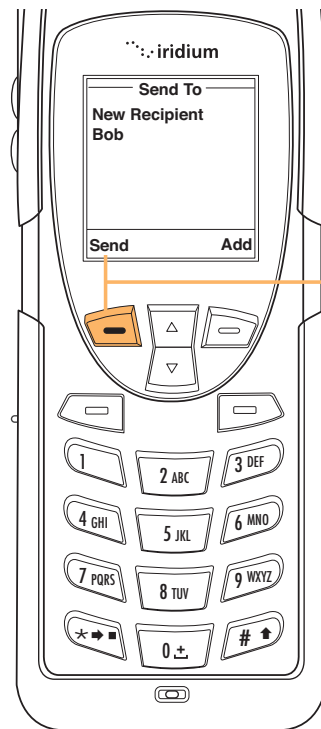

15. Press the **left** soft key labeled **Send**.





## About SMS Messaging

### How Your Phone Notifies You of Messages

If your phone is powered on, it notifies you of received messages in the following ways:

- An alert sounds and/or the phone vibrates.
- The message indicator is displayed
- The message **New SMS. Read Now?** is displayed.

### How messages are Stored

Your phone stores all messages on the SIM card. If the message indicator is flashing, your SIM card is full. See Delete a Message on page **8.11** to make room for the new message.

### What Messages Contain

You can receive short text or numeric messages in your Personal Mailbox. Text messages may contain up to 160 characters. Numeric messages, typically phone numbers, may contain up to 20 digits.

Your personal mailbox works along with Call Forwarding. For more information see section 6 on using the phonebook, and the call forwarding feature described on page **7.7**.





## Iridium 9555 Handset | 7 Using the Message Menu

### Using the Inbox Menu

You will be able to perform the following functions using the inbox:

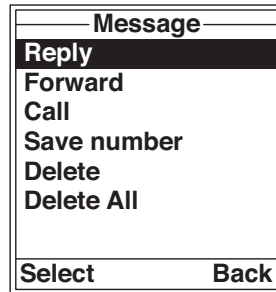

- Read a message
- Reply to a message
- Forward a message
- Call the number that left the message
- Save the number from the message
- Delete one or all messages

**Note:** If the message storage space on your SIM card is full, you will not be able to store a message for later retrieval. Use the delete message on page 7.11 to make room for new messages on your SIM card.

### Read a Message

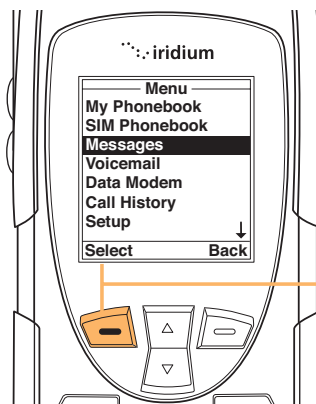

Start at the **Main Menu** with **Messages** highlighted:



1. Press the **left soft** key, labeled **Select**.

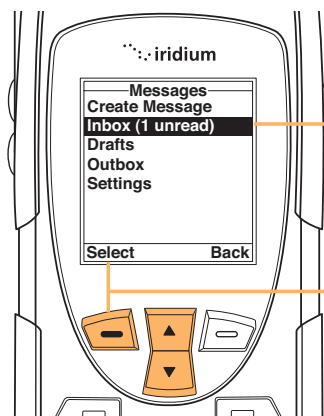

2. Use the **2-way navi-key** to scroll until **Inbox** is highlighted.
3. Press the **left soft** key, labeled **Select**.





## Iridium 955 Handset | 7 Using the Message Menu

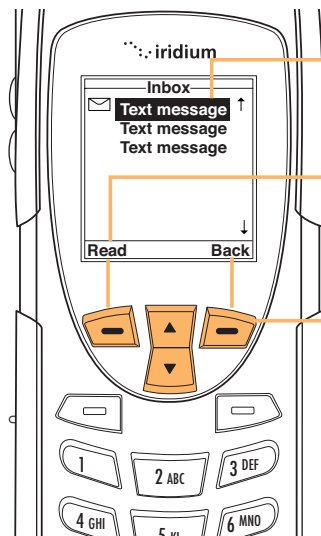

4. Use the **2-way navi-key** to highlight a message.
5. Press the **left** soft key labeled **Read** to view the selected message.
6. Press the **right** soft key, labeled **Back** to return to the previous menu.

### Reply to Sender

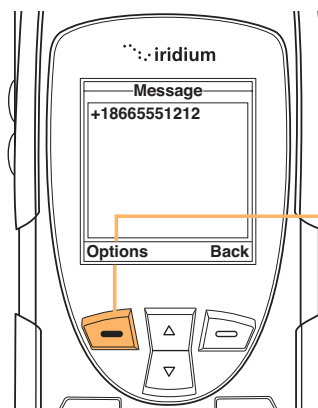

While reading the **Message** screen:

1. Press the **left** soft key labeled **Options**.

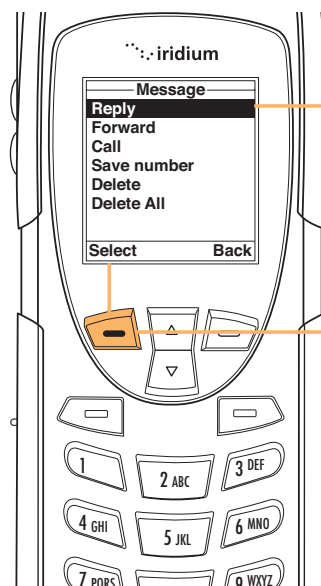

2. Use the **2-way navi-key** to scroll until **Reply** is highlighted.
3. Press the **left** soft key labeled **Select**.





## Iridium 9555 Handset | 7 Using the Message Menu

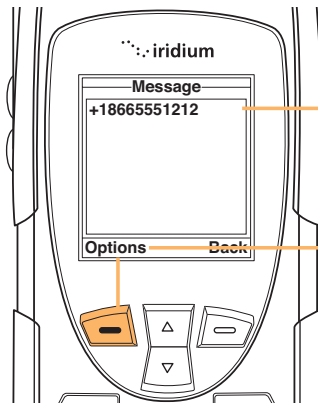

4. Enter your reply.

5. Press the **left** soft key, labeled **Options**.

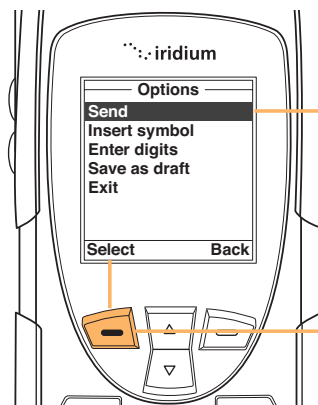

6. The **Send** option should be highlighted, if not use the 2-way navi-key to scroll until **Send** is highlighted.

7. Press the **left** soft key, labeled **Select** to send the message.

**Note:** If the sender's phone number is not part of your phonebook, select **New Recipient** to add the number.

## Forward a Received Message

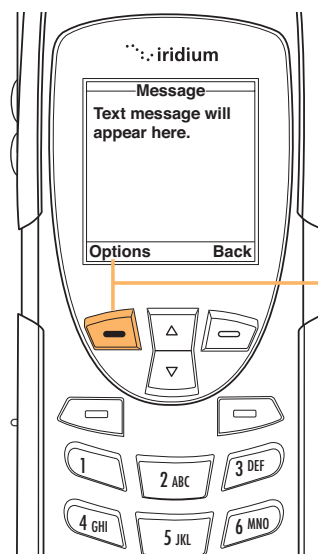

While reading the **Message**:

1. Press the **left** soft key, labeled **Options**.



## Iridium 9555 Handset | 7 Using the Message Menu

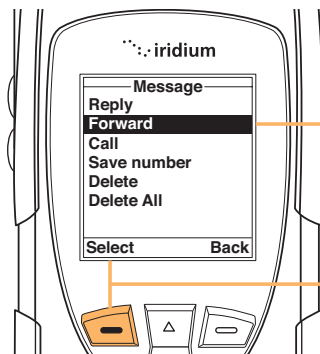

2. Use the **2-way navi-key** to scroll until **Forward** is highlighted.
3. Press the **left** soft key, labeled **Select**.

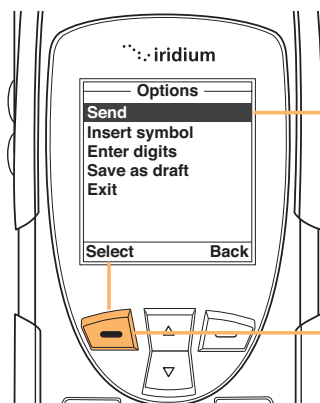

4. The **Send** option should be highlighted, if not use the 2-way navi-key to scroll until Send is highlighted.
5. Press the **left** soft key, labeled **Select** to send the message.

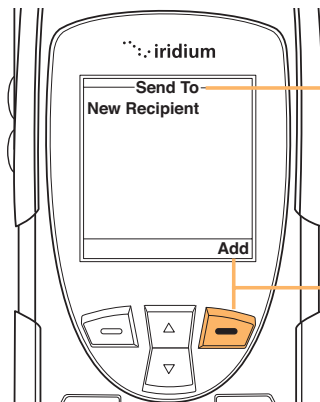

6. A **Send To** screen will now appear.
7. Press the **right** soft key, labeled **Add**.

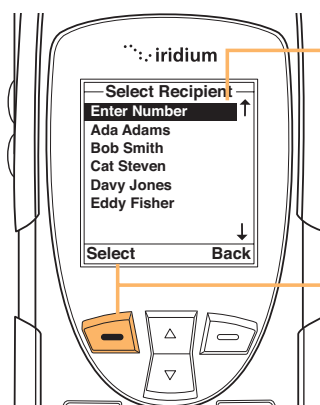

8. Use the **2-way navi-key** until the desired recipient from your Phonebook is highlighted.
9. Press the **left** soft key labeled **Options**.



## Iridium 9555 Handset | 7 Using the Message Menu

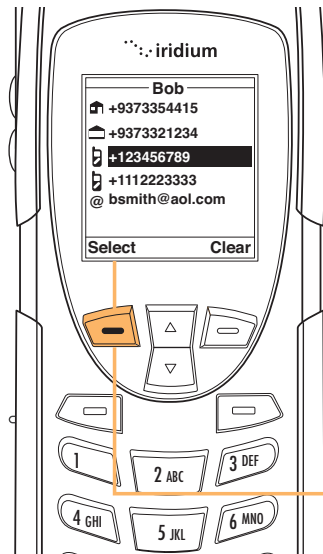

10. If the recipient has more than one number listed, the recipient's information screen will appear. Use the **2-way navi-key** to scroll to the desired number you would like to forward to.

11. Press the **left** soft key labeled **Select**. The number will be added to a recipient list.

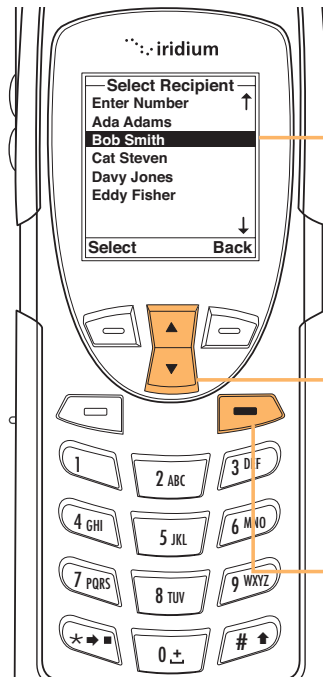

12. The Phonebook screen will appear with the recipient's name highlighted. To add another recipient, using the **two-way navi-key**, highlight the next recipient and repeat step 8.

13. Once all recipients have been selected, press the **right** soft key **Back**.

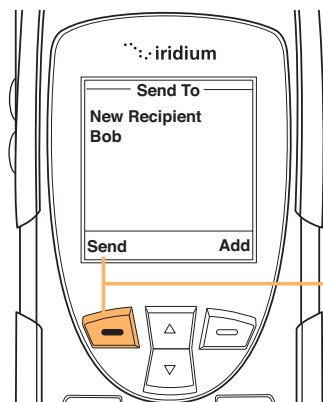

14. Press the **left** soft key labeled **Send**.





## Call a Number From a Received Message

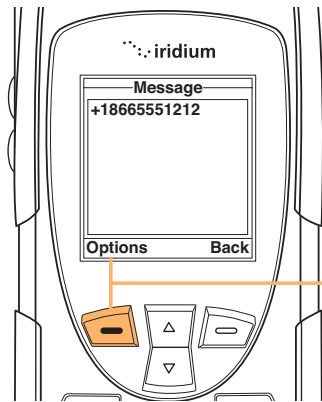

While reading the **Message screen**:

1. Press the **left** soft key labeled **Options**.

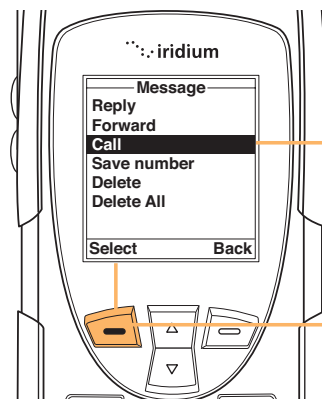

2. Use the **2-way navi-key** to scroll until **Call** is highlighted.

3. Press the **left** soft key, labeled **Select**.

## Save a Number from a Received Message

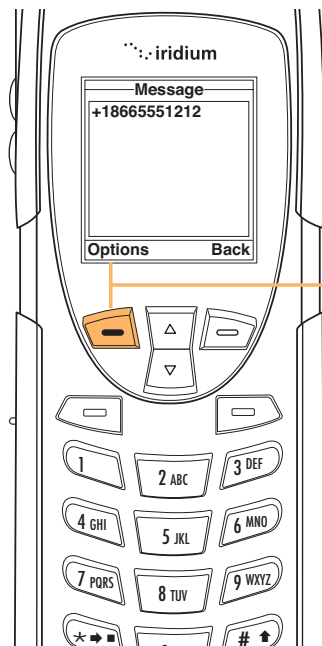

While reading the **Message screen**:

1. Press the **left** soft key labeled **Options**.







## Iridium 9555 Handset | 7 Using the Message Menu

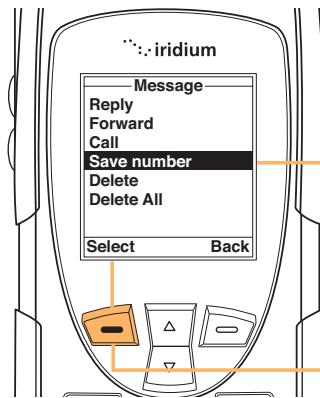

2. Use the **2-way navi-key** to scroll until **Save number** is highlighted.

3. Press the **left soft key**, labeled **Select**.

## Delete a Message

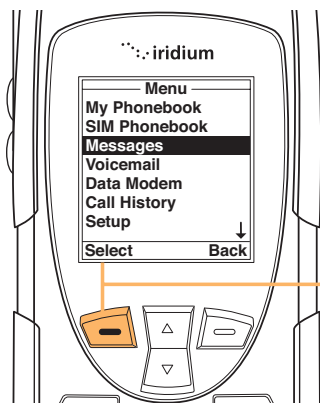

Start at the **Main Menu** with **Messages** highlighted:

1. Press the **left soft key**, labeled **Select**.

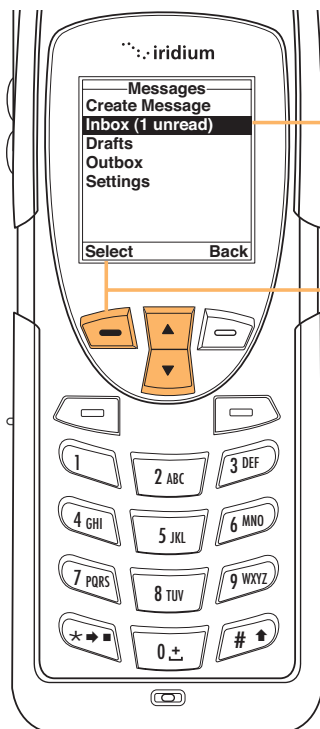

2. Use the **2-way navi-key** until **Inbox** is highlighted.

3. Press the **left soft key**, labeled **Select**.



## Iridium 9555 Handset | 7 Using the Message Menu

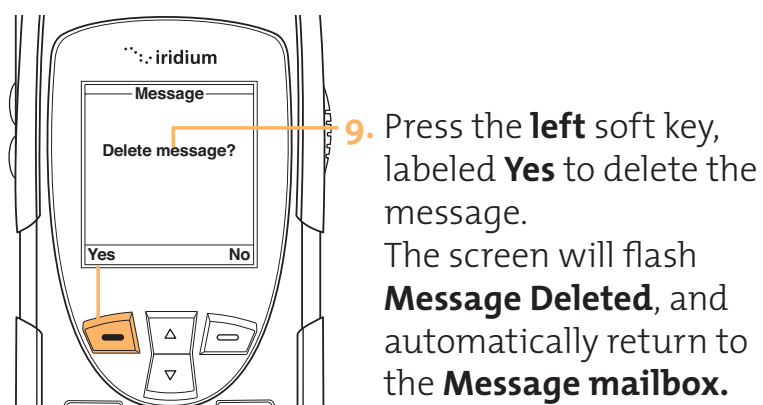
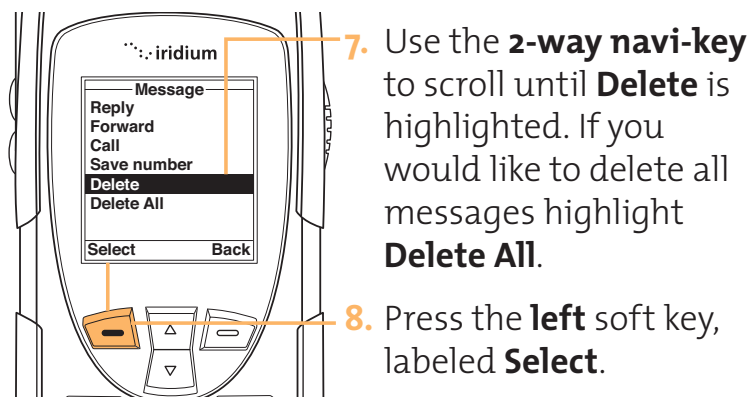
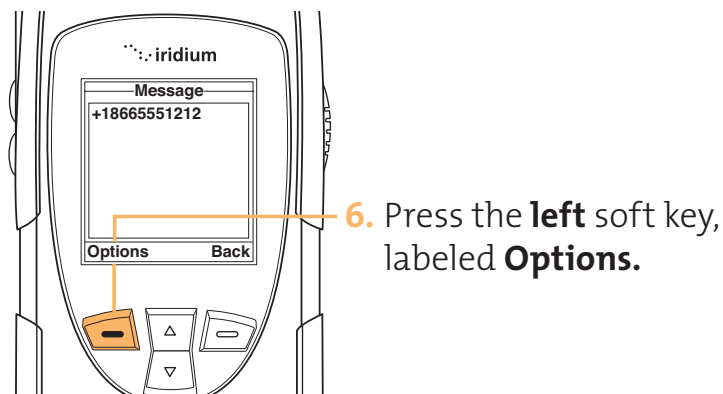
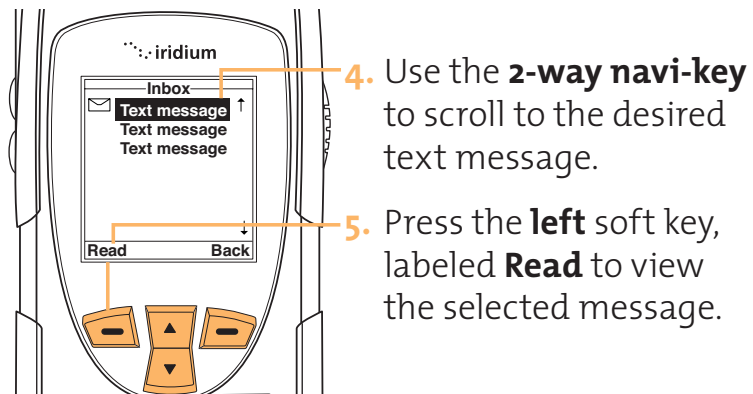



## Iridium 9555 Handset | 7 Using the Message Menu

### Using the Drafts Menu

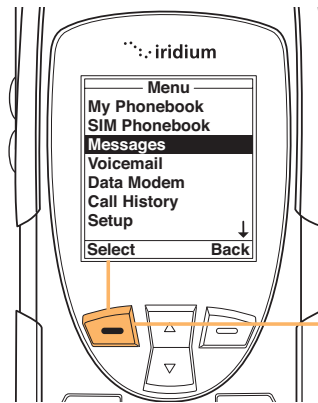

To edit and send a stored messages, use the Draft menu. Start at the **Main Menu** with **Messages** highlighted:

1. Press the **left soft key**, labeled **Select**.

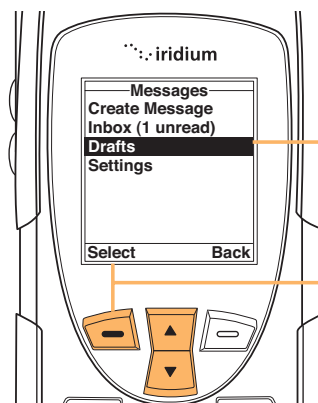

2. Use the **2-way navi-key** to scroll until the **Drafts** option is highlighted.

3. Press the **left soft key**, labeled **Select**.

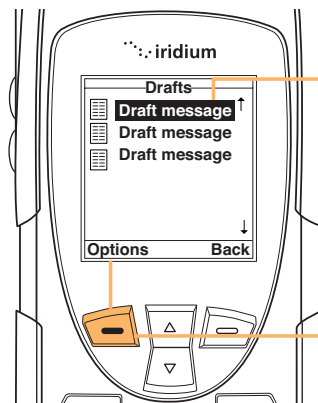

4. Use the **2-way navi-key** to scroll until the draft message you wish to send is highlighted.

5. Press the **left soft key**, labeled **Options**.

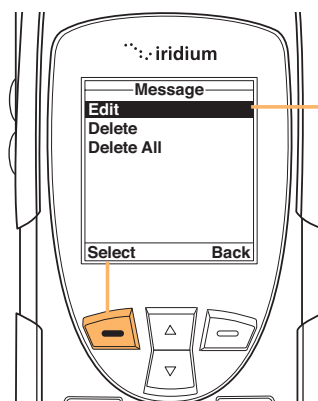

6. Highlight **Edit** and press **left soft key** labeled **Select**.



## Iridium 9555 Handset | 7 Using the Message Menu

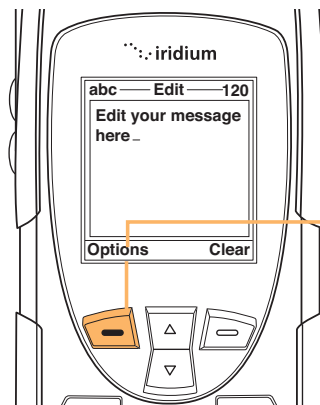

7. When you are finished editing press the **left** soft key, labeled **Options**.

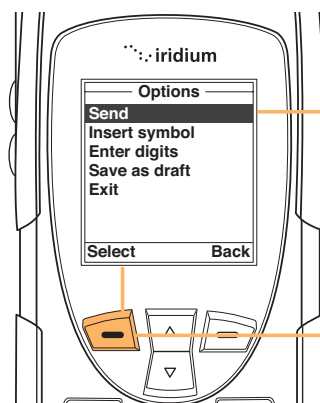

8. The **Send** option should be highlighted, if not use the 2-way navi-key to scroll until it is highlighted.
9. Press the **left** soft key, labeled **Select** to send the message.

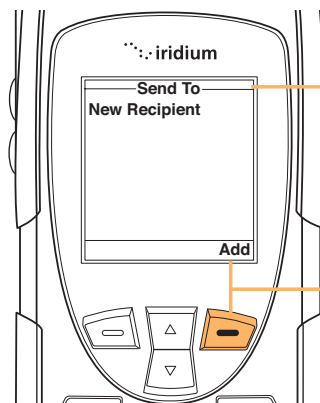

10. A **Send To** screen will appear with the entry name and number.
11. Press the **right** soft key, labeled **Add**.

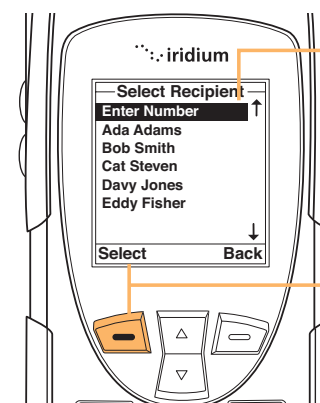

12. Use the **2-way navi-key** until the desired recipient from your Phonebook is highlighted.
13. Press the **left** soft key labeled **Options**.



## Iridium 9555 Handset | 7 Using the Message Menu

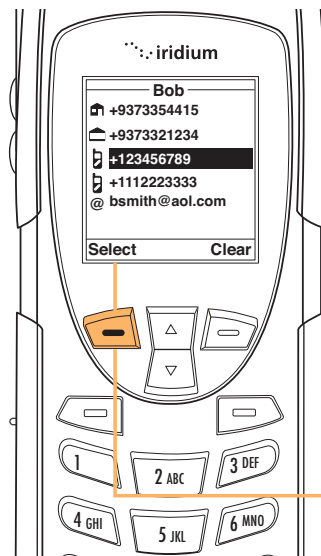

14. If the recipient has more than one number listed, the recipient's information screen will appear. Use the **2-way navi-key** to scroll to the desired number you would like to forward to.

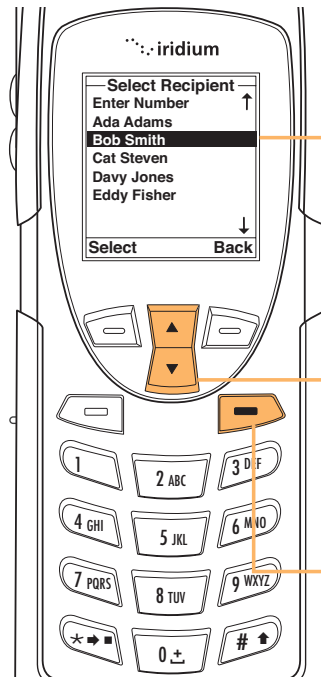

15. Press the **left** soft key labeled **Select**. The number will be added to a recipient list.

16. The Phonebook screen will appear with the recipient's name highlighted. To add another recipient, using the **two-way navi-key**, highlight the next recipient and repeat step 12.

17. Once all recipients have been selected, press the **right** soft key **Back**.

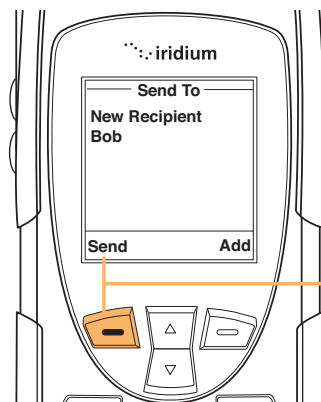

18. Press the **left** soft key labeled **Send**.





## Iridium 9555 Handset | 7 Using the Message Menu

### Using the Settings Menu

#### Enter Service Center Number

Use this feature to enter the number for the service center that forwards your outgoing messages. You must specify a service center number before you can send any messages or receive new voicemail notifications.

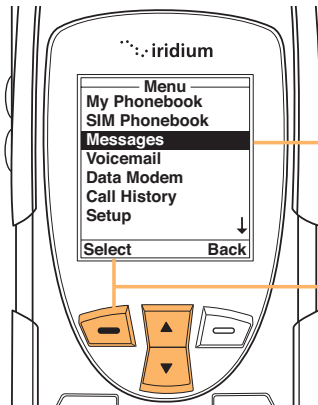

1. Start at the **Main Menu** with **Messages** highlighted:

2. Press the **left soft key** labeled **Select**.

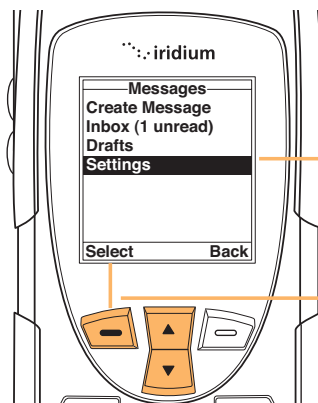

3. Use the **2-way navi-key** to scroll until **Settings** is highlighted.

4. Press the **left soft key**, labeled **Select**.

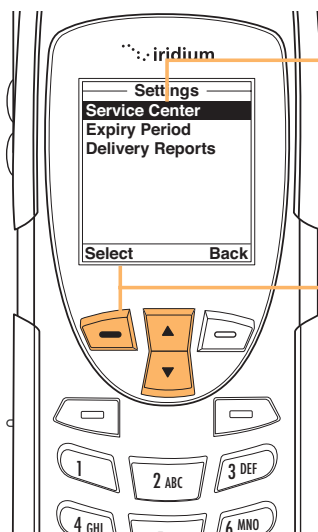

5. The **Service Center** option should be highlighted, if not use the **2-way navi-key** until it is highlighted.

6. Press the **left soft key**, labeled **Select**.





## Iridium 9555 Handset | 7 Using the Message Menu

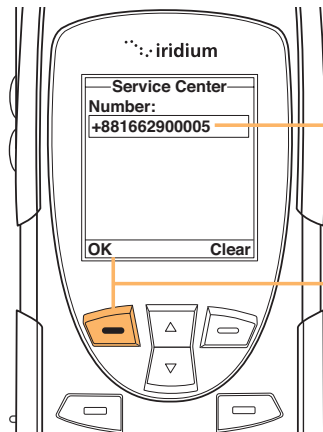

7. Enter the service number.

8. Press the **left** soft key, labeled **OK**. The screen will then return to the Settings menu.

## Set Expiry Period

Use this feature to specify the amount of time you would like your messages stored.

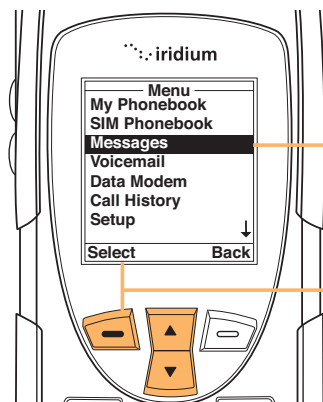

1. Start at the **Main Menu** with **Messages** highlighted:

2. Press the **left** soft key labeled **Select**.

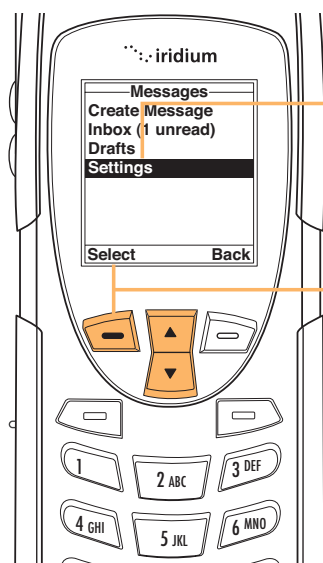

3. Use the **2-way navi-key** to scroll until **Settings** is highlighted.

4. Press the **left** soft key, labeled **Select**.



## Iridium 9555 Handset | 7 Using the Message Menu

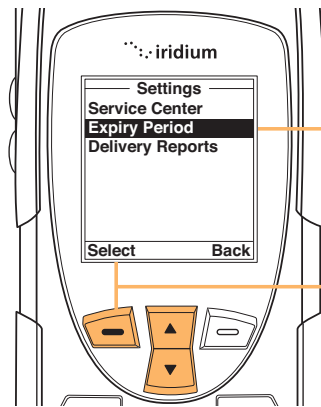

5. Use the **2-way navi-key** to scroll until **Expiry Period** is highlighted.

6. Press the **left** soft key, labeled **Select**.

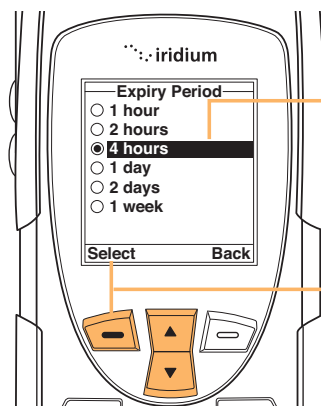

7. Use the **2-way navi-key** to scroll until the desired period of time is highlighted.

8. Press the **left** soft key, labeled **Select**. The screen will then return to the Settings menu.

### Select Delivery Reports

Use this feature to enable or disable message delivery reports.

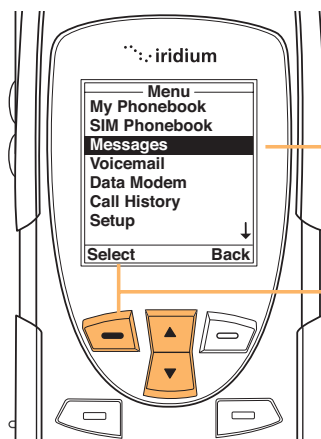

1. Start at the **Main Menu** with **Messages** highlighted.

2. Press the **left** soft key labeled **Select**.





## Iridium 9555 Handset | 7 Using the Message Menu

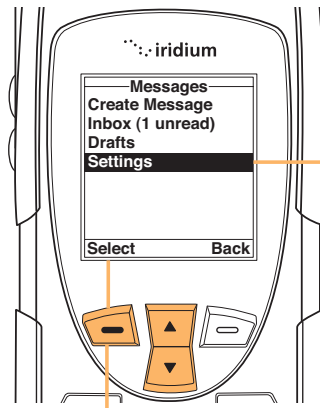

3. Use the **2-way navi-key** to scroll until **Settings** is highlighted.

4. Press the **left** soft key, labeled **Select**.

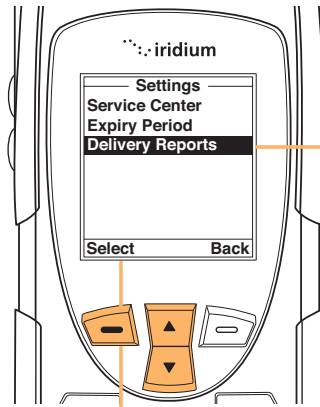

5. Use the **2-way navi-key** to scroll until **Delivery Reports** is highlighted.

6. Press the **left** soft key, labeled **Select**.

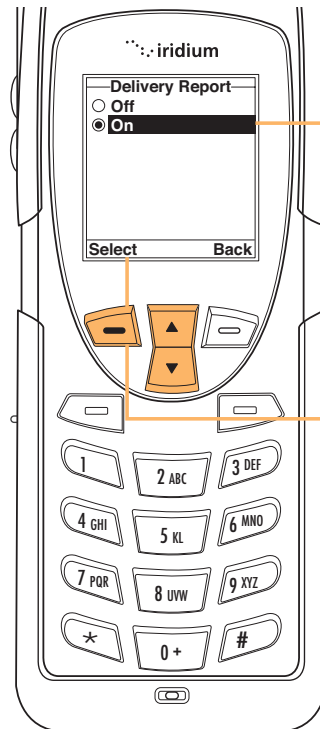

7. Use the **2-way navi-key** to turn the Delivery Report **Off** or **On**.

8. Press the **left** soft key, labeled **Select**. The screen will then return to the Settings menu.







# 8 | Using the Voicemail Menu

## Locating the Voicemail Menu

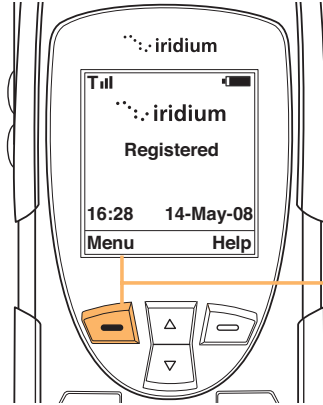

Starting from the **Main Screen:**

1. Press the **left** soft key labeled **Menu**.

**Note:** All instructions for the Voicemail Menu will start from the **Main Menu** as shown.

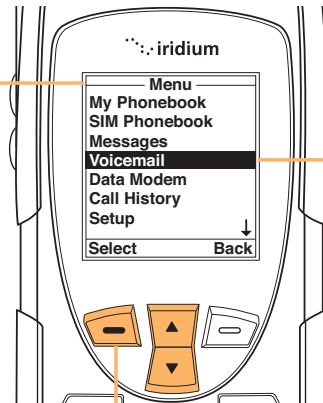

2. The **Main Menu** will now be displayed. Use the **2-way navi-key** to scroll until **Voicemail** is highlighted.

3. Press the **left** soft key labeled **Select**.

## About the Voicemail Menu

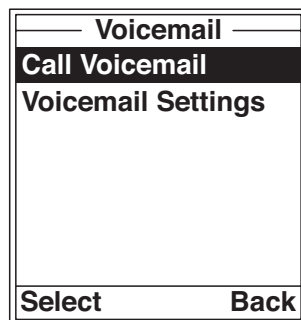

You will be able to perform the following functions using the **Voicemail** Menu.

- Listen to your voicemail
- Reply to a voicemail
- Store voicemail numbers
- Access and configure your voicemail account





## Iridium 9555 Handset | 8 Using the Voicemail Menu

### Voicemail Notification

When you receive a voicemail, an incoming voicemail notification message automatically scrolls across your screen.

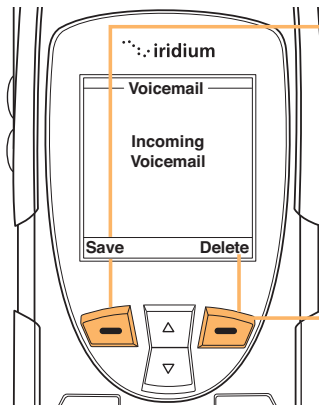

Press the **left** soft key, labeled **Save** to store the voicemail to the SIM card.

OR

Press the **right** soft key, labeled **Delete**.

### Check Your Voicemail

To listen to a voicemail that has been saved:

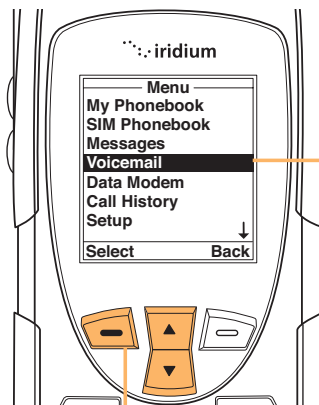

1. Use the **2-way navi-key** to scroll until **Voicemail** is highlighted.

2. Press the **left** soft key labeled **Select**.

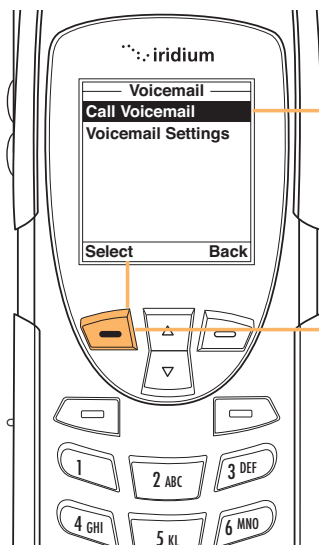

3. **Call Voicemail** will be highlighted.

4. Press the **left soft** key, labeled **Select**.

Follow the audio prompts for additional features.





## Iridium 9555 Handset | 8 Using the Voicemail Menu

### Store Your Voicemail Number

If you have not previously stored a voicemail number, then you will see **No Number Available on the display**. You must store a voicemail number before you can access the service for the first time.

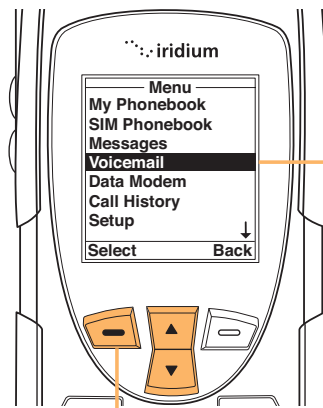

1. Use the **2-way navi-key** to scroll until **Voicemail** is highlighted.

2. Press the **left** soft key labeled **Select**.

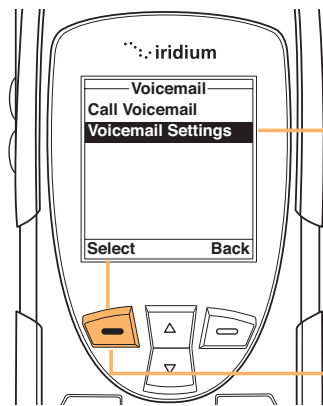

3. Use the **2-way navi-key** to scroll until **Voicemail Settings** is highlighted.

4. Press the **left** soft key labeled **Select**.

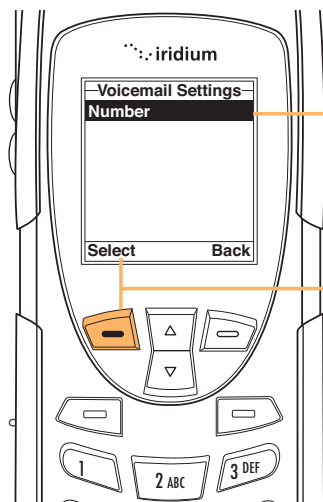

5. The **Number** option will be highlighted.

6. Press the **left** soft key, labeled **Select**.



## Iridium 9555 Handset | 8 Using the Voicemail Menu

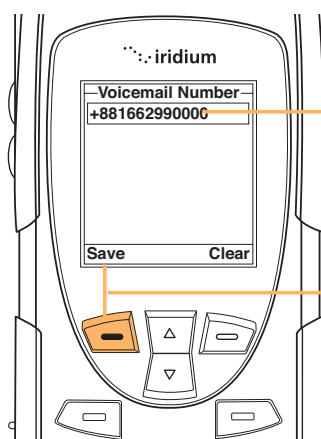

7. Enter the voicemail number given to you by your Service Provider.

8. Press the **left** soft key, labeled **Save**.

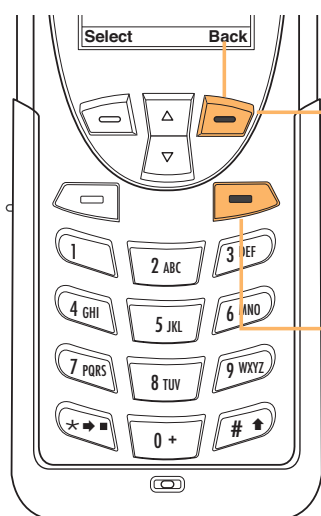

9. Press the **right** soft key, labeled **Back** to return to the previous menu.

Press the **red** key to exit to the **Main screen**.



# 9 | Using the Data Modem Menu

To Locate the Data Modem Menu

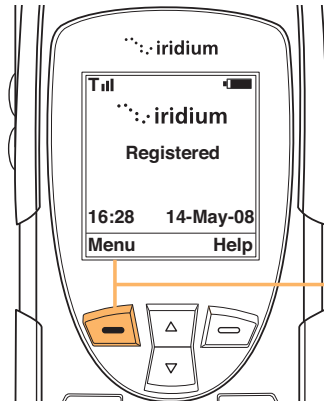

Starting from the **main screen**:

1. Press the **left** soft key labeled **Menu**.

**Note:** All instructions for the Data Modem Menu will start from the **Main Menu** as shown.

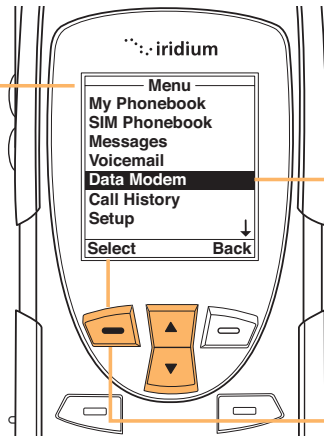

2. The **Main Menu** will now be displayed. Use the **2-way navi-key** to scroll until **Data Modem** is highlighted.
3. Press the **left soft** key, labeled **Select**.

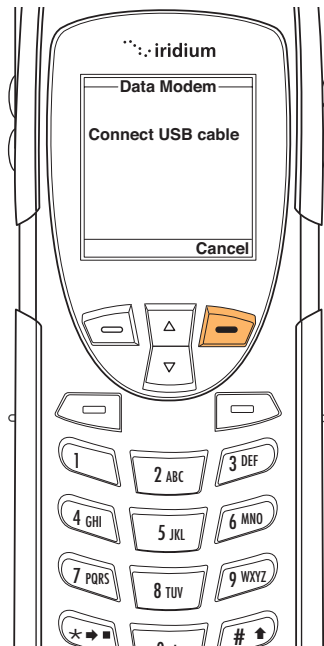

**Note:** If you are not connected to the USB cable you will be prompted to connect. While connected to the USB cable it is important to not remove the battery. If you need to remove the battery, first disconnect from the USB cable, power down the handset and then remove the battery.









# 10 | Using the Call History Menu

## Locating the Call History Menu

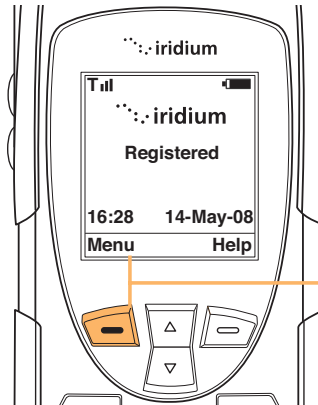

Starting from the **main screen**:

1. Press the **left** soft key labeled **Menu**.

### Note:

All instructions for the Call History menu will start from the **Main Menu** as shown.

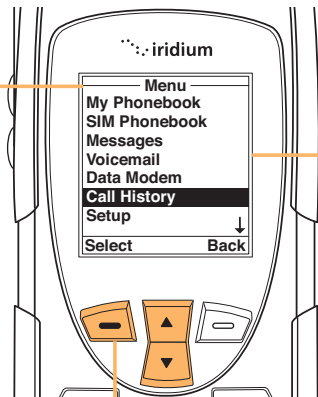

2. The **Main Menu** will now be displayed. Use the **2-way navi-key** to scroll until **Call History** is highlighted.

3. Press the **left** soft key labeled **Select**.

## About the Call History Menu

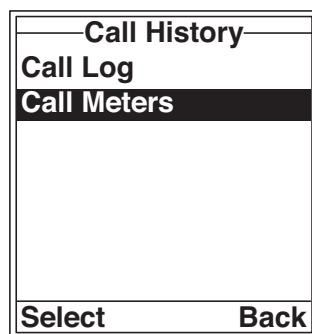

You will be able to perform the following functions using the **Call History** menu.

- View the amount of time spent talking on your phone
- View your most recent dialed, missed and received calls
- Set phone alerts



## Using the Call Log Menu

### View Most Recent Received Calls

Your phone saves received calls. Use the Call Log menu to view those numbers.

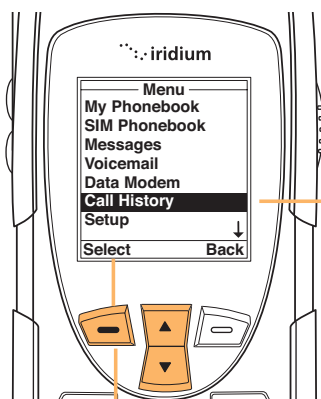

1. Use the **2-way navi-key** until **Call History** is highlighted.

2. Press the **left soft** key labeled **Select**.

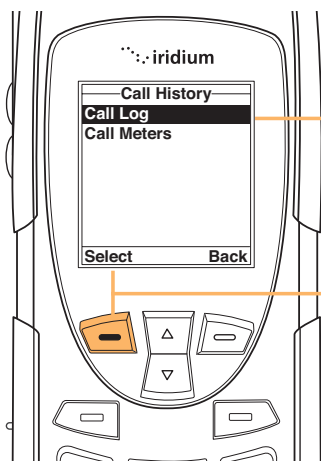

3. The **Call History** menu will now be displayed with **Call Log** highlighted.

4. Press the **left soft** key labeled **Select**.

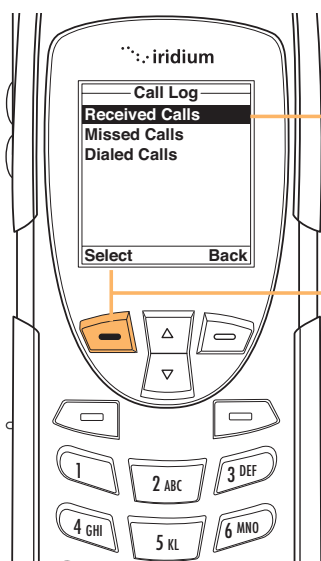

5. The **Call Log** menu will now be displayed. **Received Calls** will be highlighted.

6. Press the **left soft** key labeled **Select**.



## Iridium 9555 Handset | 10 Using the Call History Menu

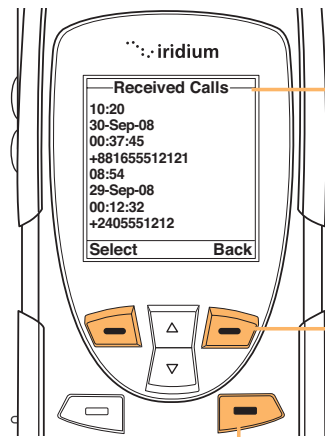

7. The **Received Calls** menu will now be displayed with a list of your last ten calls.

Press the **right** soft key labeled **Back** to go back one level, or the **red** key to return the Main screen.

### View Missed Calls

Your phone saves calls you've missed when your phone is busy or were not able to get to your phone. Your phone will not show calls that you missed when the phone is turned off or not registered on the network.

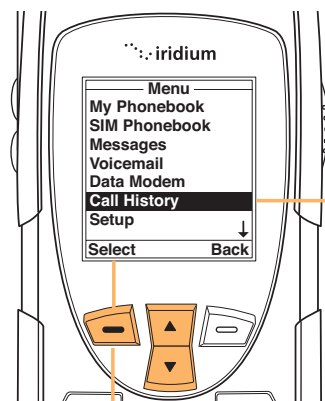

1. Use the **2-way navi-key** until **Call History** is highlighted.

2. Press the **left soft** key labeled **Select**.

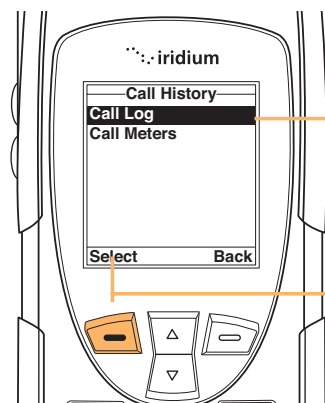

3. The **Call History** menu will now be displayed with **Call Log** highlighted.

4. Press the **left soft** key labeled **Select**.



## Iridium 9555 Handset | 10 Using the Call History Menu

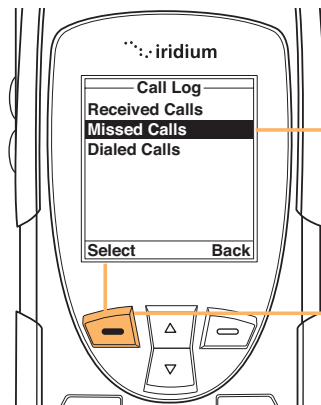

5. Using the 2-way navi-key scroll until **Missed Calls** is highlighted.

6. Press the **left** soft key labeled **Select**.

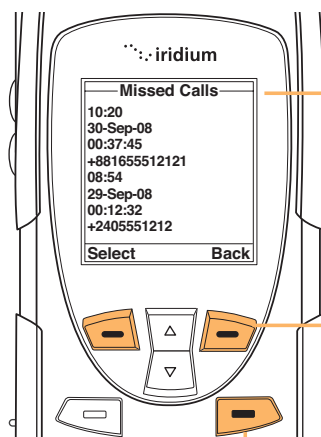

7. The **Missed Calls** menu will now be displayed with a list of your last missed calls.

Press the **right** soft key labeled **Back** to go back one level, or the **red** key to return the Main screen.

### View Most Recent Dialed Calls

Your phone saves the last ten calls dialed. Use the Call Log menu to view those numbers.

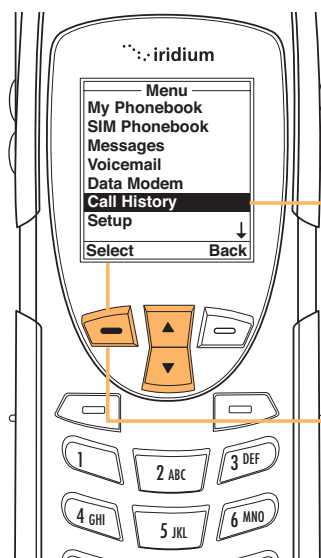

1. Use the **2-way navi-key** until **Call History** is highlighted.

2. Press the **left soft** key labeled **Select**.

Iridium 9555 Handset | 10 Using the Call History Menu

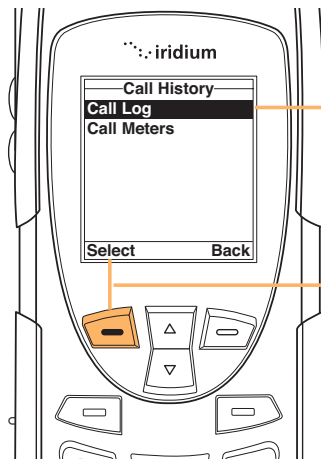

- 3. The **Call History** menu will now be displayed with **Call Log** highlighted.
- 4. Press the **left** soft key labeled **Select**.

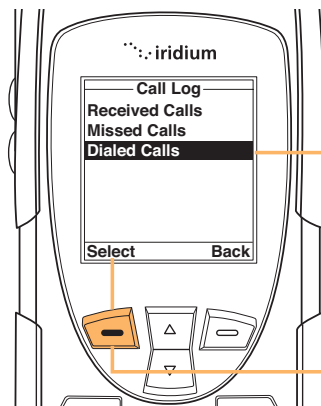

- 5. The **Call Log** menu will now be displayed. Using the **2-way navi-key** scroll to **Dialed Calls**.
- 6. Press the **left** soft key labeled **Select**.

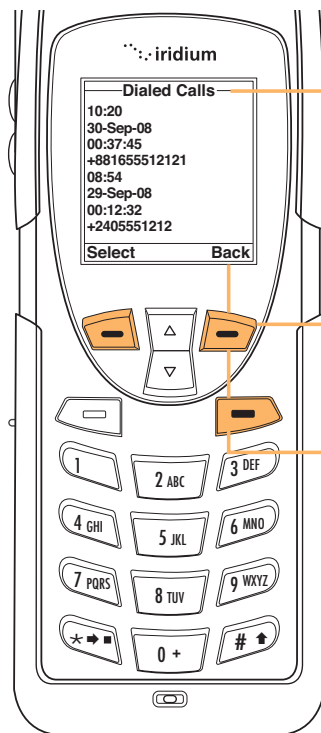

- 7. The **Dialed Calls** menu will now be displayed with a list of your last ten calls.
- Press the **right** soft key labeled **Back** to go back one level, or the **red** key to return the Main screen.



## Iridium 955 Handset | 10 Using the Call History Menu

### Using the Call Meters Menu

Call meters help you track your airtime. Keep a running tab of your monthly usage or view the air time of your most recent calls.

### Show the Time of Last Call

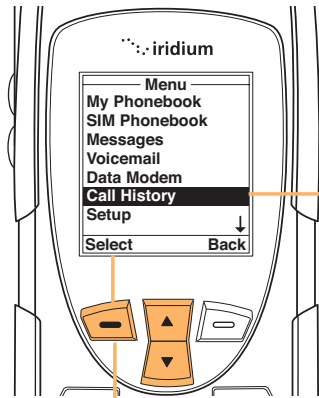

Starting from the **Main Menu**:

1. Use the **2-way navi-key** until **Call History** is highlighted.

2. Press the **left soft key** labeled **Select**.

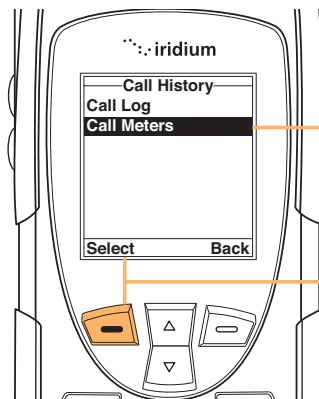

3. Use the **2-way navi-key** until **Call Meters** is highlighted.

4. Press the **left soft key** labeled **Select**.

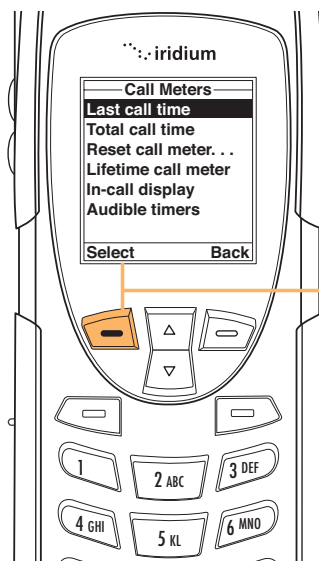

5. **Last call time** will be highlighted. If not use the **2-way Navi-key** until it is.

6. Press the **left soft key**, labeled **Select**.





## Iridium 9555 Handset | 10 Using the Call History Menu

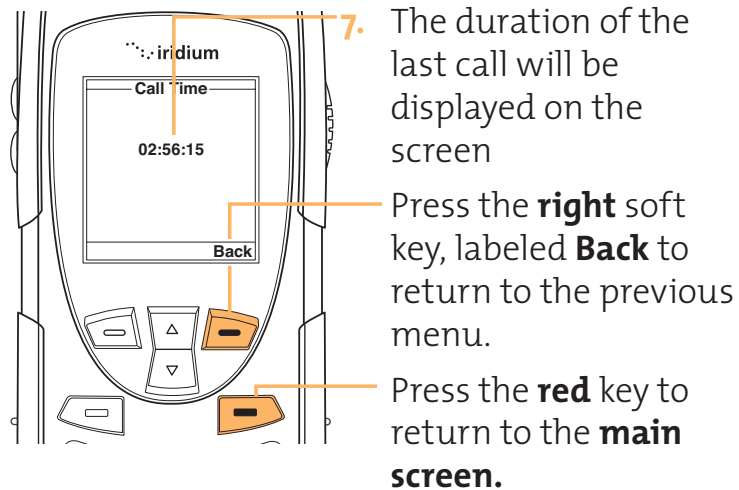

**Note:** The last call timer shows elapsed time of the most recent call made since your phone was turned on. This information is not saved when you turn off the phone.

### Show Total Time for All Calls

This feature displays your total airtime since you last reset the Call timer.

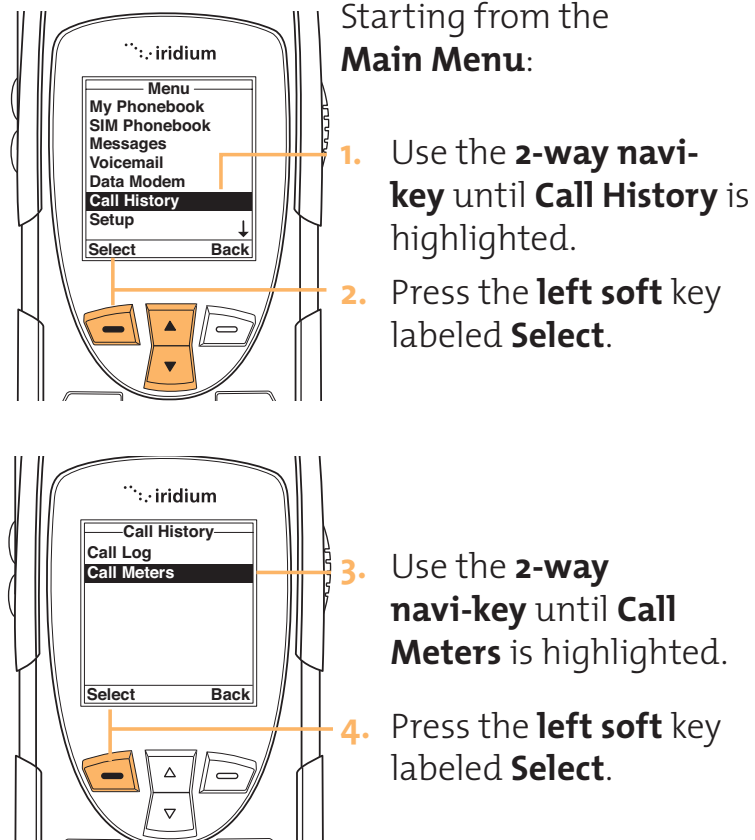

## Iridium 955 Handset | 10 Using the Call History Menu

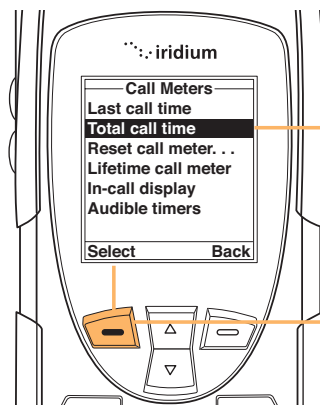

5. Use the **2-way Navi-key** to scroll until **Total Call Time** is highlighted.

6. Press the **left soft key** labeled **Select**.

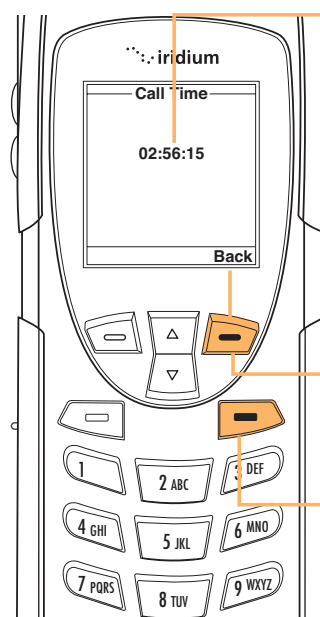

7. The airtime accumulation since the timer was last reset will be displayed on the screen.

Press the **right soft key**, labeled **Back** to return to the previous menu.

Press the **red key** to return to the **main screen**.

### Reset all Timers

Reset your timers at the beginning of each billing cycle to keep track of your spending.

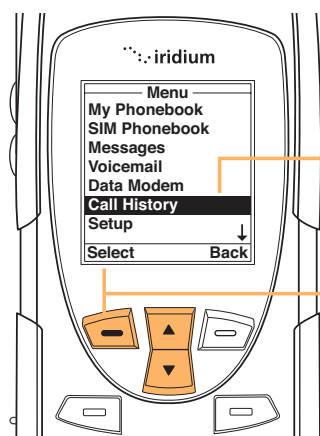

Starting from the **Main Menu**:

1. Use the **2-way navi-key** until **Call History** is highlighted.

2. Press the **left soft key** labeled **Select**.



Iridium 9555 Handset | 10 Using the Call History Menu

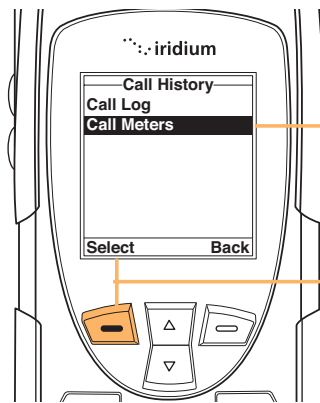

- 3. Use the **2-way navi-key** until **Call Meters** is highlighted.
- 4. Press the **left** soft key labeled **Select**.

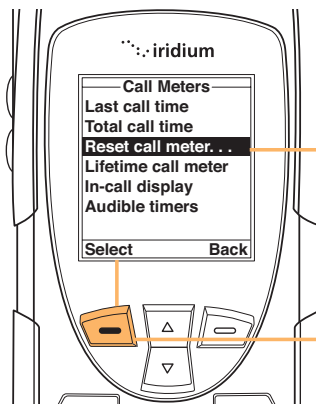

- 5. Use the **2-way Navi-key** to scroll until **Reset call meter** is highlighted.
- 6. Press the **left** soft key, labeled **Select**.

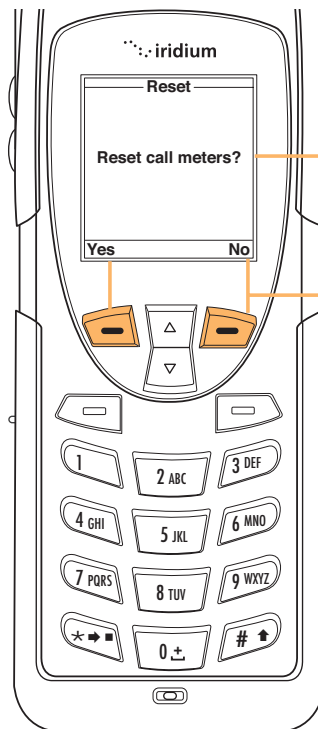

- 7. The screen will display: **Reset call meters?**
- 8. Press the **left** soft key for **Yes** or the **right** soft key for **No**.



## Iridium 955 Handset | 10 Using the Call History Menu

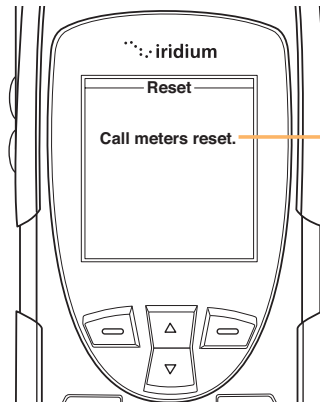

- 9. If you press **Yes**, the display will read **Call meters reset**.

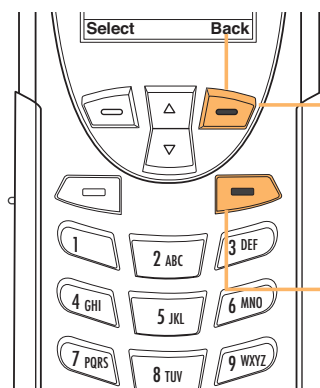

- 10. Press the **right** soft key, labeled **Back** to return to the previous menu.
- Press the **red** key to return to the **main screen**.

## Showing the Lifetime Call Timer

This feature displays a running clock of the total call time for the phone since being activated.

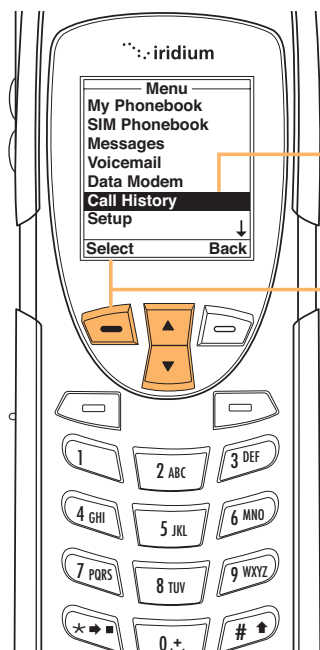

Starting from the **Main Menu**:

- 1. Use the **2-way navi-key** until **Call History** is highlighted.
- 2. Press the **left soft key** labeled **Select**.



## Iridium 9555 Handset | 10 Using the Call History Menu

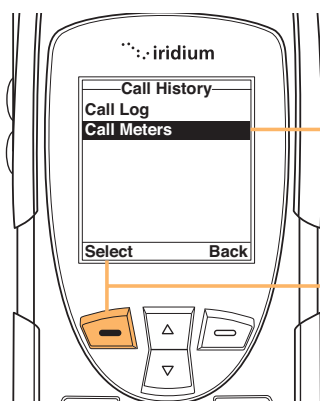

3. Use the **2-way navi-key** until **Call Meters** is highlighted.
4. Press the **left** soft key labeled **Select**.

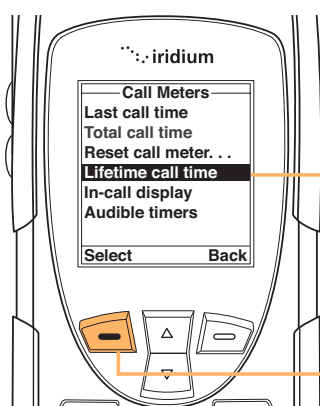

5. Use the **2-way navi-key** to scroll until **Lifetime call time** is highlighted.
6. Press the **left** soft key, labeled **Select**.

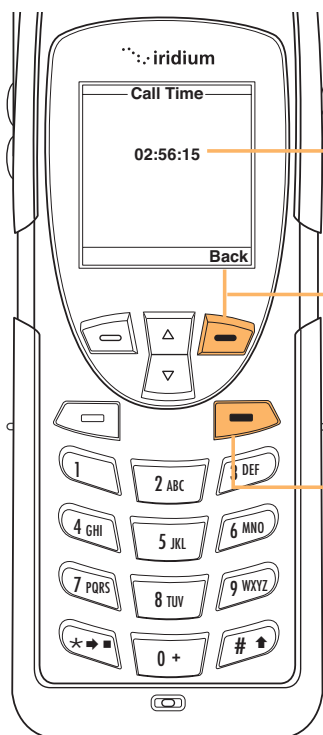

7. The total time of all calls will be displayed on the screen
- Press the **right** soft key, labeled **Back** to return to the previous menu.
- Press the **red** key to return to the **main screen**.

**Note:** The lifetime timer can not be reset.



## Iridium 9555 Handset | 10 Using the Call History Menu

### Showing the In-call Display

This feature enables or disables the call timer which displays the amount of time which has passed since placing a specific call.

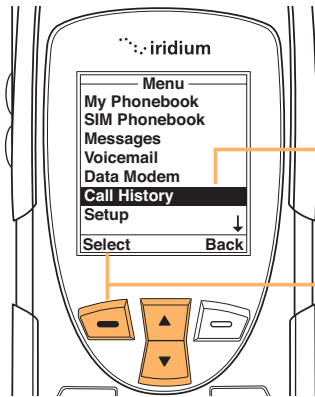

Starting from the **Main Menu**:

1. Use the **2-way navi-key** until **Call History** is highlighted.
2. Press the **left soft key** labeled **Select**.

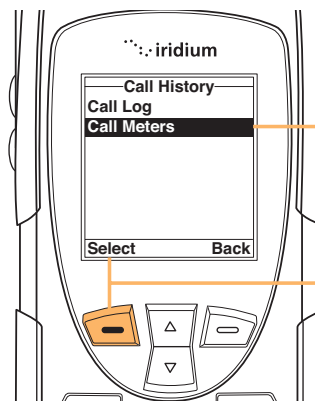

3. Use the **2-way navi-key** until **Call Meters** is highlighted.
4. Press the **left soft key** labeled **Select**.

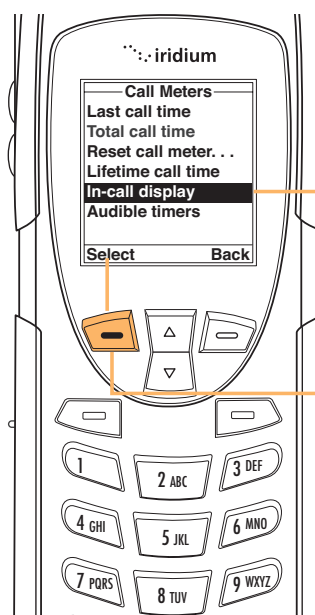

5. Use the **2-way navi-key** to scroll until **In-call display** is highlighted.
6. Press the **left soft key**, labeled **Select**.





## Iridium 9555 Handset | 10 Using the Call History Menu

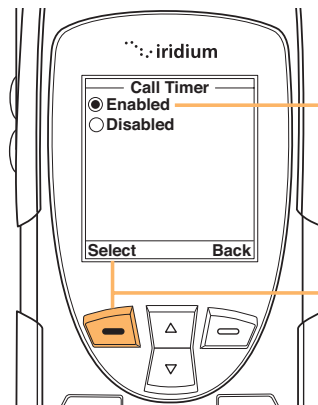

- 7. Use the **2-way navi-key** to scroll to **Enabled** or **Disabled**.
- 8. Press the **left soft key**, labeled **Select**.

### Setting Audible Call Timers

This feature lets the phone watch the clock for you. The call timers signal at a set time or interval with beeps only you can hear. You can choose No Alert, Single Alert, or Repetitive Alert.

### Set the Single Alert Timer

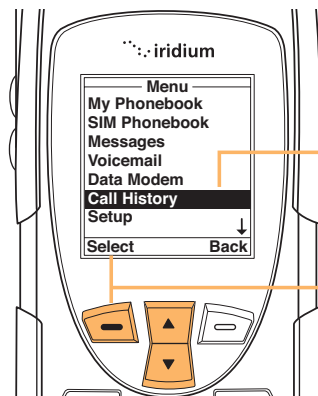

- Starting from the **Main Menu**:
- 1. Use the **2-way navi-key** until **Call History** is highlighted.
  - 2. Press the **left soft key** labeled **Select**.

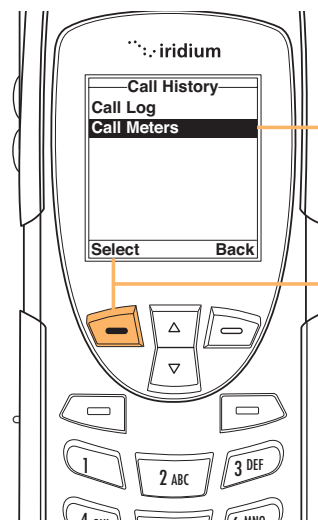

- 3. Use the **2-way navi-key** until **Call Meters** is highlighted.
- 4. Press the **left soft key** labeled **Select**.

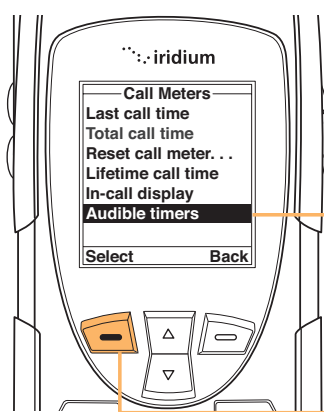
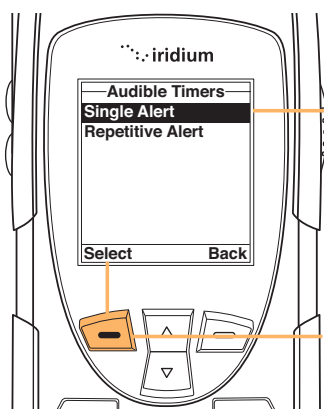
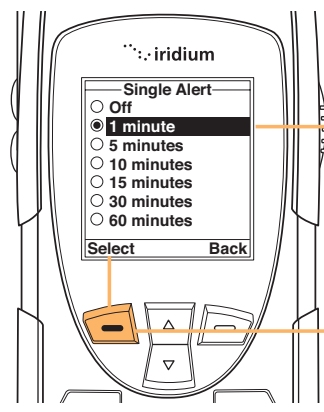
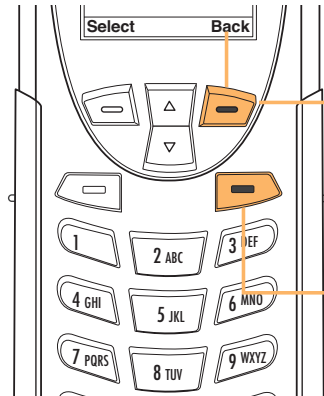

## Iridium 955 Handset | 10 Using the Call History Menu

- 
5. Use the **2-way Navi-key** to scroll until **Audible timers** is highlighted.
- 
6. Press the **left** soft key, labeled **Select**.
7. The **Single Alert** option should be highlighted, if not use the **2-way navi-key** to scroll until it is.
- 
8. Press the **left** soft key labeled **Select**.
9. Use the **2-way navi-key** to scroll to the desired single alert.
- 
10. Press the **left** soft key labeled **Select**.
11. Press the **right** soft key, labeled **Back** to return to the previous menu.
- Press the **red** key to exit to the **main screen**.



## Iridium 9555 Handset | 10 Using the Call History Menu

### Set the Repetitive Alert

This feature sets your phone to alert you at specific intervals, for example every 5 minutes.

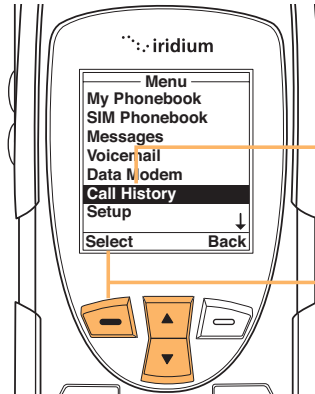

Starting from the **Main Menu**:

1. Use the **2-way navi-key** until **Call History** is highlighted.
2. Press the **left soft key** labeled **Select**.

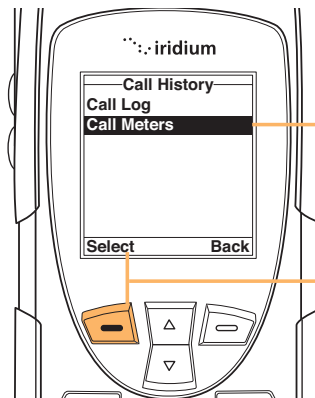

3. Use the **2-way navi-key** until **Call Meters** is highlighted.
4. Press the **left soft key** labeled **Select**.

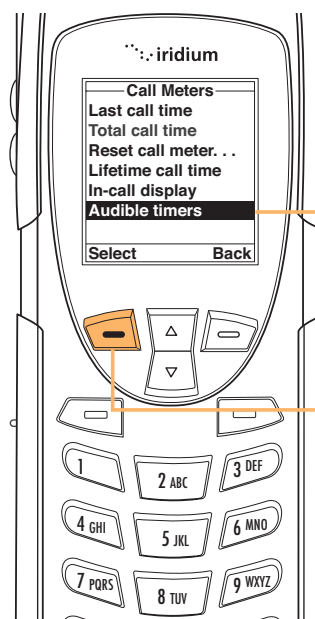

5. Use the **2-way Navi-key** to scroll until **Audible timers** is highlighted.
6. Press the **left soft key** labeled **Select**.



## Iridium 955 Handset | 10 Using the Call History Menu

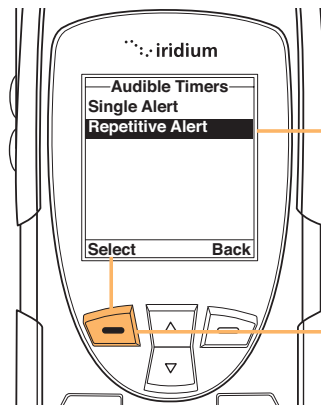

7. Use the **2-way navi-key** to scroll to The **Repetitive Alert** option.

8. Press the **left** soft key labeled **Select**.

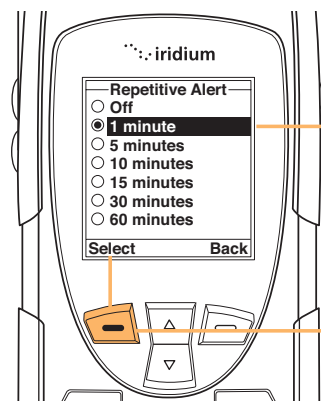

9. Use the **2-way navi-key** to scroll to the desired repetitive alert time.

10. Press the **left** soft key labeled **Select**.

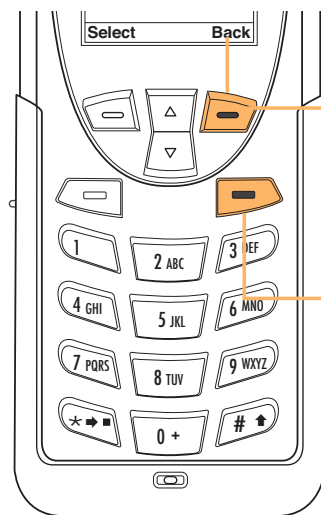

11. Press the **right** soft key, labeled **Back** to return to the previous menu.

Press the **red** key to exit to the **main screen**.



# 11 | Using the Setup Menu

## Locating the Setup Menu

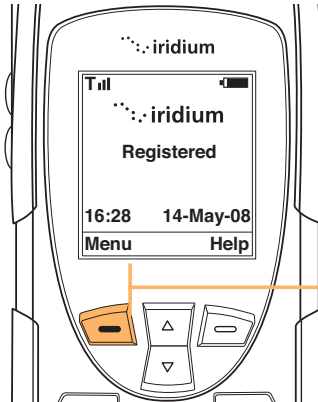

Starting from the **main screen**:

1. Press the **left** soft key labeled **Menu**.

**Note:** All instructions for the Setup menu will start from the **Main Menu** as shown.

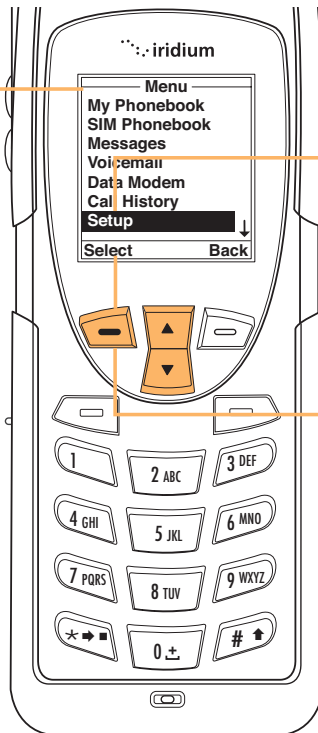

2. The **Main Menu** will now be displayed. Use the **2-way navi-key** to scroll until **Setup** is highlighted.

3. Press the **left** soft key labeled **Select**.



## Iridium 9555 Handset | 11 Using the Setup Menu

### About the Setup Menu

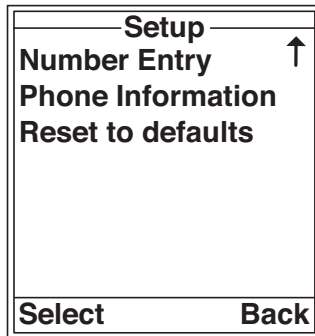
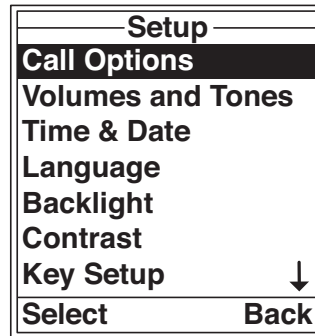

#### Note:

The Setup menu consists of two screens. Scroll past the Key setup for more menu options.

You will be able to perform the following functions using the **Setup** Menu.

- Set call options
- Set volumes and tones for your ringer speaker and alert.
- Set time zone, time and date format
- Set language
- Set your phone lighting preferences
- Set the contrast on the display screen
- Set preference for the convenience key and right soft key
- Set your prefix preference for entering phone numbers
- View phone information
- Reset phone settings to default





## Setting Call Options

The Call Options menu allows you to enable or disable various call features

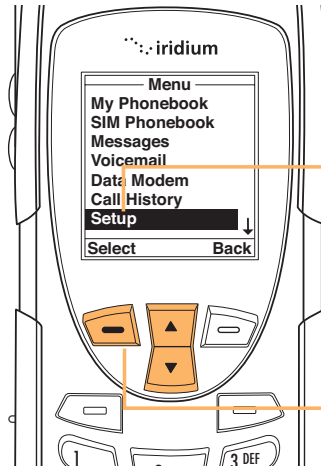

Starting from the **Main Menu:**

1. Use the **2-way navi-key** to scroll until **Setup** is highlighted.

2. Press the **left soft key** labeled **Select**.

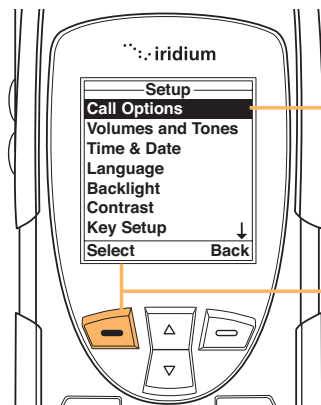

3. **Call Options** will already be highlighted.

4. Press the **left soft key** labeled **Select**.

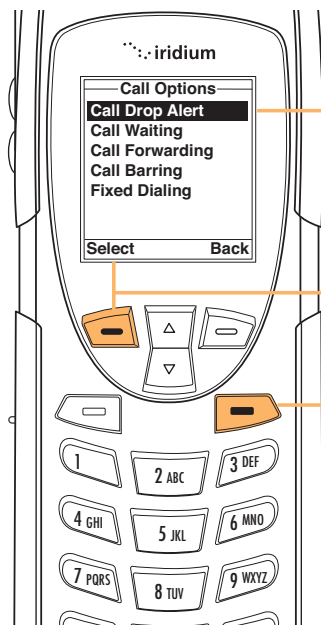

4. Highlight the call feature you would like to enable.

5. Press the **left soft key** labeled **Select**.

Press the **red key** to return to the **Main Screen**.





## Iridium 9555 Handset | 11 Using the Setup Menu

### Setting Volumes and Tones

#### Adjust the Ringer Volume

The Volumes and Tones menu allows you to adjust your phone's ringer volume and tone, and set the phone to ring or vibrate to notify you of incoming calls.

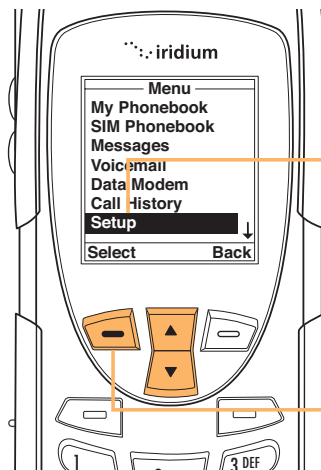

Starting from the **Main Menu**:

1. Use the **2-way navi-key** to scroll until **Setup** is highlighted.

2. Press the **left soft key** labeled **Select**.

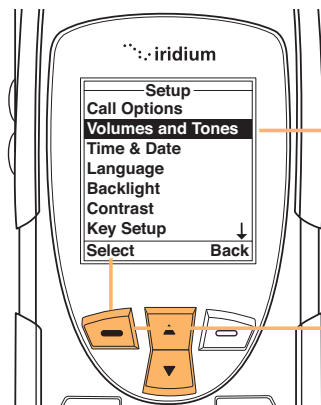

3. Use the **2-way navi-key** to scroll until **Volumes and Tones** is highlighted.

4. Press the **left soft key** labeled **Select**.

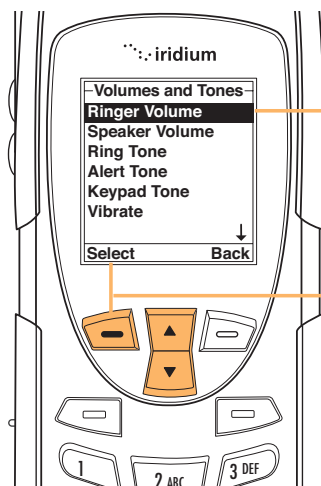

5. **Ringer Volume** will be highlighted. If not, use the **2-way navi-key** to scroll to it.

6. Press the **left soft key**, labeled **Select**.





## Iridium 9555 Handset | 11 Using the Setup Menu

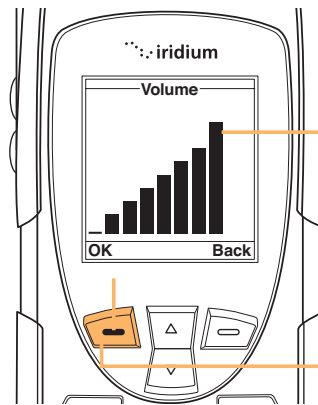

7. The volume bars will increase or decrease as you press the **2-way Navi-key** up or down.

8. Press the **left** soft key, labeled **OK** when you have the desired setting.

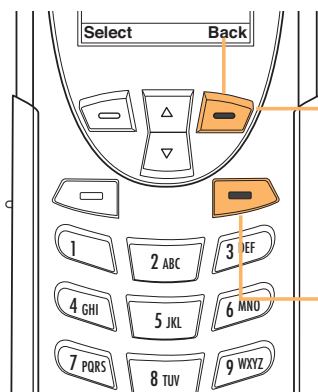

9. Press the **right** soft key, labeled **Back** to return to the previous menu.

Press the **red** key to exit to the **Main screen**.

### Adjust the Speaker Volume

This feature adjusts the volume of the speaker. The phone sounds the new volume level as you adjust it.

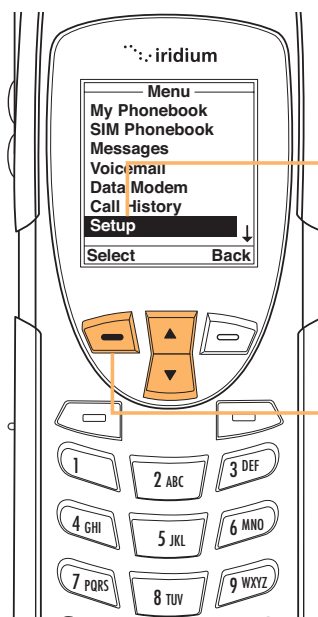

Starting from the **Main Menu**:

1. Use the **2-way navi-key** to scroll until **Setup** is highlighted.

2. Press the **left** soft key labeled **Select**.



## Iridium 9555 Handset | 11 Using the Setup Menu

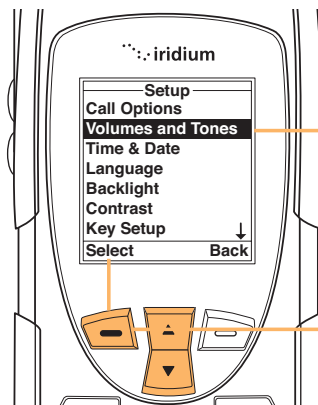

3. Use the **2-way navi-key** to scroll until **Volumes and Tones** is highlighted.

4. Press the **left soft** key labeled **Select**.

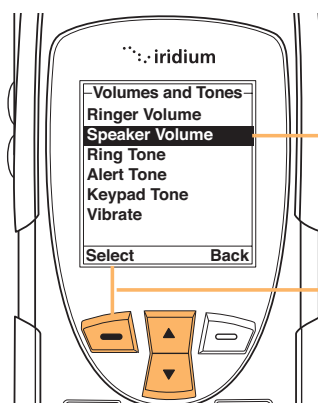

5. Use the **2-way Navi-key** to scroll to **Speaker Volume**.

6. Press the **left soft** key, labeled **Select**.

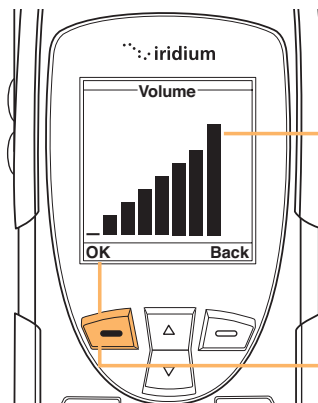

7. The volume bars will increase or decrease as you press the **2-way navi-key** up or down.

8. Press the **left soft** key, labeled **OK** when you have the desired setting.

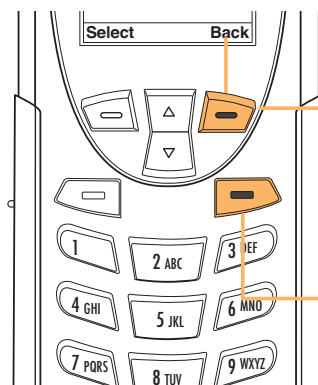

9. Press the **right soft** key, labeled **Back** to return to the previous menu.

Press the **red** key to exit to the **main screen**.



## Adjust the Ring Tone

This feature adjusts the tone of the ringer. The Phone sounds the new tone as you adjust it.

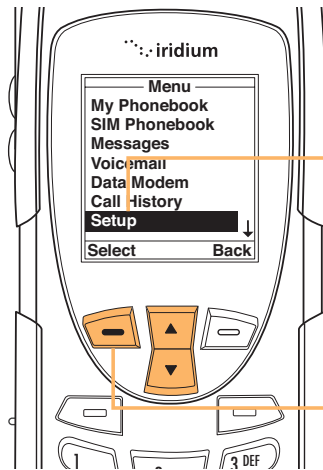

Starting from the **Main Menu:**

1. Use the **2-way navi-key** to scroll until **Setup** is highlighted.

2. Press the **left soft key** labeled **Select**.

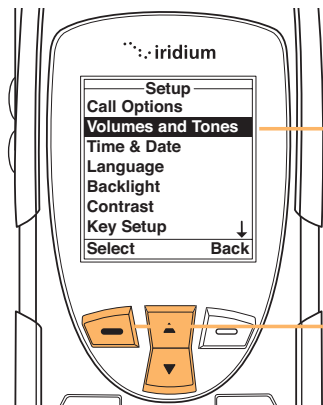

3. Use the **2-way navi-key** to scroll until **Volumes and Tones** is highlighted.

4. Press the **left soft key** labeled **Select**.

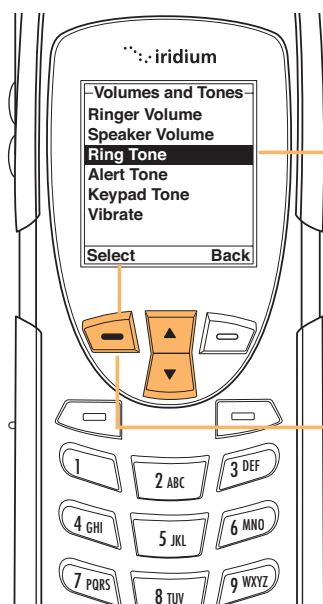

5. Use the **2-way Navi-key** to scroll until **Ring Tone** is highlighted.

6. Press the **left soft key**, labeled **Select**.



## Iridium 9555 Handset | 11 Using the Setup Menu

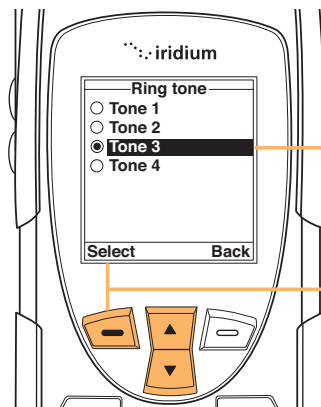

7. Use the **2-way navi-key** to scroll to the desired tone.
8. Press the **left soft key**, labeled **Select**.

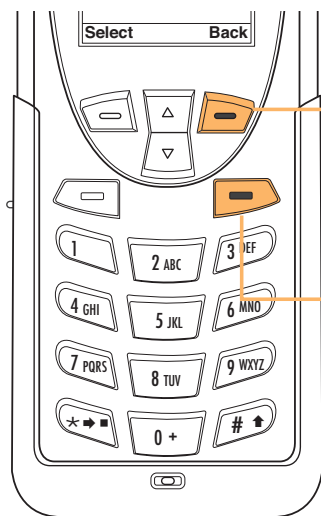

9. Press the **right soft key**, labeled **Back** to return to the previous menu.
- Press the **red key** to return to the **main screen**.

### Setting the Call Alert Mode

This feature adjusts the alert tone. The phone sounds the new tone as you adjust it.

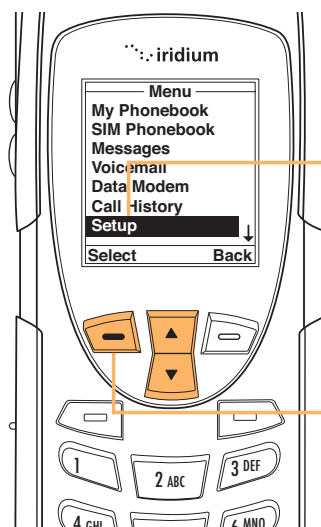

- Starting from the **Main Menu**:
1. Use the **2-way navi-key** to scroll until **Setup** is highlighted.
  2. Press the **left soft key** labeled **Select**.





## Iridium 9555 Handset | 11 Using the Setup Menu

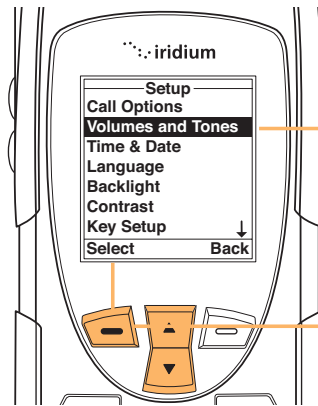

3. Use the **2-way navi-key** to scroll until **Volumes and Tones** is highlighted.

4. Press the **left soft key** labeled **Select**.

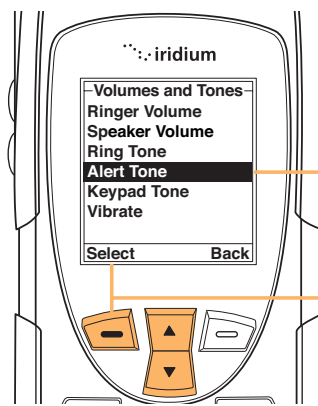

6. Use the **2-way Navi-key** to scroll to **Alert Tone**.

7. Press the **left soft key**, labeled **Select**.

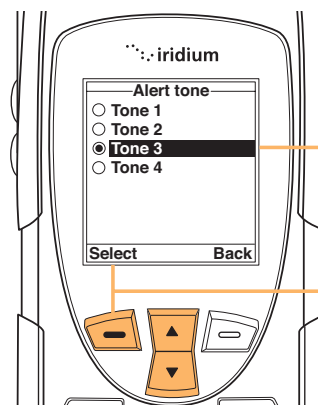

8. Use the **2-way navi-key** to scroll to the desired tone.

9. Press the **left soft key**, labeled **Select**.

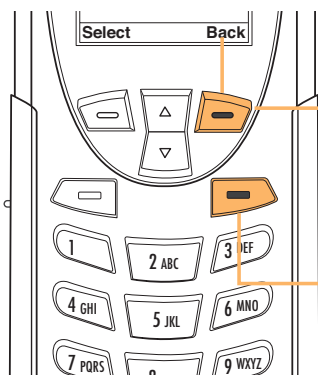

10. Press the **right soft key**, labeled **Back** to return to the previous menu.

Press the **red key** to exit to the **Main screen**.





## Iridium 9555 Handset | 11 Using the Setup Menu

### Setting the Keypad Tone

This feature selects the keypad tone. You can select to have a single tone, DTMF tones or no tones when the keypad is pressed.

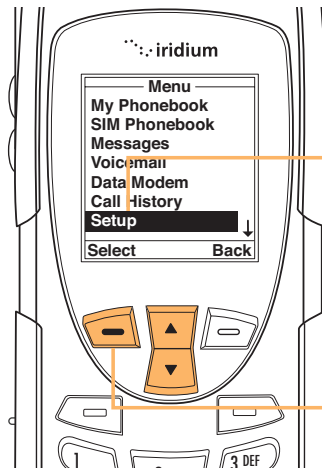

Starting from the **Main Menu:**

1. Use the **2-way navi-key** to scroll until **Setup** is highlighted.

2. Press the **left soft key** labeled **Select**.

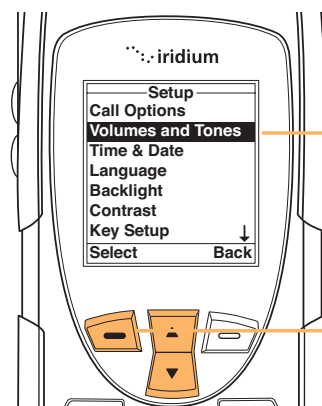

3. Use the **2-way navi-key** to scroll until **Volumes and Tones** is highlighted.

4. Press the **left soft key** labeled **Select**.

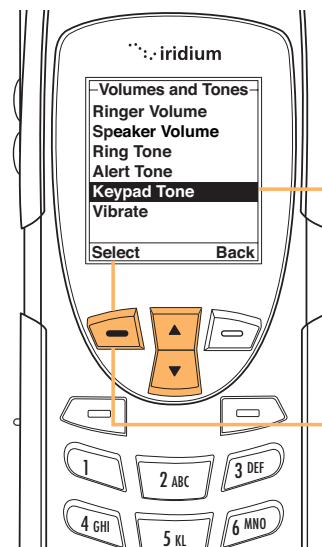

5. Use the **2-way Navi-key** to scroll to **Keypad Tone**.

6. Press the **left soft key** labeled **Select**.





## Iridium 9555 Handset | 11 Using the Setup Menu

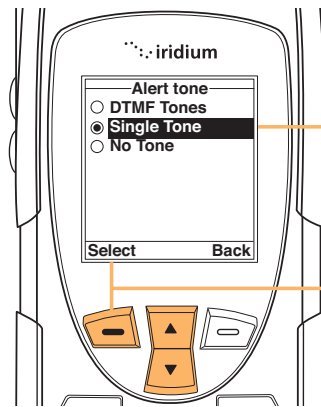

7. Use the **2-way navi-key** to scroll to the desired tone.

8. Press the **left soft key** labeled **Select**.

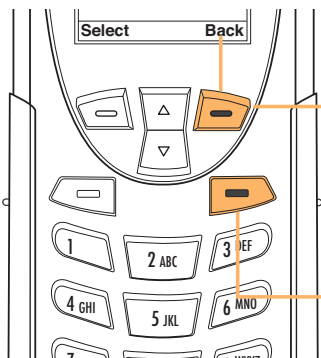

9. Press the **right soft key**, labeled **Back** to return to the previous menu.

Press the **red key** to exit to the **main screen**.

### Set the Phone to Ring and /or Vibrate

This feature is ideal for situations where a ringing phone is inappropriate or in a loud environment. The vibrate function notifies you of incoming calls by discreet vibrations.

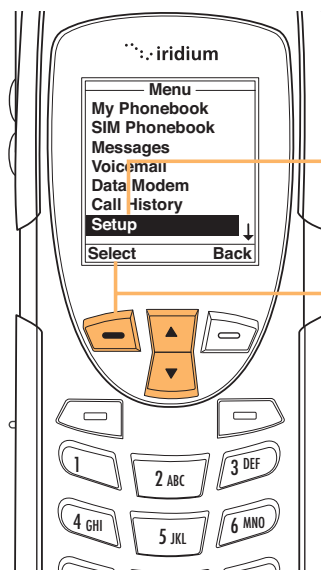

Starting from the **Main Menu**:

1. Use the **2-way navi-key** to scroll until **Setup** is highlighted.

2. Press the **left soft key** labeled **Select**.



## Iridium 9555 Handset | 11 Using the Setup Menu

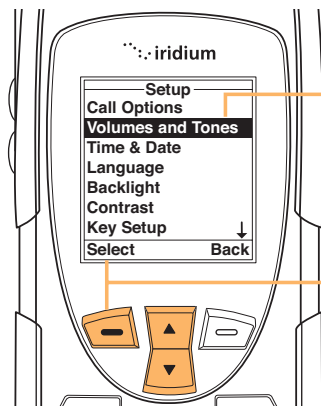

3. Use the **2-way navi-key** to scroll until **Volumes and Tones** is highlighted.

4. Press the **left soft** key labeled **Select**.

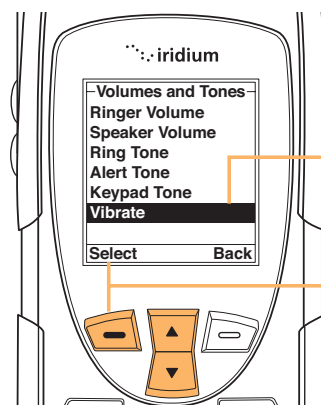

5. Use the **2-way Navi-key** to scroll to **vibrate**.

6. Press the **left soft** key, labeled **Select**.

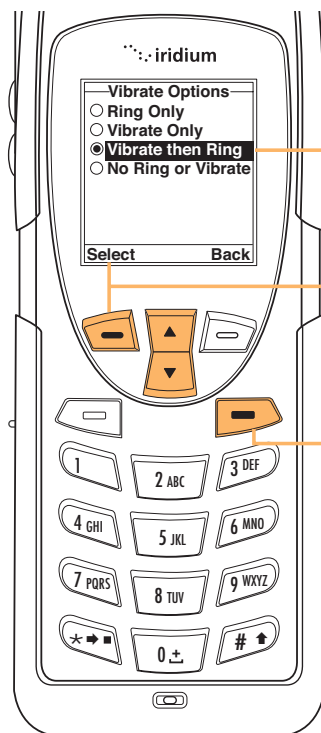

7. Use the **2-way navi-key** to scroll to the desired vibrate option.

8. Press the **left soft** key, labeled **Select**.

Press the **red** key to exit to the **main screen**.



## Time and Date Settings

### Select the Time Zone

Your phone uses the satellite network to obtain the time and date information, however, you need to select the time zone in which you are located.

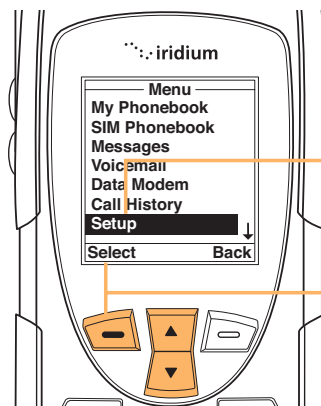

Starting from the **Main Menu:**

1. Use the **2-way navi-key** to scroll until **Setup** is highlighted.
2. Press the **left** soft key labeled **Select**.

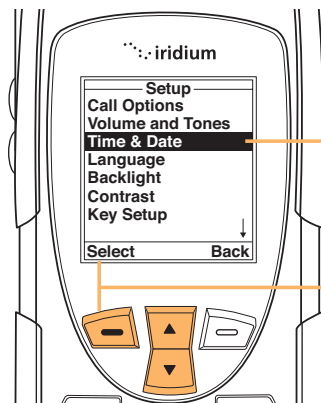

3. Use the **2-way navi-key** until **Time & Date** is highlighted.
4. Press the **left** soft key labeled **Select**.

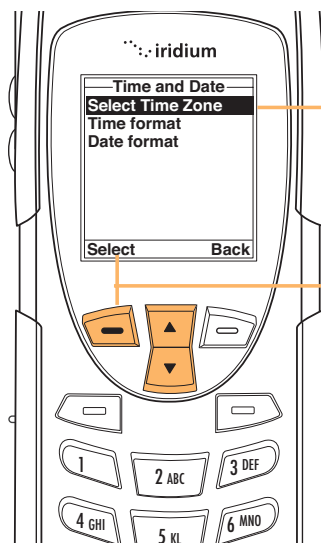

5. Use the **2-way navi-key** until **Select Time Zone** is highlighted.
6. Press the **left** soft key labeled **Select**.



## Iridium 9555 Handset | 11 Using the Setup Menu

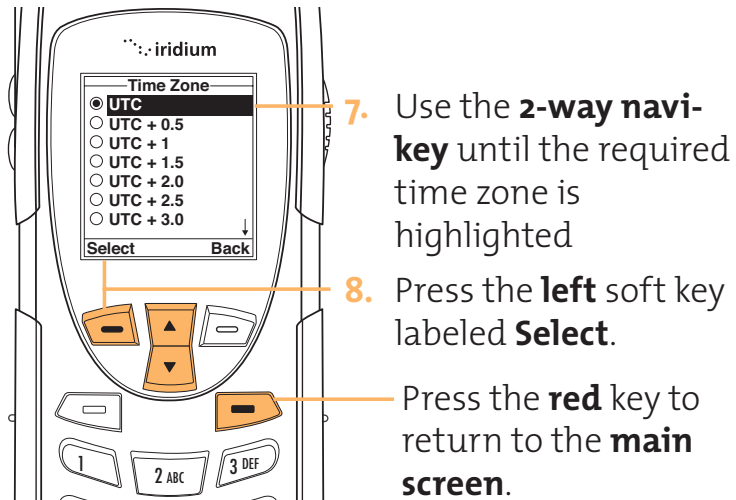

### Select the Time Format

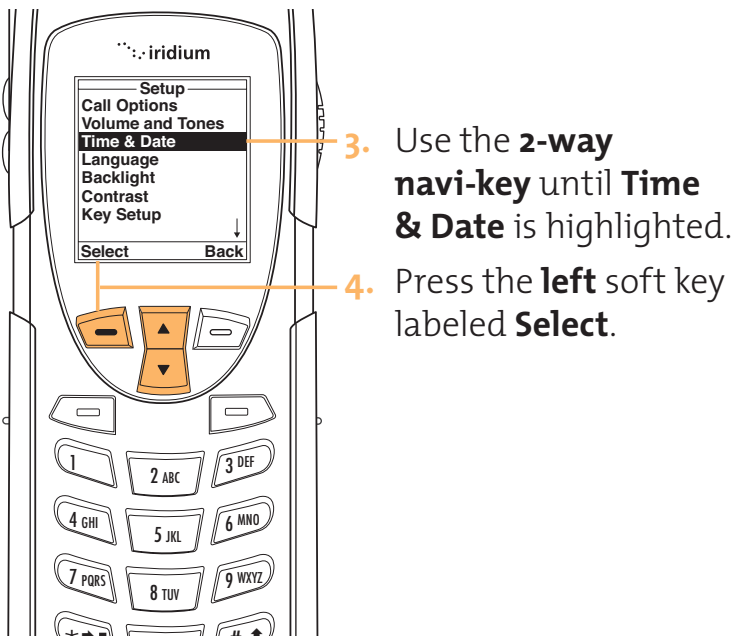
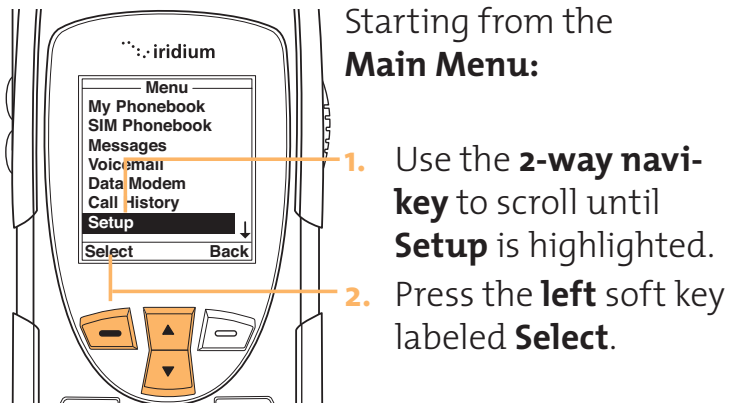



## Iridium 9555 Handset | 11 Using the Setup Menu

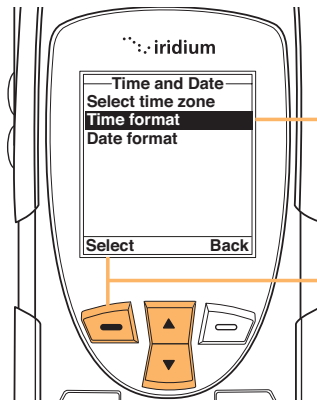

5. Use the **2-way navi-key** to scroll until **Time Format** is highlighted.

6. Press the **left** soft key labeled **Select**.

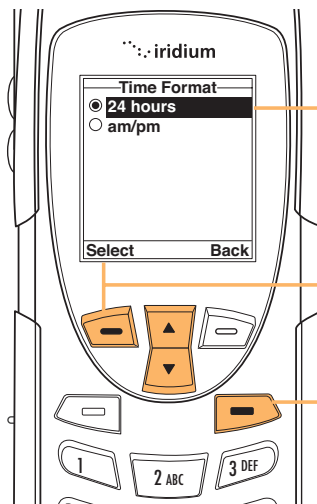

7. Use the **2-way navi-key** to scroll until the desired time format is highlighted.

8. Press the **left** soft key labeled **Select**.

Press the **red** key to return to the **main screen**.

## Select the Date Format

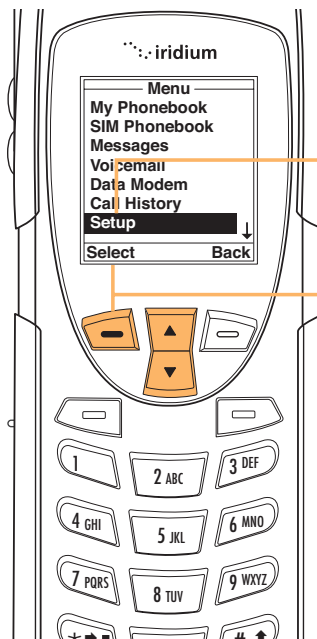

Starting from the **Main Menu**:

1. Use the **2-way navi-key** to scroll until **Setup** is highlighted.

2. Press the **left** soft key labeled **Select**.



## Iridium 9555 Handset | 11 Using the Setup Menu

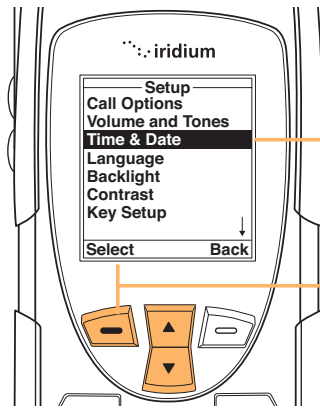

3. Use the **2-way navi-key** until **Time & Date** is highlighted.
4. Press the **left** soft key labeled **Select**.

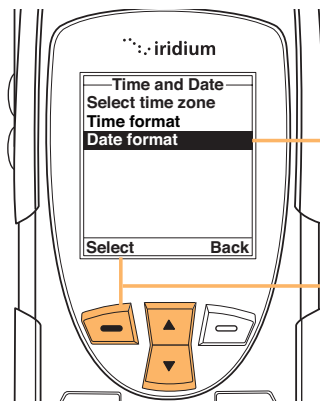

5. Use the **2-way navi-key** to scroll until **Date format** is highlighted.
6. Press the **left** soft key labeled **Select**.

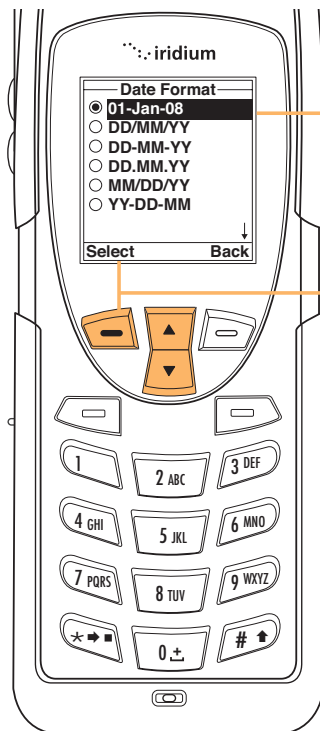

7. Use the **2-way navi-key** to scroll until the desired date format is highlighted.
8. Press the **left** soft key labeled **Select**.





## Selecting the Display Language

Your phone contains 21 languages. Use this feature to select the language in which your phone displays menus and messages.

### TIP:

If you accidentally select a language other than English and are unable to reset your phone, follow these steps:

1. Press the left soft key.
2. Scroll down 6 times.
3. Press the left soft key again.
4. Scroll down 3 times
5. Press the left soft key, the English option will be at the top.

Starting from the **Main Menu:**

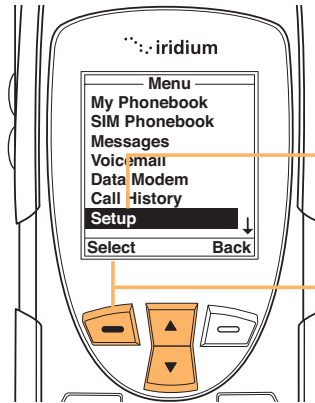

1. Use the **2-way navi-key** to scroll until **Setup** is highlighted.
2. Press the **left** soft key labeled **Select**.

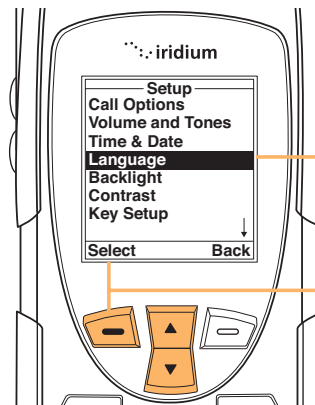

3. Use the **2-way navi-key** until **Language** is highlighted.
4. Press the **left** soft key labeled **Select**.

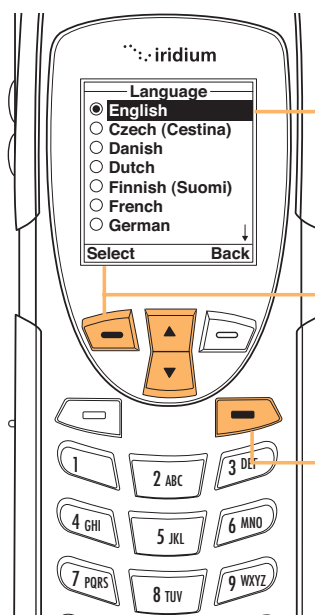

5. Use the **2-way navi-key** to scroll until the required Language is highlighted.
  6. Press the **left** soft key labeled **Select** to choose the Language.
- Press the **red** key to return to the **main screen**.





## Iridium 955 Handset | 11 Using the Setup Menu

### Setting Backlights

Enable, disable or adjust the length of time the backlight stays on after a key press.

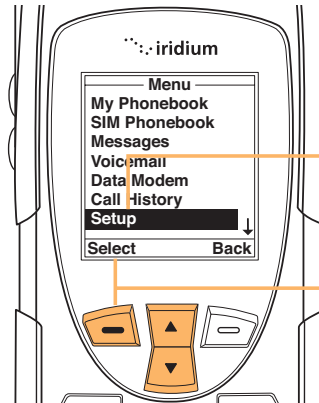

Starting from the **Main Menu:**

1. Use the **2-way navi-key** to scroll until **Setup** is highlighted.
2. Press the **left** soft key labeled **Select**.

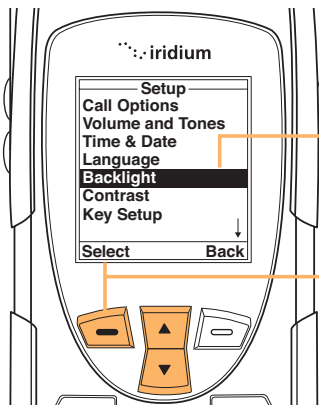

3. Use the **2-way navi-key** until **Backlight** is highlighted.
4. Press the **left** soft key labeled **Select**.

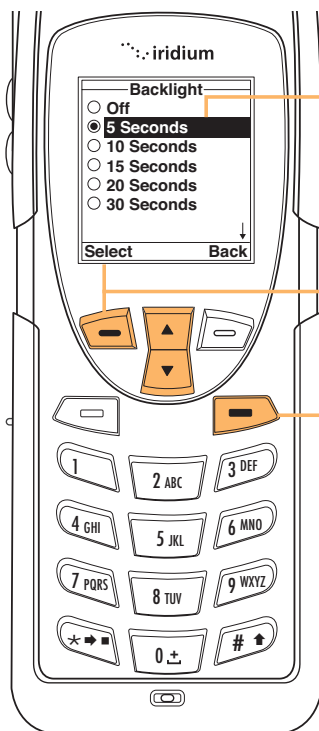

5. Use the **2-way navi-key** to scroll until the required Backlight time is highlighted.
  6. Press the **left** soft key, labeled **Select**.
- Press the **red** key to return to the **main screen**.





## Setting Contrast

This feature allows you to adjust the contrast on the display screen.

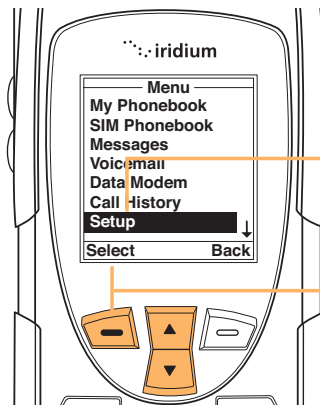

Starting from the **Main Menu:**

1. Use the **2-way navi-key** to scroll until **Setup** is highlighted.

2. Press the **left** soft key labeled **Select**.

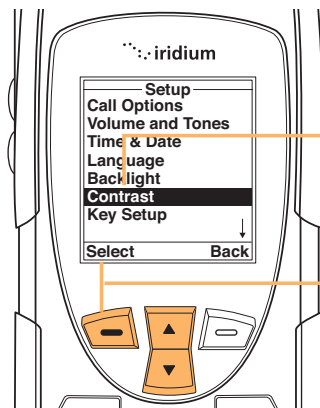

3. Use the **2-way navi-key** until **Contrast** is highlighted.

4. Press the **left** soft key labeled **Select**.

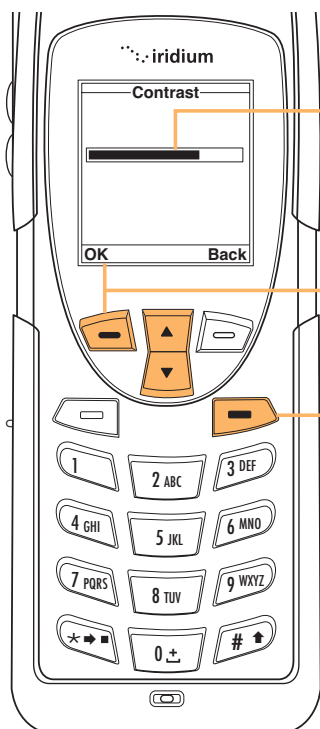

5. Use the **2-way navi-key** to increase or decrease the contrast.

6. Press the **left** soft key, labeled **Select**.

Press the **red** key to return to the **main screen**.





## Iridium 955 Handset | 11 Using the Setup Menu

### Using the Key Setup Menu

This feature selects the function of the convenience key and the right soft key when the main screen is displayed. The default function is to display the Help screen which is useful for new users; however the function can be changed to access the Phonebook.

### Setup the Convenience Key Function

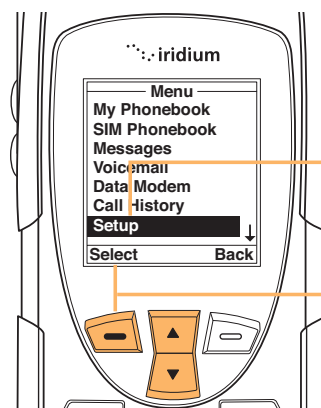

Starting from the **Main Menu:**

1. Use the **2-way navi-key** to scroll until **Setup** is highlighted.
2. Press the **left soft key** labeled **Select**.

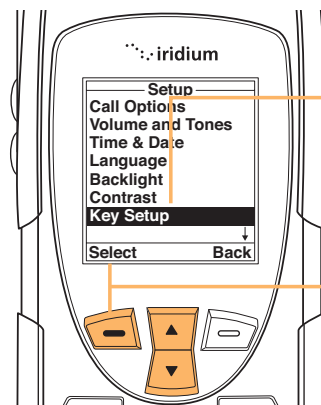

3. Use the **2-way navi-key** until **Key Setup** is highlighted.
4. Press the **left soft key** labeled **Select**.

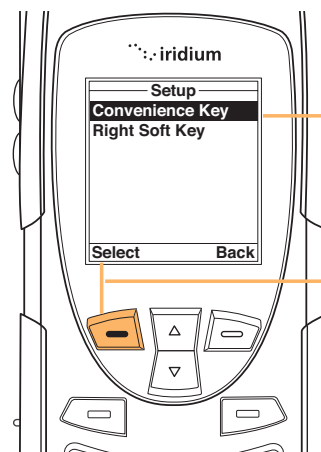

5. The **Convenience Key** will be highlighted.
6. Press the **left soft key** labeled **Select**.





## Iridium 9555 Handset | 11 Using the Setup Menu

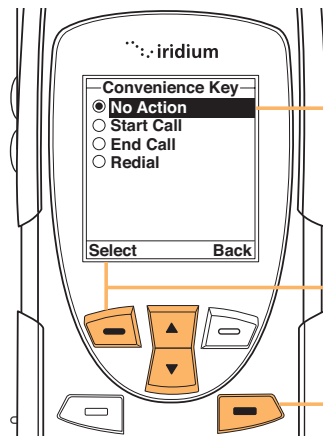

7. Use the **2-way navi-key** to scroll until the desired action is highlighted.
8. Press the **left** soft key labeled **Select**.
- Press the **red** key to return to the **main screen**.

## Setup the Right Soft Key Function

Starting from the **Main Menu**:

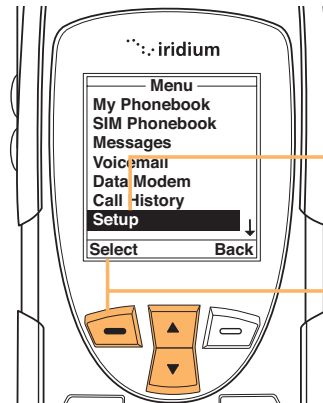

1. Use the **2-way navi-key** to scroll until **Setup** is highlighted.
2. Press the **left** soft key labeled **Select**.

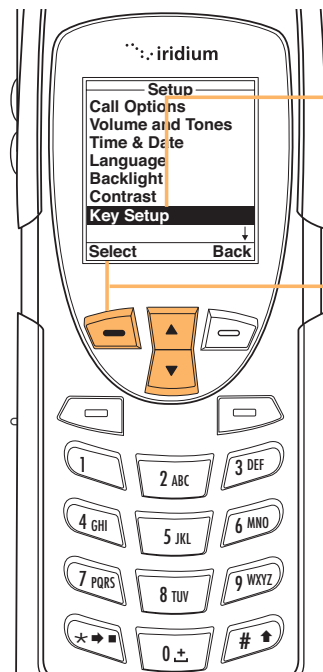

3. Use the **2-way navi-key** until **Key Setup** is highlighted.
4. Press the **left** soft key labeled **Select**.



## Iridium 9555 Handset | 11 Using the Setup Menu

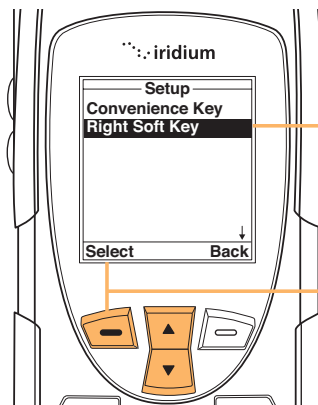

5. Use the **2-way navi-key** until **Right Soft Key** is highlighted.

6. Press the **left** soft key labeled **Select**.

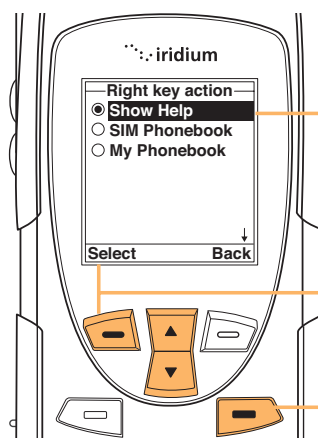

7. Use the **2-way navi-key** to scroll until the desired action is highlighted.

8. Press the **left** soft key labeled **Select**.

Press the **red** key to return to the **main screen**.

### Set Number Entry Prefix

This feature allows you to set your preferred international access code and can automatically attach (00) or (+) to any phone number you enter

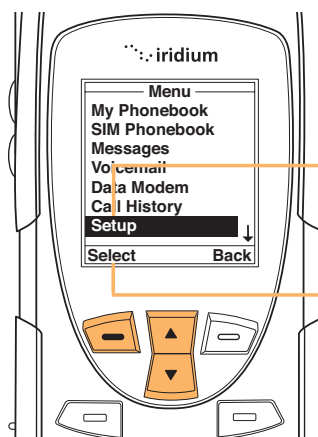

Starting from the **Main Menu**:

1. Use the **2-way navi-key** to scroll until **Setup** is highlighted.

2. Press the **left** soft key labeled **Select**.



## Iridium 9555 Handset | 11 Using the Setup Menu

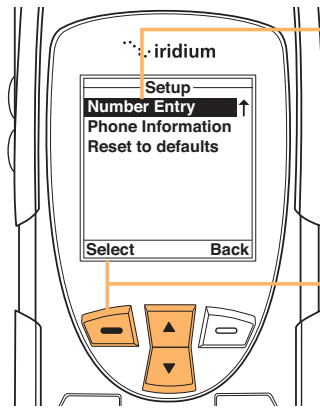

- Use the **2-way navi-key** until **Number Entry** is highlighted.

**Note:** Scroll past the Key setup for the Number Entry Option.

- Press the **left** soft key labeled **Select**.

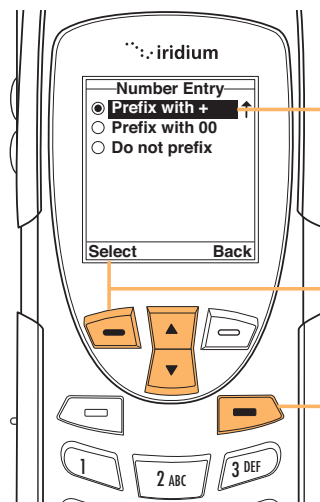

- Use the **2-way navi-key** to scroll until the desired action is highlighted.

- Press the **left** soft key labeled **Select**.

Press the **red** key to return to the **main screen**.

## View Phone Information

This feature allows you to view the technical information regarding the handsets software and hardware versions as well as the IMEI number.

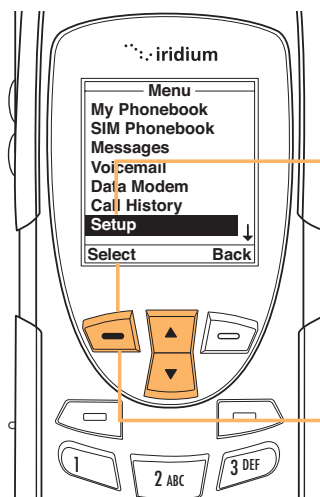

Starting from the **Main Menu:**

- Use the **2-way navi-key** to scroll until **Setup** is highlighted.

- Press the **left** soft key labeled **Select**.



## Iridium 9555 Handset | 11 Using the Setup Menu

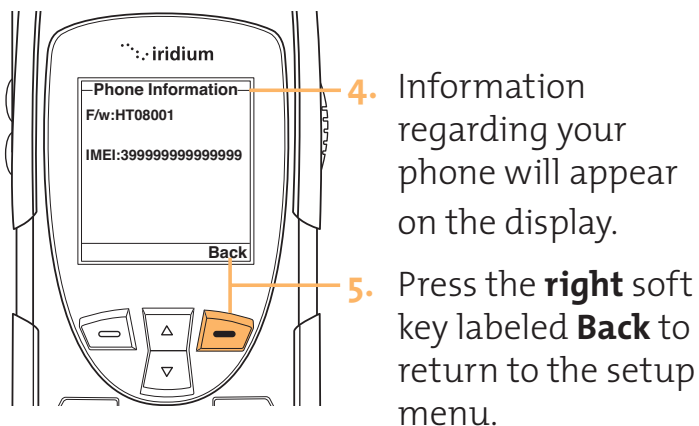
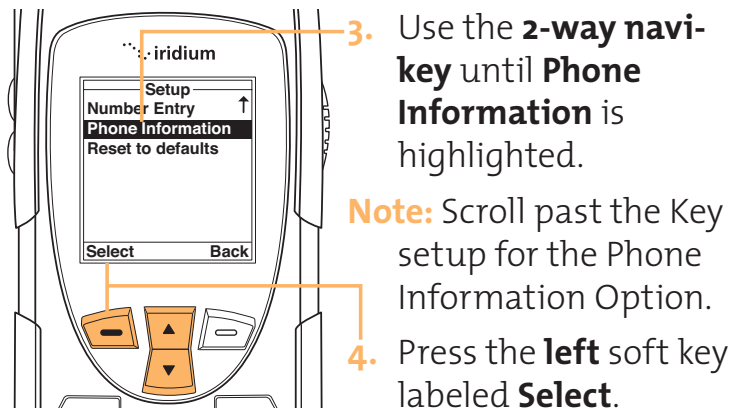

### Reset Phone Options to Factory Defaults

This feature resets all settings to their original default settings.

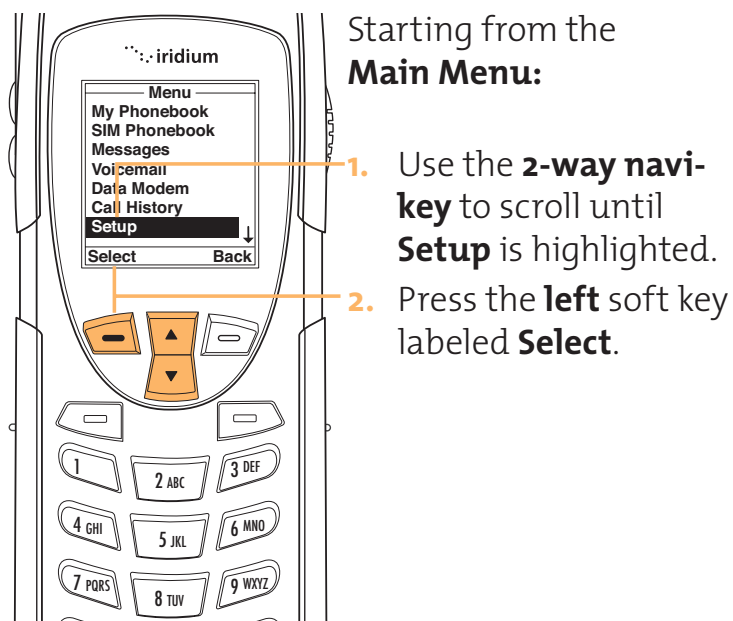





## Iridium 9555 Handset | 11 Using the Setup Menu

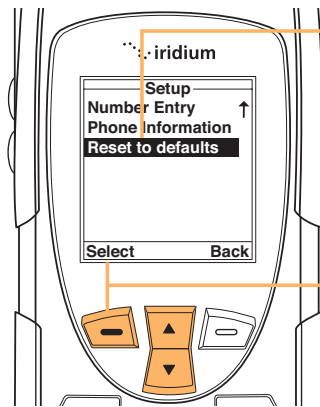

3. Use the **2-way navi-key** until **Reset to defaults** is highlighted.

**Note:** Scroll past the Key setup for the Reset to defaults Option.

4. Press the **left** soft key labeled **Select**.

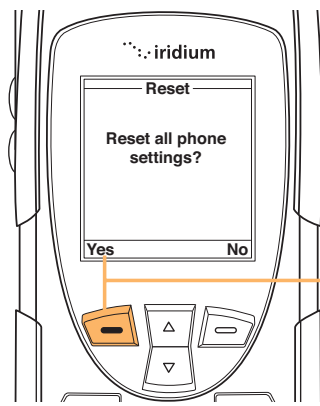

5. Press the **left** soft key labeled **Yes**.

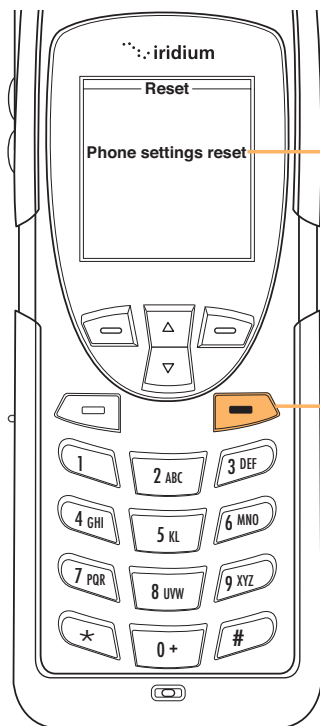

6. A message will appear briefly indicating the phone settings have been reset.

Press the **red** key to return to the **Main Screen**.





# 12 | Using the Security Menu

**Important:** Do not change the PIN/PUK/SIM settings unless you have your original settings available. Your phone and/or SIM card may be disabled if you don't know the correct code and enter it incorrectly three times.

## Locating the Security Menu

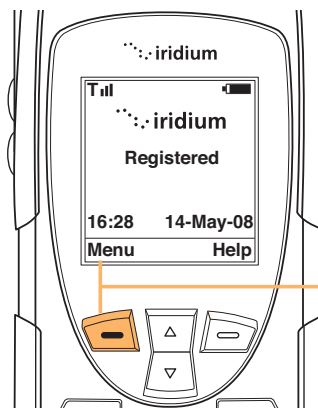

Starting from the **main screen**:

1. Press the **left** soft key labeled **Menu**.

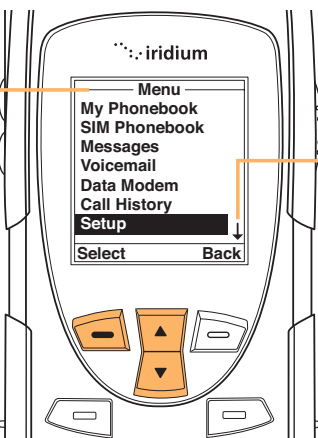

**Note:** All instructions for the Security menu will start from the **Main Menu** as shown.

2. The **Main Menu** will now be displayed. Use the **2-way navi-key** to scroll until **Security** is highlighted.

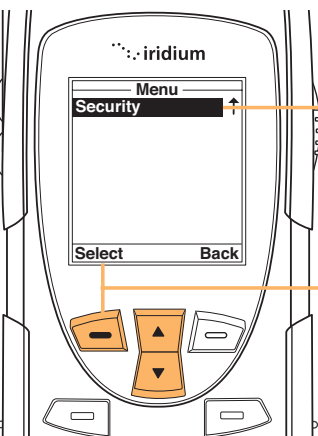

**Note:** Scroll one down from Setup to view the Security option.

3. Press the **left** soft key labeled **Select**.



## Iridium 9555 Handset | 12 Using the Security Menu

### About the Security Menu

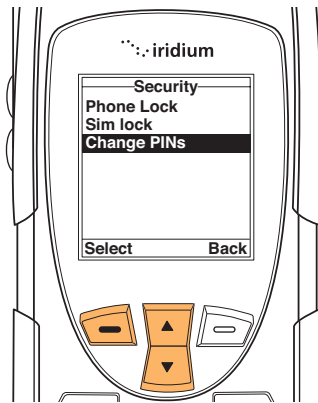

You will be able to perform the following functions using the **Security** Menu.

- Lock and unlock the phone
- Enable and disable the SIM lock
- Change PIN and block PIN codes

### Locking and Unlocking Your Phone

This feature helps prevent unwanted use of your phone.

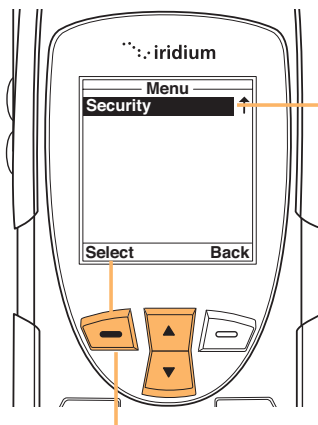

Starting from the **Main Menu**:

1. Use the **2-way navi-key** to scroll until **Security** is highlighted.

**Note:** Scroll one down from Setup to view the Security option.

2. Press the **left** soft key labeled **Select**.

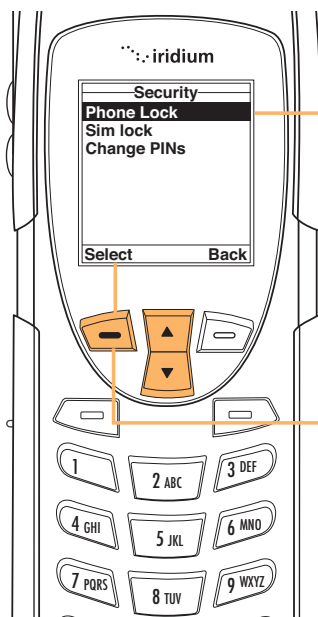

3. The **Phone Lock** option will be highlighted, if not use the **2-way navi-key** to scroll until it is.

4. Press the **left soft** key labeled **Select**.



## Iridium 9555 Handset | 12 Using the Security Menu

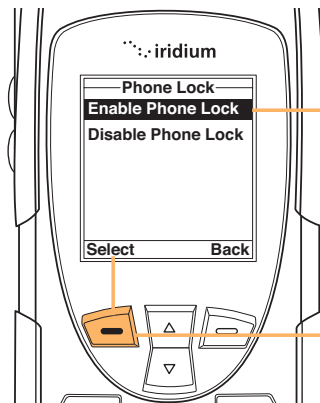

5. The **Enable Phone Lock** option will be highlighted, if not use the **2-way navi-key** to scroll until it is.

6. Scroll to the desired option and press the **left** soft key labeled **Select**.

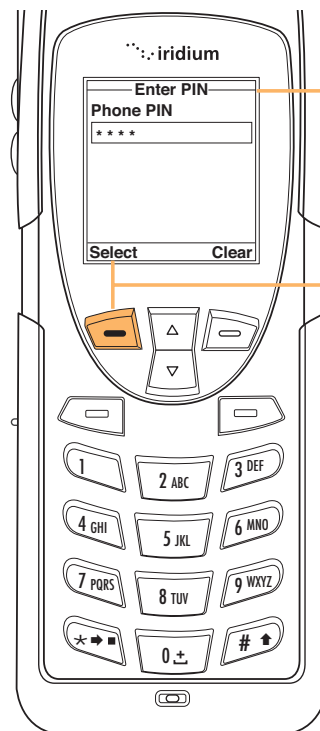

7. The **Enter PIN** screen will now appear. Using the **keypad** enter the PIN number.

8. Press the **left** soft key labeled **Select**.

**Note:** The Phone Lock feature takes effect when you turn off your handset. Each time you restart your handset you will be prompted to enter your Phone PIN, once you do so the handset will be fully operational.



## Iridium 9555 Handset | 12 Using the Security Menu

### Enable or Disable the SIM lock

When you activate the SIM card PIN code, your phone requests the code whenever you phone is powered on. To change this setting, you need to enter the PIN code that your service provider gave you.

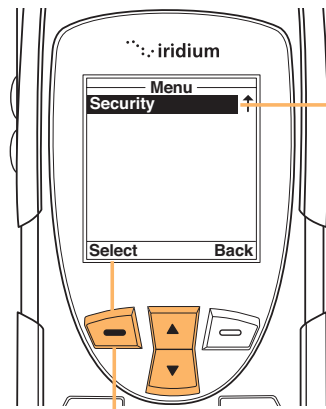

Starting from the **Main Menu:**

1. Use the **2-way navi-key** to scroll until **Security** is highlighted.

**Note:** Scroll one down from Setup to view the Security option.

2. Press the **left soft key** labeled **Select**.

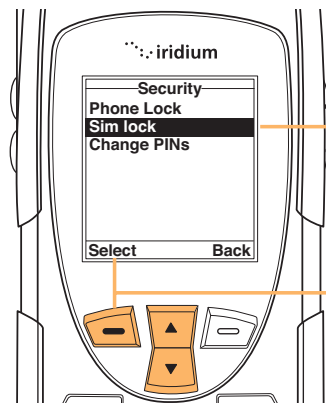

3. Use the **2-way navi-key** to scroll until **SIM lock** is highlighted.

4. Press the **left soft key** labeled **Select**.

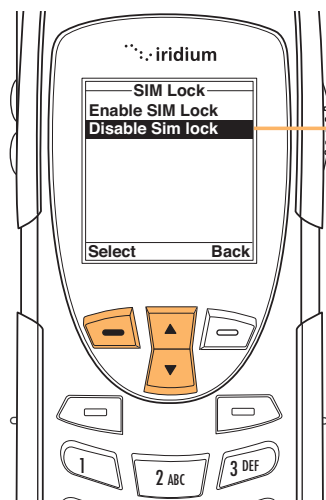

5. Use the **2-way navi-key** until the action you prefer is highlighted.





## Iridium 9555 Handset | 12 Using the Security Menu

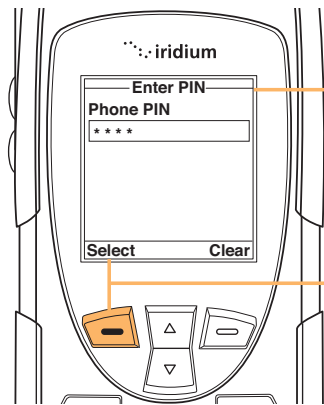

6. The **Enter PIN** screen will now appear. Using the **keypad** enter the PIN number.

7. Press the **left** soft key labeled **Select**.

**Note:** The message **Sim Lock disabled** will briefly appear and then return to the Sim Lock menu.

### Using the Change PIN Menu

#### Change the Phone PIN Code

This feature allows you to modify the default PIN associated with your phone.

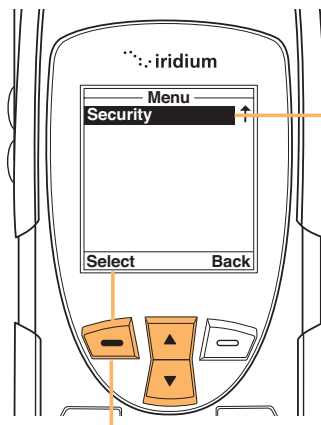

Starting from the **Main Menu**:

1. Use the **2-way navi-key** to scroll until **Security** is highlighted.

**Note:** Scroll one down from Setup to view the Security option.

2. Press the **left** soft key labeled **Select**.

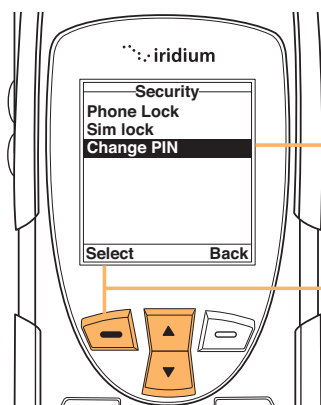

3. Use the **2-way navi-key** to scroll until **Change PIN** is highlighted.

4. Press the **left soft** key labeled **Select**.



## Iridium 9555 Handset | 12 Using the Security Menu

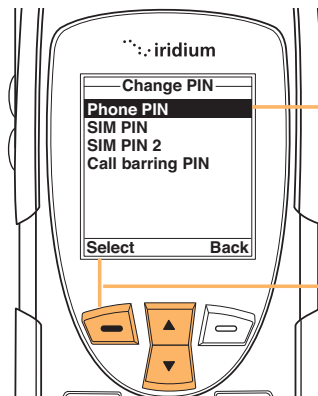

5. The **Change PIN** menu will now appear. **Phone PIN** will be highlighted.

6. Press the **left soft key** labeled **Select**.

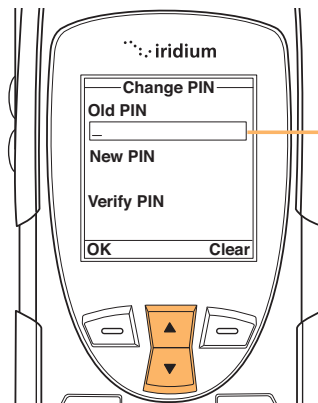

7. Enter your current PIN in the **Old PIN** field (the default PIN is 1234). Use the **2-way navi-key** to move to the next field and enter your new PIN into the **New PIN** field. Move to the **Verify PIN** field and enter the new PIN again.

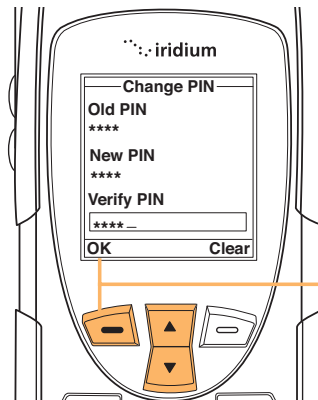

8. When all fields are complete, press the **left soft key**, labeled **OK**.

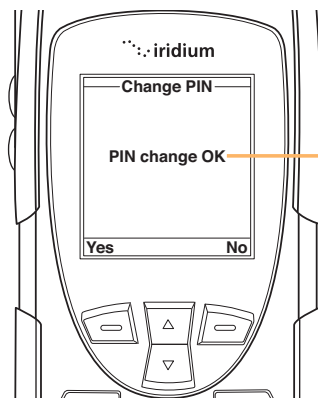

9. The screen will display: **PIN Changed OK**, then will return to the Change PIN menu.





## Change the SIM PIN Code

This feature allows you to modify the default PIN associated with your SIM card.

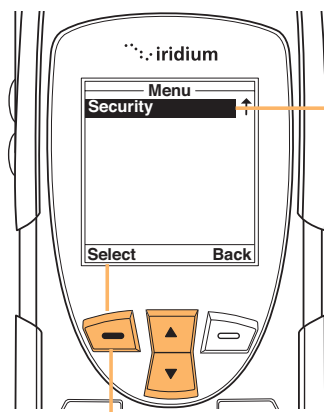

Starting from the **Main Menu:**

1. Use the **2-way navi-key** to scroll until **Security** is highlighted.

**Note:** Scroll one down from Setup to view the Security option.

2. Press the **left soft key** labeled **Select**.

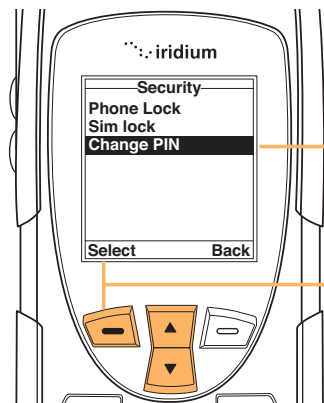

3. Use the **2-way navi-key** to scroll until **Change PIN** is highlighted.

4. Press the **left soft key** labeled **Select**.

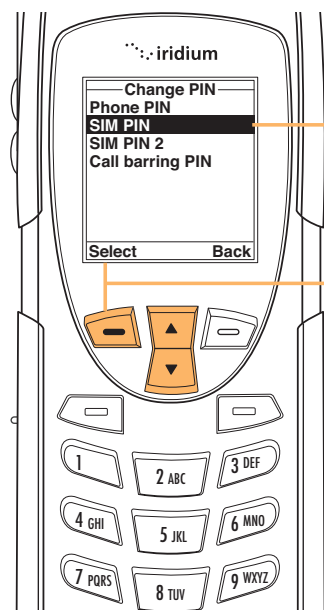

5. Use the 2-way navi-key to scroll until **SIM PIN** is highlighted.

6. Press the **left soft key** labeled **Select**.



## Iridium 9555 Handset | 12 Using the Security Menu

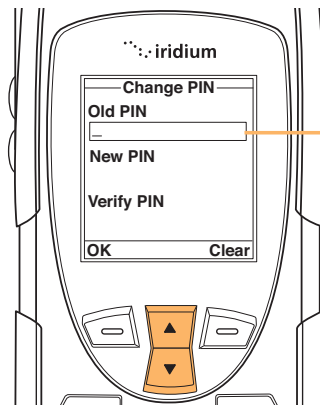

7. Enter your current PIN in the **Old PIN** field. Use the **2-way navi-key** to move to the next field and enter your new PIN into the **New PIN** field. Move to the **Verify PIN** field and enter the new PIN again.

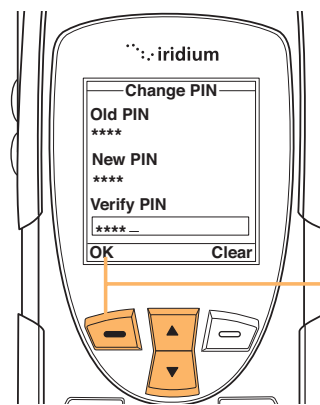

8. When all fields are complete, press the **left** soft key, labeled **OK**.

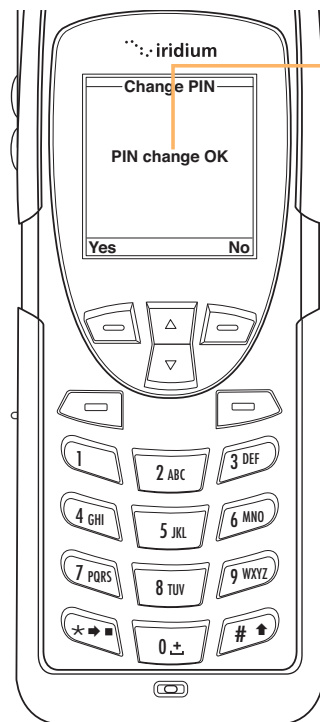

9. The screen will display: **PIN Changed OK**, then will return to the Change PIN menu.



## Change the SIM Card Pin2 Code

Your SIM card PIN2 code is used to access fixed dialing settings. This four- to eight-digit code is issued to you when you subscribe to the feature.

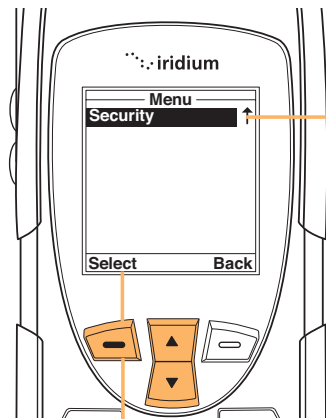

Starting from the **Main Menu:**

1. Use the **2-way navi-key** to scroll until **Security** is highlighted.

**Note:** Scroll one down from Setup to view the Security option.

2. Press the **left soft key** labeled **Select**.

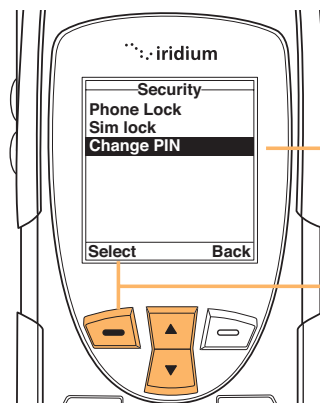

3. Use the **2-way navi-key** to scroll until **Change PIN** is highlighted.

4. Press the **left soft key** labeled **Select**.

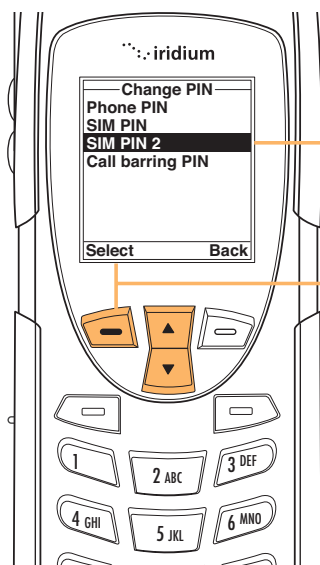

5. Use the **2-way navi-key** to scroll until **SIM PIN 2** is highlighted.

6. Press the **left soft key** labeled **Select**.



## Iridium 9555 Handset | 12 Using the Security Menu

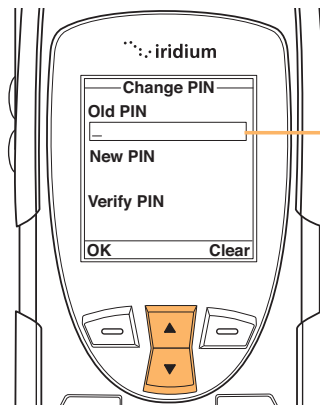

7. Enter your current 4-digit PIN in the **Old PIN** field. Use the **2-way navi-key** to move to the next field and enter your new PIN into the **New PIN** field. Move to the **Verify PIN** field and enter the new PIN again.

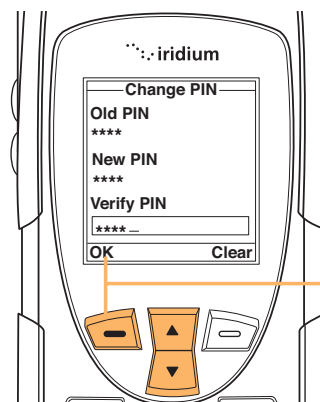

8. When all fields are complete, press the **left** soft key, labeled **OK**.

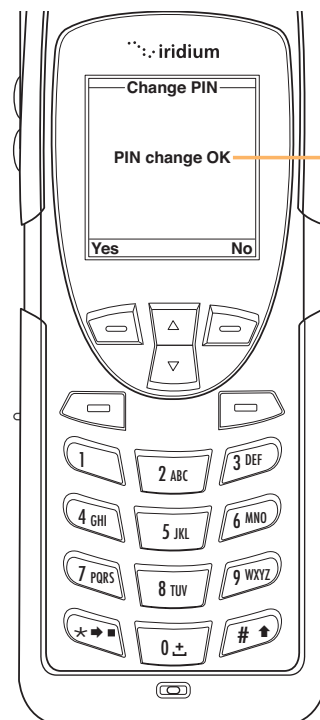

9. The screen will display: **PIN Changed OK**, then will return to the Change PIN menu.



## Call Barring PIN

If your PIN code is entered incorrectly three times in a row, **Blocked** appears in the display screen and your SIM card will be locked. You must enter a Personal Unblocking Key (PUK) to restore the SIM to service which is obtained from your service provider.

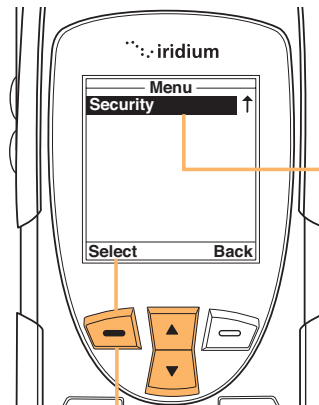

To unblock the PIN code, start from the **Main Menu**:

1. Use the **2-way navi-key** to scroll until **Security** is highlighted.

**Note:** Scroll one down from Setup to view the Security option.

2. Press the **left soft key** labeled **Select**.

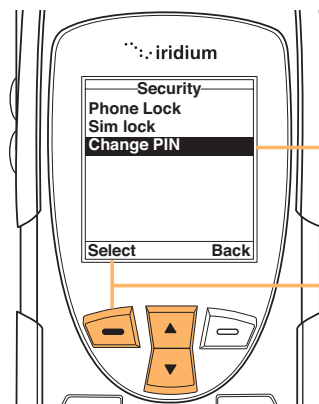

3. Use the **2-way navi-key** to scroll until **Change PIN** is highlighted.

4. Press the **left soft key** labeled **Select**.

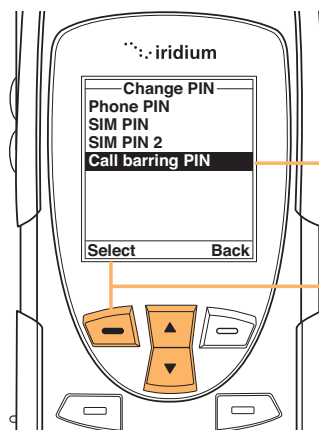

5. Use the **2-way navi-key** to scroll until **Call barring PIN** is highlighted.

6. Press the **left soft key** labeled **Select**.



## Iridium 955 Handset | 12 Using the Security Menu

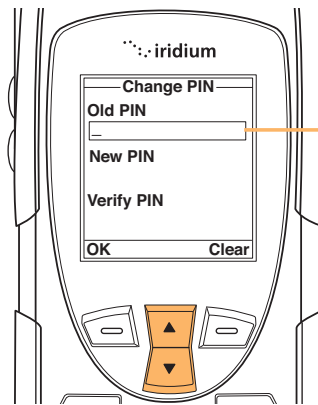

7. Enter your the 4-digit PIN code provided by your service provider in the **Old PIN** field. Use the **2-way navi-key** to move to the next field and enter your new PIN into the **New PIN** field. Move to the **Verify PIN** field and enter the new PIN again.

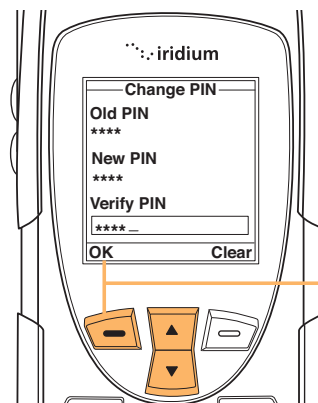

8. When all fields are complete, press the **left** soft key, labeled **OK**.

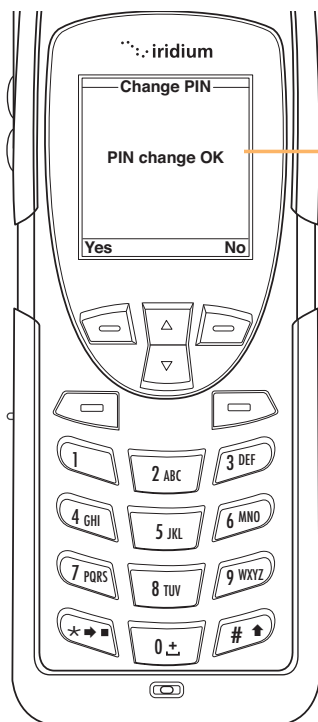

9. The screen will display: **PIN Changed OK**, then will return to the main Change PIN menu.



# 13 | Troubleshooting

Problem	Solution
Phone won't power on	<ul style="list-style-type: none"><li>• Did you press and hold the power button for a minimum of 3 seconds to turn the phone's power on?</li><li>• Check the battery. Is it charged, properly fitted, and are the contacts clean and dry?</li></ul>
You can't make calls	<ul style="list-style-type: none"><li>• Check the antenna. Is it fully extended and correctly angled? Do you have a clear unobstructed view of the sky?</li><li>• Did you enter the number in international format? All calls made from the Iridium satellite system must be in international format. See page 4.11.</li><li>• Check the signal strength indicator. If the signal is weak, ensure that you have a clear line of sight to the sky and there are no buildings, trees, etc. around.</li><li>• Is Restricted displayed? Check the Call Barring setting.</li><li>• Has a new SIM card been inserted? Check that no new restrictions have been imposed.</li><li>• Check to see if your fixed dialing list is enabled. If so, you can only make calls to numbers or prefixes that are on the list.</li></ul>

continued on next page





## Iridium 9555 Handset | 13 Troubleshooting

Problem	Solution
You can't receive calls	<ul style="list-style-type: none"><li>• Check to see that your phone is powered on.</li><li>• Check the antenna. Is it fully extended and correctly angled? Do you have a clear unobstructed view of the sky?</li><li>• Check the signal strength indicator. If the signal is weak, ensure that you have a clear line of sight to the sky and there are no buildings, trees, etc. around.</li><li>• Check the Call Forwarding and Call Barring settings.</li><li>• Check the Ringer setting. If it is off, there is no audible ringer.</li><li>• Check to see if your fixed dialing list is enabled.</li></ul>
You can't make international calls	Have you included the relevant codes? Enter oo or + followed by the appropriate country code and the phone number.
Your phone will not unlock	<ul style="list-style-type: none"><li>• Have you inserted a new SIM card? Enter the new PIN code.</li><li>• Enter the default phone unlock code – 1234</li><li>• Have you forgotten the unlock code?</li></ul>
Your PIN is blocked	Enter the PIN unblocking code or contact your service provider. See <b>Call barring PIN</b> on page 12.14 for additional information.
Your PIN2 is blocked	Enter the PIN2 unblocking code or contact your service provider. See <b>Call barring PIN</b> on page 12.14 for additional information.





Problem	Solution
Your SIM card will not work	<ul style="list-style-type: none"> <li>• Is the SIM card inserted the correct way?</li> <li>• Is the card visibly damaged or scratched? Return the card to your service provider.</li> <li>• Check the SIM and card contacts. If they are dirty, clean them with an antistatic cloth.</li> </ul>
You can't cancel Call Forwarding or Call Barring	Wait until you are in an area with good network coverage and try again.
The message indicator is flashing	There is not enough memory available to store another message. Use the messages menu to delete one or more messages.
The battery won't charge	<ul style="list-style-type: none"> <li>• Check the charger. Is it properly connected? Are its contacts clean and dry?</li> <li>• Check the battery contacts. Are they clean and dry?</li> <li>• Check the battery temperature. If it is warm, let it cool before charging.</li> <li>• Is it an old battery? Battery performance declines after several years of use. Replace the battery.</li> <li>• Make sure you have an Iridium approved battery installed. If you see Invalid Batt on the display, you will not be able to charge this battery.</li> </ul>

continued on the next page



## Iridium 9555 Handset | 13 Troubleshooting

Problem	Solution
The battery drains faster than normal	<ul style="list-style-type: none"><li>• Are you in an area of variable coverage? This uses extra battery power.</li><li>• Is your antenna fully extended and correctly angled? Do you have a clear unobstructed view of the sky? This helps use less battery power.</li><li>• Is it a new battery? A new battery needs two to three charge/discharge cycles to attain normal performance</li><li>• Is it an old battery? Battery performance declines after several years of use. Replace the battery.</li><li>• Is it a battery that hasn't been completely discharged? Allow the battery to fully discharge (until the phone turns itself off) and then charge the battery overnight.</li><li>• Are you using your phone in extreme temperatures? At extreme hot or cold temperatures, battery performance is significantly reduced.</li></ul>
You find your phone becoming warm during use	You may notice this during long calls or during charging. The heat is produced by the electronic components within your phone and is quite normal.
Phone is not responding to user controls including the power keys	Remove the battery from the phone and then reattach it to cycle power and reset.





Problem	Solution
Your SIM card is inserted in the phone but the display says:	<p><b>Check Card or Insert Card</b> Check that the SIM card has been inserted correctly. The contacts of the SIM card may be dirty. Turn the phone off, remove the SIM card and rub the contacts with a clean cloth. Replace the card in the phone.</p> <p><b>Blocked</b> Enter the PIN unblocking key or contact your service provider. See <b>Call barring PIN</b> on page 12.14 for additional information.</p>
Your phone is displaying an unknown foreign language and you would like to restore it to its original setting.	<ul style="list-style-type: none"><li>• Power on the phone</li><li>• Press left soft key for menu</li><li>• Press down 6 times for Setup, then left soft key for Select</li><li>• Press down 3 times for Languages, then left soft key for Select</li><li>• Press left soft key for Select</li></ul>







# 14 | Patent Information

**Manufactured under one or more of the following U.S. patents:**

4121218	4616314	4741034	D306594	5083304	D337332	D354062	D368696
4138681	4617520	4742562	4912602	D324024	5230007	5384825	5510693
4193036	D286778	D295627	4918732	D324388	5230093	D356084	5511235
4254382	4626309	4746242	4922178	5095503	5233633	5402447	D369162
4302845	4628529	D295973	4945570	D325028	5235492	5406146	5513078
4312074	4629829	D295975	4954796	D325583	5237257	5406562	D369359
4327319	4630304	4751737	4959851	5109536	5239127	D357224	5519303
4329666	4630305	D296187	4963812	D325915	241545	D357457	5519346
4369516	4633141	4761621	4963843	5113436	5241548	5410741	5524276
4369522	4636593	4764737	4965537	5117450	5241650	D357680	5524278
4378603	4636741	D297734	4972355	5121047	5241693	D357681	D370463
4390963	D288432	D297735	4972432	5122480	5242767	5428836	5530922
D269873	4648125	4777564	4972455	5122722	D339582	D359734	5542116
4398265	4649543	Re.32768	4975808	D327061	5249302	D359735	5544250
4400584	D288683	D299136	4984290	5128834	5251331	D359959	D372481
4400585	4654655	4797929	D314173	D328302	D340710	5432017	5546275
D270835	D289156	4798975	D315330	5142551	5260988	D360632	5546380
D271491	4662691	4800348	D315346	5142696	5261119	5438684	D372896
Re.31470	4667333	4802236	D315543	5146620	5262710	D361070	5551078
4431977	4668917	4809356	D315559	5148471	5263052	5442680	5559471
4434461	4670747	4811377	D315565	5148473	5276707	5446763	D374424
4455534	4672502	4811404	5004992	5148961	5278994	5448763	D374872
4462098	4680787	4827226	D315907	5150359	D343173	5448771	572193
D275951	4681476	4827507	5008925	5150384	5280637	5453997	5574976
4484153	4683585	4829274	D316417	5152006	D344087	D362840	5577268
4485486	4692726	4837534	D316859	5157693	5287553	5457744	D375732
4486624	4704588	D301476	5017856	5163159	5287555	5459640	D375733
D276809	D292578	4843621	5018188	5164652	5287556	5463646	D375734
4491972	4706036	4845772	5020091	5166596	D344511	5465412	D375932
D277667	D292920	D302015	5020092	5175759	5301365	5469177	D375952
4504834	4710724	4851966	5020093	5175874	5321847	5475752	D376127
D278708	4711361	4868576	5028083	D332261	D348880	D365094	5588041
4523155	4715063	4870686	5028859	5182749	5349588	D365817	5589796
4546329	4716319	D303656	5029044	D332785	5359696	5486843	5590177
4550426	4716391	4876552	5029233	5185566	5361400	5487184	5594778
4551696	4723305	4879533	5031028	5187809	5363071	5488335	5594951
4564821	D294257	D305427	5036532	5193223	5365549	5488649	D377792
D282169	4727306	4896124	5053924	5195106	D352497	D366872	D377934



## Iridium 9555 Handset | 14 Patent Information

4571595	4727583	4897873	057762	5195108	5366826	5493198	5604050
4573017	4730195	D305717	D320780	5201069	D353131	5493714	5606730
4574243	4734635	4904549	5059885	5204977	D353361	5497126	D378366
4585957	4736277	4905288	5060294	5210793	5375143	5497382	5613229
4602218	4737976	4905301	D322783	5214675	5375258	D367640	5613863
D284759	4740794	D306293	D322955	5222104	5379324	5499394	5615233
D285439	4741018	D306441	5081674	5222251	D354055	5506490	5621763





# 15 | Declaration of Conformity

**E C Directive  
Declaration of Conformity**

This is to certify that the following equipment complies with all relevant Essential Health and Safety Requirements of the Radio and Telecommunications Terminal Equipment Directive 1999/5/EC and the Low Voltage Directive 73/23/EC as amended by 93/68/EC.

<b>Equipment description</b>	Iridium 9555 Satellite Handset
<b>Manufacturer</b>	Iridium Satellite LLC, 8440 South River Parkway, Tempe, AZ 85284 USA

The following harmonised standards were applied to the design of the handset:

Standard	Description
EN60950-1:2006	Information technology equipment – Safety – Part 1: General requirements
EN301 489-20 V1.2.1 (2002-11)	Electromagnetic compatibility and Radio Spectrum Matters (ERM)
EN301 489-01 V1.6.1 (2005-09)	Electromagnetic Compatibility (EMC) standard for radio equipment and services
ETSI EN50360:2001	Product standard to demonstrate the compliance of mobile phones with the basic restrictions related to human exposure to electromagnetic fields (300MHz to 3GHz)
ETSI EN 301 441 V 1.1.1 05/2000	Satellite Earth Stations and Systems (SES); Harmonised EN for Mobile Earth Stations (MESs)

The tests were conducted by TRL Compliance Services Ltd, Moss View, Nipe Lane, Up Holland, West Lancashire, WN89PY, UK except for the SAR report which was prepared by EMC Technologies Pty Ltd, ABN 82 057 105 549, 57 Assembly Drive, Tullamarine, Victoria, Australia 3043.

Accreditation references:

TRL - UKAS 0728 and BSI FS 21805  
EMC Technologies - NATA 5292

A "technical file" is retained by Iridium Satellite LLC. Related test reports are available upon request directly from Iridium Satellite, LLC.

The 9555 handset is declared conformant only if it is used with the Iridium accessories and antenna approved for the 9555 model and if the handset is used as described in the 9555 User Guide.

<b>Name</b>	<b>David Schoen</b>	
<b>Date</b>	<b>October 8, 2008</b>	



