

# ENGINEERING TEST REPORT

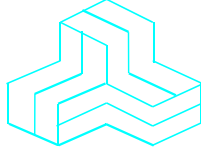

**QT-AD10 Family:**  
**PlayerMic S, PlayerMic , AquaMic, AquaMic L, CoachMic, RefMic**  
**RefMic HD, BeltMic, Incognito, GolfCupMic, TapshoeMic, BouyMic**

**Models:**  
QT-AD10PS, QT-AD10PM, QT-AD10CM, QT-AD10RF, QT-AD10RD,  
QT-AD10BM, QT-AD10IM, QT-AD10GM, QT-AD10TM, QT-AD10WM, QT-AD10AM, QT-AD10AL

**FCC ID: Q5N-QTAD10A15**

*Applicant:*  
**Quantum5x Systems Inc.**  
30 Adelaide Street North Suite 12  
London, Ontario  
Canada N6B 3N5

**In Accordance With**

**Federal Communications Commission (FCC)**  
**Part 15, Subpart C, Section 15.247**

**UltraTech's File No.: 21Q5X071\_F15.247C**

This Test report is Issued under the Authority of  
Tri M. Luu  
Vice President of Engineering  
UltraTech Group of Labs

Date: January 20, 2021

Report Prepared by: Santhosh Fernandez

Tested by: Hung Trinh

Issued Date: January 20, 2021

Test Dates: January 31- February 20, 2020

- *The results in this Test Report apply only to the sample(s) tested, and the sample tested is randomly selected.*
- *This report must not be used by the client to claim product endorsement by any agency of the US Government.*
- *This test report shall not be reproduced, except in full, without a written approval from UltraTech*

## UltraTech

3000 Bristol Circle, Oakville, Ontario, Canada L6H 6G4  
Tel.: (905) 829-1570 Fax.: (905) 829-8050  
Website: [www.ultratech-labs.com](http://www.ultratech-labs.com), Email: [vic@ultratech-labs.com](mailto:vic@ultratech-labs.com), Email: [tri@ultratech-labs.com](mailto:tri@ultratech-labs.com)



APEC TEL CA0001



1309



CA 0001/2049



AT-1945



SL2-IN-E-1119R



Korea KCC-RRR  
CA0001

TABLE OF CONTENTS

**EXHIBIT 1. INTRODUCTION ..... 1**

1.1. SCOPE..... 1

1.2. RELATED SUBMITTAL(S)/GRANT(S)..... 1

1.3. NORMATIVE REFERENCES ..... 1

**EXHIBIT 2. PERFORMANCE ASSESSMENT ..... 2**

2.1. CLIENT INFORMATION ..... 2

2.2. EQUIPMENT UNDER TEST (EUT) INFORMATION..... 2

2.3. EUT’S TECHNICAL SPECIFICATIONS ..... 3

2.4. ASSOCIATED ANTENNA DESCRIPTIONS ..... 3

2.5. LIST OF EUT’S PORTS ..... 3

2.6. ANCILLARY EQUIPMENT ..... 4

**EXHIBIT 3. EUT OPERATING CONDITIONS AND CONFIGURATIONS DURING TESTS ..... 5**

3.1. CLIMATE TEST CONDITIONS ..... 5

3.2. OPERATIONAL TEST CONDITIONS & ARRANGEMENT FOR TESTS..... 5

**EXHIBIT 4. SUMMARY OF TEST RESULTS ..... 6**

4.1. LOCATION OF TESTS ..... 6

4.2. APPLICABILITY & SUMMARY OF EMC EMISSION TEST RESULTS ..... 6

4.3. DEVIATION OF STANDARD TEST PROCEDURES ..... 6

4.4. MODIFICATIONS INCORPORATED IN THE EUT FOR COMPLIANCE PURPOSES..... 6

**EXHIBIT 5. TEST DATA..... 7**

5.1. OCCUPIED BANDWIDTH [§ 15.247(A)(2)], RSS 247-5.2(A) ..... 7

5.1.1. *Limit(s)* ..... 7

5.1.2. *Method of Measurements*..... 7

5.1.3. *Test Arrangement* ..... 7

5.1.4. *Test Equipment List* ..... 7

5.1.5. *Test Data* ..... 8

5.2. PEAK CONDUCTED OUTPUT POWER - DTS [§ 15.247(B)(3)], RSS 247-5.4 (D)..... 11

5.2.1. *Limit(s)* ..... 11

5.2.2. *Method of Measurements*..... 11

5.2.3. *Test Arrangement* ..... 11

5.2.4. *Test Equipment List* ..... 11

5.2.5. *Test Data* ..... 12

5.2.6. *Duty Cycle Analysis (2.48 GHz)*..... 15

5.3. TRANSMITTER BAND-EDGE & SPURIOUS CONDUCTED EMISSIONS [§ 15.247(D)], RSS 247-5.5 ..... 17

5.3.1. *Limit(s)* ..... 17

5.3.2. *Method of Measurements*..... 17

5.3.3. *Test Arrangement* ..... 17

5.3.4. *Test Equipment List* ..... 18

5.3.5. *Test Data* ..... 18

5.4. TRANSMITTER SPURIOUS RADIATED EMISSIONS AT 3 METERS [§§ 15.247(D), 15.209 & 15.205] RSS 247-3.3, 5.5, RSS GEN 8.10 ..... 42

5.4.1. *Limit(s)* ..... 42

**ULTRATECH GROUP OF LABS**

3000 Bristol Circle, Oakville, Ontario, Canada L6H 6G4  
Tel. #: 905-829-1570, Fax. #: 905-829-8050, Email: [vic@ultratech-labs.com](mailto:vic@ultratech-labs.com), Website: <http://www.ultratech-labs.com>

File #: 21Q5X071\_F15.247C  
January 20, 2021

*All test results contained in this engineering test report are traceable to National Institute of Standards and Technology (NIST)*

5.4.2. *Method of Measurements*..... 43

5.4.3. *Test Arrangement* ..... 43

5.4.4. *Test Equipment List* ..... 43

5.4.5. *Test Data* ..... 44

5.5. POWER SPECTRAL DENSITY [§ 15.247(E)], RSS 247-5.2 (B) ..... 46

5.5.1. *Limit(s)* ..... 46

5.5.2. *Method of Measurements*..... 46

5.5.3. *Test Arrangement* ..... 46

5.5.4. *Test Equipment List* ..... 46

5.5.5. *Test Data* ..... 47

5.6. RF EXPOSURE REQUIRMENTS [ §§ 15.247(I), 1.1310 & 2.1091] RSS GEN 3.4, RSS 102..... 50

5.7. POWER LINE CONDUCTED EMISSIONS [§15.207(A)], RSS GEN-8.8 ..... 53

5.7.1. *Limit(s)* ..... 53

5.7.2. *Method of Measurements*..... 53

5.7.3. *Test Equipment* ..... 53

5.7.4. *Test Arrangement* ..... 53

5.7.5. *Test Data* ..... 54

5.8. RADIATED EMISSIONS –UNINTENTIONAL @ ICES-003 ..... 58

5.8.1. *Limits* ..... 58

5.8.2. *Method of Measurements*..... 58

5.8.3. *Test Equipment* ..... 58

5.8.4. *Test Arrangement* ..... 59

5.8.5. *Test Data* ..... 59

**EXHIBIT 6. MEASUREMENT UNCERTAINTY..... 60**

6.1. LINE CONDUCTED EMISSION MEASUREMENT UNCERTAINTY ..... 60

6.2. RADIATED EMISSION MEASUREMENT UNCERTAINTY ..... 60

**EXHIBIT 1. INTRODUCTION**

**1.1. SCOPE**

<b>Reference:</b>	FCC Part 15, Subpart C, Section 15.247
<b>Title:</b>	Code of Federal Regulations (CFR), Title 47 – Telecommunication, Part 15 – Radio Frequency Devices
<b>Purpose of Test:</b>	Equipment Certification for Digital Modulation Systems (DTS) Operating Under §15.247
<b>Test Procedures:</b>	<ul style="list-style-type: none"> <li>▪ ANSI C63.4</li> <li>▪ ANSI C63.10</li> <li>▪ FCC KDB Publication No. 558074 D01 15.247 Meas Guidance v05r02</li> </ul>
<b>Environmental Classification:</b>	<input checked="" type="checkbox"/> Commercial, industrial or business environment <input checked="" type="checkbox"/> Residential environment

**1.2. RELATED SUBMITTAL(S)/GRANT(S)**

None.

**1.3. NORMATIVE REFERENCES**

Publication	Year	Title
47 CFR Parts 0-19	2020	Code of Federal Regulations (CFR), Title 47 – Telecommunication
ANSI C63.4	2014	American National Standard for Methods of Measurement of Radio-Noise Emissions from Low-Voltage Electrical and Electronic Equipment in the Range of 9 KHz to 40 GHz
ANSI C63.10	2013	American National Standard of Procedures for Compliance Testing of Unlicensed Wireless Devices
FCC, KDB Publication No. 558074 D01 15.247 Meas Guidance v05r02	2019	Guidance for compliance measurements on digital transmission system, frequency hopping spread spectrum system, and hybrid system devices operating under section 15.247 of the fcc rules
RSS-Gen, Issue 5	2019	General Requirements for Compliance of Radio Apparatus
RSS-247, Issue 2	2017	Digital Transmission Systems (DTSs), Frequency Hopping Systems (FHSs) and Licence-Exempt Local Area Network (LE-LAN) Devices
ICES-003, Issue 6	2016	Information Technology Equipment (Including Digital Apparatus) – Limits and methods of measurement

**EXHIBIT 2. PERFORMANCE ASSESSMENT**  
**2.1. CLIENT INFORMATION**

<b>Applicant</b>	
<b>Name:</b>	Quantum5x Systems Inc.
<b>Address:</b>	30 Adelaide Street North Suite 12 London, Ontario Canada N6B 3N5
<b>Contact Person:</b>	Mr. Paul Johnson Phone #: 519-675-6999 Fax #: 519-667-2162 Email Address: <a href="mailto:paul@g5x.com">paul@g5x.com</a>

<b>Manufacturer</b>	
<b>Name:</b>	Quantum5x Systems Inc.
<b>Address:</b>	30 Adelaide Street North Suite 12 London, Ontario Canada N6B 3N5
<b>Contact Person:</b>	Mr. Paul Johnson Phone #: 519-675-6999 Fax #: 519-667-2162 Email Address: <a href="mailto:paul@g5x.com">paul@g5x.com</a>

**2.2. EQUIPMENT UNDER TEST (EUT) INFORMATION**

The following information (with the exception of the Date of Receipt) has been supplied by the applicant.

<b>Brand Name:</b>	Quantum5x Systems Inc.
<b>Model Name or Number:</b>	QT-AD10 Family representative sample*
<b>Serial Number:</b>	Sample #124, prototype sample for QT-AD10 2.4GHz radio
<b>Type of Equipment:</b>	Digital Transmission System (DTS)
<b>Input Power Supply Type:</b>	Lithium-Ion Battery / External DC Power
<b>Primary User Functions of EUT:</b>	The Primary use is to broadcast audio from the user.

\*Prototype test sample representing all models of the family was provided by the applicant for intentional radiator testing.

**2.3. EUT’S TECHNICAL SPECIFICATIONS**

<b>Transmitter</b>	
<b>Equipment Type:</b>	Portable and Mobile
<b>Intended Operating Environment:</b>	Commercial, industrial or business environment
<b>Power Supply Requirement:</b>	3.7 V Lithium-Ion battery/ 5 VDC via AC adapter
<b>RF Output Power Rating:</b>	16.62 dBm (45.92 mW)
<b>Operating Frequency Range:</b>	2405 – 2480 MHz
<b>RF Output Impedance:</b>	50 Ω
<b>Duty Cycle:</b>	3.458%
<b>Modulation Type:</b>	IEEE 802.15.4 Direct sequence spread spectrum(MSK)
<b>Antenna Connector Types:</b>	Integral(MH-4L internal) / SSMA connector

**2.4. ASSOCIATED ANTENNA DESCRIPTIONS**

<b>Antenna Type</b>	<b>Maximum Gain (dBi)</b>
¼ Wave wire UHF	2

**2.5. LIST OF EUT’S PORTS**

<b>Port Number</b>	<b>EUT’s Port Description</b>	<b>Number of Identical Ports</b>	<b>Connector Type</b>	<b>Cable Type (Shielded/Non-shielded)</b>
1	Audio Connector	1	Single Pin Lemo	4” min length, Shielded
2	UHF Antenna	1	Hardwired	129mm
3	802.15.4 Antenna	1	Hardwired	30mm
4	Battery Charger	1	Micro USB	<3 feet - Shielded

**2.6. ANCILLARY EQUIPMENT**

The EUT was tested while connected to the following representative configuration of ancillary equipment necessary to exercise the ports during tests:

<b>Ancillary Equipment # 1</b>	
Description:	AC/DC Adapter 5 V, 500 mA
Brand name:	Emerson Network Power
Model Name or Number:	DCH3-050US-0002
Serial#	010138
Connected to EUT's Port:	Micro USB

<b>Ancillary Equipment # 2</b>	
Description:	Remote Gateway
Brand name:	Q5X
Model Name or Number:	QG-N3
Connected to EUT's Port:	Wirelessly

<b>Ancillary Equipment # 3</b>	
Description:	Laptop
Brand name:	Acer
Model Name or Number:	D270-1998
Serial#	NUSGAAA 0012281 DF327614
Connected to EUT's Port:	N/A

**EXHIBIT 3. EUT OPERATING CONDITIONS AND CONFIGURATIONS DURING TESTS****3.1. CLIMATE TEST CONDITIONS**

The climate conditions of the test environment are as follows:

Temperature:	21 to 23 °C
Humidity:	45 to 58%
Pressure:	102 kPa
Power Input Source:	3.7 V Lithium-Ion battery / 5 VDC via AC adapter

**3.2. OPERATIONAL TEST CONDITIONS & ARRANGEMENT FOR TESTS**

<b>Operating Modes:</b>	The transmitter was operated in a continuous transmission mode with the carrier modulated as specified in the Test Data.
<b>Special Test Software:</b>	Test software provided by the Applicant to operate the EUT at each channel frequency continuously and in the range of typical modes of operation.
<b>Special Hardware Used:</b>	N/A
<b>Transmitter Test Antenna:</b>	The EUT is tested with the antenna port terminated to a 50 Ohm RF Load.

<b>Transmitter Test Signals</b>	
<b>Frequency Band(s):</b>	2405 – 2480 MHz
<b>Frequency(ies) Tested:</b>	2405 MHz, 2440 MHz, 2475, MHz, 2480 MHz
<b>RF Power Output:</b> (measured maximum output power at antenna terminals)	16.62 dBm Peak
<b>Normal Test Modulation:</b>	MSK
<b>Modulating Signal Source:</b>	Internal



**EXHIBIT 4. SUMMARY OF TEST RESULTS**

**4.1. LOCATION OF TESTS**

All of the measurements described in this report were performed at Ultratech Group of Labs located in the city of Oakville, Province of Ontario, Canada.

AC Power Line Conducted Emissions were performed in UltraTech's shielded room, 24'(L) by 16'(W) by 8'(H).

Radiated Emissions were performed at the Ultratech's 3-10 TDK Semi-Anechoic Chamber situated in the Town of Oakville, province of Ontario. This test site been calibrated in accordance with ANSI C63.4, and found to be in compliance with the requirements of Sec. 2.948 of the FCC Rules. The descriptions and site measurement data of the Oakville 3-10 TDK Semi-Anechoic Chamber has been filed with ANAB File No.: AT-1945.

**4.2. APPLICABILITY & SUMMARY OF EMC EMISSION TEST RESULTS**

FCC 15/ RSS Section(s)	Test Requirements	Compliance (Yes/No)
15.203 RSS-Gen, Section 6.8	Antenna requirements	Yes
15.207(a), RSS-Gen, Section 8.8	AC Power Line Conducted Emissions	Yes
15.247(a)(2) RSS-247, Section 5.2(a)	6 dB Bandwidth	Yes
15.247(b)(3) RSS-247, Section 5.4	Peak Conducted Output Power - DTS	Yes
15.247(d) RSS-247, Section 5.5	Band-Edge and RF Conducted Spurious Emissions at the Transmitter Antenna Terminal	Yes
15.247(d), 15.209 & 15.205 RSS-247, Section 5.5	Transmitter Spurious Radiated Emissions	Yes
15.247(e) RSS-247, Section 5.2(a)	Power Spectral Density	Yes
1.1307, 1.1310, 2.1091 & 2.1093 RSS-Gen, Section 3.4, RSS-102	RF Exposure	Yes

**4.3. DEVIATION OF STANDARD TEST PROCEDURES**

None

**4.4. MODIFICATIONS INCORPORATED IN THE EUT FOR COMPLIANCE PURPOSES**

None

**EXHIBIT 5. TEST DATA**

**5.1. OCCUPIED BANDWIDTH [§ 15.247(a)(2)], RSS 247-5.2(a)**

**5.1.1. Limit(s)**

The minimum 6 dB bandwidth shall be at least 500 kHz.

**5.1.2. Method of Measurements**

KDB 558074 D01 15.247 Meas Guidance v05r02, Section 8.2 DTS Bandwidth (11.8.1 Option 2 ANSI C63.10-2013)

**5.1.3. Test Arrangement**

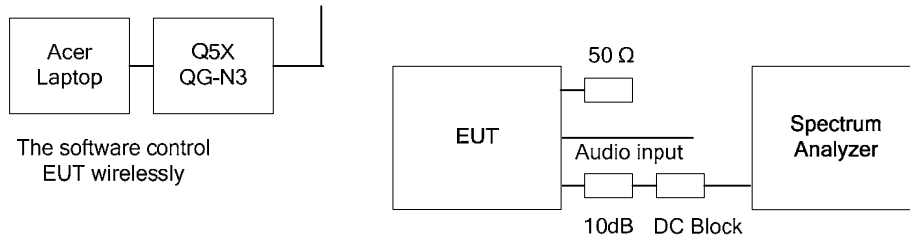

**5.1.4. Test Equipment List**

Test Instruments	Manufacturer	Model No.	Serial No.	Frequency Range	Calibration Due Date
Spectrum Analyzer	Rohde & Schwarz	FSU26	200946	20Hz–26.5 GHz	Jul 25, 2020
Attenuator	Hewlett Packard	8493C	0461	DC - 26.5 GHz	Cal on use
DC Block	Hewlett Packard	11742A	12460	0.045 – 26.5 GHz	Cal on use
Laptop	Acer	D270-1998	NUSGAAA 0012281 DF327614	0.045 – 26.5 GHz	-
Remote Gateway	Q5X	QG-N3	61719	-	-

5.1.5. Test Data

Modulation	Power Setting	Channel Number	Frequency (MHz)	6dB BW (MHz)	Min. Limit (kHz)
MSK	22	11	2405	1.68	500
		18	2440	1.71	500
		25	2475	1.66	500
	18	26	2480	1.58	500

Plot 5.1.5.1. 6 dB Bandwidth, Channel 11, 2405 MHz, MSK Modulation, Pulse RX PRBS9, Power Setting 22

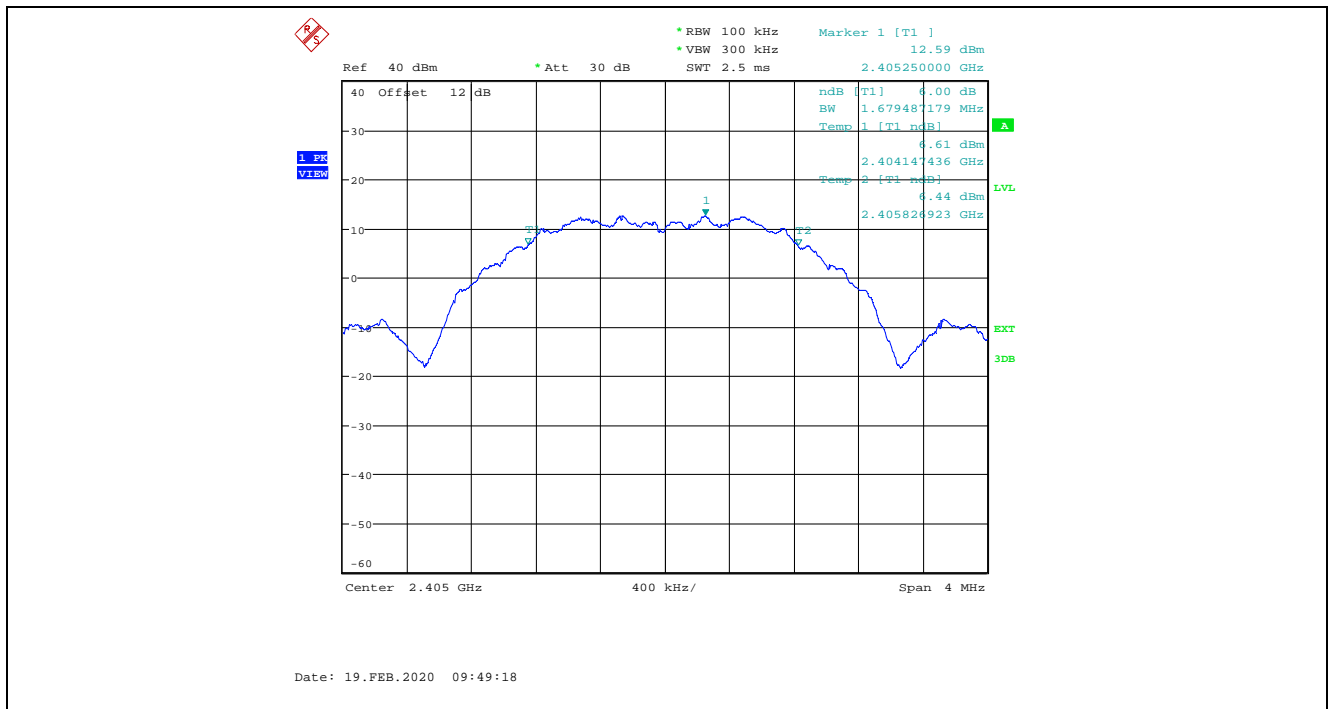

Plot 5.1.5.2. 6 dB Bandwidth, Channel 18, 2440 MHz, MSK Modulation, Pulse RX PRBS9, Power Setting 22

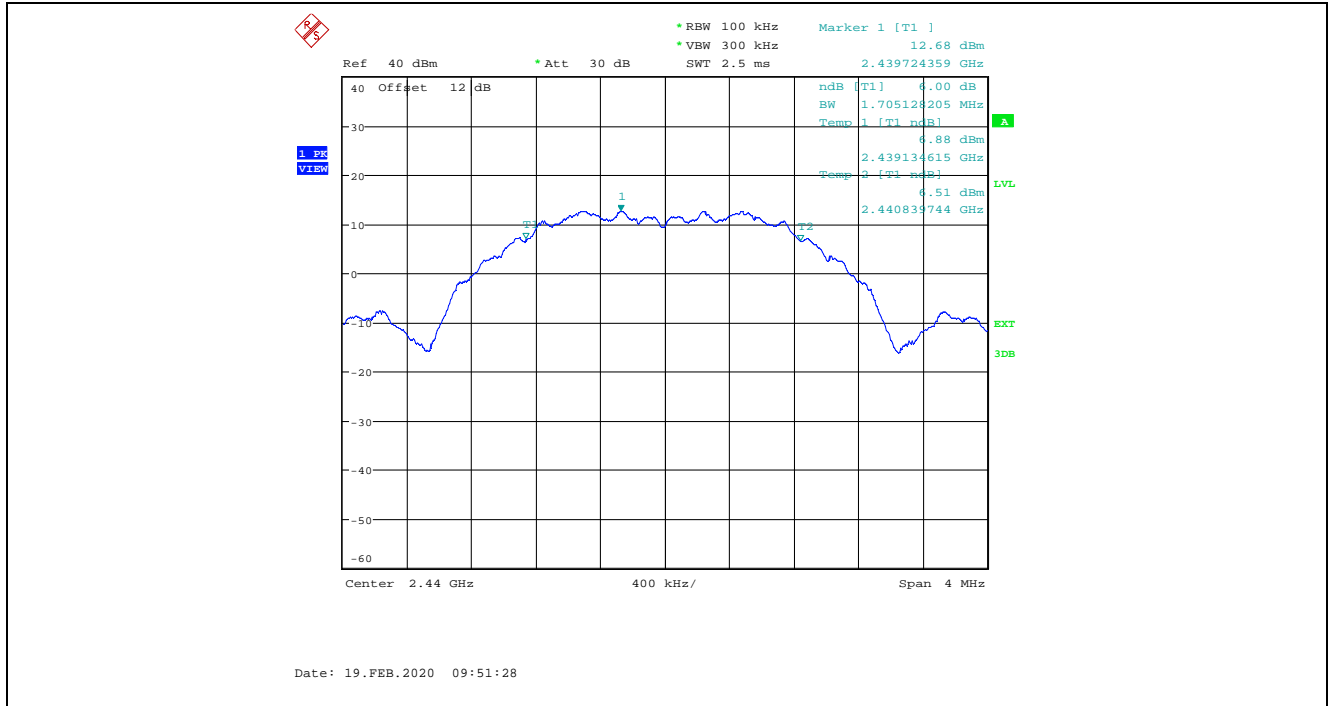

Plot 5.1.5.3. 6 dB Bandwidth, Channel 25, 2475 MHz, MSK Modulation, Pulse RX PRBS9, Power Setting 22

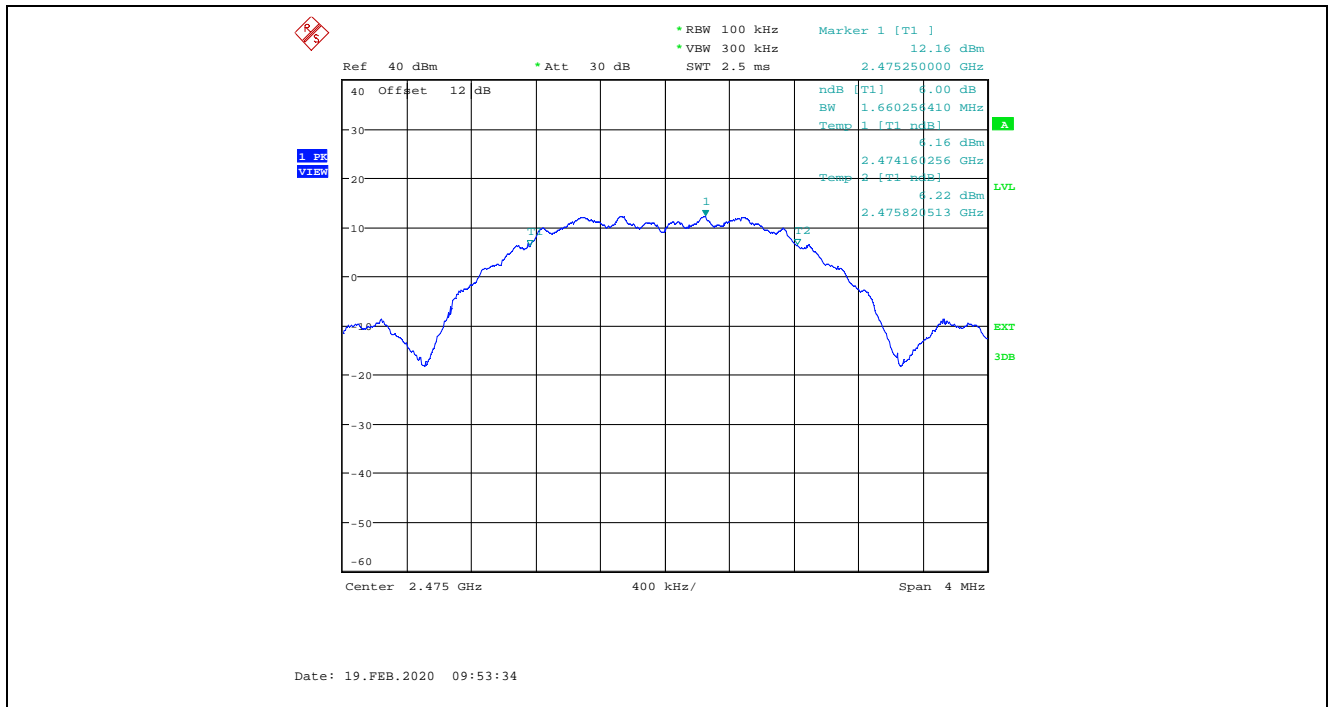

Plot 5.1.5.4. 6 dB Bandwidth, Channel 26, 2480 MHz, MSK Modulation, Pulse RX PRBS9, Power Setting 18

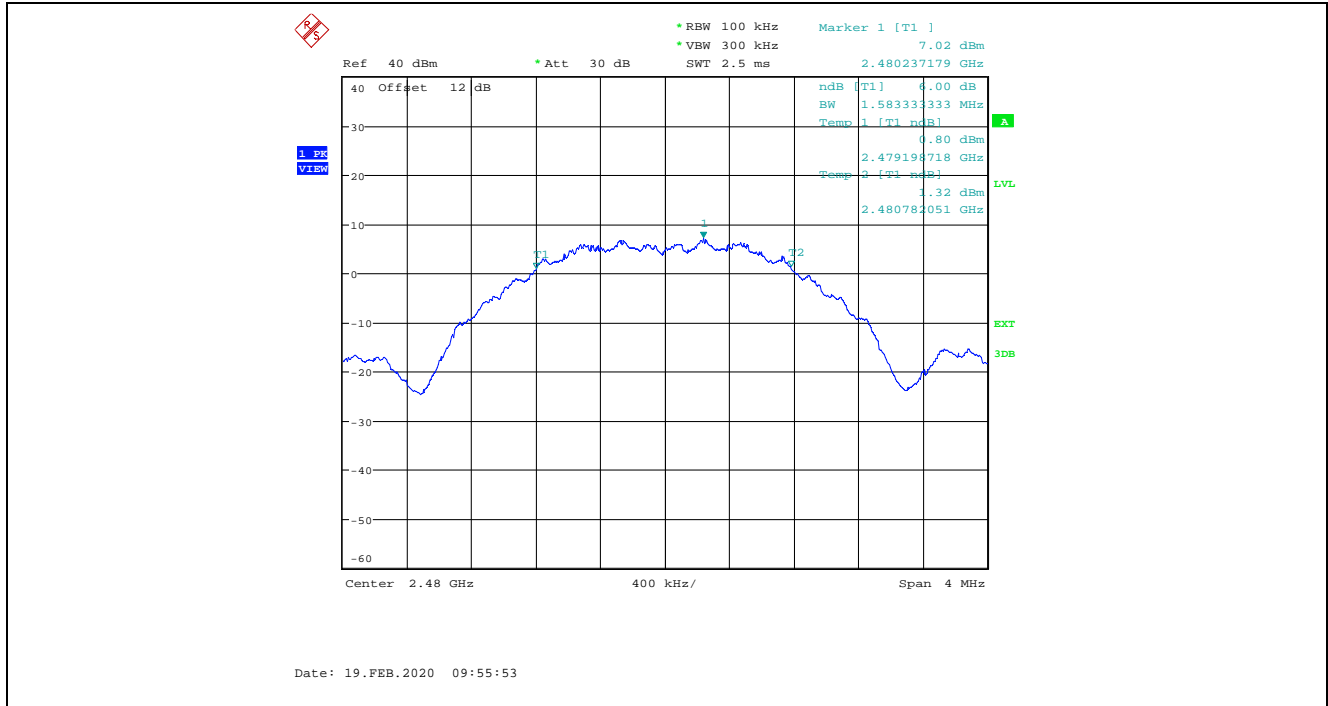

Note: Please refer to Annex 1 for the 99% OBW for ISED requirements as per RSS-Gen

**5.2. PEAK CONDUCTED OUTPUT POWER - DTS [§ 15.247(b)(3)], RSS 247-5.4 (d)**

**5.2.1. Limit(s)**

**§ 15.247(b)(3):** For systems using digital modulation in the 902-928 MHz, 2400-2483.5 MHz, and 5725-5850 MHz bands: 1 Watt. As an alternative to a peak power measurement, compliance with the one Watt limit can be based on a measurement of the maximum conducted output power. Maximum Conducted Output Power is defined as the total transmit power delivered to all antennas and antenna elements averaged across all symbols in the signaling alphabet when the transmitter is operating at its maximum power control level. Power must be summed across all antennas and antenna elements. The average must not include any time intervals during which the transmitter is off or is transmitting at a reduced power level. If multiple modes of operation are possible (e.g., alternative modulation methods), the *maximum conducted output power* is the highest total transmit power occurring in any mode.

**5.2.2. Method of Measurements**

KDB 558074 D01 15.247 Meas Guidance v05r02, Section 8.3.1.1 RBW ≥ DTS bandwidth, Sub clause 11.9.1.1 of ANSI C63.10

**5.2.3. Test Arrangement**

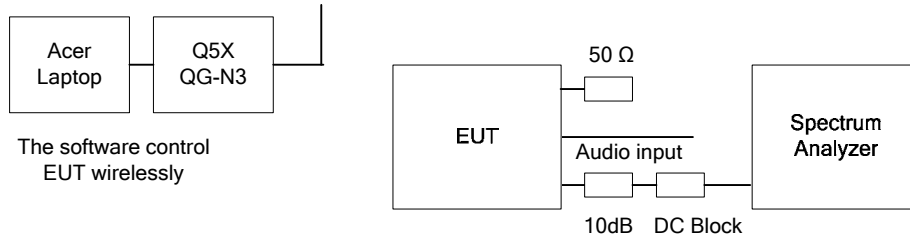

**5.2.4. Test Equipment List**

Test Instruments	Manufacturer	Model No.	Serial No.	Frequency Range	Calibration Due Date
Spectrum Analyzer	Rohde & Schwarz	FSU26	200946	20Hz–26.5 GHz	Jul 25, 2020
Attenuator	Hewlett Packard	8493C	0461	DC - 26.5 GHz	Cal on use
DC Block	Hewlett Packard	11742A	12460	0.045 – 26.5 GHz	Cal on use
Band Reject Filter	Micro-Tronics	BRM50701	105	Cut off 2.4-2.483 GHz	Cal on use
High Pass Filter	K & L	11SH10-4000/T12000	4	Cut off 2400 MHz	Cal on use
Remote Gateway	Q5X	QG-N3	61719	-	-

5.2.5. Test Data

Modulation	Power Setting	Channel Number	Frequency (MHz)	Max. Peak Conducted Output Power (dBm)	Limit (dBm)
MSK	22	11	2405	16.34	30
		18	2440	16.62	30
		25	2475	15.98	30
	18	26	2480	10.30	30

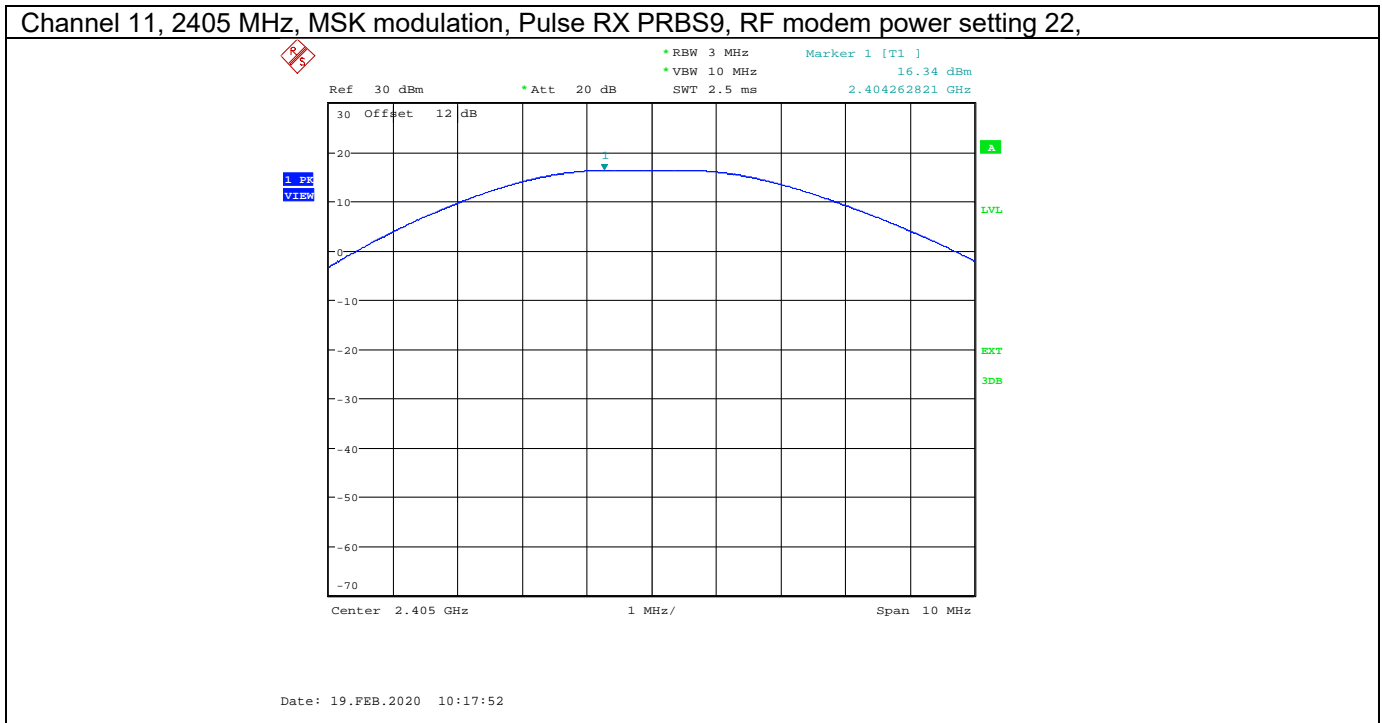

Channel 18, 2440 MHz, MSK modulation, Pulse RX PRBS9, RF modem power setting 22,

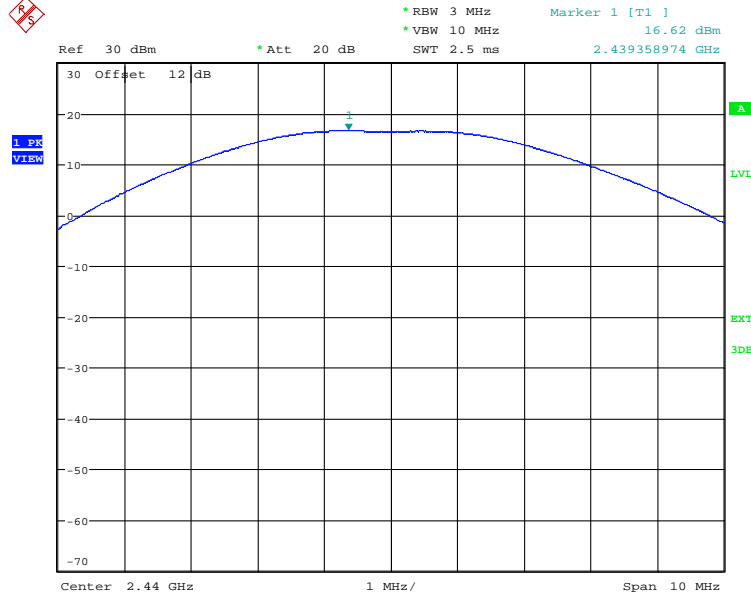

Date: 19.FEB.2020 10:19:41

Channel 25, 2475 MHz, MSK modulation, Pulse RX PRBS9, RF modem power setting 22,

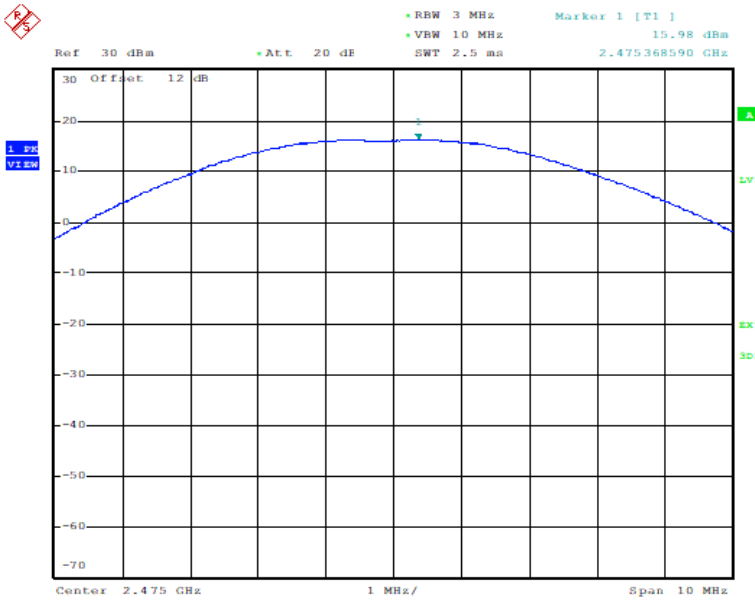

Date: 19.FEB.2020 10:24:38

**ULTRATECH GROUP OF LABS**

3000 Bristol Circle, Oakville, Ontario, Canada L6H 6G4  
Tel. #: 905-829-1570, Fax. #: 905-829-8050, Email: [vic@ultratech-labs.com](mailto:vic@ultratech-labs.com), Website: <http://www.ultratech-labs.com>

File #: 21Q5X071\_F15.247C

January 20, 2021

All test results contained in this engineering test report are traceable to National Institute of Standards and Technology (NIST)



Channel 26, 2480 MHz, MSK modulation, Pulse RX PRBS9, RF modem power setting 18,

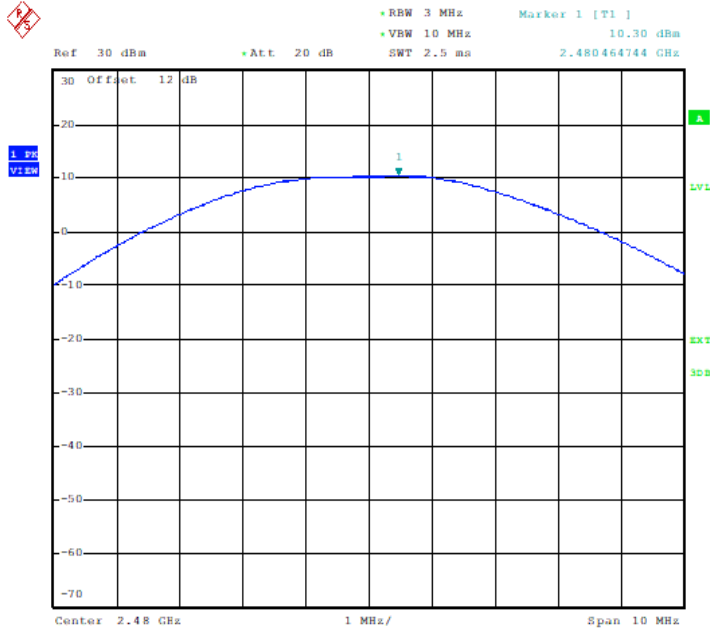

Date: 19.FEB.2020 10:26:38

**ULTRATECH GROUP OF LABS**

3000 Bristol Circle, Oakville, Ontario, Canada L6H 6G4  
Tel. #: 905-829-1570, Fax. #: 905-829-8050, Email: [vic@ultratech-labs.com](mailto:vic@ultratech-labs.com), Website: <http://www.ultratech-labs.com>

File #: 21Q5X071\_F15.247C

January 20, 2021

All test results contained in this engineering test report are traceable to National Institute of Standards and Technology (NIST)

### 5.2.6. Duty Cycle Analysis (2.48 GHz)

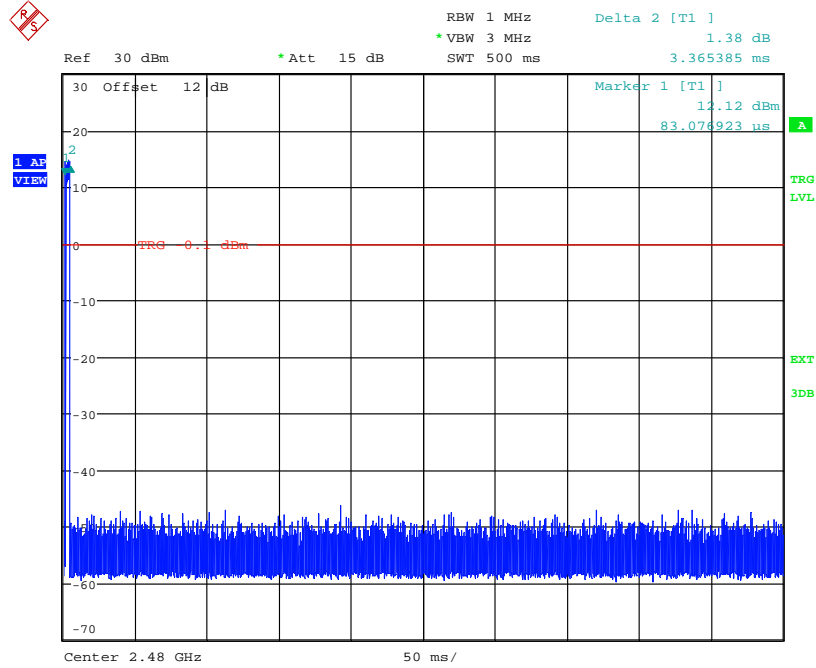

Date: 4.FEB.2020 12:05:00

500ms plot

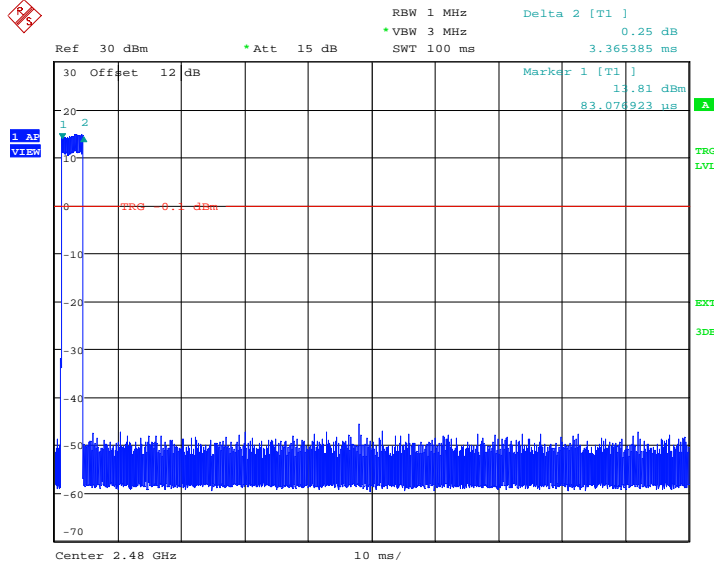

Date: 4.FEB.2020 11:51:59

100ms Plot

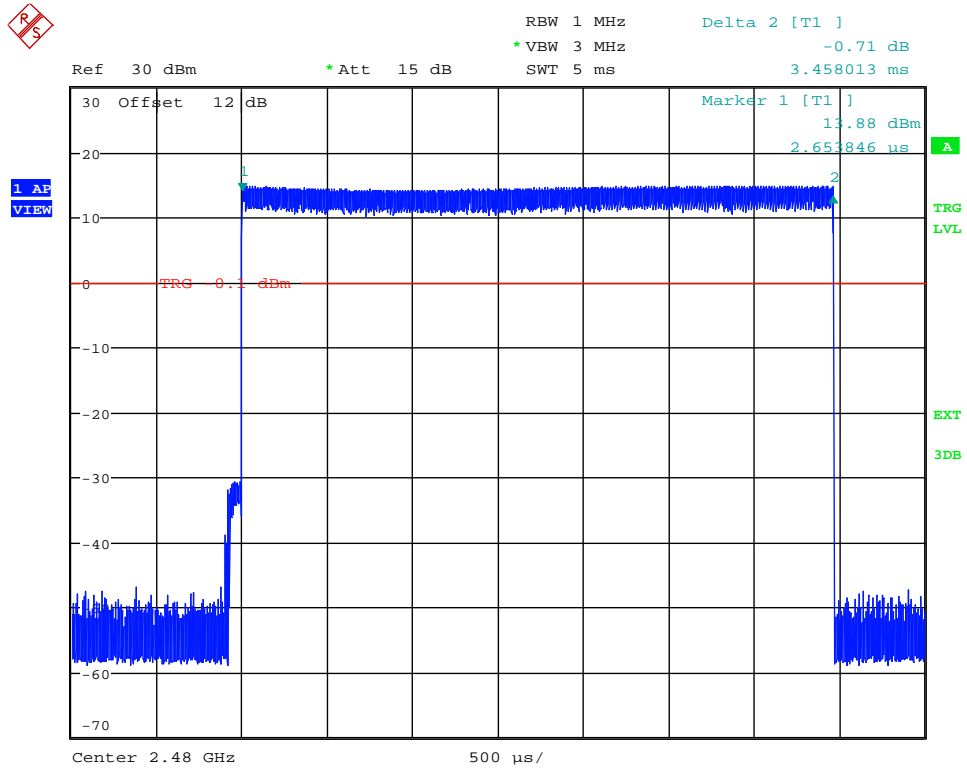

Date: 4.FEB.2020 11:48:55

On time plot

### Calculation

$$\text{Duty cycle} = \frac{T_{\text{on}}}{(T_{\text{on}} + T_{\text{off}})} = \frac{3.458}{100} = 0.03458 \text{ (3.458\%)}$$

**5.3. TRANSMITTER BAND-EDGE & SPURIOUS CONDUCTED EMISSIONS [§ 15.247(d)], RSS 247-5.5**

**5.3.1. Limit(s)**

**§ 15.247 (d):** In any 100 kHz bandwidth outside the frequency band in which the spread spectrum or digitally modulated intentional radiator is operating, the radio frequency power that is produced by the intentional radiator shall be at least 20 dB below that in the 100 kHz bandwidth within the band that contains the highest level of the desired power, based on either an RF conducted or a radiated measurement, provided the transmitter demonstrates compliance with the peak conducted power limits. If the transmitter complies with the conducted power limits based on the use of RMS averaging over a time interval, as permitted under paragraph (b)(3) of this section, the attenuation required under this paragraph shall be 30 dB instead of 20 dB. Attenuation below the general limits specified in §15.209(a) is not required. In addition, radiated emissions which fall in the restricted bands, as defined in §15.205(a), must also comply with the radiated emission limits specified in §15.209(a) (see §15.205(c)).

**5.3.2. Method of Measurements**

KDB 558074 D01 DTS Meas Guidance V05r02, Sections 8.7 ANSI C63.10 Sec 11.3

**5.3.3. Test Arrangement**

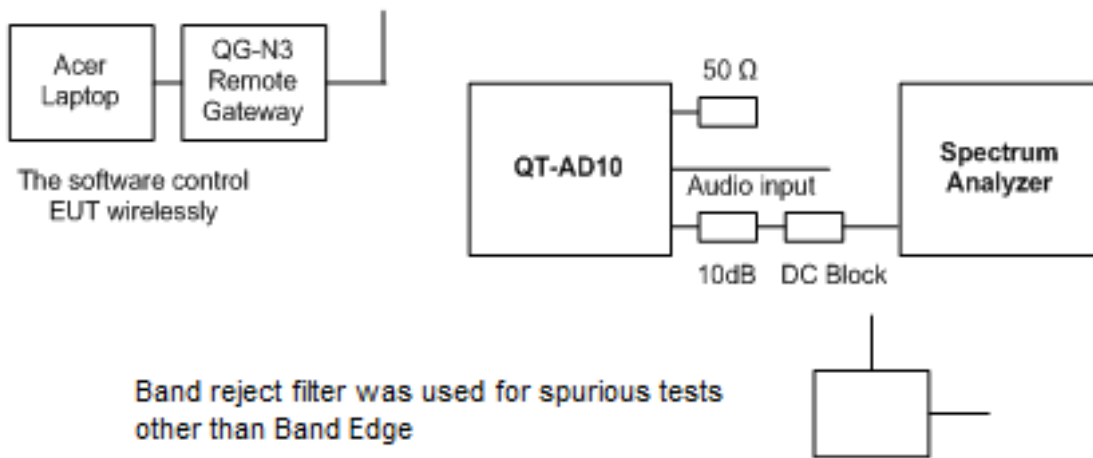

**5.3.4. Test Equipment List**

Test Instruments	Manufacturer	Model No.	Serial No.	Frequency Range	Calibration Due Date
Spectrum Analyzer	Rohde & Schwarz	FSU26	200946	20Hz–26.5 GHz	Jul 25, 2020
Attenuator	Hewlett Packard	8493C	0461	DC - 26.5 GHz	Cal on use
DC Block	Hewlett Packard	11742A	12460	0.045 – 26.5 GHz	Cal on use
Band Reject Filter	Micro-Tronics	BRM50701	105	Cut off 2.4-2.483 GHz	Cal on use
High Pass Filter	K & L	11SH10- 4000/T12000	4	Cut off 2400 MHz	Cal on use
Laptop	Acer	D270-1998	NUSGAAA 0012281 DF327614	0.045 – 26.5 GHz	-
Remote Gateway	Q5X	QG-N3	61719	-	-

**5.3.5. Test Data**

Remark(s): Exploratory tests performed to determined worst-case test configurations, the following test results represent the worst-case.

5.3.5.1. Band-Edge RF Conducted Emissions

Plot 5.3.5.1.1. Band-Edge RF Conducted Emissions, Lower Channel Frequency  
2405 MHz, MSK modulation Pulse RX PRBS9 Modulation, Power Setting 22

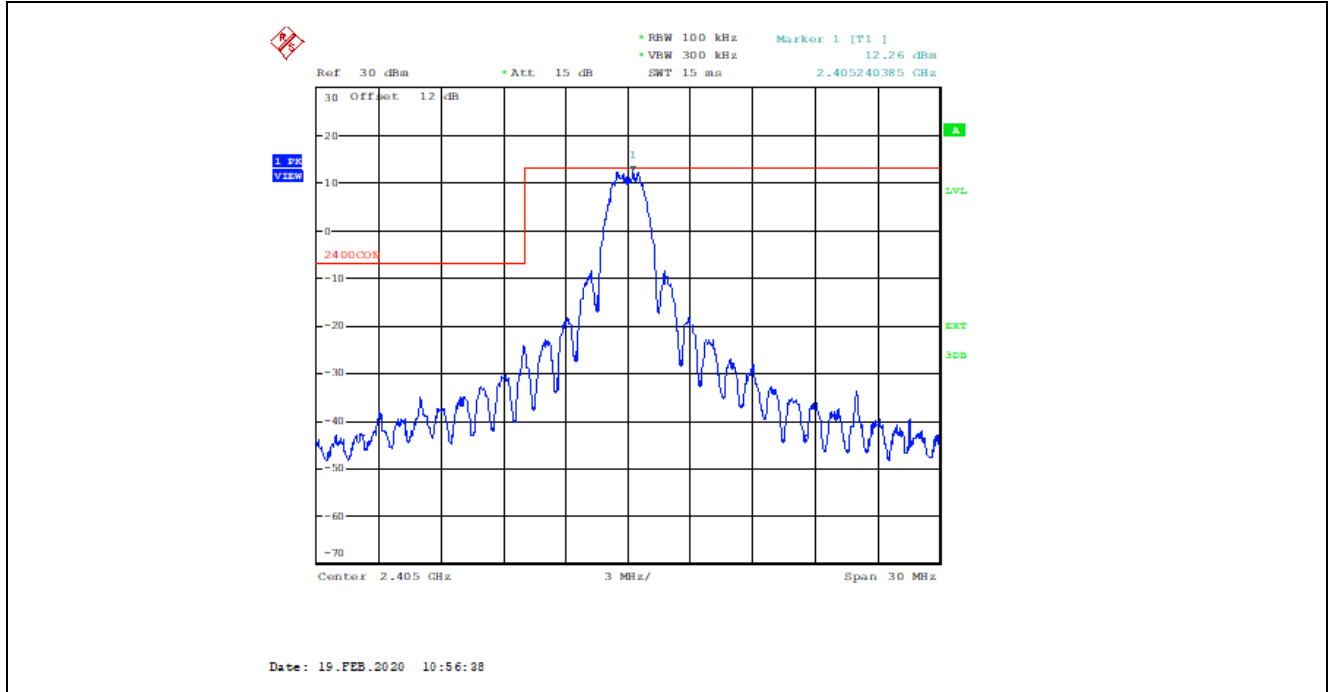

Plot 5.3.5.1.2. Band-Edge RF Conducted Emissions, Highest Channel Frequency  
2480 MHz, MSK modulation Pulse RX PRBS9 Modulation, Power Setting 18

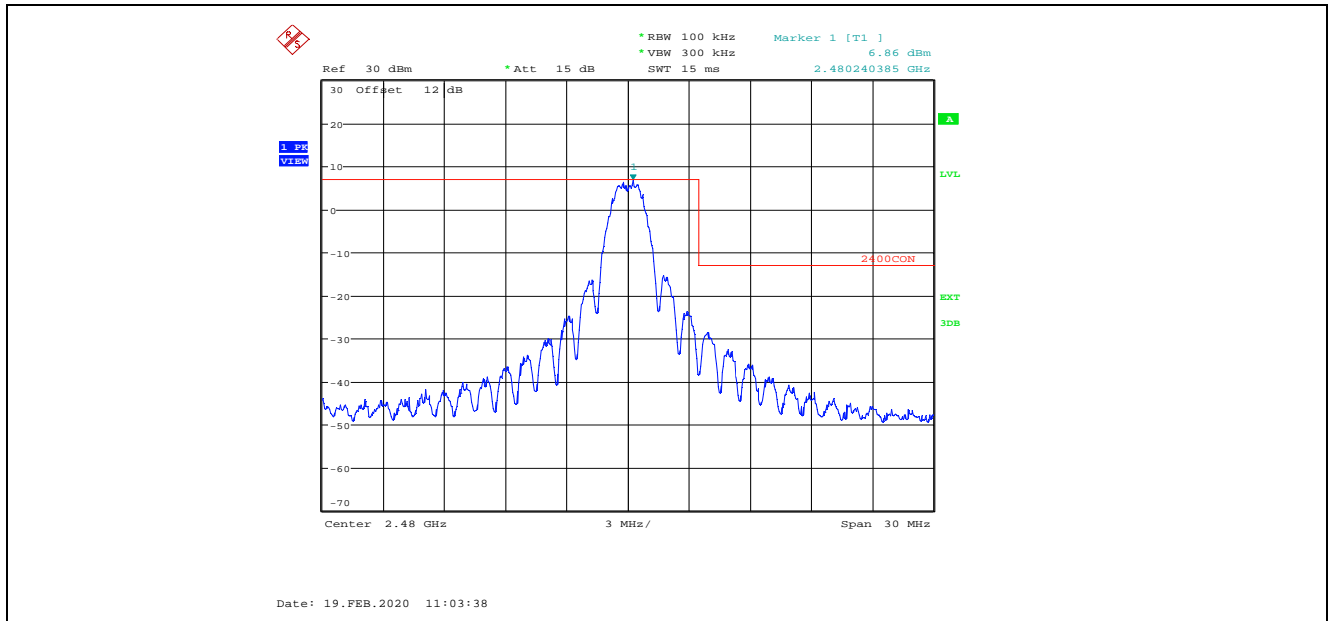

5.3.5.2. Spurious RF Conducted Emissions in Non-restricted Frequency Bands

Plot 5.3.5.2.1. Conducted Spurious Emissions in Non-restricted Frequency Bands 2405 MHz, MSK modulation Pulse RX PRBS9Channel 11, , Power Setting 22 , 30 MHz – 2.6 GHz

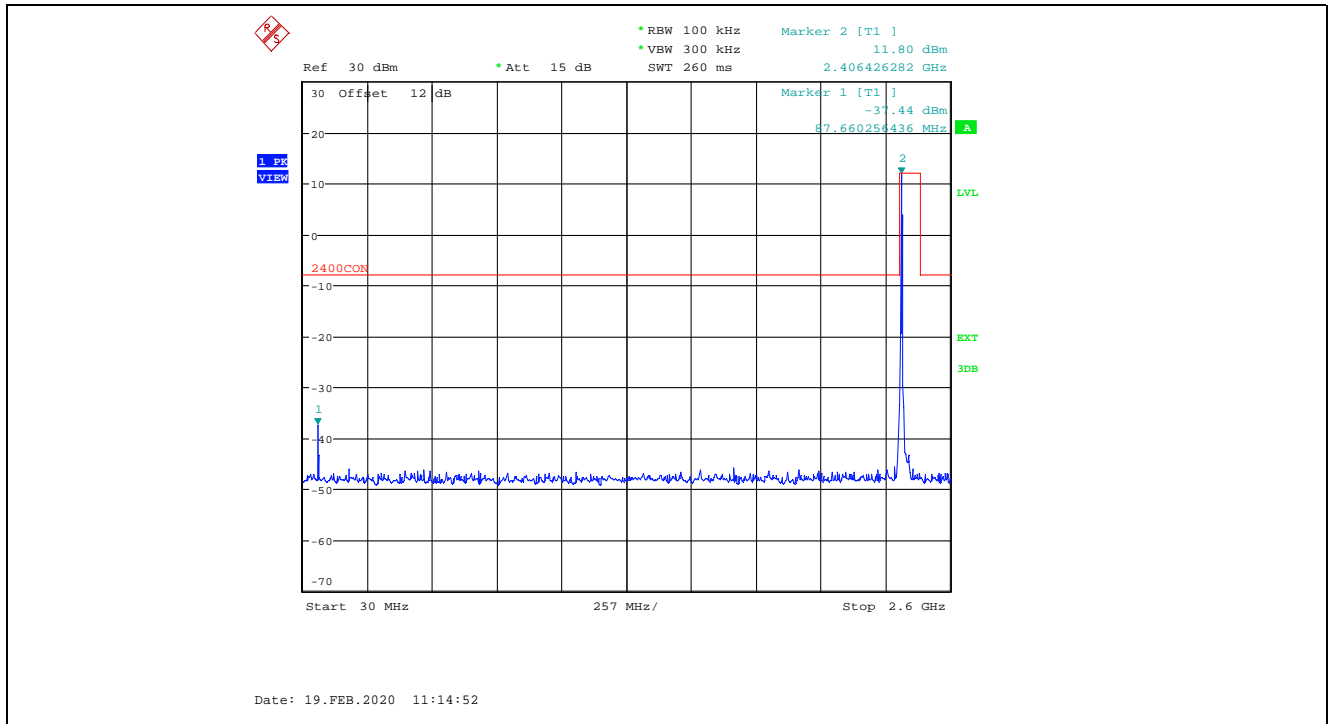

Plot 5.3.5.2.2. 2405 MHz, 2.6 GHz – 25 GHz

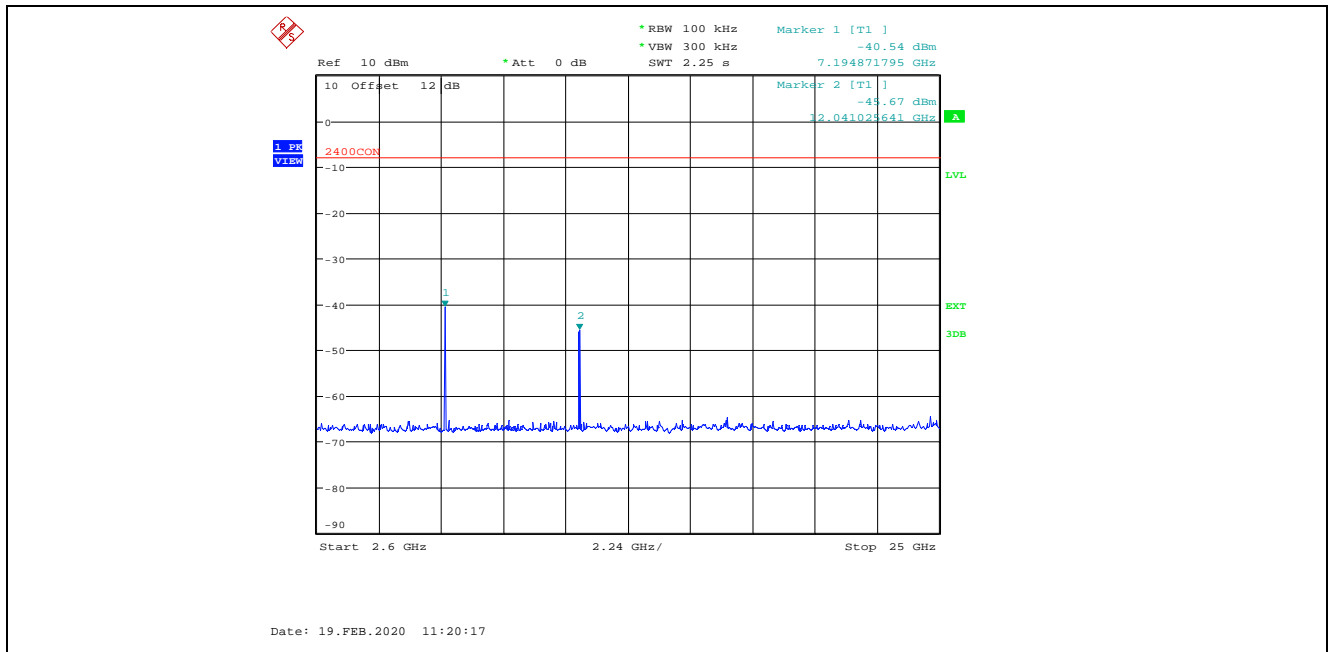

**Plot 5.3.5.2.3.** Conducted Spurious Emissions in Non-restricted Frequency Bands  
MSK modulation Pulse RX PRBS9 , Power Setting 22, Channel 18, 2440 MHz, 30 MHz – 2.6 GHz

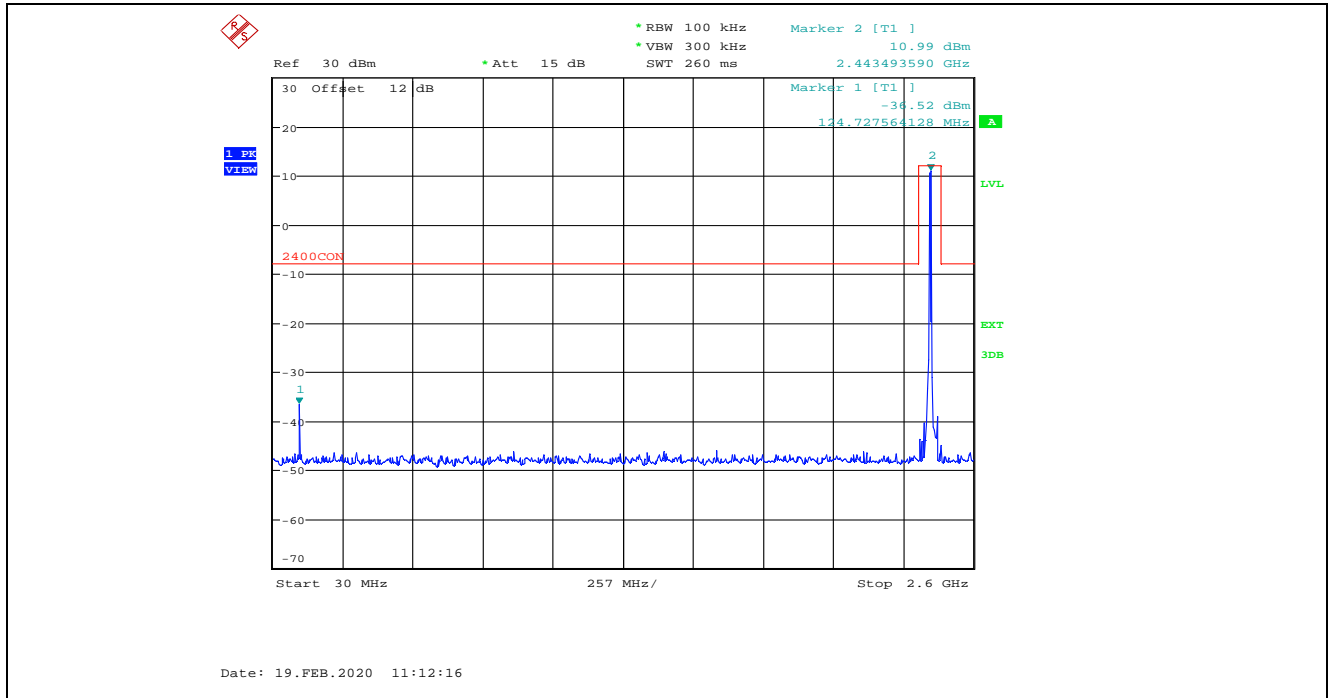

**Plot 5.3.5.2.4.** 2440 MHz, 2.6 GHz – 25 GHz

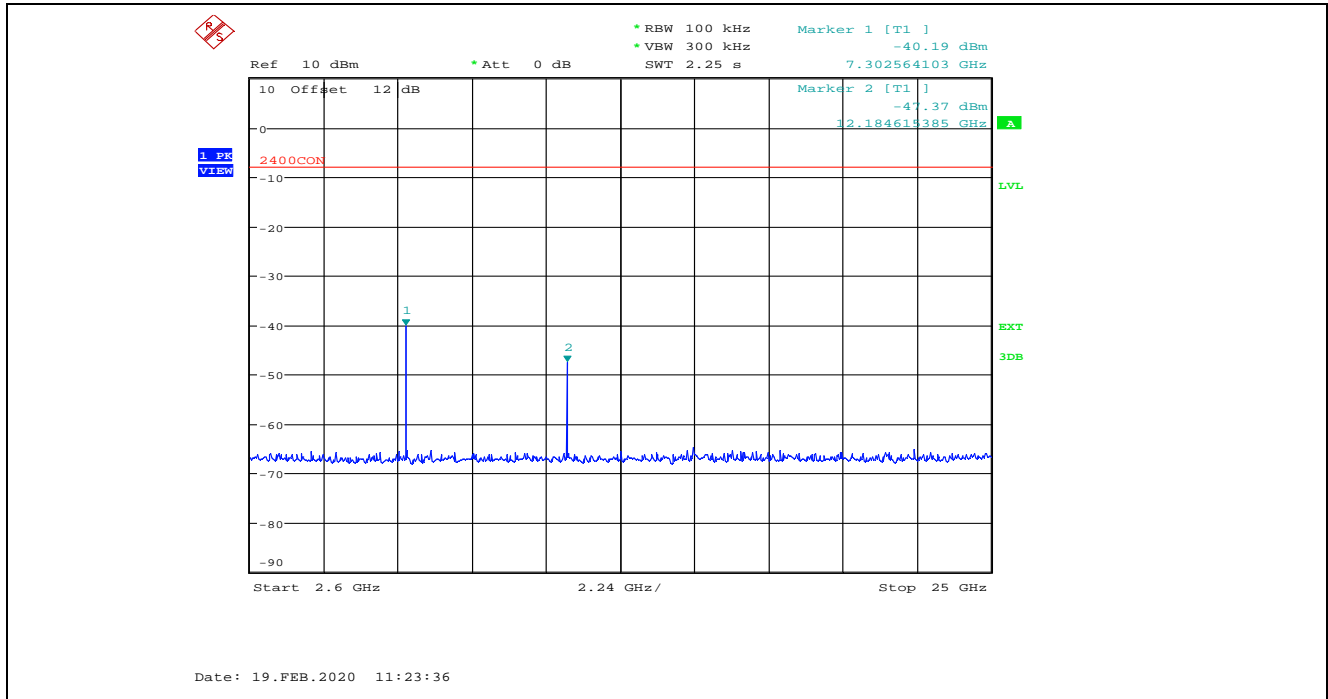



**Plot 5.3.5.2.5.** Conducted Spurious Emissions in Non-restricted Frequency Bands  
MSK modulation Pulse RX PRBS9, Power Setting 22, Channel 25, 2475 MHz, 30 MHz – 2.6 GHz

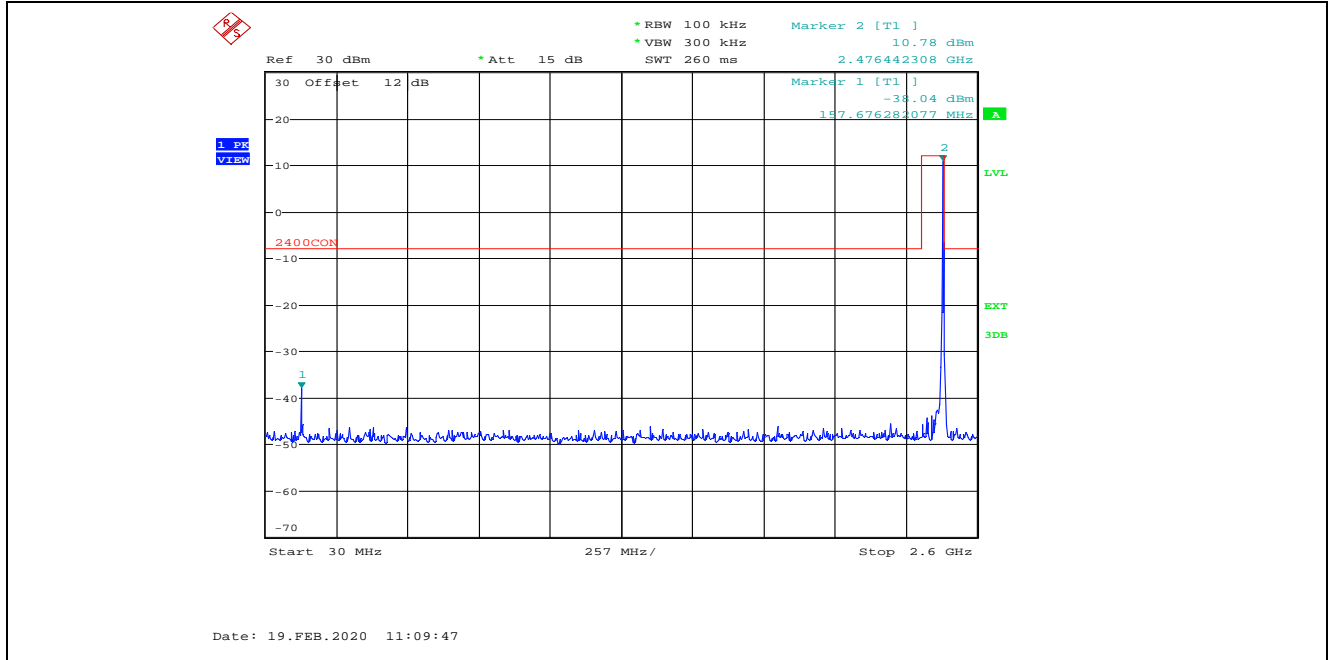

**Plot 5.3.5.2.6.** 2475 MHz, 2.6 GHz – 25 GHz

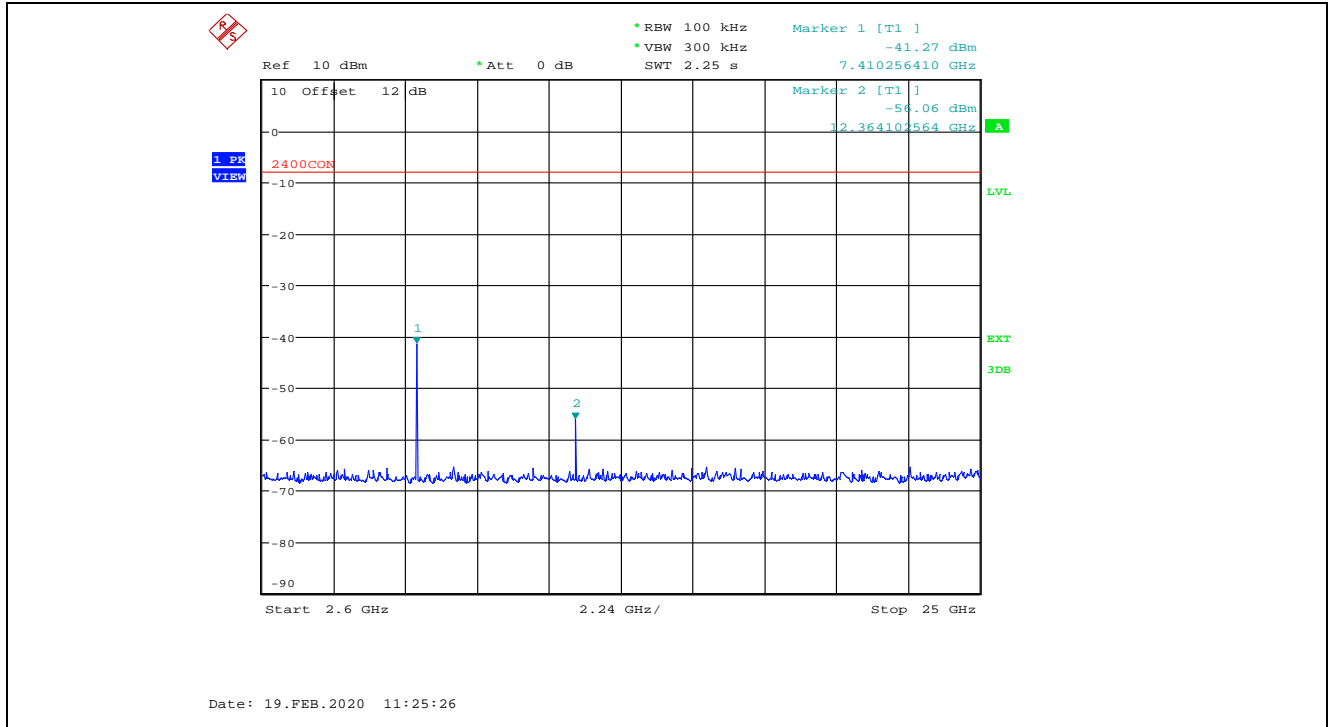

**Plot 5.3.5.2.7.** Conducted Spurious Emissions in Non-restricted Frequency Bands  
MSK modulation Pulse RX PRBS9, Power Setting 18, Channel 26, 2480 MHz, 30 MHz – 2.6 GHz

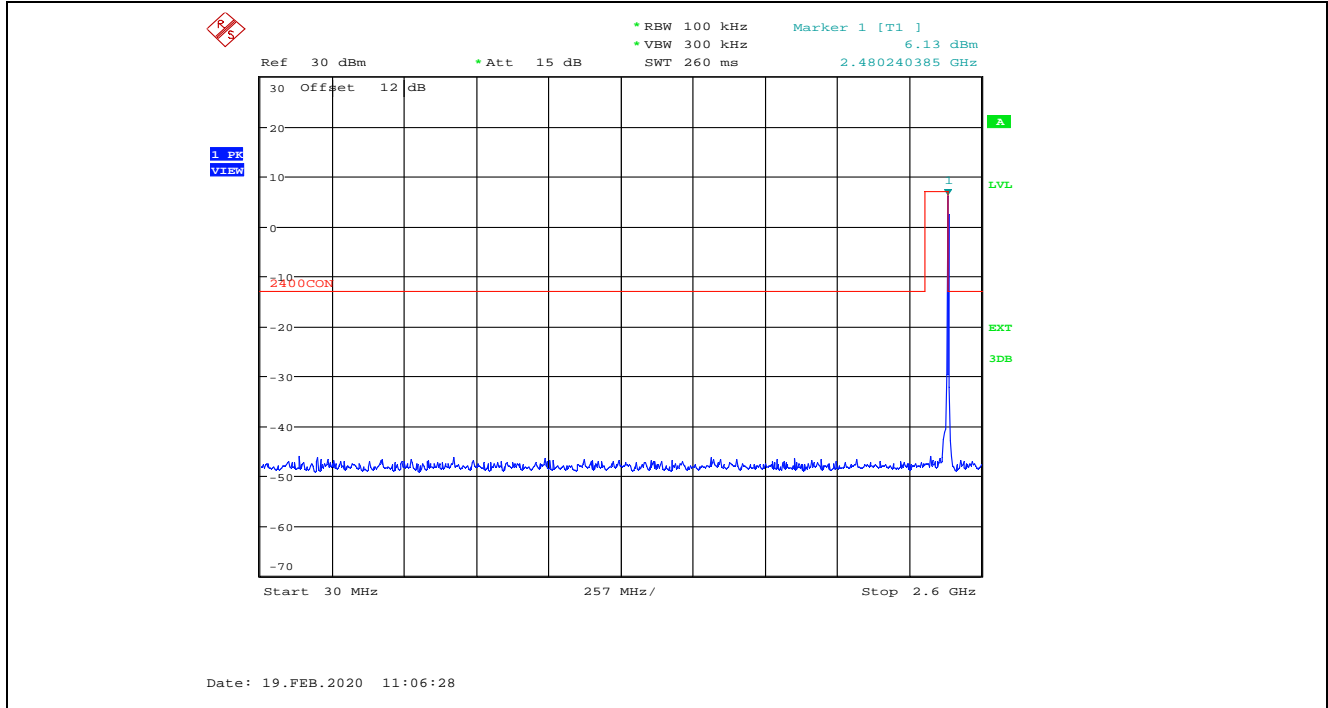

**Plot 5.3.5.2.8.** 2480 MHz, 2.6 GHz – 25 GHz

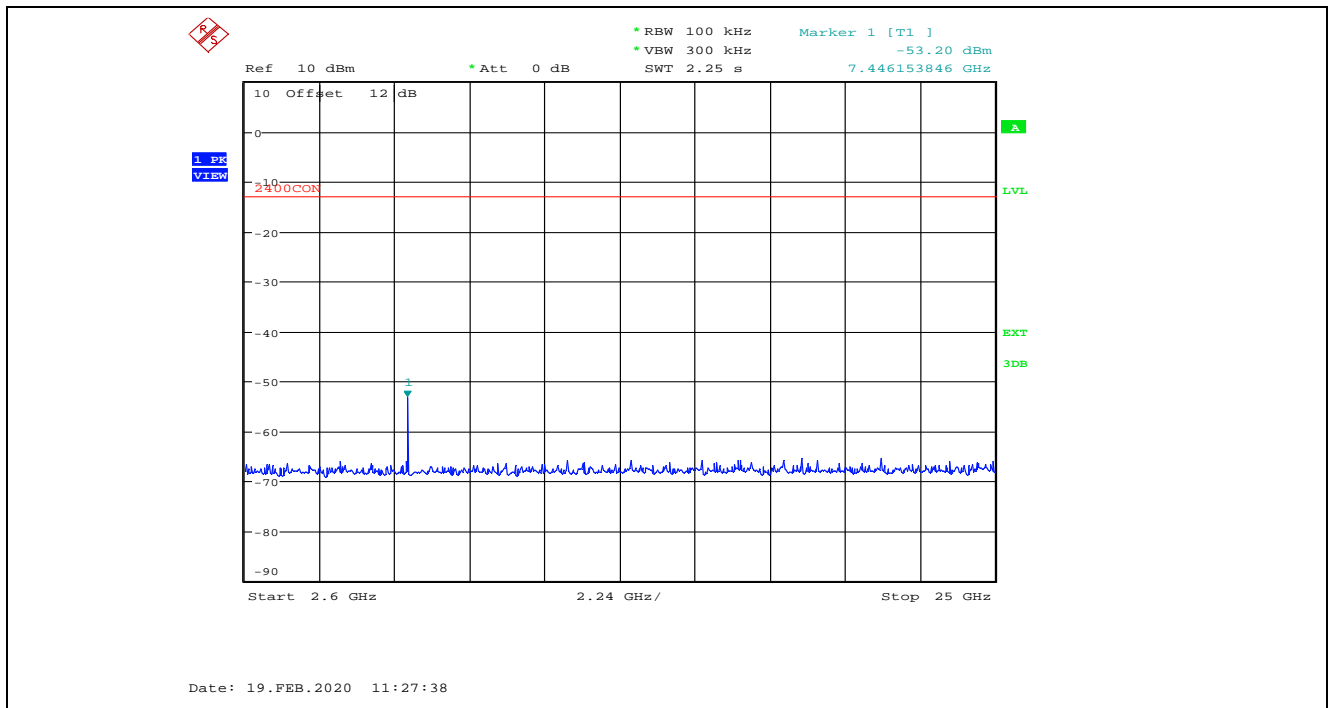

**5.3.5.3. Conducted Spurious Emissions in Restricted Frequency Bands, 2 dBi Antenna Gain**

**Remarks:** Offset = [Insertion Loss] + [Transmit Antenna Gain (in dBi)] + [Maximum Ground Reflection Factor]  
Testing cable loss: 11.96 dB, Antenna Gain: 2dBi, Maximum Ground Reflection Factor: 6dB ( $\leq 30$  MHz), 4.7 dB (30-1000MHz), 0 dB ( $>1000$  MHz)

**Plot 5.3.5.3.1.** Conducted Spurious Emissions in Restricted Frequency Bands  
Channel 11, 2405 MHz, MSK Modulation, Power Setting 22, 9 kHz - 30 MHz, Peak Detector

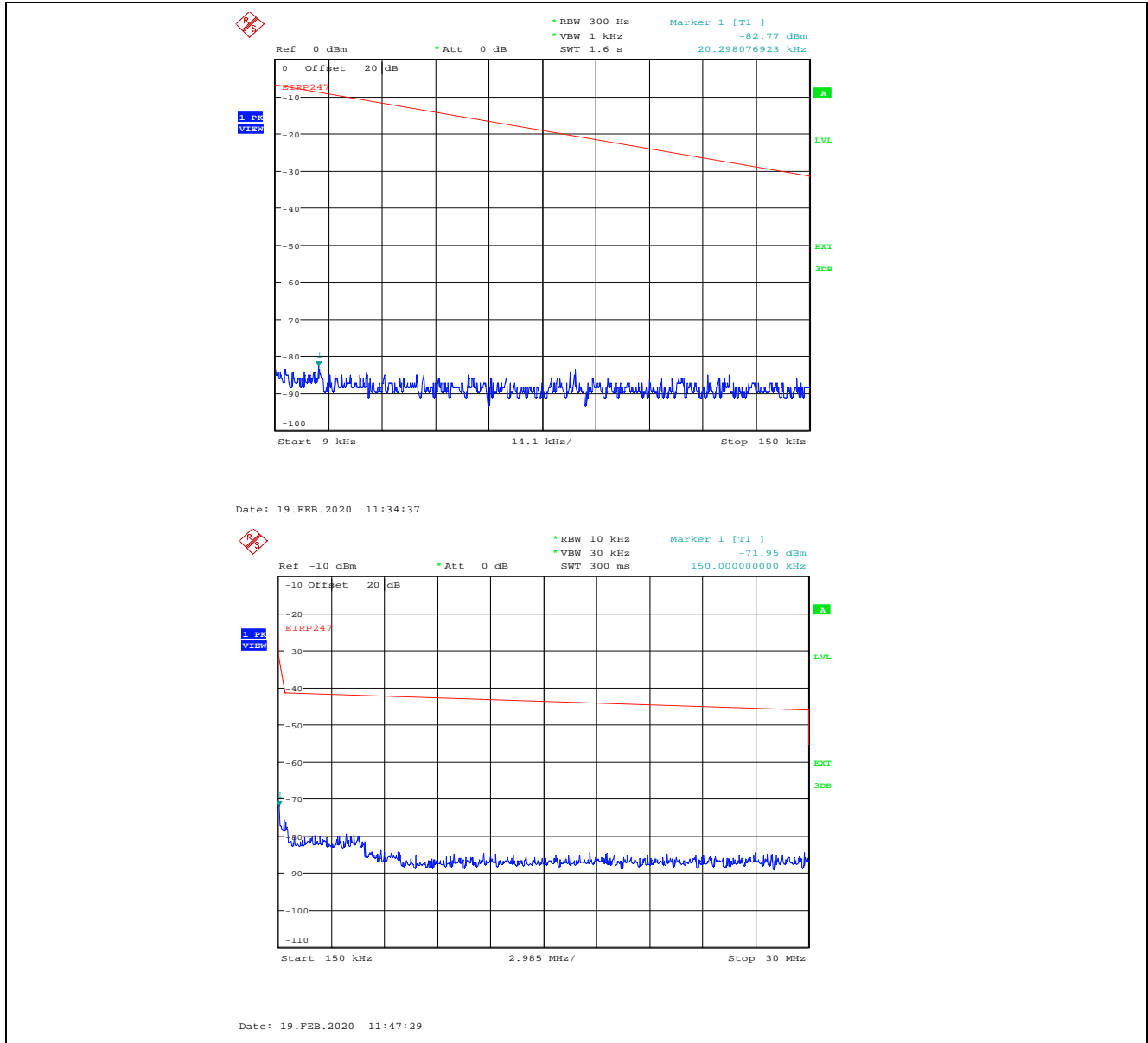

**Plot 5.3.5.3.2. Conducted Spurious Emissions in Restricted Frequency Bands**  
Channel 11, 2405 MHz, MSK Modulation, Power Setting 22, 30 MHz-4GHz, Peak Detector

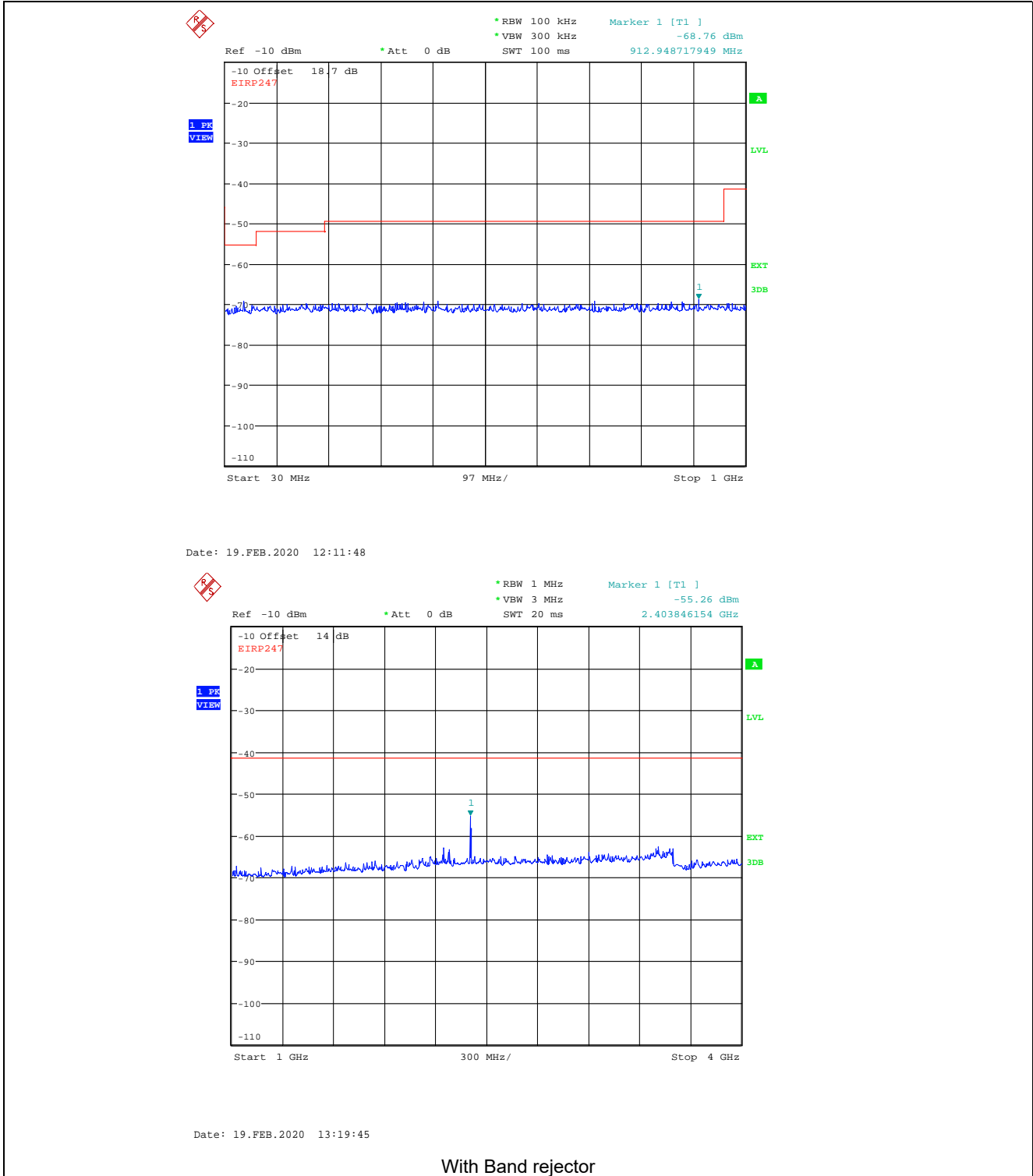

**Plot 5.3.5.3.3. Conducted Spurious Emissions in Restricted Frequency Bands**  
Channel 11, 2405 MHz, MSK Modulation, Power Setting 22, 1.39 GHz, Peak Detector /Average

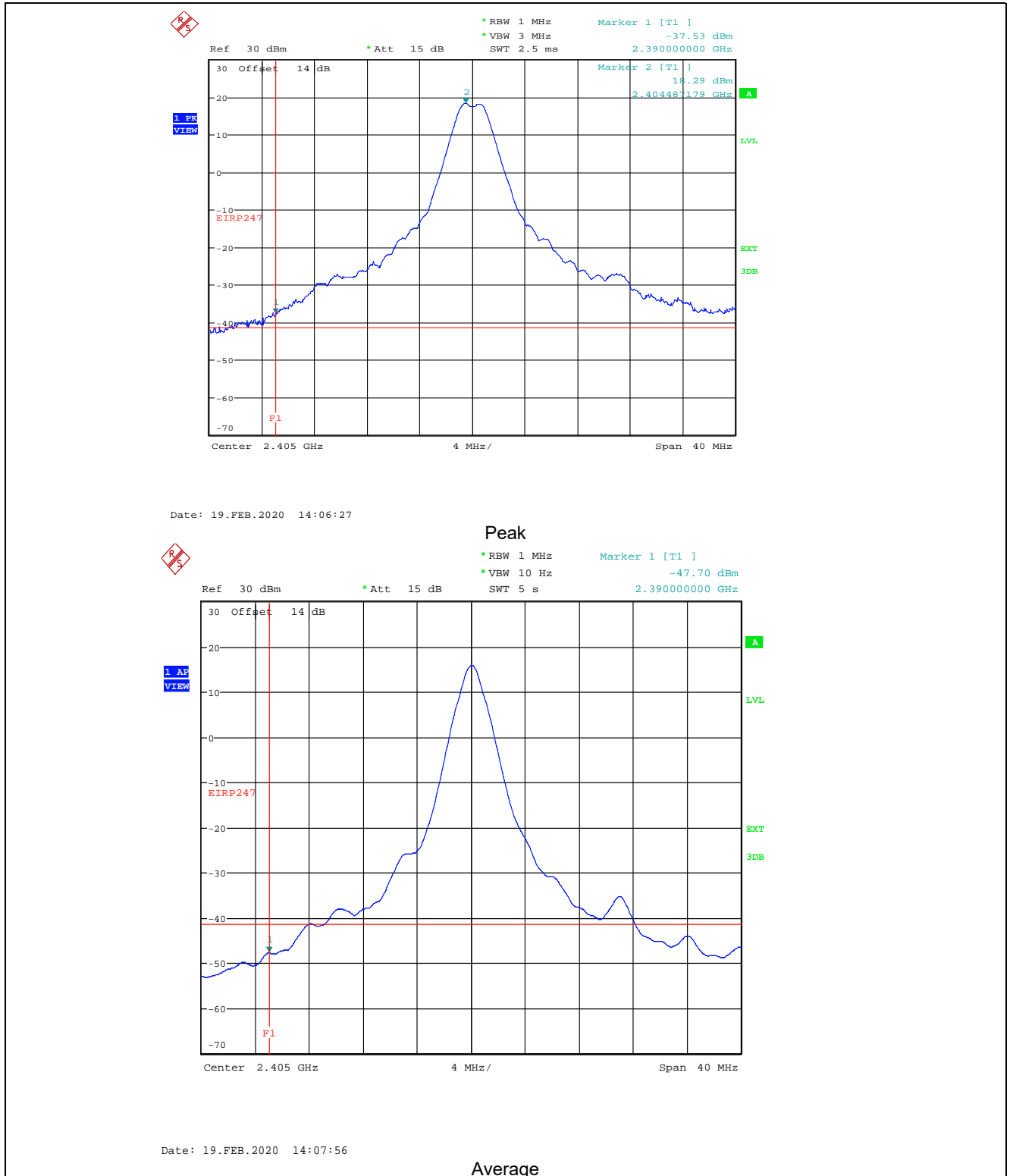

**Plot 5.3.5.3.4. Conducted Spurious Emissions in Restricted Frequency Bands**  
Channel 11, 2405 MHz, MSK Modulation, Power Setting 22, 4 – 25 GHz, Peak Detector

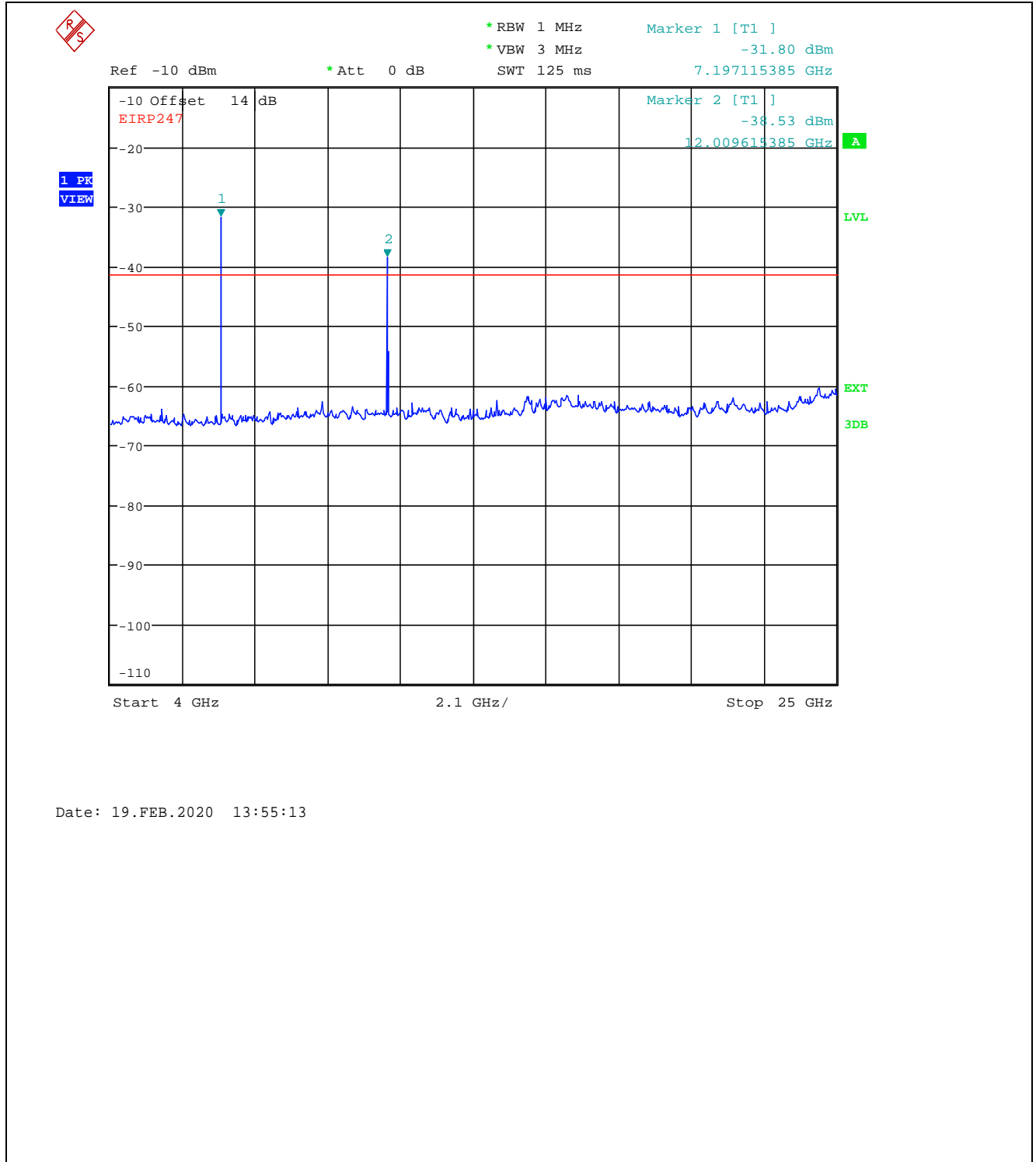

**Plot 5.3.5.3.5. Conducted Spurious Emissions in Restricted Frequency Bands**  
Channel 11, 2405 MHz, MSK Modulation, Power Setting 22, 7.21 and 12.022 GHz, Average

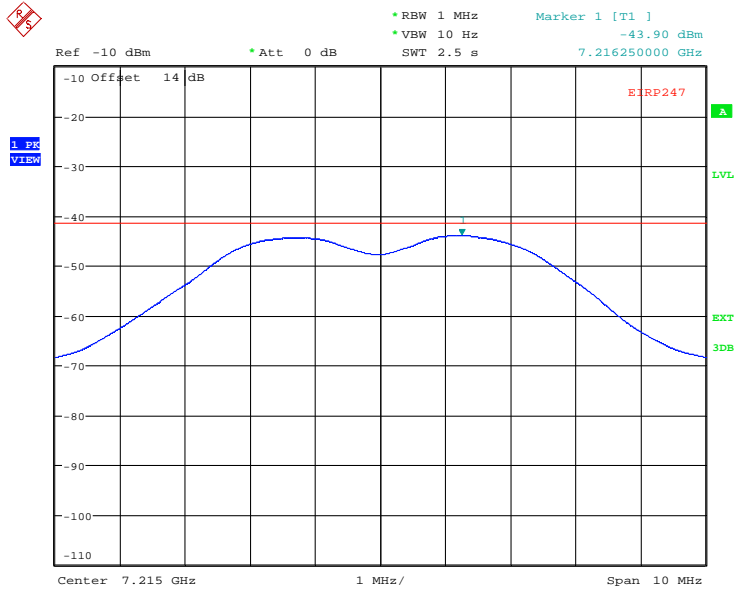

Date: 19.FEB.2020 13:57:23

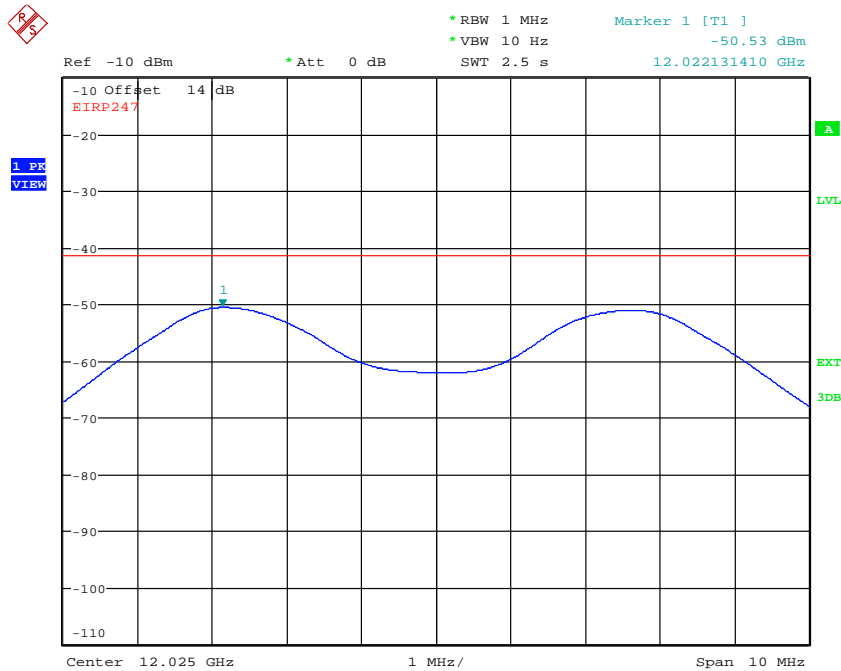

Date: 19.FEB.2020 13:59:45

Average measurements on Peak points above the limit

**Plot 5.3.5.3.6. Conducted Spurious Emissions in Restricted Frequency Bands**  
Channel 18, 2440 MHz, Pulse RX PRBS9 MSK Modulation, Power Setting 22, 9 kHz- 30 MHz, Peak Detector

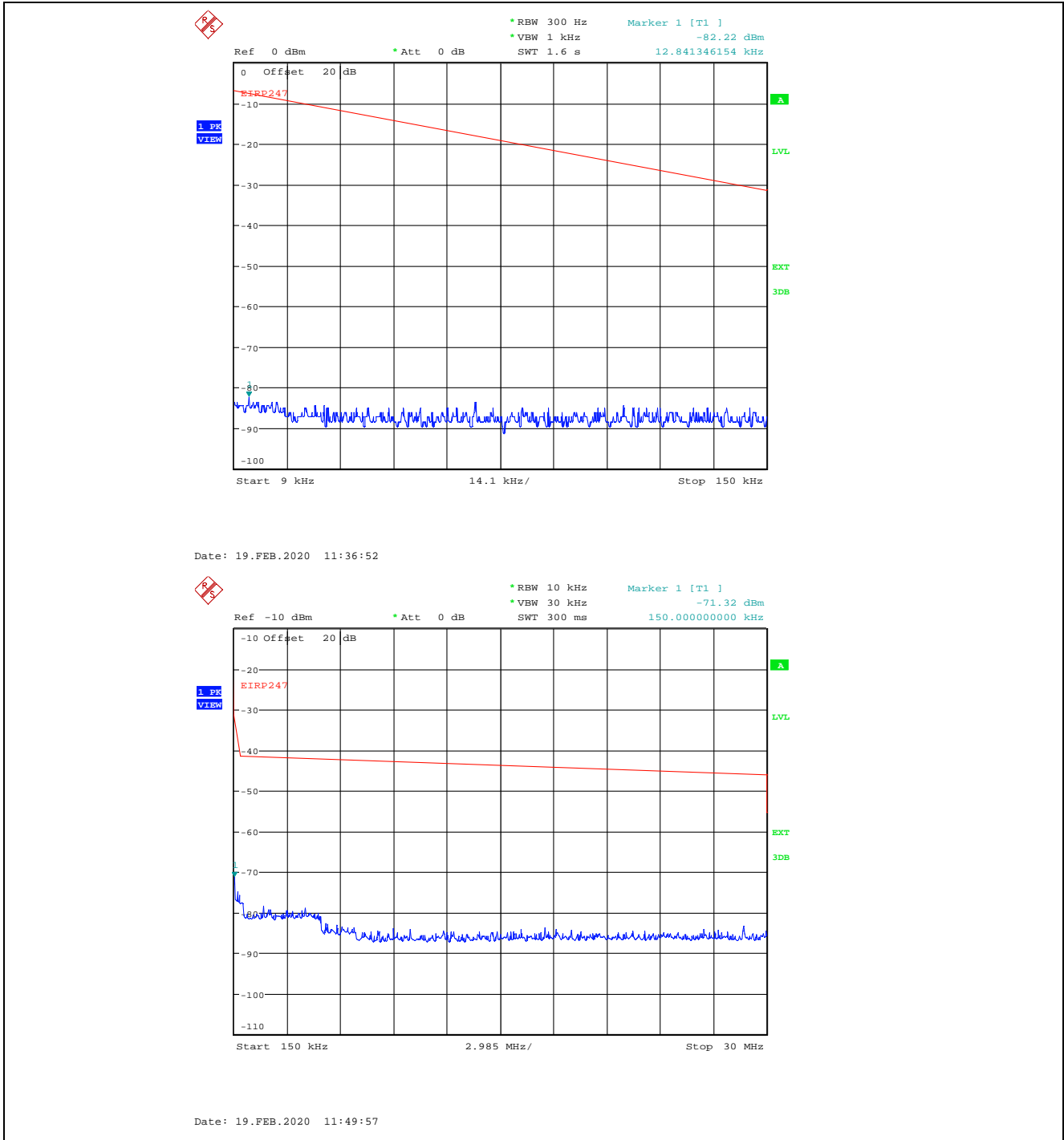



**Plot 5.3.5.3.7. Conducted Spurious Emissions in Restricted Frequency Bands**  
Channel 18, 2440 MHz, Pulse RX PRBS9, Power Setting 22, 30 MHz - 4 GHz, Peak Detector

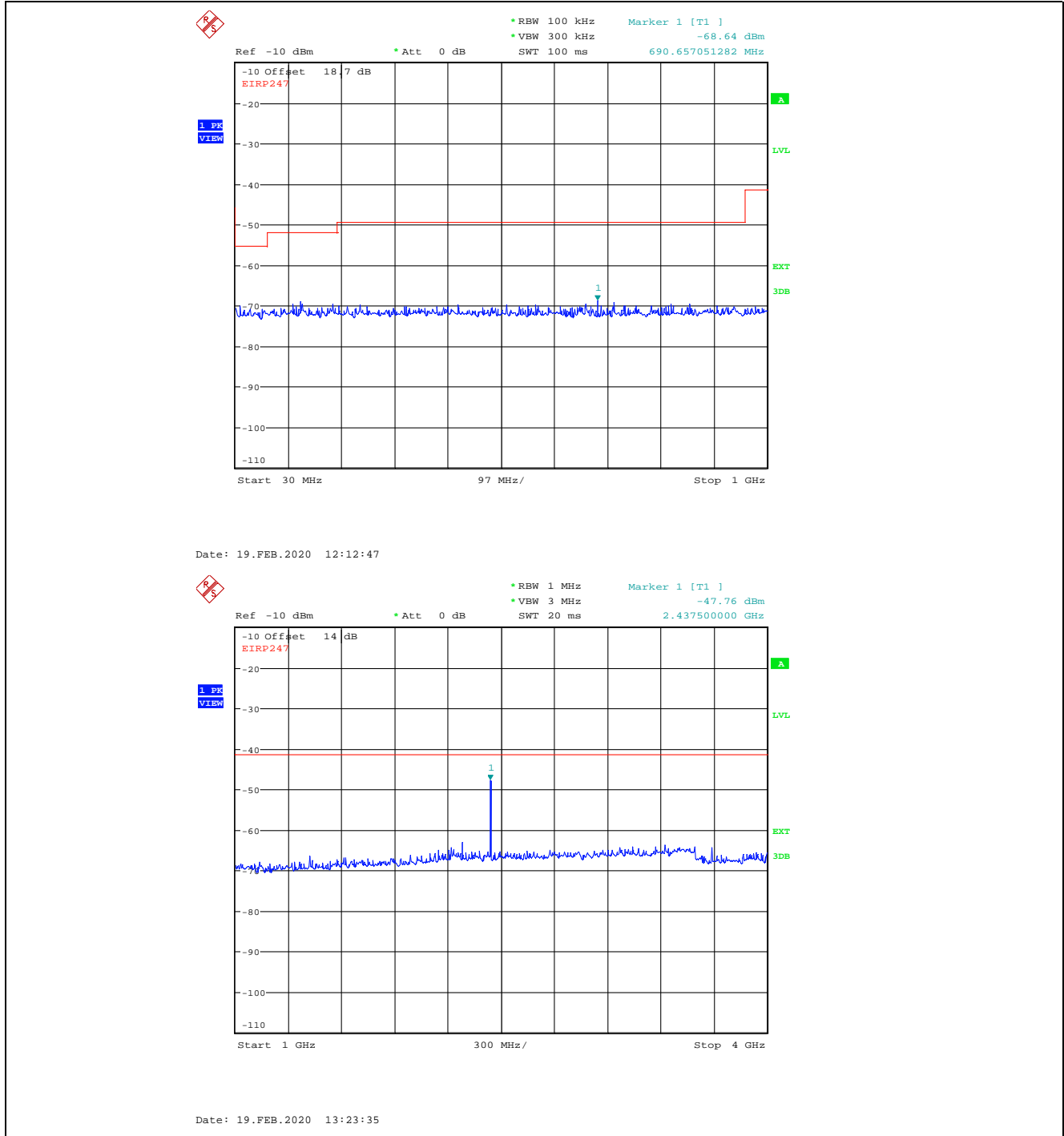

**Plot 5.3.5.3.8. Conducted Spurious Emissions in Restricted Frequency Bands**  
Channel 18, 2440 MHz, Pulse RX PRBS9, Power Setting 22, 4 -25 GHz, Peak Detector

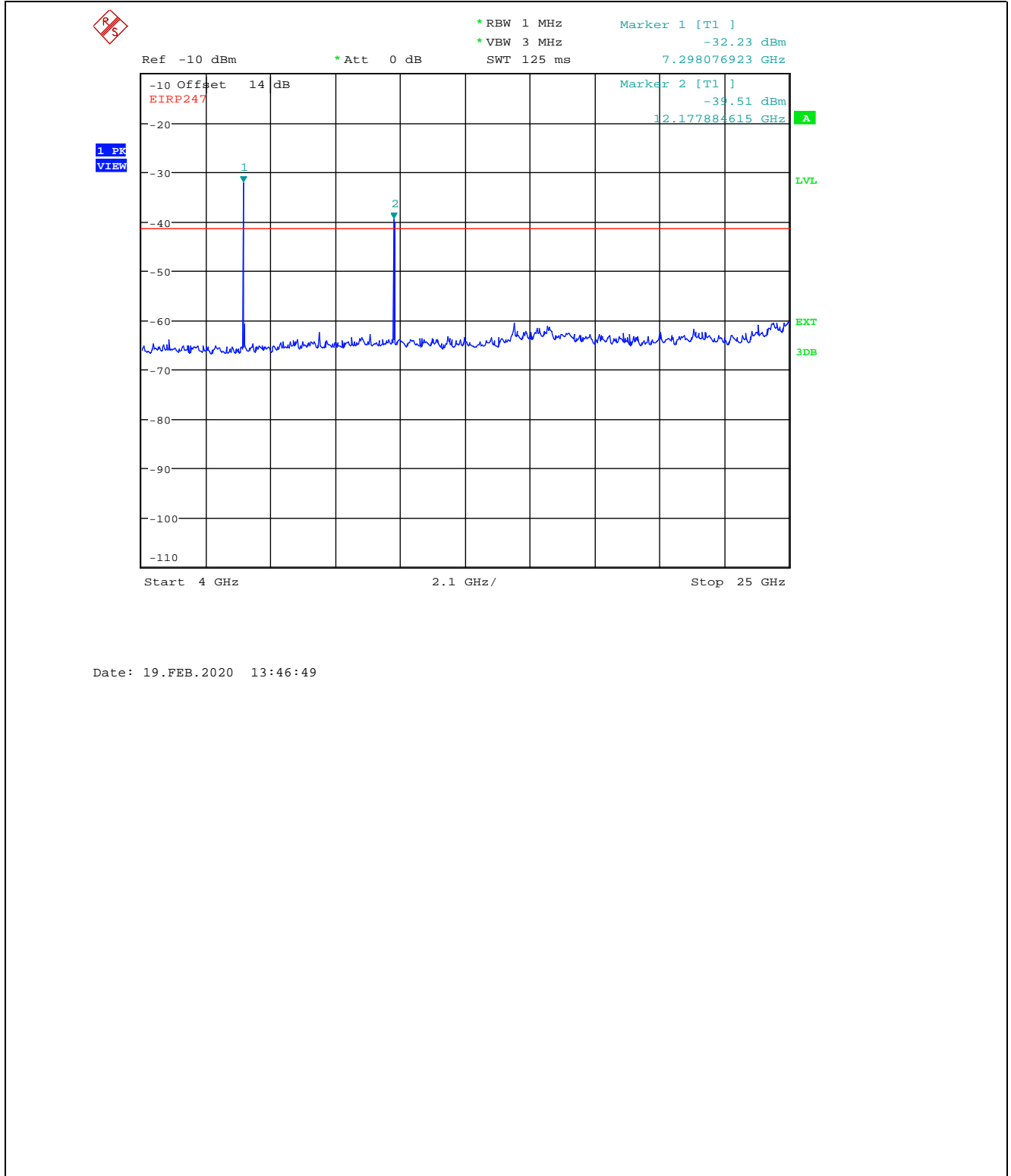

**Plot 5.3.5.3.9. Conducted Spurious Emissions in Restricted Frequency Bands**  
Channel 18, 2440 MHz, Pulse RX PRBS9, Power Setting 22, 7.32 and 12.197 GHz, Average

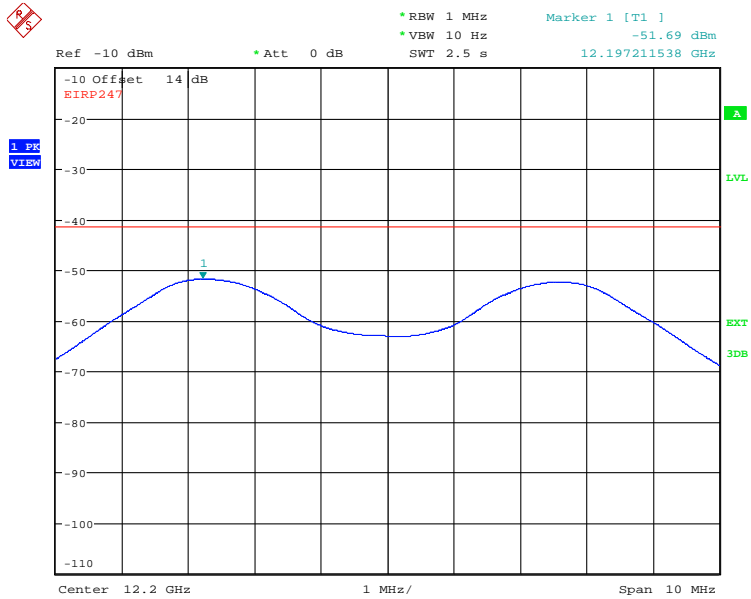
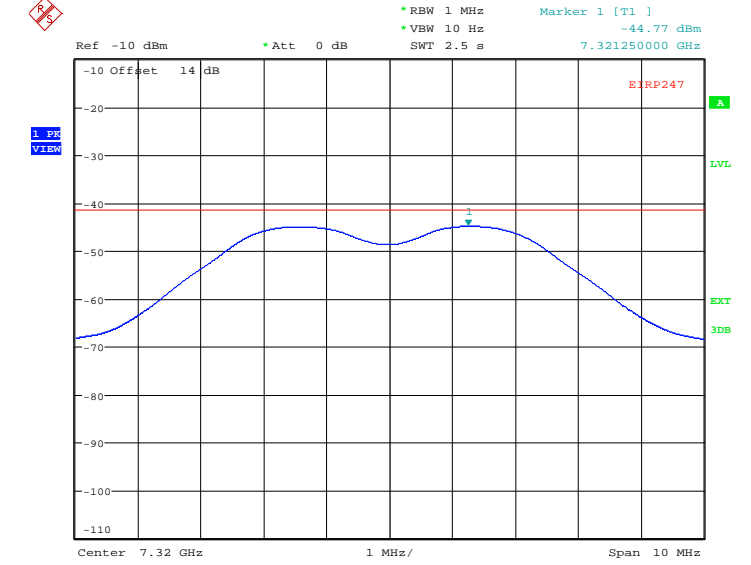

Average measurements on Peak points above the limit

**Plot 5.3.5.3.10.** Conducted Spurious Emissions in Restricted Frequency Bands  
Channel 25, 2475 MHz, Pulse RX PRBS9MSK Modulation, Power Setting 22, 9 kHz – 30 MHz, Peak Detector

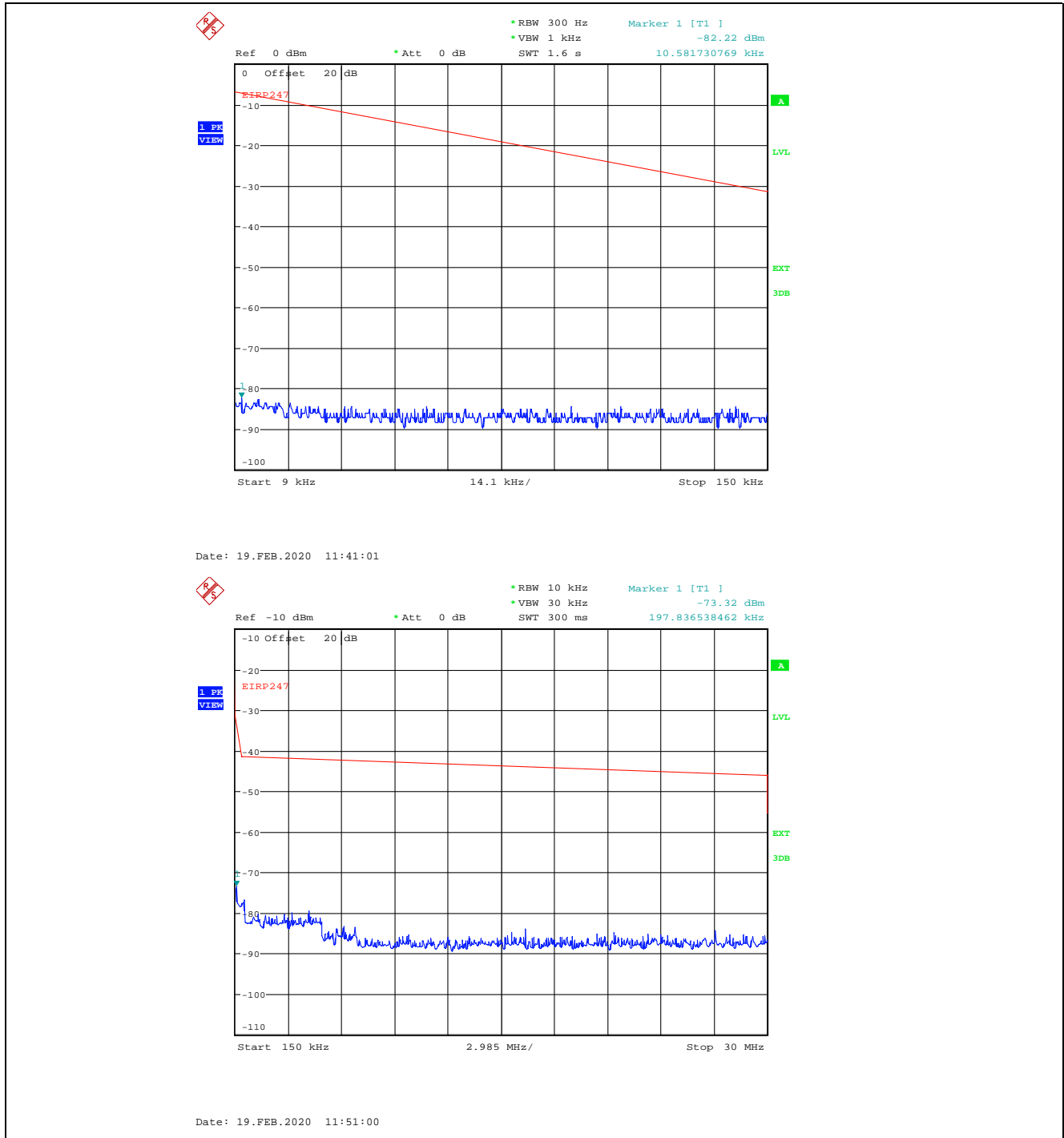



**Plot 5.3.5.3.12.** Conducted Spurious Emissions in Restricted Frequency Bands  
Channel 25, 2475 MHz, Pulse RX PRBS9MSK Modulation, Power Setting 22, Band edge 2483.5 MHz, Peak Detector/Average

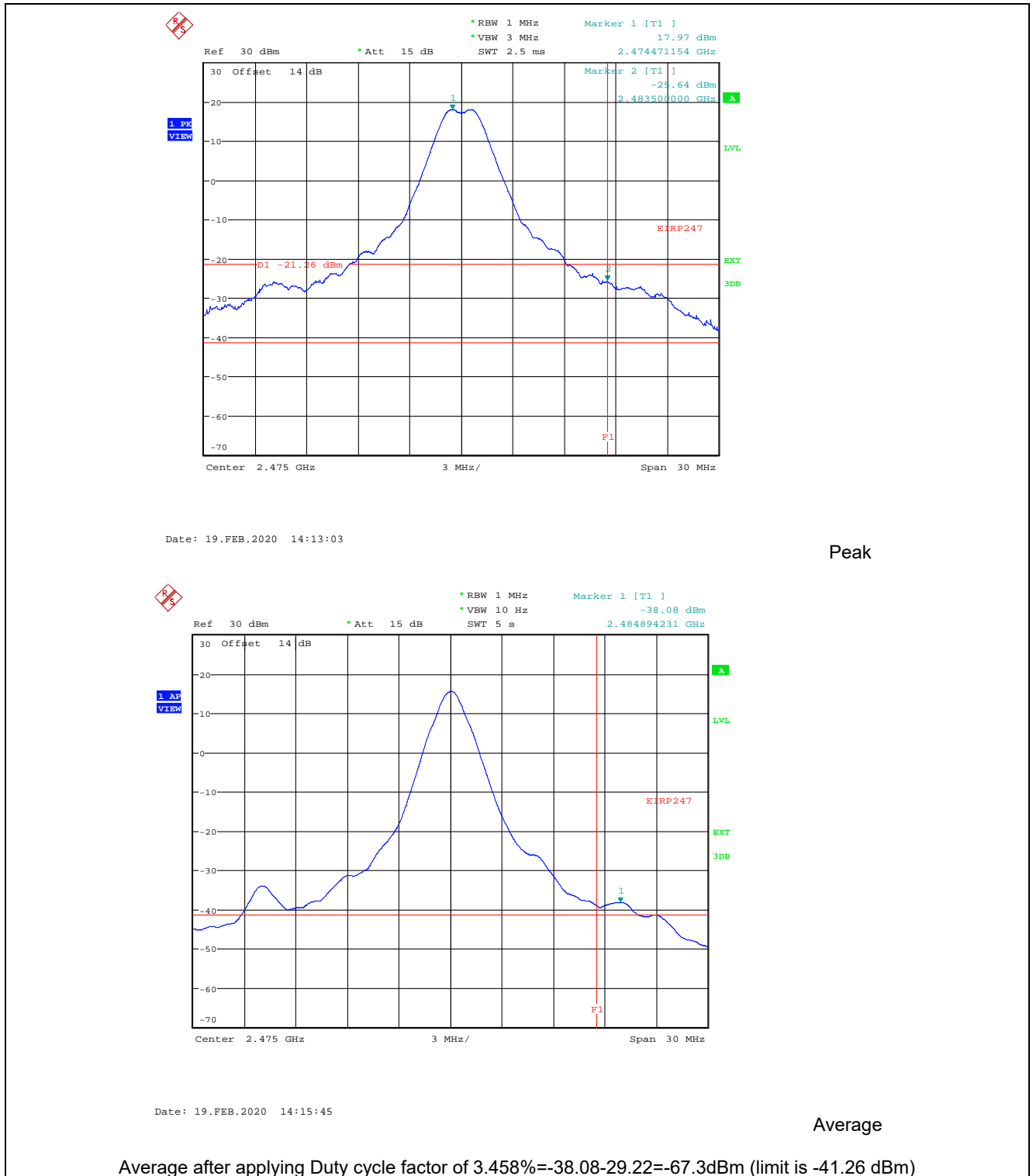

**Plot 5.3.5.3.13.** Conducted Spurious Emissions in Restricted Frequency Bands  
Channel 25, 2475 MHz, Pulse RX PRBS9MSK Modulation, Power Setting 22, 1-25 GHz, Peak Detector

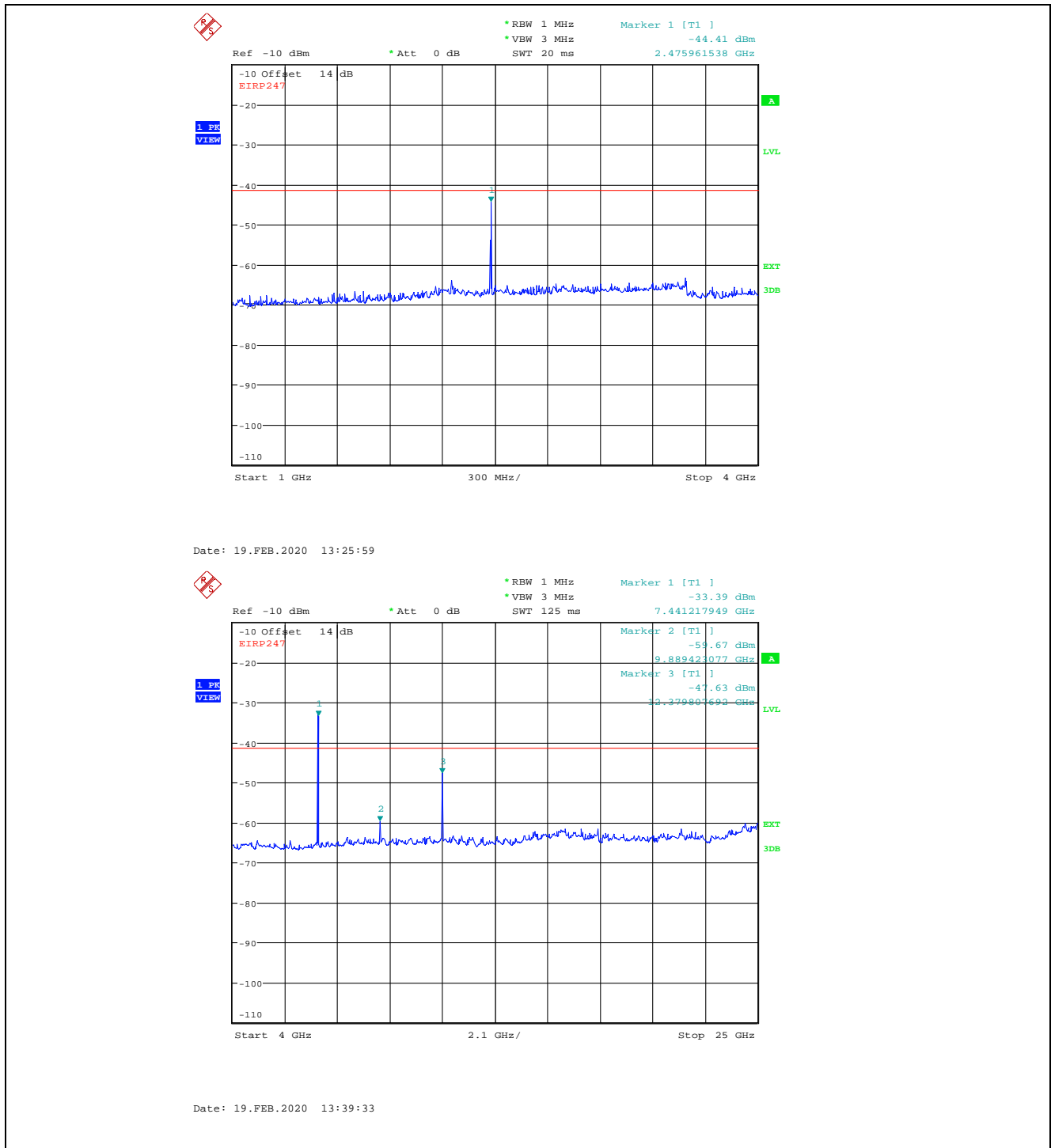

**Plot 5.3.5.3.14.** Conducted Spurious Emissions in Restricted Frequency Bands  
Channel 25, 2475 MHz, Pulse RX PRBS9MSK Modulation, Power Setting 22, 7.4 GHz, Average

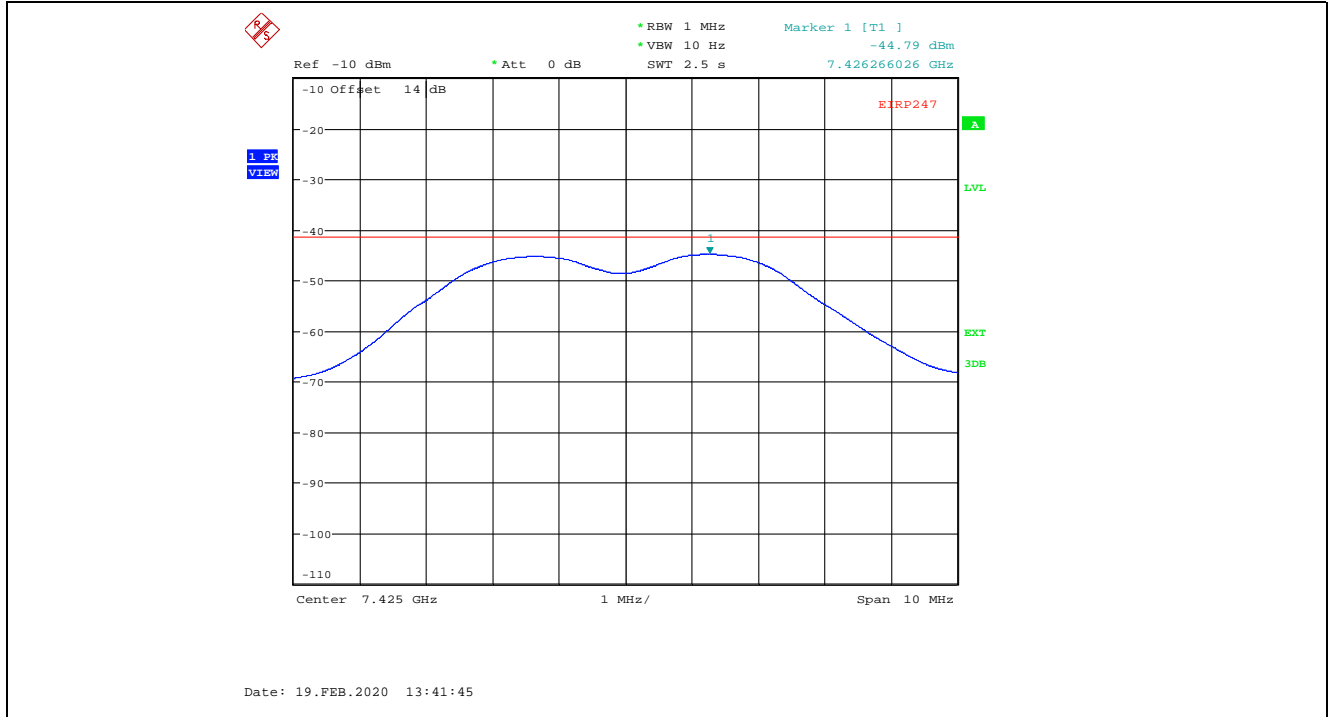

**Plot 5.3.5.3.15.** Conducted Spurious Emissions in Restricted Frequency Bands  
Channel 26, 2480 MHz, Pulse RX PRBS9MSK Modulation, Power Setting 18, 9 -150 kHz, Peak Detector

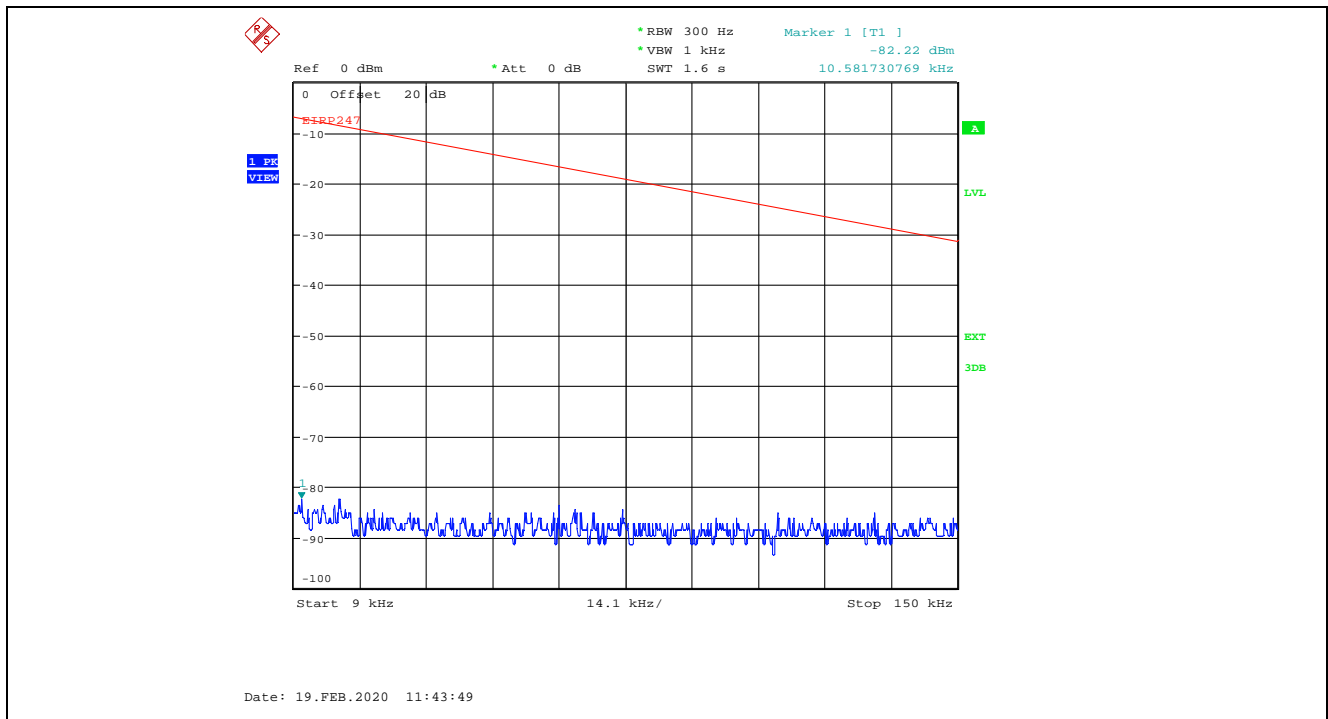



**Plot 5.3.5.3.16.** Conducted Spurious Emissions in Restricted Frequency Bands  
Channel 26, 2480 MHz, Pulse RX PRBS9MSK Modulation, Power Setting 18, 150 kHz- 1GHz , Peak Detector

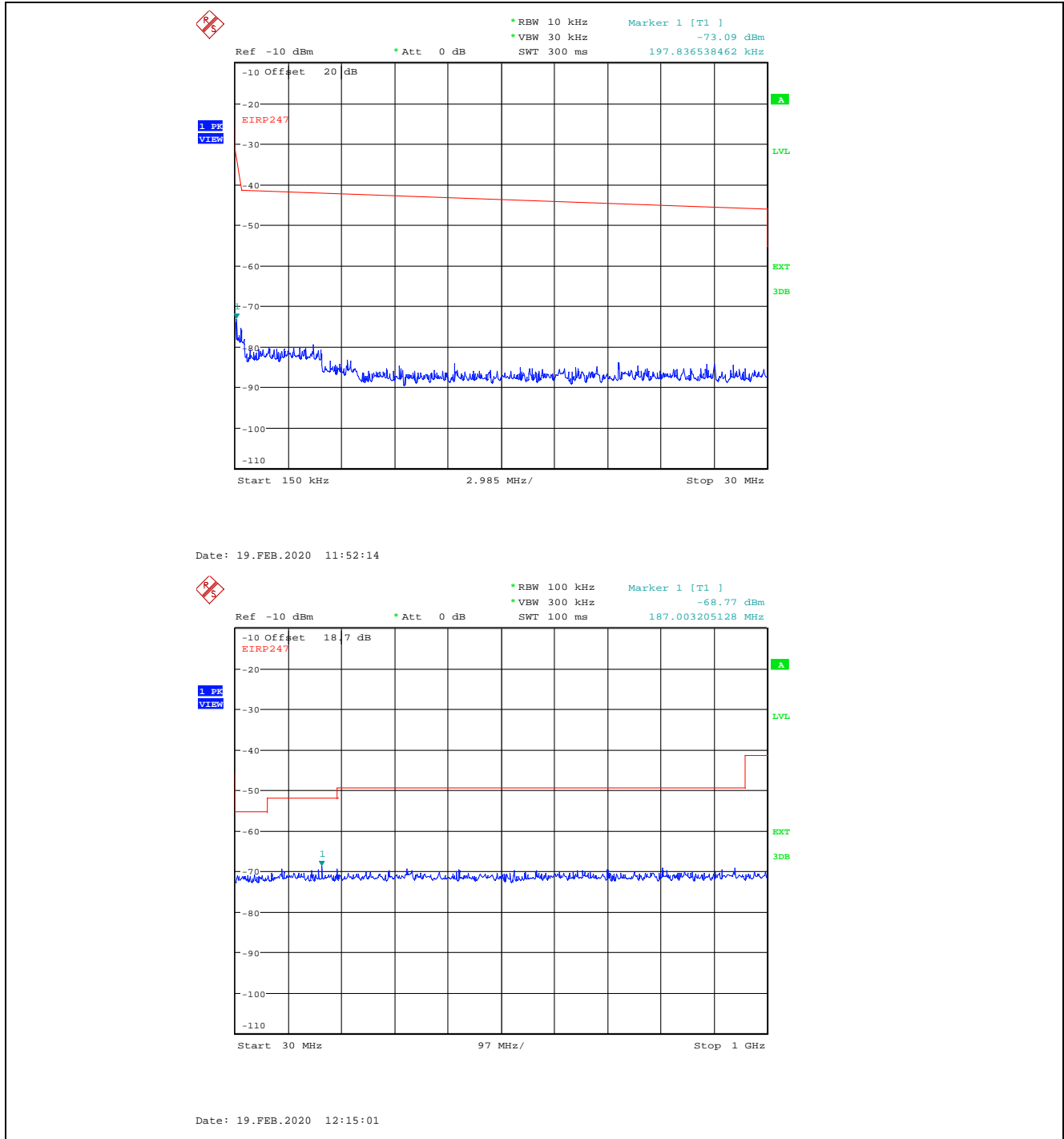

**Plot 5.3.5.3.17.** Conducted Spurious Emissions in Restricted Frequency Bands  
Channel 26, 2480 MHz, Pulse RX PRBS9MSK Modulation, Power Setting 18, Band edge 2483.5 MHz, Peak Detector/Average

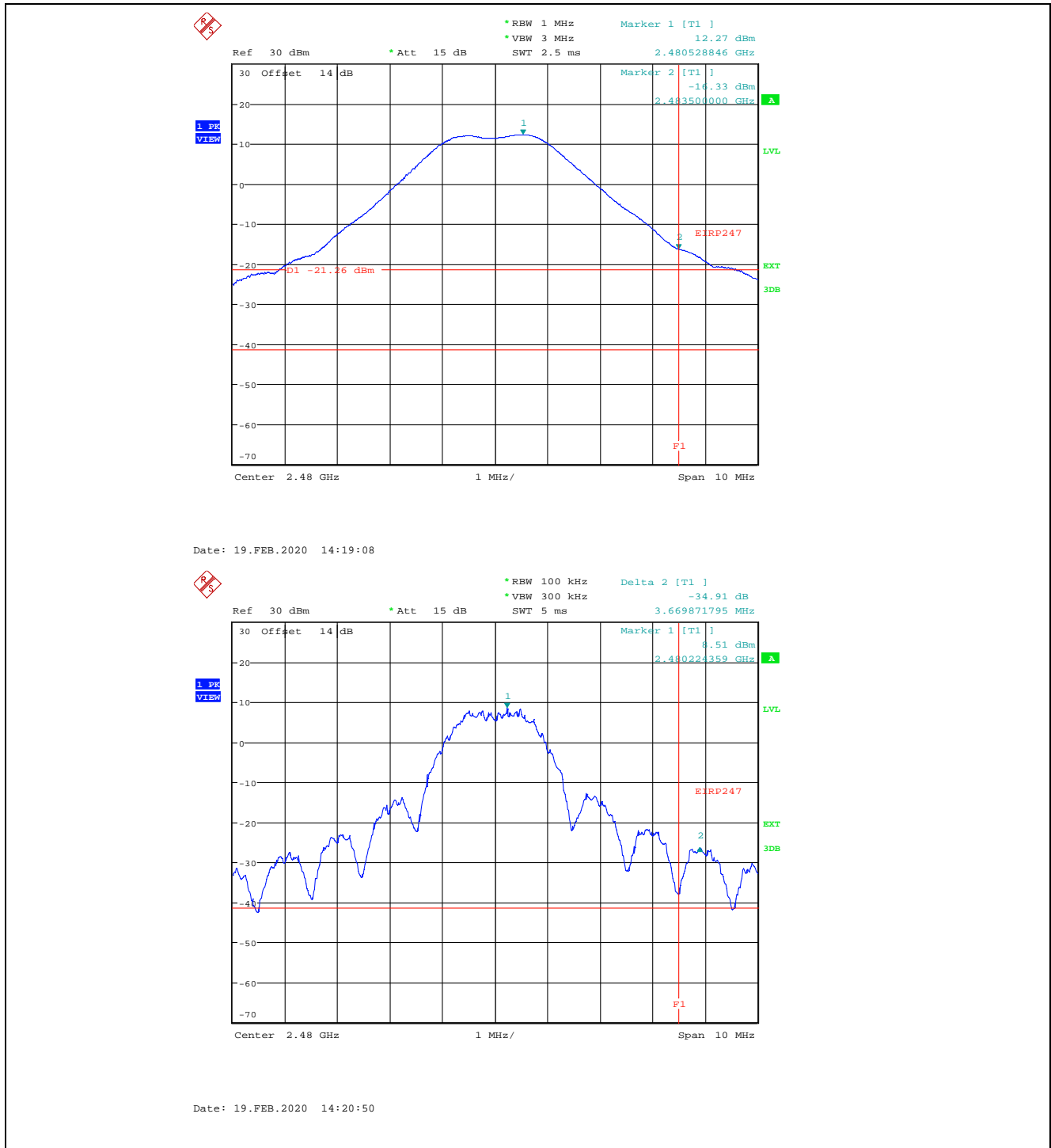

**Plot 5.3.5.3.18.** Conducted Spurious Emissions in Restricted Frequency Bands  
Channel 26, 2480 MHz, Pulse RX PRBS9MSK Modulation, Power Setting 18, Band edge 2483.5 MHz, Average

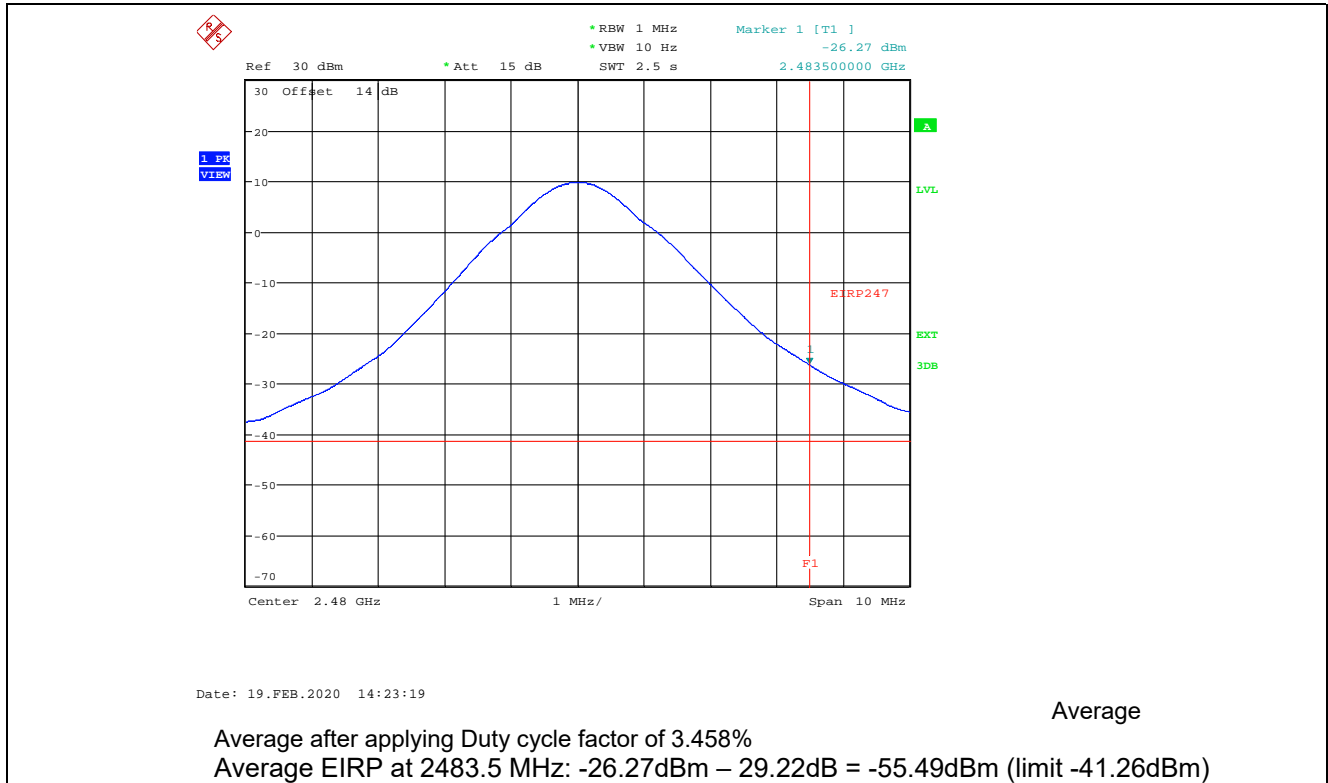

**Plot 5.3.5.3.19.** Conducted Spurious Emissions in Restricted Frequency Bands  
Channel 26, 2480 MHz, Pulse RX PRBS9MSK Modulation, Power Setting 18, 150 kHz- 1GHz , Peak Detector

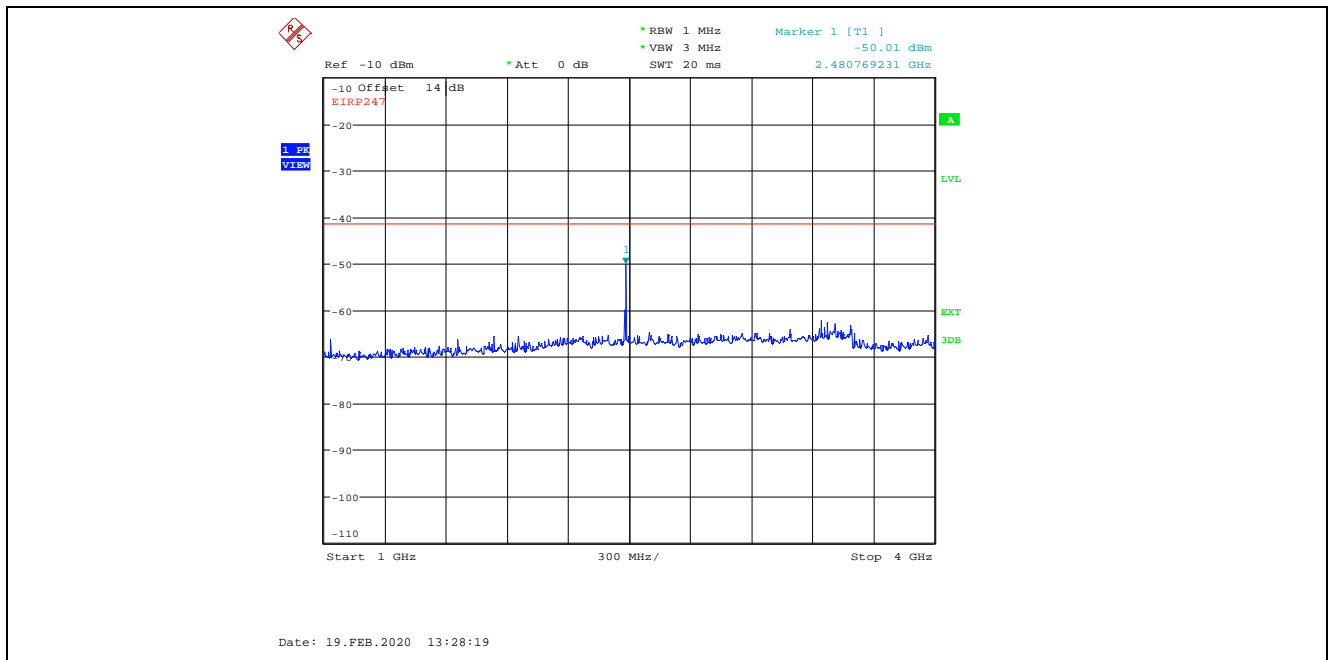

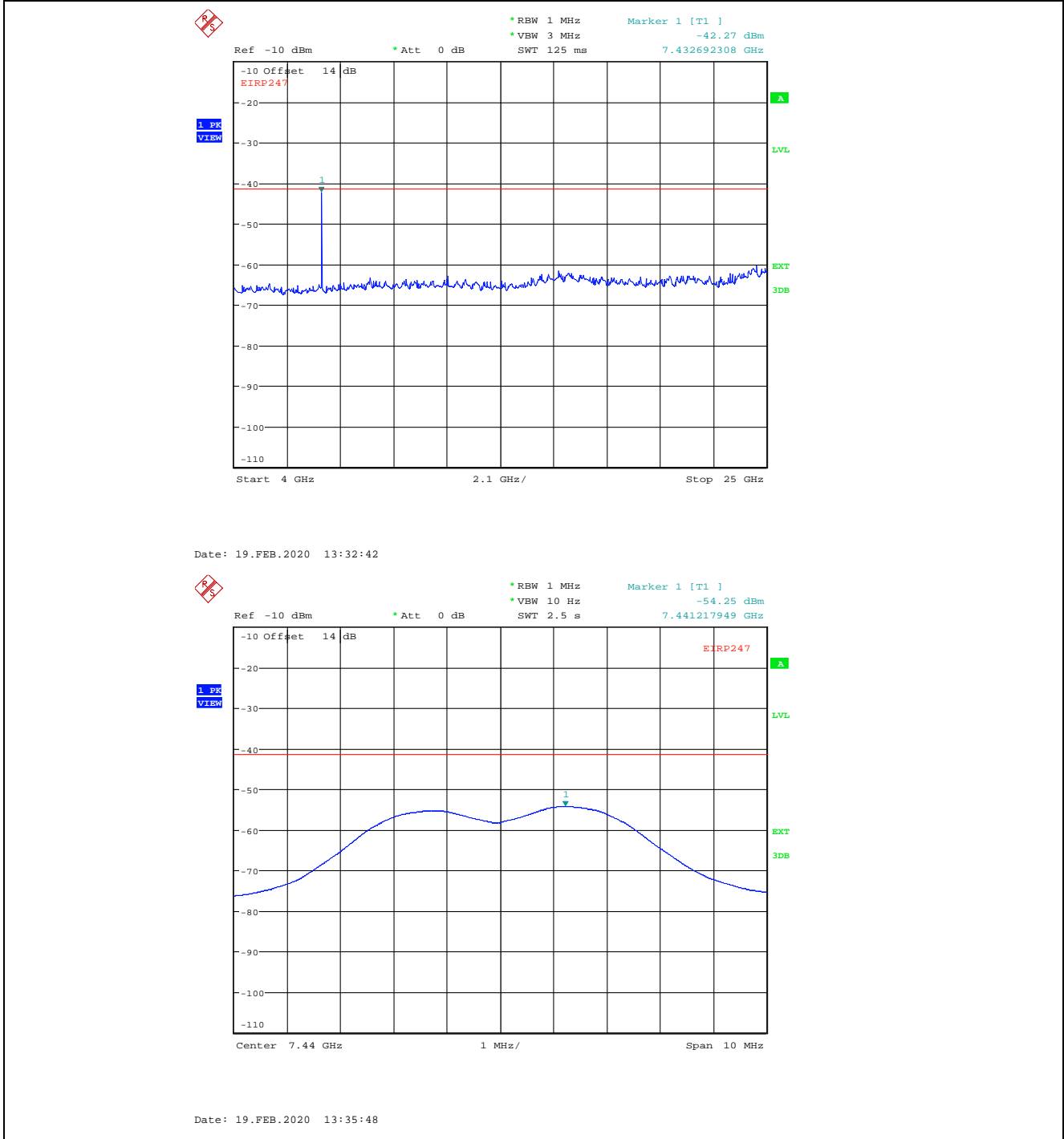

**5.4. TRANSMITTER SPURIOUS RADIATED EMISSIONS AT 3 METERS [§§ 15.247(d), 15.209 & 15.205] RSS 247-3.3, 5.5, RSS Gen 8.10**

**5.4.1. Limit(s)**

§ 15.247 (d): In any 100 kHz bandwidth outside the frequency band in which the spread spectrum or digitally modulated intentional radiator is operating, the radio frequency power that is produced by the intentional radiator shall be at least 20 dB below that in the 100 kHz bandwidth within the band that contains the highest level of the desired power, based on either an RF conducted or a radiated measurement, provided the transmitter demonstrates compliance with the peak conducted power limits. If the transmitter complies with the conducted power limits based on the use of RMS averaging over a time interval, as permitted under paragraph (b)(3) of this section, the attenuation required under this paragraph shall be 30 dB instead of 20 dB. Attenuation below the general limits specified in Section 15.209(a) is not required. In addition, radiated emissions which fall in the restricted bands, as defined in Section 15.205(a), must also comply with the radiated emission limits specified in Section 15.209(a) (see Section 15.205(c)).

**Section 15.205(a) - Restricted Bands of Operation**

MHz	MHz	MHz	GHz
0.090–0.110 .....	16.42–16.423	399.9–410	4.5–5.15
10.495–0.505 .....	16.69475–16.69525	608–614	5.35–5.46
2.1735–2.1905 .....	16.80425–16.80475	960–1240	7.25–7.75
4.125–4.128 .....	25.5–25.67	1300–1427	8.025–8.5
4.17725–4.17775 .....	37.5–38.25	1435–1626.5	9.0–9.2
4.20725–4.20775 .....	73–74.6	1645.5–1646.5	9.3–9.5
6.215–6.218 .....	74.8–75.2	1660–1710	10.6–12.7
6.26775–6.26825 .....	108–121.94	1718.8–1722.2	13.25–13.4
6.31175–6.31225 .....	123–138	2200–2300	14.47–14.5
8.291–8.294 .....	149.9–150.05	2310–2390	15.35–16.2
8.362–8.366 .....	156.52475–156.52525	2483.5–2500	17.7–21.4
8.37625–8.38675 .....	156.7–156.9	2655–2900	22.01–23.12
8.41425–8.41475 .....	162.0125–167.17	3260–3267	23.6–24.0
12.29–12.293 .....	167.72–173.2	3332–3339	31.2–31.8
12.51975–12.52025 .....	240–285	3345.8–3358	36.43–36.5
12.57675–12.57725 .....	322–335.4	3600–4400	( <sup>2</sup> )
13.36–13.41.			

<sup>1</sup>Until February 1, 1999, this restricted band shall be 0.490–0.510 MHz.

<sup>2</sup>Above 38.6

In addition to above for Canada RSS Gen 8.10: the following bands are restricted too. 3.020-3.026 MHz, 5.677-5.683 MHz, 121.94-123 MHz, 1240-1300 MHz

**Section 15.209(a) - Field Strength Limits within Restricted Frequency Bands**

Frequency (MHz)	Field Strength (microvolts/meter)	Measurement Distance (meters)
0.009 - 0.490	2,400 / F (kHz)	300
0.490 - 1.705	24,000 / F (kHz)	30
1.705 - 30.0	30	30
30 – 88	100	3
88 – 216	150	3
216 – 960	200	3
Above 960	500	3

**5.4.2. Method of Measurements**

ANSI C63.10.

**5.4.3. Test Arrangement**

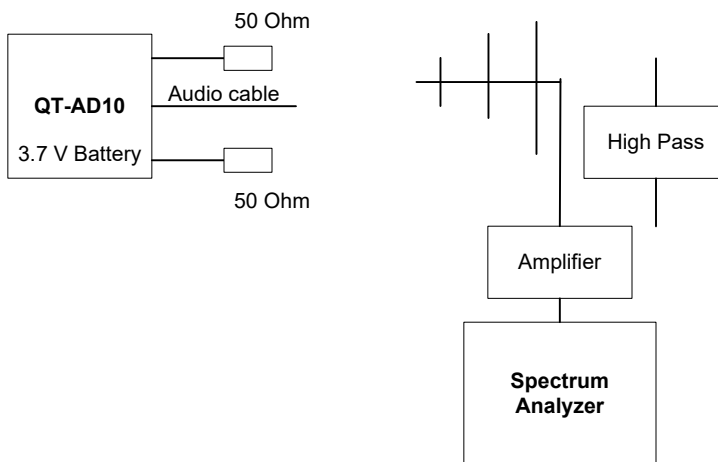

**5.4.4. Test Equipment List**

Test Instruments	Manufacturer	Model No.	Serial No.	Frequency Range	Calibration Due Date
EMI Receiver	Rohde & Schwarz	ESU40	100037	20Hz–40 GHz	Mar 15, 2020
Spectrum Analyzer	Rohde & Schwarz	FSU26	200946	20Hz–26.5 GHz	Jul 25, 2020
RF Amplifier	Com-Power	PAM-0118A	551052	0.5 – 18 GHz	Jul 24, 2020
RF Amplifier	Hewlett Packard	84498	3008A00769	1 – 26.5 GHz	Jan 7, 2021
Biconilog	Emco	3142B	1575	26-2000 MHz	May 10, 2020
Horn Antenna	Emco	3155	6570	1 – 18 GHz	Oct 11, 2020
Horn Antenna	ETS-Lindgren	3160-09	001183858	18 – 26.5 GHz	Oct 27, 2020
High Pass Filter	K & L	11SH10-4000/T12000	4	Cut off 2.4 GHz	Cal on use

**5.4.5. Test Data**

**Remark(s):**

- All spurious emissions that are in excess of 20 dB below the specified limit shall be recorded.
- EUT shall be tested in three orthogonal positions.
- § 15.247 (d) spurious emission limit:  
 $E_{dB\mu V/m} = EIRP_{dBm} - 20\log(d) + 104.8 - 20 = EIRP_{dBm} - 20\log(3) + 84.8$
- Exploratory tests performed to determined worst-case test configurations, the following test results at high power setting represent the worst-case.

Fundamental Frequency:		2405 MHz					
EIRP:		16.34 dBm					
Frequency Test Range:		30 MHz – 25 GHz					
Frequency (MHz)	RF Peak Level (dBμV/m)	RF Avg Level (dBμV/m)	Antenna Plane (H/V)	Limit 15.209 (dBμV/m)	Limit 15.247 (dBμV/m)	Margin (dB)	Pass/Fail
4810	49.10	36.97/7.75**	V	54.0	91.6	<-20dB	Pass*
4810	49.77	35.47/6.25**	H	54.0	91.6	<-20dB	Pass*
7215	56.67	45.11/15.89**	V	54.0	91.6	<-20dB	Pass*
7215	54.89	42.61/13.39**	H	54.0	91.6	<-20dB	Pass*
12025	72.77	61.96/32.74**	V	54.0	91.6	<-20dB	Pass*
12025	69.15	57.61/28.39**	H	54.0	91.6	<-20dB	Pass*
All other spurious emissions and harmonics are more than 20 dB below the applicable limit.							

Fundamental Frequency:		2440 MHz					
EIRP:		16.62 dBm					
Frequency Test Range:		30 MHz – 25 GHz					
Frequency (MHz)	RF Peak Level (dBμV/m)	RF Avg Level (dBμV/m)	Antenna Plane (H/V)	Limit 15.209 (dBμV/m)	Limit 15.247 (dBμV/m)	Margin (dB)	Pass/Fail
4880	49.54	35.96/6.74**	V	54.0	91.9	<-20dB	Pass*
4880	50.17	36.24/7.02**	H	54.0	91.9	<-20dB	Pass*
7320	57.24	44.65/15.43**	V	54.0	91.9	<-20dB	Pass*
7320	58.37	46.69/17.47**	H	54.0	91.9	<-20dB	Pass*
12200	68.80	57.72/28.50**	V	54.0	91.9	<-20dB	Pass*
12200	69.11	57.66/28.44**	H	54.0	91.9	<-20dB	Pass*
All other spurious emissions and harmonics are more than 20 dB below the applicable limit.							

\*Field strength of emissions appearing within restricted frequency bands shall not exceed the limits in § 15.209.

\*\* Average value after applying duty cycle factor of 3.458%

Fundamental Frequency:		2475 MHz					
EIRP:		15.98 dBm					
Frequency Test Range:		30 MHz – 25 GHz					
Frequency (MHz)	RF Peak Level (dB $\mu$ V/m)	RF Avg Level (dB $\mu$ V/m)	Antenna Plane (H/V)	Limit 15.209 (dB $\mu$ V/m)	Limit 15.247 (dB $\mu$ V/m)	Margin (dB)	Pass/Fail
4950	49.23	35.69/6.47**	V	54.0	91.2	<-20dB	Pass*
4950	50.34	35.53/6.31**	H	54.0	91.2	<-20dB	Pass*
7425	57.96	45.54/16.32**	V	54.0	91.2	<-20dB	Pass*
7425	58.05	46.07/16.85**	H	54.0	91.2	<-20dB	Pass*
12375	61.57	49.22/20.00**	V	54.0	91.2	<-20dB	Pass*
12375	60.87	48.89/19.67**	H	54.0	91.2	<-20dB	Pass*
All other spurious emissions and harmonics are more than 20 dB below the applicable limit.							

Fundamental Frequency:		2480 MHz					
EIRP:		10.30 dBm					
Frequency Test Range:		30 MHz – 25 GHz					
Frequency (MHz)	RF Peak Level (dB $\mu$ V/m)	RF Avg Level (dB $\mu$ V/m)	Antenna Plane (H/V)	Limit 15.209 (dB $\mu$ V/m)	Limit 15.247 (dB $\mu$ V/m)	Margin (dB)	Pass/Fail
4960	49.79	35.98/6.76**	V	54.0	85.5	<-20dB	Pass*
4960	50.66	35.54/6.32**	H	54.0	85.5	<-20dB	Pass*
7440	53.47	40.01/10.79**	V	54.0	85.5	<-20dB	Pass*
7440	53.19	40.22/11.00**	H	54.0	85.5	<-20dB	Pass*
All other spurious emissions and harmonics are more than 20 dB below the applicable limit.							

\*Field strength of emissions appearing within restricted frequency bands shall not exceed the limits in § 15.209.

\*\* Average value after applying duty cycle factor of 3.458%



**5.5. POWER SPECTRAL DENSITY [§ 15.247(e)], RSS 247-5.2 (b)**

**5.5.1. Limit(s)**

For digitally modulated systems, the power spectral density conducted from the intentional radiator to the antenna shall not be greater than 8 dBm in any 3 kHz band during any time interval of continuous transmission.

**5.5.2. Method of Measurements**

KDB 558074 D01 15.247 Meas Guidance v05r02, Section 8.4 (11.10.2 Method PKPSD ANSI C63.10-2013)

**5.5.3. Test Arrangement**

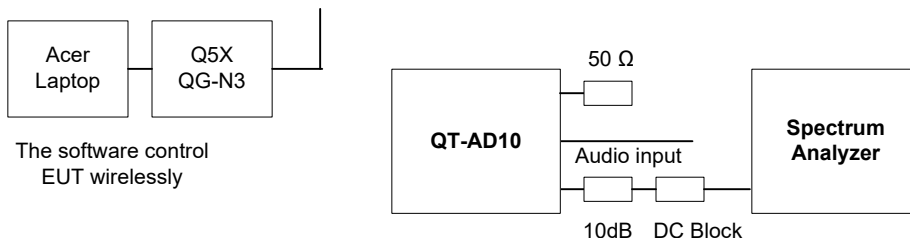

**5.5.4. Test Equipment List**

Test Instruments	Manufacturer	Model No.	Serial No.	Frequency Range	Calibration Due Date
Spectrum Analyzer	Rohde & Schwarz	FSU26	200946	20Hz–26.5 GHz	Jul 25, 2020
Attenuator	Hewlett Packard	8493C	0461	DC - 26.5 GHz	Cal on use
DC Block	Hewlett Packard	11742A	12460	0.045 – 26.5 GHz	Cal on use
Laptop	Acer	D270-1998	NUSGAAA 0012281 DF327614	0.045 – 26.5 GHz	-
Remote Gateway	Q5X	QG-N3	61719	-	-

5.5.5. Test Data

Modulation	Channel Number	Frequency (MHz)	PSD (dBm)	Limit (dBm)
MSK	11	2405	1.53	8
	18	2440	1.97	8
	25	2475	1.22	8
	26	2480	-4.07	8

Plot 5.5.5.1. Power Spectral Density, Channel 11, 2405 MHz, MSK modulation, Power Setting 22

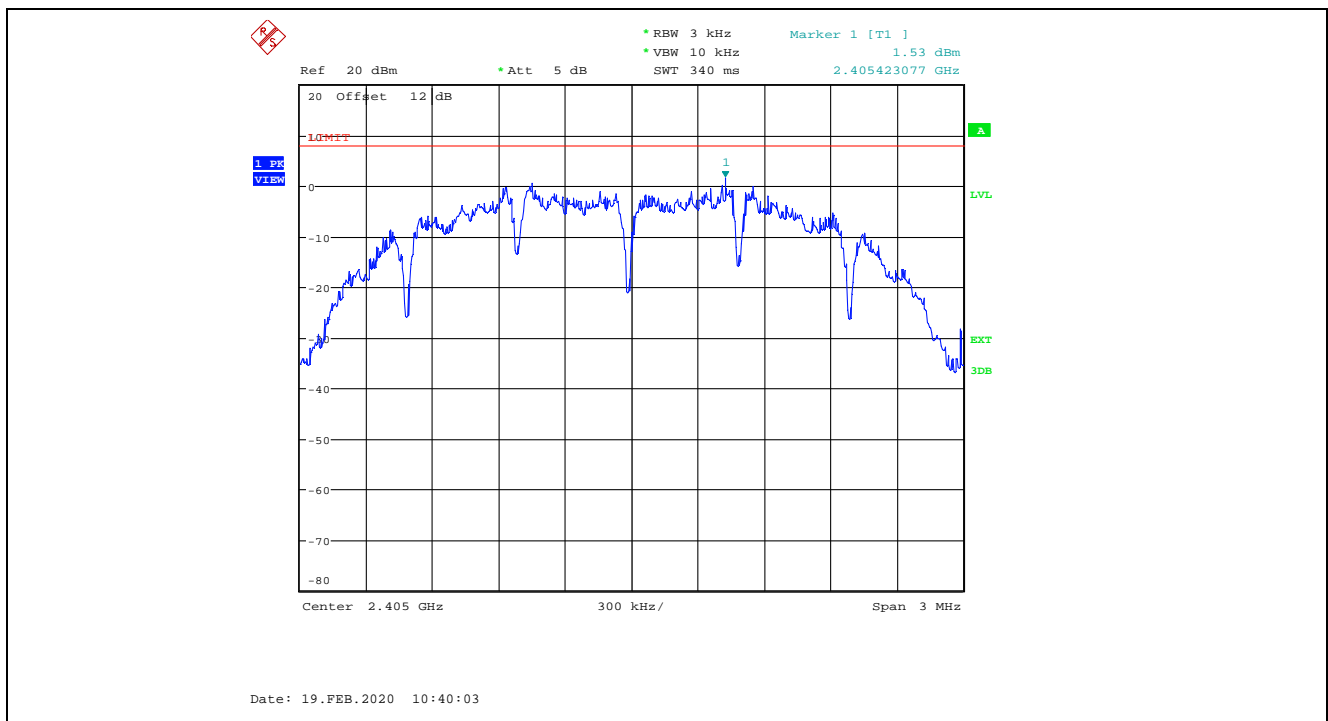

Plot 5.5.5.2. Power Spectral Density, Channel 18, 2440 MHz, MSK modulation, Power Setting 22

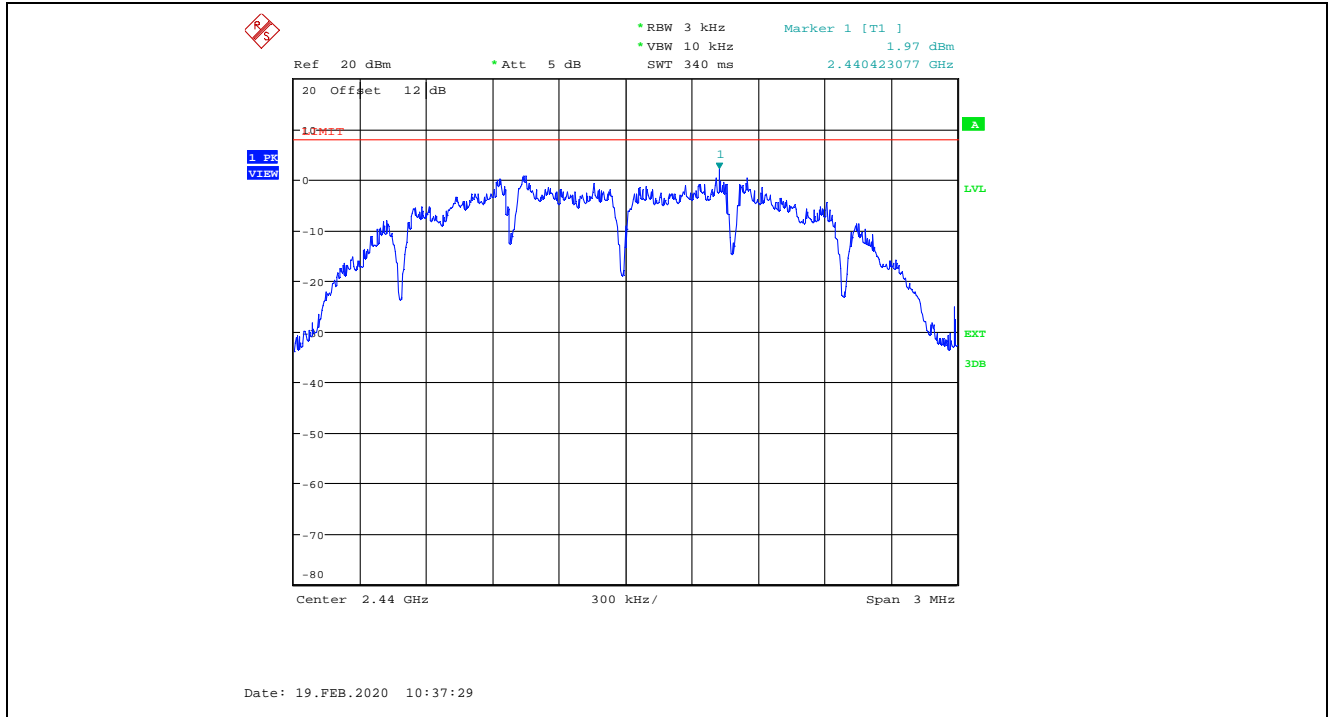

Plot 5.5.5.3. Power Spectral Density, Channel 26, 2475 MHz, MSK modulation, Power Setting 22

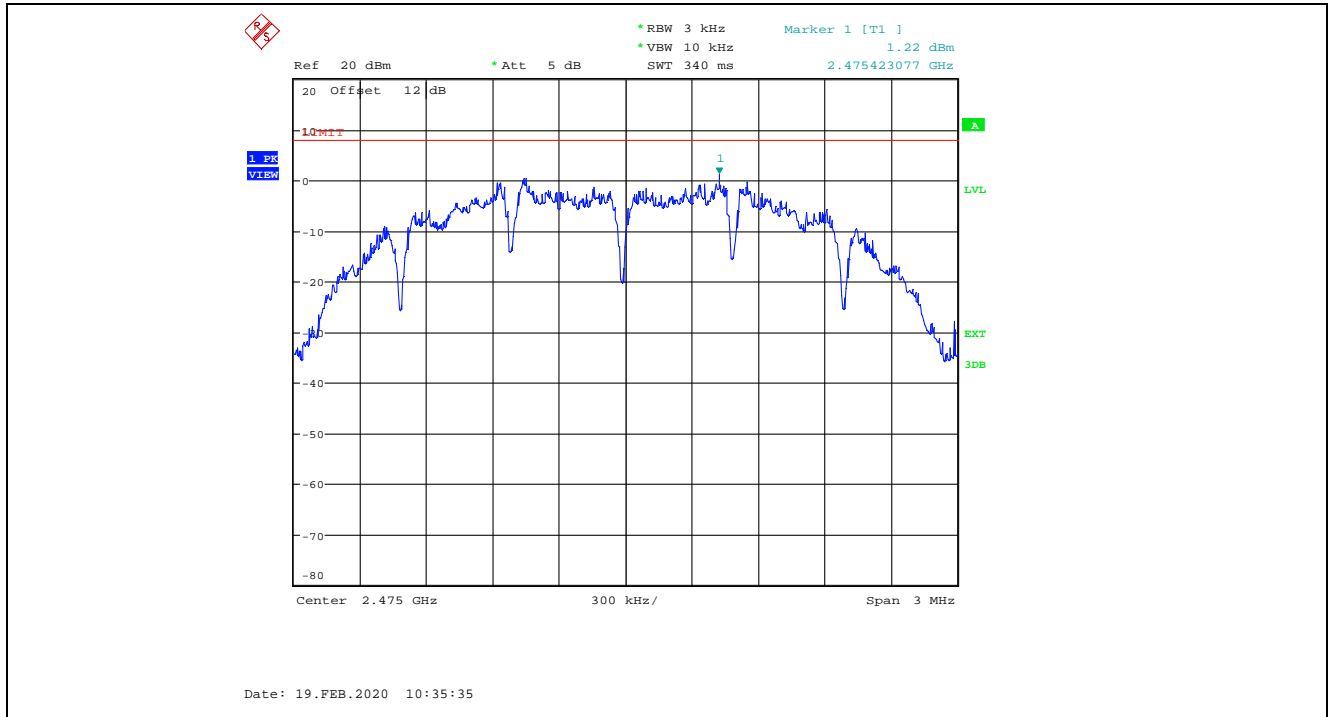

Plot 5.5.5.4. Power Spectral Density, Channel 16, 2480 MHz, MSK modulation, Power Setting 18

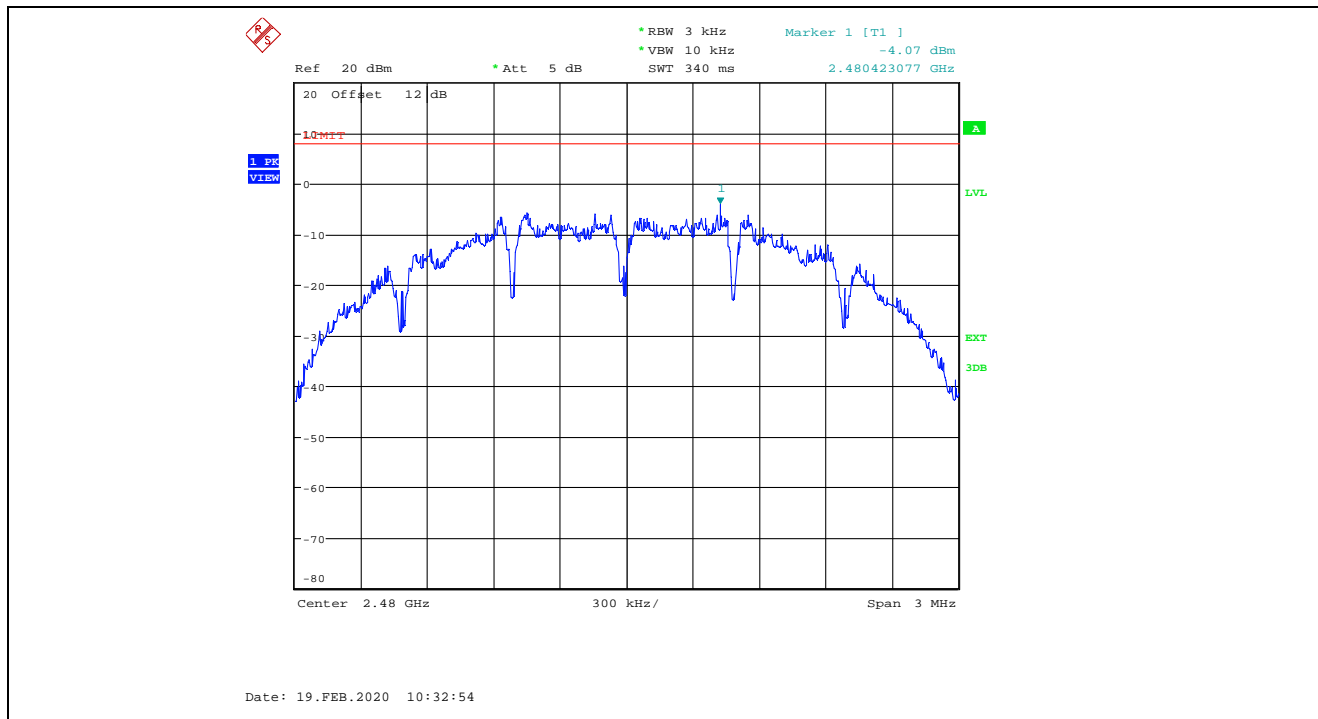

**5.6. RF EXPOSURE REQUIRMENTS [§§ 15.247(i), 1.1310 & 2.1091] RSS Gen 3.4, RSS 102**

FCC has specified the general guidance for meeting RF Exposure requirements in KDB 447498 D01 General RF Exposure Guidance v06, the following are the applicable sections for this module summarized from this guidance.

- 1) The RF exposure requirements for devices operating in mobile and portable exposure conditions are different. When both exposure conditions apply to a device, compliance is determined according to the rules and policies established for both exposure conditions. Equipment authorization for devices that are categorically excluded from routine RF exposure evaluation according to §2.1091(c) and §2.1093(c).
- 2) Standalone and simultaneous transmission use conditions for mobile and portable exposure conditions must be determined according to the host platform and product operating configuration requirements
- 3) Transmitter modules must be approved according to one of the following host platform exposure conditions, with respect to the product configurations tested or evaluated for equipment approval for incorporation in qualified host products. The approved host platform exposure condition(s) must be identified on the grant of equipment certification. When transmitter modules are incorporated in host devices that qualify for RF exposure test exclusion and no other testing or equipment approval is required, the standalone and simultaneous transmission configurations and test exclusion conditions must be fully documented in the grantee’s records.
- 4) The 1-g body and 10-g extremity SAR Test Exclusion Thresholds in 4.3 should be applied to determine SAR test requirements.

**RSS 102 Limits:**

**Table 1: SAR evaluation – Exemption limits for routine evaluation based on frequency and separation distance<sup>4,5</sup>**

Frequency (MHz)	Exemption Limits (mW)				
	At separation distance of ≤5 mm	At separation distance of 10 mm	At separation distance of 15 mm	At separation distance of 20 mm	At separation distance of 25 mm
≤300	71 mW	101 mW	132 mW	162 mW	193 mW
450	52 mW	70 mW	88 mW	106 mW	123 mW
835	17 mW	30 mW	42 mW	55 mW	67 mW
1900	7 mW	10 mW	18 mW	34 mW	60 mW
2450	4 mW	7 mW	15 mW	30 mW	52 mW
3500	2 mW	6 mW	16 mW	32 mW	55 mW
5800	1 mW	6 mW	15 mW	27 mW	41 mW

**Standalone SAR test exclusion threshold condition for radio is verified as per below.**

Unless specifically required by the published RF exposure KDB procedures, standalone 1-g head or body and 10-g extremity SAR evaluation for general population exposure conditions, by measurement or numerical simulation, is not required when the corresponding SAR Test Exclusion Threshold condition(s), listed below, is (are) satisfied. These test exclusion conditions are based on source-based time-averaged maximum conducted output power of the RF channel requiring evaluation, adjusted for tune-up tolerance, and the minimum test separation distance required for the exposure conditions. The minimum test separation distance defined in 4.1 f) is determined by the smallest distance from the antenna and radiating structures or outer surface of the device, according to the host form factor, exposure conditions and platform requirements, to any part of the body or extremity of a user or bystander. To qualify for SAR test exclusion, the test separation distances applied must be fully explained and justified, typically in the SAR measurement or SAR analysis report, by the operating configurations and exposure conditions of the transmitter and applicable host platform requirements, according to the required published RF exposure KDB procedures. When no other RF exposure testing or reporting are required, a statement of justification and compliance must be included in the equipment approval, in lieu of the SAR report, to qualify for SAR test exclusion. When required, the device specific conditions described in the other published RF exposure KDB procedures must be satisfied before applying these SAR test exclusion provisions; for example, handheld PTT two-way radios, handsets, laptops and tablets, etc.

4.3.1 (a) For 100 MHz to 6 GHz and test separation distances ≤ 50 mm, the 1-g and 10-g SAR test exclusion thresholds are determined by the following:

$[(\text{max. power of channel, including tune-up tolerance, mW}) / (\text{min. test separation distance, mm})] \cdot [\sqrt{f(\text{GHz})}] \leq 3.0$  for 1-g SAR, and ≤ 7.5 for 10-g extremity SAR, where

- f(GHz) is the RF channel transmit frequency in GHz.
- Power and distance are rounded to the nearest mW and mm before calculation<sup>31</sup>
- The result is rounded to one decimal place for comparison
- The values 3.0 and 7.5 are referred to as numeric thresholds

**Radio#1 WIFI Radio:**

**Max frequency: 2.48 GHz**  
**Max power 16.62 dbm,**  
**Antenna gain 2 dBi and duty Cycle of 3.458% @ 5 mm separation distance.**  
**Power= 16.62+2=18.62 dBm=72.77mW at 100%**  
**Power after duty cycle=0.03458\*72.77=2.52 mW**

Relative to Numeric Threshold

$$= \frac{[(\text{max. power of channel, including tune-up tolerance, mW}) / (\text{min. test separation distance, mm})] \cdot [\sqrt{f(\text{GHz})}]}{(2.52)/5 \times (\sqrt{2.48})} < 3 = \mathbf{0.793} < \mathbf{3}, \text{ satisfies the exclusion threshold for STAND ALONE}$$

**Radio#2 UHF Mic Radio:**

**Max frequency: 616 MHz**  
**Max power 16.41 mW,**  
**Antenna gain 0 dBi and @ 5 mm separation distance.**

**Power= 16.41 mW**

Relative to Numeric Threshold

$$= \frac{[(\text{max. power of channel, including tune-up tolerance, mW}) / (\text{min. test separation distance, mm})] \cdot [\sqrt{f(\text{GHz})}]}{(16.41)/5 \times (\sqrt{0.616})} = \mathbf{2.58} < \mathbf{3}, \text{ satisfies the exclusion threshold for STAND ALONE}$$

**Simultaneous transmission SAR test exclusion considerations**

4.32 (b) When an antenna qualifies for the standalone SAR test exclusion of 4.3.1 and also transmits simultaneously with other antennas, the standalone SAR value must be estimated according to the following to determine the simultaneous transmission SAR test exclusion criteria:

- 1)  $[(\text{max. power of channel, including tune-up tolerance, mW}) / (\text{min. test separation distance, mm})] \cdot [\sqrt{f(\text{GHz})}] / x$  W/kg, for test separation distances ≤ 50 mm; where x = 7.5 for 1-g SAR and x = 18.75 for 10-g SAR.

This SAR estimation formula has been considered in conjunction with the SAR Test Exclusion Thresholds to result in substantially conservative SAR values of ≤ 0.4 W/kg. When SAR is estimated, the peak SAR location is assumed to be at the feed-point or geometric center of the antenna, whichever provides a smaller antenna separation distance, and this location must be clearly identified in test reports. The estimated SAR is used only to determine simultaneous transmission SAR test exclusion; it should not be reported as the standalone SAR. When SAR is estimated, it must be applied to determine the sum of 1-g SAR test exclusion. When SAR to peak location separation ratio test exclusion is applied, the highest reported SAR for simultaneous transmission can be an estimated standalone SAR if the estimated SAR is the highest among the simultaneously transmitting antennas (see also KDB Publication 690783 D01). For situations where the estimated SAR is overly conservative for certain conditions, the test lab may choose to perform standalone SAR measurements, then use the measured SAR to determine simultaneous transmission SAR test exclusion. Estimated SAR values at selected frequencies, distances, and power levels are illustrated in Appendix D

1. **WIFI Radio:**  
 Max frequency: 2.48 GHz  
 Max power 16.62 dbm,  
 Antenna gain 2 dBi and duty Cycle of 3.458%  
 @ 5 mm separation distance.  
 Power= 16.62+2=18.62 dBm=72.77mW at 100%  
 Power after duty cycle=0.03458\*72.77=2.52  
**Estimated SAR<sub>1</sub>**                    **[2.52/5].[√2.48/7.5]=[0.504\*0.2099]=0.106 W/kg**
  
2. **UHF Mic Radio:**  
 Max frequency: 616 MHz  
 Max power 16.41 mW,  
 Antenna gain 0 dBi and duty Cycle of 100% @ 5 mm separation distance.  
  
 Power =16.41 mW  
**Estimated SAR<sub>2</sub>**                    **[16.41/5].[√0.616/7.5]=[3.2820\*0.1046]=0.343W/kg**

4.32 c) When the sum of SAR is larger than the limit, SAR test exclusion is determined by the SAR to peak location separation ratio. The simultaneously transmitting antennas in each operating mode and exposure condition combination must be considered one pair at a time to determine the SAR to peak location separation ratio to qualify for test exclusion. The ratio is determined by  $(SAR_1 + SAR_2)^{1.5}/R_i$ , rounded to two decimal digits, and must be  $\leq 0.04$  for all antenna pairs in the configuration to qualify for 1-g SAR test exclusion. When 10-g SAR applies, the ratio must be  $\leq 0.10$ . SAR1 and SAR2 are the highest reported or estimated SAR values for each antenna in the pair, and Ri is the separation distance in mm between the peak SAR locations for the antenna pair. The antennas in all antenna pairs that do not qualify for simultaneous transmission SAR test exclusion must be tested for SAR compliance, according to the enlarged zoom scan and volume scan post-processing procedures in KDB Publication 865664 D01.



Peak SAR location distance measured at feed points of antenna pairs:    r1 = 25.02mm    r2 = 44.59mm

**SAR to peak location separation ratio (SPLSR) = (Estimated SAR<sub>1</sub> + Estimated SAR<sub>2</sub>)<sup>1.5</sup>/R<sub>i</sub>**  
**SPLSR = (0.106 + 0.343)<sup>1.5</sup>/25.02 = 0.012 ≤ 0.04 for all antenna pairs in the configuration to qualify for 1-g SAR test exclusion**

**5.7. POWER LINE CONDUCTED EMISSIONS [§15.207(a)], RSS Gen-8.8**

**5.7.1. Limit(s)**

The equipment shall meet the limits of the following table:

Frequency of emission (MHz)	Conducted Limits (dBµV)	
	Quasi-peak	Average
0.15–0.5 .....	66 to 56* .....	56 to 46*
0.5–5 .....	56 .....	46
5–30 .....	60 .....	50

\*Decreases linearly with the logarithm of the frequency

**5.7.2. Method of Measurements**

ANSI C63.4

**5.7.3. Test Equipment**

Test Instruments	Manufacturer	Model No.	Serial No.	Frequency Range	Calibration Due Date
Spectrum Analyzer	Hewlett Packard	HP 8593EM	3412800103	9 kHz–26.5 GHz	Aug 12, 2021
High Pass filter	Rohde & Schwarz	EZ-25	830164/006	Cut off 150kHz	Jun 7, 2020
LISN Used	Schwarzbeck	NSLK 8127	8127276	10 kHz–30 MHz	Mar 1, 2020
AC/DC Adaptor	Emerson Network Power	DCH3-050US-0002	010138	5 V, 500 mA	---

**5.7.4. Test Arrangement**

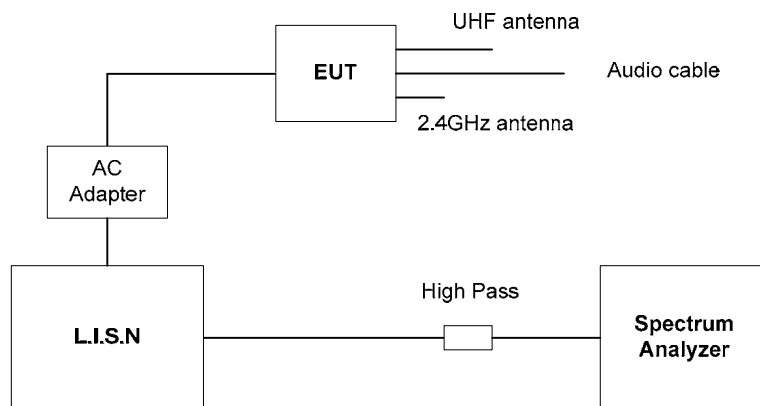



5.7.5. Test Data

Plot 5.7.5.1. Power Line Conducted Emission, Tx Mode  
 Line Voltage: AC 120 V; Line Tested: Line

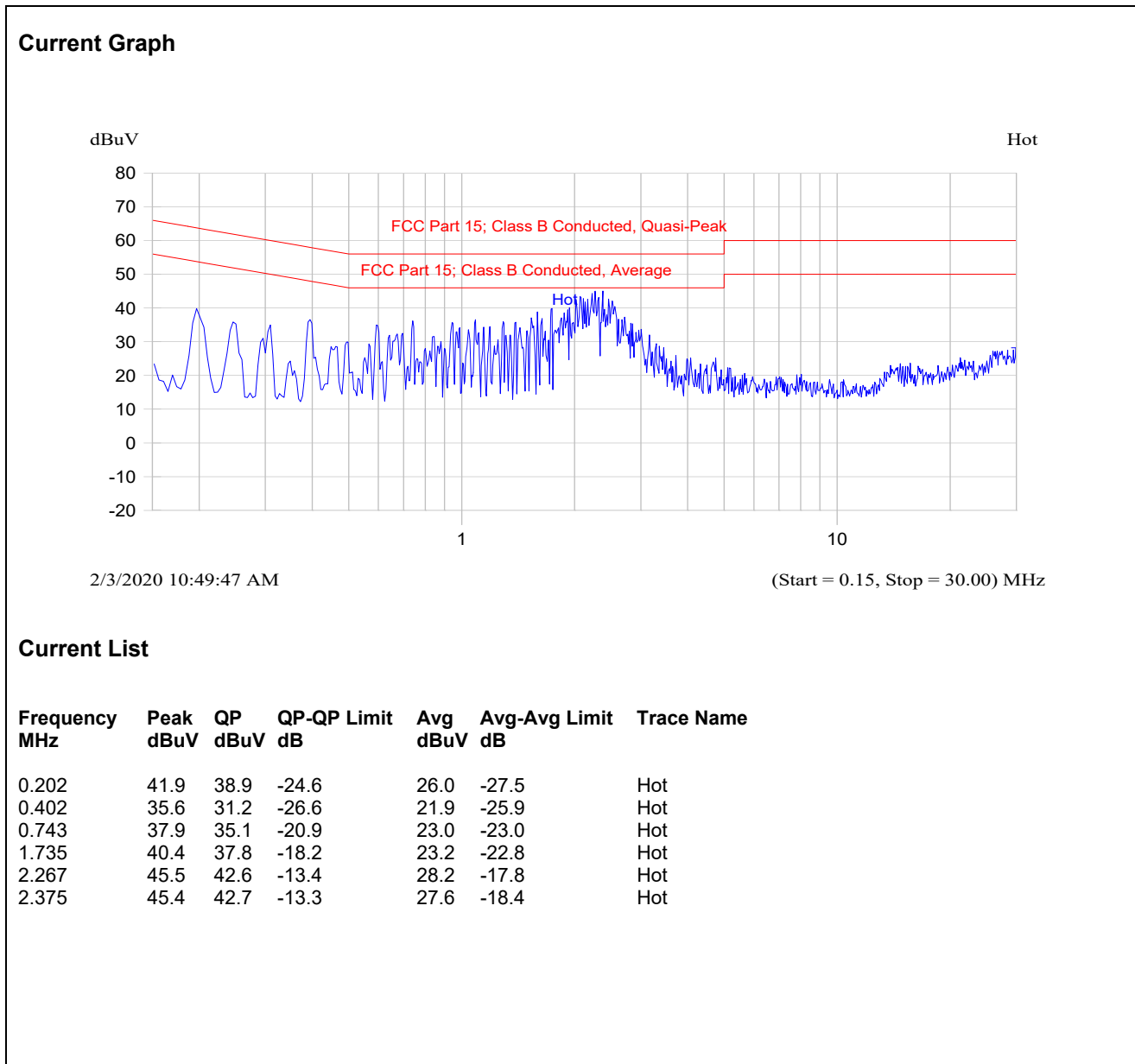

**Plot 5.7.5.2.** Power Line Conducted Emission, Tx Mode  
 Line Voltage: AC 120 V; Line Tested: Neutral

**Current Graph**

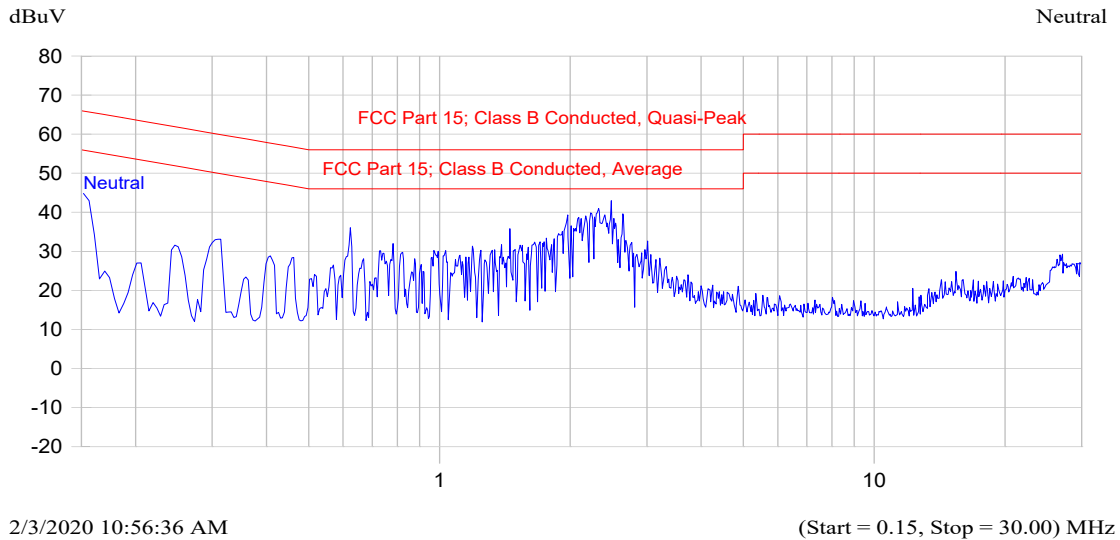

**Current List**

Frequency MHz	Peak dBuV	QP dBuV	QP-QP Limit dB	Avg dBuV	Avg-Avg Limit dB	Trace Name
0.154	45.3	43.3	-22.5	28.7	-27.1	Neutral
0.309	36.6	32.3	-27.7	21.4	-28.6	Neutral
0.619	37.7	33.3	-22.7	19.7	-26.3	Neutral
1.443	37.2	32.4	-23.6	19.9	-26.1	Neutral
2.479	43.1	38.9	-17.1	23.9	-22.1	Neutral

**Plot 5.7.5.3. Power Line Conducted Emission, Rx Mode**  
 Line Voltage: AC 120 V; Line Tested: Line

**Current Graph**

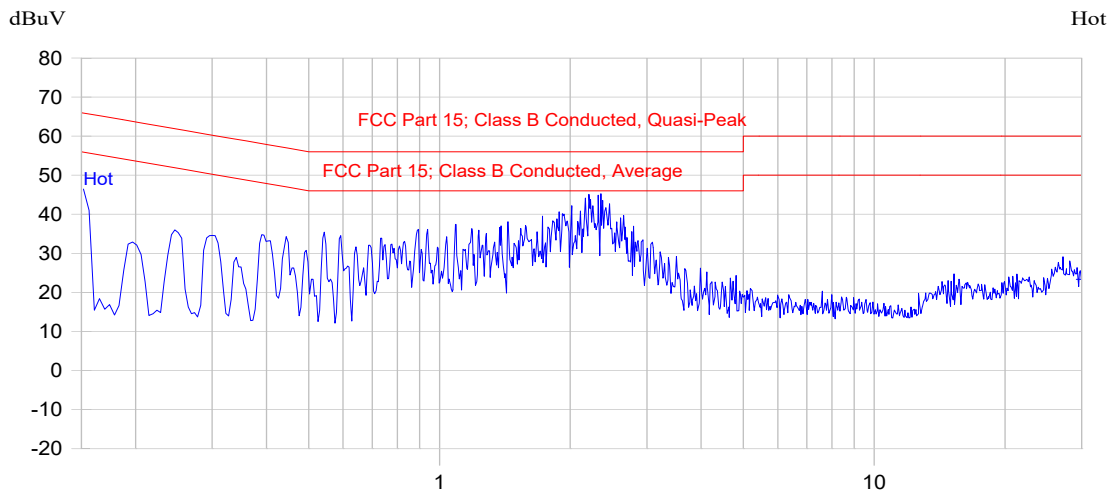

2/3/2020 10:41:32 AM

(Start = 0.15, Stop = 30.00) MHz

**Current List**

Frequency MHz	Peak dBuV	QP dBuV	QP-QP Limit dB	Avg dBuV	Avg-Avg Limit dB	Trace Name
0.154	47.2	45.7	-20.1	30.2	-25.6	Hot
0.258	40.3	37.9	-23.6	23.9	-27.7	Hot
0.392	36.7	34.8	-23.2	23.1	-24.9	Hot
0.543	36.3	33.9	-22.1	22.6	-23.4	Hot
1.083	38.4	35.6	-20.4	22.2	-23.8	Hot
2.369	45.7	42.9	-13.1	27.1	-18.9	Hot

**Plot 5.7.5.4. Power Line Conducted Emission, Rx Mode**  
 Line Voltage: AC 120 V; Line Tested: Neutral

**Current Graph**

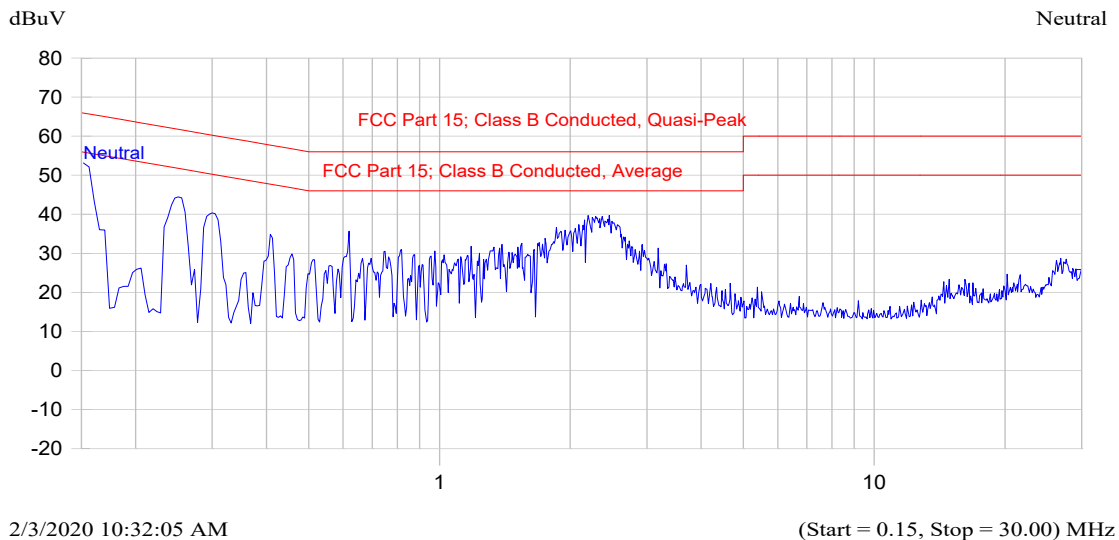

**Current List**

Frequency MHz	Peak dBuV	QP dBuV	QP-QP Limit dB	Avg dBuV	Avg-Avg Limit dB	Trace Name
0.154	51.3	50.0	-15.8	33.3	-22.5	Neutral
0.247	42.9	40.1	-21.7	25.7	-26.1	Neutral
0.294	38.1	35.7	-24.7	19.8	-30.6	Neutral
0.613	36.5	32.0	-24.0	21.0	-25.0	Neutral
2.461	44.3	39.0	-17.0	24.3	-21.7	Neutral

**5.8. Radiated Emissions –Unintentional @ ICES-003**

**5.8.1. Limits**

The equipment shall meet the limits of the following table:

Test Frequency Range (MHz)	Class B Limits (dBµV/m)	EMI Detector Used	Measurement Distance (meters)
30 – 88	40.0	Quasi-Peak	3
88 – 216	43.5	Quasi-Peak	3
216 – 960	46.0	Quasi-Peak	3
960 -1000	54.0	Quasi-Peak	3
Above 1000	54.0 74.0	Average Peak	3

**5.8.2. Method of Measurements**

Refer to Ultratech Test Procedures ULTR-P001-2004 & ANSI C63.4 for method of measurements.

The spectrum shall be investigated from the lowest radio frequency signal generated or used in the device, without going below the lowest frequency for which a radiated emission limit is specified, up to the frequency 5<sup>th</sup> harmonic of the highest frequency or 40 GHz, whichever is lower

**Calculation of Field Strength:**

The field strength is calculated by adding the calibrated antenna factor and cable factor, and subtracting the Amplifier gain (if any) from the measured reading. The basic equation with a sample calculation is as follows:

$$FS = RA + AF + CF - AG$$

- Where FS = Field Strength
- RA = Receiver/Analyzer Reading
- AF = Antenna Factor
- CF = Cable Attenuation Factor
- AG = Amplifier Gain

**5.8.3. Test Equipment**

Test Instruments	Manufacturer	Model No.	Serial No.	Frequency Range	Calibration Due Date
EMI Receiver	Rohde & Schwarz	ESU40	100037	20Hz–40 GHz	Mar 15, 2020
RF Amplifier	Com-Power	PAM-0118A	551052	0.5 – 18 GHz	Jul 24, 2020
Biconilog	Emco	3142B	1575	26-2000 MHz	May 10, 2020
Horn Antenna	Emco	3155	5061	1 – 18 GHz	Apr 30, 2020
AC/DC Adapter	Emerson Network Power	DCH3-050US-0002	010138	5 V, 500 mA	-

**ULTRATECH GROUP OF LABS**

3000 Bristol Circle, Oakville, Ontario, Canada L6H 6G4  
 Tel. #: 905-829-1570, Fax. #: 905-829-8050, Email: [vic@ultratech-labs.com](mailto:vic@ultratech-labs.com), Website: <http://www.ultratech-labs.com>

File #: 21Q5X071\_F15.247C  
 January 20, 2021

*All test results contained in this engineering test report are traceable to National Institute of Standards and Technology (NIST)*

**5.8.4. Test Arrangement**

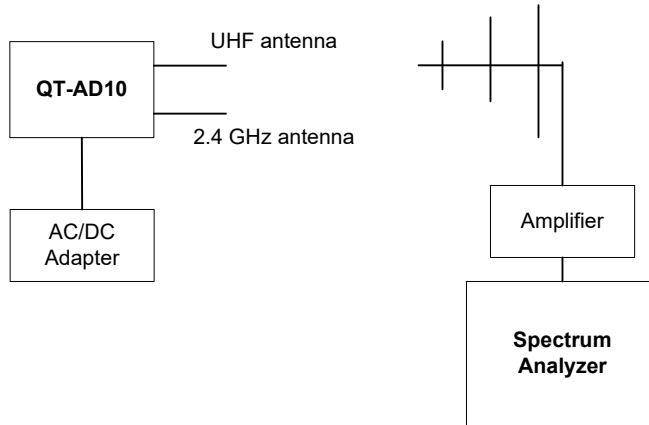

**5.8.5. Test Data**

The emissions were scanned from 30 MHz to 13 GHz at 3 meters distance and all emissions in excess of 20 dB below the limits were recorded.

FREQUENCY (MHz)	RF LEVEL (dBuV/m)	DETECTOR USED (PEAK/QP/AVG)	ANTENNA PLANE (H/V)	LIMIT (dBuV/m)	MARGIN (dB)	PASS/ FAIL
36.21	30.28	PEAK	V	40.0	-9.7	PASS
47.09	30.20	PEAK	V	40.0	-9.8	PASS
152.08	32.19	PEAK	V	43.5	-11.3	PASS
152.08	24.32	PEAK	H	43.5	-19.2	PASS
182.33	32.16	PEAK	V	43.5	-11.3	PASS
182.33	31.73	PEAK	H	43.5	-11.8	PASS
412.40	35.80	PEAK	V	46.0	-10.2	PASS
412.40	35.55	PEAK	H	46.0	-10.5	PASS

No further significant signals.

**EXHIBIT 6. MEASUREMENT UNCERTAINTY**

The measurement uncertainties stated were calculated in accordance with the requirements of CISPR 16-4-2 @ IEC:2003 and JCGM 100:2008 (GUM 1995) – Guide to the Expression of Uncertainty in Measurement.

**6.1. LINE CONDUCTED EMISSION MEASUREMENT UNCERTAINTY**

	Line Conducted Emission Measurement Uncertainty (9 kHz – 30 MHz):	Measured	Limit
<b>u<sub>c</sub></b>	<b>Combined standard uncertainty:</b> $u_c(y) = \sqrt{\sum_{i=1}^m u_i^2(y)}$	<b>± 1.44</b>	<b>± 1.8</b>
<b>U</b>	<b>Expanded uncertainty U:</b> $U = 2u_c(y)$	<b>± 2.89</b>	<b>± 3.6</b>

**6.2. RADIATED EMISSION MEASUREMENT UNCERTAINTY**

	Radiated Emission Measurement Uncertainty @ 3m, Horizontal (30-1000 MHz):	Measured	Limit
<b>u<sub>c</sub></b>	<b>Combined standard uncertainty:</b> $u_c(y) = \sqrt{\sum_{i=1}^m u_i^2(y)}$	<b>± 2.15</b>	<b>± 2.6</b>
<b>U</b>	<b>Expanded uncertainty U:</b> $U = 2u_c(y)$	<b>± 4.30</b>	<b>± 5.2</b>

	Radiated Emission Measurement Uncertainty @ 3m, Vertical (30-1000 MHz):	Measured	Limit
<b>u<sub>c</sub></b>	<b>Combined standard uncertainty:</b> $u_c(y) = \sqrt{\sum_{i=1}^m u_i^2(y)}$	<b>± 2.14</b>	<b>± 2.6</b>
<b>U</b>	<b>Expanded uncertainty U:</b> $U = 2u_c(y)$	<b>± 4.29</b>	<b>± 5.2</b>

	Radiated Emission Measurement Uncertainty @ 3 m, Horizontal & Vertical (1 – 18 GHz):	Measured	Limit
<b>u<sub>c</sub></b>	<b>Combined standard uncertainty:</b> $u_c(y) = \sqrt{\sum_{i=1}^m u_i^2(y)}$	<b>± 1.52</b>	<b>Under consideration</b>
<b>U</b>	<b>Expanded uncertainty U:</b> $U = 2u_c(y)$	<b>± 3.04</b>	<b>Under consideration</b>