

ENGINEERING TEST REPORT

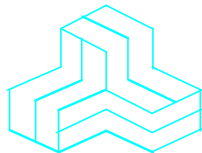

QT-5100A Module
Model No.: QT-5100A
FCC ID: Q5N-QT5100A

Applicant:

Quantum5X Systems Inc.
30 Adelaide Street North, Suite 12
London ON N6B 3N5
Canada

Tested in Accordance With

Federal Communications Commission (FCC)
47 CFR, Parts 2 and 74

UltraTech's File No.: 18Q5X047_FCC74H1

This Test report is Issued under the Authority of
Tri M. Luu
Vice President of Engineering
UltraTech Group of Labs

Date: February 28. 2018

Report Prepared by: Dan Huynh

Tested by: Wei Wu

Issued Date: February 28. 2018

Test Dates: December 15 - 19, 2016
March 29, April 3, & July 11, 2017

- *The results in this Test Report apply only to the sample(s) tested, and the sample tested is randomly selected.*
- *This report must not be used by the client to claim product endorsement by any agency of the US Government.*
- *This test report shall not be reproduced, except in full, without a written approval from UltraTech*

UltraTech

3000 Bristol Circle, Oakville, Ontario, Canada L6H 6G4
Tel.: (905) 829-1570 Fax.: (905) 829-8050
Website: www.ultratech-labs.com, Email: vic@ultratech-labs.com, Email: tri@ultratech-labs.com



91038



1309



46390-2049



AT-1945



SL2-IN-E-1119R



Korea
KCC-RRR
CA2049

TABLE OF CONTENTS

EXHIBIT 1. INTRODUCTION..... 1

1.1. SCOPE..... 1

1.2. RELATED SUBMITTAL(S)/GRANT(S)..... 1

1.3. NORMATIVE REFERENCES 1

EXHIBIT 2. PERFORMANCE ASSESSMENT..... 2

2.1. CLIENT INFORMATION 2

2.2. EQUIPMENT UNDER TEST (EUT) INFORMATION..... 2

2.3. EUT'S TECHNICAL SPECIFICATIONS..... 3

2.4. LIST OF EUT'S PORTS 3

2.5. ANCILLARY EQUIPMENT 3

EXHIBIT 3. EUT OPERATING CONDITIONS AND CONFIGURATIONS DURING TESTS..... 4

3.1. CLIMATE TEST CONDITIONS 4

3.2. OPERATIONAL TEST CONDITIONS & ARRANGEMENT FOR TEST SIGNALS 4

EXHIBIT 4. SUMMARY OF TEST RESULTS 5

4.1. LOCATION OF TESTS 5

4.2. APPLICABILITY & SUMMARY OF EMISSION TEST RESULTS 5

4.3. DEVIATION OF STANDARD TEST PROCEDURES..... 5

4.4. MODIFICATIONS INCORPORATED IN THE EUT FOR COMPLIANCE PURPOSES 6

EXHIBIT 5. MEASUREMENTS, EXAMINATIONS & TEST DATA FOR EMC EMISSIONS..... 7

5.1. RF POWER OUTPUT [§§ 2.1046 & 74.861] 7

5.2. AUDIO FREQUENCY RESPONSE [§ 2.1047(a)] 8

5.3. MODULATION LIMITING [§§ 2.1047 (b) & 74.861(e)(3)]..... 11

5.4. OCCUPIED BANDWIDTH, EMISSION MASKS [§§ 2.1049 & 74.861(e)(5),(6)&(7)]..... 14

5.5. SPURIOUS EMISSIONS AT ANTENNA TERMINAL [§§ 2.1051, 2.1057 & 74.861(e)(6)] 23

5.6. FIELD STRENGTH OF SPURIOUS RADIATION [§§ 2.1053, 2.1057 & 74.861(e)(6)]..... 33

5.7. FREQUENCY STABILITY [§§ 2.1055 & 74.861(e)(4)] 35

5.8. RF EXPOSURE REQUIRMENTS [§§ 15.247(i), 1.1310 & 2.1091]..... 37

EXHIBIT 6. TEST EQUIPMENT LIST 39

EXHIBIT 7. MEASUREMENT UNCERTAINTY..... 40

7.1. RADIATED EMISSION MEASUREMENT UNCERTAINTY 40

ULTRATECH GROUP OF LABS

3000 Bristol Circle, Oakville, Ontario, Canada L6H 6G4
Tel. #: 905-829-1570, Fax. #: 905-829-8050, Email: vic@ultratech-labs.com, Website: <http://www.ultratech-labs.com>

File #: 18Q5X047_FCC74H1
February 28, 2018

All test results contained in this engineering test report are traceable to National Institute of Standards and Technology (NIST)

EXHIBIT 1. INTRODUCTION

1.1. SCOPE

Reference:	FCC Parts 2 and 74
Title:	Code of Federal Regulations (CFR), Title 47 Telecommunication – Parts 2 and 74
Purpose of Test:	To obtain FCC Certification Authorization for Radio operating
Test Procedures:	ANSI C63.26

1.2. RELATED SUBMITTAL(S)/GRANT(S)

None

1.3. NORMATIVE REFERENCES

Publication	Year	Title
FCC CFR Parts 0-19, 80-End	2017	Code of Federal Regulations – Telecommunication
ANSI C63.4	2014	American National Standard for Methods of Measurement of Radio-Noise Emissions from Low-Voltage Electrical and Electronic Equipment in the Range of 9 kHz to 40 GHz
ANSI/TIA-603-E	2016	Land Mobile FM or PM Communications Equipment Measurement and Performance Standards
ANSI C63.26	2015	American National Standard for Compliance Testing of Transmitters used in Licensed Radio Services
CISPR 22	2008-09 Ed 6	Information Technology Equipment - Radio Disturbance Characteristics - Limits and Methods of Measurement
CISPR 16-1-1 +A1 +A2	2006 2006 2007	Specification for radio disturbance and immunity measuring apparatus and methods. Part 1-1: Measuring Apparatus
CISPR 16-1-2 +A1 +A2	2003 2004 2006	Specification for radio disturbance and immunity measuring apparatus and methods. Part 1-2: Conducted disturbances
ETSI EN 300 422-1 V1.4.2	2011-08	Electromagnetic compatibility and Radio spectrum Matters (ERM); Wireless microphones in the 25 MHz to 3 GHz frequency range; Part 1: Technical characteristics and methods of measurement

EXHIBIT 2. PERFORMANCE ASSESSMENT

2.1. CLIENT INFORMATION

APPLICANT	
Name:	Quantum5X Systems Inc.
Address:	30 Adelaide Street North, Suite 12 London ON N6B 3N5 Canada
Contact Person:	Mr. Paul Johnson Phone #: 519-675-6999 Fax #: 519-667-2162 Email Address: paul@q5x.com

MANUFACTURER	
Name:	Quantum5X Systems Inc.
Address:	30 Adelaide Street North, Suite 12 London ON N6B 3N5 Canada
Contact Person:	Mr. Paul Johnson Phone #: 519-675-6999 Fax #: 519-667-2162 Email Address: paul@q5x.com

2.2. EQUIPMENT UNDER TEST (EUT) INFORMATION

The applicant has supplied the following information (with the exception of the Date of Receipt).

Brand Name:	Quantum5X Systems Inc.
Product Name:	QT-5100A Module
Model Name or Number:	QT-5100A
Serial Number:	Test sample
Type of Equipment:	Licensed Broadcast Transmitter Worn on Body
Power Supply Requirement:	3.7 Lithium-Ion Battery / 5 VDC
Transmitting/Receiving Antenna Type:	Integral and Non-integral
Primary User Functions of EUT:	The Primary use is to broadcast audio from the user.

ULTRATECH GROUP OF LABS

3000 Bristol Circle, Oakville, Ontario, Canada L6H 6G4
Tel. #: 905-829-1570, Fax. #: 905-829-8050, Email: vic@ultratech-labs.com, Website: <http://www.ultratech-labs.com>

File #: 18Q5X047_FCC74H1

February 28, 2018

All test results contained in this engineering test report are traceable to National Institute of Standards and Technology (NIST)

2.3. EUT'S TECHNICAL SPECIFICATIONS

Transmitter	
Equipment Type:	Mobile and Portable
Intended Operating Environment:	Commercial, industrial or business environment
Power Supply Requirement:	3.7 Lithium-Ion Battery / 5 VDC
RF Output Power Rating:	0.010 to 0.250 Watt
Operating Frequency Range:	470.250 - 550.000 MHz
RF Output Impedance:	50 Ω
Channel Spacing:	25 kHz
Occupied Bandwidth (99%):	128.37 kHz
Emission Designation*:	180KF3E
* Necessary Bandwidth is calculated as follows: For Sound broadcasting: $B_n = 2M + 2DK$, $K = 1$ (typically), $D = 75,000$ Hz, $M = 15,000$ $B_n = 2M + 2DK = 2(15,000) + 2(75,000)(1) = 180,000$ Hz = 180 kHz Emission designation: 180KF3E	

2.4. LIST OF EUT'S PORTS

Port Number	EUT's Port Description	Number of Identical Ports	Connector Type	Cable Type (Shielded/Non-shielded)
1	Audio input, Single Pin lemo	1	Single Pin Lemo	2" min length, Shielded
2	UHF Antenna	1	Hardwired	4.5"
3	802.15.4 Antenna	1	Hardwired	1 1/8"
4	Battery Charger	1	Micro USB	5', Shielded

2.5. ANCILLARY EQUIPMENT

The EUT was tested while connected to the following representative configuration of ancillary equipment necessary to exercise the ports during tests:

Ancillary Equipment # 1	
Description:	AC/DC Adapter
Brand Name:	Emerson
Model Name or Number:	DCH3-050US-002

EXHIBIT 3. EUT OPERATING CONDITIONS AND CONFIGURATIONS DURING TESTS

3.1. CLIMATE TEST CONDITIONS

The climate conditions of the test environment are as follows:

Temperature:	21°C - 24°C
Humidity:	45% to 58%
Pressure:	102 kPa
Power Input Source:	3.7 Lithium-Ion Battery / 5 VDC

3.2. OPERATIONAL TEST CONDITIONS & ARRANGEMENT FOR TEST SIGNALS

Operating Modes:	The transmitter was operated in a continuous transmission mode with the carrier modulated as specified in the Test Data.
Special Test Software:	N/A
Special Hardware Used:	N/A
Transmitter Test Antenna:	The EUT is tested with the antenna port terminated to a 50 Ohm RF Load.

Transmitter Test Signals	
Frequency Band(s):	470.250 - 550.000 MHz
Test Frequencies: (Near lowest, near middle & near highest frequencies in the frequency range of operation.)	470.250 MHz, 510.000 MHz, 550.000 MHz
Transmitter Wanted Output Test Signals:	
Transmitter Power (measured maximum output power):	237.68 mW
Normal Test Modulation:	FM Voice
Modulating signal source:	External

EXHIBIT 4. SUMMARY OF TEST RESULTS

4.1. LOCATION OF TESTS

All of the measurements described in this report were performed at Ultratech Group of Labs located in the city of Oakville, Province of Ontario, Canada.

Radiated Emissions were performed at the Ultratech's 3-10 TDK Semi-Anechoic Chamber situated in the Town of Oakville, province of Ontario. This test site been calibrated in accordance with ANSI C63.4, and found to be in compliance with the requirements of Sec. 2.948 of the FCC Rules. The descriptions and site measurement data of the Oakville 3-10 TDK Semi-Anechoic Chamber has been filed with ANAB File No.: AT-1945.

4.2. APPLICABILITY & SUMMARY OF EMISSION TEST RESULTS

FCC Section(s)	Test Requirements	Applicability (Yes/No)
2.1046 and 74.861(e)(1)	RF Power Output	Yes
2.1047(a)	Modulation characteristics, Audio Frequency Response	Tests are conducted under FCC's recommendation.
2.1047(b) and 74.861(e)(3)	Modulation characteristics, Modulation Limiting	Yes
2.1049 and 74.861(e)(5)	Occupied bandwidth	Yes
2.1051, 2.1057 and 74.861(e)(6)	Spurious Emissions at Antenna Terminal	Yes
2.1053, 2.1057 and 74.861(e)(6)	Field Strength of Spurious Radiation	Yes
2.1055 and 74.861(e)(4)	Frequency Stability	Yes
1.1307, 1.1310, 2.1091 & 2.1093	RF Exposure Limit	Yes

4.3. DEVIATION OF STANDARD TEST PROCEDURES

None

ULTRATECH GROUP OF LABS

3000 Bristol Circle, Oakville, Ontario, Canada L6H 6G4
Tel. #: 905-829-1570, Fax. #: 905-829-8050, Email: vic@ultratech-labs.com, Website: <http://www.ultratech-labs.com>

File #: 18Q5X047_FCC74H1
February 28, 2018

All test results contained in this engineering test report are traceable to National Institute of Standards and Technology (NIST)

4.4. MODIFICATIONS INCORPORATED IN THE EUT FOR COMPLIANCE PURPOSES

The device shall need a ferrite clamp on AC adapter, near micro USB connector, Stewart ferrite P/N: 28A2029-0A2 with 2 ½ turns.



EXHIBIT 5. MEASUREMENTS, EXAMINATIONS & TEST DATA FOR EMC EMISSIONS

5.1. RF POWER OUTPUT [§§ 2.1046 & 74.861]

5.1.1. Limit(s)

74.861(e)(1)(ii) 470-608 and 614-698: 250 mW conducted power.

5.1.2. Method of Measurements

TIA-603-E, Clause 2.2.1

5.1.3. Test Arrangement

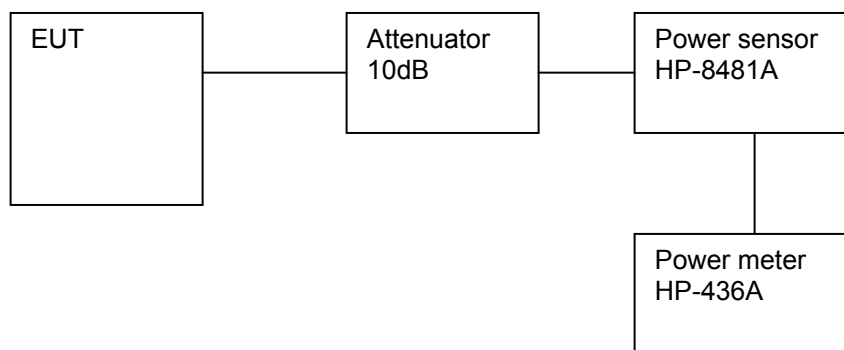

5.1.4. Test Data

Frequency (MHz)	Power Rating (mW)	Measured Power		Limit (mW)
		(dBm)	(mW)	
470.250	250	23.76	237.68	250
510.000	250	23.39	218.27	250
550.000	250	22.92	195.88	250
470.250	10	9.32	8.55	250
510.000	10	7.96	6.25	250
550.000	10	8.67	7.36	250

5.2. AUDIO FREQUENCY RESPONSE [§ 2.1047(a)]

5.2.1. Limit(s)

§ 2.1047(a): Voice modulated communication equipment. A curve or equivalent data showing the frequency response of the audio modulating circuit over a range of 100 to 5000 Hz shall be submitted. For equipment required to have an audio low-pass filter, a curve showing the frequency response of the filter or of all circuitry installed between the modulation limiter and the modulated stage shall be submitted.

5.2.2. Method of Measurements

The rated audio input signal was applied to the input of the audio low-pass filter (or of all modulation stages) using an audio oscillator, this input signal level and its corresponding output signal were then measured and recorded using the FFT Digital Spectrum Analyzer. Tests were repeated at different audio signal frequencies from 0.1 to 30 kHz.

5.2.3. Test Arrangement

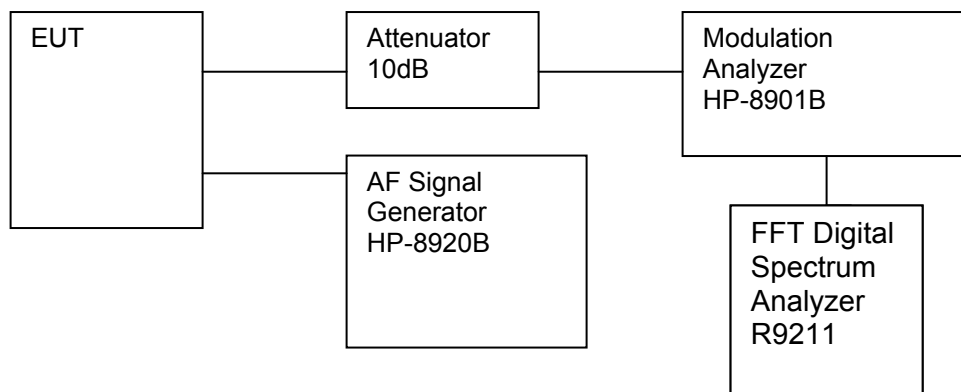

5.2.4. Test Data

Remark(s):

- Due to the difficulty of measuring the Frequency Response of the internal low-pass filter, the Frequency Response of All Modulation States is performed to show the roll-off at 3 kHz in comparison with the recommended audio filter attenuation.
- Tests were conducted at different audio signal frequencies from 0.1 to 30 kHz.

25 kHz Channel Spacing, F3E				
Frequency (kHz)	Audio In (dBV)	Audio Out (dBV)	Attenuation (Out - In) (dB)	Attenuation Rel. to 1 kHz (dB)
0.1	-2.38	4.77	7.2	-2.6
0.2	-2.38	5.97	8.4	-1.4
0.4	-2.38	6.18	8.6	-1.2
0.6	-2.38	6.51	8.9	-0.9
0.8	-2.38	7.09	9.5	-0.3
1.0	-2.38	7.37	9.8	0.0
1.5	-2.38	7.51	9.9	0.1
2.0	-2.38	7.86	10.2	0.5
2.5	-2.38	8.26	10.6	0.9
3.0	-2.38	8.46	10.8	1.1
3.5	-2.38	8.64	11.0	1.3
4.0	-2.38	8.78	11.2	1.4
4.5	-2.38	8.90	11.3	1.5
5.0	-2.38	8.99	11.4	1.6
6.0	-2.38	9.15	11.5	1.8
7.0	-2.38	9.26	11.6	1.9
8.0	-2.38	9.33	11.7	2.0
9.0	-2.38	9.34	11.7	2.0
10.0	-2.38	9.36	11.7	2.0
11.0	-2.38	9.30	11.7	1.9
12.0	-2.38	9.21	11.6	1.8
13.0	-2.38	9.07	11.5	1.7
14.0	-2.38	8.67	11.1	1.3
15.0	-2.38	8.39	10.8	1.0
20.0	-2.38	5.68	8.1	-1.7
25.0	-2.38	1.02	3.4	-6.4
30.0	-2.38	-5.10	-2.7	-12.5

ULTRATECH GROUP OF LABS

3000 Bristol Circle, Oakville, Ontario, Canada L6H 6G4
 Tel. #: 905-829-1570, Fax. #: 905-829-8050, Email: vic@ultratech-labs.com, Website: <http://www.ultratech-labs.com>

File #: 18Q5X047_FCC74H1

February 28, 2018

All test results contained in this engineering test report are traceable to National Institute of Standards and Technology (NIST)

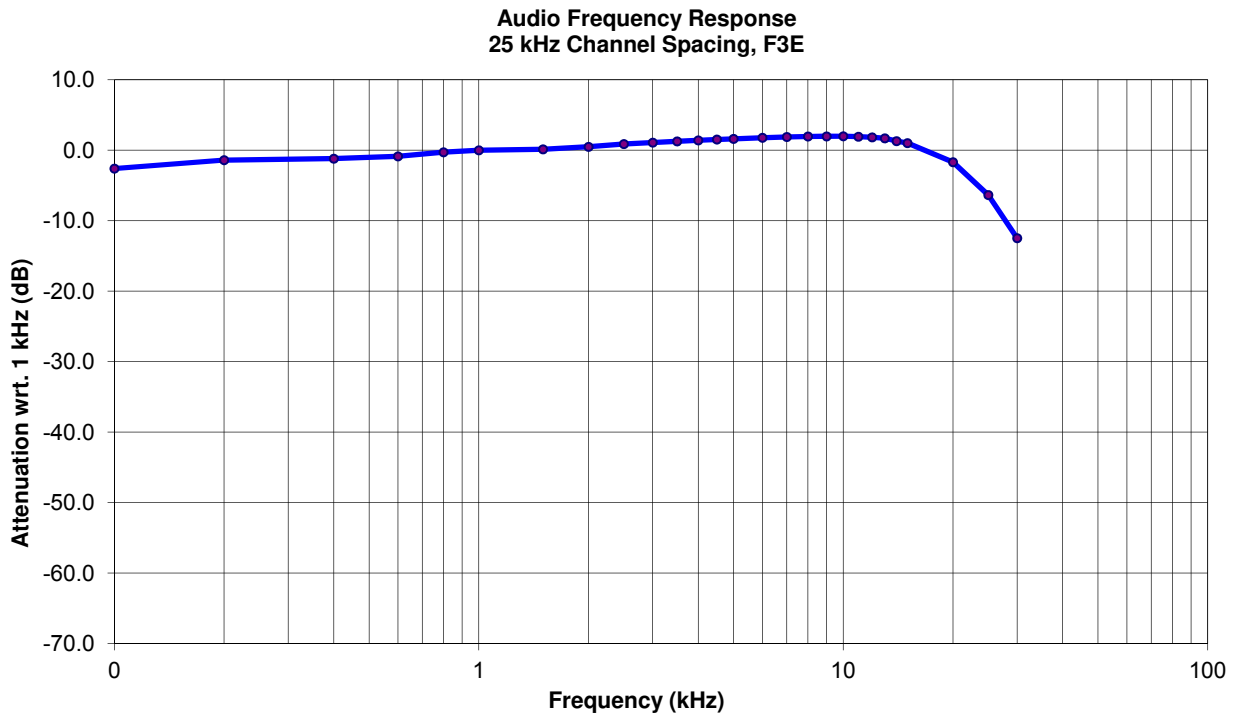

ULTRATECH GROUP OF LABS

3000 Bristol Circle, Oakville, Ontario, Canada L6H 6G4
Tel. #: 905-829-1570, Fax. #: 905-829-8050, Email: vic@ultratech-labs.com, Website: <http://www.ultratech-labs.com>

File #: 18Q5X047_FCC74H1

February 28, 2018

All test results contained in this engineering test report are traceable to National Institute of Standards and Technology (NIST)

5.3. MODULATION LIMITING [§§ 2.1047 (b) & 74.861(e)(3)]

5.3.1. Limits

§ 2.1047(b): Equipment which employs modulation limiting. A curve or family of curves showing the percentage of modulation versus the modulation input voltage shall be supplied. The information submitted shall be sufficient to show modulation limiting capability throughout the range of modulating frequencies and input modulating signal levels employed.

§74.861(e)(3) Any form of modulation may be used. A maximum deviation of ± 75 kHz is permitted when frequency modulation is employed.

5.3.2. Method of Measurements

For Audio Transmitter: The carrier frequency deviation was measured with the tone input signal level varied from 0 Vp to the maximum audio input rating level declared by the manufacturer at frequencies 0.1, 0.5, 1.0, 3.0, 5.0, 10.0 and 15.0 kHz. The maximum deviation was recorded at each test condition.

For Data Transmitter with Maximum Frequency Deviation set by Factory: The EUT was set at maximum frequency deviation, and its peak frequency deviation was then measured using EUT's internal random data source.

5.3.3. Test Arrangement

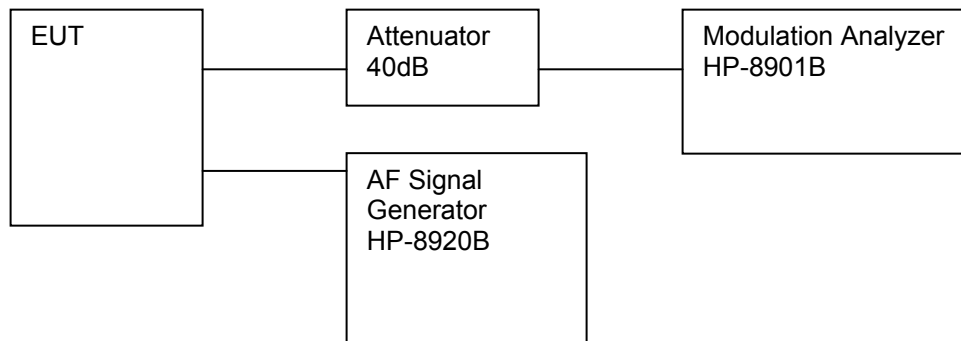

5.3.4. Test Data

Voice Modulation Limiting for 25 kHz Channel Spacing Operation								
Modulating Signal Level (mVrms)	Peak Frequency Deviation (kHz) at the following modulating frequency:							Maximum Limit (kHz)
	0.1 kHz	0.5 kHz	1.0 kHz	3.0 kHz	5.0 kHz	10.0 kHz	15.0 kHz	
5	4.68	5.14	5.36	5.74	5.77	5.87	5.66	75.0
10	5.50	6.07	6.35	6.92	7.04	7.15	6.80	75.0
20	6.57	7.42	7.82	8.66	8.95	9.02	8.45	75.0
30	7.41	8.42	8.93	9.93	10.21	10.39	9.23	75.0
40	8.09	9.31	8.85	11.03	11.35	11.56	10.27	75.0
50	8.71	10.06	10.23	11.96	12.37	12.58	11.68	75.0
60	9.26	10.76	11.53	12.83	13.31	13.52	12.61	75.0
70	9.25	11.39	12.21	13.66	14.15	14.00	13.35	75.0
80	10.32	12.02	12.95	14.52	15.08	15.31	14.21	75.0
90	10.64	12.48	13.38	14.99	15.56	15.84	14.66	75.0
100	11.11	13.04	14.01	15.73	16.28	16.58	15.39	75.0
200	14.63	17.44	18.82	21.25	22.06	22.48	20.75	75.0
300	17.33	20.65	22.35	25.32	26.41	26.84	24.72	75.0
400	19.57	23.39	25.37	28.83	30.03	30.53	28.14	75.0
500	21.51	25.77	28.02	31.89	33.26	33.83	30.11	75.0
600	23.37	28.03	30.52	34.81	36.37	36.87	33.83	75.0
700	25.09	30.08	32.70	37.39	39.09	39.70	36.42	75.0
800	26.88	32.23	35.08	40.11	42.00	42.70	36.43	75.0
900	27.85	33.52	36.48	41.80	43.80	44.40	39.11	75.0
1000	29.35	35.32	38.46	44.20	46.20	46.80	43.10	75.0

Voice Signal Input Level: 1 Vrms (max. audio signal level declared by the manufacturer)

Modulation Frequency (kHz)	Peak Deviation (kHz)	Maximum Limit (kHz)
0.1	29.35	75.0
0.2	31.48	75.0
0.4	34.37	75.0
0.6	36.16	75.0
0.8	37.48	75.0
1.0	38.48	75.0
1.2	38.31	75.0
1.4	40.20	75.0
1.6	40.70	75.0
1.8	41.40	75.0
2.0	42.10	75.0
2.5	43.20	75.0
3.0	44.10	75.0
3.5	44.80	75.0
4.0	45.40	75.0
4.5	45.90	75.0
5.0	46.20	75.0
6.0	46.70	75.0
7.0	47.00	75.0
8.0	47.10	75.0
9.0	47.10	75.0
10.0	47.00	75.0
15.0	42.90	75.0
20.0	32.26	75.0
25.0	20.98	75.0
30.0	12.22	75.0

5.4. OCCUPIED BANDWIDTH, EMISSION MASKS [§§ 2.1049 & 74.861(e)(5),(6)&(7)]

5.4.1. Limit(s)

Occupied Bandwidth:

§74.861(e)(5) The operating bandwidth shall not exceed 200 kHz.

Emission Masks:

§74.861(e)(6) The mean power of emissions shall be attenuated below the mean output power of the transmitter in accordance with the following schedule:

- (i) On any frequency removed from the operating frequency by more than 50 percent up to and including 100 percent of the authorized bandwidth: at least 25 dB;
- (ii) On any frequency removed from the operating frequency by more than 100 percent up to and including 250 percent of the authorized bandwidth: at least 35 dB;
- (iii) On any frequency removed from the operating frequency by more than 250 percent of the authorized bandwidth: at least $43 + 10\log_{10}$ (mean output power in watts) dB.

§74.861(e)(7) Analog emissions within the band from one megahertz below to one megahertz above the carrier frequency shall comply with the emission mask in *Section 8.3.1.2 of the European Telecommunications Institute Standard ETSI EN 300 422-1 v1.4.2 (2011-08)*. Digital emissions within the band from one megahertz below to one megahertz above the carrier frequency shall comply with the emission mask in *Section 8.3.2.2 (Figure 4) of the European Telecommunications Institute Standard ETSI EN 300 422-1 v1.4.2 (2011-08)*. Beyond one megahertz below and above the carrier frequency, emissions shall be attenuated 90 dB below the level of the unmodulated carrier. The requirements of this paragraph (e)(7) shall not apply to applications for certification of equipment in these bands until nine months after release of the Commission's Channel Reassignment Public Notice, as defined in §73.3700(a)(2) of this chapter.

5.4.2. Method of Measurements

ANSI C63.26-2015 Section 5.4.4 and TIA-603-E, Clause 2.2.11

5.4.3. Test Arrangement

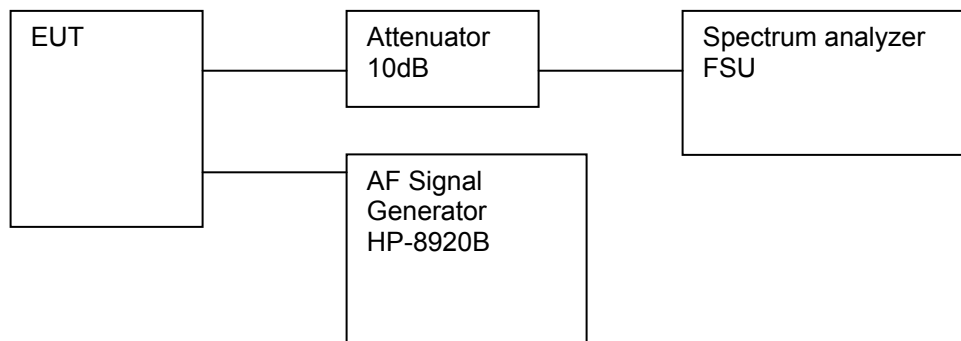

5.4.4. Test Data

5.4.4.1. 99% Occupied Bandwidth

Modulation	Channel Spacing (kHz)	Frequency (MHz)	*Measured 99% OBW at Maximum Freq. Deviation (kHz)	Maximum Authorized Bandwidth (kHz)
FM - Direct Modulation	25	470.250	95.19	200
		510.000	95.19	200
		550.000	128.37	200

* Measured using 99% OBW function of the spectrum analyzer.

Refer to the following test data plots for details.

Plot 5.4.4.1.1. Occupied Bandwidth, 470.250 MHz, Audio input 15 kHz 1 Vrms, High Power

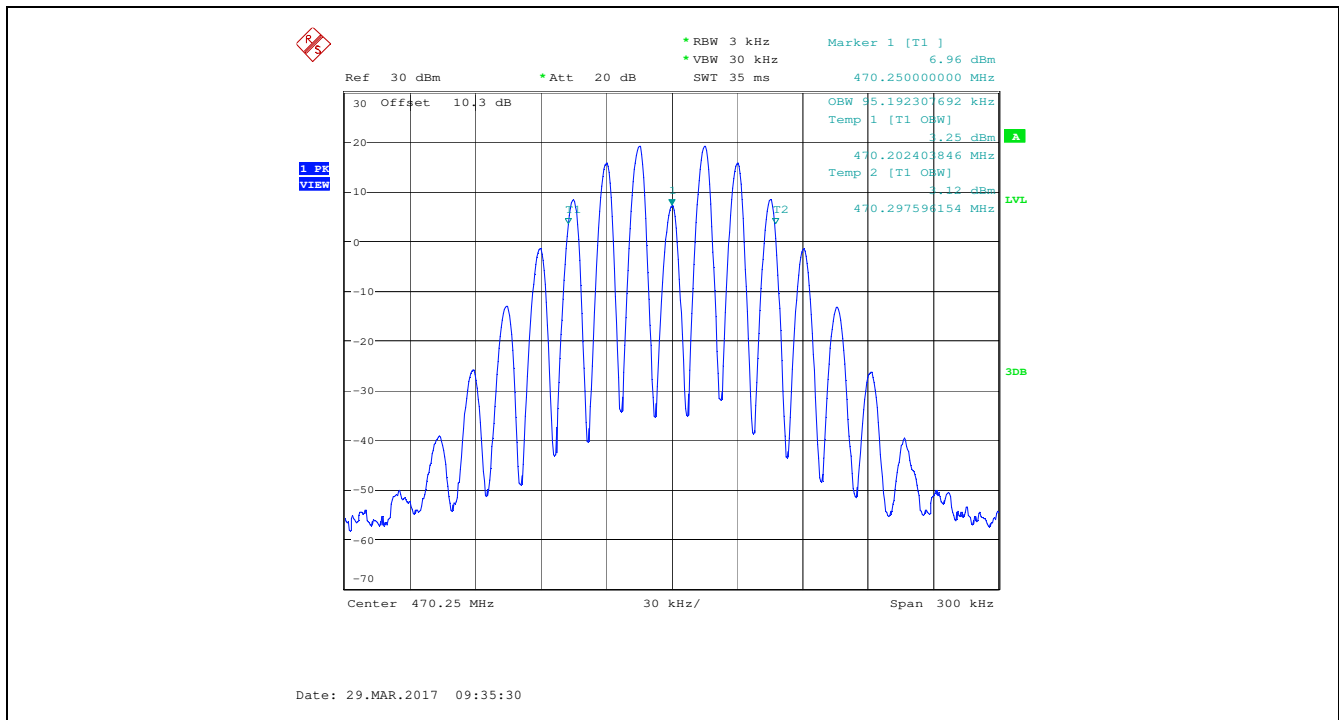

Plot 5.4.4.1.2. Occupied Bandwidth, 510.000 MHz, Audio input 15 kHz 1 Vrms, High Power

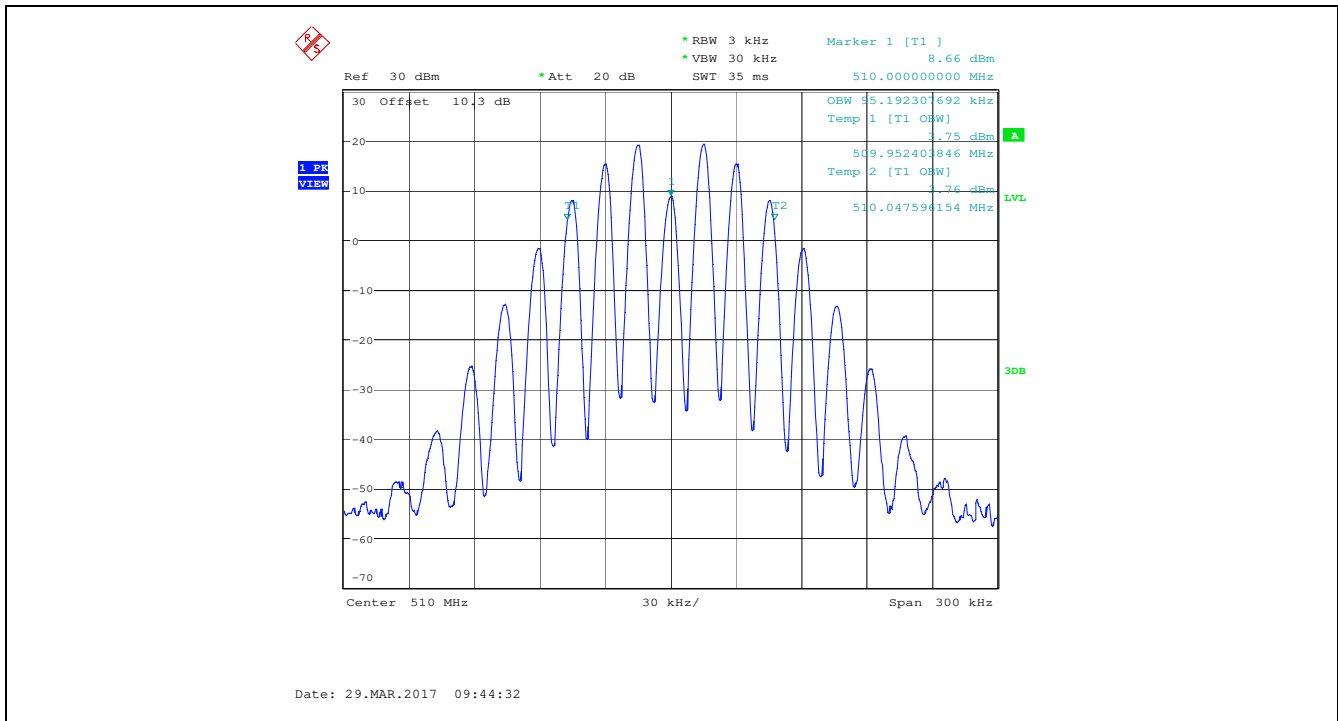

Plot 5.4.4.1.3. Occupied Bandwidth, 550.000 MHz, Audio input 15 kHz 1 Vrms, High Power

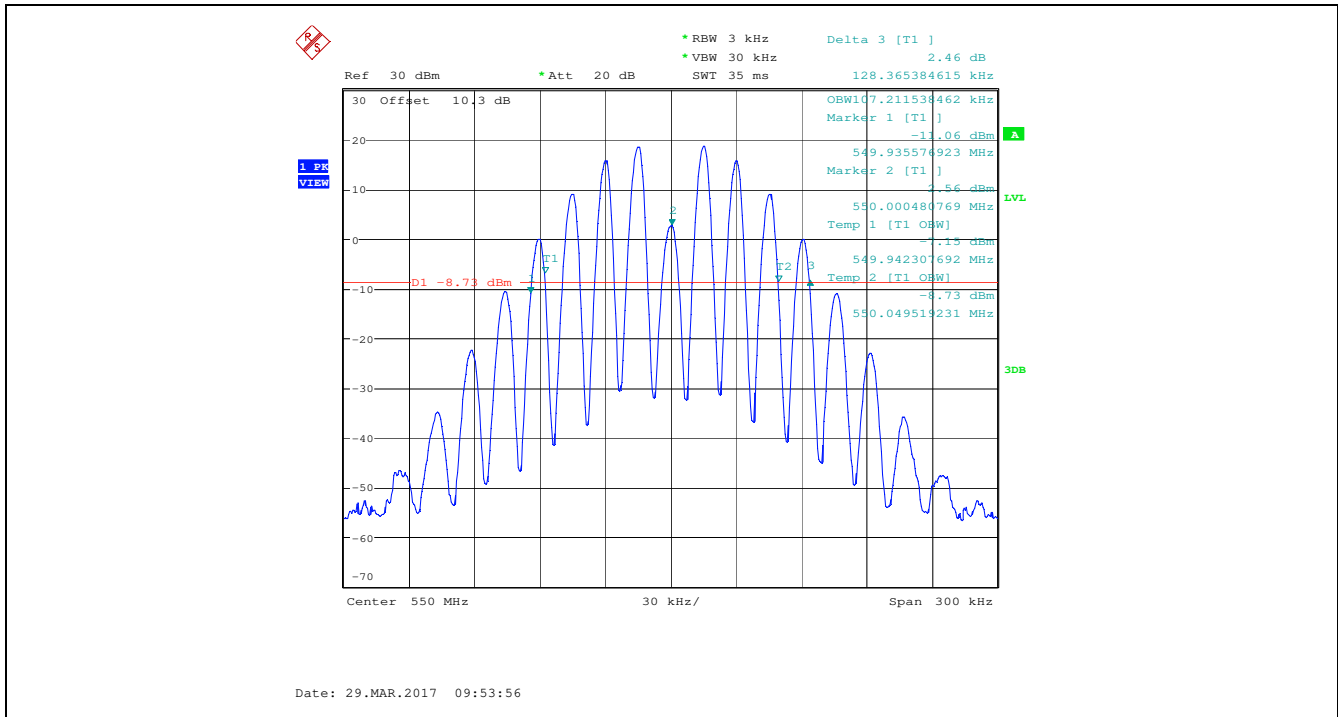

5.4.4.2. Emission Mask of §74.861(e)(6)

Plot 5.4.4.2.1. Emission Mask of §74.861(e)(6), 470.250 MHz, High Power, Audio input 15 kHz 1 Vrms

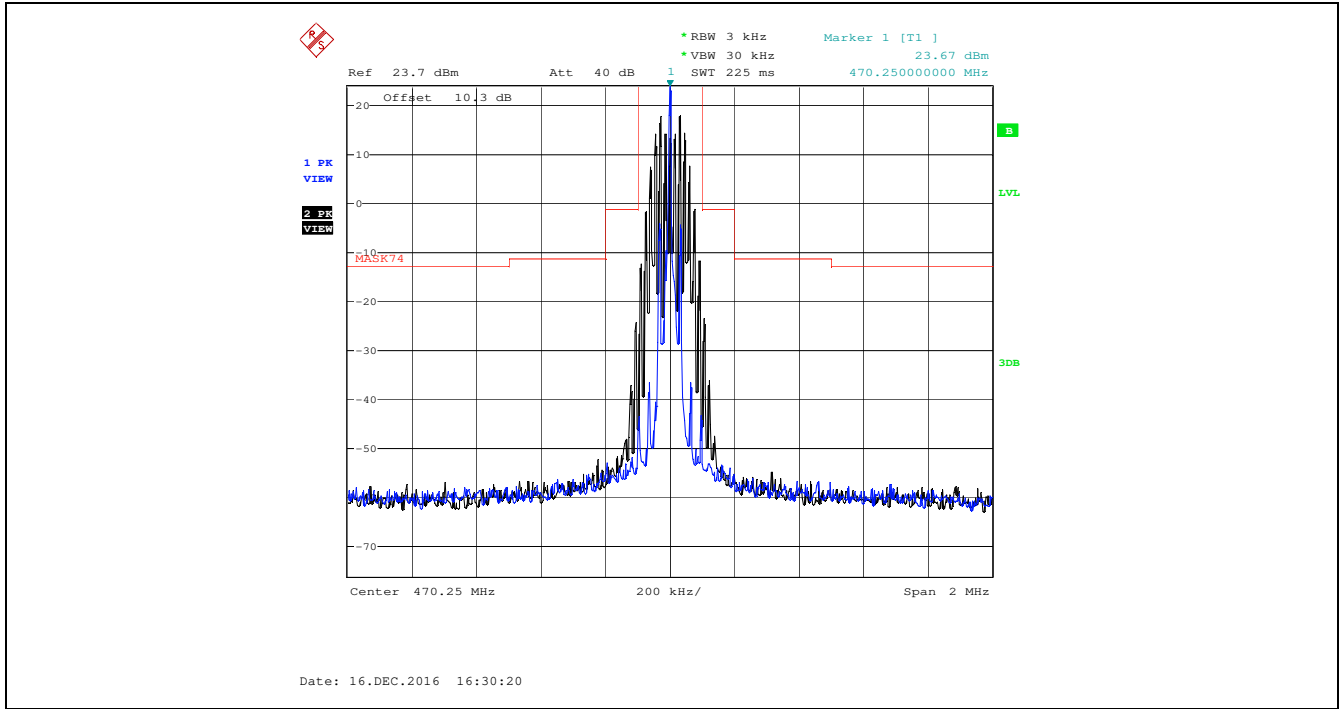

Plot 5.4.4.2.2. Emission Mask of §74.861(e)(6), 470.250 MHz, Low Power, Audio input 15 kHz 1 Vrms

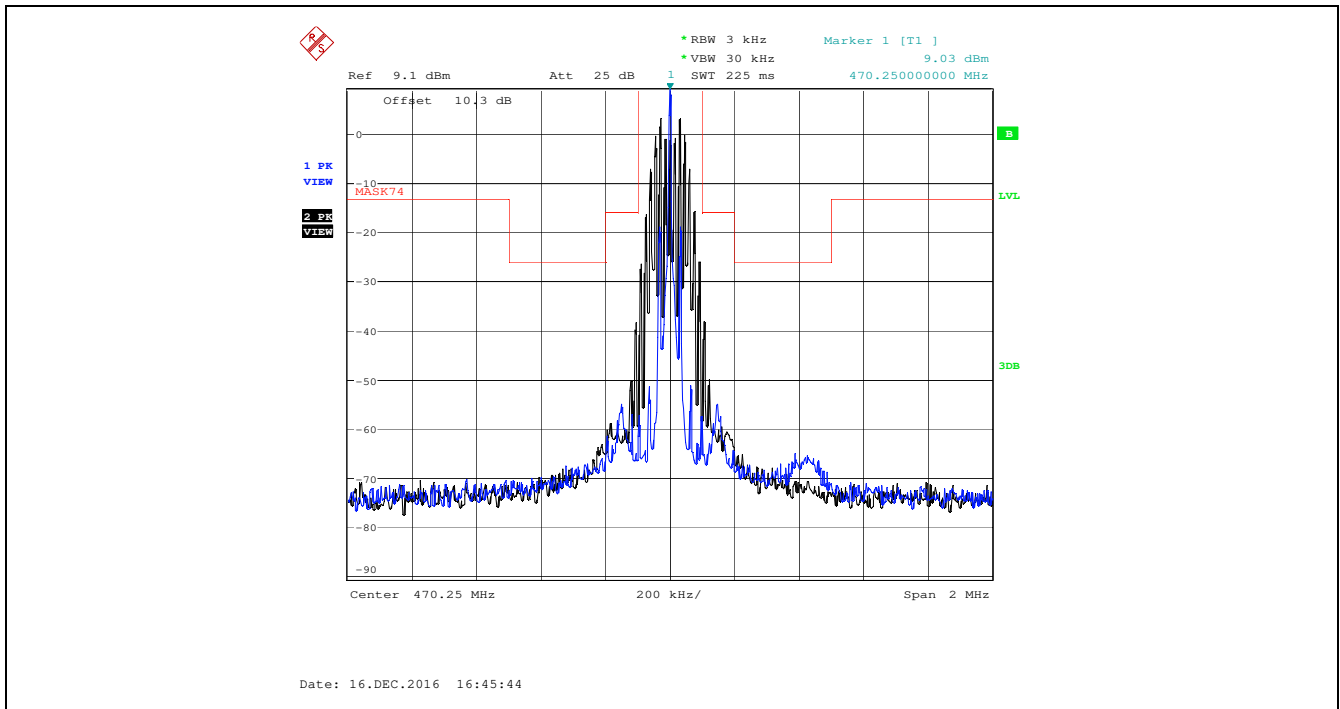

Plot 5.4.4.2.3. Emission Mask of §74.861(e)(6), 510.000 MHz, High Power, Audio input 15 kHz 1 Vrms

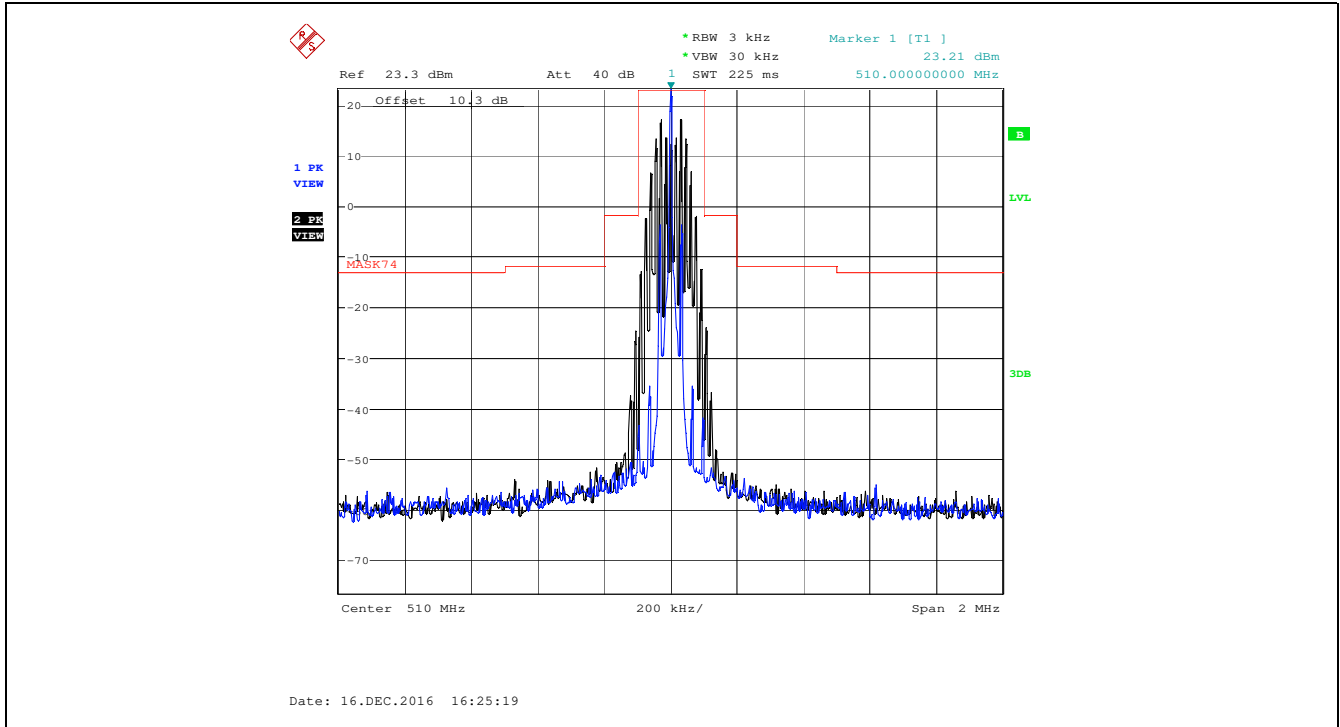

Plot 5.4.4.2.4. Emission Mask of §74.861(e)(6), 510.000 MHz, Low Power, Audio input 15 kHz 1 Vrms

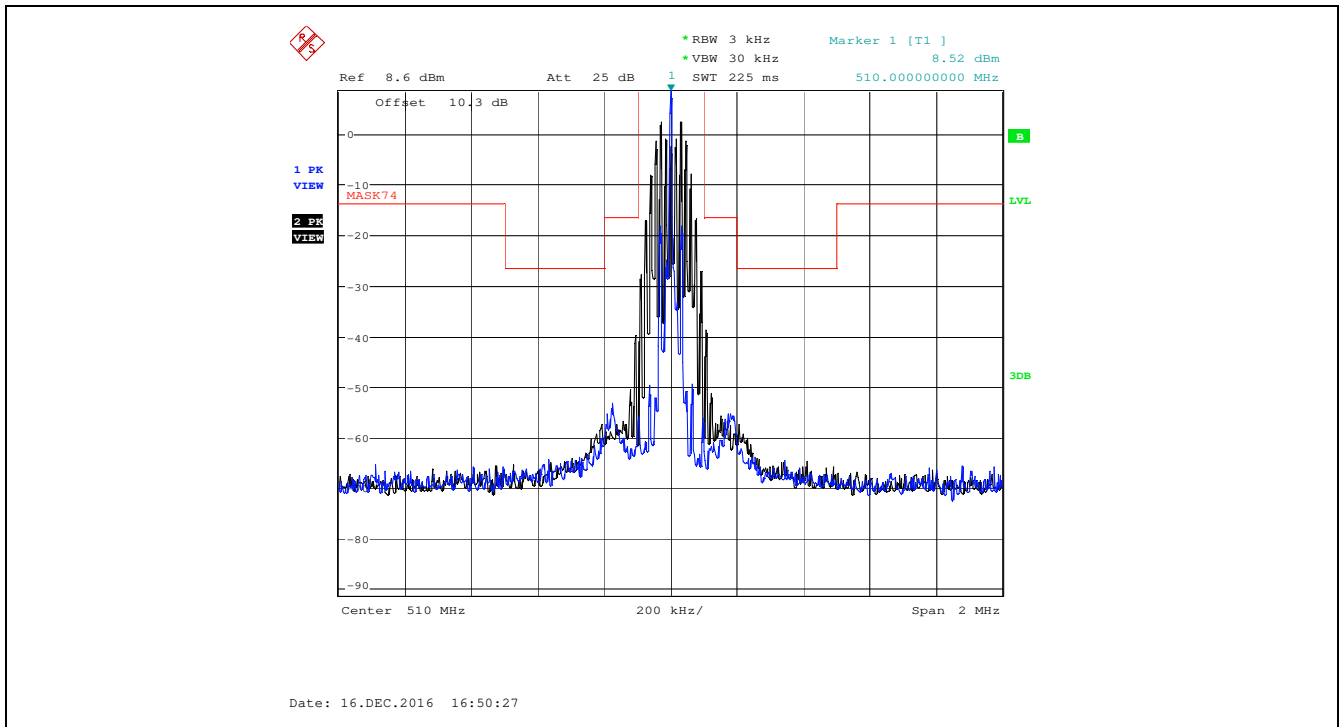

Plot 5.4.4.2.5. Emission Mask of §74.861(e)(6), 550.000 MHz, High Power, Audio input 15 kHz 1 Vrms

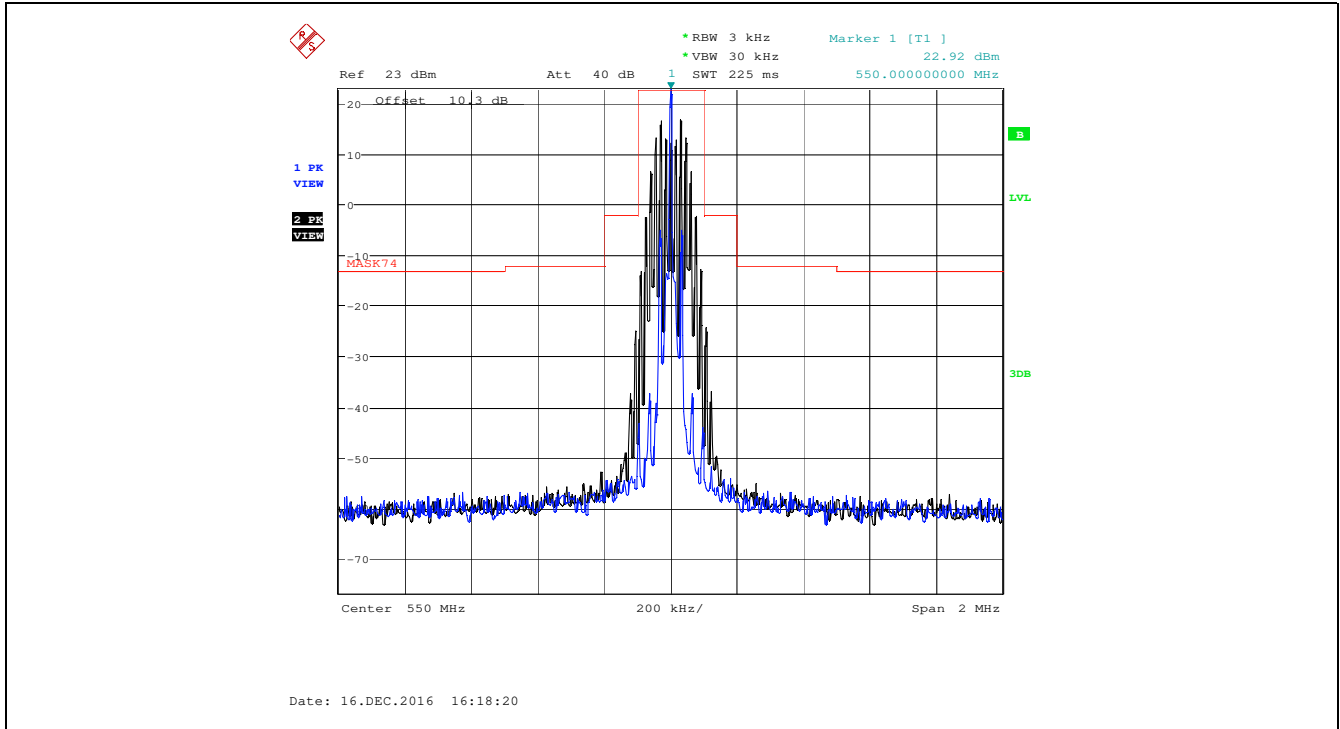

Plot 5.4.4.2.6. Emission Mask of §74.861(e)(6), 550.000 MHz, Low Power, Audio input 15 kHz 1 Vrms

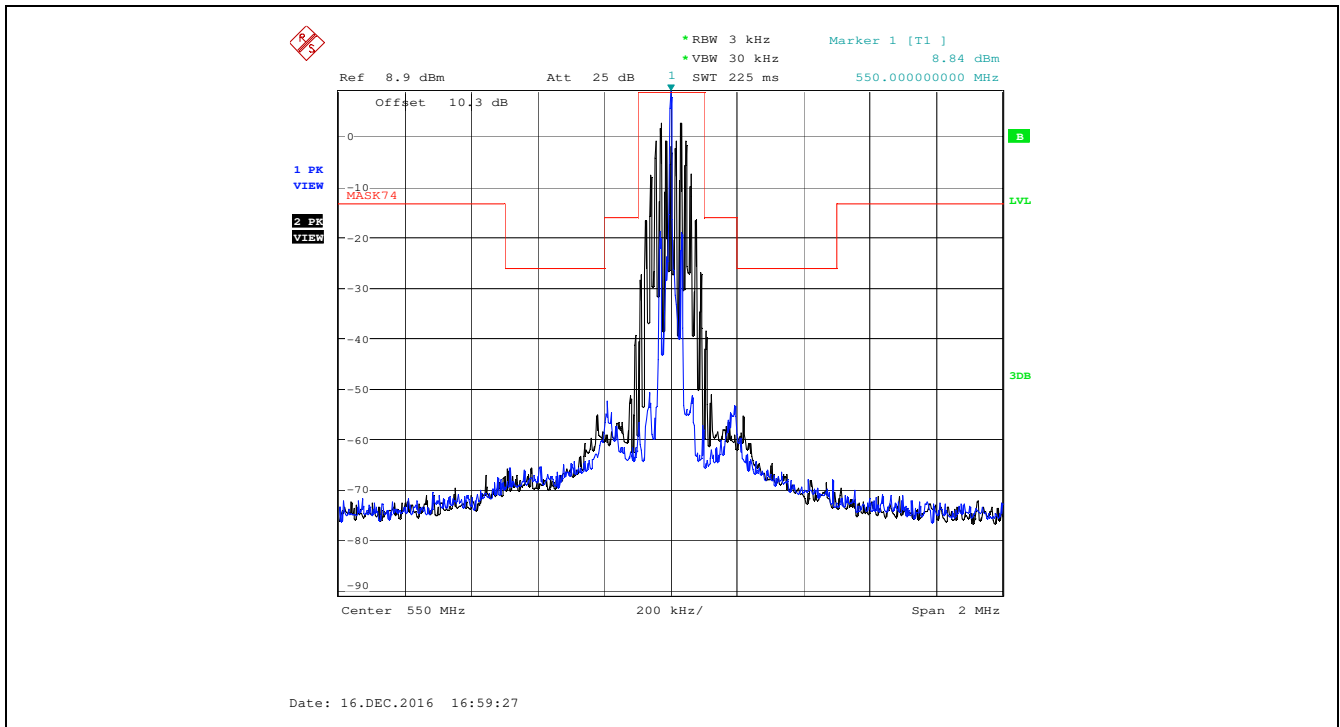

5.4.4.3. Emission Mask of §74.861(e)(7)

Plot 5.4.4.3.1. Emission Mask of §74.861(e)(7), 470.250 MHz, High Power
Audio input maximum 1 Vrms, Noise source input level 1V band limit to 15 kHz

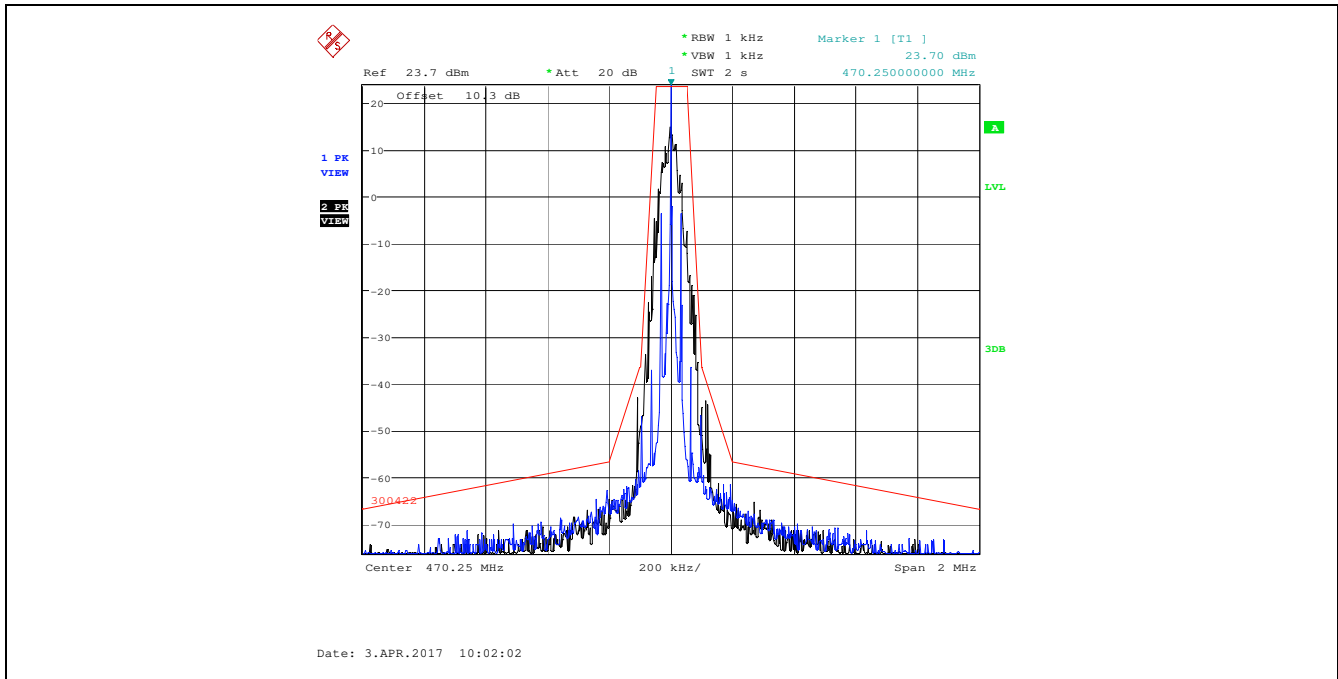

Plot 5.4.4.3.2. Emission Mask of §74.861(e)(7), 470.250 MHz, Low Power
Audio input maximum 1 Vrms, Noise source input level 1V band limit to 15 kHz

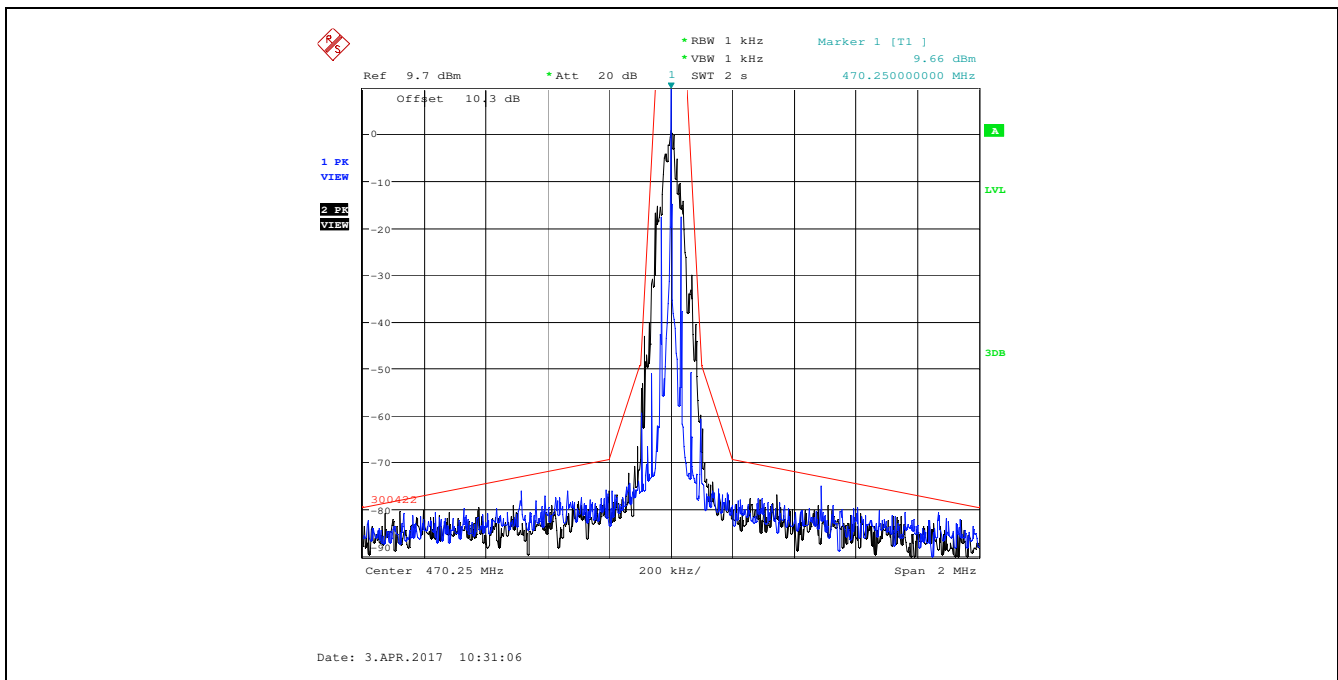

Plot 5.4.4.3.3. Emission Mask of §74.861(e)(7), 510.000 MHz, High Power
Audio input maximum 1 Vrms, Noise source input level 1V band limit to 15 kHz

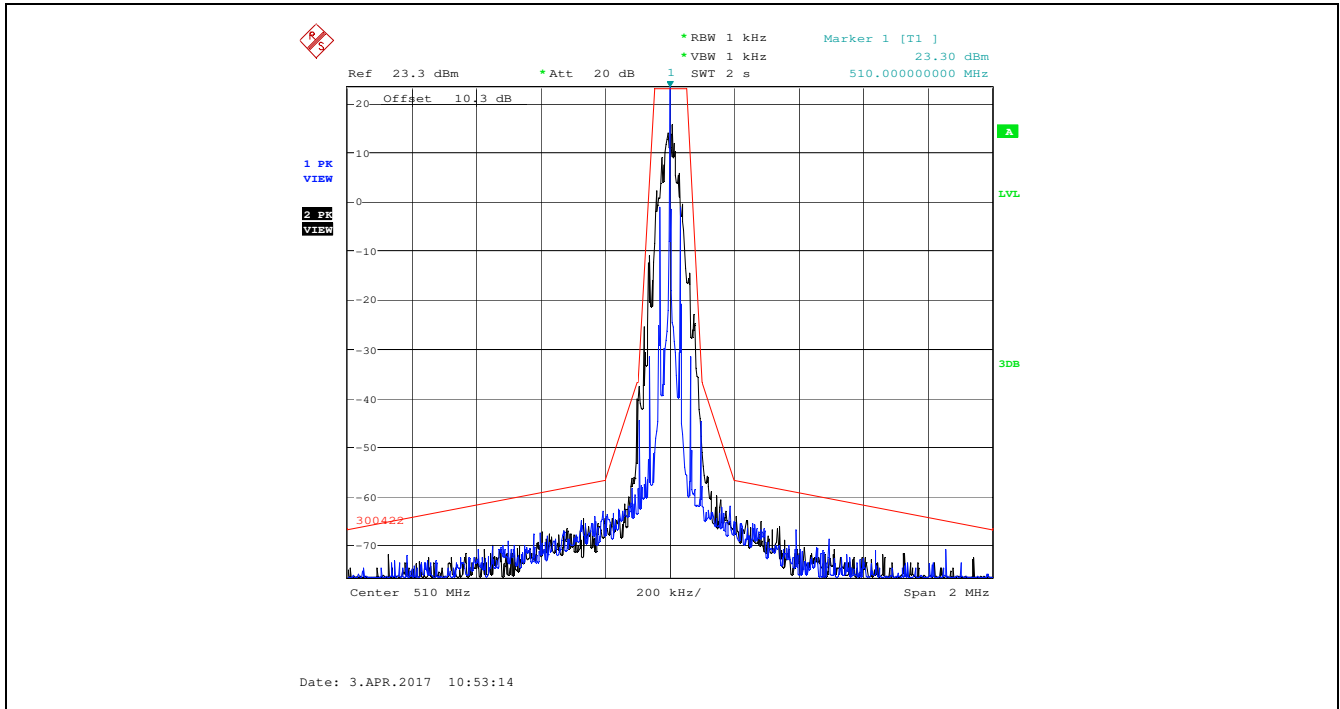

Plot 5.4.4.3.4. Emission Mask of §74.861(e)(7), 510.000 MHz, Low Power
Audio input maximum 1 Vrms, Noise source input level 1V band limit to 15 kHz

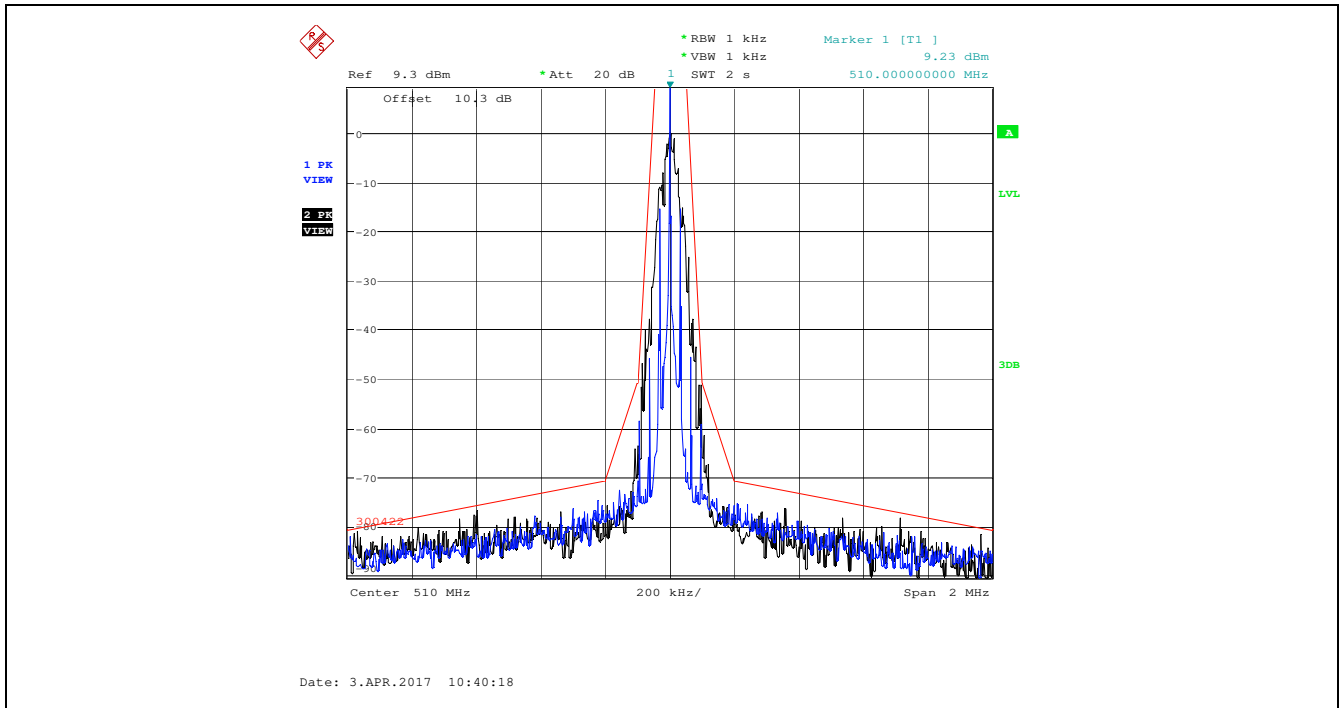

Plot 5.4.4.3.5. Emission Mask of §74.861(e)(7), 550.000 MHz, High Power
Audio input maximum 1 Vrms, Noise source input level 1V band limit to 15 kHz

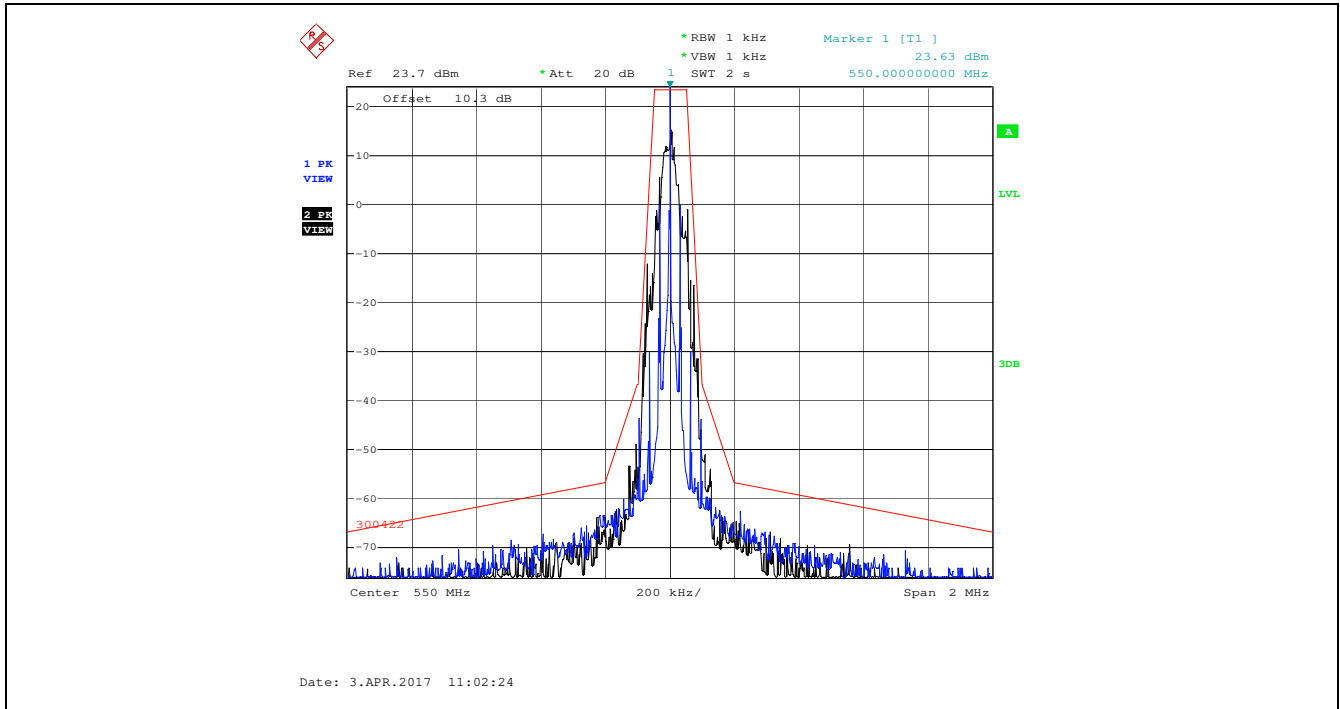

Plot 5.4.4.3.6. Emission Mask of §74.861(e)(7), 550.000 MHz, Low Power
Audio input maximum 1 Vrms, Noise source input level 1V band limit to 15 kHz

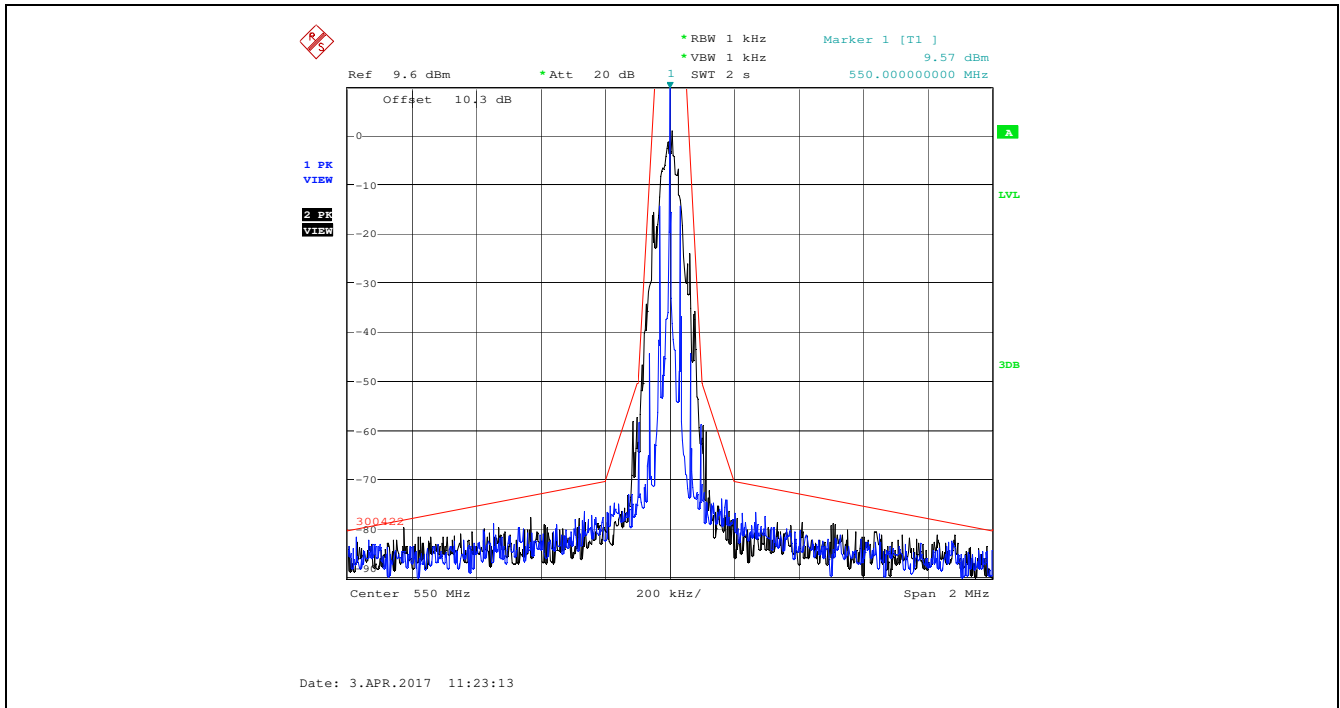

5.5. SPURIOUS EMISSIONS AT ANTENNA TERMINAL [§§ 2.1051, 2.1057 & 74.861(e)(6)]

5.5.1. Limit(s)

Emissions shall be attenuated below the mean output power of the transmitter as follows:

FCC Rules	Attenuation Limit (dBc)
§ 74.861(e)(6)	At least $43 + 10\log_{10}$ (mean power in watts) dB

5.5.2. Method of Measurements

ANSI C63.26-2015 Clause 5.7 and/or TIA-603-E, Clause 2.2.13

5.5.3. Test Arrangement

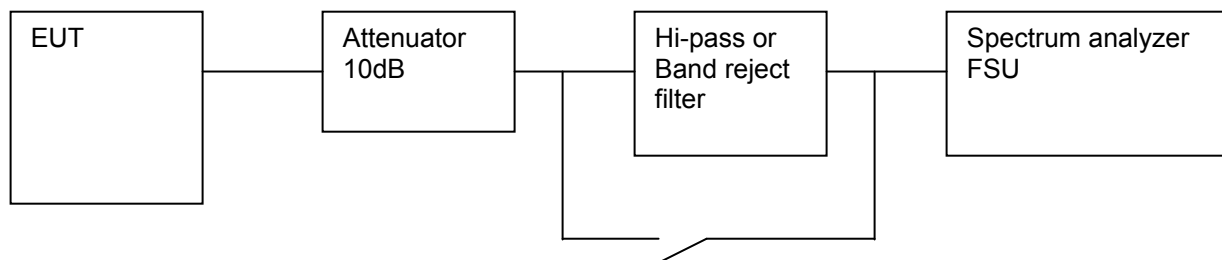

5.5.4. Test Data

Plot 5.5.4.1. Spurious Emissions at Antenna Terminal, 470.250 MHz, High Power, Audio Input 15 kHz 1 Vrms
30 MHz - 800 MHz

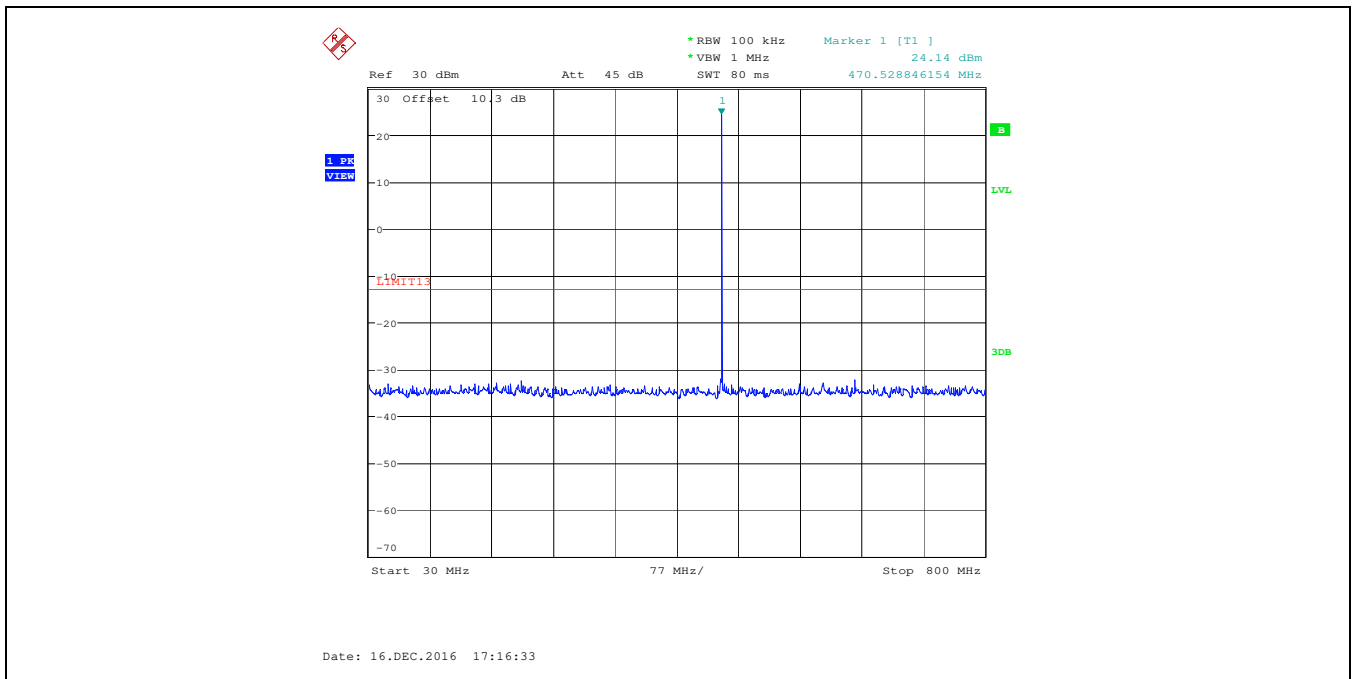

Plot 5.5.4.2. Spurious Emissions at Antenna Terminal, 470.250 MHz, High Power, Audio Input 15 kHz 1 Vrms
800 MHz - 1 GHz

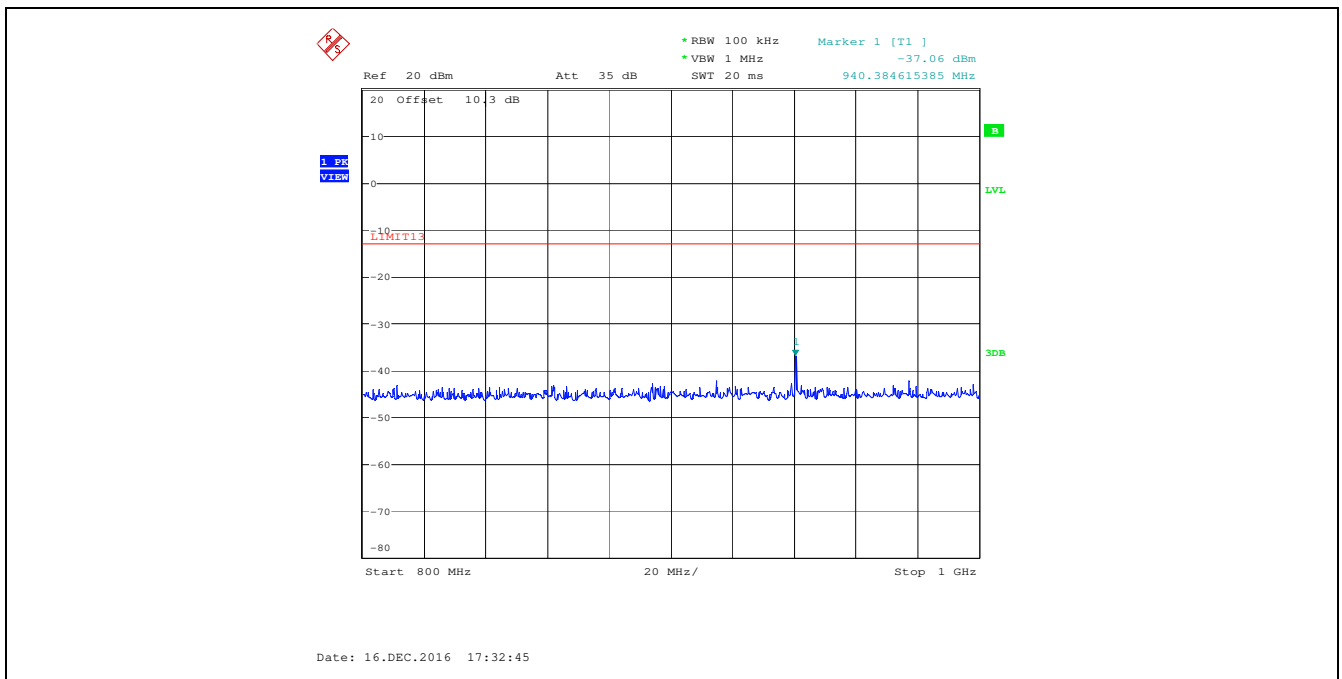

Plot 5.5.4.3. Spurious Emissions at Antenna Terminal, 470.250 MHz, High Power, Audio Input 15 kHz 1 Vrms
1 GHz - 7 GHz

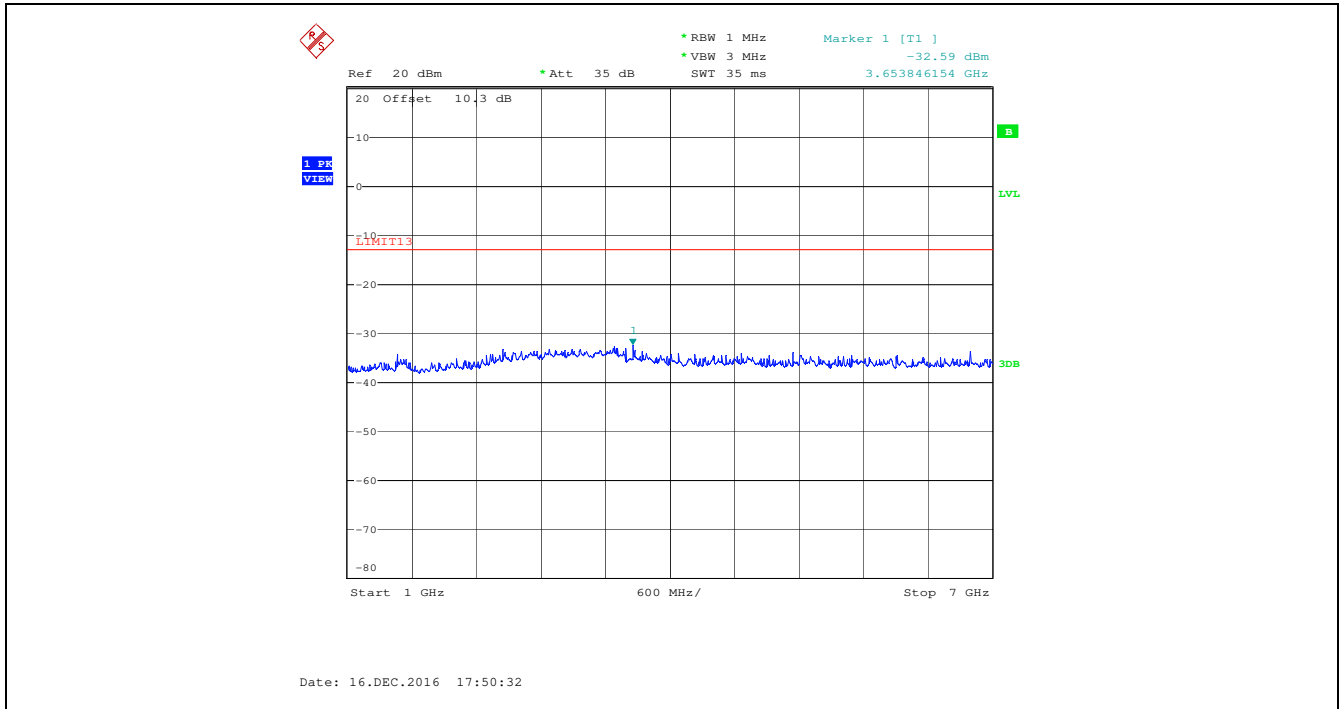

Plot 5.5.4.4. Spurious Emissions at Antenna Terminal, 470.250 MHz, Low Power, Audio Input 15 kHz 1 Vrms
30 MHz - 800 MHz

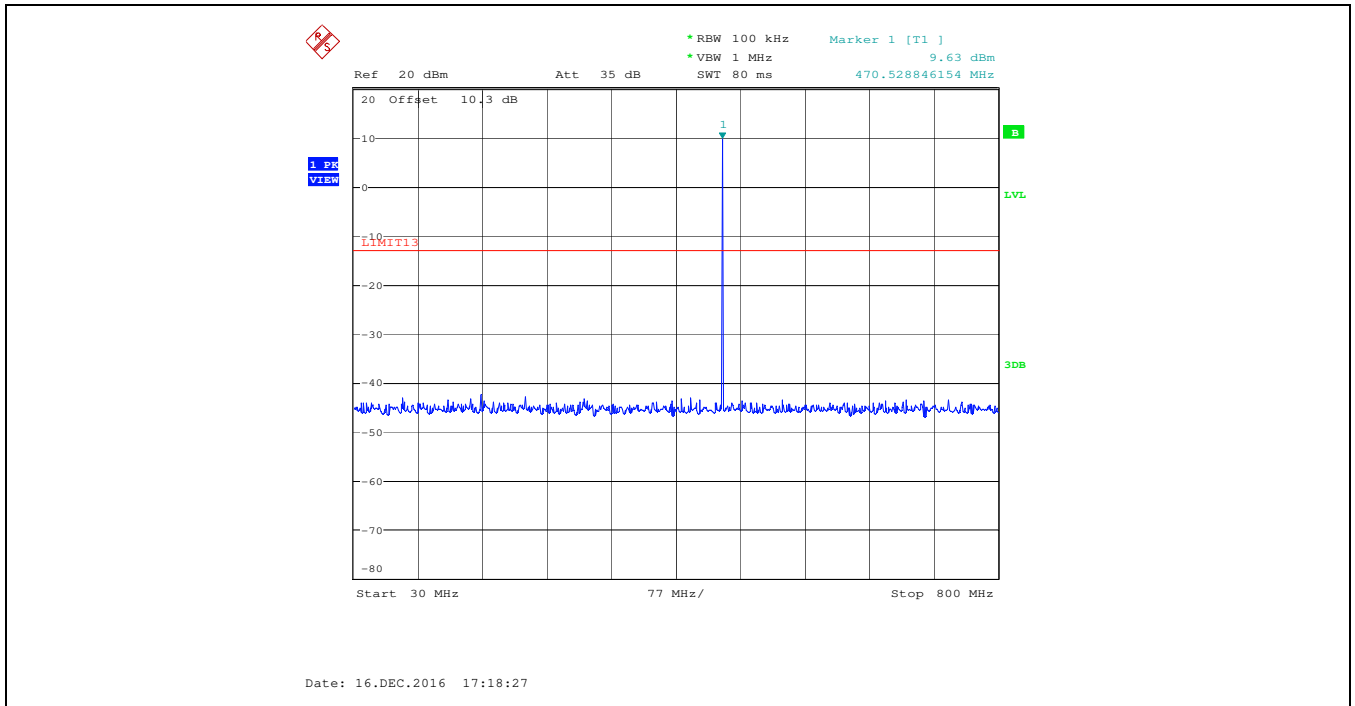

ULTRATECH GROUP OF LABS

3000 Bristol Circle, Oakville, Ontario, Canada L6H 6G4
Tel. #: 905-829-1570, Fax. #: 905-829-8050, Email: vic@ultratech-labs.com, Website: <http://www.ultratech-labs.com>

File #: 18Q5X047_FCC74H1

February 28, 2018

All test results contained in this engineering test report are traceable to National Institute of Standards and Technology (NIST)

Plot 5.5.4.5. Spurious Emissions at Antenna Terminal, 470.250 MHz, Low Power, Audio Input 15 kHz 1 Vrms
800 MHz - 1 GHz

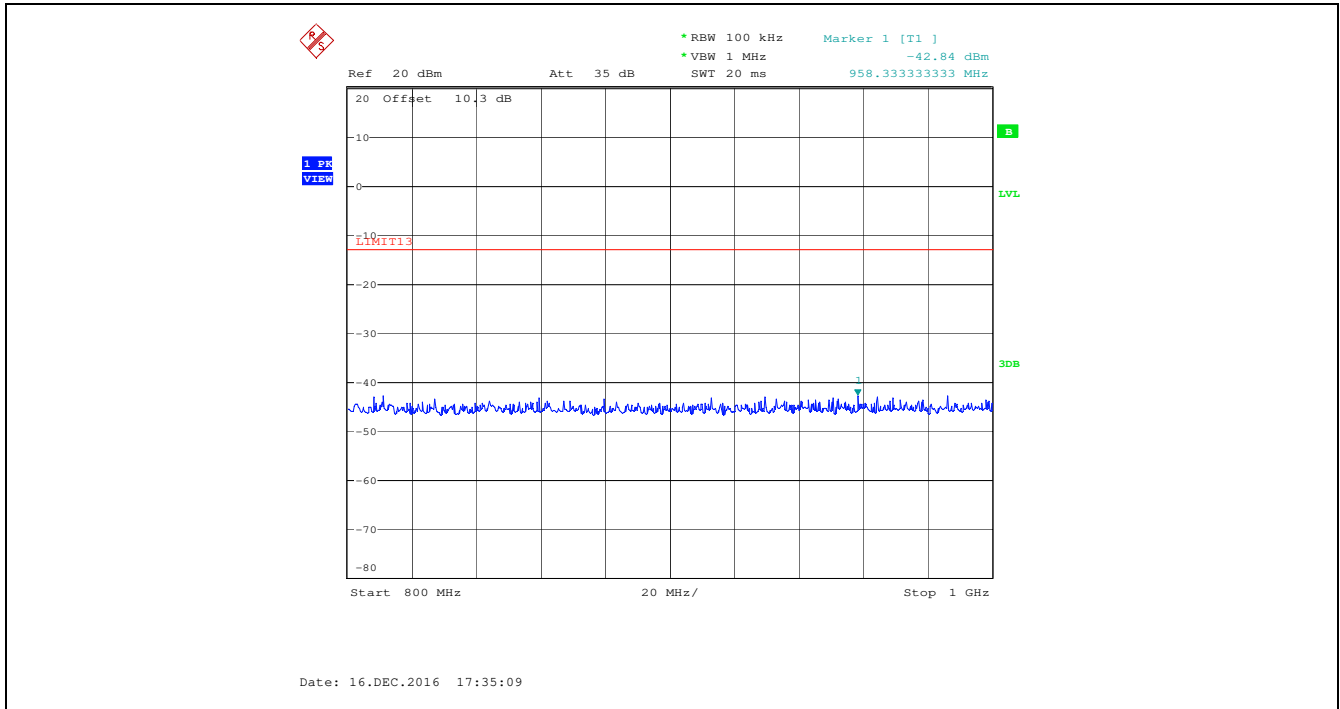

Plot 5.5.4.6. Spurious Emissions at Antenna Terminal, 470.250 MHz, Low Power, Audio Input 15 kHz 1 Vrms
1 GHz - 7 GHz

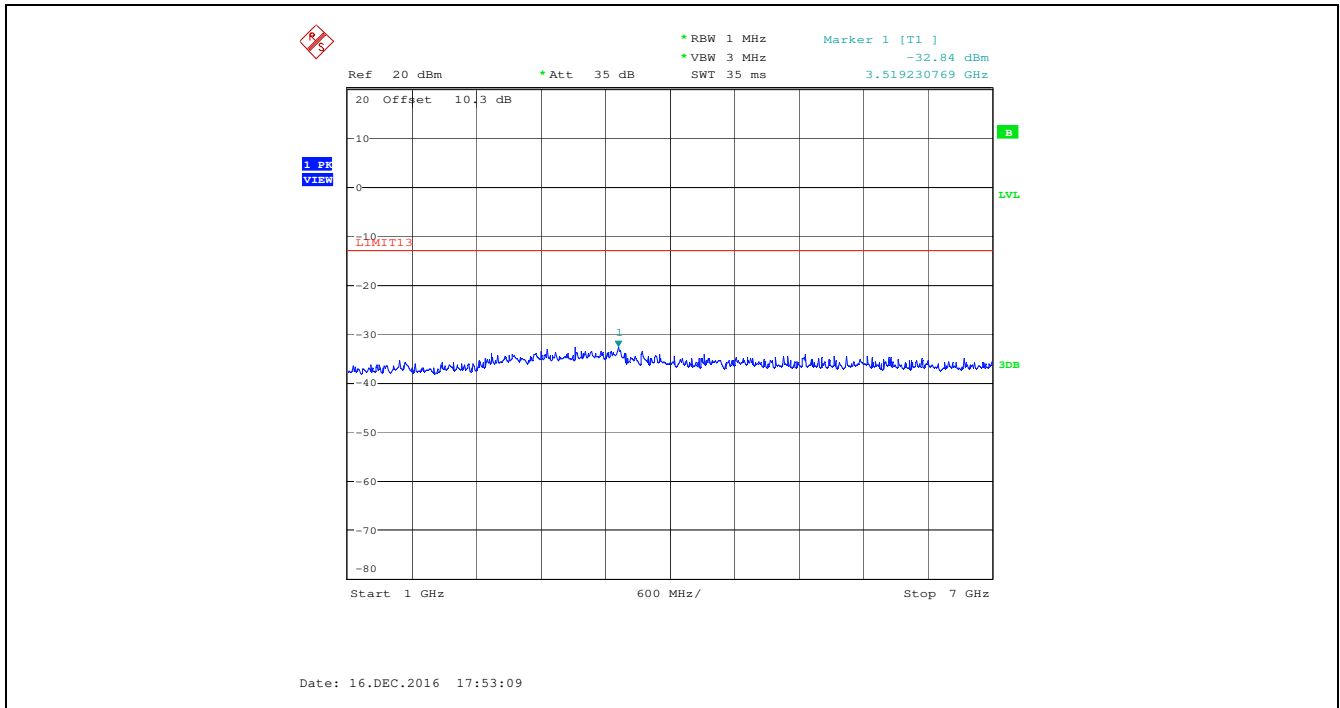

Plot 5.5.4.7. Spurious Emissions at Antenna Terminal, 510.000 MHz, High Power, Audio Input 15 kHz 1 Vrms
30 MHz - 800 MHz

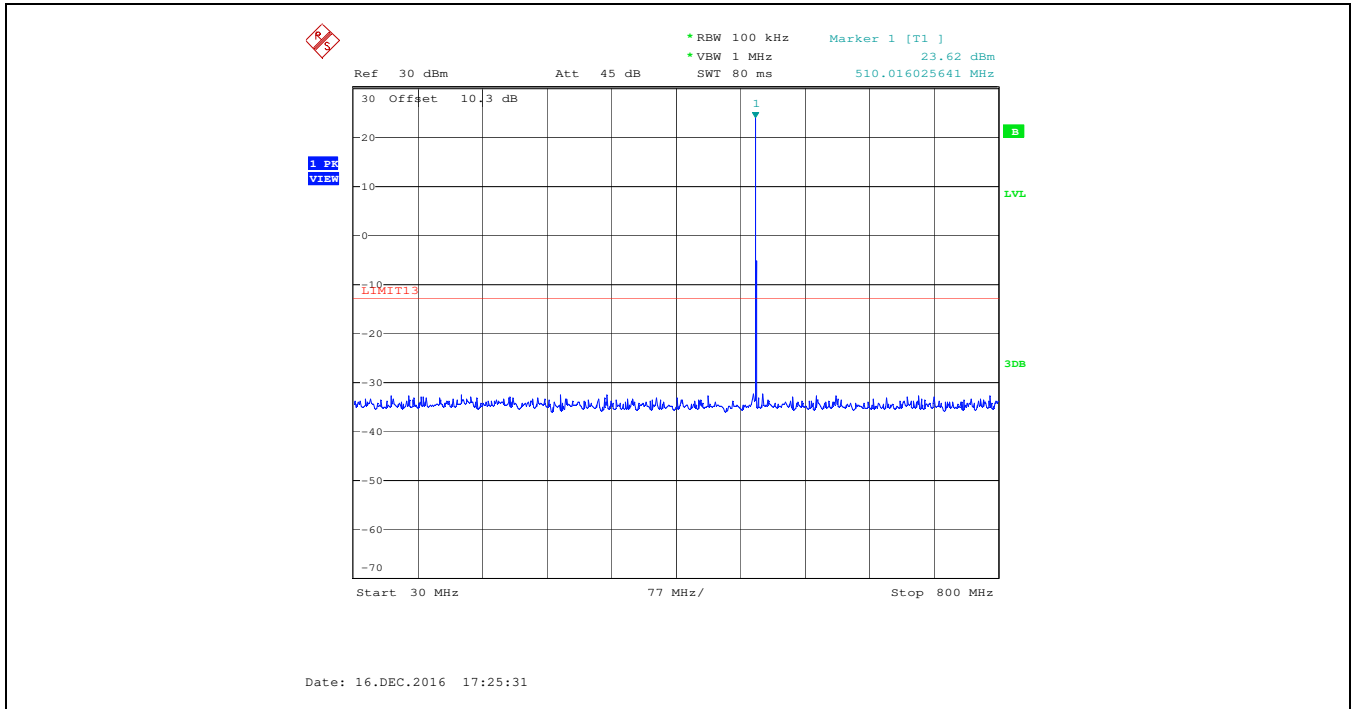

Plot 5.5.4.8. Spurious Emissions at Antenna Terminal, 510.000 MHz, High Power, Audio Input 15 kHz 1 Vrms
800 MHz - 1 GHz

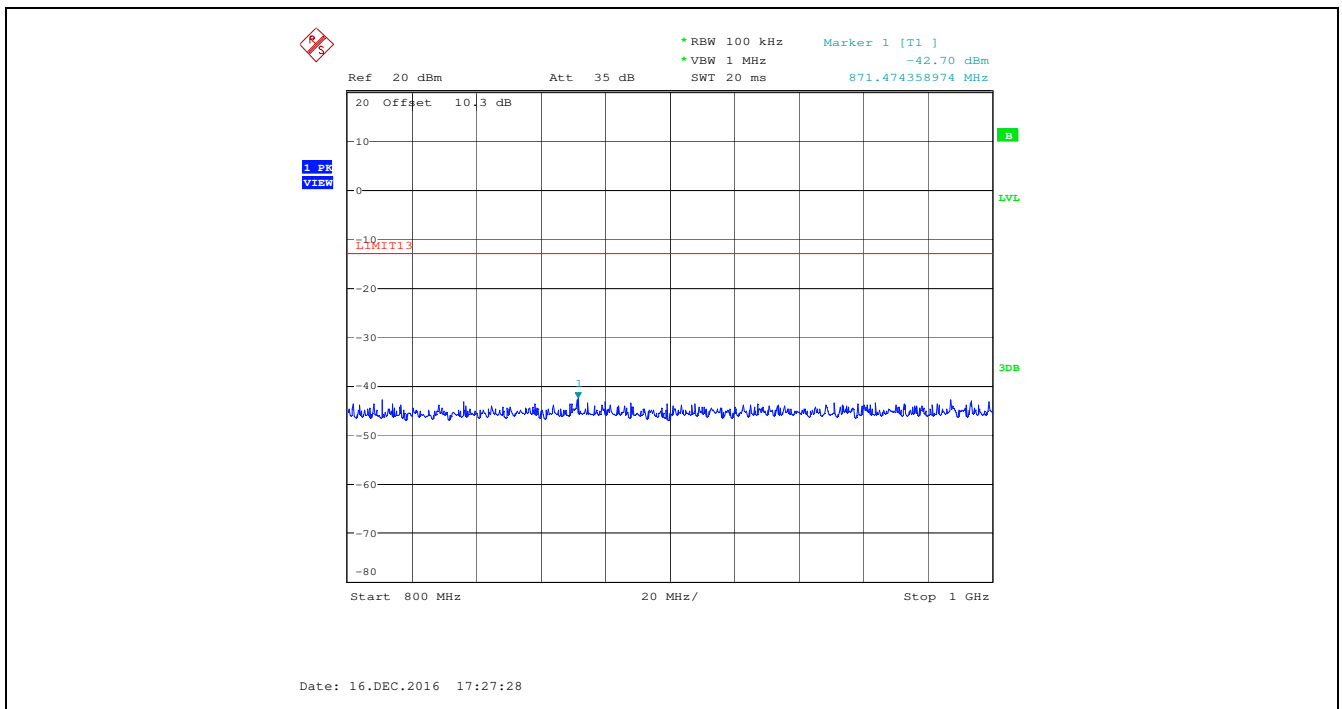

Plot 5.5.4.9. Spurious Emissions at Antenna Terminal, 510.000 MHz, High Power, Audio Input 15 kHz 1 Vrms
1 GHz - 7 GHz

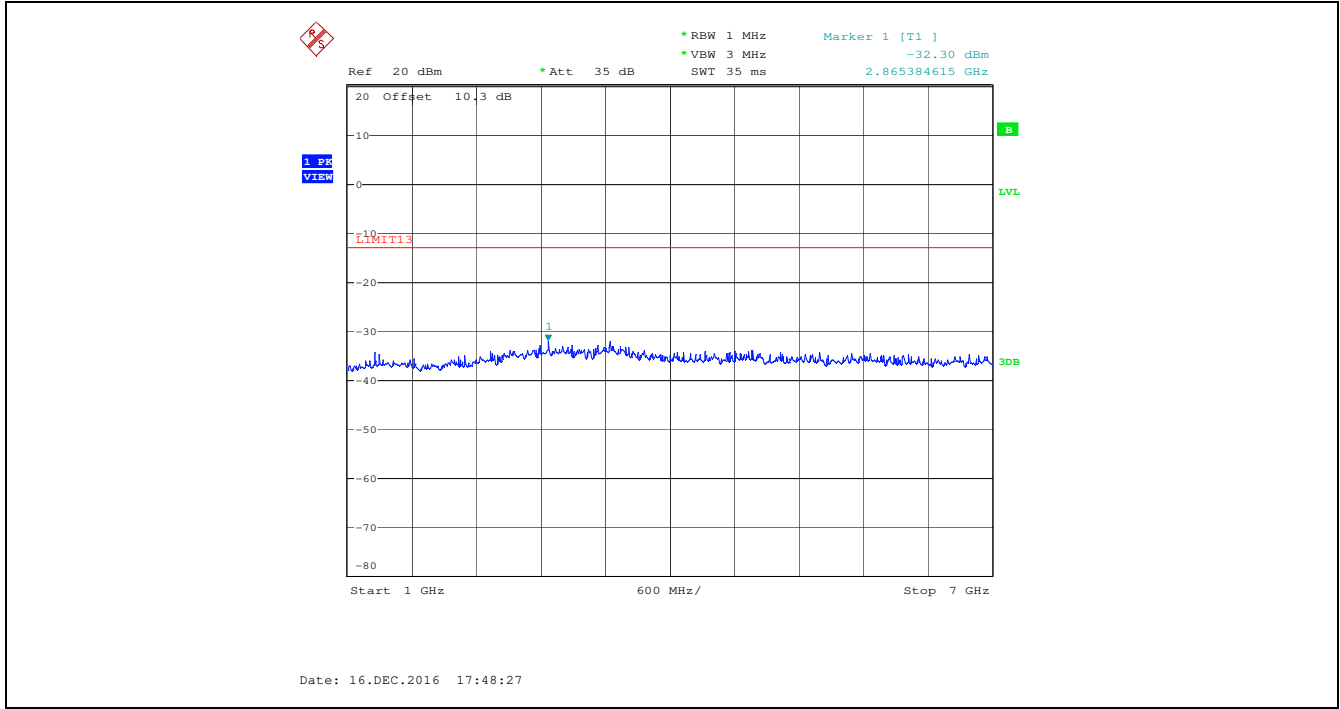

Plot 5.5.4.10. Spurious Emissions at Antenna Terminal, 510.000 MHz, Low Power, Audio Input 15 kHz 1 Vrms
30 MHz - 800 MHz

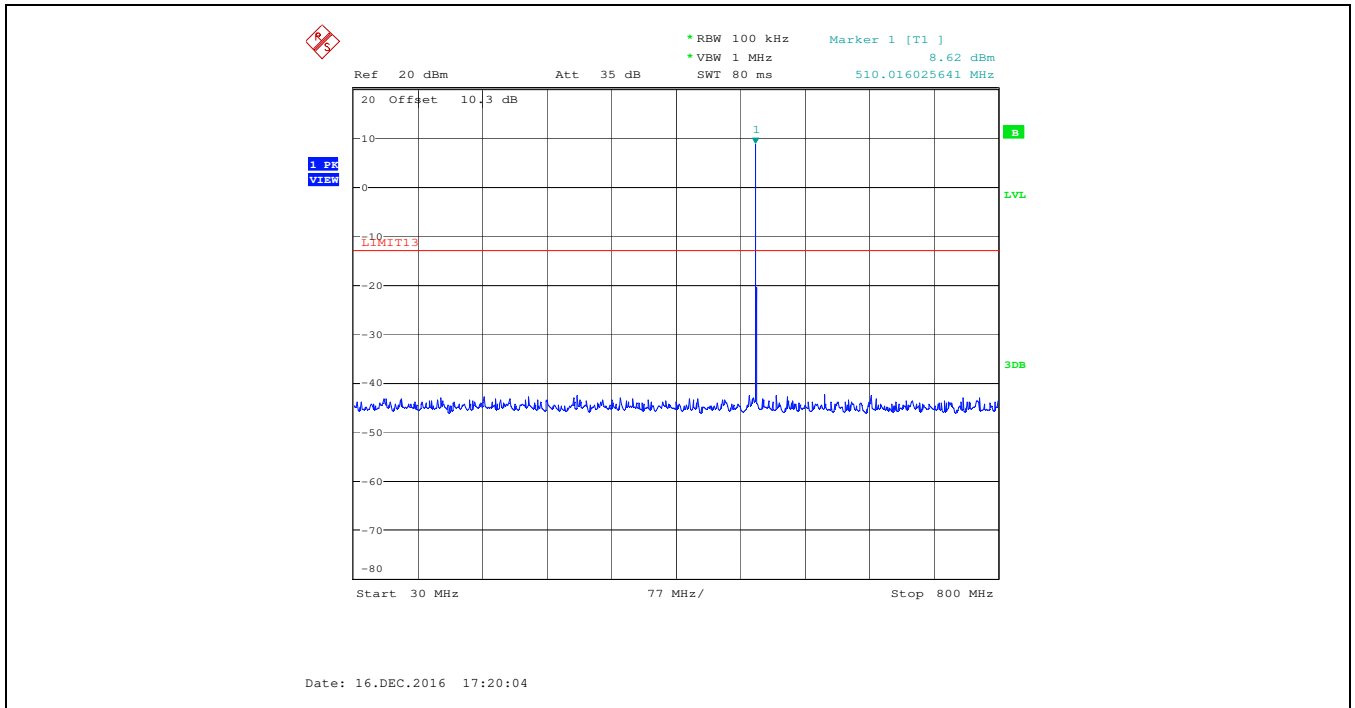

Plot 5.5.4.11. Spurious Emissions at Antenna Terminal, 510.000 MHz, Low Power, Audio Input 15 kHz 1 Vrms
800 MHz - 1 GHz

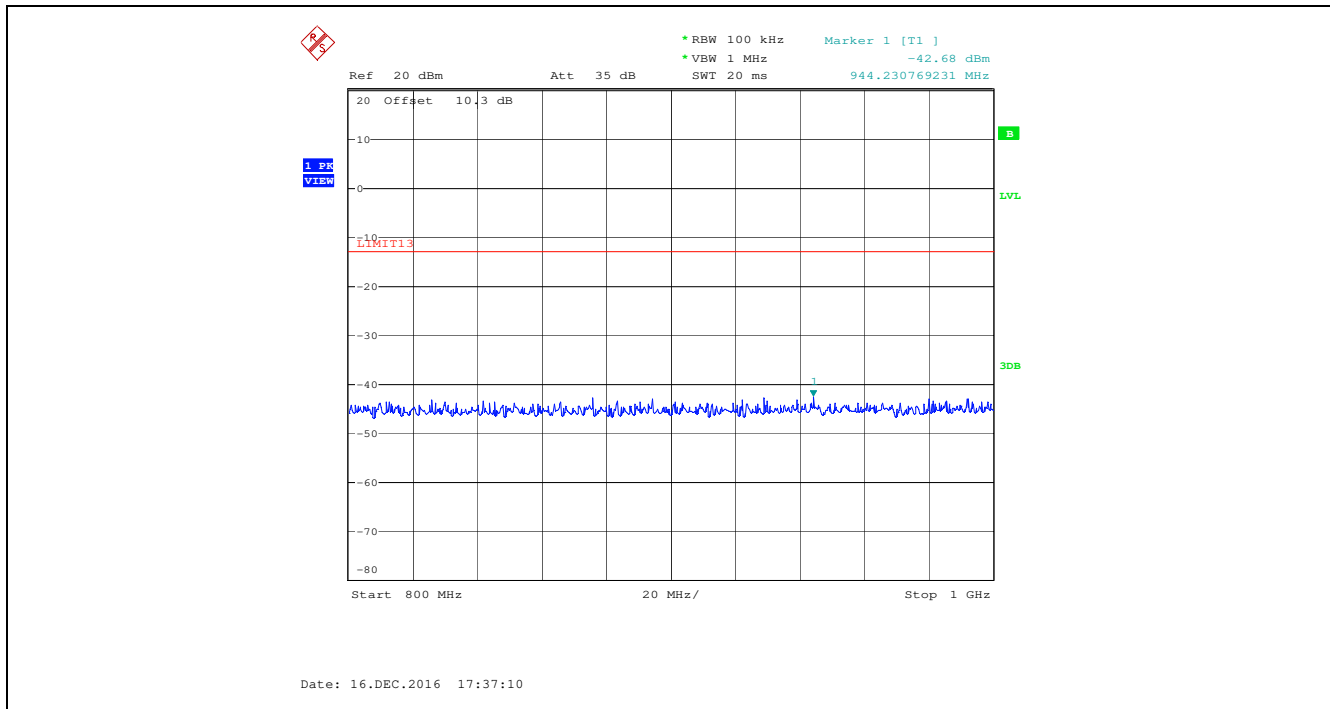

Plot 5.5.4.12. Spurious Emissions at Antenna Terminal, 510.000 MHz, Low Power, Audio Input 15 kHz 1 Vrms
1 GHz - 7 GHz

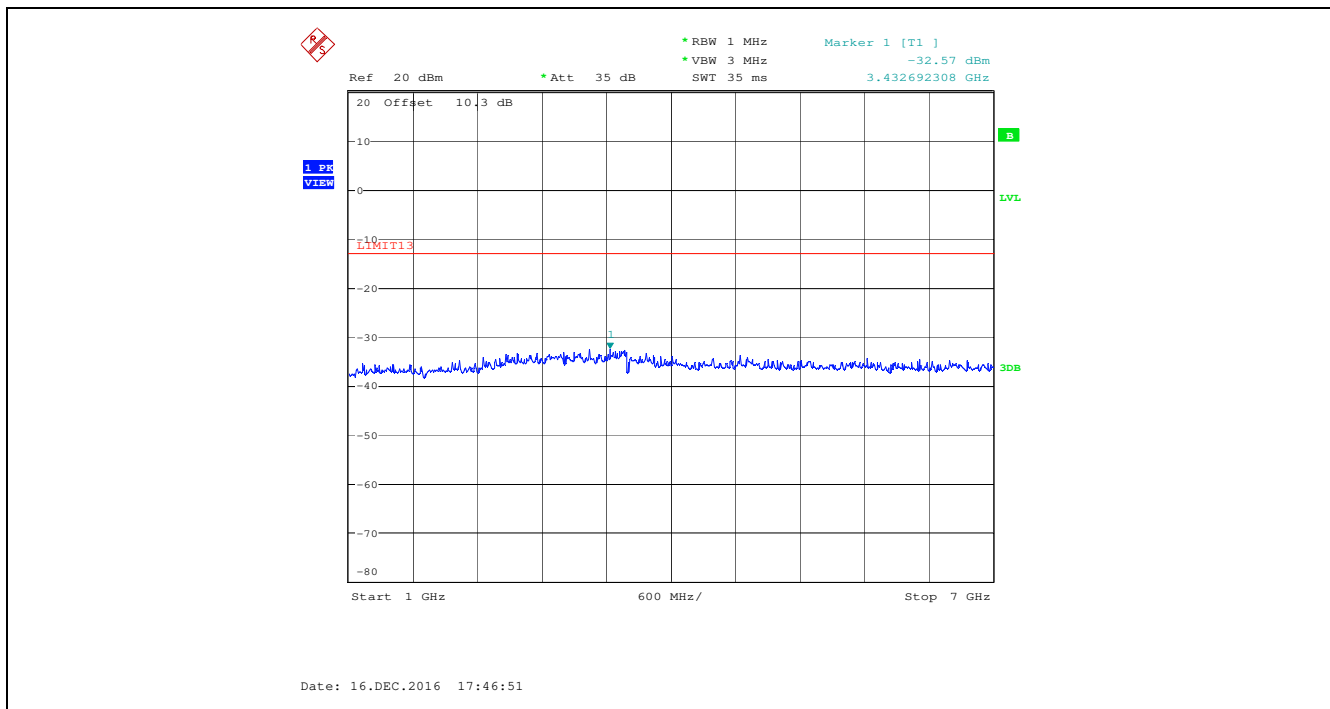

Plot 5.5.4.13. Spurious Emissions at Antenna Terminal, 550.000 MHz, High Power, Audio Input 15 kHz 1 Vrms
30 MHz - 800 MHz

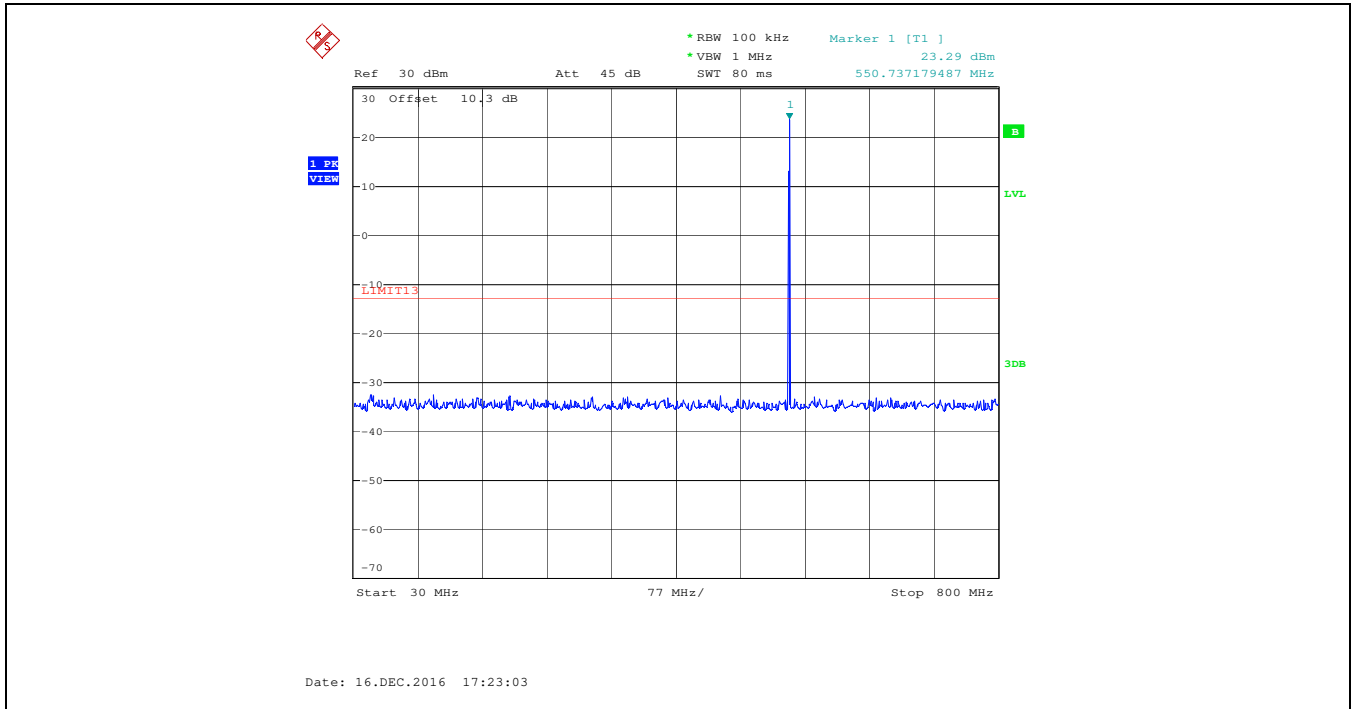

Plot 5.5.4.14. Spurious Emissions at Antenna Terminal, 550.000 MHz, High Power, Audio Input 15 kHz 1 Vrms
800 MHz - 1 GHz

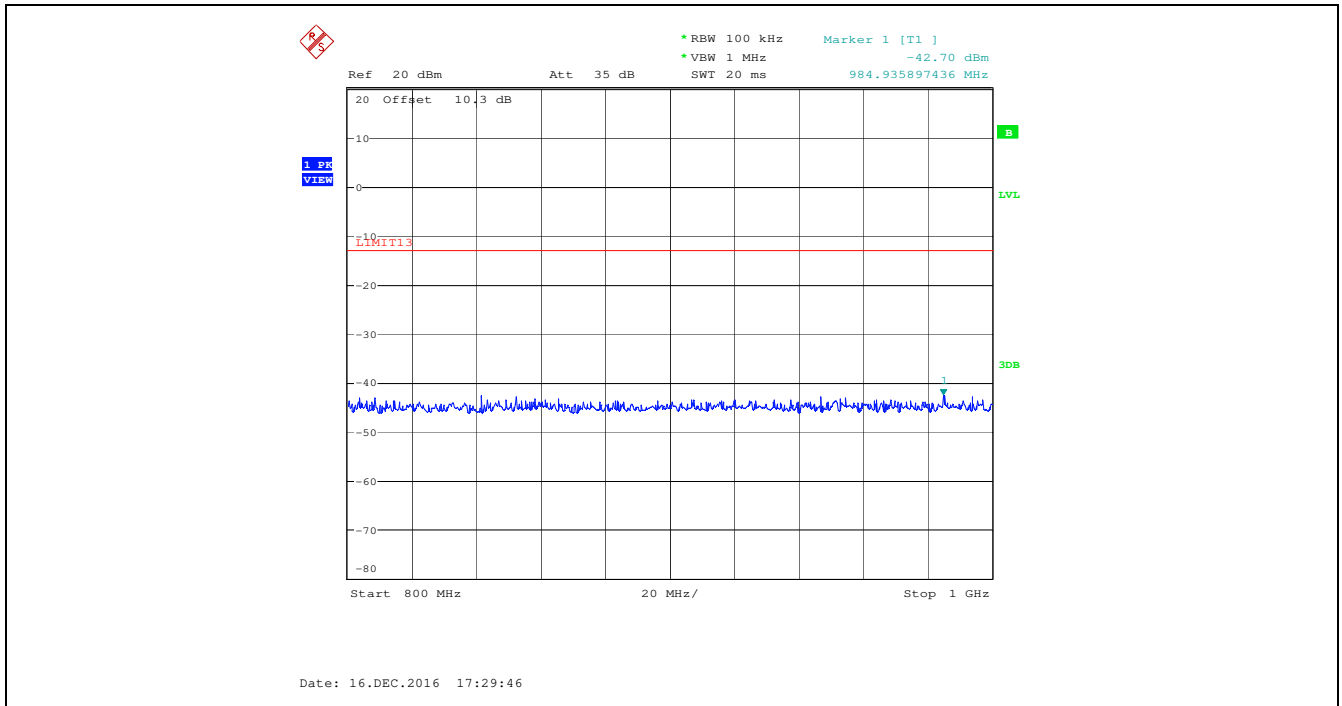

Plot 5.5.4.15. Spurious Emissions at Antenna Terminal, 550.000 MHz, High Power, Audio Input 15 kHz 1 Vrms
1 GHz - 7 GHz

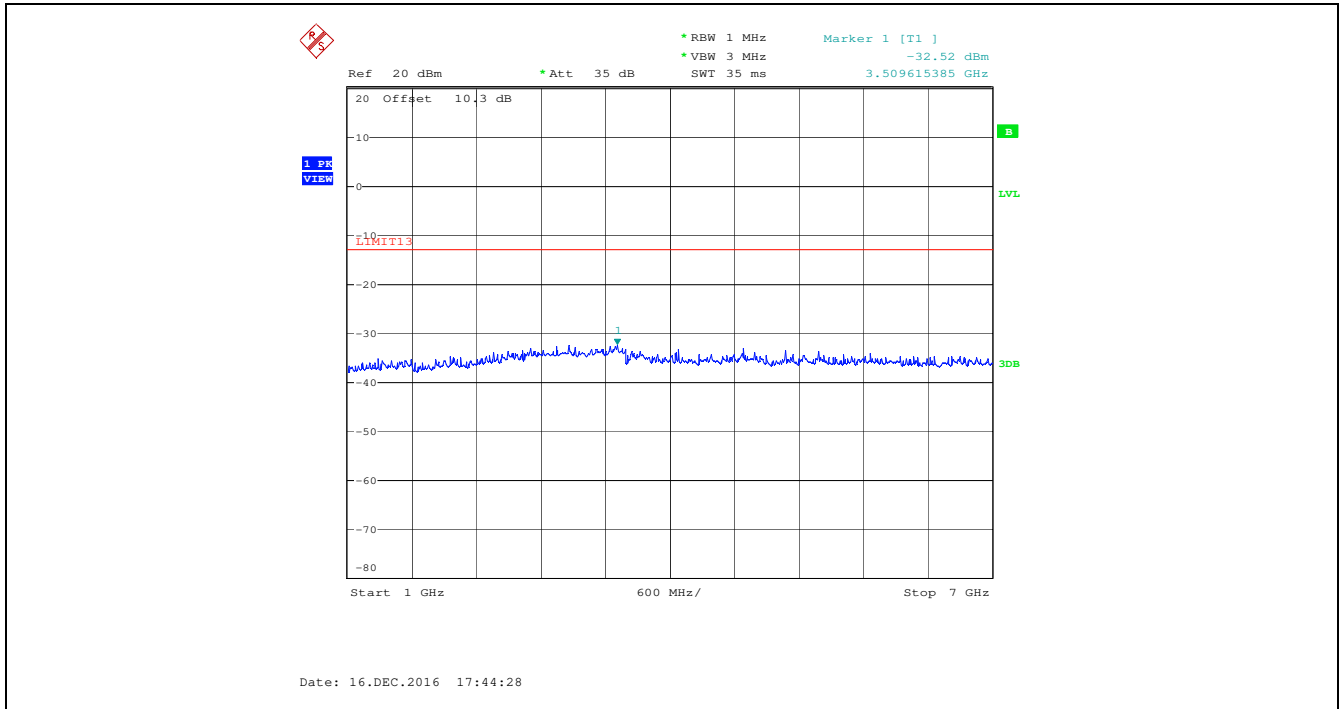

Plot 5.5.4.16. Spurious Emissions at Antenna Terminal, 550.000 MHz, Low Power, Audio Input 15 kHz 1 Vrms
30 MHz - 800 MHz

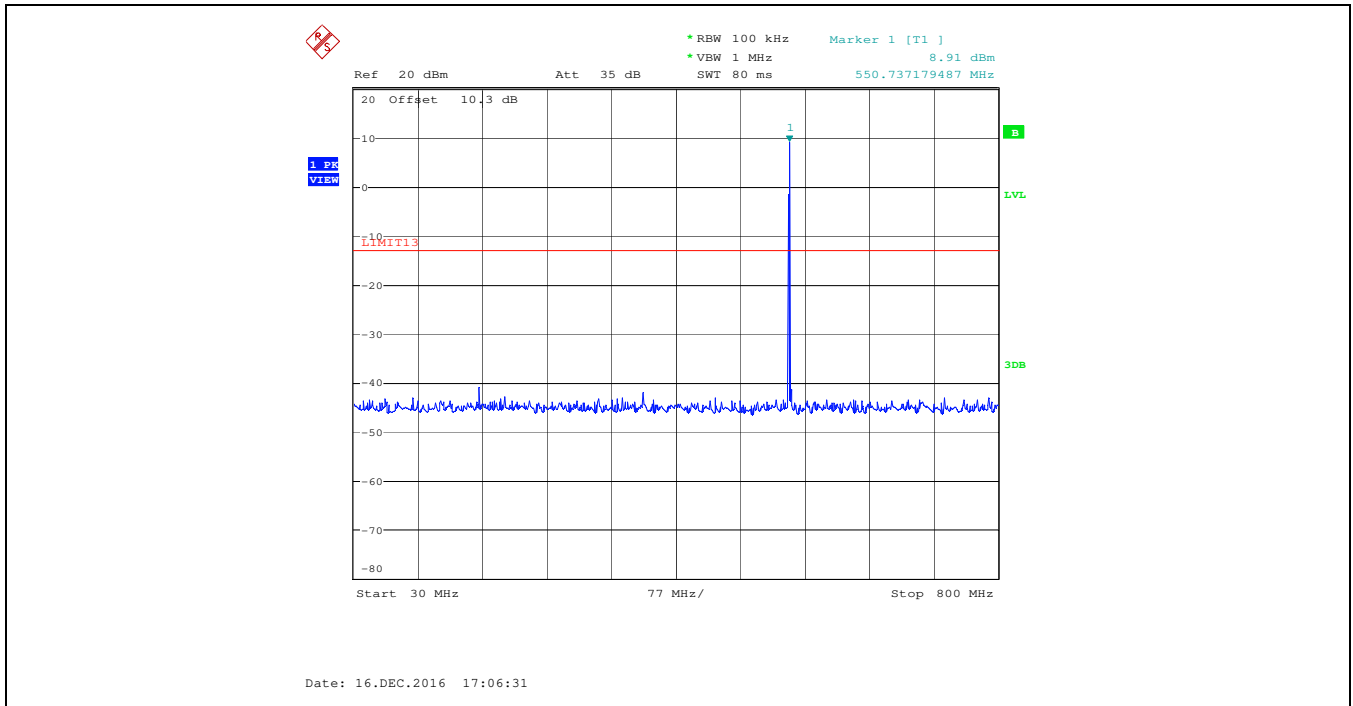

Plot 5.5.4.17. Spurious Emissions at Antenna Terminal, 550.000 MHz, Low Power, Audio Input 15 kHz 1 Vrms
800 MHz - 1 GHz

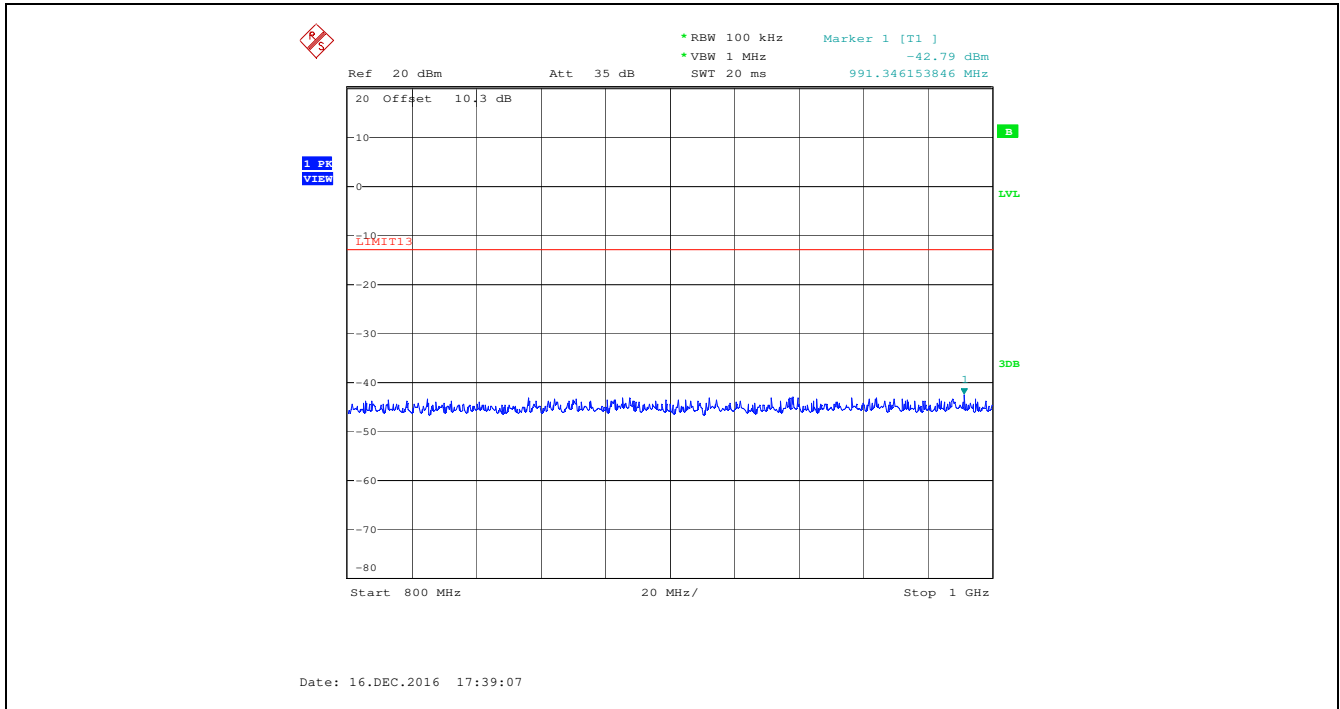

Plot 5.5.4.18. Spurious Emissions at Antenna Terminal, 550.000 MHz, Low Power, Audio Input 15 kHz 1 Vrms
1 GHz - 7 GHz

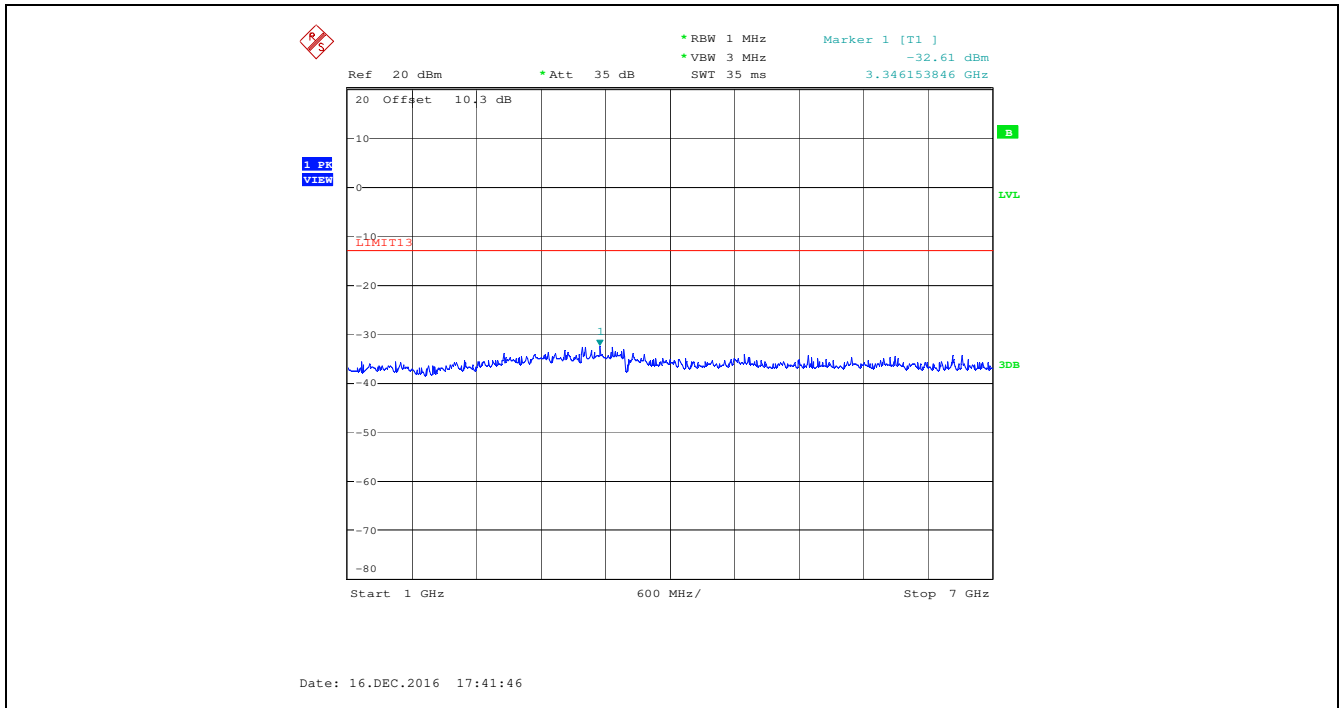

5.6. FIELD STRENGTH OF SPURIOUS RADIATION [§§ 2.1053, 2.1057 & 74.861(e)(6)]

5.6.1. Limit(s)

Emissions shall be attenuated below the mean output power of the transmitter as follows:

FCC Rules	Attenuation Limit (dBc)
§ 74.861(e)(6)	At least $43 + 10\log_{10}$ (mean power in watts) dB

5.6.2. Method of Measurements

ANSI C63.26-2015 Clause 5.5 and/or TIA-603-E, Clause 2.2.12

5.6.3. Test Arrangement

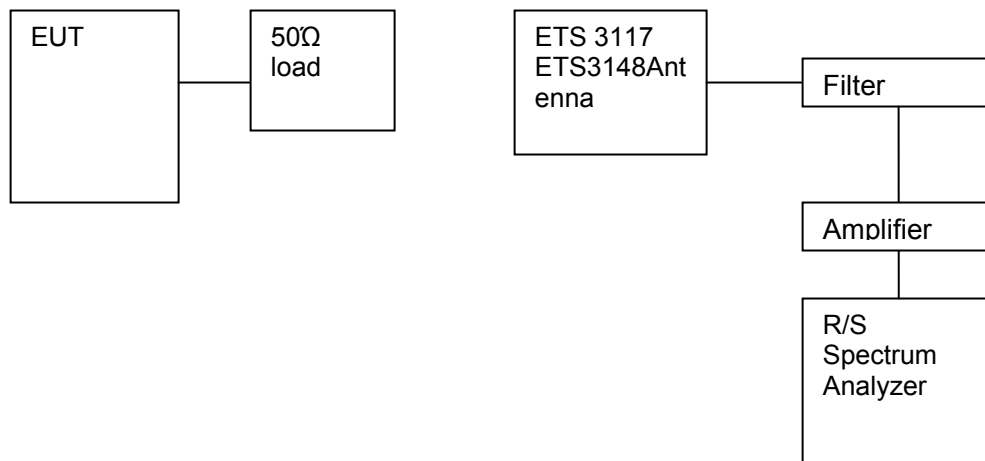

5.6.4. Test Data

Remarks:

- The radiated emissions were performed with high power setting at 3 m distance to represents the worst-case test configuration.
- The emissions were scanned from 30 MHz to 10th harmonics); all spurious emissions that are in excess of 20dB below the specified limit shall be recorded.
- EUT shall be tested in three orthogonal positions.

5.6.4.1. Near Low End Range Of Operation (470.250 MHz)

Test Frequency (MHz):		470.250				
Power_{conducted} (W):		0.23768				
Limit (dBm):		-13				
Frequency (MHz)	E-Field (dBμV/m)	EMI Detector (Peak/QP)	Antenna Polarization (H/V)	Measured ERP (dBm)	Limit (dBm)	Margin (dB)
30 - 7000	*	Peak	H/V	*	-13	*
* Spurious emissions are more than 20dB below the specified limit.						

5.6.4.2. Near Middle Range Of Operation (510.000 MHz)

Test Frequency (MHz):		510.000				
Power_{conducted} (W):		0.21827				
Limit (dBm):		-13				
Frequency (MHz)	E-Field (dBμV/m)	EMI Detector (Peak/QP)	Antenna Polarization (H/V)	Measured ERP (dBm)	Limit (dBm)	Margin (dB)
30 - 7000	*	Peak	H/V	*	-13	*
* Spurious emissions are more than 20dB below the specified limit.						

5.6.4.3. Near High End Range Of Operation (550.000 MHz)

Test Frequency (MHz):		550.000				
Power_{conducted} (W):		0.19588				
Limit (dBm):		-13				
Frequency (MHz)	E-Field (dBμV/m)	EMI Detector (Peak/QP)	Antenna Polarization (H/V)	Measured ERP (dBm)	Limit (dBm)	Margin (dB)
30 - 7000	*	Peak	H/V	*	-13	*
* Spurious emissions are more than 20dB below the specified limit.						

5.7. FREQUENCY STABILITY [§§ 2.1055 & 74.861(e)(4)]

5.7.1. Limit(s)

§74.861(e)(4) The frequency tolerance of the transmitter shall be 0.005 percent.

5.7.2. Method of Measurements

ANSI C63.26-2015 Section 5.6 and 47 CFR §2.1055

5.7.3. Test Arrangement

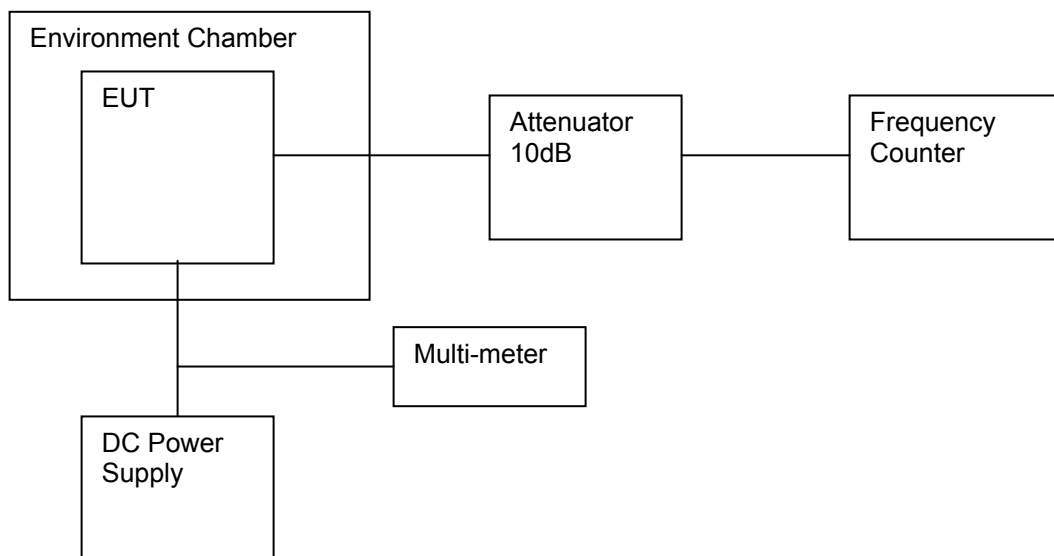

5.7.4. Test Data

Test Frequency:	470.250 MHz		
Full Power Level:	23.76 dBm		
Frequency Tolerance Limit:	50 ppm or 23513 Hz		
Max. Frequency Tolerance Measured:	+317 Hz or 0.67 ppm		
Input Voltage Rating:	3.7 VDC (Nominal)		
Ambient Temperature (°C)	Frequency Drift (Hz)		
	Supply Voltage (Nominal) 3.7 VDC	Supply Voltage (Battery End Point) 3.3 VDC	Supply Voltage (Battery Fully Charged) 4.26 VDC
-30	+317	--	--
-20	-161	--	--
-10	-147	--	--
0	-94	--	--
10	+48	--	--
20	+39	-37	+28
30	-77	--	--
40	-131	--	--
50	-204	--	--

5.8. RF EXPOSURE REQUIRMENTS [§§ 15.247(i), 1.1310 & 2.1091]

5.8.1. Limits

§ 1.1310: The criteria listed in the following table shall be used to evaluate the environmental impact of human exposure to radio-frequency (RF) radiation as specified in 1.1307(b).

Limits for Maximum Permissible Exposure (MPE)

Frequency range (MHz)	Electric field strength (V/m)	Magnetic field strength (A/m)	Power density (mW/cm ²)	Averaging time (minutes)
(A) Limits for Occupational/Controlled Exposures				
0.3-3.0	614	1.63	*(100)	6
3.0-30	1842/f	4.89/f	*(900/f ²)	6
30-300	61.4	0.163	1.0	6
300-1500			f/300	6
1500-100,000			5	6
(B) Limits for General Population/Uncontrolled Exposure				
0.3-1.34	614	1.63	*(100)	30
1.34-30	824/f	2.19/f	*(180/f ²)	30
30-300	27.5	0.073	0.2	30
300-1500			f/1500	30
1500-100,000			1.0	30

f = frequency in MHz

* = Plane-wave equivalent power density

Note 1: Occupational/controlled limits apply in situations in which persons are exposed as a consequence of their employment provided those persons are fully aware of the potential for exposure and can exercise control over their exposure. Limits for occupational/controlled exposure also apply in situations when an individual is transient through a location where occupational/controlled limits apply provided he or she is made aware of the potential for exposure.

Note 2: General population/uncontrolled exposures apply in situations in which the general public may be exposed, or in which persons that are exposed as a consequence of their employment may not be fully aware of the potential for exposure or can not exercise control over their exposure.

5.8.2. Method of Measurements

Calculation Method of Power Density/RF Safety Distance:

$$S = \frac{PG}{4\pi \cdot r^2} = \frac{EIRP}{4\pi \cdot r^2}$$

Where,
 P: power input to the antenna in mW
 EIRP: Equivalent (effective) isotropic radiated power.
 S: power density mW/cm²
 G: numeric gain of antenna relative to isotropic radiator
 r: distance to centre of radiation in cm

5.8.3. RF Evaluation for Mobile Applications

Pursuant to FCC KDB 447498 D01 General RF Exposure Guidance v06, Section 7.2:

Simultaneous transmission MPE test exclusion applies when the sum of the MPE ratios for all simultaneously transmitting antennas incorporated in a host device is ≤ 1.0, according to calculated/estimated, numerically modeled, or measured field strengths or power density.

The following table addresses the co-location of the EUT dual band operation.

EUT Co-located MPE for Dual Band Operation at an Evaluation Distance of 20cm										
Frequency Band (MHz)	Frequency	Conducted Output Power (mW)	Conducted Output Power (dBm)	Antenna Gain (dBi)	Max EUT EIRP (dBm)	Averaged Max EUT EIRP (mW)	Evaluation Distance (cm)	Power Density (mW/cm ²)	Power Density FCC Limit (mW/cm ²)	FCC Power Density MPE Ratio
2405-2480	2405.0	--	17.85	3	20.85	121.62	20	0.024	1.000	0.024
470.250 - 550.000	470.250	250	23.98	3	26.98	498.88	20	0.099	0.314	0.317
Worst case sum of the MPE ratios for all simultaneously transmitting antennas:										0.341

5.8.4. RF Evaluation for Portable Applications

For portable applications, refer to SAR test report for portable host products with the module integrated.

EXHIBIT 6. TEST EQUIPMENT LIST

Test Instruments	Manufacturer	Model No.	Serial No.	Operating Range	Cal. Due Date
Spectrum Analyzer	R/S	Fsu	100398	20Hz – 40 GHz	14 Sep 2017
Attenuator	Mini-Circuits	VAT-10	---	DC–6 GHz	See Note 1
High Pass Filter	Mini Circuit	SHP 800	---	Cut off 800 MHz	See Note 1
Power Meter	Hewlett Packard	436A	2015A07747	100kHz--50G sensor dependent	08 Mar 2018
Power Sensor	Hewlett Packard	8481A	1550A15143	10MHz-18GHZ	30 Sep 2018
Modulation Analyzer	Hewlett Packard	8901B	3226A04606	150kHz-1300MHz	08 Mar 2018
Combiner	Mini Circuit	ZFSC-3-4	15542	1MHz - 1GHz	See Note 1
RF Detector	Pasternack	PE8000-50	---	10MHz--1GHz	See Note 1
Environmental Chamber	Envirotronics	SSH32C	11994847-S-11059	-60 to 177 °C	02 Jun 2018
RF Synthesized signal Generator	HP	8648C	3343U00391	100kHz-3200MHz AM/ FM/ PM	18 Mar 2018
Power supply	Tenma	72-7295	490300297	1-40V DC 5A	See Note 1
FFT Digital Spectrum Analyzer	Advantest	R9211E	8202336	10mHz—100kHz	13 Sep 2018
RF Communication Test Set	Hewlett Packard	8920B	US39064699	30MHz-1GHz	08 Mar 2018
Horn antenna	ETS-LINDGREN	3117	119425	1-18GHz	17 Jun 2017*
Preamplifier	Hewlett Packard	8449B	3008A00769	1-26.5GHz	01 May 2018
Attenuator	Aeroflex/Weinschel	23-20-34	BH7876	DC-18 GHz	See Note 1
Antenna	ETS	3148	1101	200-2000 MHz	20 Jul 2018
Attenuator	Aeroflex/Weinschel	24-20-34	BJ2364	DC-18 GHz	See Note 1
Frequency counter	HP	5352	3049A04423	10Hz-40 GHz	05 May 2018
Infinium Digital Oscilloscope	Hewlett-Packard	54801A	US38380192	DC--500MHz 1G sampling	10 Aug 2017
High Pass Filter	Mini Circuit	SHP 600	---	Cut off 600 MHz	See Note 1
Audio filter	Kaohn-Hite	3200 Filter	567	Variable audio filter	13 May 2019
15MHz function generator	HP	33120A	US34011688	15 MHz Function waveform generator	18 May 2017*
Multi-meter	Tenma	726202	02080027	DC-1000V DC	25 Nov 2017

Note 1: Internal Verification/Calibration check

* Equipment used before calibration due date.

ULTRATECH GROUP OF LABS

3000 Bristol Circle, Oakville, Ontario, Canada L6H 6G4
 Tel. #: 905-829-1570, Fax. #: 905-829-8050, Email: vic@ultratech-labs.com, Website: <http://www.ultratech-labs.com>

File #: 18Q5X047_FCC74H1

February 28, 2018

All test results contained in this engineering test report are traceable to National Institute of Standards and Technology (NIST)

EXHIBIT 7. MEASUREMENT UNCERTAINTY

The measurement uncertainties stated were calculated in accordance with the requirements of CISPR 16-4-2 @ IEC:2003 and JCGM 100:2008 (GUM 1995) – Guide to the Expression of Uncertainty in Measurement.

7.1. RADIATED EMISSION MEASUREMENT UNCERTAINTY

	Radiated Emission Measurement Uncertainty @ 3m, Horizontal (30-1000 MHz):	Measured	Limit
u_c	Combined standard uncertainty: $u_c(y) = \sqrt{\sum_{i=1}^m u_i^2(y)}$	± 2.15	± 2.6
U	Expanded uncertainty U: $U = 2u_c(y)$	± 4.30	± 5.2

	Radiated Emission Measurement Uncertainty @ 3m, Vertical (30-1000 MHz):	Measured	Limit
u_c	Combined standard uncertainty: $u_c(y) = \sqrt{\sum_{i=1}^m u_i^2(y)}$	± 2.39	± 2.6
U	Expanded uncertainty U: $U = 2u_c(y)$	± 4.78	± 5.2

	Radiated Emission Measurement Uncertainty @ 3 m, Horizontal & Vertical (1 – 18 GHz):	Measured	Limit
u_c	Combined standard uncertainty: $u_c(y) = \sqrt{\sum_{i=1}^m u_i^2(y)}$	± 1.87	Under consideration
U	Expanded uncertainty U: $U = 2u_c(y)$	± 3.75	Under consideration