

A decorative horizontal bar chart composed of vertical bars of varying heights and colors (gray, light blue, and medium blue) arranged in a pattern that frames the central text.

# INSTRUCTION MANUAL

**Trunked POC Portable Radio**

<http://en.kirisun.com>

## **Instruction Manual Trunked POC Portable Radio**

**We are very grateful for your purchasing Kirisun brand two-way radio produced by Kirisun Communications Co., Ltd.**

**We believe Kirisun two-way radio, which always incorporates the latest technology, can bring great convenience to your life and work. We also believe that the quality and function of Kirisun two-way radio can meet your demands for reliable communication.**



## Contents

Safety .....	2
Regulatory .....	7
Caring for your product .....	8
Connectors, controls, buttons and keys.....	9
Keys, buttons and knobs overview .....	11
LED status indicator.....	12
Battery information .....	13
Accessory information.....	17
Basic operation .....	20
Technical specifications .....	24

## **Safety**

Read these safety instructions carefully.

It is the responsibility of the person operating the product to ensure that it is operated safely at all times, and that local laws and regulations governing the usage of Radio Frequency (RF) products are observed. Obey all signs and instructions relating to the usage to RF wireless devices

It is recommended that you obtain training on how to safely operate this product. Your personal safety could be affected if you do not understand how to operate this product correctly.

This product must not be operated in environments that exceed those listed in the product technical datasheet and in the Regulatory section of the product user guide.

Unauthorised modifications to the product could cause the product to become non-operational. Always use Kirisun approved antenna, battery and accessories with this product.

### **Exposure to RF energy**

Kirisun designs and manufactures products to meet strict guidelines and international standards relating to Radio Frequency (RF) energy and the potential health risks associated with using such products. If you have any concerns about potential health risks associated with long term exposure to RF energy, you should obtain advice from your employer.

### **RF energy interference with electronic equipment**

Some personal medical devices, such as hearing aids and pacemakers, can be affected by RF energy. Always consult your service provider or the manufacturer of the medical device before using RF wireless devices.

Some electronic devices are sensitive to RF energy. POWER OFF your radio when operating within health care facilities or other areas that are sensitive to RF energy.

### **Safely operating your radio**

Your radio is not intrinsically safe and has not been designed for use in hazardous environments such as gas fumes, flammable chemicals, or blasting areas. Check the compliance ratings of this product before operating the radio in any hazardous environment.

Your radio should be used in its normal operating position when hand-held, worn on the body or secured within a cradle. Always ensure that the antenna is pointed away from the body, particularly the eyes. When body-worn, the radio must be secured using Kirisun approved attachments. Always ensure that your radio is operating correctly before entering any environment that has a potential risk to personal safety.

Only remove the antenna, battery or accessories when it is safe to do so.

### **Protection against hearing loss**

NEVER place the radio next to your ear, like a mobile phone when making a PTT call. Your radio has a powerful loudspeaker that could potentially damage your hearing if held next to your ear. Always check the volume level before making and receiving calls.

### **Safety when driving a vehicle**

Always obey local laws and regulations governing the operation of RF wireless devices when driving and whilst at locations. Do not operate your radio if it creates a distraction from driving safely and observing road conditions.

Always POWER OFF your radio at refuelling stations and obey warning signs relating to the use of RF wireless devices in the vicinity of refuelling stations.

### **Important safety notes about the Antenna**

NEVER touch the antenna when the radio is transmitting, this may cause a minor burn to the skin and may affect the operational range of the antenna. NEVER use your radio if the antenna shows signs for damage.

DO NOT handle, hold or swing the radio by its antenna, because this may damage the antenna and the radio. Do not chew the antenna or place it into your mouth. NEVER use your radio without an antenna attached. Transmitting without an antenna may damage the radio. Only use a Kirisun approved antenna with your radio.

### **Operational Conditions**

Do not exceed the operational conditions for the radio and battery. Always check the technical data for this product before attempting to operate the product in extreme conditions. Leaving the radio in extreme temperatures, for example behind glass indirect sunlight may cause damage to the casing and the battery.

Care should be taken to avoid mechanical impact.

### **Accessories**

Kirisun products have been tested to meet strict guidelines for personal safety and operational conditions. Only accessories approved by Kirisun are recommended for use with this product. Always read the instructions supplied with the accessory for additional safety instructions.



The use of non-approved accessories may invalidate any product warranty. If a non-approved accessory is fitted, it may compromise the product safety ratings.

Always fit the RAC cover when an accessory is not in use.

### **Safe installation into vehicles**

Electronic control mechanisms within a vehicle can be affected by the use of RF energy such as ABS and transmission controls. Always refer to the vehicle manufacturer's instructions and technical information relating to electronic modules and their wiring harnesses before installing an RF wireless device into a vehicle.

Do not install the product within the air bag deployment area. In the event of the air bag deflating, the radio could be propelled at great force potentially causing serious injury.

### **Servicing**

Do not attempt to dismantle this product. Servicing and repairs to this product must be performed by trained service technicians at Kirisun approved service centres.

## Regulatory



Kirisun declares that this product is **compliant** with the essential requirements and other relevant provisions of the European R&TTE directive 1999/5/EC relating to radio and telecommunications terminal equipment and the mutual recognition of their conformity.

This product is also compliant with directive 2011/65/EU having been designed and manufactured to the RoHS requirements.

## Waste Electrical and Electronic Equipment recycling



This symbol on the product or its packaging indicates that this product must not be disposed of as household or commercial waste. Some countries have set up collection and recycling systems for waste electrical and electronic products. By ensuring that this product and its packaging is disposed of correctly, you will help prevent potentially negative consequences for the environment and human health, and help conserve natural resources. Please dispose of your waste product according to your national and local regulations. Contact your service provider or Kirisun for information about disposing of this product in your region of the world.

## Disposing of batteries



Your radio is supplied with a rechargeable lithium-ion battery. This symbol on the battery and its packaging indicates that it must not be disposed of with household or commercial waste. Please dispose of your waste batteries according to your national and local regulations. Contact your service provider or Kirisun about recycling batteries in your region of the world.

## **Caring for your product**

Your radio does not require regular servicing. Caring for your radio as described in this guide will help maintain the product in good operational condition.

Kirisun supplies a range of accessories to protect the radio during use, including a protective cover. Contact Kirisun for more information.

Always wear eye protection when using brushes or other tools to remove debris from connectors or other parts of the radio.

Do not use chemicals, aerosols or abrasive cleaners. Chemical coatings must not be applied to any part of the radio or battery.

Clean the exterior surfaces daily using a lint free soft cloth.

Clean the battery contacts periodically using a soft brush

## Connectors, controls, buttons and keys

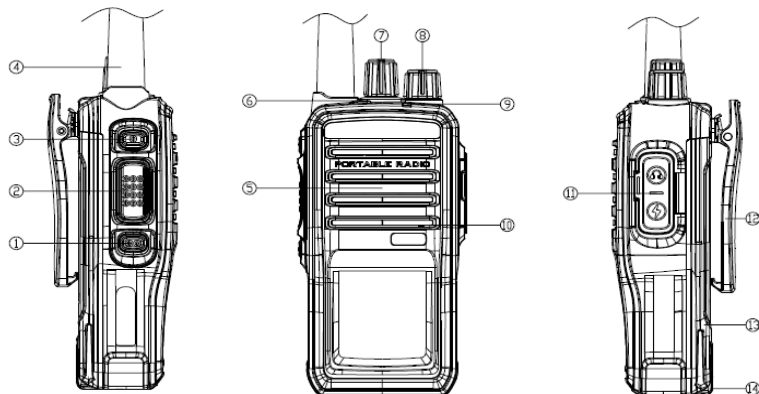

Refer to the illustration for the location of the following connectors, controls, buttons and keys:

- (1) Programmable side button 1
- (2) PTT button
- (3) Programmable side button 2
- (4) Antenna
- (5) Speaker
- (6) Top key
- (7) Channel selector knob
- (8) Power/Volume knob
- (9) LED status indicator
- (10) Microphone
- (11) Rugged accessory connector (RAC) with cover (screw fixing)  
    Micro USB slot and earphone slot
- (12) Belt clip accessory
- (13) Battery
- (14) Battery latch

## **Keys, buttons and knobs overview**

### **Power switch / Volume knob**

To power on, rotate clockwise.

To power off, rotate counter-clockwise.

To increase the volume, continue rotating clockwise. Rotate counter-clockwise to decrease the volume.

### **Channel knob / Group selector knob**

Rotate clockwise to change channels / groups. Your service provider may program your radio up to 16 channels with contact groups or persons.

### **Top button (Programmable)**

It's programmable to support the following functions: broadcast battery / broadcast user name / broadcast group name / download voice record / open contact list. It supports defining function for two actions: " long press" and " short press"

### **Side button (Programmable)**

It's programmable to support the following functions: broadcast battery / broadcast user name / broadcast group name / download voice record / open contact list. It supports defining function for two actions: " long press" and " short press"

## LED status indicator

The LED changes colour to show the operational state of your radio.

LED	Operational State
Solid red	<ul style="list-style-type: none"><li>- Fail to insert SIM card or SIM card was installed wrongly, voice prompts "mobile phone card read failure"</li><li>- This device is not added in the server</li><li>- Device is added, but its group selector knob is not set successfully</li><li>- SIM card PIN unlock unsuccessfully, and the voice prompts "PIN ERROR"</li></ul>
Solid green	<ul style="list-style-type: none"><li>- Calling status (group call / single call / duplex / all call)</li><li>- In the status of downloading or playing voice records</li></ul>
Solid yellow	<ul style="list-style-type: none"><li>- Standby status for individual call</li><li>- Standby status or setting up status for duplex call</li></ul>
Flashing red	<ul style="list-style-type: none"><li>- SIM card is not activated or in deficit, so the device cannot register to the wireless network</li></ul>

LED	Operational State
	- Wireless signal is poor, so the device cannot register
Flashing green slowly	- Has successfully registered in the server, enter the standby mode
Flashing yellow	- In the status of registering to the network;
No indication	- Radio is in 'idle' mode or is powered off.

## Battery information

Your radio is supplied with a Kirisun approved battery to provide optimum performance. If you battery is new, it may need to be fully charged before first use. Always ensure your battery is fully charged before you start your shift.

The following guidelines will help you get the best performance from your Kirisun battery and help to ensure your safety.

### Battery safety

Refer to the instructions supplied with the charger for more safety information.





**Warning:** Take care when handling and charging batteries. Accidental short-circuiting of the battery electrical circuit (battery radios) by metal objects may cause bodily injury such as a burn. Do not disassemble, mutilate or incinerate the battery.

**Caution:** This radio has been tested and certified using a Kirisun approved battery. Using non-approved batteries may damage the radio and invalidate any product warranty. When recharging batteries, always ensure that the battery charger is placed in a well-ventilated area away from combustible materials. Never use a battery that shows signs of damage (not minor scratches) or has been dropped or received a 'sharp blow'. Damage to the battery may not always be obvious.

## Storage and transportation

Use the original packaging to store and transport batteries. To obtain the best performance from your battery, store it in a cool dry place. Failure to store batteries correctly could lead to reduced capacity and battery life

Do not store a fully charged battery for periods exceeding 6 months. For storage periods exceeding 6 months, apply a conditioning charge of 7 minutes for standard and 12 minutes for high capacity batteries every 6 months.

Storage temperature guidelines:

<1 months	-20 to +55 °C (-4 to 131 °F)
1 to 3 months	-20 to +40 °C (-4 to 104 °F)
>3months	-20 to +30 °C (-4 to 86 °F)

## Charging your battery

If the battery is new, it is important that it is fully charged before first use.

Your radio will sound an audible alert when the battery has less than 15% charge remaining.

Typical charging time is approximately 3-4 hours. This may vary depending on the battery and environmental conditions.

Charge your battery between 5 °C to 35 °C (41 °F to 95 °F) temperatures only.

Always ensure that the radio is powered **off** before charging the battery.

This radio provides 3 types of charging:

- 1) Charging with the micro USB slot in the RAC ( battery attached in the boy of radio)

Connect the data/charging cable to the micro USB in the RAC, the LED indicator at the top of the radio can show the charging status.

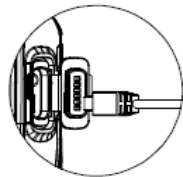

2) Charging with the micro USB slot at the bottom of the battery

Remove the battery from the body of the radio, connect the data/charging cable to the micro USB slot at the bottom of the battery. The LED indicator can show the charging status.

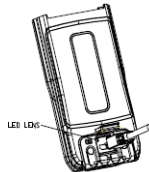

3) Charging with the charger (**charger is optional accessory**)

The charger must be placed onto a flat surface away from flammable materials when charging.

Place the battery into the charger pocket by aligning the slots on the battery with the guides on the charger pocket. It is not necessary to remove the battery from the radio when charging. Ensure the battery (or radio with battery attached) is secure in the charger pocket.

Never leave the battery or radio with battery attached in the charger when not charging.

The charger unit has LEDs that indicate the state of charging.

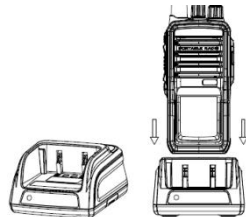

Charger LED	State
Solid red	Battery is charging.
Solid green	Battery is fully charged. Standby mode without battery.
Flashing yellow	Battery is damaged. Contact your service provider or Kirisun.

## Accessory information

### Fit the battery

Align the battery with the two slots on the back of the radio.

Carefully slide the battery forward along the slots until it clicks into place.

### Remove the battery

Ensure the radio is powered **off**.

Push the battery latch upwards. Slide the battery backwards until it detaches from the radio.

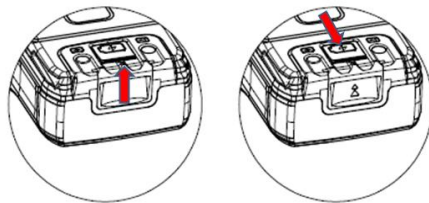

### Fit the antenna

Ensure the radio is powered **off**

Place the antenna into its receptacle

Rotate the antenna clockwise until finger tight.

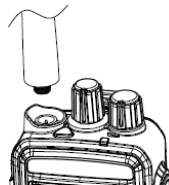

### Fit the belt clip

Ensure the radio is powered **off**.

Remove the two screws at the back of the radio using a cross-head PH1 screwdriver.

Align the screw holes on the belt clip with the mounting holes on the back of the radio.

Secure into position using the two screws.

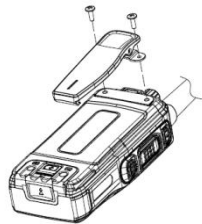

**Caution:** Do not over tighten the screws, this may damage the product.

### **Connect the programming cable**

Open the RAC fist, then plug the data/charging cable into the micro USB slot in the RAC.

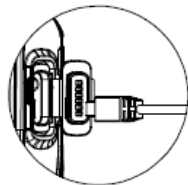

### **Fit earphone (earphone is optional accessory)**

Open the RAC cover first, then plug Kirisun-approved earphone into the slot in the RAC.

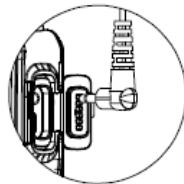

## **Basic operation**

### **Power on/off**

To power **on**, rotate the Power/volume knob clockwise.

To power **off**, rotate the Power/volume knob counter-clockwise until the knob clicks.

### **Standby**

First boot after installed battery, it will take about 50s to register in the server. Then if turn off the power, the radio will get into sleep mode to maintain the minimum power consumption. If turn on again, it will takes just 10 seconds to register. After successfully registered, the radio will get into the standby status waiting for group call.

### **Adjusting the volume**

Rotate the Power/volume knob clockwise to increase the volume.

Rotate the Power/volume knob counter-clockwise to decrease the volume.

### **Selecting a channel**

Your service provider may program the radio with up to 16 channels with either a contact group or person.

To change the channel, rotate the channel selector knob.

## **Call duration setting**

To avoid occupy right to speak too long, it provides setting for call duration, Time periods range from 30 to 90 seconds, and can be set in the configuration tool. At the end of the time period, the call will be terminated automatically no matter the calling is finished or not.

## **Making a PTT call**

Press PTT key to initiate a call, if there is no group member online, then voice prompts “no user online”, otherwise the indicator turns green to indicate the call has gotten through. Release the PTT key to finish the call to enter the standby status

## **Receiving a PTT call**

When the radio is in standby status, if a call comes, the indicator will turn solid red. When the call is finished, a sound ‘Di’ can be heard. When the call is finished, If it’s a group call, the indicator will flash green slowly; if it’s a individual call, the indicator will turn yellow. If want to call back, press PTT button.

## **Delay access**

Allow radio to access an ongoing group call after a period of time



## Priority call

Allow setting different priorities for each radio. The radio with higher priority can make a call prior to others

## Calling types

### ➤ Group call

After boot, the radio will enter standby status waiting for group call, press the PTT button can make a group call, and by rotating the channel / group selection knob can switch between the groups

### ➤ Individual call

First, do the setting for “friend person” for radio in the management platform. Press the programmable key which is programmed to be with “individual call” function, enter into “individual call mode”, there is a voice prompts the status and broadcast the name of individual person / radio in the other end. Press again to exit the individual mode. By pressing the side programmable key, each friend in the preset friend list can be selected

### ➤ All call

First, add an “All call” group with relevant members in the management platform. The radio with the authorization of “All call” can call all the radios belonging to the account (agent / client / company etc), no matter which group the radios are in at the moment. The all call will last for 30s, within this period, every member in this call group could have right to speak.

### ➤ Duplex call

Press the programmable button which is programmed to be with “duplex call” function, then enter the duplex call mode, press PTT button to initiate the call, during the duplex call, the members in the call can speak without pressing PTT button

\*Duplex cal can't be interrupted

### **Historical call record playback**

Press the programmable button which is programmed to be with “download the historical call”, then the radio can download and playback the historical call. It only supports to download five historical calls, and this function should be opened in the management platform in advance.

### **Position information report**

GPS function can report the radio's position information to the management platform. Then radio's position can be shown in map in the management platform or dispatcher

### **Low battery alert**

When the remaining battery is less than 15%, voice will prompt “low battery, please charge” first time.

When the remaining battery is less than 10%, voice will prompt “low battery, please charge” again

When the remaining battery is less than 5%, there will be a voice prompts “low battery, please charge” at a certain frequency with the indicator flashing slowly

## Remote programming

Allow programming the radio via 2G (GPRS) / 3G network by operating in management platform , or via WIFI network by operating in configuration APP in Android phone.

## WIFI network

Support access to WIFI network and open a hotspot for other devices. WIFI SSID and password can be set through “PC configuration tool”

## Advanced signalling function

Support functions of stun, revive and kill

## Technical specifications

General	
Communication Mode & Frequency Band	3G: WCDMA 850Mhz+2100Mhz or WCDMA 900Mhz+2100Mh 2G: GSM 850M+900M+1800M+1900Mhz WIFI: 2.4Ghz

Channel Spacing	2G: 200kHz 3G: 5Mhz (Follow 2G/3G protocol and managed by public telecom operator)
Operating Temperature	-10°C ~ + 50°C
Storage Temperature	-40°C ~ + 80°C
Power Supply	DC 3.7V
Battery	3600mAh Li-ion
Dimension (H*W*D)	115mm*54mm*30mm (with battery, without antenna)
Weight	330g (with battery and antenna)
Display	NA
Keypad	NA
Dustproof & Waterproof	IP65

Battery Life (3600mAh)	2G mode: 22 hrs (GPS on); 25 hrs (GPS off) 3G mode: 15 hrs (GPS on); 16 hrs (GPS off)
<b>Transmitter</b>	
RF Power Output	2G: 2W $\pm$ 0.5W 3G: 0.25W $\pm$ 0.1W
Frequency Stability	$\pm$ 0.1 ppm
Audio Distortion	5% (typical)
<b>Receiver</b>	
Frequency Stability	$\pm$ 0.1 ppm
Sensitivity	2G: BER < 0.001 when $\hat{I}_{or} = 1\mu\text{V}$ ; 3G: BER < 0.001 when $\hat{I}_{or} = 1\mu\text{V}$
Rated Audio Power	1W
Rated Audio Distortion	5% (typical)



**Kirisun Communications Co.,Ltd.**  
<http://en.kirisun.com>

## **FCC RF EXPOSURE INFORMATION:**

**WARNING!! Read this information before using your phone**

In August 1986 the Federal Communications Commission (FCC) of the United States with its action in Report and Order FCC 96-326 adopted an updated safety standard for human exposure to radio frequency (RF) electromagnetic energy emitted by FCC regulated transmitters. Those guidelines are consistent with the safety standard previously set by both U.S. and international standards bodies. The design of this PTT complies with the FCC guidelines and these international standards. Use only the supplied or an approved antenna. Unauthorized antennas modifications, or attachments could impair call quality, damage the PTT, or result in violation of FCC regulations. Do not use the PTT with a damaged antenna. If a damaged antenna comes into contact with the skin, a minor burn may result. Please contact your local dealer for replacement antenna.

## **BODY-WORN OPERATION:**

This device was tested for typical body-worn operations with the front of the PTT kept 25mm from the face. To comply with FCC RF exposure requirements, a minimum separation distance of 25mm must be maintained between the user's face and the front of the PTT, including the antenna. Third-party belt-clips, holsters and similar accessories containing metallic components shall not be used. Body-worn accessories that cannot maintain 0mm separation distance between the user's body and the back with belt clip of the PTT, and have not been tested for typical body-worn operations may not comply with FCC RF exposure limits and should be avoided.

For more information about RF exposure, please visit the FCC website at [www.fcc.gov](http://www.fcc.gov)

When it is ON, it receives and also sends out radio frequency (RF) signals. In August, 1996, the Federal Communications Commission (FCC) adopted RF exposure guidelines with safety levels for hand-held wireless PTT. Those guidelines are consistent with the safety standards previously set by both U.S. and international standards bodies:

<ANSI C95.1> (1992) / <NCRP Report 86> (1986) / <ICNIRP> (1999)

Those standards were based on comprehensive and periodic evaluations of the relevant scientific literature. For example, over 120 scientists, engineers, and physicians from universities, government health agencies, and industry reviewed the available body of research to develop the ANSI Standard (C95.1). Nevertheless, we recommend that you use a hands-free kit with your PTT (such as an earpiece or headset) to avoid potential exposure to RF energy. The design of your PTT complies with the FCC guidelines (and those standards).

Use only the supplied or an approved replacement antenna. Unauthorized antennas, modifications, or attachments could damage the PTT and may violate FCC regulations.

### **RF Exposure Information:**

This product is compliance to FCC RF Exposure requirements and refers to FCC website <https://apps.fcc.gov/oetcf/eas/reports/GenericSearch.cfm> search for FCC ID: Q5EW60W65 to gain further information include SAR Values.

This device complies with part 15 of the FCC rules. Operation is subject to the following two conditions:

- (1) this device may not cause harmful interference, and
- (2) this device must accept any interference received, including interference that may cause undesired operation.

NOTE: The manufacturer is not responsible for any radio or TV interference caused by unauthorized modifications to this equipment. Such modifications could void the user's authority to operate the equipment.

NOTE: This equipment has been tested and found to comply with the limits for a Class B digital device, pursuant to part 15 of the FCC Rules. These limits are designed to provide reasonable protection against harmful interference in a residential installation. This equipment generates uses and can radiate radio frequency energy and, if not installed and used in accordance with the instructions, may cause harmful interference to radio communications. However, there is no guarantee that interference will not occur in a particular installation. If this equipment does cause harmful interference to radio or television reception, which can be determined by turning the equipment off and on, the user is encouraged to try to correct the interference by one or more of the following measures:

- Reorient or relocate the receiving antenna.
- Increase the separation between the equipment and receiver.
- Connect the equipment into an outlet on a circuit different from that to which the receiver is connected.
- Consult the dealer or an experienced radio/TV technician for help

Do not use the device with the environment which below minimum  $-10^{\circ}\text{C}$  or over maximum  $50^{\circ}\text{C}$ , the device may not work.

Changes or modifications to this unit not expressly approved by the party responsible for compliance could void the user's authority to operate the equipment.

Ad Hoc function is supported but not able to operate on non-US frequencies.

Please only use the belt clip provided in the package.



This device complies with Industry Canada licence-exempt RSS standard(s). Operation is subject to the following two conditions: (1) this device may not cause interference, and (2) this device must accept any interference, including interference that may cause undesired operation of the device.

Le présent appareil est conforme aux CNR d'Industrie Canada applicables aux appareils radio exempts de licence. L'exploitation est autorisée aux deux conditions suivantes : (1) l'appareil ne doit pas produire de brouillage, et (2) l'utilisateur de l'appareil doit accepter tout brouillage radioélectrique subi, même si le brouillage est susceptible d'en compromettre le fonctionnement.

**BODY-WORN OPERATION:** This device was tested for typical body-worn operations with the back of the PTT kept 0cm from the body. To comply with RSS102 requirements, a minimum separation distance of 0cm must be maintained between the user's body and the back of the PTT, including the antenna. Third-party belt-clips, holsters and similar accessories containing metallic components shall not be used. Body-worn accessories that cannot maintain 0cm separation distance between the user's body and the back of the PTT, and have not been tested for typical body-worn operations may not comply with RSS 102 limits and should be avoided.

Antenna for GSM & UMTS: Detachable external antenna ;0.5dBi

This EUT is compliance with SAR for general population/uncontrolled exposure limits in IC RSS-102 and had been tested in accordance with the measurement methods and procedures specified in IEEE 1528 and IEC 62209. This equipment should be installed and operated with minimum distance 0 cm between the radiator and your body.

Cet appareil est conforme aux limites d'exposition DAS incontrôlée pour la population générale de la norme CNR-102 d'Industrie Canada et a été testé en conformité avec les méthodes de mesure et procédures spécifiées dans IEEE 1528 et IEC 62209.

Cet appareil doit être installé et utilisé avec une distance minimale de 0 cm entre l'émetteur et votre corps.

**RF Exposure Information:**

This product is compliance to IC RF Exposure requirements and refers to IC website [https://sms-sgs.ic.gc.ca/eic/site/sms-sgs-prod.nsf/eng/h\\_00013.html](https://sms-sgs.ic.gc.ca/eic/site/sms-sgs-prod.nsf/eng/h_00013.html) search for IC: 8992A-W60W65 to gain further information include SAR Values.

Ce produit est conforme aux exigences d'exposition à RF RF et se réfère au site Web IC

Informations sur l'exposition RF:

Obtenir d'autres informations incluent les valeurs SAR.

[https://sms-sgs.ic.gc.ca/eic/site/sms-sgs-prod.nsf/fra/h\\_00013.html](https://sms-sgs.ic.gc.ca/eic/site/sms-sgs-prod.nsf/fra/h_00013.html) recherche IC: 8992A-W60W65 pour obtenir de plus amples informations incluent les valeurs SAR.