

# FCC Test Report

Report No.: AGC00607171204FE03

**FCC ID** : Q5EW25  
**APPLICATION PURPOSE** : Original Equipment  
**PRODUCT DESIGNATION** : POC Trunked Two-way Radio  
**BRAND NAME** : KIRISUN  
**MODEL NAME** : W25, iTALK150  
**CLIENT** : Shenzhen Kirisun Communications Co., Ltd.  
**DATE OF ISSUE** : June 13 2018  
**STANDARD(S)** : FCC Part 15 Rules  
**TEST PROCEDURE(S)** : ANSI C63.10 (2013)  
**REPORT VERSION** : V1.2

Attestation of Global Compliance (Shenzhen) Co., Ltd



**CAUTION:**

This report shall not be reproduced except in full without the written permission of the test laboratory and shall not be quoted out of context.



The results shown in this test report refer only to the sample(s) tested unless otherwise stated and the sample(s) are retained for 30 days only. The document is issued by AGC, this document cannot be reproduced except in full with our prior written permission. The more details and the authenticity of the report will be confirmed at <http://www.agc-cert.com>.

**REPORT REVISE RECORD**

Report Version	Revise Time	Issued Date	Valid Version	Notes
V1.0	/	Mar. 27, 2018	Invalid	Original Report
V1.1	1 <sup>st</sup>	May. 14, 2018	Invalid	Revise Report P32 P35
V1.2	2 <sup>nd</sup>	June 13, 2018	Valid	Revise Report P46

The results shown in this test report refer only to the sample(s) tested unless otherwise stated and the sample(s) are retained for 30 days only. The document is issued by AGC, this document cannot be reproduced except in full with our prior written permission. The more details and the authenticity of the report will be confirmed at <http://www.agc-cert.com>.

**TABLE OF CONTENTS**

**1. VERIFICATION OF CONFORMITY..... 5**

**2. GENERAL INFORMATION ..... 6**

2.1. PRODUCT DESCRIPTION ..... 6

2.2. TABLE OF CARRIER FREQUENCIES ..... 6

2.3. RECEIVER INPUT BANDWIDTH ..... 7

2.4. EXAMPLE OF A HOPPING SEQUENCY IN DATA MODE ..... 7

2.5. EQUALLY AVERAGE USE OF FREQUENCIES AND BEHAVIOUR ..... 7

2.6. RELATED SUBMITTAL(S) / GRANT (S) ..... 8

2.7. TEST METHODOLOGY ..... 8

2.8. SPECIAL ACCESSORIES ..... 8

2.9. EQUIPMENT MODIFICATIONS..... 8

**3. MEASUREMENT UNCERTAINTY ..... 9**

**4. DESCRIPTION OF TEST MODES ..... 10**

**5. SYSTEM TEST CONFIGURATION ..... 11**

5.1. CONFIGURATION OF EUT SYSTEM..... 11

5.2. EQUIPMENT USED IN EUT SYSTEM..... 11

5.3. SUMMARY OF TEST RESULTS ..... 11

**6. TEST FACILITY ..... 12**

**7. PEAK OUTPUT POWER..... 13**

7.1. MEASUREMENT PROCEDURE ..... 13

7.2. TEST SET-UP (BLOCK DIAGRAM OF CONFIGURATION) ..... 13

7.3. LIMITS AND MEASUREMENT RESULT..... 14

**8. 20DB BANDWIDTH..... 17**

8.1. MEASUREMENT PROCEDURE ..... 17

8.2. TEST SET-UP (BLOCK DIAGRAM OF CONFIGURATION) ..... 17

8.3. LIMITS AND MEASUREMENT RESULTS ..... 17

**9. CONDUCTED SPURIOUS EMISSION..... 20**

9.1. MEASUREMENT PROCEDURE ..... 20

9.2. TEST SET-UP (BLOCK DIAGRAM OF CONFIGURATION) ..... 20

9.3. MEASUREMENT EQUIPMENT USED ..... 21

9.4. LIMITS AND MEASUREMENT RESULT ..... 21

**10. RADIATED EMISSION ..... 27**

10.1. MEASUREMENT PROCEDURE ..... 27

10.2. TEST SETUP ..... 28

10.3. LIMITS AND MEASUREMENT RESULT..... 29

The results shown in this test report refer only to the sample(s) tested unless otherwise stated and the sample(s) are retained for 30 days only. The document is issued by AGC, this document cannot be reproduced except in full with our prior written permission. The more details and the authenticity of the report will be confirmed at <http://www.agc-cert.com>.

10.4. TEST RESULT.....	30
<b>11. BAND EDGE EMISSION .....</b>	<b>34</b>
11.1. MEASUREMENT PROCEDURE.....	34
11.2. TEST SET-UP.....	34
11.3. RADIATED TEST RESULT .....	35
11.4 CONDUCTED TEST RESULT .....	36
<b>12. NUMBER OF HOPPING FREQUENCY .....</b>	<b>38</b>
12.1. MEASUREMENT PROCEDURE .....	38
12.2. TEST SETUP (BLOCK DIAGRAM OF CONFIGURATION) .....	38
12.3. MEASUREMENT EQUIPMENT USED .....	38
12.4. LIMITS AND MEASUREMENT RESULT.....	38
<b>13. TIME OF OCCUPANCY (DWELL TIME).....</b>	<b>39</b>
13.1. MEASUREMENT PROCEDURE .....	39
13.2. TEST SETUP (BLOCK DIAGRAM OF CONFIGURATION) .....	39
13.3. MEASUREMENT EQUIPMENT USED .....	39
13.4. LIMITS AND MEASUREMENT RESULT.....	40
<b>14. FREQUENCY SEPARATION .....</b>	<b>41</b>
14.1. MEASUREMENT PROCEDURE .....	41
14.2. TEST SETUP (BLOCK DIAGRAM OF CONFIGURATION) .....	41
14.3. MEASUREMENT EQUIPMENT USED .....	41
14.4. LIMITS AND MEASUREMENT RESULT.....	41
<b>15. FCC LINE CONDUCTED EMISSION TEST .....</b>	<b>42</b>
15.1. LIMITS OF LINE CONDUCTED EMISSION TEST .....	42
15.2. BLOCK DIAGRAM OF LINE CONDUCTED EMISSION TEST.....	42
15.3. PRELIMINARY PROCEDURE OF LINE CONDUCTED EMISSION TEST .....	43
15.4. FINAL PROCEDURE OF LINE CONDUCTED EMISSION TEST.....	43
15.5. TEST RESULT OF LINE CONDUCTED EMISSION TEST.....	44
<b>APPENDIX A: PHOTOGRAPHS OF TEST SETUP .....</b>	<b>46</b>

The results shown in this test report refer only to the sample(s) tested unless otherwise stated and the sample(s) are retained for 30 days only. The document is issued by AGC, this document cannot be reproduced except in full with our prior written permission. The more details and the authenticity of the report will be confirmed at <http://www.agc-cert.com>.

**1. VERIFICATION OF CONFORMITY**

<b>Applicant</b>	Shenzhen Kirisun Communications Co., Ltd.
<b>Address</b>	3rd Floor, Building A, Tongfang Information Harbour, No.11 Langshan Road, Nanshan District, Shenzhen 518057, P.R.China
<b>Manufacturer</b>	Shenzhen Kirisun Communications Co., Ltd.
<b>Address</b>	3rd Floor, Building A, Tongfang Information Harbour, No.11 Langshan Road, Nanshan District, Shenzhen 518057, P.R.China
<b>Product Designation</b>	POC Trunked Two-way Radio
<b>Brand Name</b>	KIRISUN
<b>Test Model</b>	W25
<b>Series Model</b>	iTALK150
<b>Difference Description</b>	All the same except for the model name.
<b>Date of test</b>	Mar. 01, 2018~ Mar. 27, 2018
<b>Deviation</b>	None
<b>Condition of Test Sample</b>	Normal
<b>Report Template</b>	AGCRT-US-BR/RF

We hereby certify that:

The above equipment was tested by Attestation of Global Compliance(Shenzhen) Co., Ltd. The test data, data evaluation, test procedures, and equipment configurations shown in this report were made in accordance with the procedures given in ANSI C63.10 (2013) and the energy emitted by the sample EUT tested as described in this report is in compliance with radiated emission limits of FCC Rules Part 15.247.

The test results of this report relate only to the tested sample identified in this report.

Tested By donjon shang  
 \_\_\_\_\_  
 Nice Xie(Xie xiaosong) Mar. 27, 2018

Reviewed By Bart Xie  
 \_\_\_\_\_  
 Bart Xie(Xie Xiaobin) June 13, 2018

Approved By Forrest Lei  
 \_\_\_\_\_  
 Forrest Lei(Lei Yonggang) June 13, 2018  
 Authorized Officer

The results shown in this test report refer only to the sample(s) tested unless otherwise stated and the sample(s) are retained for 30 days only. The document is issued by AGC, this document cannot be reproduced except in full with our prior written permission. The more details and the authenticity of the report will be confirmed at <http://www.agc-cert.com>.

## 2. GENERAL INFORMATION

### 2.1. PRODUCT DESCRIPTION

The EUT is "POC Trunked Two-way Radio" designed as a "Communication Device". It is designed by way of utilizing the FHSS technology to achieve the system operation.

A major technical description of EUT is described as following:

<b>Operation Frequency</b>	2.402 GHz to 2.480GHz
<b>Bluetooth Version</b>	V4.0
<b>Modulation</b>	GFSK, $\pi/4$ -DQPSK, 8DPSK
<b>Number of channels</b>	79(For BR/EDR)
<b>Hardware Version</b>	V1.0
<b>Software Version</b>	V1.0
<b>Antenna Designation</b>	PIFA Antenna
<b>Antenna Gain</b>	1.16dBi
<b>Power Supply</b>	DC3.7V by Battery

### 2.2. TABLE OF CARRIER FREQUENCIES

Frequency Band	Channel Number	Frequency
2400~2483.5MHZ	0	2402MHZ
	1	2403MHZ
	:	:
	38	2440 MHZ
	39	2441 MHZ
	40	2442 MHZ
	:	:
	77	2479 MHZ
	78	2480 MHZ

The results shown in this test report refer only to the sample(s) tested unless otherwise stated and the sample(s) are retained for 30 days only. The document is issued by AGC, this document cannot be reproduced except in full with our prior written permission. The more details and the authenticity of the report will be confirmed at <http://www.agc-cert.com>.

### 2.3. RECEIVER INPUT BANDWIDTH

The input bandwidth of the receiver is 1.3MHz. In every connection one Bluetooth device is the master and the other one is slave. The master determines the hopping sequence. The slave follows this sequence. Both devices shift between RX and TX time slot according to the clock of the master. Additionally the type of connection (e.g. single or multislotted packet) is set up at the beginning of the connection. The master adapts its hopping frequency and its TX/RX timing according to the packet type of the connection. Also the slave of the connection will use these settings.

Repeating of a packet has no influence on the hopping sequence. The hopping sequence generated by the master of the connection will be followed in any case. That means, a repeated packet will not be sent on the same frequency, it is sent on the next frequency of the hopping sequence.

### 2.4. EXAMPLE OF A HOPPING SEQUENCE IN DATA MODE

Example of a 79 hopping sequence in data mode:

40,21,44,23,42,53,46,55,48,33,52,35,50,65,54,67  
56,37,60,39,58,69,62,71,64,25,68,27,66,57,70,59  
72,29,76,31,74,61,78,63,01,41,05,43,03,73,07,75  
09,45,13,47,11,77,15,00,64,49,66,53,68,02,70,06  
01, 51, 03, 55, 05, 04

### 2.5. EQUALLY AVERAGE USE OF FREQUENCIES AND BEHAVIOUR

The generation of the hopping sequence in connection mode depends essentially on two input values:

1. LAP/UAP of the master of the connection.
2. Internal master clock

The LAP (lower address part) are the 24 LSB's of the 48 BD\_ADDRESS. The BD\_ADDRESS is an unambiguous number of every Bluetooth unit. The UAP (upper address part) are the 24 MSB's of the 48 BD\_ADDRESS.

The internal clock of a Bluetooth unit is derived from a free running clock which is never adjusted and is never turned off. For synchronization with other units only offsets are used. It has no relation to the time of the day. Its resolution is at least half the RX/TX slot length of 312.5µs. The clock has a cycle of about one day (23h30). In most cases it is implemented as a 28-bit counter. For the deriving of the hopping sequence the entire LAP (24 bits), 4 LSB's (4 bits) (Input 1) and the 27 MSB's of the clock (Input 2) are used. With these input values different mathematical procedures (permutations, additions, XOR-operations) are performed to generate the Sequence.

This will be done at the beginning of every new transmission.

Regarding short transmissions the Bluetooth system has the following behavior:

The first connection between the two devices is established, a hopping sequence was generated. For transmitting the wanted data the complete hopping sequence was not used. The connection ended.

The second connection will be established. A new hopping sequence is generated. Due to the fact the Bluetooth clock has a different value, because the period between the two transmissions is longer (and it cannot be shorter) than the minimum resolution of the clock (312.5µs). The hopping sequence will always differ from the first one.

## 2.6. RELATED SUBMITTAL(S) / GRANT (S)

This submittal(s) (test report) is intended for **FCC ID: Q5EW25** filing to comply with Section 15.247 of the FCC Part 15, Subpart C Rules.

## 2.7. TEST METHODOLOGY

Both conducted and radiated testing was performed according to the procedures in ANSI C63.10 (2013). Radiated testing was performed at an antenna to EUT distance 3 meters.

## 2.8. SPECIAL ACCESSORIES

Refer to section 5.2.

## 2.9. EQUIPMENT MODIFICATIONS

Not available for this EUT intended for grant.

The results shown in this test report refer only to the sample(s) tested unless otherwise stated and the sample(s) are retained for 30 days only. The document is issued by AGC, this document cannot be reproduced except in full with our prior written permission. The more details and the authenticity of the report will be confirmed at <http://www.agc-cert.com>.



### 3. MEASUREMENT UNCERTAINTY

- Uncertainty of Conducted Emission,  $U_c = \pm 3.2\text{dB}$
- Uncertainty of Radiated Emission below 1GHz,  $U_c \pm 3.9\text{dB}$
- Uncertainty of Radiated Emission above 1GHz,  $U_c \pm 4.8\text{dB}$

The results shown in this test report refer only to the sample(s) tested unless otherwise stated and the sample(s) are retained for 30 days only. The document is issued by AGC, this document cannot be reproduced except in full with our prior written permission. The more details and the authenticity of the report will be confirmed at <http://www.agc-cert.com>.

#### 4. DESCRIPTION OF TEST MODES

NO.	TEST MODE DESCRIPTION
1	Low channel GFSK
2	Middle channel GFSK
3	High channel GFSK
4	Low channel $\pi/4$ -DQPSK
5	Middle channel $\pi/4$ -DQPSK
6	High channel $\pi/4$ -DQPSK
7	Low channel 8DPSK
8	Middle channel 8DPSK
9	High channel 8DPSK
10	Normal Hopping

**Note:**

1. All the test modes can be supply by Built-in Li-ion battery, only the result of the worst case was recorded in the report, if no other cases.
2. For Radiated Emission, 3axis were chosen for testing for each applicable mode.

The results shown in this test report refer only to the sample(s) tested unless otherwise stated and the sample(s) are retained for 30 days only. The document is issued by AGC, this document cannot be reproduced except in full with our prior written permission. The more details and the authenticity of the report will be confirmed at <http://www.agc-cert.com>.

## 5. SYSTEM TEST CONFIGURATION

### 5.1. CONFIGURATION OF EUT SYSTEM

Configuration:

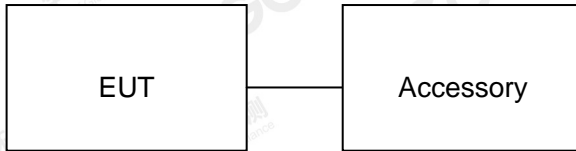

### 5.2. EQUIPMENT USED IN EUT SYSTEM

Item	Equipment	Model No.	ID or Specification	Remark
1	POC Trunked Two-way Radio	W25	Q5EW25	EUT
2	Adapter	DZ0501000EU-1A RBC-10	DC 5.0V/1A 0.2A	Accessory
3	Battery	KB-W25	DC3.7V/ 4000mAh	Accessory
4	USB Cable	N/A	N/A	Accessory
5	Earphone	N/A	N/A	Accessory

### 5.3. SUMMARY OF TEST RESULTS

FCC RULES	DESCRIPTION OF TEST	RESULT
§15.247	Peak Output Power	Compliant
§15.247	20 dB Bandwidth	Compliant
§15.247	Spurious Emission	Compliant
§15.209	Radiated Emission	Compliant
§15.247	Band Edges	Compliant
§15.207	Conduction Emission	Compliant
§15.247	Number of Hopping Frequency	Compliant
§15.247	Time of Occupancy	Compliant
§15.247	Frequency Separation	Compliant

The results shown in this test report refer only to the sample(s) tested unless otherwise stated and the sample(s) are retained for 30 days only. The document is issued by AGC, this document cannot be reproduced except in full with our prior written permission. The more details and the authenticity of the report will be confirmed at <http://www.agc-cert.com>.

**6. TEST FACILITY**

<b>Site</b>	Attestation of Global Compliance (Shenzhen) Co., Ltd
<b>Location</b>	1-2F., Bldg.2, No.1-4, Chaxi Sanwei Technical Industrial Park, Gushu, Xixiang, Bao'an District B112-B113, Bldg.12, Baoan Bldg Materials Center, No.1 of Xixiang Inner Ring Road, Baoan District, Shenzhen 518012
<b>NVLAP LAB CODE</b>	600153-0
<b>Designation Number</b>	CN5028
<b>Description</b>	Attestation of Global Compliance(Shenzhen) Co., Ltd is accredited by National Voluntary Laboratory Accreditation program, NVLAP Code 600153-0

**ALL TEST EQUIPMENT LIST**

Equipment	Manufacturer	Model	S/N	Cal. Date	Cal. Due
TEST RECEIVER	R&S	ESPI	101206	Jun.20, 2017	Jun.19, 2018
LISN	R&S	ESH2-Z5	100086	Aug.21, 2017	Aug.20, 2018
TEST RECEIVER	R&S	ESCI	10096	Jun.20, 2017	Jun.19, 2018
EXA Signal Analyzer	Aglient	N9010A	MY53470504	Dec.08, 2017	Dec.07, 2018
Horn antenna	SCHWARZBECK	BBHA 9170	#768	Sep.20, 2017	Sep.19, 2018
preamplifier	ChengYi	EMC184045SE	980508	Sep.15, 2017	Sep.14, 2018
Double-Ridged Waveguide Horn	ETS LINDGREN	3117	00034609	May.18, 2017	May.17, 2019
Broadband Preamplifier	SCHWARZBECK	BBV 9718	9718-205	Jun.20, 2017	Jun.19, 2018
ANTENNA	SCHWARZBECK	VULB9168	D69250	Sep.28, 2017	Sep.27, 2018
SIGNAL ANALYZER	Agilent	N9020A	MY52090123	Sep. 21, 2017	Sep. 20, 2018
USB Wideband Power Sensor	Agilent	U2021XA	MY54110007	Sep. 21, 2017	Sep. 20, 2018
LOOP ANTENNA	A.H	SAS-562B	/	Mar.01,2018	Feb.28,2020

The results shown in this test report refer only to the sample(s) tested unless otherwise stated and the sample(s) are retained for 30 days only. The document is issued by AGC, this document cannot be reproduced except in full with our prior written permission. The more details and the authenticity of the report will be confirmed at <http://www.agc-cert.com>.

## 7. PEAK OUTPUT POWER

### 7.1. MEASUREMENT PROCEDURE

For peak power test:

1. Connect EUT RF output port to the Spectrum Analyzer through an RF attenuator
2. Set the EUT Work on the top, middle and the bottom operation frequency individually.
3. Use the following spectrum analyzer settings:
  - 1) Span : Approximately five times the 20 dB bandwidth, centered on a hopping channel.
  - 2) RBW > 20 dB bandwidth of the emission being measured.
  - 3) VBW  $\geq$  RBW.
  - 4) Sweep: Auto.
  - 5) Detector function: Peak.
  - 6) Trace: Max hold.
4. Record the maximum power from the Spectrum Analyzer.

**Note** : The EUT was tested according for compliance ANSI C63.10 (2013) requirements.

### 7.2. TEST SET-UP (BLOCK DIAGRAM OF CONFIGURATION)

#### PEAK POWER TEST SETUP

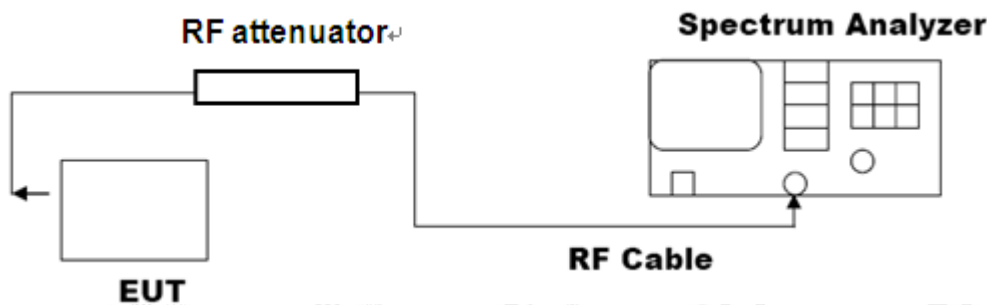

The results shown in this test report refer only to the sample(s) tested unless otherwise stated and the sample(s) are retained for 30 days only. The document is issued by AGC, this document cannot be reproduced except in full with our prior written permission. The more details and the authenticity of the report will be confirmed at <http://www.agc-cert.com>.

**7.3. LIMITS AND MEASUREMENT RESULT**

Mode	Frequency (GHz)	Peak Power (dBm)	Applicable Limits (dBm)	Pass or Fail
GFSK	2.402	6.062	30	Pass
	2.441	6.028	30	Pass
	2.480	5.415	30	Pass

Mode	Frequency (GHz)	Peak Power (dBm)	Applicable Limits (dBm)	Pass or Fail
$\pi$ /4-DQPSK	2.402	5.340	30	Pass
	2.441	5.421	30	Pass
	2.480	4.754	30	Pass

Mode	Frequency (GHz)	Peak Power (dBm)	Applicable Limits (dBm)	Pass or Fail
8DPSK	2.402	5.357	30	Pass
	2.441	5.381	30	Pass
	2.480	4.659	30	Pass

The results shown in this test report refer only to the sample(s) tested unless otherwise stated and the sample(s) are retained for 30 days only. The document is issued by AGC, this document cannot be reproduced except in full with our prior written permission. The more details and the authenticity of the report will be confirmed at <http://www.agc-cert.com>.

Test Graph

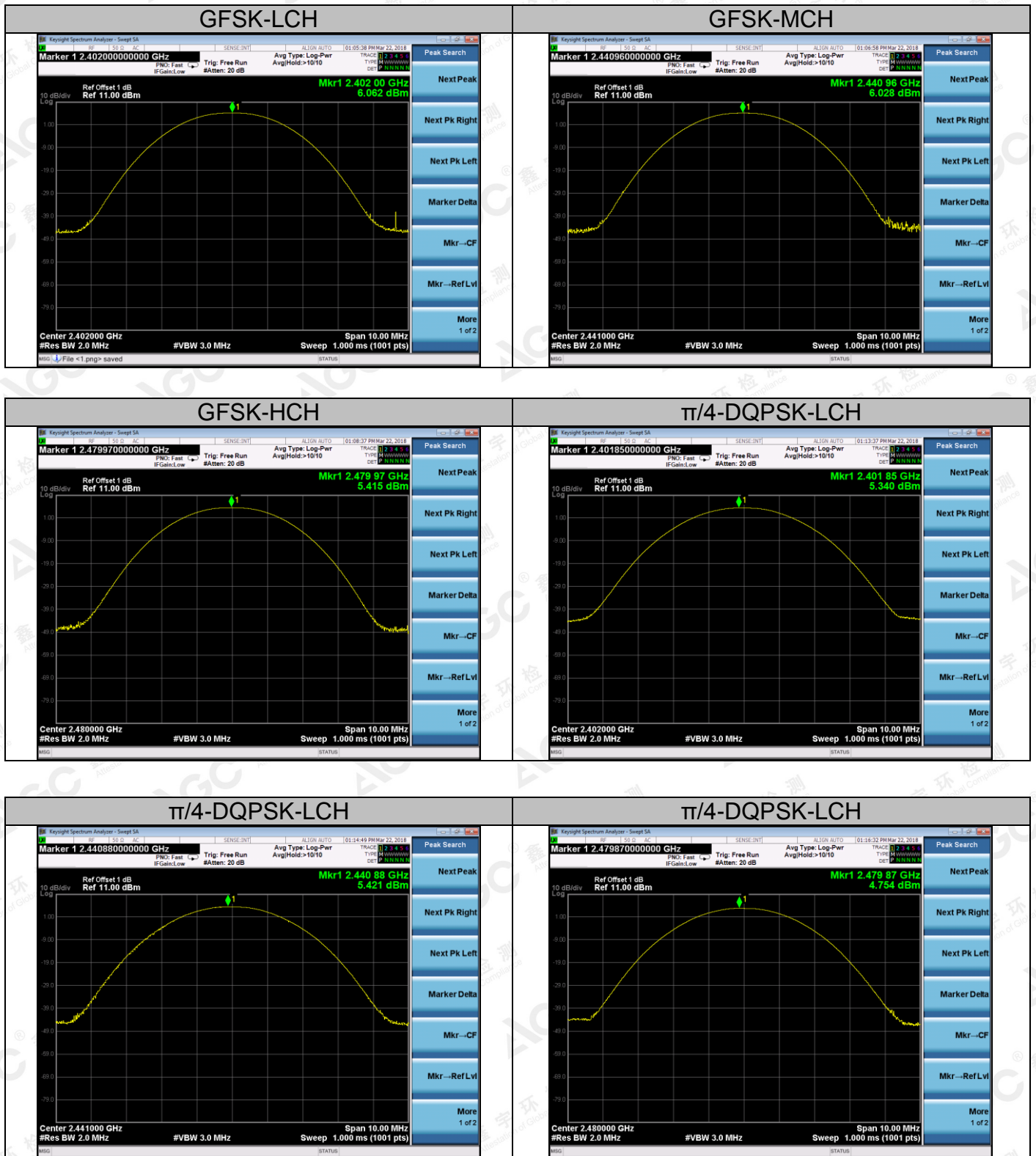

The results shown in this test report refer only to the sample(s) tested unless otherwise stated and the sample(s) are retained for 30 days only. The document is issued by AGC, this document cannot be reproduced except in full with our prior written permission. The more details and the authenticity of the report will be confirmed at <http://www.agc-cert.com>.



The results shown in this test report refer only to the sample(s) tested unless otherwise stated and the sample(s) are retained for 30 days only. The document is issued by AGC, this document cannot be reproduced except in full with our prior written permission. The more details and the authenticity of the report will be confirmed at <http://www.agc-cert.com>.



## 8. 20DB BANDWIDTH

### 8.1. MEASUREMENT PROCEDURE

1. Connect EUT RF output port to the Spectrum Analyzer through an RF attenuator
2. Set the EUT Work on the top, the middle and the bottom operation frequency individually.
3. Set Span = approximately 2 to 3 times the 20 dB bandwidth, centered on a hoping channel  
RBW ≥ 1% of the 20 dB bandwidth, VBW ≥ RBW; Sweep = auto; Detector function = peak
4. Set SPA Trace 1 Max hold, then View.

### 8.2. TEST SET-UP (BLOCK DIAGRAM OF CONFIGURATION)

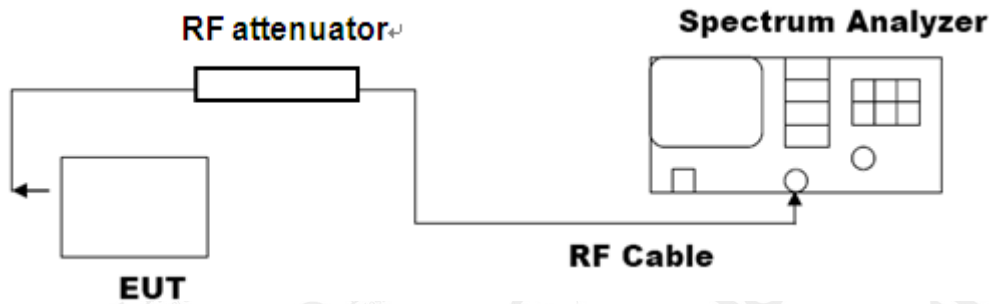

### 8.3. LIMITS AND MEASUREMENT RESULTS

Mode	Channel.	20dB Bandwidth [KHz]	Verdict
GFSK	LCH	828.6	PASS
GFSK	MCH	828.8	PASS
GFSK	HCH	826.2	PASS
$\pi$ /4-DQPSK	LCH	1125	PASS
$\pi$ /4-DQPSK	MCH	1124	PASS
$\pi$ /4-DQPSK	HCH	1123	PASS
8DPSK	LCH	1116	PASS
8DPSK	MCH	1117	PASS
8DPSK	HCH	1115	PASS

The results shown in this test report refer only to the sample(s) tested unless otherwise stated and the sample(s) are retained for 30 days only. The document is issued by AGC, this document cannot be reproduced except in full with our prior written permission. The more details and the authenticity of the report will be confirmed at <http://www.agc-cert.com>.

Test Graph

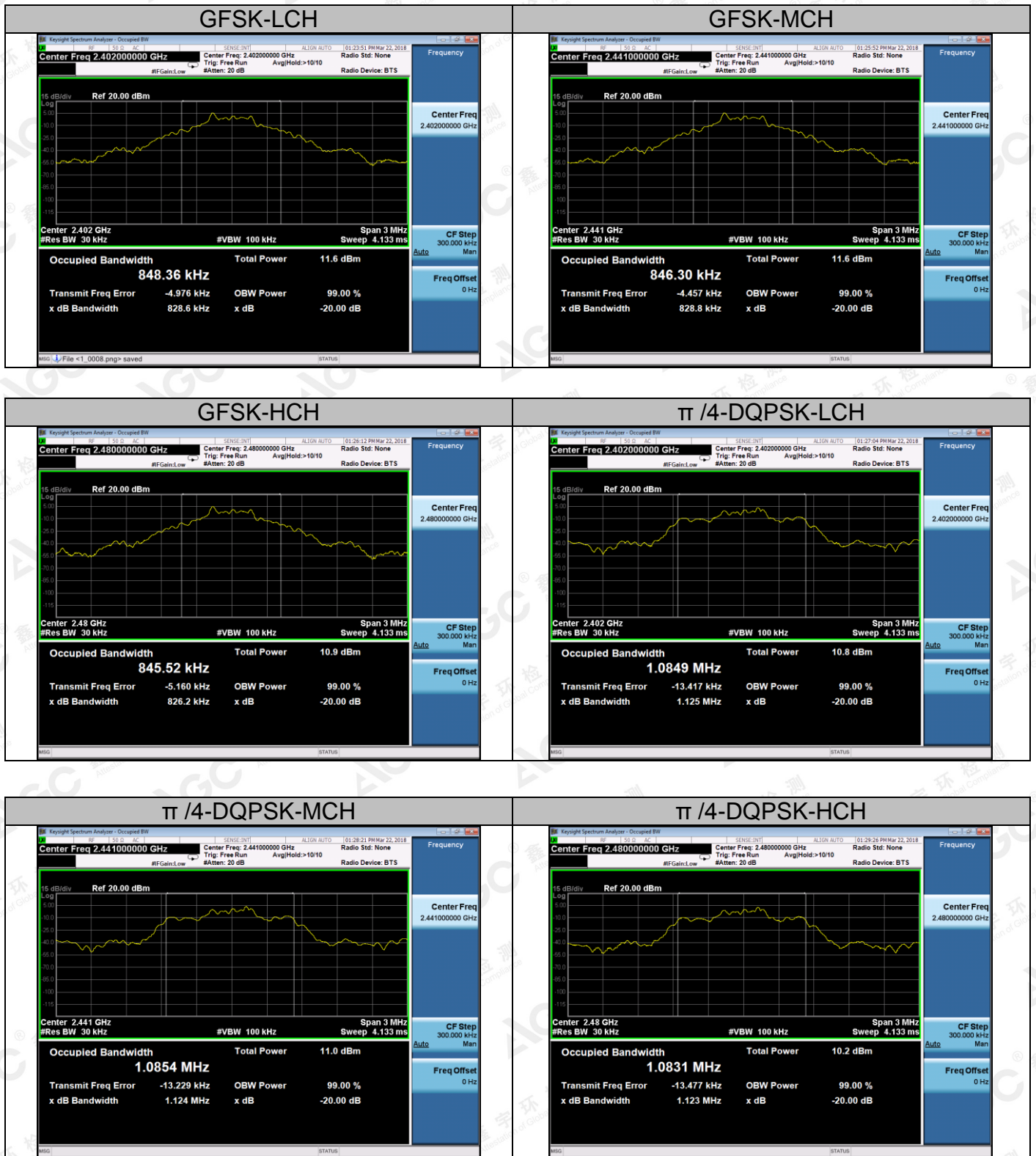

The results shown in this test report refer only to the sample(s) tested unless otherwise stated and the sample(s) are retained for 30 days only. The document is issued by AGC, this document cannot be reproduced except in full with our prior written permission. The more details and the authenticity of the report will be confirmed at <http://www.agc-cert.com>.

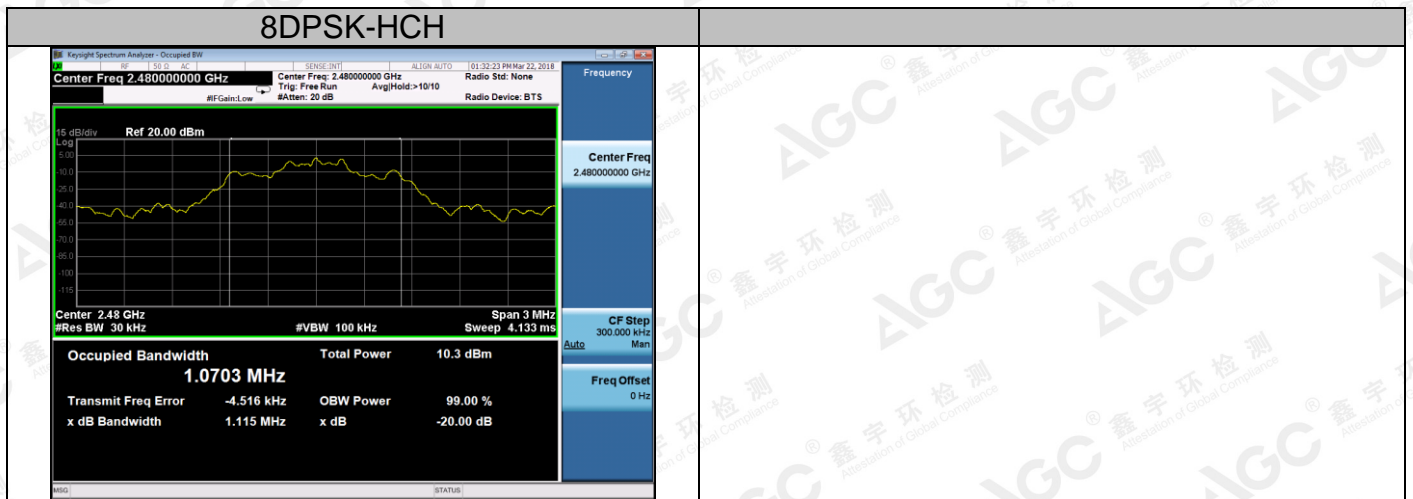
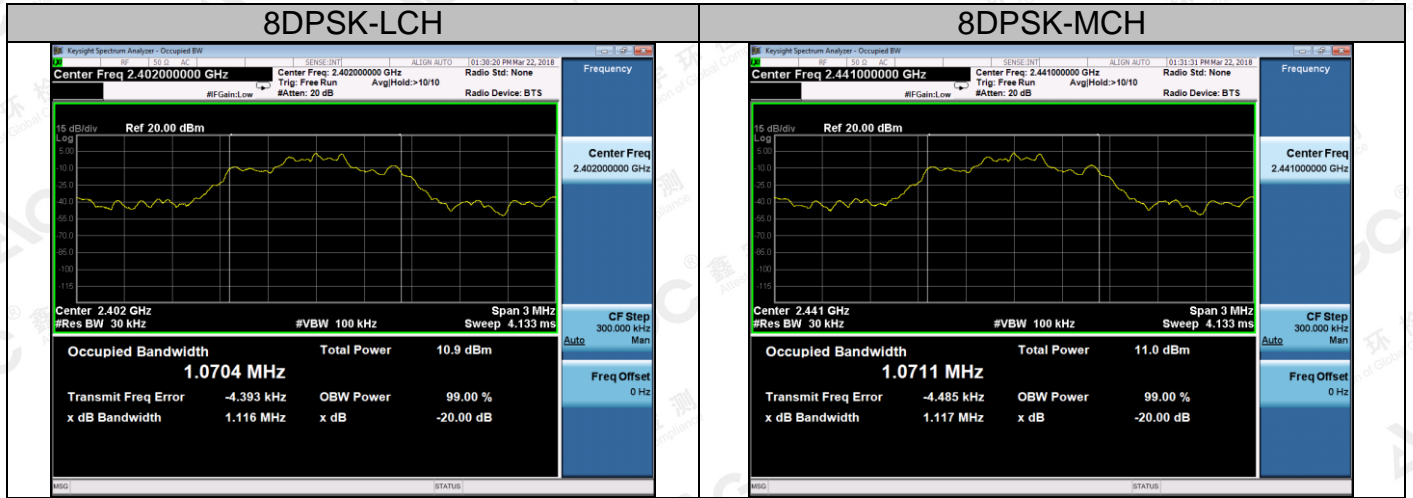

The results shown in this test report refer only to the sample(s) tested unless otherwise stated and the sample(s) are retained for 30 days only. The document is issued by AGC, this document cannot be reproduced except in full with our prior written permission. The more details and the authenticity of the report will be confirmed at <http://www.agc-cert.com>.

## 9. CONDUCTED SPURIOUS EMISSION

### 9.1. MEASUREMENT PROCEDURE

1. Connect EUT RF output port to the Spectrum Analyzer through an RF attenuator
2. Set the EUT Work on the top, the Middle and the bottom operation frequency individually.
3. Set the Span = wide enough to capture the peak level of the in-band emission and all spurious emissions from the lowest frequency generated in the EUT up through the 10th harmonic.  
RBW = 100 kHz; VBW  $\geq$  RBW; Sweep = auto; Detector function = peak.
4. Set SPA Trace 1 Max hold, then View.

**Note:** The EUT was tested according for compliance ANSI C63.10 (2013) requirements. Owing to satisfy the requirements of the number of measurement points, we set the RBW=1MHz, VBW > RBW, scan up through 10th harmonic, and consider the tested results as the worst case, if the tested results conform to the requirement, we can deem that the real tested results(set the RBW=100KHz, VBW > RBW) are conform to the requirement.

### 9.2. TEST SET-UP (BLOCK DIAGRAM OF CONFIGURATION)

The same as described in section 8.2

The results shown in this test report refer only to the sample(s) tested unless otherwise stated and the sample(s) are retained for 30 days only. The document is issued by AGC, this document cannot be reproduced except in full with our prior written permission. The more details and the authenticity of the report will be confirmed at <http://www.agc-cert.com>.

### 9.3. MEASUREMENT EQUIPMENT USED

The same as described in section 6

### 9.4. LIMITS AND MEASUREMENT RESULT

LIMITS AND MEASUREMENT RESULT		
Applicable Limits	Measurement Result	
	Test Data	Criteria
In any 100 KHz Bandwidth Outside the frequency band in which the spread spectrum intentional radiator is operating, the radio frequency power that is produce by the intentional radiator shall be at least 20 dB below that in 100KHz bandwidth within the band that contains the highest level of the desired power. In addition, radiation emissions which fall in the restricted bands, as defined in §15.205(a), must also comply with the radiated emission limits specified in§15.209(a)	At least -20dBc than the limit Specified on the BOTTOM Channel	PASS
	At least -20dBc than the limit Specified on the TOP Channel	PASS

The results shown in this test report refer only to the sample(s) tested unless otherwise stated and the sample(s) are retained for 30 days only. The document is issued by AGC, this document cannot be reproduced except in full with our prior written permission. The more details and the authenticity of the report will be confirmed at <http://www.agc-cert.com>.

Test Graph

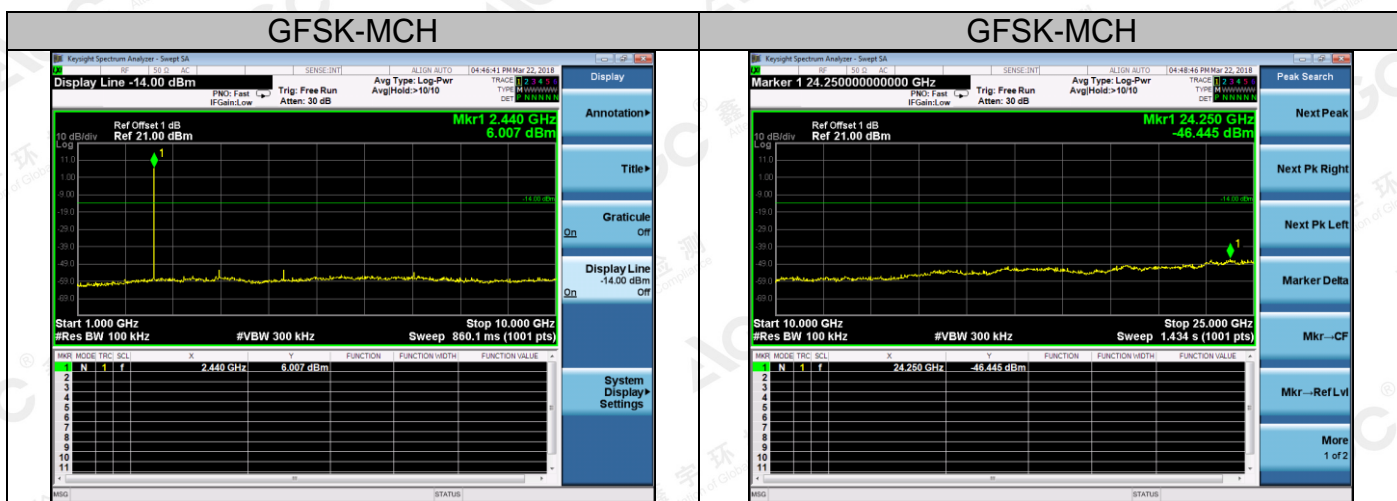
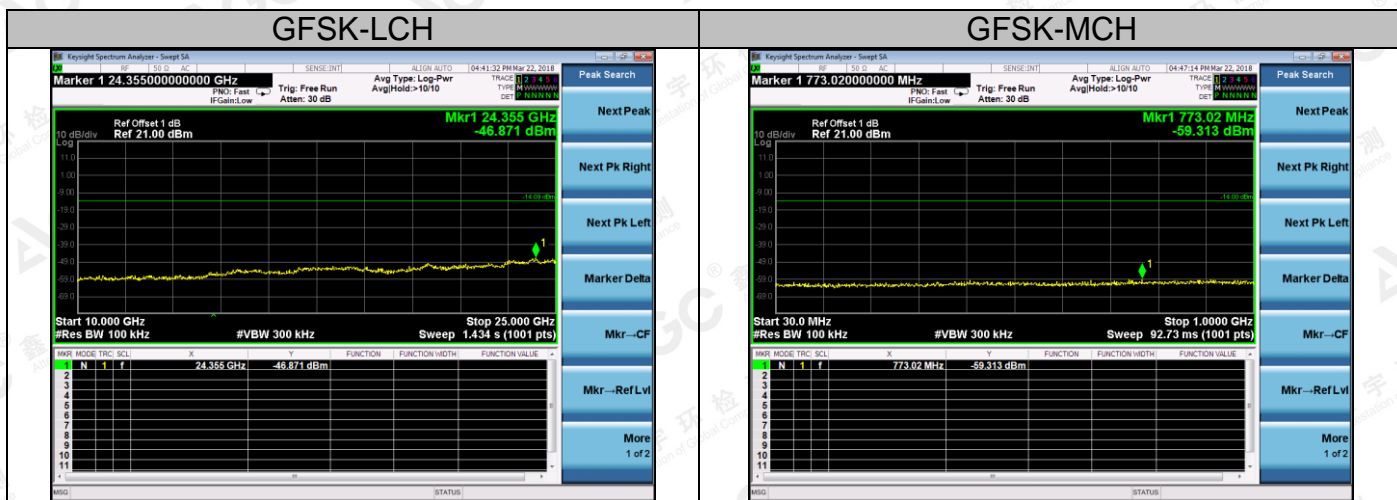
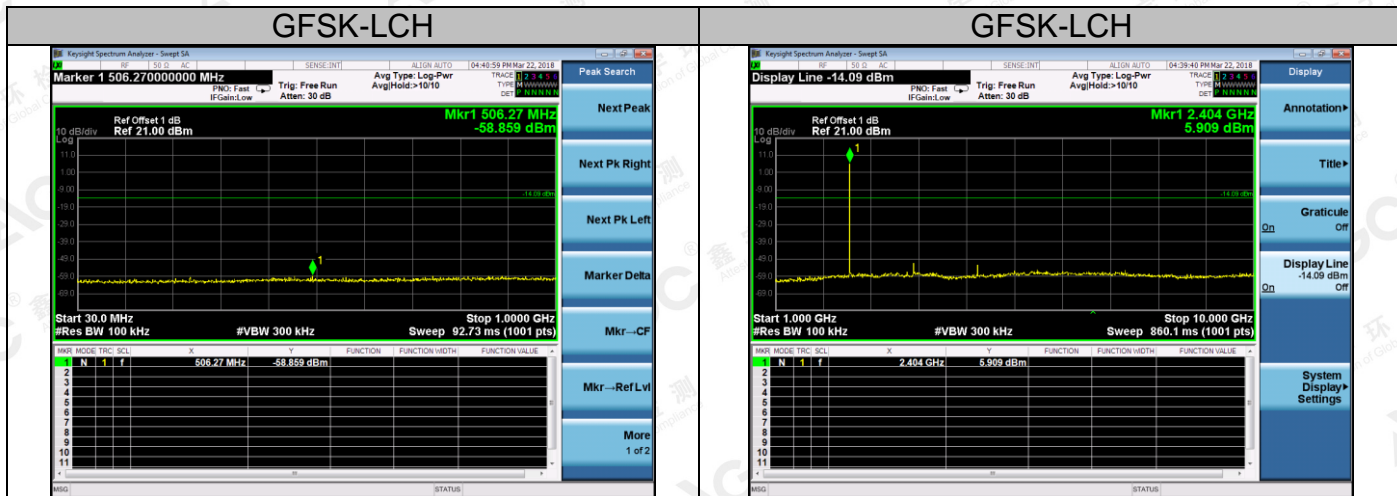

The results shown in this test report refer only to the sample(s) tested unless otherwise stated and the sample(s) are retained for 30 days only. The document is issued by AGC, this document cannot be reproduced except in full with our prior written permission. The more details and the authenticity of the report will be confirmed at <http://www.agc-cert.com>.

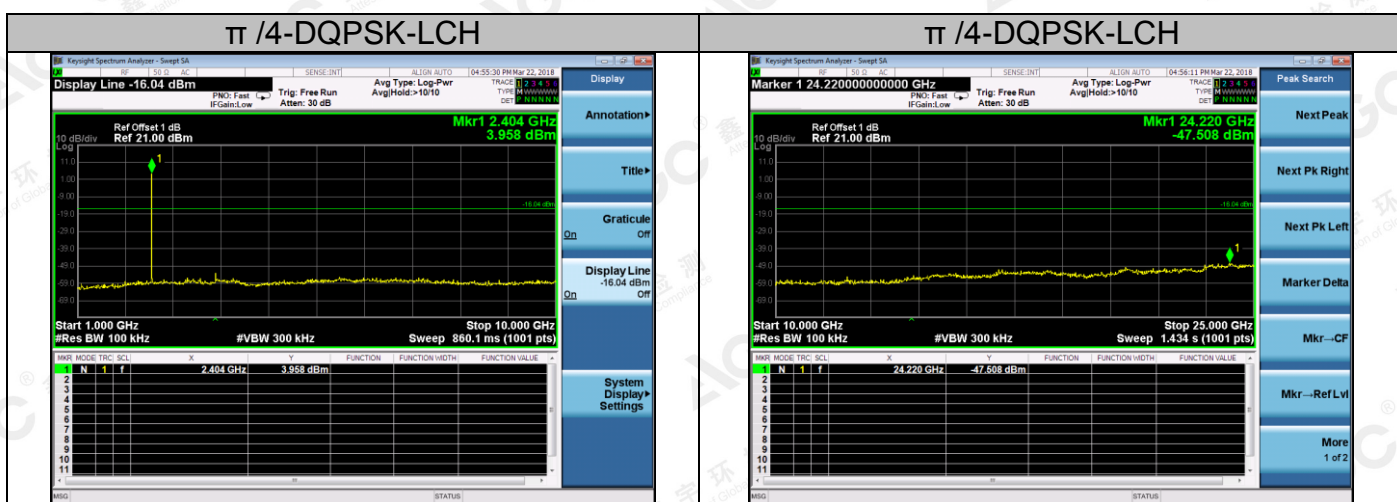
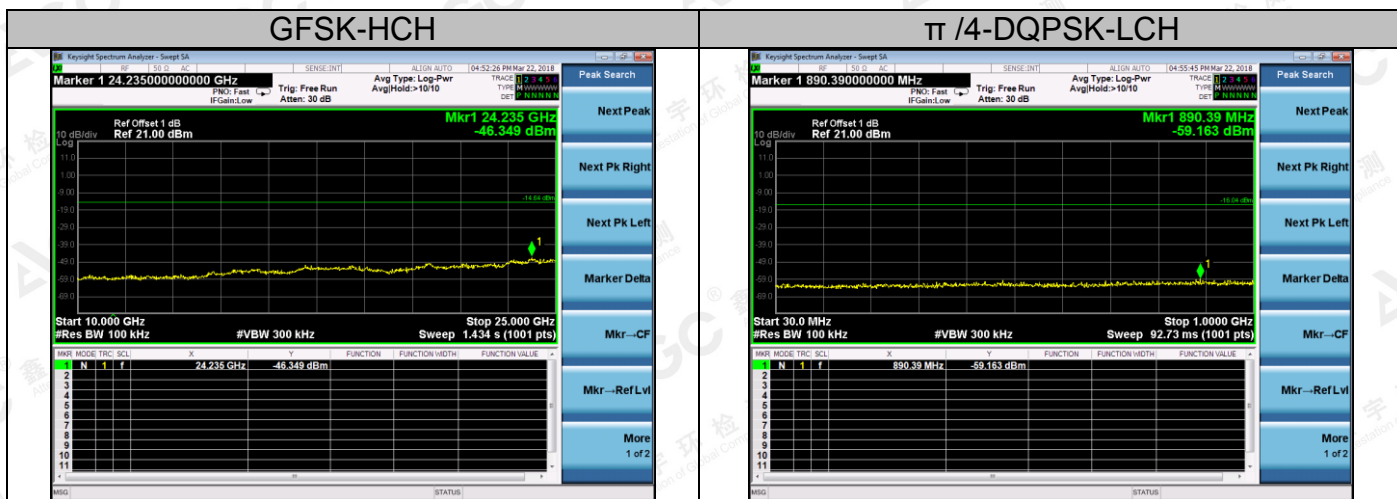
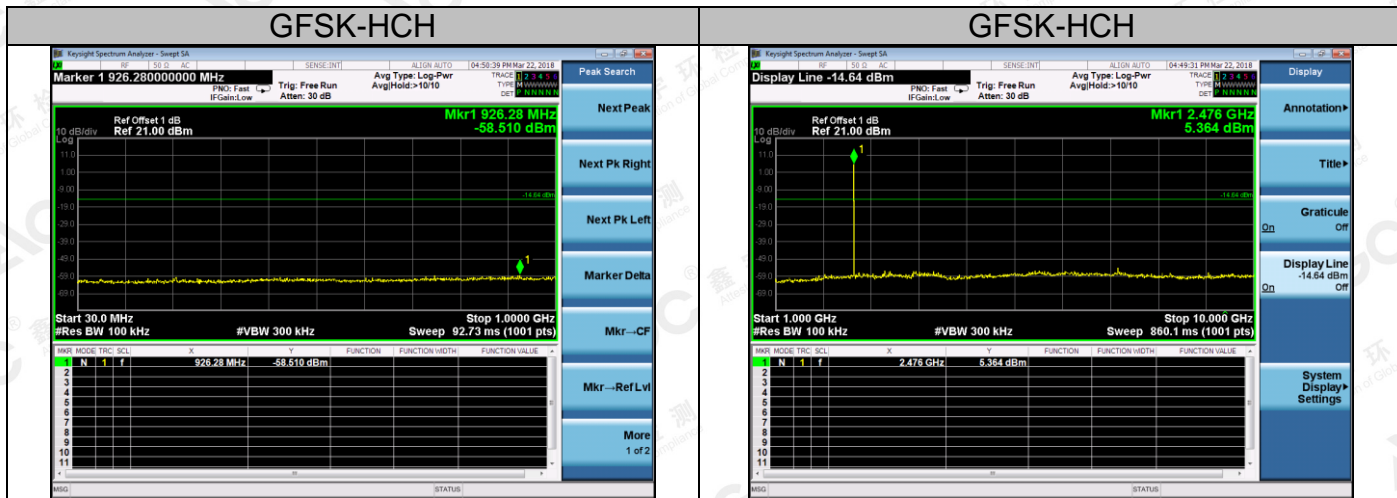

The results shown in this test report refer only to the sample(s) tested unless otherwise stated and the sample(s) are retained for 30 days only. The document is issued by AGC, this document cannot be reproduced except in full with our prior written permission. The more details and the authenticity of the report will be confirmed at <http://www.agc-cert.com>.

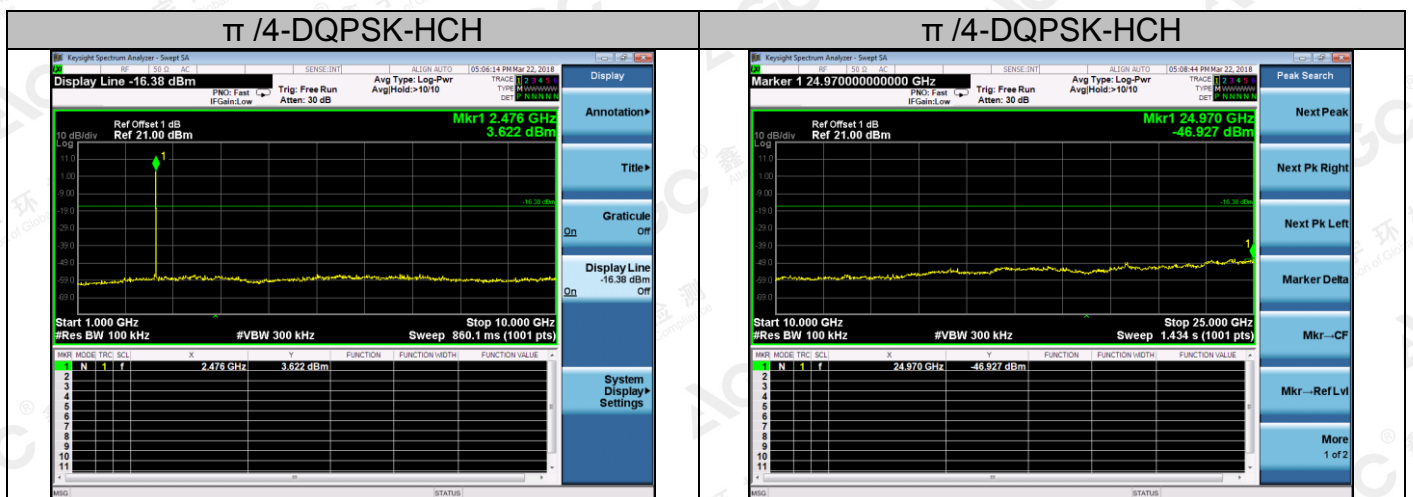
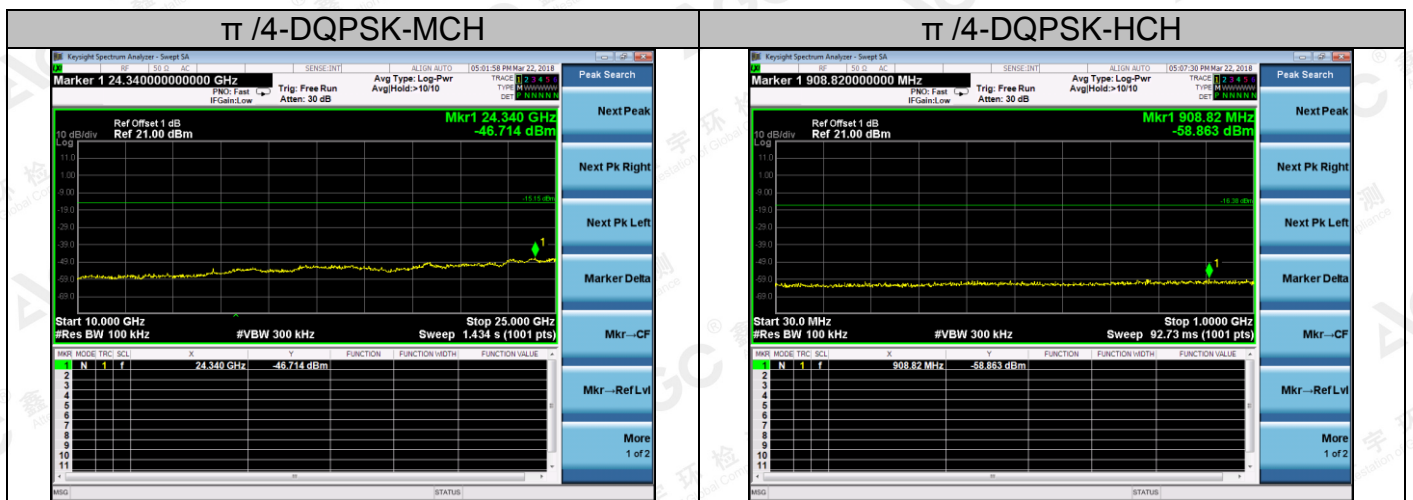
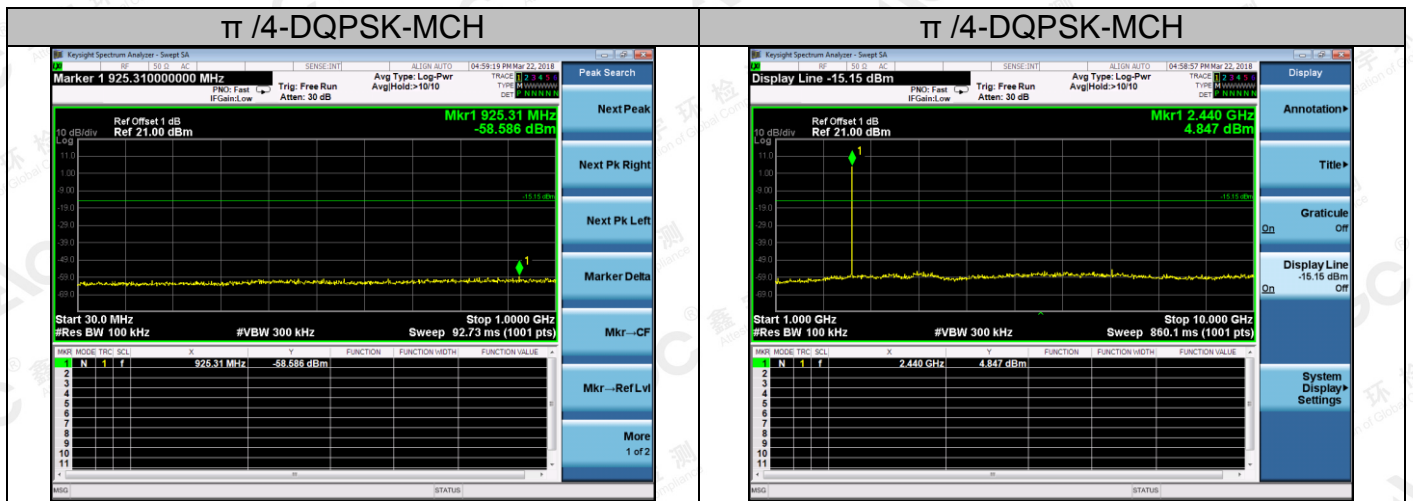

The results shown in this test report refer only to the sample(s) tested unless otherwise stated and the sample(s) are retained for 30 days only. The document is issued by AGC, this document cannot be reproduced except in full with our prior written permission. The more details and the authenticity of the report will be confirmed at <http://www.agc-cert.com>.



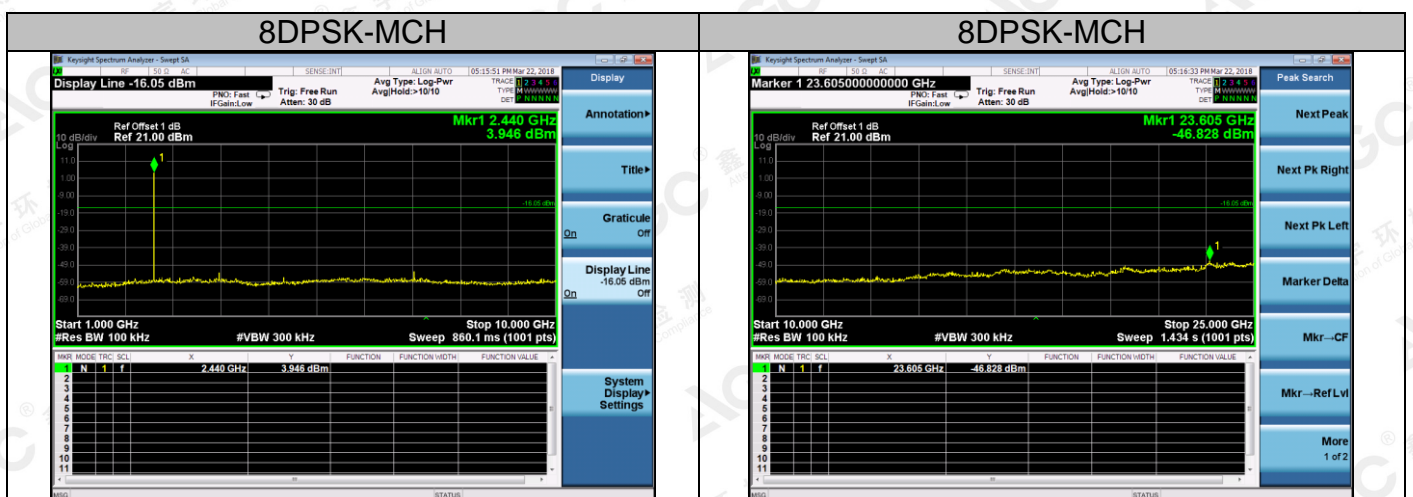
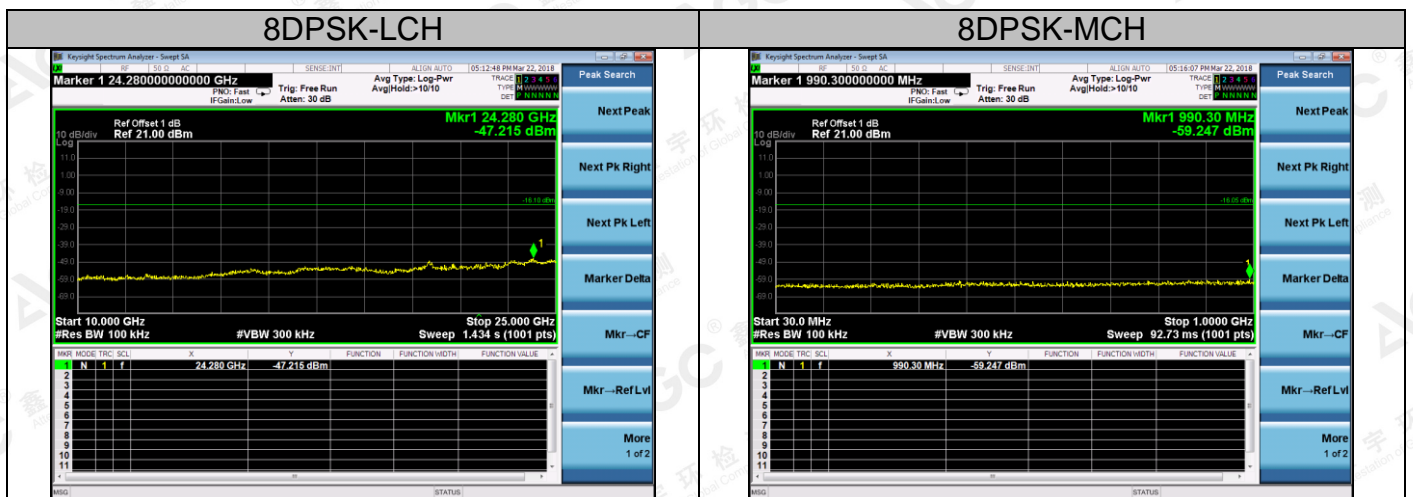
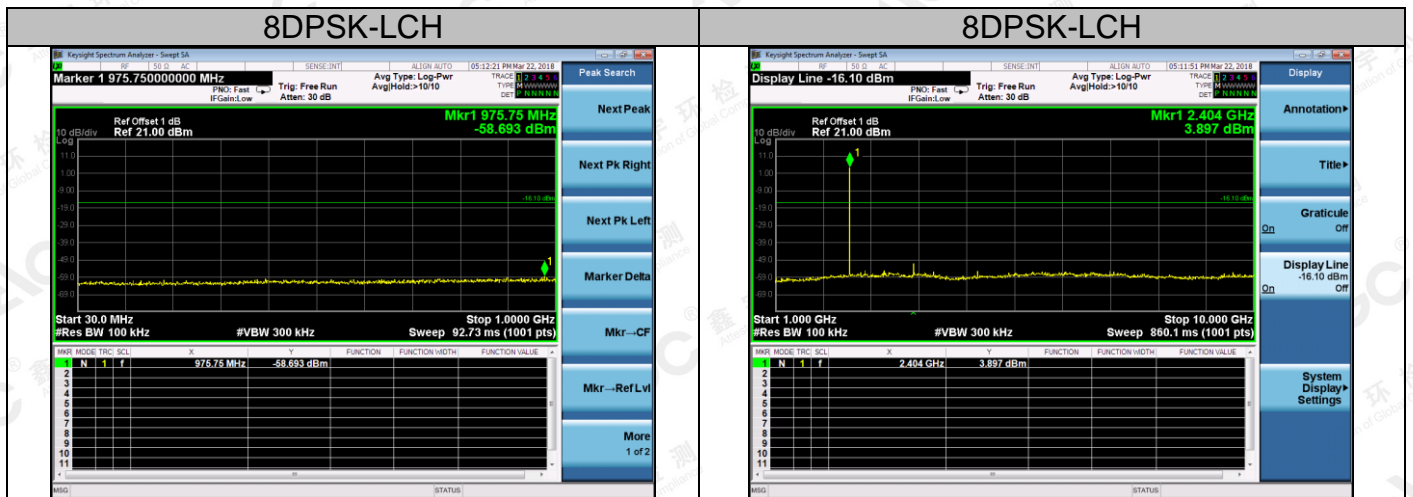

The results shown in this test report refer only to the sample(s) tested unless otherwise stated and the sample(s) are retained for 30 days only. The document is issued by AGC, this document cannot be reproduced except in full with our prior written permission. The more details and the authenticity of the report will be confirmed at <http://www.agc-cert.com>.