

A decorative horizontal bar chart consisting of numerous vertical bars of varying heights and colors (gray, light blue, and medium blue) arranged in a pattern that resembles a signal waveform or a stylized bar chart.

QUICK INSTRUCTION MANUAL

TM840, TM840G
DMR Mobile Radio

DIGITAL

<http://en.kirisun.com>

Quick User Guide

TM840, TM840G
DMR Mobile Radio

We are very grateful for your purchasing KIRISUN DMR Mobile Radio produced by Kirisun Communications Co., Ltd.

We believe KIRISUN DMR Mobile Radio, which always incorporates the latest technology, can bring great convenience to your life and work.

We also believe that the quality and function of KIRISUN DMR Mobile Radio can meet your demands for reliable communication.

1 Safety Information

- The government bans on operation the radio transmitter without permission in the jurisdiction scope. Illegal operation will punished with fine or arrest. This product can only be maintained by the professional technicians.
- Safety: It's very important for users to realize the generally dangerous of using the radio.
- Warning: Please turn off the radio when you are refueling in the explosive atmosphere (such as gas, dust and smog, etc.) or park at the gas station.

2 First Use

2.1 Unpacking and Checking

Please unpack carefully and check all the items listed in the following table before discarding the packing material. If any damage or loss occurs during shipment, please contact your dealer.

2.1.1 Standard Accessories

No.	Material	Quantity
1	Mobile	1
2	Hand Microphone	1
3	Fixed Bracket	1
4	Power Supply Line	1
5	Fuse	2
6	Microphone Hanger, with two ST4*16 tapping screws	1

7	Plastic handle screw, contain matching flat washer and spring washer	2
8	ST4.8*20 Self-tapping screws	6
9	Certificate of Approval	1
10	Quick User Guide	1

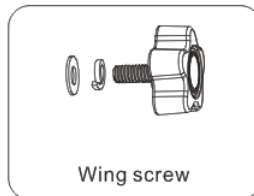
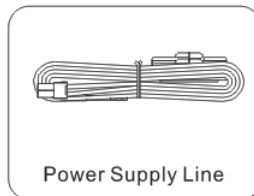
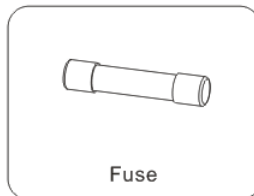
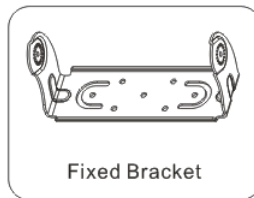
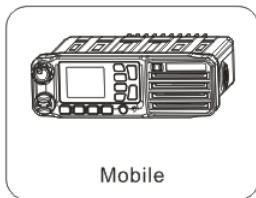

2.2 Preparing Your Mobile for Use

2.2.1 Installing your Mobile

1) Using six ST4.8*20 self-tapping self-drilling screws to fasten the bracket at the suitable place inside the vehicle.

2) Using two Plastic handle screw to fasten the mobile on the bracket.

3) Connect the Power Supply Cable

First, arrange the 5 meter power cable (First, find that if there is a hole on the thermal baffle can cross the power line. If there don't have one, please drill a hole use the suitable drill bit and put on rubber hole. Then let the power line through the thermal baffle into the engine compartment), and connect the engine battery or other power supply to the open end (the power supply can't exceed 16 Volt). Attention that the red line connect positive pole, the black line connect the negative pole. Put in the suitable protective tube (random provided, please apply the protective tube from the suppliers if you change it in the late, avoid causing other damage), put the plug insert the power interface socket at the tail of turn-table.

4) Connect the Antenna

5) Connect the hand Microphones

Install hand microphone

Put the direction indicative plane of the hand microphone plug on the top and insert it into the microphone interface of the mobile. Then clockwise rotate the self-lock cover on the microphone plug until the self-lock cover against the card slot. At this moment, please press down a little bit and continue rotate in clockwise until it can't be rotated.

Uninstall hand microphone

Anticlockwise rotate the self-lock cover on the hand microphone until you can't be rotated, then pull the plug out.

Install Microphone Hanger Clip

Using two ST4*16 tapping screw to install the microphone Hanger clip at the place where it is convenient for your use (the microphone and the microphone line should install at the place doesn't impact the safe drive), put the hand microphone hang on the microphone hanger.

3 Product Overview

3.1 Control Parts Introduction

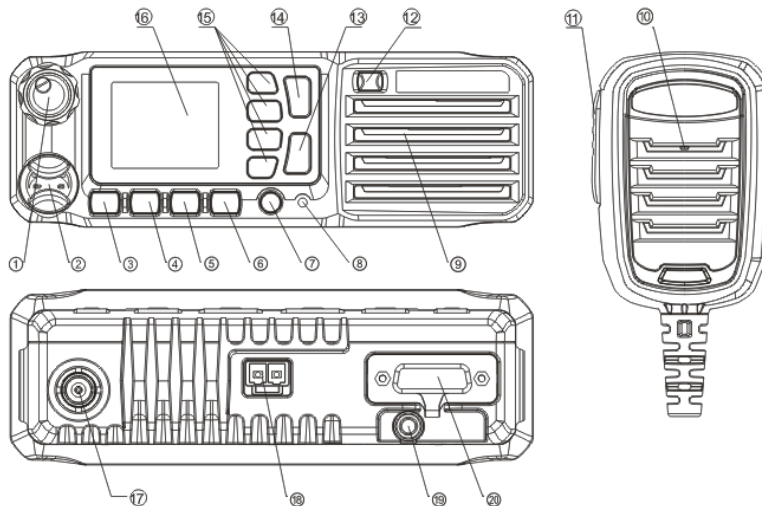

No.	Part Name	No.	Part Name
1	Volume Control Knob	11	PTT Key(Hand Microphone)
2	Microphone/Programming Cable Interface	12	Emergency Button
3	The Menu/Ok Button	13	Hook off Key
4	Up Key	14	Dial Key
5	Down Key	15	P1~P4 (Programmable Keys)
6	Return Button	16	LCD Display
7	On/Off Button	17	Antenna Connector
8	LED Indicator	18	Power Cable Connector
9	Speaker	19	GPS Antenna Connector
10	Microphone	20	26 Pin Connector

3.2 Programmable Buttons

For the convenience of users to operate the radio according to their own habits, the following buttons can be programmed as short cuts to radio functions by dealer.

P1 to P4 can be programmed to “long press” and short press.

Note :

Short Press : Pressing and releasing rapidly.

Long Press: Pressing and holding for the programmed duration. (This time can be set via the programming settings)

No.	Shortcut Keys	Description
1	None	No function. The error alert will be heard when the key pressed.
2	High/Low	Toggles power level between high and low.
3	Monitor	Press monitor key to enter to “carrier squelch” mode when the current channel is with CTC/DCS, thus the radio will unmute

		when receiving carrier.
4	Squelch Off	To always unmute the speaker no matter whether carrier is present or not. (Analog mode).
5	Squelch Level	Adjust the signal stress required for the radio to unmute.
6	Scan	Toggles scan on or off. To receive signal from other channels
7	LCD Brightness	Adjust the brightness level by entering to "LCD Brightness".
8	LCD Backlight Type	To adjust off time of LCD backlight in this option.
9	Repeater/Talkaround	Toggle between using a repeater and communicating directly with another radio.
10	Zone Selection	To change the current call zone.
11	Home Screen	To quickly return to the home screen.
12	Nuisance Delete	To temporarily ignore unwanted channel activity.
13	Scramble/Encryption	Toggles scramble/encryption on or off.
14	Contacts	Provides directly access to the contact list
15	Message	Selects the message menu. Only works on digital mode.

16	Call log	Selects the call log menu. Only valid in digital mode.
17	Monitor Channel	On/off monitor channel. Exit monitor channel function when pressing PTT.
18	Permanent Monitor Channel	On/off permanent monitor channel. Don't exit monitor channel function when pressing PTT.
19	Sending Interrupt	To interrupt other user to initiating a call at the current channel.
20	Public Address1	Allows the user to toggle the audio routing from incoming audio or radio microphone to the connected external public address (PA) speaker at rear port 1.
21	Public Address2	Allows the user to toggle the audio routing from incoming audio or radio microphone to the connected external public address (PA) speaker at rear port 2.
22	External Alarm/Speaker/Light	When the mobile received emergency call/alarm, call alert or private call and without operation during the programmed time, the valid level will output from GPIO. The level can drive the

		external alarm device (light or speaker) connected to GPIO to alarm.
--	--	--

4 Basic Operation

4.1 Powering On/Off the Radio









In the power off status, long press the Radio On-Off button  to power on the mobile. The power on screen will be shown, backlight will light and the power on alert will be heard.

In the power on status, long press Radio On-Off button  until power off screen is shown to power off the mobile.



4.2 Selecting a Zone

A Zone is a group of channels exhibiting the same property, allowing users quickly switch from a channel group to a different channel group. The radio can be set to have up to 248 zones, each with a maximum of 128 channels.

You may select a zone through the following way:

- 1) Press  key to enter the main menu in home screen.
- 2) Access to zone item by  or , then press  to select.
- 3) All the zones are listed here. The current zone is indicated by .
- 4) Press  or  key to required zone and press  to select.
- 5) This display shows "Zone Selected "and return to selected zone screen.

4.3 Selecting a Channel



Pressing  or  key to select channel on home screen.

4.4 Adjusting the Volume

After the radio power on, rotate the volume knob  clockwise to increase radio volume or counter-clockwise to decrease the volume.

4.5 Making a Call

You can initiate a call by following method.

When a call is initiated, the red LED lights on. The call type (private call icon , group call icon , alias or ID and outgoing call icon  is displayed on the LCD

4.5.1 Initiate a Call to the Default Contact

In the home screen, hold down the PTT key to initiate a call to the default contact which has been set for the current channel in CPS software. The contact can be set to private call, group call, or all call by CPS.

4.5.2 Selecting a Contact and Initiate a Call



You can also make a call via contacts. Enter contact list menu and select one specific contact, then hold down PTT to initiate a call.

4.5.3 Manual Dial and Initiate a Call

You can also make a call by "Manual Dial". Enter the "Contacts" menu and then enter "Manual Dial" sub-menu, directly enter contacts' ID number, and press PTT key to initiate a call.

4.6 Receiving and Answering the Call

When a call is received in the standby mode:

Green LED indicator lights on. The call type (private call icon , group call icon , alias or ID and incoming call icon  is displayed on the LCD.

You can hold down PTT to call back to current contact within the hang time duration.

Note:

To receive a group call, your radio must be configured as part of that group. (Dealer set it via CPS).





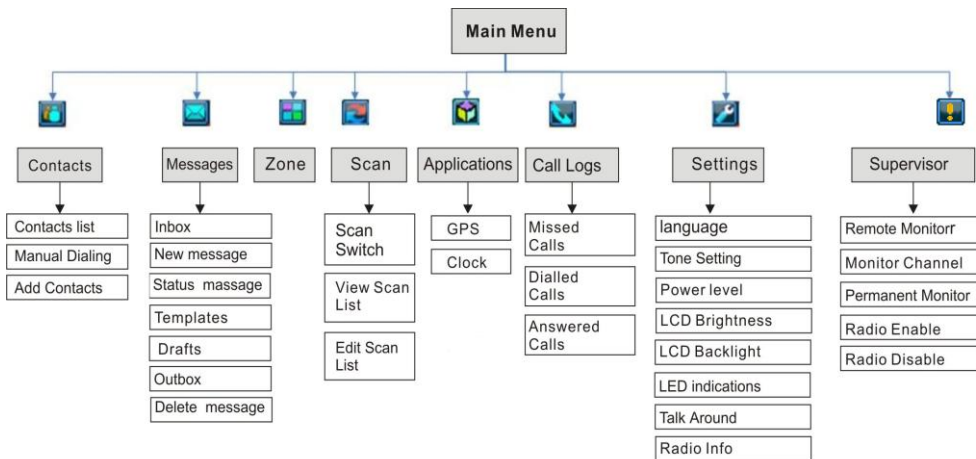

You cannot respond to an All Call.







5 Menu Bar



6 Status Indicator

6.1 LCD Icon

Icon Name	Icon	Radio Status
Signal Strength Indication		No signal The number of bars indicates the received signal strength. Four bars are the strongest.
Message		There is new message/unread message. Message inbox is full.
Encryption or Scrambling		Analog scrambling or digital encryption is available.
Speaker Mute		Speaker is muted.
Transmitting Power	 	High TX power for the current channel Low TX power for the current channel
Channel		Channel is being monitored

Monitoring		
Talk Around		Talk-around mode is active for repeater mode; or the current channel is direct mode.
Emergency Alarm		Emergency alarm mode
GPS feature		GPS feature is available and the radio is receiving valid GPS data. GPS feature is available, but the radio has not got valid location information.
Scan		Scanning is in process. Scanning stops on apriority channel 1 or apriority channel 2. Scanning stops on anon-priority channel.
Accessory Connecting Status		External MIC/Speaker is connected. USB cable is connected
Lone Work		Lone work function is enable

6.2 LED Indicator

LED Indicator	Radio Work Status
Red LED lights on	Radio is transmitting.
Green LED lights on	Radio is receiving (voice, short message, or data) or there is an activity on the channel.
Orange LED lights on	The radio is in the call hang time period, you can press PTT to talk back while the orange LED lights on.
Orange LED flashes	Radio is in emergency status; or there is a missed call / incoming call alert; or the radio is scanning.
Red LED flashes	Radio is receiving emergency alarm.

7 Maintenance and Cleaning

In order to derive optimum performance and long service life from this product, please read the following maintenance and cleaning information carefully for better daily care and clean.

7.1 Maintenance

Please do not puncture or scratch the mobile with hard objects.

Please make sure the mobile located at the good ventilation and good heat dissipation place for every components working normally.

Please do not put unrelated objects on top of mobile to make sure the efficient heat dissipation.

Please do not soak the mobile in all kinds of etchant, solution or water.

7.2 Cleaning

Please regular do the daily cleaning for the mobile. Wiping away the dust attached to the parts of mobile by using clean and dry lint free cloth or hairbrush, keep it clean and prevent bad contact.

If the key, control knob, display screen and interface became dirty, using non-woven fabrics dipped with neutral detergent to clean them. Don't use the strong corrosive chemicals like decontaminant,

alcohol, spray or oil preparations and so on. After cleaning, must ensure that the vehicle terminal completely dry, otherwise don't use it.

Note: Please turn off the power supply of the vehicle terminal before your cleaning.

FCC Statement

Any Changes or modifications not expressly approved by the party responsible for compliance could void the user's authority to operate the equipment.

This device complies with part 15 of the FCC Rules. Operation is subject to the following two conditions: (1) This device may not cause harmful interference, and (2) this device must accept any interference received, including interference that may cause undesired operation.

FCC Radiation Exposure Statement:

This equipment complies with FCC radiation exposure limits set forth for an uncontrolled environment. This equipment should be installed and operated with minimum distance 0.5m between the radiator& your body.

This transmitter must not be co-located or operating in conjunction with any other antenna or transmitter.

Note: This equipment has been tested and found to comply with the limits for a Class B digital device, pursuant to part 15 of the FCC Rules. These limits are designed to provide reasonable protection against harmful interference in a residential installation. This equipment generates uses and can radiate radio frequency energy and, if not installed and used in accordance with the instructions, may cause harmful interference to radio communications. However, there is no guarantee that interference will not occur in a particular installation. If this equipment does cause harmful interference to radio or television reception, which can be determined by turning the equipment off and on, the user is encouraged to try to correct the interference by one or more of the following measures:

- Reorient or relocate the receiving antenna.
- Increase the separation between the equipment and receiver.
- Connect the equipment into an outlet on a circuit different from that to which the receiver is connected.
- Consult the dealer or an experienced radio/TV technician for help.



Kirisun Communications Co.,Ltd.
<http://en.kirisun.com>