

TEST REPORT

For Bluetooth-EDR

Report No. : **CHTEW23100112** Report Verification: 

Project No..... : **SHT2309011206EW**

FCC ID..... : **Q5ETM2210H5**

Applicant's name..... : **Kirisun Communication Co.,Ltd.**

Address..... : 3rd Floor, Building A, Tongfang Information Harbour, No.11
Langshan Road, Nanshan District, Shenzhen 518057,
P.R.China

Product Name : **DMR Mobile Radio**

Trade Mark : TAIT

Model No. : TM2210-H5

Listed Model(s) : TM2210-H5-BNC, TM2210-H5-MUHF

Standard : **FCC CFR Title 47 Part 15 Subpart C § 15.247**

Date of receipt of test sample..... : Sep.13, 2023

Date of testing..... : Sep.18, 2023- Oct.27, 2023

Date of issue..... : Oct.31, 2023

Result..... : **PASS**

Compiled by File administrators Caspar Chen
 (Position+Printed name+Signature):



Supervised by Project Engineer Caspar Chen
 (Position+Printed name+Signature):



Approved by RF Manager Xu Yang
 (Position+Printed name+Signature):

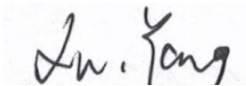

Testing Laboratory Name : Shenzhen Huatongwei International Inspection Co., Ltd.

Address..... : Building 7, Baiwang Idea Factory, No.1051, Songbai Road,
Yangguang Community, Xili Subdistrict, Nanshan District,
Shenzhen, Guangdong, China

Shenzhen Huatongwei International Inspection Co., Ltd. All rights reserved.

This publication may be reproduced in whole or in part for non-commercial purposes as long as the Shenzhen Huatongwei International Inspection Co., Ltd. is acknowledged as copyright owner and source of the material. Shenzhen Huatongwei International Inspection Co., Ltd. takes no responsibility for and will not assume liability for damages resulting from the reader's interpretation of the reproduced material due to its placement and context.

The test report merely correspond to the test sample.

Contents

1.	TEST STANDARDS AND REPORT VERSION	3
1.1.	Test Standards	3
1.2.	Report version	3
2.	TEST DESCRIPTION	4
3.	SUMMARY	5
3.1.	Client Information	5
3.2.	Product Description	5
3.3.	Radio Specification Description	5
3.4.	Testing Laboratory Information	6
4.	TEST CONFIGURATION	7
4.1.	Test frequency list	7
4.2.	Descriptions of Test mode	7
4.3.	Test mode	7
4.4.	Test sample information	8
4.5.	Support unit used in test configuration and system	8
4.6.	Testing environmental condition	8
4.7.	Statement of the measurement uncertainty	9
4.8.	Equipment Used during the Test	10
5.	TEST CONDITIONS AND RESULTS	11
5.1.	Antenna Requirement	11
5.2.	AC Conducted Emission	12
5.3.	Peak Output Power	13
5.4.	20 dB Bandwidth	17
5.5.	99% Occupied Bandwidth	21
5.6.	Carrier Frequencies Separation	22
5.7.	Hopping Channel Number	24
5.8.	Dwell Time	26
5.9.	Duty Cycle Correction Factor (DCCF)	33
5.10.	Pseudorandom Frequency Hopping Sequence	34
5.11.	Conducted Band edge and Spurious Emission	35
5.12.	Radiated Band edge Emission	51
5.13.	Radiated Spurious Emission	53
6.	TEST SETUP PHOTOS	58
7.	EXTERNAL AND INTERNAL PHOTOS	60
8.	APPENDIX REPORT	60

1. TEST STANDARDS AND REPORT VERSION

1.1. Test Standards

The tests were performed according to following standards:

- [FCC CFR Title 47 Part 15 Subpart C § 15.247](#): Operation within the bands 902-928 MHz, 2400-2483.5 MHz, and 5725-5850 MHz
- [ANSI C63.10:2020](#): American National Standard for Testing Unlicensed Wireless Devices
- [KDB 558074 D01 15.247 Meas Guidance v05r02](#): Guidance for Compliance Measurements on Digital Transmission System, Frequency Hopping Spread Spectrum System, and Hybrid System Devices Operating under Section 15.247 of The FCC Rules

1.2. Report version

Revision No.	Date of issue	Description
N/A	2023-10-31	Original

2. TEST DESCRIPTION

Report clause	Test Items	Standard Requirement	Result	Test Engineer
5.1	Antenna Requirement	15.203/15.247 (c)	PASS	Caspar Chen
5.2	AC Conducted Emission	15.207	N/A	N/A
5.3	Peak Output Power	15.247 (b)(1)	PASS	Caspar Chen
5.4	20 dB Bandwidth	15.247 (a)(1)	PASS	Caspar Chen
5.5	99% Occupied Bandwidth ^{*1}	-	N/A	N/A
5.6	Carrier Frequency Separation	15.247 (a)(1)	PASS	Caspar Chen
5.7	Hopping Channel Number	15.247 (a)(1)	PASS	Caspar Chen
5.8	Dwell Time	15.247 (a)(1)	PASS	Caspar Chen
5.9	Duty Cycle Correction Factor ^{*1}	-	N/A	N/A
5.10	Pseudorandom Frequency Hopping Sequence	15.247(b)(4)	PASS	Caspar Chen
5.11	Conducted Band Edge and Spurious Emission	15.247(d)/15.205	PASS	Caspar Chen
5.12	Radiated Band Edge Emission	15.205/15.209	PASS	Yifan Wang
5.13	Radiated Spurious Emission	15.247(d)/15.205/15.209	PASS	Yifan Wang

Note:

- The measurement uncertainty is not included in the test result.
- *1: No requirement on standard.
- N/A: Not Applicable

3. SUMMARY

3.1. Client Information

Applicant:	Kirisun Communication Co.,Ltd.
Address:	3rd Floor, Building A, Tongfang Information Harbour, No.11 Langshan Road, Nanshan District, Shenzhen 518057, P.R.China
Manufacturer:	Kirisun Communication Co.,Ltd.
Address:	3rd Floor, Building A, Tongfang Information Harbour, No.11 Langshan Road, Nanshan District, Shenzhen 518057, P.R.China

3.2. Product Description

Main unit information:	
Product Name:	DMR Mobile Radio
Trade Mark:	TAIT
Model No.:	TM2210-H5
Listed Model(s):	TM2210-H5-BNC, TM2210-H5-MUHF
Power supply:	DC 13.8V
Hardware version:	V19.01.144200200
Software version:	V5.3.6.12

3.3. Radio Specification Description

Bluetooth version:	V5.0
Support function:	EDR
Modulation:	GFSK, $\pi/4$ DQPSK, 8DPSK
Operation frequency:	2402MHz~2480MHz
Channel number:	79
Channel separation:	1MHz
Antenna type:	$\lambda/4$ Antenna
Antenna gain:	2 dBi

3.4. Testing Laboratory Information

Laboratory Name	Shenzhen Huatongwei International Inspection Co., Ltd.	
Laboratory Location	Building 7, Baiwang Idea Factory, No.1051, Songbai Road, Yangguang Community, Xili Subdistrict, Nanshan District, Shenzhen, Guangdong, China	
Connect information:	Tel: 86-755-26715499 E-mail: cs@szhtw.com.cn http://www.szhtw.com.cn	
Qualifications	Type	Accreditation Number
	FCC Registration Number	762235
	FCC Designation Number	CN1181

4. TEST CONFIGURATION

4.1. Test frequency list

According to section 15.31(m), regards to the operating frequency range over 10 MHz, must select three channels which were tested. The Lowest frequency, the middle frequency, and the highest frequency of channel were selected to perform the test, please see the below blue front.

Channel	Frequency (MHz)
00	2402
01	2403
⋮	⋮
39	2441
⋮	⋮
77	2479
78	2480

4.2. Descriptions of Test mode

Preliminary tests were performed in different data rates and recorded the RF output power in the clause 5.3

Note:

- 1) The manufacturer declare that the maximum power value of the product is set as a default value in the enter test mode software.
- 2) All the test data for each data rate were verified, found GFSK Modulation which is worse case mode

4.3. Test mode

For RF test items:			
The engineering test program was provided and enabled to make EUT continuous transmitting.			
Test Item	Modulation / Data Rate		
	GFSK 1Mbps	$\pi/4$ DQPSK 2Mbps	8DPSK 3Mbps
Conducted test item	✓	✓	✓
Radiated test item	✓	-	-
Remark:			
<ul style="list-style-type: none"> – For radiated test item, the worst mode data rate 1Mbps was reported only, because this data rate has the highest RF output power at preliminary tests. – The EUT in each of three orthogonal axis emissions had been tested, but only the worst case (X axis) data recorded in the report. 			

4.4. Test sample information

Test item	HTW sample no.
RF Conducted test items	Refer to the description in the appendix report
RF Radiated test items	YPHT23090112001
EMI test items	-

Note:

RF Conducted test items: Peak Output Power, 20 dB Bandwidth, 99% Occupied Bandwidth, Carrier Frequency Separation, Hopping Channel Number, Dwell Time, Duty Cycle Correction Factor, Pseudorandom Frequency Hopping Sequence, Conducted Band Edge and Spurious Emission

RF Radiated test items: Radiated Band Edge Emission, Radiated Spurious Emission

EMI test items: AC Conducted Emission

4.5. Support unit used in test configuration and system

The EUT has been associated with peripherals and configuration operated in a manner tended to maximize its emission characteristics in a typical application.

The following peripheral devices and interface cables were connected during the measurement:

Whether support unit is used?			
✓ No			
Item	Equipment	Trade Name	Model No.
1			
2			

4.6. Testing environmental condition

Type	Requirement	Actual
Temperature:	15~35°C	25°C
Relative Humidity:	25~75%	50%
Air Pressure:	860~1060mbar	1000mbar

4.7. Statement of the measurement uncertainty

No.	Test Items	Measurement Uncertainty
1	AC Conducted Emission	3.21dB
2	Peak Output Power	1.07
3	Power Spectral Density	1.07
4	6dB Bandwidth	0.002%
5	99% Occupied Bandwidth	0.002%
6	Duty cycle	-
7	Conducted Band Edge and Spurious Emission	1.68dB
8	Radiated Band Edge Emission	4.54dB for 30MHz-1GHz 5.10dB for above 1GHz
9	Radiated Spurious Emission	4.54dB for 30MHz-1GHz 5.10dB for above 1GHz

This uncertainty represents an expanded uncertainty expressed at approximately the 95% confidence level using a coverage factor of $k=1.96$.

4.8. Equipment Used during the Test

● RF Conducted test item							
Used	Test Equipment	Manufacturer	Equipment No.	Model No.	Serial No.	Last Cal. Date (YY-MM-DD)	Next Cal. Date (YY-MM-DD)
●	Signal and spectrum Analyzer	R&S	HTWE0242	FSV40	100048	2023/08/22	2024/08/21
●	Signal & Spectrum Analyzer	R&S	HTWE0262	FSW26	103440	2023/08/22	2024/08/21
●	Vector signal generator	R&S	HTWE0244	SMBV100A	260790	2023/05/23	2024/05/22
●	Test software	Tonscend	N/A	JS1120	N/A	N/A	N/A

● Radiated Emission – 9kHz~30MHz							
Used	Test Equipment	Manufacturer	Equipment No.	Model No.	Serial No.	Last Cal. Date (YY-MM-DD)	Next Cal. Date (YY-MM-DD)
●	Semi-Anechoic Chamber	Albatross projects	HTWE0127	SAC-3m-02	C11121	2023/4/6	2026/4/5
●	EMI Test Receiver	R&S	HTWE0099	ESCI 7	100900	2023/8/22	2024/8/21
●	Loop Antenna	R&S	HTWE0170	HFH2-Z2	100020	2021/4/6	2024/4/5
●	Test Software	R&S	N/A	EMC32	N/A	N/A	N/A

● Radiated Emission - 30MHz~1GHz							
Used	Test Equipment	Manufacturer	Equipment No.	Model No.	Serial No.	Last Cal. Date (YY-MM-DD)	Next Cal. Date (YY-MM-DD)
●	Semi-Anechoic Chamber	Albatross projects	HTWE0127	SAC-3m-02	C11121	2023/4/6	2026/4/5
●	EMI Test Receiver	R&S	HTWE0099	ESCI 7	100900	2023/8/22	2024/8/21
●	Ultra-Broadband Antenna	SCHWARZBEC K	HTWE0119	VULB9163	546	2023/2/22	2026/2/21
●	Pre-Amplifier	SCHWARZBEC K	HTWE0295	BBV 9742	/	2023/5/25	2024/5/24
●	Test Software	R&S	N/A	EMC32	N/A	N/A	N/A

● Radiated emission-Above 1GHz							
Used	Test Equipment	Manufacturer	Equipment No.	Model No.	Serial No.	Last Cal. Date (YY-MM-DD)	Next Cal. Date (YY-MM-DD)
●	Semi-Anechoic Chamber	Albatross projects	HTWE0122	SAC-3m-01	C11121	2023/4/17	2026/4/16
●	Spectrum Analyzer	R&S	HTWE0098	FSP40	100597	2023/8/22	2024/8/21
●	Horn Antenna	SCHWARZBE CK	HTWE0126	BBHA 9120D	1011	2023/2/14	2026/2/13
●	Horn Antenna	SCHWARZBE CK	HTWE0103	BBHA9170	BBHA9170472	2023/2/20	2026/2/19
●	Broadband Pre-amplifier	SCHWARZBE CK	HTWE0201	BBV 9718	9718-248	2023/5/25	2024/5/24
●	Test Software	R&S	N/A	EMC32	N/A	N/A	N/A

5. TEST CONDITIONS AND RESULTS

5.1. Antenna Requirement

REQUIREMENT

FCC CFR Title 47 Part 15 Subpart C Section 15.203:

An intentional radiator shall be designed to ensure that no antenna other than that furnished by the responsible party shall be used with the device. The use of a permanently attached antenna or of an antenna that uses a unique coupling to the intentional radiator, the manufacturer may design the unit so that a broken antenna can be replaced by the user, but the use of a standard antenna jack or electrical connector is prohibited.

TEST RESULT

Passed **Not Applicable**

The antenna type is a $\lambda/4$ Antenna, please refer to the below antenna photo.

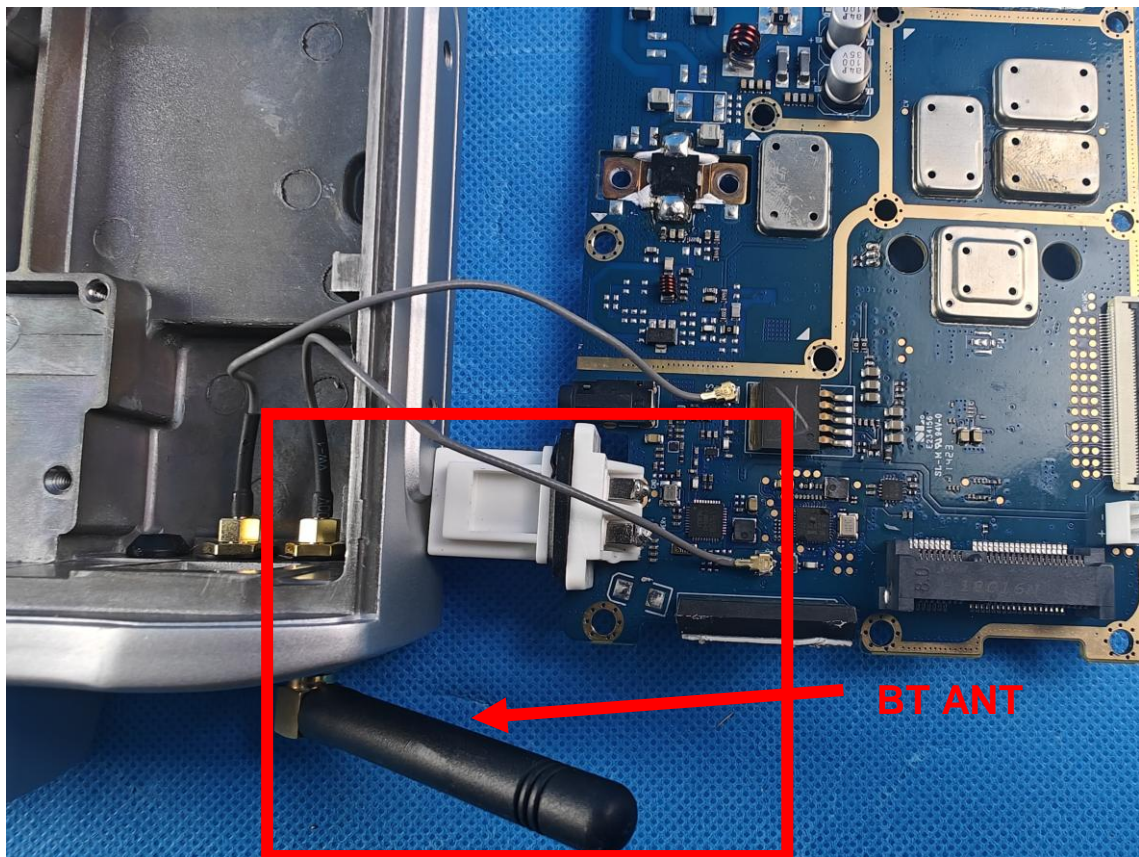

5.2. AC Conducted Emission

LIMIT

FCC CFR Title 47 Part 15 Subpart C Section 15.207

Frequency range (MHz)	Limit (dBuV)	
	Quasi-peak	Average
0.15-0.5	66 to 56*	56 to 46*
0.5-5	56	46
5-30	60	50

* Decreases with the logarithm of the frequency.

TEST CONFIGURATION

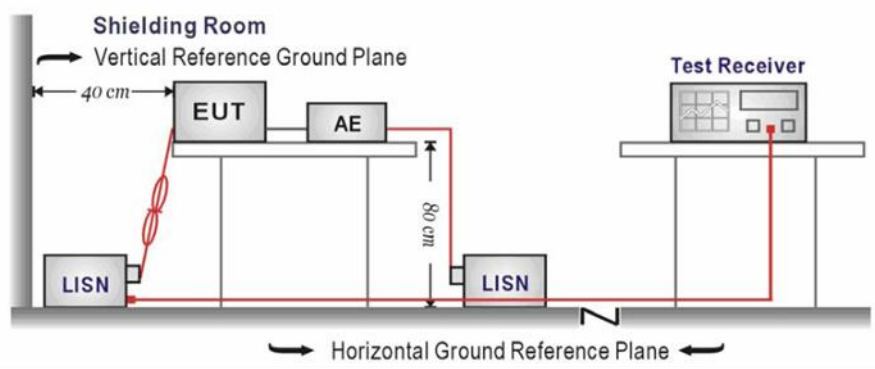

TEST PROCEDURE

1. The EUT was setup according to ANSI C63.10 requirements.
2. The EUT was placed on a platform of nominal size, 1 m by 1.5 m, raised 80 cm above the conducting ground plane. The vertical conducting plane was located 40 cm to the rear of the EUT. All other surfaces of EUT were at least 80 cm from any other grounded conducting surface.
3. The EUT and simulators are connected to the main power through a line impedances stabilization network (LISN). The LISN provides a 50 ohm /50uH coupling impedance for the measuring equipment.
4. The peripheral devices are also connected to the main power through a LISN. (Refer to the block diagram of the test setup and photographs)
5. Each current-carrying conductor of the EUT power cord, except the ground (safety) conductor, was individually connected through a LISN to the input power source.
6. The excess length of the power cord between the EUT and the LISN receptacle were folded back and forth at the center of the lead to form a bundle not exceeding 40 cm in length.
7. Conducted emissions were investigated over the frequency range from 0.15MHz to 30MHz using a receiver bandwidth of 9 kHz.
8. During the above scans, the emissions were maximized by cable manipulation.

TEST MODE

Refer to the clause 4.3

TEST RESULT

Passed Not Applicable

5.3. Peak Output Power

LIMIT

FCC CFR Title 47 Part 15 Subpart C Section 15.247 (b)(1):

For frequency hopping systems operating in the 2400-2483.5 MHz band employing at least 75 non-overlapping hopping channels, and all frequency hopping systems in the 5725-5850 MHz band: 1 watt.
For all other frequency hopping systems in the 2400-2483.5 MHz band: 0.125 watts.

TEST CONFIGURATION

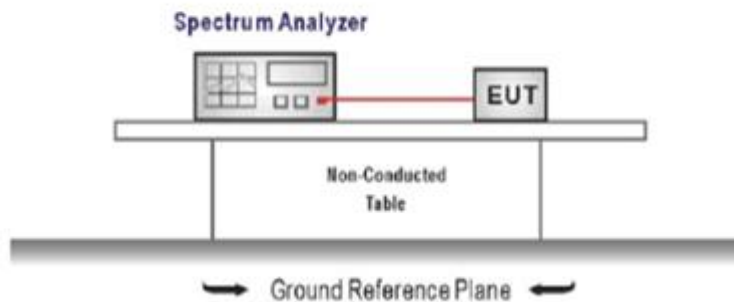

TEST PROCEDURE

1. The transmitter output was connected to the spectrum analyzer through an attenuator, the pathloss was compensated to the results for each measurement.
2. Set to the maximum power setting and enable the EUT transmit continuously
3. Use the following spectrum analyzer settings:
Span = approximately 5 times the 20 dB bandwidth, centered on a hopping channel
RBW \geq the 20 dB bandwidth of the emission being measured, VBW \geq RBW
Sweep = auto, Detector function = peak, Trace = max hold
4. Measure and record the results in the test report.

TEST MODE

Refer to the clause 4.3

TEST RESULT

Passed Not Applicable

Modulation type	Channel	Output power (dBm)	Limit (dBm)	Result
GFSK	00	6.14	≤ 30.00	Pass
	39	6.88		
	78	7.75		
$\pi/4$ DQPSK	00	4.95	≤ 21.00	Pass
	39	6.15		
	78	6.53		
8DPSK	00	5.18	≤ 21.00	Pass
	39	6.28		
	78	6.53		

Modulation Type: GFSK	
CH00	<p>Spectrum plot for CH00. The plot shows a signal with a peak at 6.14 dBm and a center frequency of 2.40207240 GHz. The y-axis represents power in dBm, ranging from -70 to 10. The x-axis represents frequency in GHz, with a span of 5.0 MHz. The plot includes a peak marker M1[1] and a peak value of 6.14 dBm. The center frequency is 2.40207240 GHz. The plot also shows a reference level of 20.00 dBm, an offset of 1.00 dB, a resolution bandwidth (RBW) of 1 MHz, an attenuation (Att) of 30 dB, a sweep time (SWT) of 1 ms, a video bandwidth (VBW) of 3 MHz, and a mode of Auto Sweep. The count is 500/500. The plot is titled 'Spectrum' and '1Pk View'.</p>
CH39	<p>Spectrum plot for CH39. The plot shows a signal with a peak at 6.88 dBm and a center frequency of 2.44071780 GHz. The y-axis represents power in dBm, ranging from -70 to 10. The x-axis represents frequency in GHz, with a span of 5.0 MHz. The plot includes a peak marker M1[1] and a peak value of 6.88 dBm. The center frequency is 2.44071780 GHz. The plot also shows a reference level of 20.00 dBm, an offset of 1.00 dB, a resolution bandwidth (RBW) of 1 MHz, an attenuation (Att) of 30 dB, a sweep time (SWT) of 1 ms, a video bandwidth (VBW) of 3 MHz, and a mode of Auto Sweep. The count is 500/500. The plot is titled 'Spectrum' and '1Pk View'.</p>
CH78	<p>Spectrum plot for CH78. The plot shows a signal with a peak at 7.75 dBm and a center frequency of 2.47973950 GHz. The y-axis represents power in dBm, ranging from -70 to 10. The x-axis represents frequency in GHz, with a span of 5.0 MHz. The plot includes a peak marker M1[1] and a peak value of 7.75 dBm. The center frequency is 2.47973950 GHz. The plot also shows a reference level of 20.00 dBm, an offset of 1.00 dB, a resolution bandwidth (RBW) of 1 MHz, an attenuation (Att) of 30 dB, a sweep time (SWT) of 1 ms, a video bandwidth (VBW) of 3 MHz, and a mode of Auto Sweep. The count is 500/500. The plot is titled 'Spectrum' and '1Pk View'.</p>

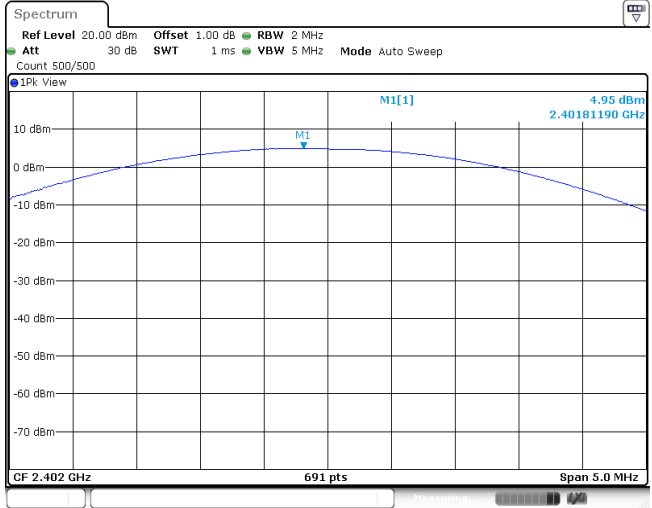
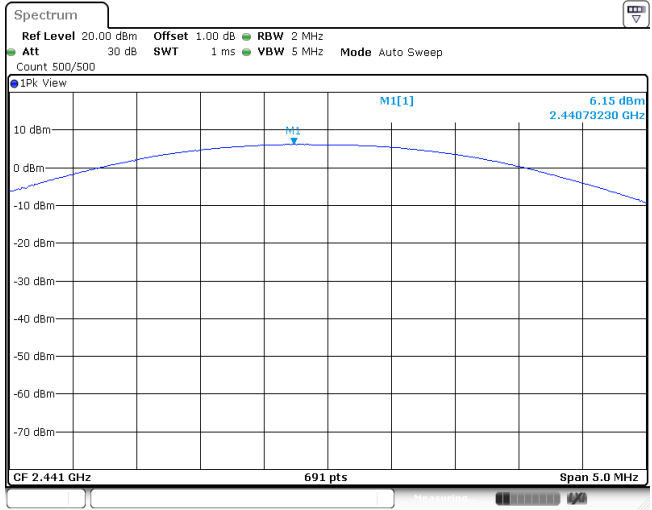
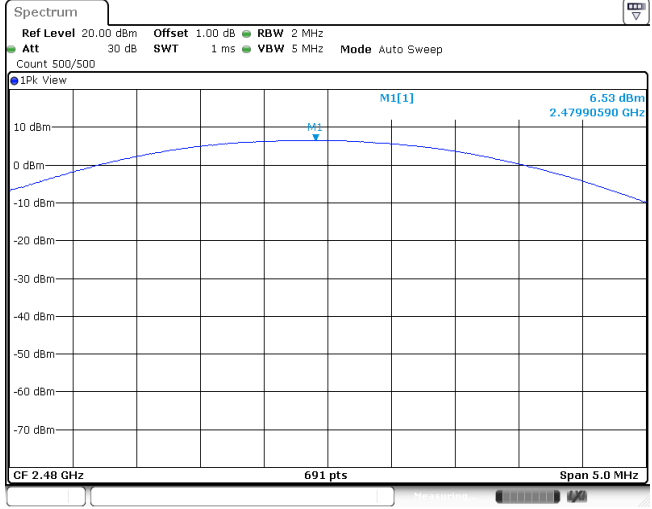
Modulation Type: $\pi/4$ DQPSK	
CH00	
CH39	
CH78	

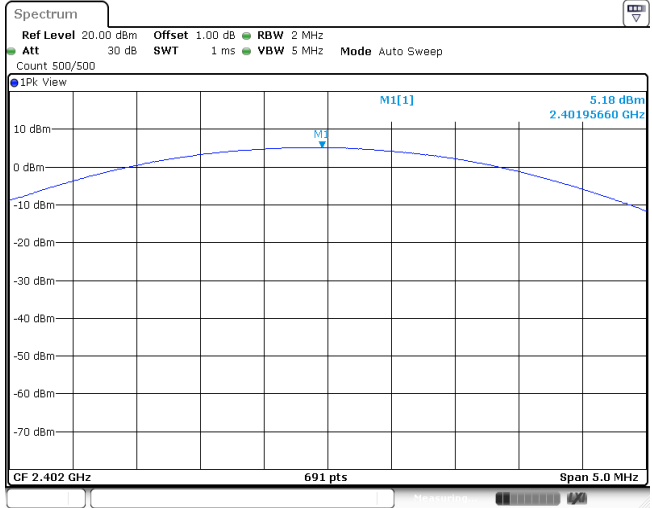
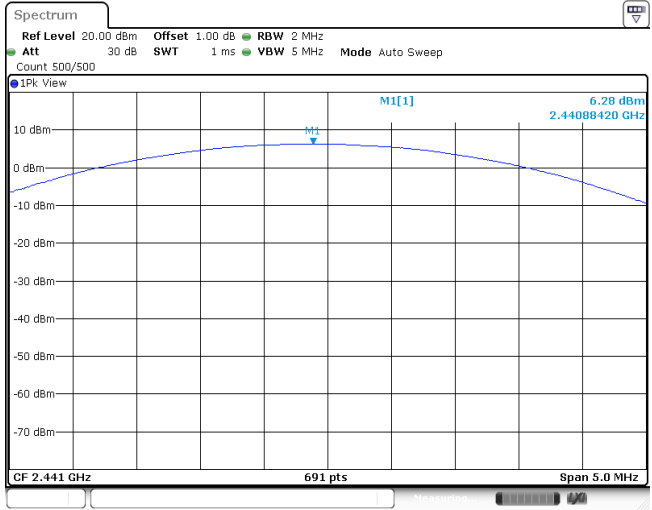
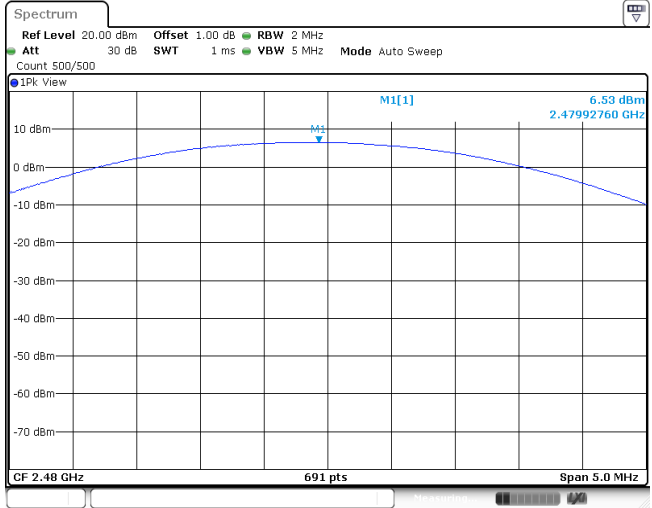
Modulation Type: 8DPSK	
CH00	
CH39	
CH78	

5.4. 20 dB Bandwidth

LIMIT

N/A

TEST CONFIGURATION

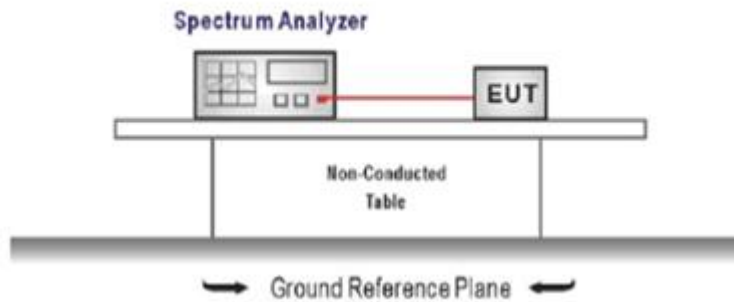

TEST PROCEDURE

1. The transmitter output was connected to the spectrum analyzer through an attenuator, the path loss was compensated to the results for each measurement.
2. Set to the maximum power setting and enable the EUT transmit continuously
3. Use the following spectrum analyzer settings:
Span = approximately 2 to 3 times the 20 dB bandwidth, centered on a hopping channel
RBW \geq 1% of the 20 dB bandwidth, VBW \geq RBW
Sweep = auto, Detector function = peak, Trace = max hold
4. Measure and record the results in the test report.

TEST MODE

Refer to the clause 4.3

TEST RESULT

Passed Not Applicable

Modulation type	Channel	20 dB Bandwidth (MHz)	Limit (MHz)	Result
GFSK	00	0.93	-	Pass
	39	0.93		
	78	0.93		
$\pi/4$ DQPSK	00	1.24	-	Pass
	39	1.24		
	78	1.25		
8DPSK	00	1.26	-	Pass
	39	1.26		
	78	1.26		

Modulation Type:		GFSK																												
CH00	<p>Spectrum Ref Level 20.00 dBm Offset 1.00 dB RBW 10 kHz Att 30 dB SWT 189.6 μs VBW 30 kHz Mode Auto FFT Count 500/500 1Pk View</p> <table border="1"> <thead> <tr> <th>Type</th> <th>Ref</th> <th>Trc</th> <th>X-value</th> <th>Y-value</th> <th>Function</th> <th>Function Result</th> </tr> </thead> <tbody> <tr> <td>M1</td> <td>1</td> <td></td> <td>2.40146 GHz</td> <td>-19.84 dBm</td> <td></td> <td></td> </tr> <tr> <td>M2</td> <td>1</td> <td></td> <td>2.4019675 GHz</td> <td>0.40 dBm</td> <td></td> <td></td> </tr> <tr> <td>D3</td> <td>M1</td> <td>1</td> <td>925.0 kHz</td> <td>-0.88 dB</td> <td></td> <td></td> </tr> </tbody> </table> <p>CF 2.402 GHz 1001 pts Span 2.5 MHz</p>		Type	Ref	Trc	X-value	Y-value	Function	Function Result	M1	1		2.40146 GHz	-19.84 dBm			M2	1		2.4019675 GHz	0.40 dBm			D3	M1	1	925.0 kHz	-0.88 dB		
Type	Ref	Trc	X-value	Y-value	Function	Function Result																								
M1	1		2.40146 GHz	-19.84 dBm																										
M2	1		2.4019675 GHz	0.40 dBm																										
D3	M1	1	925.0 kHz	-0.88 dB																										
CH39	<p>Spectrum Ref Level 20.00 dBm Offset 1.00 dB RBW 10 kHz Att 30 dB SWT 189.6 μs VBW 30 kHz Mode Auto FFT Count 500/500 1Pk View</p> <table border="1"> <thead> <tr> <th>Type</th> <th>Ref</th> <th>Trc</th> <th>X-value</th> <th>Y-value</th> <th>Function</th> <th>Function Result</th> </tr> </thead> <tbody> <tr> <td>M1</td> <td>1</td> <td></td> <td>2.440455 GHz</td> <td>-19.41 dBm</td> <td></td> <td></td> </tr> <tr> <td>M2</td> <td>1</td> <td></td> <td>2.440965 GHz</td> <td>1.14 dBm</td> <td></td> <td></td> </tr> <tr> <td>D3</td> <td>M1</td> <td>1</td> <td>925.0 kHz</td> <td>0.38 dB</td> <td></td> <td></td> </tr> </tbody> </table> <p>CF 2.441 GHz 1001 pts Span 2.5 MHz</p>		Type	Ref	Trc	X-value	Y-value	Function	Function Result	M1	1		2.440455 GHz	-19.41 dBm			M2	1		2.440965 GHz	1.14 dBm			D3	M1	1	925.0 kHz	0.38 dB		
Type	Ref	Trc	X-value	Y-value	Function	Function Result																								
M1	1		2.440455 GHz	-19.41 dBm																										
M2	1		2.440965 GHz	1.14 dBm																										
D3	M1	1	925.0 kHz	0.38 dB																										
CH78	<p>Spectrum Ref Level 20.00 dBm Offset 1.00 dB RBW 10 kHz Att 30 dB SWT 189.6 μs VBW 30 kHz Mode Auto FFT Count 500/500 1Pk View</p> <table border="1"> <thead> <tr> <th>Type</th> <th>Ref</th> <th>Trc</th> <th>X-value</th> <th>Y-value</th> <th>Function</th> <th>Function Result</th> </tr> </thead> <tbody> <tr> <td>M1</td> <td>1</td> <td></td> <td>2.479455 GHz</td> <td>-18.31 dBm</td> <td></td> <td></td> </tr> <tr> <td>M2</td> <td>1</td> <td></td> <td>2.4799625 GHz</td> <td>2.07 dBm</td> <td></td> <td></td> </tr> <tr> <td>D3</td> <td>M1</td> <td>1</td> <td>925.0 kHz</td> <td>-0.62 dB</td> <td></td> <td></td> </tr> </tbody> </table> <p>CF 2.48 GHz 1001 pts Span 2.5 MHz</p>		Type	Ref	Trc	X-value	Y-value	Function	Function Result	M1	1		2.479455 GHz	-18.31 dBm			M2	1		2.4799625 GHz	2.07 dBm			D3	M1	1	925.0 kHz	-0.62 dB		
Type	Ref	Trc	X-value	Y-value	Function	Function Result																								
M1	1		2.479455 GHz	-18.31 dBm																										
M2	1		2.4799625 GHz	2.07 dBm																										
D3	M1	1	925.0 kHz	-0.62 dB																										

Modulation Type:		$\pi/4$ DQPSK																												
CH00	<p>Spectrum Ref Level 20.00 dBm Offset 1.00 dB RBW 30 kHz Att 30 dB SWT 63.1 μs VBW 100 kHz Mode Auto FFT Count 500/500</p> <p>1Pk View</p> <table border="1"> <thead> <tr> <th>Type</th> <th>Ref</th> <th>Trc</th> <th>X-value</th> <th>Y-value</th> <th>Function</th> <th>Function Result</th> </tr> </thead> <tbody> <tr> <td>M1</td> <td>1</td> <td></td> <td>2.4012825 GHz</td> <td>-17.90 dBm</td> <td></td> <td></td> </tr> <tr> <td>M2</td> <td>1</td> <td></td> <td>2.4019175 GHz</td> <td>2.64 dBm</td> <td></td> <td></td> </tr> <tr> <td>D3</td> <td>M1</td> <td>1</td> <td>1.24 MHz</td> <td>0.37 dB</td> <td></td> <td></td> </tr> </tbody> </table> <p>CF 2.402 GHz 1001 pts Span 2.5 MHz</p>		Type	Ref	Trc	X-value	Y-value	Function	Function Result	M1	1		2.4012825 GHz	-17.90 dBm			M2	1		2.4019175 GHz	2.64 dBm			D3	M1	1	1.24 MHz	0.37 dB		
Type	Ref	Trc	X-value	Y-value	Function	Function Result																								
M1	1		2.4012825 GHz	-17.90 dBm																										
M2	1		2.4019175 GHz	2.64 dBm																										
D3	M1	1	1.24 MHz	0.37 dB																										
CH39	<p>Spectrum Ref Level 20.00 dBm Offset 1.00 dB RBW 30 kHz Att 30 dB SWT 63.1 μs VBW 100 kHz Mode Auto FFT Count 500/500</p> <p>1Pk View</p> <table border="1"> <thead> <tr> <th>Type</th> <th>Ref</th> <th>Trc</th> <th>X-value</th> <th>Y-value</th> <th>Function</th> <th>Function Result</th> </tr> </thead> <tbody> <tr> <td>M1</td> <td>1</td> <td></td> <td>2.44028 GHz</td> <td>-15.81 dBm</td> <td></td> <td></td> </tr> <tr> <td>M2</td> <td>1</td> <td></td> <td>2.440915 GHz</td> <td>4.35 dBm</td> <td></td> <td></td> </tr> <tr> <td>D3</td> <td>M1</td> <td>1</td> <td>1.2425 MHz</td> <td>0.11 dB</td> <td></td> <td></td> </tr> </tbody> </table> <p>CF 2.441 GHz 1001 pts Span 2.5 MHz</p>		Type	Ref	Trc	X-value	Y-value	Function	Function Result	M1	1		2.44028 GHz	-15.81 dBm			M2	1		2.440915 GHz	4.35 dBm			D3	M1	1	1.2425 MHz	0.11 dB		
Type	Ref	Trc	X-value	Y-value	Function	Function Result																								
M1	1		2.44028 GHz	-15.81 dBm																										
M2	1		2.440915 GHz	4.35 dBm																										
D3	M1	1	1.2425 MHz	0.11 dB																										
CH78	<p>Spectrum Ref Level 20.00 dBm Offset 1.00 dB RBW 30 kHz Att 30 dB SWT 63.1 μs VBW 100 kHz Mode Auto FFT Count 500/500</p> <p>1Pk View</p> <table border="1"> <thead> <tr> <th>Type</th> <th>Ref</th> <th>Trc</th> <th>X-value</th> <th>Y-value</th> <th>Function</th> <th>Function Result</th> </tr> </thead> <tbody> <tr> <td>M1</td> <td>1</td> <td></td> <td>2.4792775 GHz</td> <td>-14.72 dBm</td> <td></td> <td></td> </tr> <tr> <td>M2</td> <td>1</td> <td></td> <td>2.4799125 GHz</td> <td>5.57 dBm</td> <td></td> <td></td> </tr> <tr> <td>D3</td> <td>M1</td> <td>1</td> <td>1.25 MHz</td> <td>0.12 dB</td> <td></td> <td></td> </tr> </tbody> </table> <p>CF 2.48 GHz 1001 pts Span 2.5 MHz</p>		Type	Ref	Trc	X-value	Y-value	Function	Function Result	M1	1		2.4792775 GHz	-14.72 dBm			M2	1		2.4799125 GHz	5.57 dBm			D3	M1	1	1.25 MHz	0.12 dB		
Type	Ref	Trc	X-value	Y-value	Function	Function Result																								
M1	1		2.4792775 GHz	-14.72 dBm																										
M2	1		2.4799125 GHz	5.57 dBm																										
D3	M1	1	1.25 MHz	0.12 dB																										

Modulation Type:		8DPSK																												
CH00	<p>Ref Level 20.00 dBm Offset 1.00 dB RBW 30 kHz Att 30 dB SWT 63.1 μs VBW 100 kHz Mode Auto FFT Count 500/500</p> <p>CF 2.402 GHz 1001 pts Span 2.5 MHz</p> <table border="1"> <thead> <tr> <th>Type</th> <th>Ref</th> <th>Trc</th> <th>X-value</th> <th>Y-value</th> <th>Function</th> <th>Function Result</th> </tr> </thead> <tbody> <tr> <td>M1</td> <td></td> <td>1</td> <td>2.40127 GHz</td> <td>-17.44 dBm</td> <td></td> <td></td> </tr> <tr> <td>M2</td> <td></td> <td>1</td> <td>2.4019175 GHz</td> <td>2.60 dBm</td> <td></td> <td></td> </tr> <tr> <td>D3</td> <td>M1</td> <td>1</td> <td>1.2575 MHz</td> <td>-0.24 dB</td> <td></td> <td></td> </tr> </tbody> </table>		Type	Ref	Trc	X-value	Y-value	Function	Function Result	M1		1	2.40127 GHz	-17.44 dBm			M2		1	2.4019175 GHz	2.60 dBm			D3	M1	1	1.2575 MHz	-0.24 dB		
Type	Ref	Trc	X-value	Y-value	Function	Function Result																								
M1		1	2.40127 GHz	-17.44 dBm																										
M2		1	2.4019175 GHz	2.60 dBm																										
D3	M1	1	1.2575 MHz	-0.24 dB																										
CH39	<p>Ref Level 20.00 dBm Offset 1.00 dB RBW 30 kHz Att 30 dB SWT 63.1 μs VBW 100 kHz Mode Auto FFT Count 500/500</p> <p>CF 2.441 GHz 1001 pts Span 2.5 MHz</p> <table border="1"> <thead> <tr> <th>Type</th> <th>Ref</th> <th>Trc</th> <th>X-value</th> <th>Y-value</th> <th>Function</th> <th>Function Result</th> </tr> </thead> <tbody> <tr> <td>M1</td> <td></td> <td>1</td> <td>2.4402625 GHz</td> <td>-16.13 dBm</td> <td></td> <td></td> </tr> <tr> <td>M2</td> <td></td> <td>1</td> <td>2.440915 GHz</td> <td>4.37 dBm</td> <td></td> <td></td> </tr> <tr> <td>D3</td> <td>M1</td> <td>1</td> <td>1.2625 MHz</td> <td>0.17 dB</td> <td></td> <td></td> </tr> </tbody> </table>		Type	Ref	Trc	X-value	Y-value	Function	Function Result	M1		1	2.4402625 GHz	-16.13 dBm			M2		1	2.440915 GHz	4.37 dBm			D3	M1	1	1.2625 MHz	0.17 dB		
Type	Ref	Trc	X-value	Y-value	Function	Function Result																								
M1		1	2.4402625 GHz	-16.13 dBm																										
M2		1	2.440915 GHz	4.37 dBm																										
D3	M1	1	1.2625 MHz	0.17 dB																										
CH78	<p>Ref Level 20.00 dBm Offset 1.00 dB RBW 30 kHz Att 30 dB SWT 63.1 μs VBW 100 kHz Mode Auto FFT Count 500/500</p> <p>CF 2.48 GHz 1001 pts Span 2.5 MHz</p> <table border="1"> <thead> <tr> <th>Type</th> <th>Ref</th> <th>Trc</th> <th>X-value</th> <th>Y-value</th> <th>Function</th> <th>Function Result</th> </tr> </thead> <tbody> <tr> <td>M1</td> <td></td> <td>1</td> <td>2.479265 GHz</td> <td>-16.21 dBm</td> <td></td> <td></td> </tr> <tr> <td>M2</td> <td></td> <td>1</td> <td>2.4799125 GHz</td> <td>4.27 dBm</td> <td></td> <td></td> </tr> <tr> <td>D3</td> <td>M1</td> <td>1</td> <td>1.255 MHz</td> <td>0.35 dB</td> <td></td> <td></td> </tr> </tbody> </table>		Type	Ref	Trc	X-value	Y-value	Function	Function Result	M1		1	2.479265 GHz	-16.21 dBm			M2		1	2.4799125 GHz	4.27 dBm			D3	M1	1	1.255 MHz	0.35 dB		
Type	Ref	Trc	X-value	Y-value	Function	Function Result																								
M1		1	2.479265 GHz	-16.21 dBm																										
M2		1	2.4799125 GHz	4.27 dBm																										
D3	M1	1	1.255 MHz	0.35 dB																										

5.5. 99% Occupied Bandwidth

LIMIT

N/A

TEST CONFIGURATION

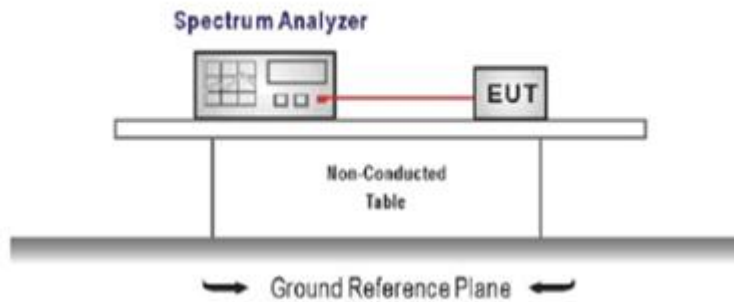

TEST PROCEDURE

1. Connect the antenna port(s) to the spectrum analyzer input.
2. Configure the spectrum analyzer as shown below (enter all losses between the transmitter output and the spectrum analyzer).
Center Frequency = channel center frequency
Span $\geq 1.5 \times$ OBW
RBW = 1%~5%OBW
VBW $\geq 3 \times$ RBW
Sweep time = auto couple
Detector = Peak
Trace mode = max hold
3. Place the radio in continuous transmit mode, allow the trace to stabilize, view the transmitter waveform on the spectrum analyzer.

TEST MODE

Refer to the clause 4.3

TEST RESULT

Passed Not Applicable

5.6. Carrier Frequencies Separation

LIMIT

FCC CFR Title 47 Part 15 Subpart C Section 15.247 (a)(1):

Frequency hopping systems shall have hopping channel carrier frequencies separated by a minimum of 25kHz or the 20 dB bandwidth of the hopping channel, whichever is greater. Alternatively, Frequency hopping systems operating in the 2400-2483.5 MHz band may have hopping channel carrier frequencies that are separated by 25 kHz or two-thirds of the 20 dB bandwidth of the hopping channel, whichever is greater, provided the systems operate with an output power no greater than 125 mW.

TEST CONFIGURATION

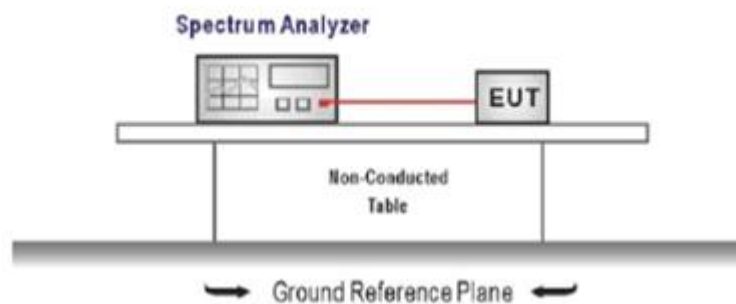

TEST PROCEDURE

1. The transmitter output was connected to the spectrum analyzer through an attenuator, the path loss was compensated to the results for each measurement.
2. Set to the maximum power setting and enable the EUT transmit continuously
3. Use the following spectrum analyzer settings:
 - Span = wide enough to capture the peaks of two adjacent channels
 - RBW \geq 1% of the span, VBW \geq RBW
 - Sweep = auto, Detector function = peak, Trace = max hold
4. Measure and record the results in the test report.

TEST MODE

Refer to the clause 4.3

TEST RESULTS

Passed Not Applicable

Modulation type	Channel	Carrier Frequencies Separation (MHz)	Limit (MHz) *	Result
GFSK	39	1.00	≥ 0.93	Pass
$\pi/4$ DQPSK	39	1.00	≥ 0.83	Pass
8DPSK	39	1.00	≥ 0.84	Pass

Note:

*: GFSK limit = The maximum 20 dB Bandwidth for GFSK modulation on the section 5.4.

$\pi/4$ DQPSK limit = $2/3$ * The maximum 20 dB Bandwidth for $\pi/4$ DQPSK modulation on the section 5.4.

8DPSK limit = $2/3$ * The maximum 20 dB Bandwidth for 8DPSK modulation on the section 5.4

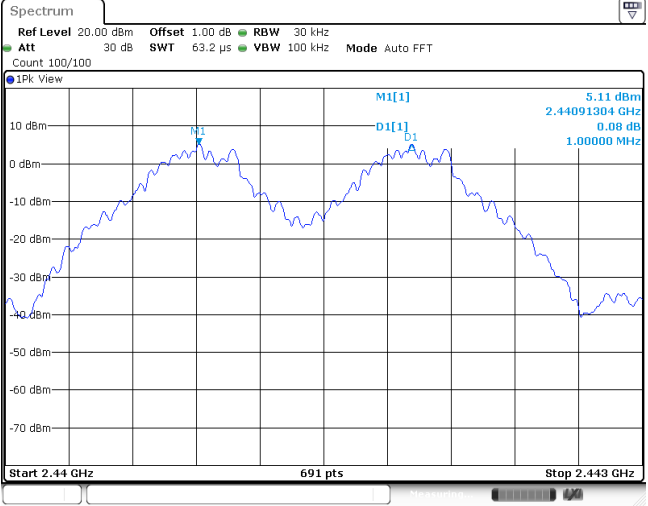
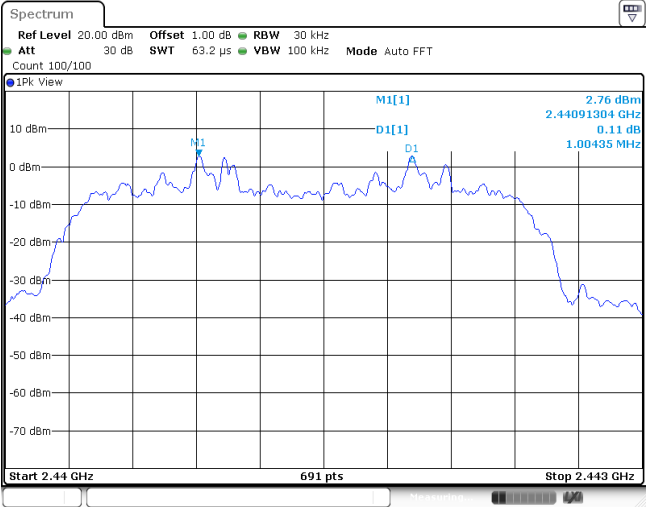
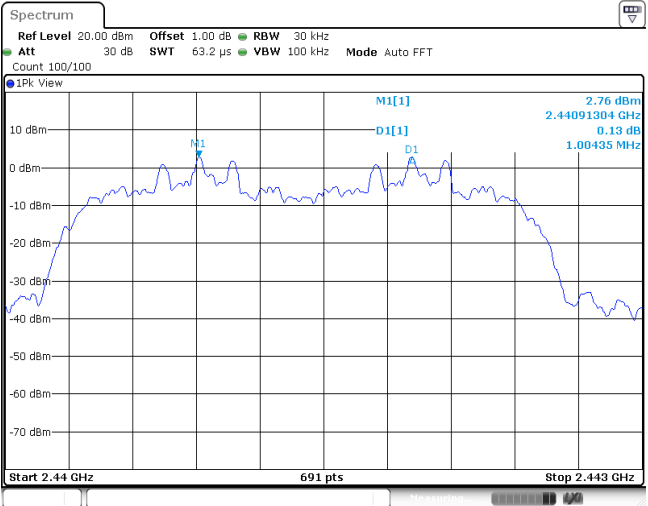
<p>GFSK</p>	
<p>$\pi/4$DQPSK</p>	
<p>8DPSK</p>	

5.7. Hopping Channel Number

LIMIT

FCC CFR Title 47 Part 15 Subpart C Section 15.247 (a)(1):

Frequency hopping systems in the 2400–2483.5 MHz band shall use at least **15** channels.

TEST CONFIGURATION

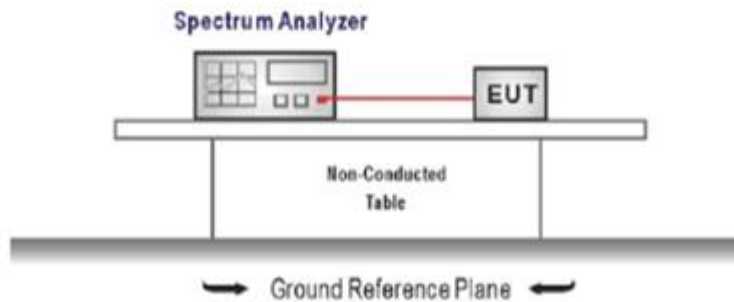

TEST PROCEDURE

1. The transmitter output was connected to the spectrum analyzer through an attenuator, the path loss was compensated to the results for each measurement.
2. Set to the maximum power setting and enable the EUT transmit continuously
3. Use the following spectrum analyzer settings:
Span = the frequency band of operation
RBW \geq 1% of the span, VBW \geq RBW
Sweep = auto, Detector function = peak, Trace = max hold
4. Measure and record the results in the test report.

TEST MODE

Refer to the clause 4.3

TEST RESULTS

Passed Not Applicable

Modulation type	Channel number	Limit	Result
GFSK	79	≥ 15.00	Pass
$\pi/4$ DQPSK	79		
8DPSK	79		

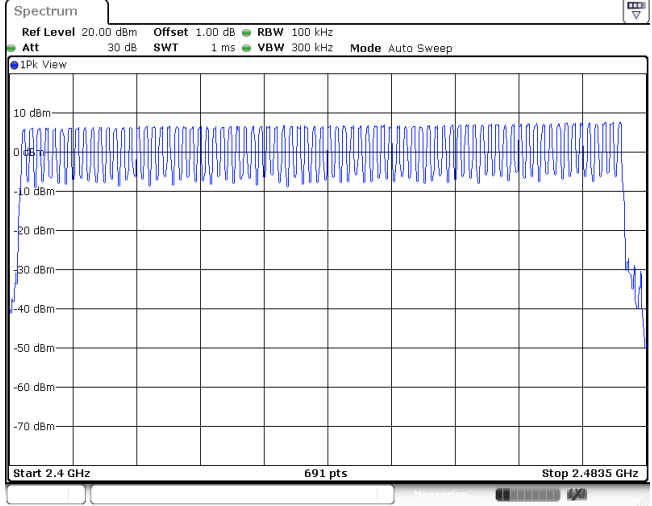
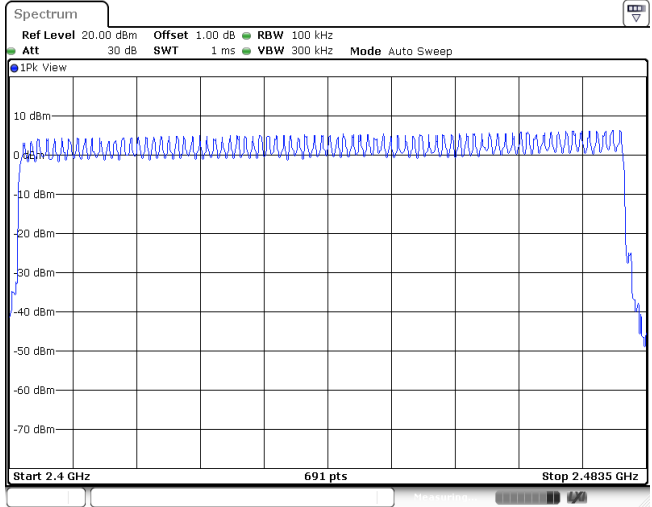
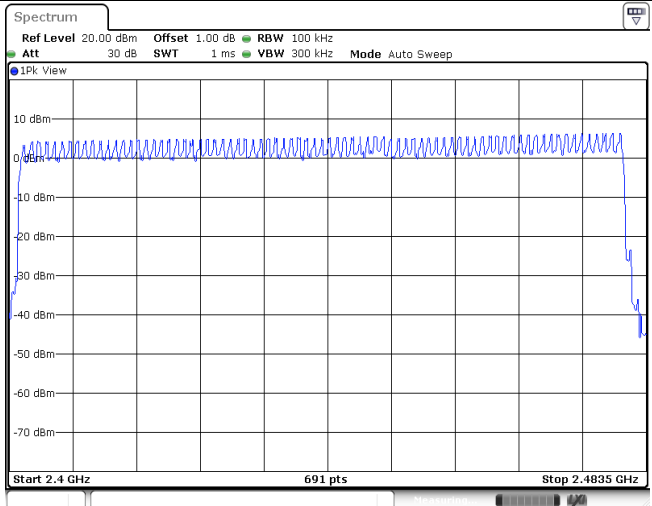
<p>GFSK</p>	
<p>$\pi/4$DQPSK</p>	
<p>8DPSK</p>	

5.8. Dwell Time

LIMIT

FCC CFR Title 47 Part 15 Subpart C Section 15.247 (a)(1):The average time of occupancy on any channel shall not be greater than 0.4 seconds within a pe-riod of 0.4 seconds multiplied by the number of hopping channels employed.

TEST CONFIGURATION

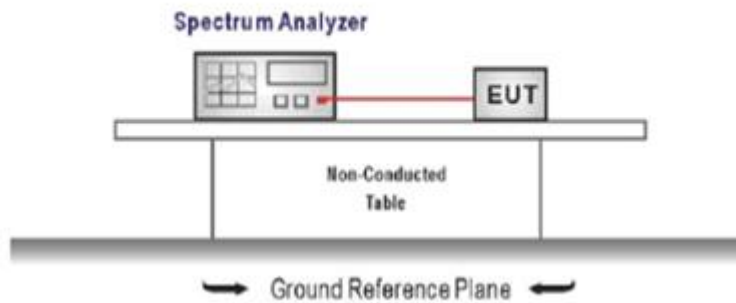

TEST PROCEDURE

1. The transmitter output was connected to the spectrum analyzer through an attenuator, the path loss was compensated to the results for each measurement.
2. Set to the maximum power setting and enable the EUT transmit continuously
3. Use the following spectrum analyzer settings:
Span = zero span, centered on a hopping channel, RBW= 1 MHz, VBW ≥ RBW
Sweep = as necessary to capture the entire dwell time per hopping channel,
Detector function = peak, Trace = max hold
4. Measure and record the results in the test report.

TEST MODE

Refer to the clause 4.3

TEST RESULTS

Passed Not Applicable

Modulation type	Channel	Burst Width [ms/hop/ch]	Total Hops[hop*ch]	Dwell time (Second)	Limit (Second)	Result
GFSK	DH1	0.37	315.00	0.12	≤ 0.40	Pass
	DH3	1.63	155.00	0.25		
	DH5	2.87	108.00	0.31		
π/4DQPSK	2DH1	0.38	316.00	0.12	≤ 0.40	Pass
	2DH3	1.63	166.00	0.27		
	2DH5	2.88	109.00	0.31		
8DPSK	3DH1	0.38	315.00	0.12	≤ 0.40	Pass
	3DH3	1.63	158.00	0.26		
	3DH5	2.88	97.00	0.28		

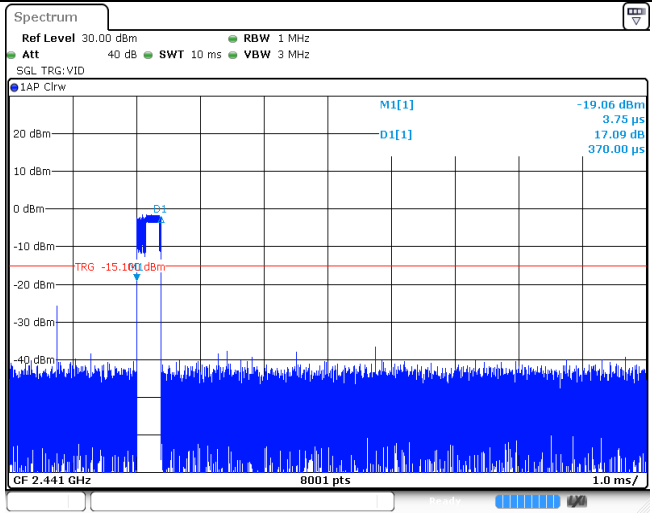
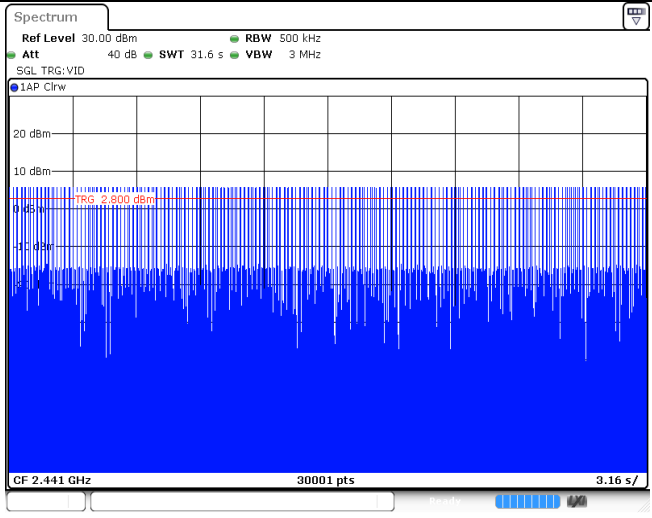
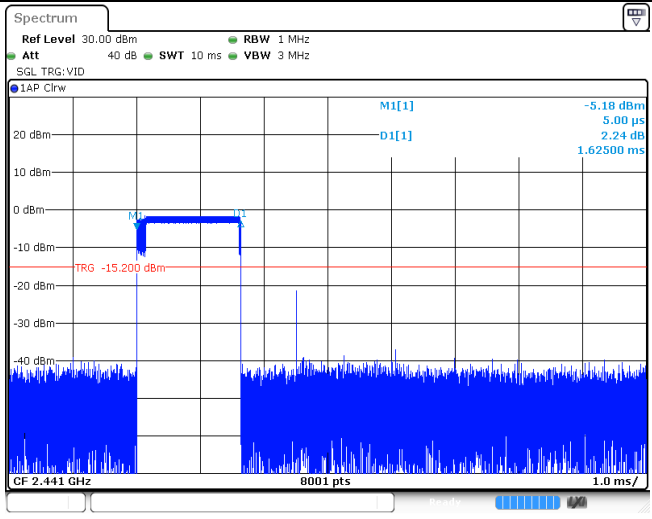
Modulation Type: GFSK	
DH1 Burst width	
DH1 Burst number	
DH3 Burst width	

DH3
Burst number

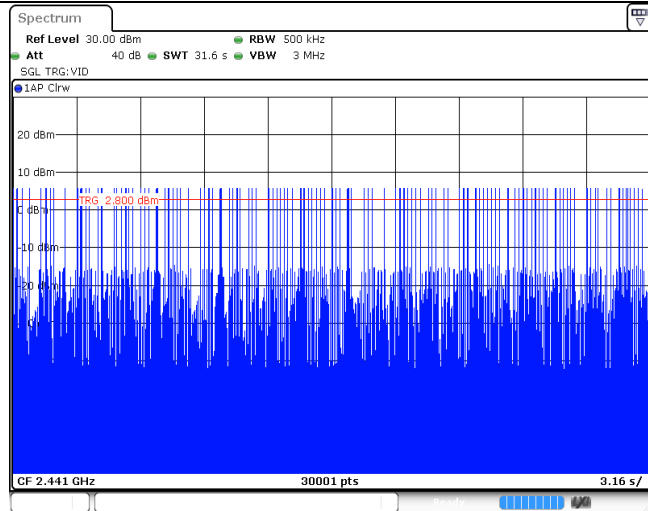

DH5
Burst width

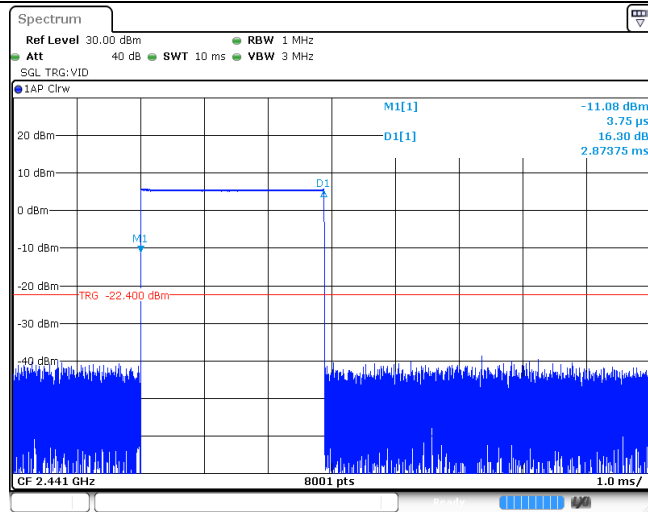

DH5
Burst number

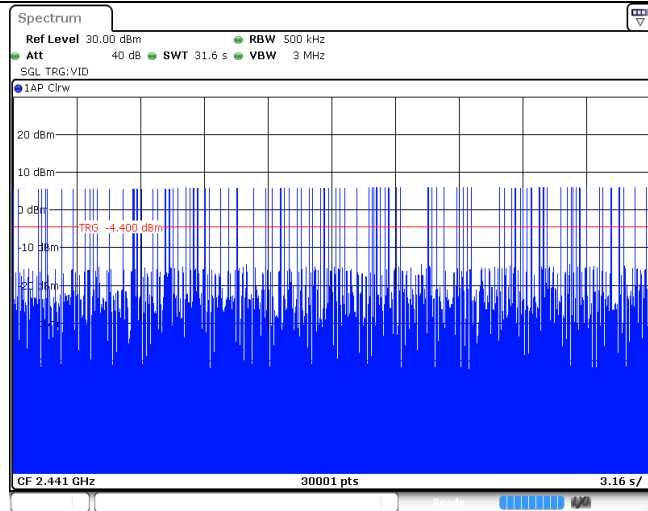

Modulation Type:		$\pi/4$ DQPSK
2DH1 Burst width		
2DH1 Burst number		
2DH3 Burst width		

2DH3
Burst number

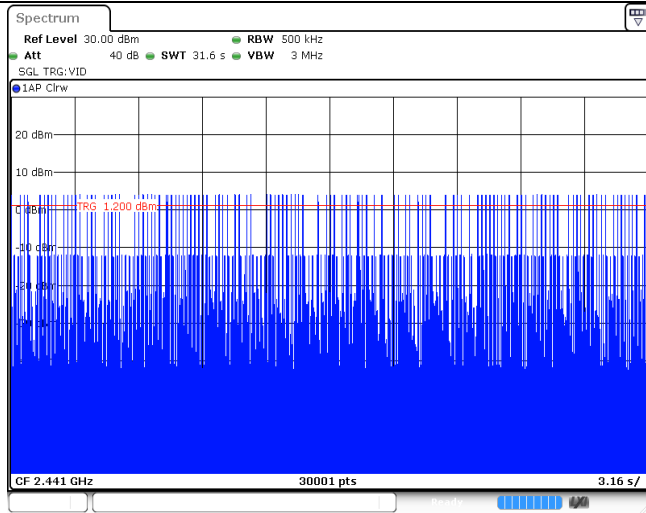

2DH5
Burst width

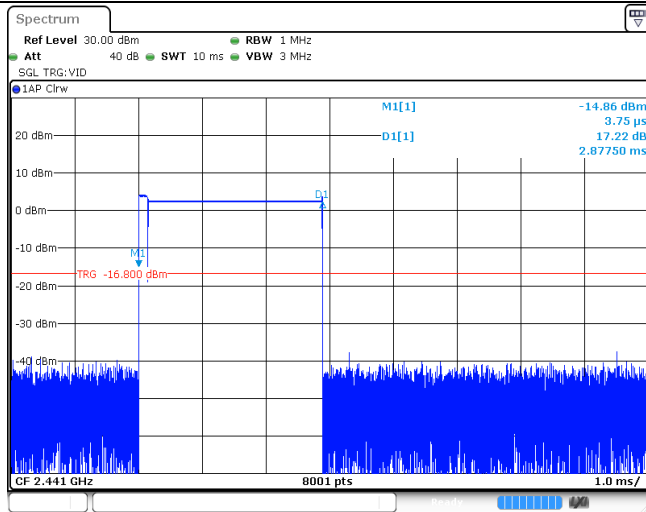

2DH5
Burst number

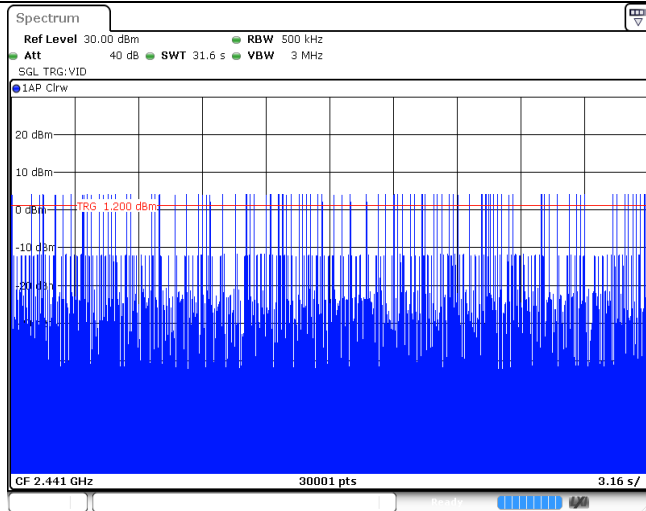

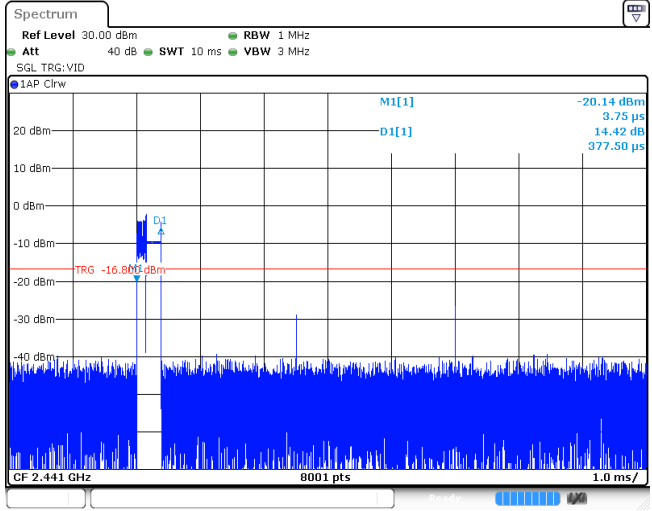
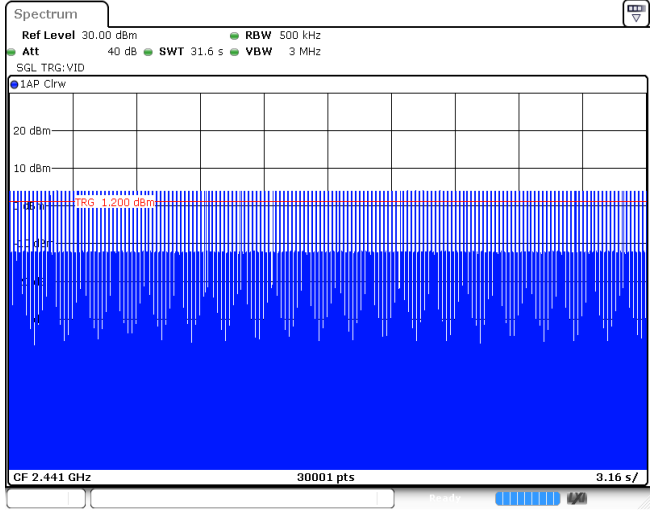
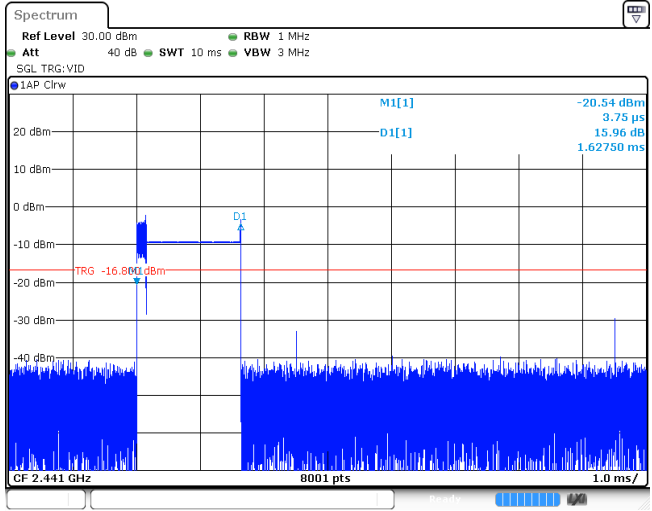
Modulation Type: $\pi/4$ DQPSK	
3DH1 Burst width	
3DH1 Burst number	
3DH3 Burst width	

3DH3
Burst number

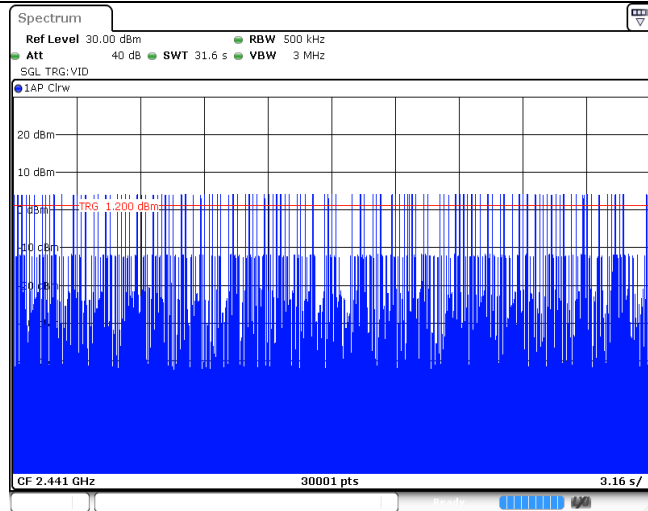

3DH5
Burst width

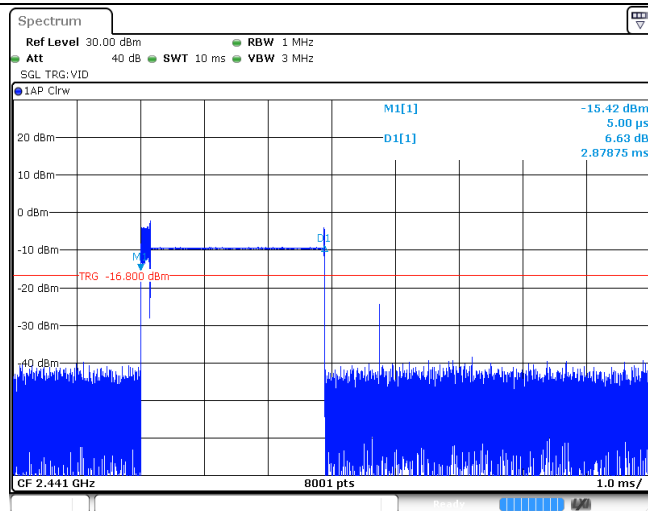

3DH5
Burst number

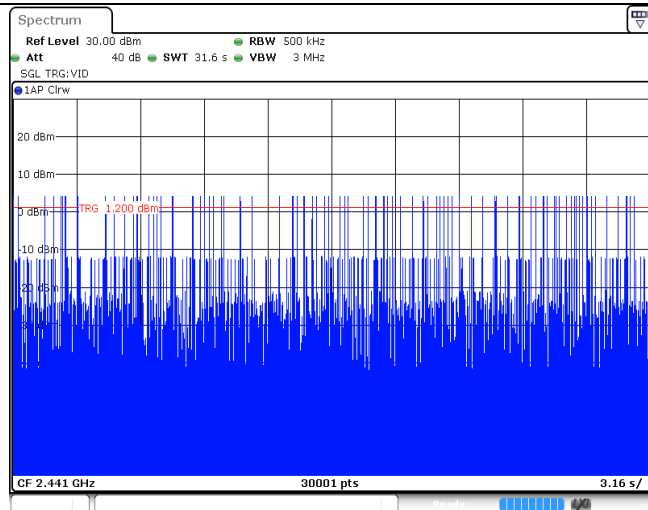

5.9. Duty Cycle Correction Factor (DCCF)

LIMIT

N/A

TEST CONFIGURATION

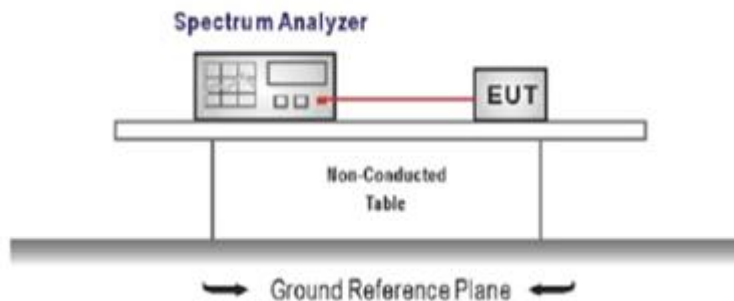

TEST PROCEDURE

1. The transmitter output was connected to the spectrum analyzer through an attenuator, the path loss was compensated to the results for each measurement.
2. Set to the maximum power setting and enable the EUT transmit continuously
3. Use the following spectrum analyzer settings:
Span = zero span, centered on a hopping channel, RBW= 1 MHz, VBW \geq RBW
Sweep = as necessary to capture the entire dwell time per hopping channel,
Detector function = peak, Trigger mode
4. Measure and record the duty cycle data

TEST MODE

Refer to the clause 4.3

Not Applicable

5.10. Pseudorandom Frequency Hopping Sequence

LIMIT

FCC CFR Title 47 Part 15 Subpart C Section 15.247 (a)(1):Frequency hopping systems shall have hopping channel carrier frequencies separated by a minimum of 25 kHz or the 20 dB bandwidth of the hopping channel, whichever is greater. Alternatively, frequency hopping systems operating in the 2400–2483.5 MHz band may have hopping channel carrier frequencies that are separated by 25 kHz or two-thirds of the 20 dB bandwidth of the hopping channel, whichever is greater, provided the systems operate with an output power no greater than 125 mW. The system shall hop to channel frequencies that are selected at the system hopping rate from a pseudo-randomly ordered list of hopping frequencies. Each frequency must be used equally on the average by each transmitter. The system receivers shall have input bandwidths that match the hopping channel bandwidths of their corresponding transmitters and shall shift frequencies in synchronization with the transmitted signals.

TEST RESULTS

The pseudorandom frequency hopping sequence may be generated in a nine-stage shift register whose 5th and 9th stage outputs are added in a modulo-two addition stage. And the result is fed back to the input of the first stage. The sequence begins with the first one of 9 consecutive ones, for example: the shift register is initialized with nine ones.

- Number of shift register stages: 9
- Length of pseudo-random sequence: $2^9 - 1 = 511$ bits
- Longest sequence of zeros: 8 (non-inverted signal)

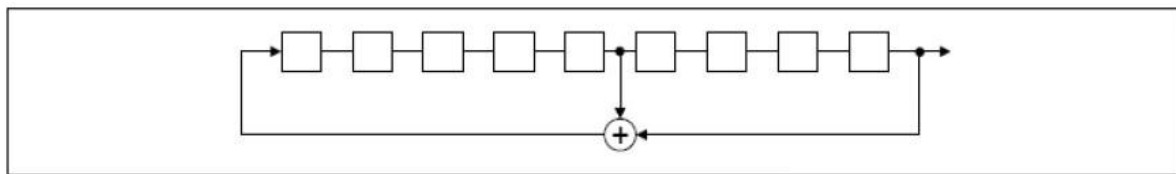

Linear Feedback Shift Register for Generation of the PRBS sequence

An example of pseudorandom frequency hopping sequence as follows:

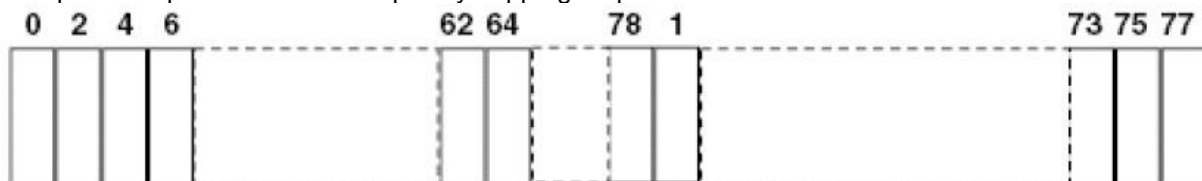

Each frequency used equally on the average by each transmitter. The system receiver has input bandwidths that match the hopping channel bandwidths of their corresponding transmitter and shift frequencies in synchronization with the transmitted signals.

5.11. Conducted Band edge and Spurious Emission

LIMIT

FCC CFR Title 47 Part 15 Subpart C Section 15.247 (d): In any 100 kHz bandwidth outside the frequency band in which the spread spectrum intentional radiator is operating, the radio frequency power that is produced by the intentional radiator shall be at least 20 dB below that in the 100 kHz bandwidth within the band that contains the highest level of the desired power, based on either an RF conducted or a radiated measurement.

TEST CONFIGURATION

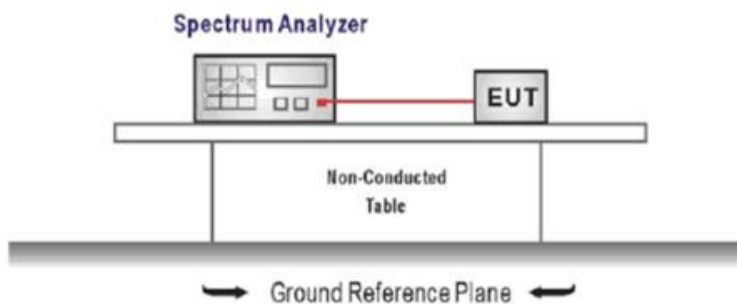

TEST PROCEDURE

1. Connect the antenna port(s) to the spectrum analyzer input.
2. Emission level measurement
Set the center frequency and span to encompass frequency range to be measured
RBW = 100 kHz, VBW \geq 3 x RBW
Detector = peak, Sweep time = auto couple, Trace mode = max hold
Allow trace to fully stabilize
Use the peak marker function to determine the maximum amplitude level.
3. Place the radio in continuous transmit mode, allow the trace to stabilize, view the transmitter waveform on the spectrum analyzer.
4. Ensure that the amplitude of all unwanted emission outside of the authorized frequency band excluding restricted frequency bands) are attenuated by at least the minimum requirements specified (at least 20 dB relative to the maximum in-band peak PSD level in 100 kHz). Report the three highest emission relative to the limit.

TEST MODE

Refer to the clause 4.3

TEST RESULT

Passed Not Applicable

Test Item:	Band edge	Modulation type:	GFSK																																										
<p>CH00 No hopping mode</p>			<p>Spectrum</p> <p>Ref Level 20.00 dBm Offset 1.00 dB RBW 100 kHz Att 30 dB SWT 1.1 ms VBW 300 kHz Mode Auto Sweep Count 500/500</p> <p>1Pk Max</p> <p>M1[1] 5.73 dBm 2.402040 GHz M2[1] -36.91 dBm 2.400000 GHz</p> <p>D1 -14.270 dBm</p> <p>Start 2.31 GHz 691 pts Stop 2.405 GHz</p> <table border="1"> <thead> <tr> <th>Type</th> <th>Ref</th> <th>Trc</th> <th>X-value</th> <th>Y-value</th> <th>Function</th> <th>Function Result</th> </tr> </thead> <tbody> <tr> <td>M1</td> <td>1</td> <td></td> <td>2.40204 GHz</td> <td>5.73 dBm</td> <td></td> <td></td> </tr> <tr> <td>M2</td> <td>1</td> <td></td> <td>2.4 GHz</td> <td>-36.91 dBm</td> <td></td> <td></td> </tr> <tr> <td>M3</td> <td>1</td> <td></td> <td>2.39 GHz</td> <td>-55.82 dBm</td> <td></td> <td></td> </tr> <tr> <td>M4</td> <td>1</td> <td></td> <td>2.31 GHz</td> <td>-58.01 dBm</td> <td></td> <td></td> </tr> <tr> <td>M5</td> <td>1</td> <td></td> <td>2.399217 GHz</td> <td>-39.03 dBm</td> <td></td> <td></td> </tr> </tbody> </table>	Type	Ref	Trc	X-value	Y-value	Function	Function Result	M1	1		2.40204 GHz	5.73 dBm			M2	1		2.4 GHz	-36.91 dBm			M3	1		2.39 GHz	-55.82 dBm			M4	1		2.31 GHz	-58.01 dBm			M5	1		2.399217 GHz	-39.03 dBm		
Type	Ref	Trc	X-value	Y-value	Function	Function Result																																							
M1	1		2.40204 GHz	5.73 dBm																																									
M2	1		2.4 GHz	-36.91 dBm																																									
M3	1		2.39 GHz	-55.82 dBm																																									
M4	1		2.31 GHz	-58.01 dBm																																									
M5	1		2.399217 GHz	-39.03 dBm																																									
<p>CH00 Hopping mode</p>			<p>Spectrum</p> <p>Ref Level 20.00 dBm Offset 1.00 dB RBW 100 kHz Att 30 dB SWT 1.1 ms VBW 300 kHz Mode Auto Sweep Count 500/500</p> <p>1Pk Max</p> <p>M1[1] 5.73 dBm 2.403970 GHz M2[1] -45.15 dBm 2.400000 GHz</p> <p>D1 -14.270 dBm</p> <p>Start 2.31 GHz 691 pts Stop 2.405 GHz</p> <table border="1"> <thead> <tr> <th>Type</th> <th>Ref</th> <th>Trc</th> <th>X-value</th> <th>Y-value</th> <th>Function</th> <th>Function Result</th> </tr> </thead> <tbody> <tr> <td>M1</td> <td>1</td> <td></td> <td>2.40397 GHz</td> <td>5.73 dBm</td> <td></td> <td></td> </tr> <tr> <td>M2</td> <td>1</td> <td></td> <td>2.4 GHz</td> <td>-45.15 dBm</td> <td></td> <td></td> </tr> <tr> <td>M3</td> <td>1</td> <td></td> <td>2.39 GHz</td> <td>-49.57 dBm</td> <td></td> <td></td> </tr> <tr> <td>M4</td> <td>1</td> <td></td> <td>2.31 GHz</td> <td>-52.16 dBm</td> <td></td> <td></td> </tr> <tr> <td>M5</td> <td>1</td> <td></td> <td>2.399217 GHz</td> <td>-40.08 dBm</td> <td></td> <td></td> </tr> </tbody> </table>	Type	Ref	Trc	X-value	Y-value	Function	Function Result	M1	1		2.40397 GHz	5.73 dBm			M2	1		2.4 GHz	-45.15 dBm			M3	1		2.39 GHz	-49.57 dBm			M4	1		2.31 GHz	-52.16 dBm			M5	1		2.399217 GHz	-40.08 dBm		
Type	Ref	Trc	X-value	Y-value	Function	Function Result																																							
M1	1		2.40397 GHz	5.73 dBm																																									
M2	1		2.4 GHz	-45.15 dBm																																									
M3	1		2.39 GHz	-49.57 dBm																																									
M4	1		2.31 GHz	-52.16 dBm																																									
M5	1		2.399217 GHz	-40.08 dBm																																									
<p>CH78 No hopping mode</p>			<p>Spectrum</p> <p>Ref Level 20.00 dBm Offset 1.00 dB RBW 100 kHz Att 30 dB SWT 56.9 μs VBW 300 kHz Mode Auto FFT</p> <p>1Pk Max</p> <p>M1[1] 7.58 dBm 2.4800850 GHz M2[1] -50.72 dBm 2.4835000 GHz</p> <p>D1 -12.420 dBm</p> <p>Start 2.478 GHz 691 pts Stop 2.5 GHz</p> <table border="1"> <thead> <tr> <th>Type</th> <th>Ref</th> <th>Trc</th> <th>X-value</th> <th>Y-value</th> <th>Function</th> <th>Function Result</th> </tr> </thead> <tbody> <tr> <td>M1</td> <td>1</td> <td></td> <td>2.480085 GHz</td> <td>7.58 dBm</td> <td></td> <td></td> </tr> <tr> <td>M2</td> <td>1</td> <td></td> <td>2.4835 GHz</td> <td>-50.72 dBm</td> <td></td> <td></td> </tr> <tr> <td>M3</td> <td>1</td> <td></td> <td>2.5 GHz</td> <td>-46.24 dBm</td> <td></td> <td></td> </tr> <tr> <td>M4</td> <td>1</td> <td></td> <td>2.4838986 GHz</td> <td>-42.18 dBm</td> <td></td> <td></td> </tr> </tbody> </table>	Type	Ref	Trc	X-value	Y-value	Function	Function Result	M1	1		2.480085 GHz	7.58 dBm			M2	1		2.4835 GHz	-50.72 dBm			M3	1		2.5 GHz	-46.24 dBm			M4	1		2.4838986 GHz	-42.18 dBm									
Type	Ref	Trc	X-value	Y-value	Function	Function Result																																							
M1	1		2.480085 GHz	7.58 dBm																																									
M2	1		2.4835 GHz	-50.72 dBm																																									
M3	1		2.5 GHz	-46.24 dBm																																									
M4	1		2.4838986 GHz	-42.18 dBm																																									

CH78
Hopping mode

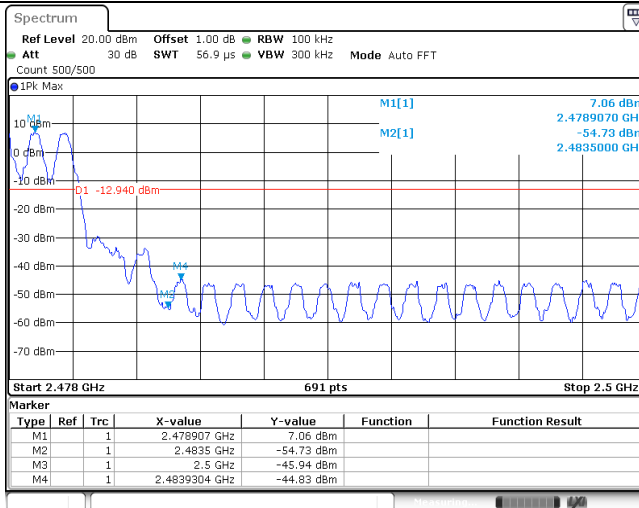

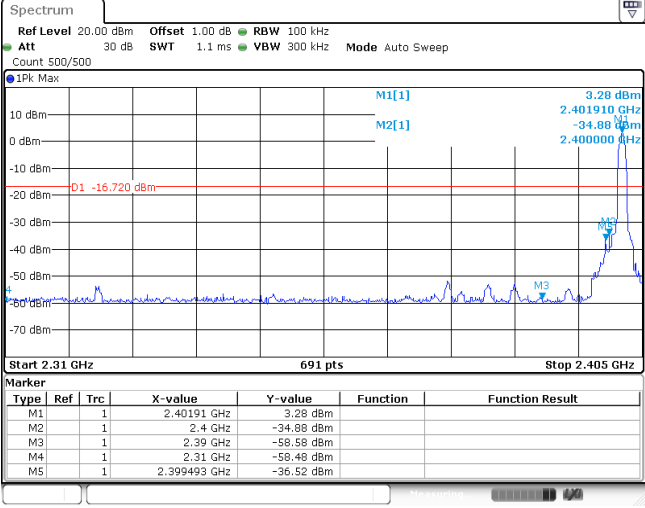
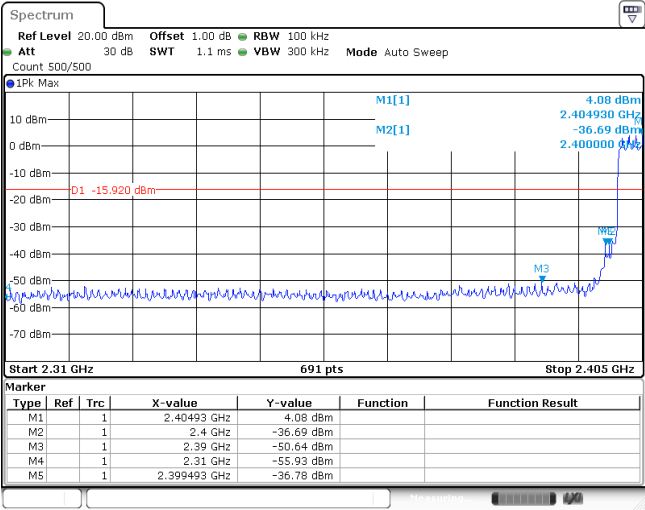
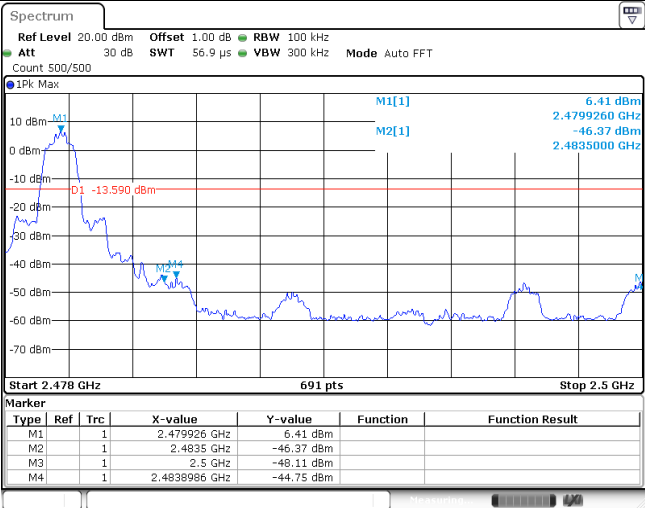
Test Item:	Band edge	Modulation type:	$\pi/4$ DQPSK																																										
<p>CH00 No hopping mode</p>	 <p>Spectrum</p> <p>Ref Level 20.00 dBm Offset 1.00 dB RBW 100 kHz Att 30 dB SWT 1.1 ms VBW 300 kHz Mode Auto Sweep Count 500/500</p> <p>1Pk Max</p> <p>M1[1] 3.28 dBm 2.40191 GHz M2[1] -34.88 dBm 2.400000 GHz</p> <p>D1 -16.720 dBm</p> <p>M3 M4 M5</p> <p>Start 2.31 GHz 691 pts Stop 2.405 GHz</p> <table border="1"> <thead> <tr> <th>Type</th> <th>Ref</th> <th>Trc</th> <th>X-value</th> <th>Y-value</th> <th>Function</th> <th>Function Result</th> </tr> </thead> <tbody> <tr> <td>M1</td> <td>1</td> <td></td> <td>2.40191 GHz</td> <td>3.28 dBm</td> <td></td> <td></td> </tr> <tr> <td>M2</td> <td>1</td> <td></td> <td>2.4 GHz</td> <td>-34.88 dBm</td> <td></td> <td></td> </tr> <tr> <td>M3</td> <td>1</td> <td></td> <td>2.39 GHz</td> <td>-58.58 dBm</td> <td></td> <td></td> </tr> <tr> <td>M4</td> <td>1</td> <td></td> <td>2.31 GHz</td> <td>-58.48 dBm</td> <td></td> <td></td> </tr> <tr> <td>M5</td> <td>1</td> <td></td> <td>2.399493 GHz</td> <td>-36.52 dBm</td> <td></td> <td></td> </tr> </tbody> </table>			Type	Ref	Trc	X-value	Y-value	Function	Function Result	M1	1		2.40191 GHz	3.28 dBm			M2	1		2.4 GHz	-34.88 dBm			M3	1		2.39 GHz	-58.58 dBm			M4	1		2.31 GHz	-58.48 dBm			M5	1		2.399493 GHz	-36.52 dBm		
Type	Ref	Trc	X-value	Y-value	Function	Function Result																																							
M1	1		2.40191 GHz	3.28 dBm																																									
M2	1		2.4 GHz	-34.88 dBm																																									
M3	1		2.39 GHz	-58.58 dBm																																									
M4	1		2.31 GHz	-58.48 dBm																																									
M5	1		2.399493 GHz	-36.52 dBm																																									
<p>CH00 Hopping mode</p>	 <p>Spectrum</p> <p>Ref Level 20.00 dBm Offset 1.00 dB RBW 100 kHz Att 30 dB SWT 1.1 ms VBW 300 kHz Mode Auto Sweep Count 500/500</p> <p>1Pk Max</p> <p>M1[1] 4.08 dBm 2.40493 GHz M2[1] -36.69 dBm 2.400000 GHz</p> <p>D1 -15.920 dBm</p> <p>M3 M4 M5</p> <p>Start 2.31 GHz 691 pts Stop 2.405 GHz</p> <table border="1"> <thead> <tr> <th>Type</th> <th>Ref</th> <th>Trc</th> <th>X-value</th> <th>Y-value</th> <th>Function</th> <th>Function Result</th> </tr> </thead> <tbody> <tr> <td>M1</td> <td>1</td> <td></td> <td>2.40493 GHz</td> <td>4.08 dBm</td> <td></td> <td></td> </tr> <tr> <td>M2</td> <td>1</td> <td></td> <td>2.4 GHz</td> <td>-36.69 dBm</td> <td></td> <td></td> </tr> <tr> <td>M3</td> <td>1</td> <td></td> <td>2.39 GHz</td> <td>-50.64 dBm</td> <td></td> <td></td> </tr> <tr> <td>M4</td> <td>1</td> <td></td> <td>2.31 GHz</td> <td>-55.93 dBm</td> <td></td> <td></td> </tr> <tr> <td>M5</td> <td>1</td> <td></td> <td>2.399493 GHz</td> <td>-36.78 dBm</td> <td></td> <td></td> </tr> </tbody> </table>			Type	Ref	Trc	X-value	Y-value	Function	Function Result	M1	1		2.40493 GHz	4.08 dBm			M2	1		2.4 GHz	-36.69 dBm			M3	1		2.39 GHz	-50.64 dBm			M4	1		2.31 GHz	-55.93 dBm			M5	1		2.399493 GHz	-36.78 dBm		
Type	Ref	Trc	X-value	Y-value	Function	Function Result																																							
M1	1		2.40493 GHz	4.08 dBm																																									
M2	1		2.4 GHz	-36.69 dBm																																									
M3	1		2.39 GHz	-50.64 dBm																																									
M4	1		2.31 GHz	-55.93 dBm																																									
M5	1		2.399493 GHz	-36.78 dBm																																									
<p>CH78 No hopping mode</p>	 <p>Spectrum</p> <p>Ref Level 20.00 dBm Offset 1.00 dB RBW 100 kHz Att 30 dB SWT 56.9 μs VBW 300 kHz Mode Auto FFT Count 500/500</p> <p>1Pk Max</p> <p>M1[1] 6.41 dBm 2.4799260 GHz M2[1] -46.37 dBm 2.4835000 GHz</p> <p>D1 -13.590 dBm</p> <p>M3 M4</p> <p>Start 2.478 GHz 691 pts Stop 2.5 GHz</p> <table border="1"> <thead> <tr> <th>Type</th> <th>Ref</th> <th>Trc</th> <th>X-value</th> <th>Y-value</th> <th>Function</th> <th>Function Result</th> </tr> </thead> <tbody> <tr> <td>M1</td> <td>1</td> <td></td> <td>2.479926 GHz</td> <td>6.41 dBm</td> <td></td> <td></td> </tr> <tr> <td>M2</td> <td>1</td> <td></td> <td>2.4835 GHz</td> <td>-46.37 dBm</td> <td></td> <td></td> </tr> <tr> <td>M3</td> <td>1</td> <td></td> <td>2.5 GHz</td> <td>-48.11 dBm</td> <td></td> <td></td> </tr> <tr> <td>M4</td> <td>1</td> <td></td> <td>2.4838986 GHz</td> <td>-44.75 dBm</td> <td></td> <td></td> </tr> </tbody> </table>			Type	Ref	Trc	X-value	Y-value	Function	Function Result	M1	1		2.479926 GHz	6.41 dBm			M2	1		2.4835 GHz	-46.37 dBm			M3	1		2.5 GHz	-48.11 dBm			M4	1		2.4838986 GHz	-44.75 dBm									
Type	Ref	Trc	X-value	Y-value	Function	Function Result																																							
M1	1		2.479926 GHz	6.41 dBm																																									
M2	1		2.4835 GHz	-46.37 dBm																																									
M3	1		2.5 GHz	-48.11 dBm																																									
M4	1		2.4838986 GHz	-44.75 dBm																																									

CH78
Hopping mode

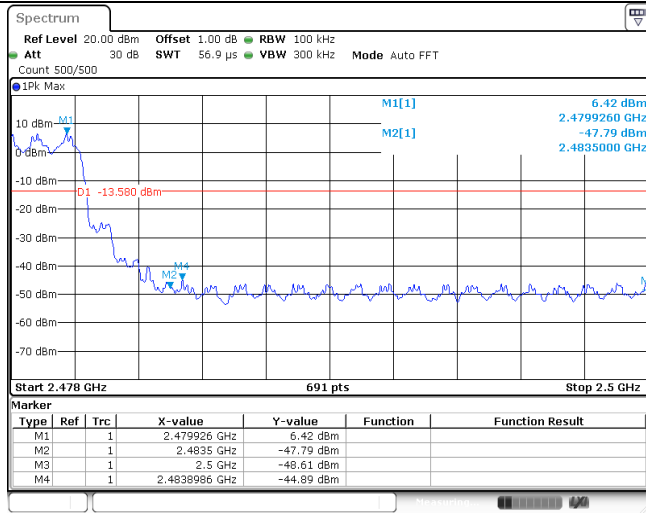

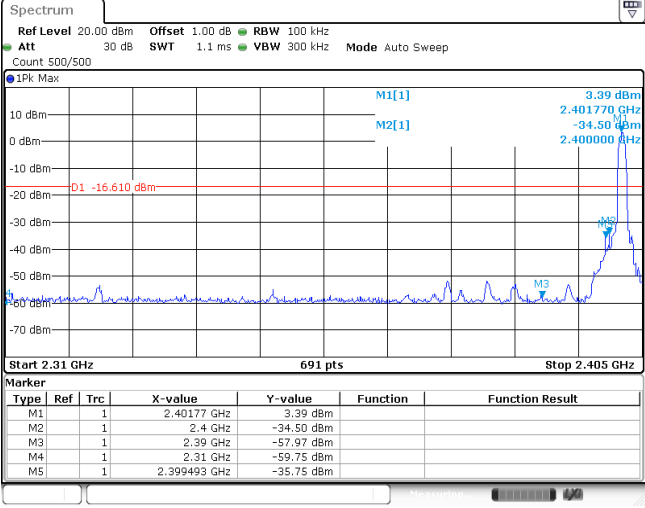
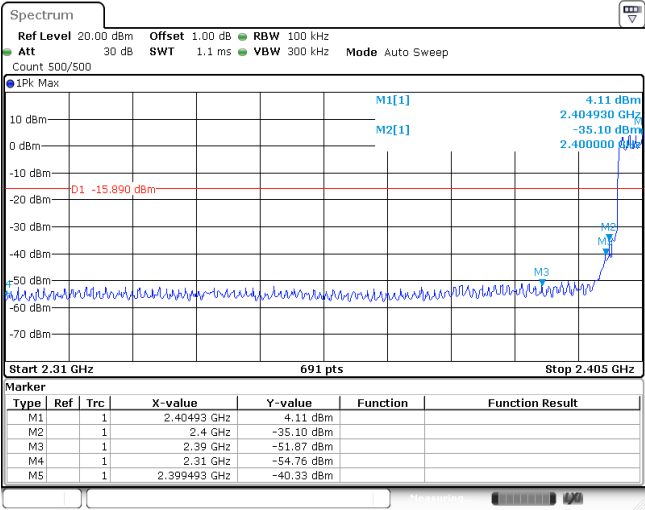
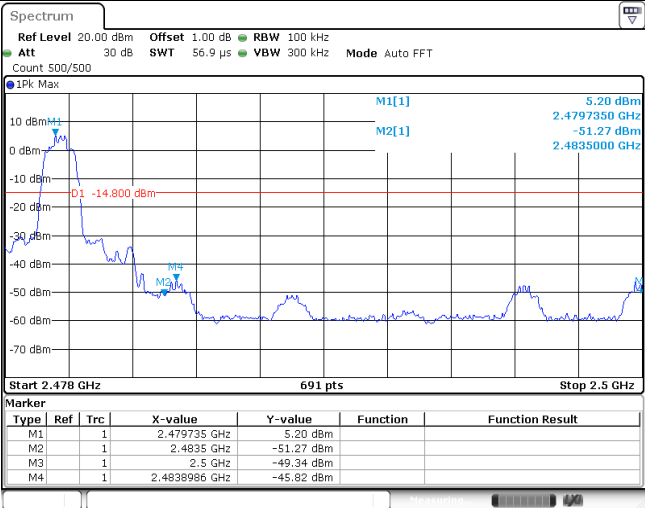
Test Item:	Band edge	Modulation type:	8DPSK
<p>CH00 No hopping mode</p>			
<p>CH00 Hopping mode</p>			
<p>CH78 No hopping mode</p>			

CH78
Hoppig mode

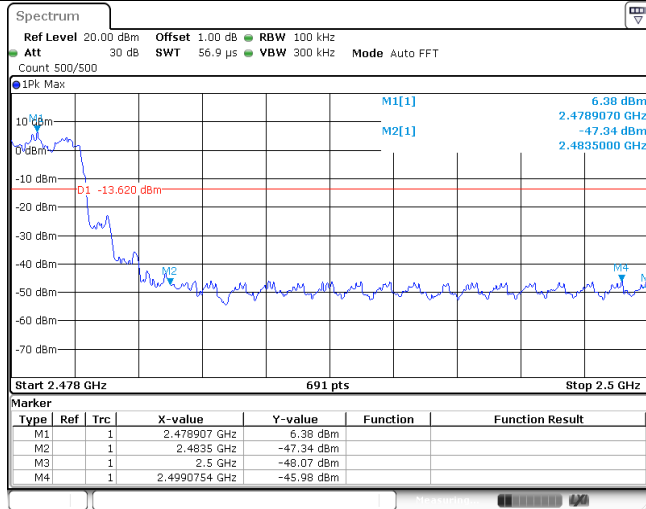

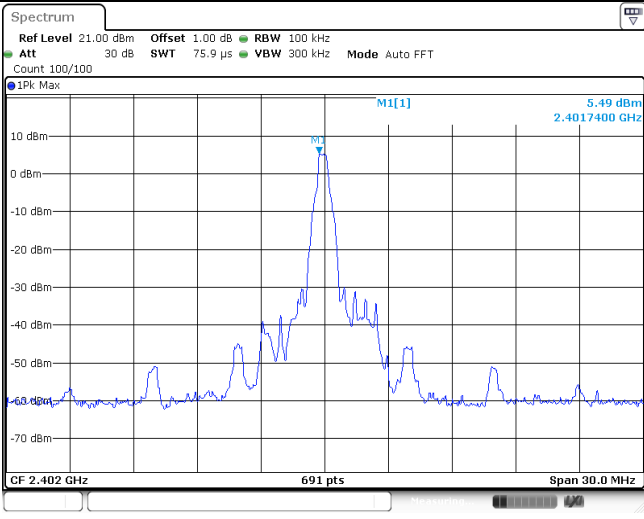
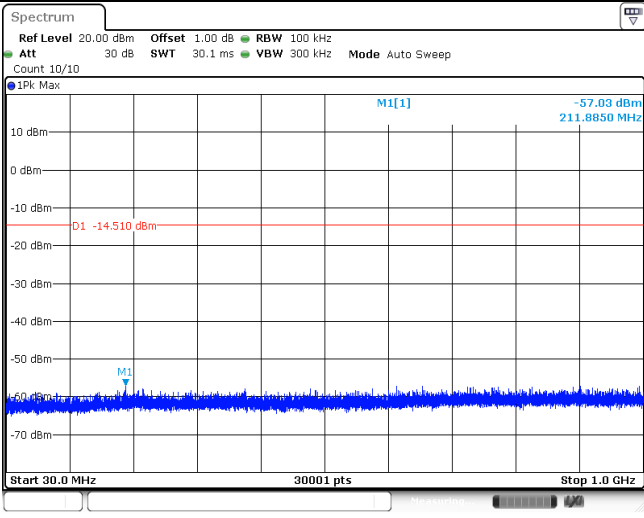
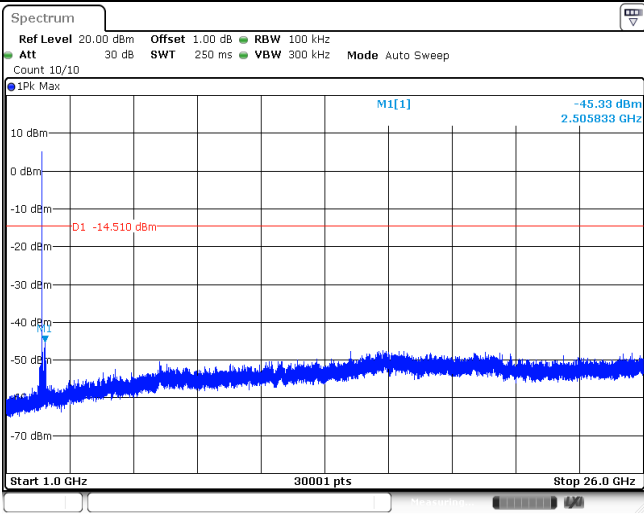
Test Item:	SE	Modulation type:	GFSK
<p>CH00 Reference level</p>			
<p>CH00 30MHz~1000MHz</p>			
<p>CH00 1GHz~26GHz</p>			

CH39
Reference level

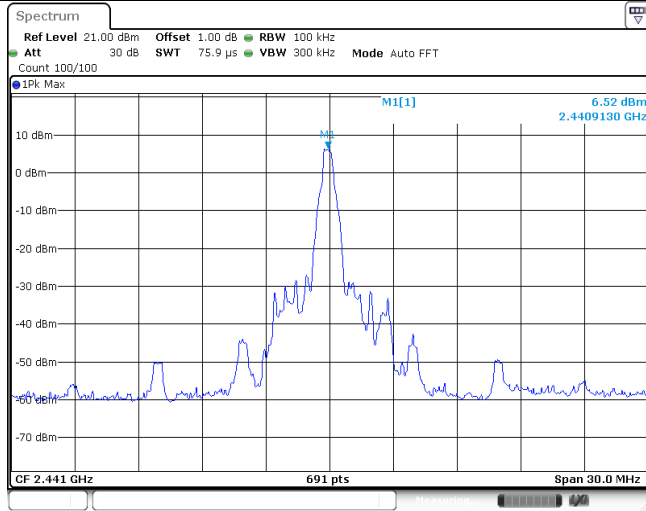

CH39
30MHz~1000MHz

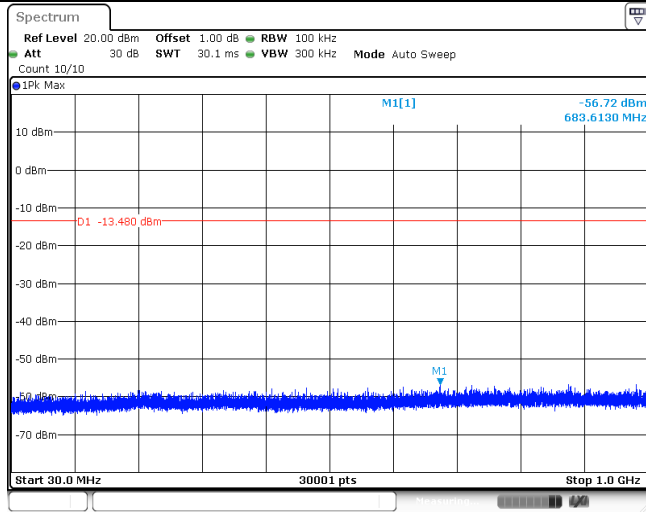

CH39
1GHz~26GHz

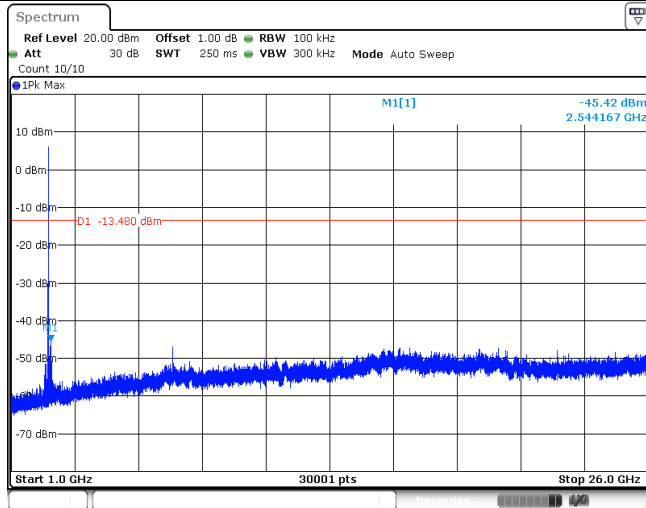

CH78
Reference level

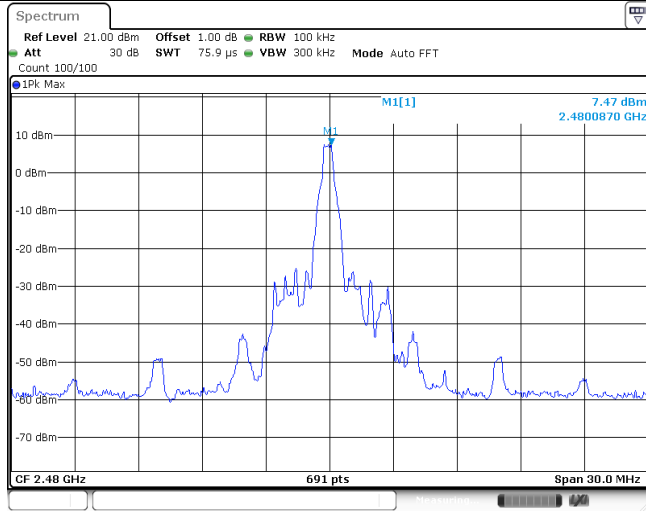

CH78
30MHz~1000MHz

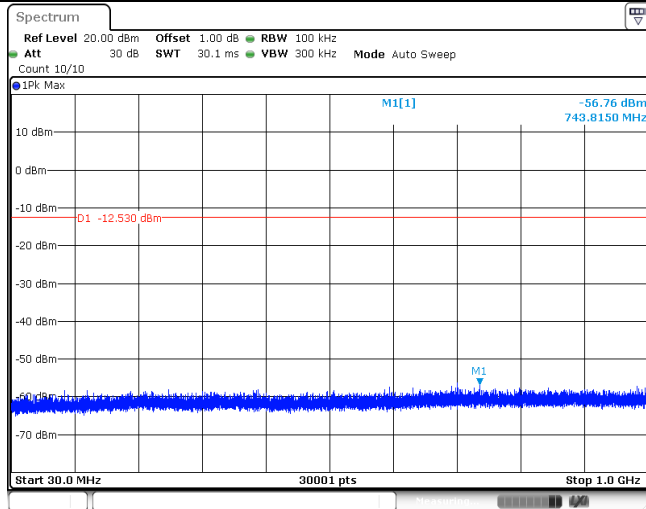

CH78
1GHz~26GHz

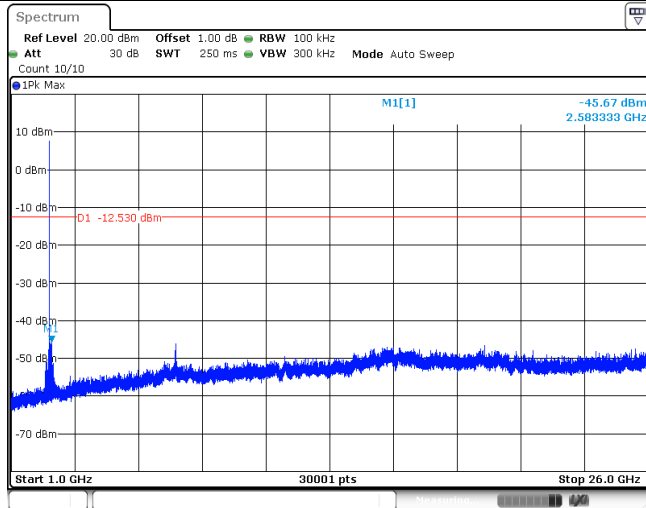

Test Item:	SE	Modulation type:	$\pi/4$ DQPSK
<p>CH00 Reference level</p>			
<p>CH00 30MHz~1000MHz</p>			
<p>CH00 1GHz~26GHz</p>			

CH39
Reference level



CH39
30MHz~1000MHz

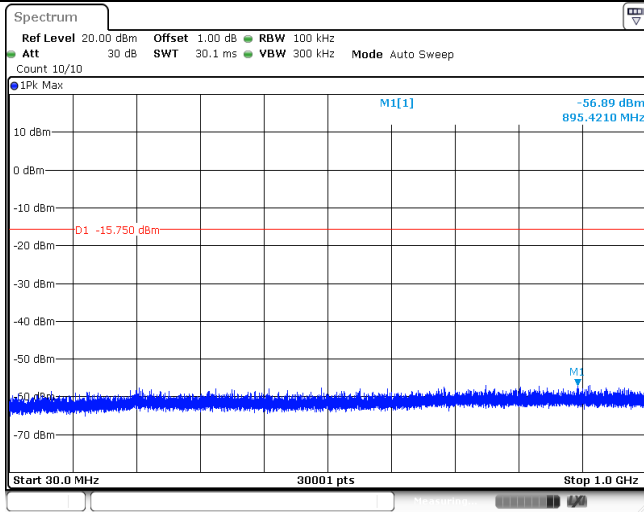

CH39
1GHz~26GHz

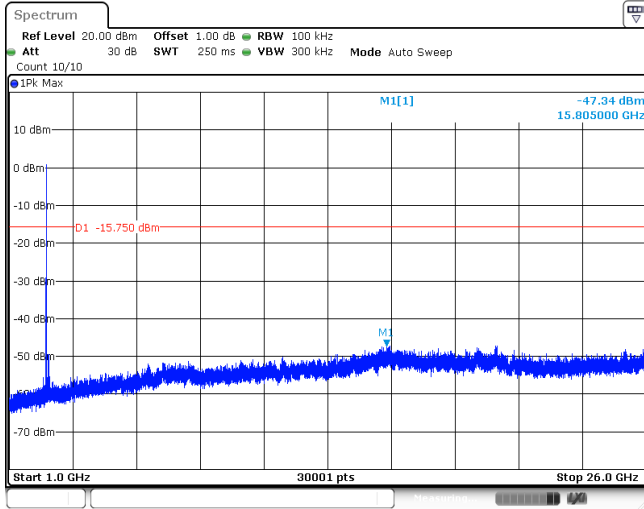

CH78
Reference level

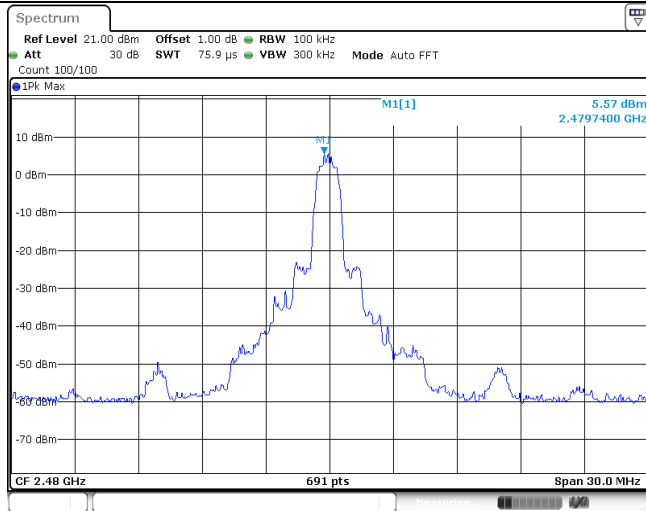

CH78
30MHz~1000MHz

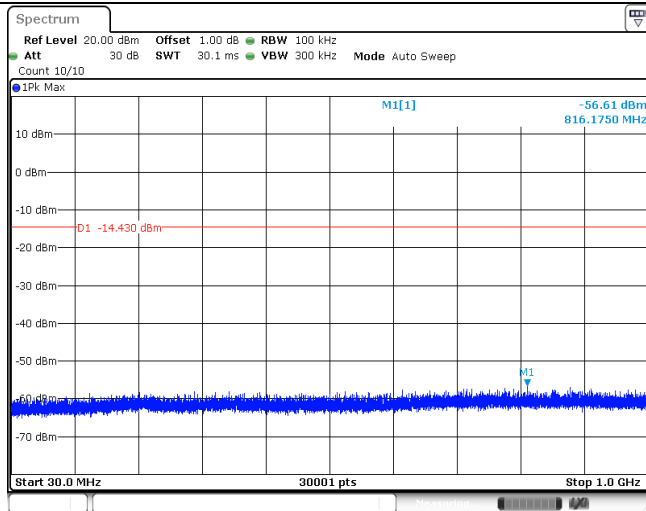

CH78
1GHz~26GHz

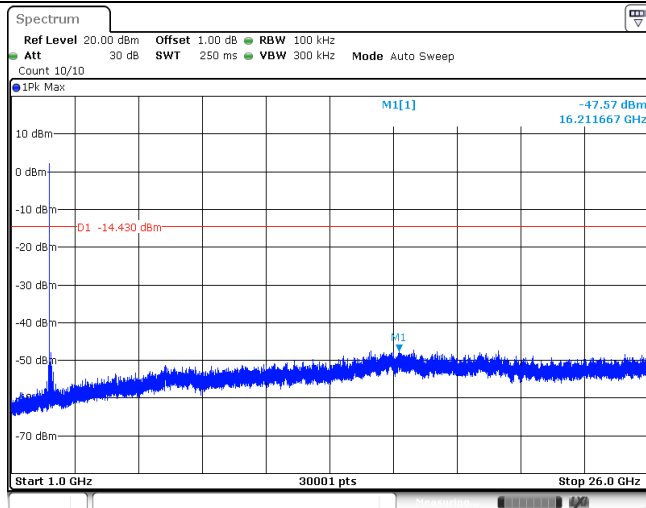

Test Item:	SE	Modulation type:	8DPSK
<p>CH00 Reference level</p>			
<p>CH00 30MHz~1000MHz</p>			
<p>CH00 1GHz~26GHz</p>			

<p>CH39 Reference level</p>	
<p>CH39 30MHz~1000MHz</p>	
<p>CH39 1GHz~26GHz</p>	

CH78
Reference level

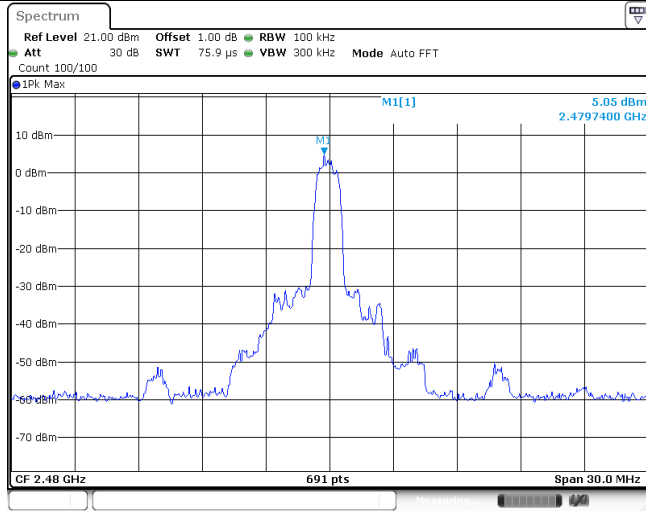

CH78
30MHz~1000MHz

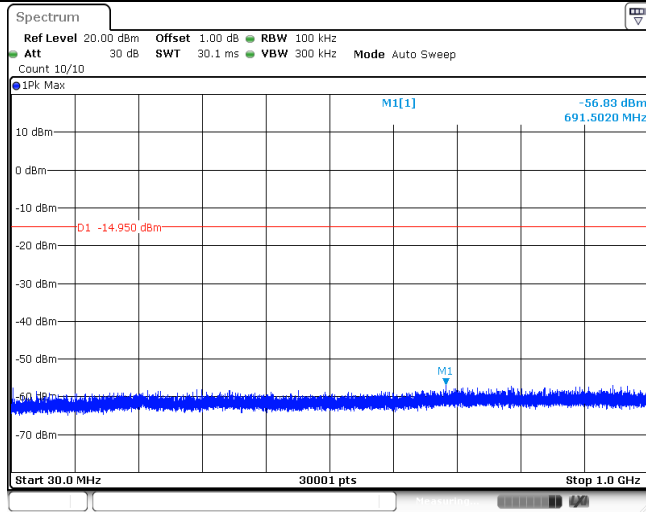

CH78
1GHz~26GHz

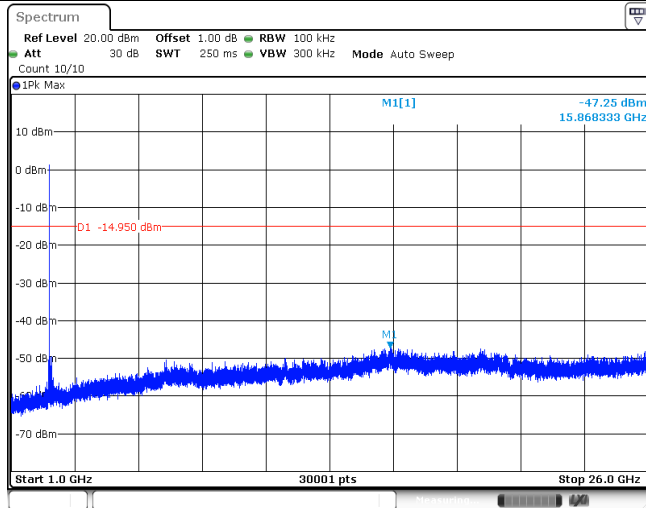

5.12. Radiated Band edge Emission

LIMIT

FCC CFR Title 47 Part 15 Subpart C Section 15.247 (d):

In any 100 kHz bandwidth outside the frequency band in which the spread spectrum or digitally modulated intentional radiator is operating, Radiated Emissions which fall in the restricted bands, as defined in §15.205(a), must also comply with the Radiated Emissions limits specified in §15.209(a) (see §15.205(c)).

TEST CONFIGURATION

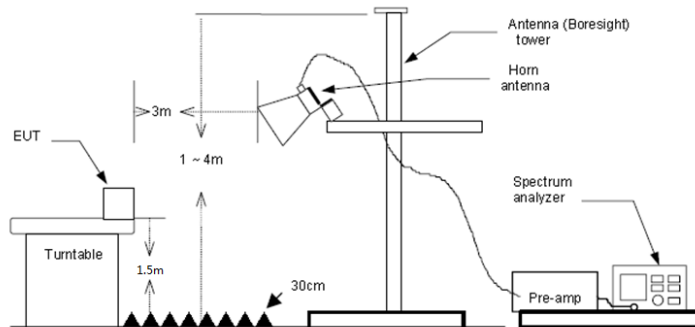

TEST PROCEDURE

1. The EUT was setup and tested according to ANSI C63.10 .
2. The EUT is placed on a turn table which is 1.5 meter above ground. The turn table is rotated 360 degrees to determine the position of the maximum emission level.
3. The EUT was positioned such that the distance from antenna to the EUT was 3 meters.
4. The antenna is scanned from 1 meter to 4 meters to find out the maximum emission level. This is repeated for both horizontal and vertical polarization of the antenna. In order to find the maximum emission, all of the interface cables were manipulated according to ANSI C63.10 on radiated measurement.
5. Use the following spectrum analyzer settings:
 - a) Span shall wide enough to fully capture the emission being measured
 - b) Set RBW=100kHz for <1GHz, VBW=3*RBW, Sweep time=auto, Detector=peak, Trace=max hold
 - c) Set RBW=1MHz, VBW=3MHz for >1GHz, Sweep time=auto, Detector=peak, Trace=max hold for Peak measurementFor average measurement: use duty cycle correction factor method (DCCF)
Averager level = Peak level + DCCF

TEST MODE

Refer to the clause 4.3

TEST RESULT

Passed Not Applicable

Note:

- 1) Level= Reading + Factor; Factor =Antenna Factor+ Cable Loss- Preamp Factor
- 2) Over Limit = Level- Limit
- 3) Average measurement was not performed if peak level is lower than average limit(54 dBuV/m).

Test channel:		CH00			Polarity			Horizontal		
Mark	Frequency MHz	Reading dBuV/m	Antenna dB	Cable dB	Preamp dB	Level dBuV/m	Limit dBuV/m	Over limit	Remark	
1	2310.00	55.45	27.86	4.01	41.80	45.52	74.00	-28.48	Peak	
2	2390.03	56.34	27.54	4.31	41.80	46.39	74.00	-27.61	Peak	

Test channel:		CH00			Polarity			Vertical		
Mark	Frequency MHz	Reading dBuV/m	Antenna dB	Cable dB	Preamp dB	Level dBuV/m	Limit dBuV/m	Over limit	Remark	
1	2310.00	56.09	27.86	4.01	41.80	46.16	74.00	-27.84	Peak	
2	2390.03	55.49	27.54	4.31	41.80	45.54	74.00	-28.46	Peak	

Test channel:		CH78			Polarity			Horizontal		
Mark	Frequency MHz	Reading dBuV/m	Antenna dB	Cable dB	Preamp dB	Level dBuV/m	Limit dBuV/m	Over limit	Remark	
1	2483.50	60.27	27.33	4.18	41.80	49.98	74.00	-24.02	Peak	
2	2500.00	50.37	27.30	4.19	41.80	40.06	74.00	-33.94	Peak	

Test channel:		CH78			Polarity			Vertical		
Mark	Frequency MHz	Reading dBuV/m	Antenna dB	Cable dB	Preamp dB	Level dBuV/m	Limit dBuV/m	Over limit	Remark	
1	2483.50	59.79	27.33	4.18	41.80	49.50	74.00	-24.50	Peak	
2	2500.00	49.23	27.30	4.19	41.80	38.92	74.00	-35.08	Peak	

5.13. Radiated Spurious Emission

LIMIT

FCC CFR Title 47 Part 15 Subpart C Section 15.209

Frequency	Limit (dBuV/m)	Value
0.009 MHz ~0.49 MHz	2400/F(kHz) @300m	Quasi-peak
0.49 MHz ~ 1.705 MHz	24000/F(kHz) @30m	Quasi-peak
1.705 MHz ~30 MHz	30 @30m	Quasi-peak

Note: Limit dBuV/m @3m = Limit dBuV/m @300m + 40*log(300/3)= Limit dBuV/m @300m +80,

Limit dBuV/m @3m = Limit dBuV/m @30m +40*log(30/3)= Limit dBuV/m @30m + 40.

Frequency	Limit (dBuV/m @3m)	Value
30MHz~88MHz	40.00	Quasi-peak
88MHz~216MHz	43.50	Quasi-peak
216MHz~960MHz	46.00	Quasi-peak
960MHz~1GHz	54.00	Quasi-peak
Above 1GHz	54.00	Average
	74.00	Peak

TEST CONFIGURATION

- 9 kHz ~ 30 MHz

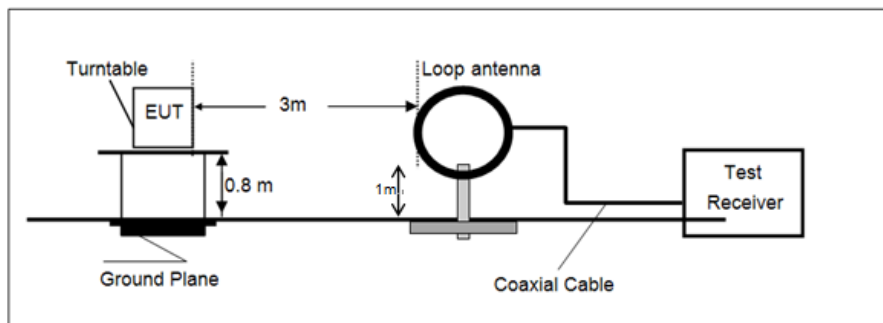

- 30 MHz ~ 1 GHz

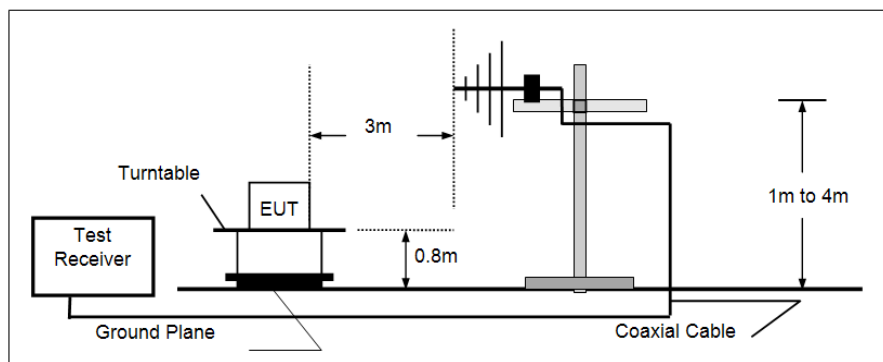

- Above 1 GHz

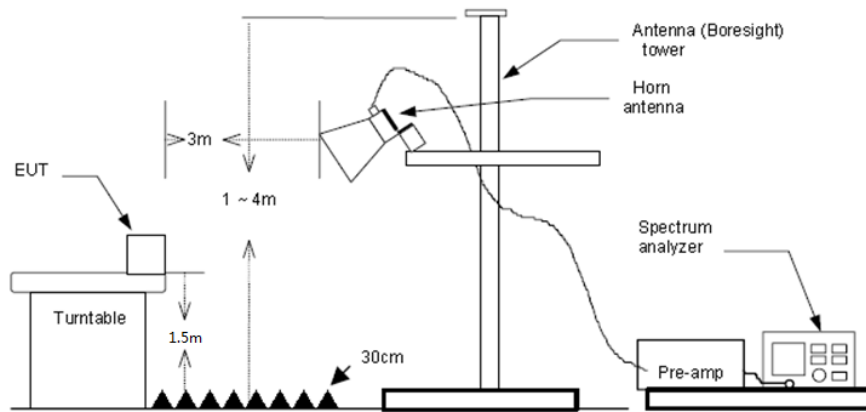

TEST PROCEDURE

1. The EUT was setup and tested according to ANSI C63.10.
2. The EUT is placed on a turn table which is 0.8 meter above ground for below 1 GHz, and 1.5 m for above 1 GHz. The turn table is rotated 360 degrees to determine the position of the maximum emission level.
3. The EUT was set 3 meters from the receiving antenna, which was mounted on the top of a variable height antenna tower.
4. For each suspected emission, the EUT was arranged to its worst case and then tune the Antenna tower (from 1 m to 4 m) and turntable (from 0 degree to 360 degrees) to find the maximum reading. A pre-amp and a high pass filter are used for the test in order to get better signal level to comply with the guidelines.
5. Set to the maximum power setting and enable the EUT transmit continuously.
6. Use the following spectrum analyzer settings
 - a) Span shall wide enough to fully capture the emission being measured;
 - b) Below 1 GHz:
RBW=120 kHz, VBW=300 kHz, Sweep=auto, Detector function=peak, Trace=max hold;
If the emission level of the EUT measured by the peak detector is 3 dB lower than the applicable limit, the peak emission level will be reported. Otherwise, the emission measurement will be repeated using the quasi-peak detector and reported.
 - c) Set RBW=1MHz, VBW=3MHz for >1GHz, Sweep time=auto, Detector=peak, Trace=max hold for Peak measurement
For average measurement: use duty cycle correction factor method (DCCF)
Averager level = Peak level + DCCF

TEST MODE

Refer to the clause 4.3

TEST RESULT

Passed **Not Applicable**

Note:

- 1) Level= Reading + Factor/Transd; Factor/Transd =Antenna Factor+ Cable Loss- Preamp Factor
- 2) Over Limit = Level- Limit
- 3) Average measurement was not performed if peak level is lower than average limit(54 dBuV/m) for above 1GHz.

For 9 kHz ~ 30 MHz

The EUT was pre-scanned this frequency band, found the radiated level 20dB lower than the limit, so don't show data on this report.

For 30 MHz ~ 1000 MHz

Have pre-scan all test channel, found CH39 which it was worst case, so only show the worst case's data on this report.

Polarization:

Horizontal

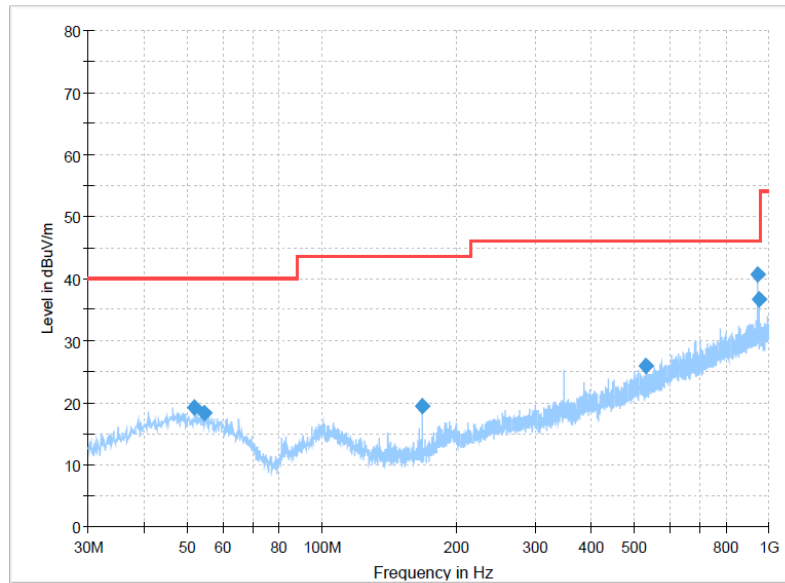

Final Result

Frequency (MHz)	MaxPeak (dBuV/m)	Limit (dBuV/m)	Margin (dB)	Height (cm)	Pol	Azimuth (deg)	Corr. (dB/m)
51.8250	19.17	40.00	20.83	100.0	H	0.0	-8.8
54.6138	18.41	40.00	21.59	100.0	H	75.0	-9.1
167.6188	19.53	43.50	23.97	100.0	H	200.0	-13.5
531.1263	25.82	46.00	20.18	300.0	H	98.0	-1.5
945.1950	40.77	46.00	5.23	100.0	H	275.0	7.1
948.4688	36.75	46.00	9.25	100.0	H	294.0	7.1

Polarization:

Vertical

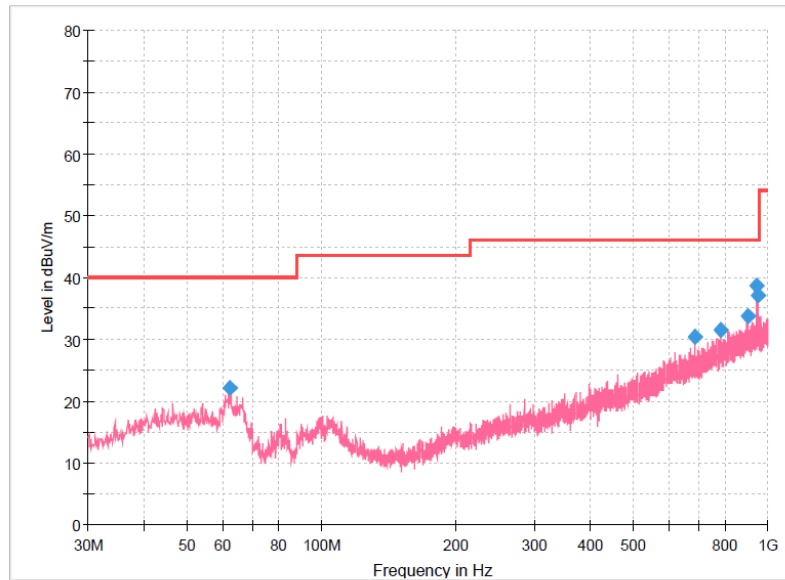

Final Result

Frequency (MHz)	MaxPeak (dBuV/m)	Limit (dBuV/m)	Margin (dB)	Height (cm)	Pol	Azimuth (deg)	Corr. (dB/m)
62.1313	22.13	40.00	17.87	100.0	V	163.0	-10.5
687.5388	30.48	46.00	15.52	100.0	V	214.0	2.1
783.6900	31.59	46.00	14.41	100.0	V	246.0	4.2
900.6963	33.66	46.00	12.34	100.0	V	37.0	6.7
945.1950	38.70	46.00	7.30	100.0	V	163.0	7.1
948.4688	37.19	46.00	8.81	100.0	V	0.0	7.1

For 1 GHz ~ 25 GHz

Test channel		CH00			Polarity			Horizontal		
Mark	Frequency MHz	Reading dBuV/m	Antenna dB	Cable dB	Preamp dB	Level dBuV/m	Limit dBuV/m	Over limit	Remark	
1	2987.92	58.69	28.50	4.77	41.66	50.30	74.00	-23.70	Peak	
2	4809.50	51.69	31.28	6.00	41.34	47.63	74.00	-26.37	Peak	
3	4983.99	50.27	31.34	6.08	41.12	46.57	74.00	-27.43	Peak	
4	9611.66	42.99	39.12	9.31	41.13	50.29	74.00	-23.71	Peak	

Test channel		CH00			Polarity			Vertical		
Mark	Frequency MHz	Reading dBuV/m	Antenna dB	Cable dB	Preamp dB	Level dBuV/m	Limit dBuV/m	Over limit	Remark	
1	2995.54	58.04	28.50	4.75	41.65	49.64	74.00	-24.36	Peak	
2	4004.08	53.32	29.81	5.63	41.46	47.30	74.00	-26.70	Peak	
3	7009.96	48.26	35.14	7.35	40.89	49.86	74.00	-24.14	Peak	
4	9611.66	43.47	39.12	9.31	41.13	50.77	74.00	-23.23	Peak	

Test channel		CH39			Polarity			Horizontal		
Mark	Frequency MHz	Reading dBuV/m	Antenna dB	Cable dB	Preamp dB	Level dBuV/m	Limit dBuV/m	Over limit	Remark	
1	2987.92	57.72	28.50	4.77	41.66	49.33	74.00	-24.67	Peak	
2	4983.99	44.49	31.34	6.08	41.12	40.79	74.00	-33.21	Peak	
3	7981.72	41.17	36.96	7.99	40.85	45.27	74.00	-28.73	Peak	
4	10453.95	39.29	39.95	9.73	40.77	48.20	74.00	-25.80	Peak	

Test channel		CH39			Polarity			Vertical		
Mark	Frequency MHz	Reading dBuV/m	Antenna dB	Cable dB	Preamp dB	Level dBuV/m	Limit dBuV/m	Over limit	Remark	
1	2987.92	58.75	28.50	4.77	41.66	50.36	74.00	-23.64	Peak	
2	4996.69	53.35	31.39	6.09	41.11	49.72	74.00	-24.28	Peak	
3	7009.96	48.77	35.14	7.35	40.89	50.37	74.00	-23.63	Peak	
4	9759.59	43.33	39.30	9.46	41.31	50.78	74.00	-23.22	Peak	

Test channel		CH78			Polarity			Horizontal		
Mark	Frequency MHz	Reading dBuV/m	Antenna dB	Cable dB	Preamp dB	Level dBuV/m	Limit dBuV/m	Over limit	Remark	
1	2995.54	56.14	28.50	4.75	41.65	47.74	74.00	-26.26	Peak	
2	4958.68	45.35	31.23	6.07	41.16	41.49	74.00	-32.51	Peak	
3	7941.19	40.36	36.85	7.97	40.93	44.25	74.00	-29.75	Peak	
4	9935.05	42.91	39.30	9.50	41.45	50.26	74.00	-23.74	Peak	

Test channel		CH78			Polarity			Vertical		
Mark	Frequency MHz	Reading dBuV/m	Antenna dB	Cable dB	Preamp dB	Level dBuV/m	Limit dBuV/m	Over limit	Remark	
1	2995.54	58.01	28.50	4.75	41.65	49.61	74.00	-24.39	Peak	
2	3993.90	52.80	29.79	5.62	41.46	46.75	74.00	-27.25	Peak	
3	4996.69	48.20	31.39	6.09	41.11	44.57	74.00	-29.43	Peak	
4	6992.14	45.88	35.07	7.34	40.89	47.40	74.00	-26.60	Peak	

6. TEST SETUP PHOTOS

Radiated Emission

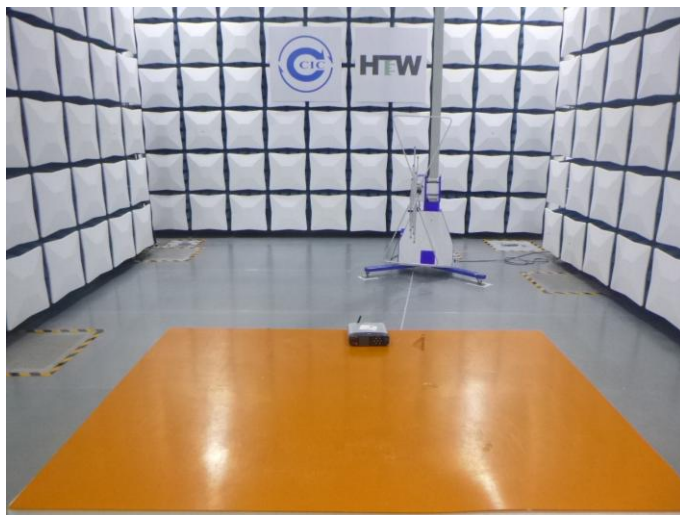

7. EXTERNAL AND INTERNAL PHOTOS

Refer to the test report No.: CHTEW23100110.

8. APPENDIX REPORT