

INSTRUCTION MANUAL
TM2210
DMR Mobile Radio

TM2210 Digital Mobile Radio User Manual

Thank you for choosing Tait mobile radio.

We believe that the product will bring much convenience to your work and life.

Tait mobile radios adopt advanced technology and fine technique.

We hope that you will be satisfied with the quality and functions of the product.

Notice

- ◆ Please read the manual carefully before using the product. We consider that you have acquainted with the manual when you start to use the product.
- ◆ Please keep the manual well for further reference.
- ◆ To prevent infringement to your legal rights, please fill in the Warranty Card carefully and faithfully and acquire a purchase voucher when you buy the product.
- ◆ The intellectual property of all parts of the product, including accessories, is owned by Tait and its authorized subjects. Without permission of Tait and such subjects, no copy, extraction or translation of such parts is allowed.
- ◆ The product is subject to change because of upgrading or improvement. Tait reserves the right to change the specifications of software and hardware mentioned in the manual from time to time without prior notification. The specifications and information in the manual is only for your reference.
- ◆ Despite of careful verification, the manual might contain mistakes. Tait reserves the right of final interpretation of the manual.

Safety Precaution

According to governmental decrees, it is prohibited to operate radio transmitters without permission within the area of its jurisdiction. Violation to such stipulations may result in penalty or be arrest. Maintenance on the product can be performed only by professional technicians.

For safety, it is important that a user learns knowledge of common hazards in using a radio transmitter.

Warning: Power off the radio in explosive environment with dangerous gas, dust or mist, for example, when refueling or parking at a gas station.

Battery

To prevent fire, personal injury and damage to the radio, please abide by the followings.

- ◆ It is suggested to have the radio to transmit continuously for 1 minute and receive continuously for 4 minutes at most at a time. Transmissions for a long time or continuous operation under high power will result in overheat at the back of the radio.
- ◆ Never disassemble this radio.
- ◆ Keep the radio away from direct sunshine for a long time. Do not place it near a heater.
- ◆ Do not place the radio in a place with a lot of dust, damp or splash of water, or on an unstable surface.
- ◆ Power off the radio immediately in case it gives out smell or smoke, and then contact the local dealer.

CONTENTS

1. UNPACKING	3
2. OVERVIEW	5
2.1 APPEARANCE.....	5
2.2 PROGRAMMING KEYS.....	6
2.3 ICONS.....	9
2.4 LED INDICATOR.....	11
3. INSTALLATION	11
4. BASIC FUNCTIONS	13
4.1 POWER ON/OFF.....	13
4.2 SELECTING A ZONE.....	14
4.3 SELECTING A CHANNEL.....	14
4.4 REGULATING VOLUME.....	15
4.5 VOLUME/CHANNEL KNOB.....	15
4.6 INITIATING A CALL.....	15
4.7 RECEIVING/REPLYING TO A CALL.....	16
5. ADVANCED FUNCTIONS	17
5.1 SHORT MESSAGE.....	17

5.2 SCANNING CHANNELS.....	19
5.3 EMERGENCY ALARM.....	22
5.4 CALL LOGS (DIGITAL MODE ONLY).....	25
5.5 SETTINGS.....	27
5.6 APPLICATION.....	30
5.7 DETECTING A RADIO.....	32
5.8 CALL ALERT.....	32
5.9 MONITORING.....	33
5.10 LONE WORKER.....	34
5.11 ENCRYPTION (DIGITAL CHANNEL ONLY).....	35
5.12 SCRAMBLING* (ANALOGUE CHANNEL ONLY).....	35
6. TROUBLE SHOOTING.....	36

1. Unpacking

Open the packing box carefully and find the parts as listed below. If any item is missing or damaged, please contact the dealer.

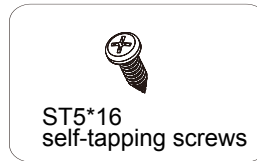
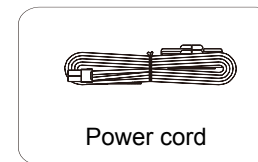
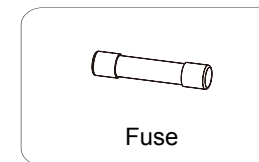
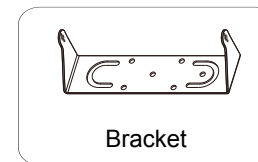
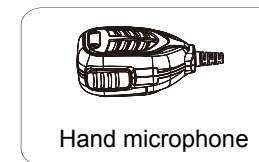
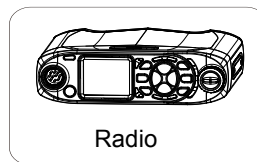

Please find the following items in the package.

SN	Item	QTY
1	Radio	1
2	Hand microphone	1
3	Bracket	1
4	Microphone stand, with 3 M2.6*10 self-tapping screws	1
5	Fuse	2
6	Power cord	1
7	ST5*16 self-tapping screw	4
8	Wing screw (flat washer and spring washer included)	4
9	Certificate of Approval	1
10	User Manual or Quick Installation Guide	1

2. Overview

2.1 Appearance

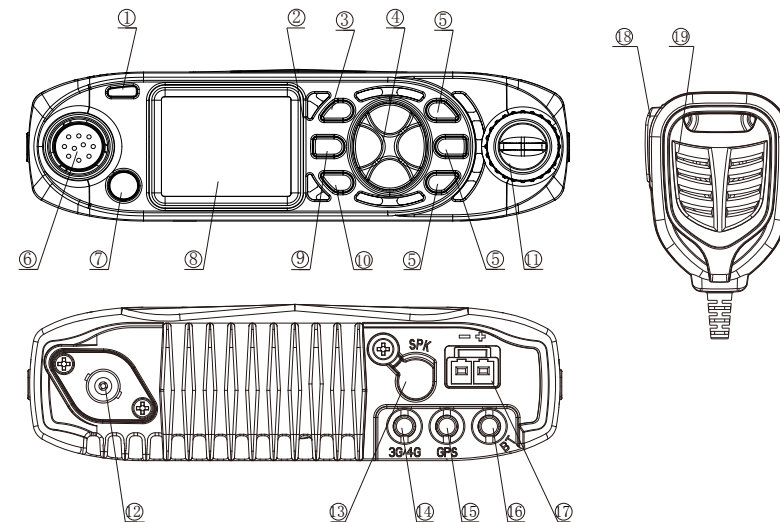

SN	Item	SN	Item
1	LED Indicator	2	Speaker
3	Menu/OK Key	4	Up/Down/Left/Right Keys
5	P1~P3(Programming Keys) Down Key	6	Hand Microphone/Programming Interface
7	Emergency Key	8	LCD Screen
9	On/Off Key	10	Return Key
11	Volume/Channel Knob	12	RF Antenna Interface
13	External Speaker Interface	14	3G/4G Antenna Interface (Optional)
15	GPS Antenna Interface (Optional)	16	Bluetooth Antenna Interface (Optional)
17	Power Interface	18	PTT Key
19	Microphone		

2.2 Programming Keys

To cater to users' habits of operating the radio, programmable keys (P1, P2 and P3) are provided, which can be set as shortcut keys through programming by the dealer.

SN	Programmable Function	Description
1	Void	No function. The error alert will be heard when the key is pressed.

2	High/Low Power	Switch between high and low power.
3	Monitor	If signaling is transmitted through the current analogue channel, press the key to switch to carrier squelch mode (i.e. cancel signaling). Voice is output when the carrier is matched. Press the key again to go back to the previous state.
4	Squelch On/Off	Enable/disable squelch. It can be used to receive weak signals in an analogue channel.
5	Squelch Level	Adjust signal strength required to receive signals.
6	Scan	Enable/disable scanning. It is used to monitor the communication activities in other channels.
7	Delete Channel of Spurious Emission	If you don't need a channel found through scanning, press it to delete the channel from the scan list.
8	LCD Backlight Type	Press it to enter the Screen Backlight interface to adjust the duration of LCD backlight.
9	Repeater/ Talk around	In a channel allowing <u>relay</u> , the radio can communicate with another radio through a repeater or directly. Press this key to switch between these two communication modes.
10	Zone Selection	Switch to the current zone to another.

11	Home Interface	Return to the home interface.
12	Home Channel	Switch to a preset channel.
13	Keyboard Lock	Lock or unlock the keyboard.
14	One-Key Call (1~6)	Press the key to make a call or send a message.
15	Scramble*/Encrypt	For a channel allowing scrambling*/encryption, press the key to enable/disable encryption. To ensure communication privacy, voice and short messages can be encrypted through scrambling/encryption.
16	Contact	Press it to go to the Contact interface.
17	Short Message	Press it to go to the Short Message interface.
18	Call Record	Press it to go to the Call Record interface.
19	Call Alert	When viewing or after selecting a contact of individual call or a contact of call alert, press it to send a call alert to the contact.
20	Interrupt Emission	Interrupt calls in current channel so that the channel becomes idle.

Note:









A key can be programmed with pressing, or pressing and holding to achieve different functions. You can have keys programmed by your dealer.













Press: Press down a key and release quickly.

Press and hold: Press down a key and hold for the duration programmed before release. (The duration can be set in programming settings.)

A function marked with * is to be developed.

2.3 Icons

Name	Icon	Description
Signal Strength		No signal
		The number of bars indicates the received signal strength.
Short Message		There is new message/unread message.
		Message inbox is full.
Encryption or Scrambling		Analogue scrambling or digital encryption is enabled.
Mute		The speaker is mute when the volume is adjusted to 0.
Transmitting Power		High TX power for the current channel.
		Low TX power for the current channel.
Talk Around		If talk-around mode is disabled, i.e. direct mode is

		enabled, this icon is displayed.
Emergency Alarm		The radio is operating under emergency alarm mode.
GPS		Locationing is successful and data is being received.
		GPS function is enabled, but no data can be received.
Scan		When the icon rotates, scanning is in progress.
		Scanning stops in the prior channel 1 or 2.
		Scanning stops in a conventional channel.
Accessory State		The USB cable is connected.
Lone Worker		The function is enabled.
Call		A call is being made.
		A call is being received.
Channel Type		An individual call is being made.
		A group call is being made.
		An all call is being made

2.4 LED Indicator

State	Description
Red light on	Transmitting signals
Green light on	Receiving signals
Orange light on	A call is received, and the radio is in the duration before automatic reset (under analogue mode) * or in the duration before call hangup (under analogue mode).
Orange light flashing	The radio is in alarm state, or a missed call or call alert is received, or scanning is under progress.
Red light flashing	An emergency alarm is being received, or startup self-test fails.

3. Installation

Before installing the radio, please read carefully.

Attentions

- The radio should be installed in a position where it can be used conveniently and personal injury can be avoided while driving a vehicle in poor road condition.

- While drilling holes, protect the internal wires of a vehicle or of other devices from being damaged.
- Leave enough space behind the radio for wiring.
- Make sure the power cord is long enough so that the radio can be maintained with the power connected.
- While replacing the fuse, make sure a fuse meeting requirements is used.

Installation Steps

1. Use the ST5*16 self-tapping screw to install the bracket at a position in a vehicle where operation is convenient.
2. Use the wing screws to fix the mobile onto the bracket.
3. Wire the 3m power cord, and connect the open end to the engine battery or other power supply (with supply voltage not higher than 16V). Make sure the red wire is connected to the anode and the black wire to the cathode.
4. Install the supplied fuse, and connect the power plug to the power interface at the rear of the radio.
5. Connect the antenna to the radio.
6. Use the M2.6*10 self-tapping screws to fix the microphone stand onto a position where operation is convenient.

7. Plug the hand microphone (with the direction sign on the top) into the corresponding interface of the radio, and rotate clockwise the cover lock on the plug. When the lock contacts the slot on the radio, press it a bit and continue to rotate it until it is tight.

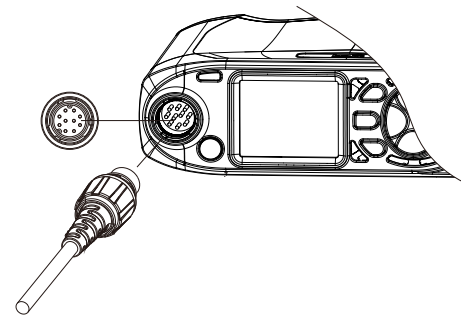

Note:

To detach the hand microphone, just rotate counterclockwise the cover lock on the plug of the microphone.

4. Basic Functions

4.1 Power On/Off

- Power On

Press the Power On/Off key and hold until the startup interface is displayed on the LCD screen, and then release the key. Backlight is on automatically, and voice prompt “di di” is given off.

- Power Off

When the radio is on, press the Power On/Off key and hold until the shutdown interface is displayed, and then release the key. The radio is powered off.

4.2 Selecting a Zone

A zone is a group of channels. You can put channels with the same property into a zone, so as to switch quickly among different channel groups under different working environments. The radio supports a maximum of 16 zones, each supporting a maximum of 16 channels.

To switch to a zone, perform the followings.

1. In the home interface, press the Menu key.
2. Select “Zone” by pressing the Up and Down keys.
3. Press the Menu/OK key.
4. Select a zone by pressing the Up and Down keys.
5. Press the Menu/OK key.

4.3 Selecting a Channel

To switch to another channel, there are two ways.

1. In the home interface, press the Up and Down keys to switch to another channel in the zone.

2. In the Channel Switching interface, rotate the Volume/Channel knob clockwise to switch to a channel of a bigger number, or rotate it counterclockwise to switch to a channel of a smaller number.

Note:

Every channel can be configured as an analogue or a digital channel. In analogue mode, some functions are disabled, for example, short messages, and corresponding menu items are hidden.

4.4 Regulating Volume

Turn the Volume/Channel knob clockwise to increase the volume or counterclockwise to decrease it.

4.5 Volume/Channel Knob

By default, the Volume/Channel knob achieves volume adjustment, and you may press it to switch from volume mode to channel mode.

4.6 Initiating a Call

You can initiate a call in any of the following ways.

- Call a default contact

If a default contact for each channel is preset, press the PTT key to call the contact.

- Select and Call a Contact

1. In the home interface, press the Menu key.
2. Select “Contact” by pressing the Up and Down keys.
3. Press the Menu/OK key.
4. Select “Contact List” by pressing the Up and Down keys.
5. Select a contact by pressing the Up and Down keys.
6. Press the PTT key.

- Dial to Call a Contact





1. In the home interface, press the Menu key.
2. Select “Contact” by pressing the Up and Down keys.
3. Press the Menu/OK key.
4. Select “Manual Dialup” by pressing the Up and Down keys.
5. Enter the ID of a contact.
6. Press the PTT key.

- Call a Contact by Pressing a One-Key Call Key

You can call a contact of individual call, or contacts of group call by pressing a programmed one-key call key. One contact can be set for a one-key call key, and you may have multiple keys programmed as one-key call keys by you dealer.

4.7 Receiving/Replying to a Call

When a call is received, the radio is automatically switched to receiving mode. Green LED indicator light is on,

and a call icon ( individual call,  group call, and  all call), alias or ID, and incoming call icon  are displayed on the LCD screen.

Note:

To receive a group call from another user, you need to have the radio set as a member of the group. The setting can be done by your dealer.

5. Advanced Functions

5.1 Short Message

You can receive and send short messages, each containing have up to 300 characters.

5.1.1 Editing and Sending a Short Message

To edit and send a short message, perform the followings.

1. In the home interface, press the Menu key.
2. Select “Short Message” by pressing the Up and Down keys.
3. Press the Menu/OK key.
4. Select “New Message” by pressing the Up and Down keys.
5. Enter content.

Note:

While entering content, you can:

- Move the cursor by rotating the Volume/Channel knob.

- Switch to another input method by pressing #, or switch between upper case and lower case.
- Under non-digit input mode, enter punctuations by pressing “1”.
- Delete the previous character to the cursor by select “Delete”.

6. After editing, click the Menu/OK key.

7. Select “Send” by pressing the Up and Down keys.

8. Select a contact, and click the Menu/OK key.

After the message is sent successfully, “Message sent successfully” is displayed on the screen with a voice prompt. Otherwise, “Message sending failed” is displayed with a voice prompt. Then, the radio returns to the Short Message interface.

5.1.2 Sending a Quick Message

You can set up to 10 quick messages, and have the setting done by your dealer. Before sending a quick message, you can edit it.

To send a quick message, perform the followings.

1. In the home interface, press the Menu key.
2. Select “Short Message” by pressing the Up and Down keys.
3. Press the Menu/OK key.
4. Select “Template” by pressing the Up and Down keys.
5. Press the Menu/OK key.
6. Select a template message.
7. Press the Menu/OK key, and edit the message.

8. After editing, click the Menu/OK key.

9. Select “Send” by pressing the Up and Down keys.

10. Select a contact, and press the Menu/OK key.

5.1.3 Receiving a Message

When a short message is received, a message will be prompted on the LCD screen, and the icon of unread message  will be displayed in the status bar.

To read the message, go to the inbox by pressing the Menu/OK key and selecting Short Message > Inbox.

5.2 Scanning Channels

To receive voice and data in other channels, channel scanning should be deployed. This can be done through programming by your dealer. The radio supports up to 16 scan lists, each containing up to 16 channels.

Analogue and digital channels can be scanned in one scan.

You can add or delete a scan list, or edit its priority level.

5.2.1 Editing Scan List

Viewing Scan List

1. In the home interface, press the Menu key.
2. Select “Scan” by pressing the Up and Down keys.
3. Press the Menu/OK key.

4. Select “View Scan List”, and view the channels in the list (P1 prior channel 1, P2 prior channel 2, N normal channel).

Note:

In a scan list, you can set prior channel 1 and prior channel 2, and they are not displayed if not set.

Adding Scan Channel

1. In the home interface, press the Menu key.
2. Select “Scan” by pressing the Up and Down keys.
3. Press the Menu/OK key.
4. Select “Edit Scan List” and then “Add”.
5. Select a channel, and add it to the scan list.

Deleting Scan List

1. In the home interface, press the Menu key.
2. Select “Scan” by pressing the Up and Down keys.
3. Press the Menu/OK key.
4. Select “Edit Scan List” and then “Delete”.
5. Select a channel, and delete it from the scan list.

Setting Prior Channel

1. In the home interface, press the Menu key.
2. Select “Scan” by pressing the Up and Down keys.
3. Press the Menu/OK key.
4. Select “Edit Scan List” and then “Edit Prior Channel”.
5. Set a prior channel by selecting “Set Prior Channel 1” or “Set Prior Channel 2”.

6. Cancel a prior channel by selecting “Cancel Prior Channel”.

5.2.2 Enabling/Disabling Scanning

1. In the home interface, press the Menu key.
2. Select “Scan” by pressing the Up and Down keys.
3. Press the Menu/OK key.
4. Select “Scan On/Off”.
5. Press the Menu/OK key.
6. Select “Enable Scan” or “Disable Scan” by pressing the Up and Down keys.
7. Press the Menu/OK key.

Note:

The radio only scans the selected channel (i.e. the starting channel) to receive data (including short messages, GPS information, telemetering information and PC data).

5.2.3 Transmitting during Scan

If traffic is found in a channel during a scan, the radio will listen to the channel. The dwelling duration is called scan suspension duration, which is set using the programming software.

1. Keep the speaker close to the mouth. If indication of channel idleness has been enabled on the radio, you will hear a short prompt tone (to indicate channel idleness) when the PTT key is released on the target radio. Now you may reply to the radio.

2. Within the scan suspension duration, press the PTT key. The red LED indicator light will be on.
3. After the prompt tone for talk (if enabled) is over, speak into the microphone.
4. To receive voice, release the PTT key.
5. If you do not reply within the scan suspension duration, the radio will resume channel scanning.

5.2.4 Deleting Noise Channel

If noise frequently occurs in a channel, you may delete the channel from the scan list by pressing the key programmed as “Delete Noise Channel”.

Note:

A prior channel or a selected channel or the only one channel in a scan list cannot be deleted.

5.3 Emergency Alarm

Under emergency, you can send an emergency alarm to another user or the control center by pressing the Emergency Alarm key. Emergency alarm has the highest priority, so you can send an emergency alarm at any time, no matter the radio is transmitting or receiving traffic.

The radio supports three emergency alarm modes, and you can have one mode set by your dealer.

- Emergency Alarm Only

In this mode, you can send an alarm message but cannot talk to a user or the control center by pressing the Emergency Alarm key.

- Emergency Alarm and Call

In this mode, you can send an alarm message by pressing the Emergency Alarm key, and send voice and

background tone by pressing the PTT key and talking into the microphone.

- Emergency Alarm Followed by Voice

In this mode, you can send an alarm message by pressing the Emergency Alarm key, and send voice and background tone by talking into the microphone. You don't need to press the PTT key.

In any of the above modes, there are four alarm types. You can have one type set by your dealer.

- Siren Only

During an emergency alarm, siren is given off on the radio, but the control center does not receive an alarm signal.

- Normal

During an emergency alarm, there is audio-video prompt.



- Secret

During an emergency alarm, there is no audio-video prompt. The speaker is not turned on when speech is received unless the PTT key is pressed.

- Secret with Voice

During an emergency alarm, there is no audio-video prompt, but call can be received. There is no audio-video prompt when speech is received unless the PTT key is pressed.

5.3.1 Sending Emergency Alarm

To send an emergency alarm, press the Emergency Alarm key. The emergency alarm icon  will be displayed in the status bar, and the alias or ID of an emergency group call, emergency alarm icon  and outgoing

message icon  will be displayed on the LCD screen.

When a response is received, “Emergency alarm succeeded” will be displayed on the LCD screen.

When no response is received and the maximum times of alarm have reached, “Emergency alarm failed” will be displayed on the LCD screen. The radio will quit emergency alarm mode automatically.

Note:

If the alarm type is Secret or Secret with Voice, there is no audio-video prompt during an emergency alarm.

5.3.2 Receiving Emergency Alarm

To receive an emergency alarm, “Emergency Alarm Indication” must be enabled, otherwise. This can be set using the programming software.

To receive an emergency alarm, you need to set the radio as a member of the group using the programming software.

When an emergency alarm is received, the emergency alarm icon  will be displayed in the status bar, and

the sender’s alias or ID, emergency alarm icon  and emergency alarm type icon on the LCD screen. The radio gives off alarm tones regularly, red LED light flashes. You may cancel the alarm by pressing any key.

5.3.3 Quitting Emergency Alarm

The radio quits emergency alarm in one of the following situations.

- In Emergency Alarm Only mode, a response is received.
- The preset maximum times of emergency alarm have reached, but no response is received.
- The Emergency Alarm key pressed and held.

5.4 call logs (Digital Mode Only)

This function enables you to view and manage the records of recent outgoing calls, received calls and missed calls. Individual calls but group calls are recorded. This function works only under digital mode.

5.4.1 Viewing Recent Calls

To view the records of recent calls, perform the followings.

1. In the home interface, press the Menu key.
2. Select “call logs” by pressing the Up and Down keys.
3. Press the Menu/OK key.
4. Select “Missed Calls”, “Outgoing Calls” or “Received Calls” by pressing the Up and Down keys.
5. Press the Menu/OK key.
6. Select a record by pressing the Up and Down keys.
7. Select “Details” to view the details of the record.
8. (Optional) You may call the contact by pressing the PTT key.

5.4.2 Storing Call Record to Contact List

To store a call record to the contact list, perform the followings.

1. Select a record from the list of missed calls, outgoing calls or received calls.
2. Select “Save” to go to the Add Contact interface.
3. Enter a contact name.
4. Press the Menu/OK key.

5.4.3 Deleting Call Record

Deleting One Call Record

1. Select a record from the list of missed calls, outgoing calls or received calls.
2. Select “Delete”.
3. Press the Menu/OK key.

Deleting All call logs

1. In the home interface, press the Menu key.
2. Select “call logs” by pressing the Up and Down keys.
3. Press the Menu/OK key.
4. Select “Missed Calls”, “Outgoing Calls” or “Received Calls” by pressing the Up and Down keys.
5. Press the Menu/OK key.
6. Select “Delete All”.
7. Select “OK”.

5.5 Settings

5.5.1 Selecting a Language

To select a language for the radio, perform the followings.

1. In the home interface, press the Menu key.
2. Select “Setting” by pressing the Up and Down keys.
3. Press the Menu/OK key.
4. Press “Language” by pressing the Up and Down key.
5. Press the Menu/OK key.
6. Select a language, and press the Menu/OK key.

5.5.2 Setting Prompt Tones

To turn on/off prompt tones or adjust volume, perform the followings.

1. In the home interface, press the Menu key.
2. Select “Setting” by pressing the Up and Down keys.
3. Press the Menu/OK key.
4. Select “Prompt Tone” by pressing the Up and Down keys.
5. Press the Menu/OK key.
6. Select “Prompt Tone Switch” by pressing the Up and Down keys.
7. Press the Menu/OK key.
8. Select on/off.

Note:

- “All prompt tones off”: All prompt tones are off.
 - “All prompt tones on”: All prompt tones are on.
 - “Prompt tone for outgoing calls”: Turn on/off the prompt tone for outgoing calls.
 - “Prompt tone for individual calls”: Turn on/off the prompt tone for received individual calls.
 - “Prompt tone for group calls”: Turn on/off the prompt tone for received group calls.
 - “Prompt tone for keystrokes”: Turn on/off the prompt tone for keystrokes.
 - “Prompt tone for messages”: Turn on/off the prompt tone for received messages.
9. (Optional) You can adjust the volume by pressing the Up and Down keys.
 10. Press the Menu/OK key.

5.5.3 Setting Power Level

To set high/low power for each channel, perform the followings.

1. In the home interface, press the Menu key.
2. Select “Setting” by pressing the Up and Down keys.
3. Press the Menu/OK key.
4. Select “Power Level” by pressing the Up and Down keys.
5. Press the Menu/OK key.
6. Select high/low power level.

5.5.4 Setting Squelch Level (Analogue Channel Only)

This function enables you to filter out unwanted calls under weak signals. Please perform the followings.

1. In the home interface, press the Menu key.
2. Select “Setting” by pressing the Up and Down keys.
3. Press the Menu/OK key.
4. Select “Squelch Level” by pressing the Up and Down keys.
5. Press the Menu/OK key.
6. Select a squelch level by pressing the Up and Down keys.
7. Press the Menu/OK key.

5.5.5 Enabling/Disabling LED Indicator

To enable/disable LED indicator, perform the followings.

1. In the home interface, press the Menu key.
2. Select “Setting” by pressing the Up and Down keys.
3. Press the Menu/OK key.
4. Select “LED Indicator” by pressing the Up and Down keys.
5. Press the Menu/OK key.
6. Choose to enable/disable LED indicator.
7. Press the Menu/OK key.

5.5.6 Device Information

To view the ID, SN, firmware version and hardware version of the radio, perform the followings.

1. In the home interface, press the Menu key.
2. Select “Setting” by pressing the Up and Down keys.
3. Press the Menu/OK key.
4. Select “Radio Information” by pressing the Up and Down keys.
5. Press the Menu/OK key.

5.6 Application

5.6.1 Setting GPS (Digital Channel Only)

To display the locating information of the radio, or submit updated locating information to the location application server, you need to enable the GPS function. This is set using the programming software.

To enable/disable the GPS function or view GPS information, perform the followings.

1. In the home interface, press the Menu key.
2. Select “Application” by pressing the Up and Down keys.
3. Press the Menu/OK key.
4. Select “GPS” by pressing the Up and Down keys.
5. Press the Menu/OK key.
 - To enable/disable the GPS function, take the 6~9 steps below after the step 5.
6. Select “GPS Switch” by pressing the Up and Down keys.
7. Press the Menu/OK key.
8. Enable/disable it.

9. Press the Menu/OK key.
 - To view GPS information, take the 10~11 steps below after the step 5.
10. Select “GPS Information” by pressing the Up and Down keys.
11. Press the Menu/OK key. You can view such information as the date, time, longitude, latitude and satellite.

5.6.2 Setting Time and Date

To set the time, perform the followings.

1. In the home interface, press the Menu key.
2. Select “Application” by pressing the Up and Down keys.
3. Press the Menu/OK key.
4. Select “Time” by pressing the Up and Down keys.
5. Press the Menu/OK key.
6. Select “Time Display”, and enable/disable clock display on the lower right of the standby interface.
7. Press the Menu/OK key to return to the Time menu.
8. Select “Time Format”, and select “12-hour” or “24-hour”.
9. Press the Menu/OK key to return to the Time menu.
10. Select “Date Display”, and enable/disable date display on the lower left of the standby interface.
11. Press the Menu/OK key to return to the Time menu.
12. Press “Date Format”, and select a format by pressing the Up and Down keys.
13. Press the Menu/OK key to return to the Time menu.
14. Select “Set Time”, and set time by pressing the Up and Down keys.
15. Press the Menu/OK key.

5.7 Detecting a Radio

To detect whether another radio (A) is powered on or operating in the channel the radio (B) is in, radio detection can be initiated from B without interfering A. Perform the followings.

1. In the home interface, press the Menu key.
2. Select “Contact” by pressing the Up and Down keys.
3. Press the Menu/OK key.
4. Select “Contact List” by pressing the Up and Down keys.
5. Press the Menu/OK key.
6. Select a contact of individual calls by pressing the Up and Down keys.
7. Select “Radio Detection”.
8. The contact’s alias or ID, and radio detection indication are displayed on the LCD screen. The red LED indicator is on. The radio is waiting for response from the target radio.

Note:

If the target radio is activated and responds, “Detection succeeded” will be displayed on the sender radio, otherwise, “Detection failed” will be displayed.

5.8 Call Alert

For a user authorized with this function, a contact can be requested to call back.

5.8.1 Receiving and Responding to Call Alert

1. If call alert decoding call has been enabled on the radio, the radio automatically response to a call alert after receiving it.
2. “Call alert...” and the caller’s alias/ID are displayed on the LCD screen.
3. The radio regularly gives off a tone, and green LED indicator light flashes.
4. You may call back the caller by pressing the PTT key to, or neglect this call alert by pressing any other key.

5.8.2 Initiating Call Alert

1. In the home interface, press the Menu key.
2. Select “Contact” by pressing the Up and Down keys.
3. Press the Menu/OK key.
4. Select “Contact List” by pressing the Up and Down keys.
5. Press the Menu/OK key.
6. Select a contact of individual calls by pressing the Up and Down keys.
7. Select “Call Alert”.
8. The contact’s alias or ID, and the indication of sending call alert are displayed on the LCD screen. The red LED indicator is on. The radio is waiting for response from the target radio.

Note:

If the target radio responds, “Call alert succeeded” will be displayed on the sender radio, otherwise, “Call alert failed” will be displayed.

5.9 Monitoring

This function enables you to listen remotely to the voice and background tone of another radio. This is achieved through turning on the microphone on the target radio without voice prompt or visible indication.

To use this function, the radio must be authorized beforehand.

To initiate remote monitoring, perform the followings.

1. In the home interface, press the Menu key.
2. Select “Management Function” by pressing the Up and Down keys.
3. Press the Menu/OK key.
4. Select “Remote Monitoring”.
5. Select a contact.

6. The contact’s alias or ID, and indication of remote monitoring initiation  are displayed on the LCD screen. The red LED indicator light is on. The radio is waiting for response from the target radio.

When a response is received,  will be displayed, and the radio will start receiving audio signals from the target radio until the preset duration is up. Then “Remote monitoring finished” will be displayed on the radio, and the LED indicator is off.

If no response is received when the preset times of command sending have reached, “Request of remote monitoring failed” will be displayed and the radio will exit sending mode.

Note:

While the radio is sending commands and waiting for response, you can terminate command resending and quit by pressing the On/Off key.

5.10 Lone Worker

This function enables the radio to send an emergency alarm if no operation (e.g. a keystroke) is performed on the radio within a preset response duration. This function needs to be set using the programming software. This function works as below.

1. If no operation is performed on the radio when a preset response duration is nearly up, the radio will give a preliminary alarm.
2. When a preliminary alarm is given, you can press any key to cancel it.
3. If no operation is performed when the preset response duration is up, an emergency alarm will be sent automatically.

5.11 Encryption (Digital Channel Only)

This function achieves encryption of voice or a short message to avoid interception by a user on the channel using third-party software, so that secret communication is ensured. Encrypted signals can be transmitted via a channel with encryption enabled, and decryption signals can also be received. This function needs to be set using the programming software.

Every channel supports the following two types of encryption. The setting can be done by your dealer.

- Basic encryption
- Enhanced encryption

A sending radio and a receiving radio sharing an encryption key can decrypt a call or data from each other. The radio cannot receive an encrypted call correctly if a different encryption type or encryption key is used on the sending radio.

5.12 Scrambling* (Analogue Channel Only)

This function achieves voice encryption to ensure secret communication. Scrambled signals can be received and sent only after enabling this function. This function needs to be set using the programming software.

To transmit signals correctly between a sending radio and a receiving radio via a channel with scrambling enabled, this function needs to be enabled on the both radios.

6. Trouble Shooting

Problem	Reason	Solution
Startup failure	The power cord is disconnected.	Connect the power cord.
Low, interrupted or no volume while receiving signals	Volume is low.	Turn up volume.
	The antenna is loose or installed improperly.	Power off the radio and install the antenna again.
	The speaker is blocked or damaged.	Clean the outside of the radio. If the problem remains, contact your dealer or a maintenance provider the Company authorizes for examination and repair.
Cannot talk to group members under digital mode	The frequency or signaling is different from that of other members	Set the same frequency or signaling for all the members.
	A digital or analogue channel is set improperly.	Set the same digital or analogue channel for all the members.

Problem	Reason	Solution
	Too far from the members.	Decrease the distance.
Unwanted voice or noise in analogue channel	The radio is interfered by user same frequency	Change to frequency point
	Signaling is not set.	Set signaling on all the radios in the group to avoid co-channel interference.
High noise	Communication distance is too long.	Decrease the distance.
	The signal is weak in the location due to an obstacle, for example, a tall building or a basement.	Move to an open and flat area. Restart the radio.
	The radio is interfered by environment or electromagnetic waves.	Keep away from an interfering device.
Keys not working	The keys are abnormal.	Power off the radio and on again.
Screen not working	The screen is abnormal.	Power off the radio and on again.
GPS positioning failed	GPS signals cannot be received at the positio	Move to an open and flat area.

Notice to user

FCC Caution

Any Changes or modifications not expressly approved by the party responsible for compliance could void the user's authority to operate the equipment.

This device complies with part 15 of the FCC Rules. Operation is subject to the following two conditions:

1. This device may not cause harmful interference
 2. This device must accept any interference received, including interference that may cause undesired operation.
- This radio is designed for and classified as “**Occupational/Controlled Use Only**” , meaning it must be used only during the course of employment by individuals aware of the hazards, and the ways to minimize such hazards; NOT intended for use in an General population/uncontrolled environment
 - DO NOT operate the radio without a proper antenna attached, as this may damage the radio and may also cause you to exceed RF exposure limits. A proper antenna is the antenna supplied with this radio by the manufacturer or an antenna specifically authorized by the manufacturer for use with this radio, and the antenna gain shall not exceed 0dBi by the manufacturer declared.
 - DO NOT transmit for more than 50% of total radio use time, more than 50% of the time can cause RF exposure compliance requirements to be exceeded.
 - During operation, the separation distance between user and the antenna shall be at least 0.45m, this separation distance will ensure that there is sufficient distance from a properly installed externally-mounted antenna to satisfy the RF exposure requirements
 - During transmissions, your radio generates RF energy that can possibly cause interference with other devices or systems. To avoid such interference, turn off the radio in areas where signs are posted to do so. DO NOT operate the transmitter in areas that are sensitive to electromagnetic radiation such as hospitals, aircraft, and blasting sites.

IC Caution

User manuals for licence-exempt radio apparatus shall contain the following or equivalent notice in a conspicuous location in the user manual or alternatively on the device or both

English: This device contains licence-exempt transmitter(s)/receiver(s) that comply with Innovation, Science and Economic Development Canada's licence-exempt RSS(s). Operation is subject to the following two conditions:

- (1) This device may not cause interference.
- (2) This device must accept any interference, including interference that may cause undesired operation of the device.

Français: Le présent appareil est conforme aux CNR d'Industrie Canada applicables aux appareils radio exempts de licence. L'exploitation est autorisée aux deux conditions suivantes :

- (1) l'appareil ne doit pas produire de brouillage;
- (2) l'utilisateur de l'appareil doit accepter tout brouillage radioélectrique subi, même si le brouillage est susceptible d'en compromettre le fonctionnement.

- This radio is designed for and classified as "**Occupational/Controlled Use Only**", meaning it must be used only during the course of employment by individuals aware of the hazards, and the ways to minimize such hazards; NOT intended for use in an General population/uncontrolled environment
- DO NOT operate the radio without a proper antenna attached, as this may damage the radio and may also cause you to exceed RF exposure limits. A proper antenna is the antenna supplied with this radio by the manufacturer or an antenna specifically authorized by the manufacturer for use with this radio, and the antenna gain shall not exceed 0dBi by the manufacturer declared.
- DO NOT transmit for more than 50% of total radio use time, more than 50% of the time can cause RF exposure compliance requirements to be exceeded.
- During operation, the separation distance between user and the antenna shall be at least 0.52m, this separation distance will ensure that there is sufficient distance from a properly installed externally-mounted antenna to satisfy the RF exposure requirements
- During transmissions, your radio generates RF energy that can possibly cause interference with other devices or systems. To avoid such interference, turn off the radio in areas where signs are posted to do so. DO NOT operate the transmitter in areas that are sensitive to electromagnetic radiation such as hospitals, aircraft, and blasting sites.

RED Caution:

1. Frequency: 136-174MHz, TX Power: 25W
2. Operation temperature range: -20°C~55°C
3. RF exposure information: The maximum gain of the antenna is 0dBi. This device's antenna must be installed in accordance with provided instructions; and it must be operated with minimum 0.45m spacing between the antennas and all person's body (excluding extremities of hands, wrist and feet) during operation.
4. Declaration of Conformity.

Manufacturer: Kirisun Communication Co.,Ltd.

Address: 3rd Floor, Building A, Tongfang Information Harbour, No.11 Langshan Road, Nanshan District, Shenzhen 518057, P.R.China

Hereby, Kirisun Communication Co., Ltd. declares that this product is in compliance with essential requirements and other relevant provisions of Directive 2014/53/EU. This product is allowed to be used in all EU member states.

Engineering personnel setting up those frequency ranges with Customer Programming Software, the mechanism implemented in the product to avoid the end user to managing changes in the definition of operating frequency ranges in order to avoid usage of un-allowed frequency ranges.

The authorized to set up the permitted frequency ranges for marketing in the specific EU country:

Country	Frequency Range(MHz)
Austria(AT)	156.4875 - 156.5125 160.3 - 160.300001,169.4 - 169.8125
Belgium(BE)	146 - 156,157.45 - 160.6,160.975 - 161.475,162.05 - 169.4, 169.825 - 174
Bulgaria(BG)	146 -161.9625,161.9875 -174
Croatia (HR)	138 - 144,146 -156,157.45 - 160.6,160.975 - 161.475, 162.0375 - 174
Cyprus (CY)	138 - 144,146 -156,157.45 - 160.6,160.975 - 161.475, 162.0375 - 174
Czech Republic (CZ)	148.2 - 149.05,150.05 - 150.975,152.8 - 153.65
Denmark(DK)	146 - 149.9,150.05 - 153,154 - 156.4875,156.8375 -174
Estonia(EE)	150.05 - 156.7625,157.45 - 160.6,160.625 - 160.95, 160.975 - 161.475,162.05 - 169.4
Finland(FI)	146.30625 - 149.9,151.00625 - 154.89375, 157.45 - 158.8,161.175 - 161.375,162.05 - 163.4,165.3 - 174
France (FR)	168.9 - 169.4,173.5 - 174
Germany(DE)	146 - 148,149.14 - 156,158.34 - 167.54,170.3 - 172.15
Greece(EL)	138 - 143.6,146 - 148.2,150.05 - 151.6,154.5 - 161.4875, 162.0375 -174
Hungary(HU)	156 - 156.7625,156.8375 - 167.3,169.6375 - 174
Ireland (IE)	154 - 156.7625

Italy(IT)	146 - 156.4875, 156.8375 -161.9625,162.0375 - 174
Latvia (LV)	146 - 174
Lithuania(LT)	146 - 156,157.45 - 160.6,160.975 - 161.475,162.05 - 174
Luxembourg (LU)	146 - 174
Malta(MT)	146 - 156,157.45 - 160.6,160.975 - 161.475,162.0375 - 174
Netherlands(NL)	146 - 156.4875, 156.8375-161.9625,162.0375 - 174
Poland(PL)	147.8 - 147.975, 150.05 - 151.625, 151.775 - 156, 157.425 - 159.9, 159.9 - 160.6, 160.975 - 161.475, 162.05 - 164.475, 167.5 - 168.5, 169.825 - 174
Portugal (PT)	148 - 149.9,150.05 - 156.4875 , 156.8375 - 174
Romania(RO)	146 - 149,149.55 - 149.8,150.05 - 156,159.175 - 160.6, 160.975 - 161.125,161.275 - 161.475,164.05 - 169.4, 169.6125 - 174
Slovakia(SK)	146 - 149.9, 150.05 - 153.5625, 155.5125 - 156, 156.8375 -
Slovenia(SI)	146 -156.4875, 156.9375 - 161.9625, 162.0375 - 174
Spain(ES)	146 - 149.9, 150.05 -156.4875, 156.5625 - 156.7625, 156.8375 - 174
Sweden(SE)	146.05 - 147, 150.05 - 151,156.8375 - 162.0375,162.025 - 163,164 - 171,172 - 174
United Kingdom (UK)	137.975 - 138.2,139.51875 - 140.98125, 143 - 144,148.01875 - 148.98125,153.025 - 153.475, 154 - 155,157.205 - 165.0375,158 - 165,165.05 - 173.0875,