



# TEST REPORT

**Report Reference No.**..... : **CHTEW19030212** Report verification: 

**Project No.**..... : **SHT1902018001EW**

**FCC ID**..... : **Q5ET60**

**Applicant's name**..... : **Kirisun Communication Co.,Ltd.**

**Address**..... : 3rd Floor, Building A, Tongfang Information Harbour, No.11  
Langshan Road, Nanshan District, Shenzhen 518057, P.R.China

**Manufacturer**..... : Kirisun Communication Co.,Ltd.

**Address**..... : 3rd Floor, Building A, Tongfang Information Harbour, No.11  
Langshan Road, Nanshan District, Shenzhen 518057, P.R.China

**Test item description** ..... : **PoC Two-way Radio**

**Trade Mark** ..... : KIRISUN

**Model/Type reference**..... : T60

**Listed Model(s)** ..... : T65, iTALK 220, iTALK 200

**Standard** ..... : **FCC CFR Title 47 Part 15 Subpart C Section 15.247**

**Date of receipt of test sample**..... : Feb 25, 2019

**Date of testing**..... : Feb 26, 2019- Mar 25, 2019

**Date of issue**..... : Mar 26, 2019

**Result**..... : **PASS**

Compiled by  
 ( Position+Printed name+Signature): File administrators Silvia Li 

Supervised by  
 (Position+Printed name+Signature): Project Engineer Aaron Fang 

Approved by  
 (Position+Printed name+Signature): RF Manager Hans Hu 

**Testing Laboratory Name** ..... : **Shenzhen Huatongwei International Inspection Co., Ltd.**

**Address**..... : 1/F, Bldg 3, Hongfa Hi-tech Industrial Park, Genyu Road, Tianliao, Gongming, Shenzhen, China

**Shenzhen Huatongwei International Inspection Co., Ltd. All rights reserved.**

This publication may be reproduced in whole or in part for non-commercial purposes as long as the Shenzhen Huatongwei International Inspection Co., Ltd. is acknowledged as copyright owner and source of the material. Shenzhen Huatongwei International Inspection Co., Ltd. takes no responsibility for and will not assume liability for damages resulting from the reader's interpretation of the reproduced material due to its placement and context.

*The test report merely correspond to the test sample.*

## Contents

<b>1.</b>	<b><u>TEST STANDARDS AND REPORT VERSION</u></b>	<b>3</b>
1.1.	Test Standards	3
1.2.	Report version	3
<b>2.</b>	<b><u>TEST DESCRIPTION</u></b>	<b>4</b>
<b>3.</b>	<b><u>SUMMARY</u></b>	<b>5</b>
3.1.	Client Information	5
3.2.	Product Description	5
3.3.	Operation state	6
3.4.	EUT configuration	6
3.5.	Modifications	6
<b>4.</b>	<b><u>TEST ENVIRONMENT</u></b>	<b>7</b>
4.1.	Address of the test laboratory	7
4.2.	Test Facility	7
4.3.	Environmental conditions	8
4.4.	Statement of the measurement uncertainty	8
4.5.	Equipments Used during the Test	9
<b>5.</b>	<b><u>TEST CONDITIONS AND RESULTS</u></b>	<b>11</b>
5.1.	Antenna requirement	11
5.2.	Conducted Emissions (AC Main)	12
5.3.	Conducted Peak Output Power	15
5.4.	20 dB Bandwidth	19
5.5.	Carrier Frequencies Separation	23
5.6.	Hopping Channel Number	25
5.7.	Dwell Time	27
5.8.	Pseudorandom Frequency Hopping Sequence	34
5.9.	Restricted band (radiated)	35
5.10.	Band edge and Spurious Emissions (conducted)	37
5.11.	Spurious Emissions (radiated)	53
<b>6.</b>	<b><u>TEST SETUP PHOTOS</u></b>	<b>57</b>
<b>7.</b>	<b><u>EXTERANAL AND INTERNAL PHOTOS</u></b>	<b>58</b>

## 1. TEST STANDARDS AND REPORT VERSION

### 1.1. Test Standards

The tests were performed according to following standards:

[FCC Rules Part 15.247](#): Frequency Hopping, Direct Spread Spectrum and Hybrid Systems that are in operation within the bands of 902-928 MHz, 2400-2483.5 MHz, and 5725-5850 MHz

[ANSI C63.10-2013](#): American National Standard for Testing Unlicensed Wireless Devices

### 1.2. Report version

Revision No.	Date of issue	Description
N/A	2019-03-26	Original

## **2. TEST DESCRIPTION**

<b>Test Item</b>	<b>Section in CFR 47</b>	<b>Result</b>	<b>Test Engineer</b>
Antenna Requirement	15.203/15.247 (c)	PASS	Xiaokang Tan
AC Power Line Conducted Emissions	15.207	PASS	Tony Duan
Conducted Peak Output Power	15.247 (b)(1)	PASS	Xiaokang Tan
20 dB Bandwidth	15.247 (a)(1)	PASS	Xiaokang Tan
Carrier Frequencies Separation	15.247 (a)(1)	PASS	Xiaokang Tan
Hopping Channel Number	15.247 (a)(1)	PASS	Xiaokang Tan
Dwell Time	15.247 (a)(1)	PASS	Xiaokang Tan
Pseudorandom Frequency Hopping Sequence	15.247(b)(4)	PASS	Xiaokang Tan
Restricted band	15.247(d)/15.205	PASS	Shower Dai
Radiated Emissions	15.247(d)/15.209	PASS	Shower Dai

Note: The measurement uncertainty is not included in the test result.

### 3. SUMMARY

#### 3.1. Client Information

Applicant:	Kirisun Communication Co.,Ltd.
Address:	3rd Floor, Building A, Tongfang Information Harbour, No.11 Langshan Road, Nanshan District, Shenzhen 518057, P.R.China
Manufacturer:	Kirisun Communication Co.,Ltd.
Address:	3rd Floor, Building A, Tongfang Information Harbour, No.11 Langshan Road, Nanshan District, Shenzhen 518057, P.R.China

#### 3.2. Product Description

Name of EUT:	PoC Two-way Radio
Trade Mark:	KIRISUN
Model No.:	T60
Listed Model(s):	T65, iTALK 220, iTALK 200
Power supply:	DC 3.7V
Adapter information:	Model:ZAU-B050100A-02 Input:100-240Va.c., 50/60Hz, 0.2A MAX Output:5.0Vd.c., 1000mA
Hardware version:	1.2
Software version:	1.3
<b>Bluetooth</b>	
Version:	Supported BT4.1+EDR
Modulation:	GFSK, $\pi/4$ DQPSK, 8DPSK
Operation frequency:	2402MHz~2480MHz
Channel number:	79
Channel separation:	1MHz
Antenna type:	Ceramic Antenna
Antenna gain:	-4.0dBi

### 3.3. Operation state

➤ **Test frequency list**

According to section 15.31(m), regards to the operating frequency range over 10 MHz, must select three channel which were tested. the Lowest frequency, the middle frequency, and the highest frequency of channel were selected to perform the test, please see the above gray bottom.

Channel	Frequency (MHz)
00	2402
01	2403
⋮	⋮
39	2441
⋮	⋮
77	2479
78	2480

➤ **TEST MODE**

For RF test items:
The engineering test program was provided and enabled to make EUT continuous transmit
For AC power line conducted emissions:
The EUT was set to connect with the Bluetooth instrument under large package sizes transmission.
For Radiated suprious emissions test item:
The engineering test program was provided and enabled to make EUT continuous transmit. The EUT in each of three orthogonal axis emissions had been tested ,but only the worst case (X axis) data recorded in the report.

### 3.4. EUT configuration

The following peripheral devices and interface cables were connected during the measurement:

- - supplied by the manufacturer
- - supplied by the lab

/	Manufacturer:	/
	Model No.:	/
/	Manufacturer:	/
	Model No.:	/

### 3.5. Modifications

No modifications were implemented to meet testing criteria.

## **4. TEST ENVIRONMENT**

### **4.1. Address of the test laboratory**

Laboratory: Shenzhen Huatongwei International Inspection Co., Ltd.

Address: 1/F, Bldg 3, Hongfa Hi-tech Industrial Park, Genyu Road, Tianliao, Gongming, Shenzhen, China

### **4.2. Test Facility**

#### **CNAS-Lab Code: L1225**

Shenzhen Huatongwei International Inspection Co., Ltd. has been assessed and proved to be in compliance with CNAS-CL01 Accreditation Criteria for Testing and Calibration Laboratories (identical to ISO/IEC17025: 2005 General Requirements) for the Competence of Testing and Calibration Laboratories.

#### **A2LA-Lab Cert. No.: 3902.01**

Shenzhen Huatongwei International Inspection Co., Ltd. EMC Laboratory has been accredited by A2LA for technical competence in the field of electrical testing, and proved to be in compliance with ISO/IEC 17025: 2005 General Requirements for the Competence of Testing and Calibration Laboratories and any additional program requirements in the identified field of testing.

#### **FCC-Registration No.: 762235**

Shenzhen Huatongwei International Inspection Co., Ltd. EMC Laboratory has been registered and fully described in a report filed with the FCC (Federal Communications Commission). The acceptance letter from the FCC is maintained in our files.

#### **IC-Registration No.:5377B-1**

Two 3m Alternate Test Site of Shenzhen Huatongwei International Inspection Co., Ltd. has been registered by Certification and Engineering Bureau of Industry Canada for the performance of radiated measurements with Registration No.: 5377B-1.

#### **ACA**

Shenzhen Huatongwei International Inspection Co., Ltd. EMC Laboratory can also perform testing for the Australian C-Tick mark as a result of our A2LA accreditation.

### 4.3. Environmental conditions

During the measurement the environmental conditions were within the listed ranges:

Temperature:	15~35°C
Relative Humidity:	30~60 %
Air Pressure:	950~1050mba

### 4.4. Statement of the measurement uncertainty

The data and results referenced in this document are true and accurate. The reader is cautioned that there may be errors in calibration limits of the equipment and facilities. The measurement uncertainty was calculated for all measurements listed in this test report according to TR-100028-01 "Electromagnetic compatibility and Radio spectrum Matters (ERM); Uncertainties in the measurement of mobile radio equipment characteristics; Part 1" and TR-100028-02 "Electromagnetic compatibility and Radio spectrum Matters (ERM); Uncertainties in the measurement of mobile radio equipment characteristics; Part 2" and is documented in the Shenzhen Huatongwei International Inspection Co., Ltd. quality system according to ISO/IEC 17025. Furthermore, component and process variability of devices similar to that tested may result in additional deviation. The manufacturer has the sole responsibility of continued compliance of the device.

Here after the best measurement capability for Shenzhen Huatongwei International Inspection Co., Ltd. is reported:

Test Items	Measurement Uncertainty	Notes
Transmitter power conducted	0.63 dB	(1)
Conducted spurious emissions 9kHz~40GHz	0.63 dB	(1)
Conducted Disturbance 150kHz~30MHz	3.35 dB	(1)
Radiated Emissions below 1GHz	4.28 dB	(1)
Radiated Emissions above 1GHz	5.16 dB	(1)
Occupied Bandwidth	69 Hz	(1)

(1) This uncertainty represents an expanded uncertainty expressed at approximately the 95% confidence level using a coverage factor of  $k=1.96$ .



#### 4.5. Equipments Used during the Test

Conducted Emissions						
Item	Test Equipment	Manufacturer	Model No.	Serial No.	Last Cal. (mm-dd-yy)	Next Cal. (mm-dd-yy)
1	EMI Test Receiver	R&S	ESCI	101247	10/27/2018	10/26/2019
2	Artificial Mains	SCHWARZBECK	NNLK 8121	573	10/27/2018	10/26/2019
3	Pulse Limiter	R&S	ESH3-Z2	101488	10/27/2018	10/26/2019
4	RF Connection Cable	HUBER+SUHNER	EF400	N/A	11/14/2017	11/13/2019
5	Test Software	R&S	ES-K1	N/A	N/A	N/A
6	Temperature and Humidity Meter	MIAOXIN	TH10R	N/A	10/30/2018	10/29/2019

Radiated Emissions(Below 1GHz)						
Item	Test Equipment	Manufacturer	Model No.	Serial No.	Last Cal. (mm-dd-yy)	Next Cal. (mm-dd-yy)
1	Semi-Anechoic Chamber	Albatross projects	SAC-3m-02	C11121	09/30/2018	09/29/2021
2	EMI Test Receiver	R&S	ESCI	100900	10/28/2018	10/27/2019
3	Loop Antenna	R&S	HFH2-Z2	100020	04/02/2018	04/02/2021
4	Ultra-Broadband Antenna	SCHWARZBECK	VULB9163	546	04/05/2017	04/04/2020
5	Pre-amplifier	SCHWARZBECK	BBV 9742	N/A	11/15/2018	11/14/2019
6	RF Connection Cable	HUBER+SUHNER	N/A	N/A	09/28/2018	09/27/2019
7	RF Connection Cable	HUBER+SUHNER	SUCOFLEX104	501184/4	09/28/2018	09/27/2019
8	Test Software	R&S	ES-K1	N/A	N/A	N/A
9	Turntable	Maturo Germany	TT2.0-1T	N/A	N/A	N/A
10	Antenna Mast	Maturo Germany	TAM-4.0-P	N/A	N/A	N/A
11	Temperature and Humidity Meter	KEJIAN	KJ03	N/A	10/30/2018	10/29/2019

Radiated Emissions(Above 1GHz)						
Item	Test Equipment	Manufacturer	Model No.	Serial No.	Last Cal. (mm-dd-yy)	Next Cal. (mm-dd-yy)
1	Anechoic Chamber	Albatross projects	SAC-3m-01	C11121	09/30/2018	09/29/2021
2	Horn Antenna	SCHWARZBECK	9120D	1011	03/27/2017	03/26/2020
3	Preamplifier	BONN	BLWA0160-2M	1811887	11/14/2018	11/13/2019
4	Broadband Pre-amplifier	SCHWARZBECK	BBV 9718	9718-248	04/28/2018	04/27/2019
5	Spectrum Analyzer	R&S	FSP40	100597	10/27/2018	10/26/2019
6	RF Connection Cable	HUBER+SUHNER	RE-7-FL	N/A	11/15/2018	11/14/2019
7	RF Connection Cable	HUBER+SUHNER	RE-7-FH	N/A	11/15/2018	11/14/2019
8	Test Software	Audix	E3	N/A	N/A	N/A
9	Turntable	Maturo Germany	TT2.0-1T	N/A	N/A	N/A
10	Antenna Mast	Maturo Germany	CAM-4.0-P-12	N/A	N/A	N/A
11	Temperature and Humidity Meter	MINGLE	YH101	N/A	10/30/2018	10/29/2019

<b>RF Conducted Test</b>						
Item	Test Equipment	Manufacturer	Model No.	Serial No.	Last Cal. (mm-dd-yy)	Next Cal. (mm-dd-yy)
1	Spectrum Analyzer	R&S	FSV40	100048	10/28/2018	10/27/2019
2	EXA Signal Analyzer	Agilent	N9020A	MY5050187	09/29/2018	09/28/2019

## 5. TEST CONDITIONS AND RESULTS

### 5.1. Antenna requirement

#### Requirement

##### **FCC CFR Title 47 Part 15 Subpart C Section 15.203:**

An intentional radiator shall be designed to ensure that no antenna other than that furnished by the responsible party shall be used with the device. The use of a permanently attached antenna or of an antenna that uses a unique coupling to the intentional radiator, the manufacturer may design the unit so that a broken antenna can be replaced by the user, but the use of a standard antenna jack or electrical connector is prohibited.

##### **FCC CFR Title 47 Part 15 Subpart C Section 15.247(c) (1)(i):**

(i) Systems operating in the 2400~2483.5 MHz band that is used exclusively for fixed. Point-to-point operations may employ transmitting antennas with directional gain greater than 6 dBi provided the maximum conducted output power of the intentional radiator is reduced by 1 dB for every 3 dB that the directional gain of the antenna exceeds 6 dBi.

#### Test Result:

**Passed**       **Not Applicable**

The directional gain of the antenna less than 6 dBi, please refer to the below antenna photo.

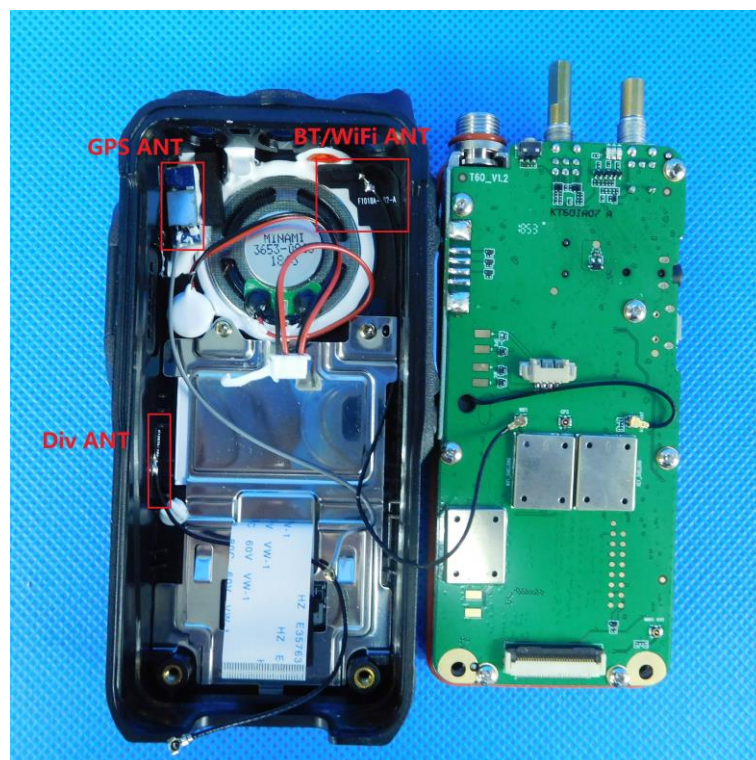

## 5.2. Conducted Emissions (AC Main)

### LIMIT

FCC CFR Title 47 Part 15 Subpart C Section 15.207

Frequency range (MHz)	Limit (dBuV)	
	Quasi-peak	Average
0.15-0.5	66 to 56*	56 to 46*
0.5-5	56	46
5-30	60	50

\* Decreases with the logarithm of the frequency.

### TEST CONFIGURATION

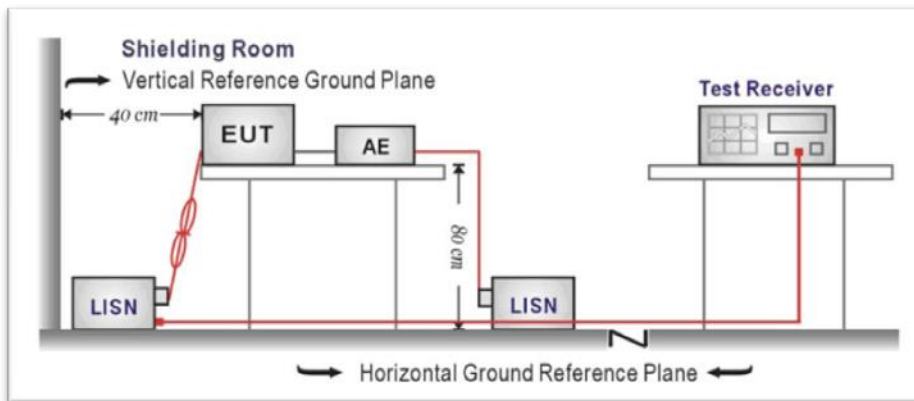

### TEST PROCEDURE

1. The EUT was setup according to ANSI C63.10:2013 requirements.
2. The EUT was placed on a platform of nominal size, 1 m by 1.5 m, raised 80 cm above the conducting ground plane. The vertical conducting plane was located 40 cm to the rear of the EUT. All other surfaces of EUT were at least 80 cm from any other grounded conducting surface.
3. The EUT and simulators are connected to the main power through a line impedances stabilization network (LISN). The LISN provides a 50 ohm /50uH coupling impedance for the measuring equipment.
4. The peripheral devices are also connected to the main power through a LISN. (Please refer to the block diagram of the test setup and photographs)
5. Each current-carrying conductor of the EUT power cord, except the ground (safety) conductor, was individually connected through a LISN to the input power source.
6. The excess length of the power cord between the EUT and the LISN receptacle were folded back and forth at the center of the lead to form a bundle not exceeding 40 cm in length.
7. Conducted emissions were investigated over the frequency range from 0.15MHz to 30MHz using a receiver bandwidth of 9 kHz.
8. During the above scans, the emissions were maximized by cable manipulation.

### TEST RESULTS

Passed       Not Applicable

Note:

- 1) Transd= Cable lose + Pulse Limiter Factor + Artificial Mains Factor
- 2) Margin= Limit - Level

Test Line:

L

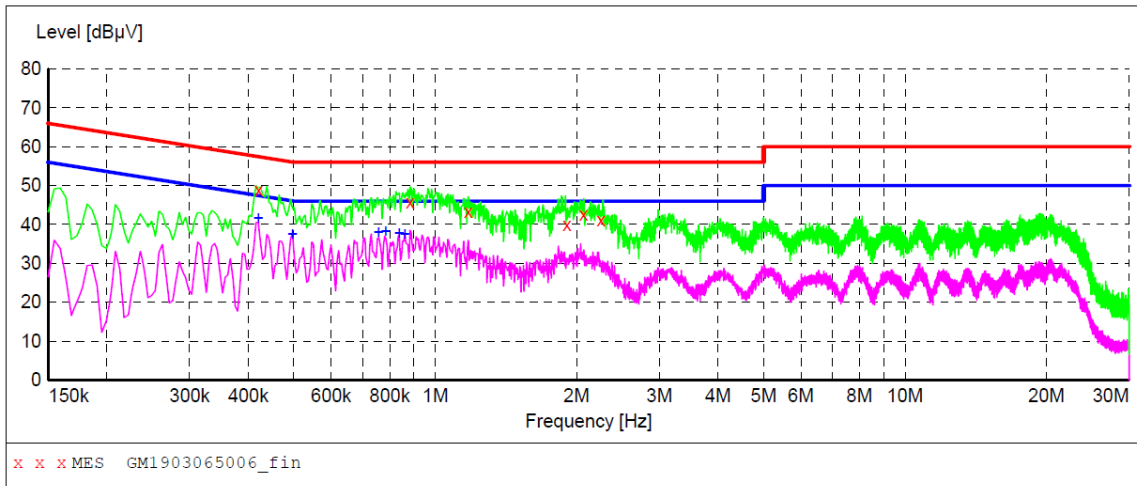

**MEASUREMENT RESULT: "GM1903065006\_fin"**

3/6/2019 9:07AM

Frequency MHz	Level dBµV	Transd dB	Limit dBµV	Margin dB	Detector	Line	PE
0.420000	48.80	10.1	57	8.6	QP	L1	GND
0.883500	45.70	9.9	56	10.3	QP	L1	GND
1.176000	43.40	10.0	56	12.6	QP	L1	GND
1.905000	39.90	10.0	56	16.1	QP	L1	GND
2.067000	42.50	10.0	56	13.5	QP	L1	GND
2.251500	41.20	10.0	56	14.8	QP	L1	GND

**MEASUREMENT RESULT: "GM1903065006\_fin2"**

3/6/2019 9:07AM

Frequency MHz	Level dBµV	Transd dB	Limit dBµV	Margin dB	Detector	Line	PE
0.420000	41.50	10.1	47	5.9	AV	L1	GND
0.496500	37.50	10.0	46	8.6	AV	L1	GND
0.757500	38.00	9.9	46	8.0	AV	L1	GND
0.784500	38.20	9.9	46	7.8	AV	L1	GND
0.838500	37.70	9.9	46	8.3	AV	L1	GND
0.861000	37.60	9.9	46	8.4	AV	L1	GND

Test Line:

N

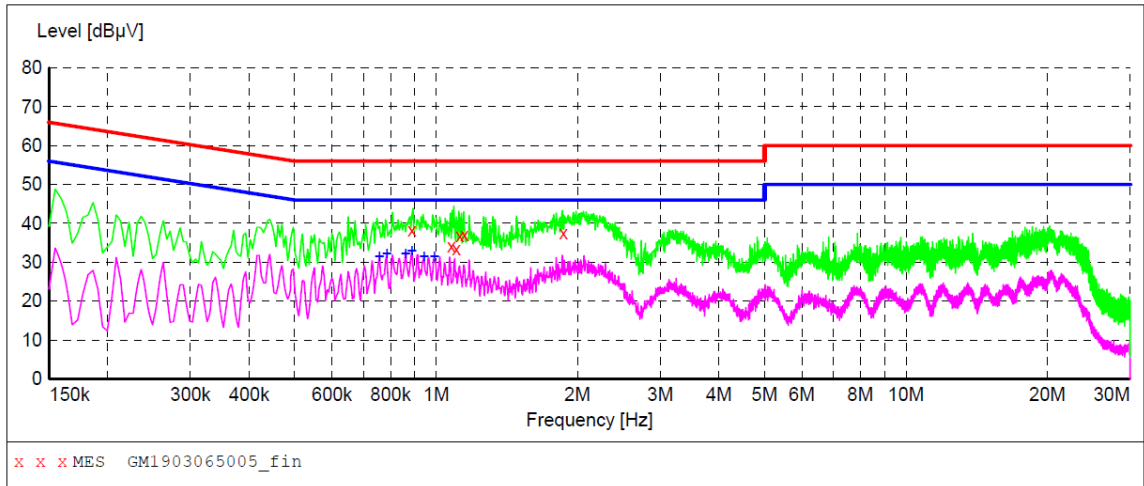

**MEASUREMENT RESULT: "GM1903065005\_fin"**

3/6/2019 9:04AM

Frequency MHz	Level dBµV	Transd dB	Limit dBµV	Margin dB	Detector	Line	PE
0.888000	38.30	9.9	56	17.7	QP	N	GND
1.077000	34.20	10.0	56	21.8	QP	N	GND
1.104000	33.40	10.0	56	22.6	QP	N	GND
1.122000	36.80	10.0	56	19.2	QP	N	GND
1.149000	37.00	10.0	56	19.0	QP	N	GND
1.864500	37.60	10.0	56	18.4	QP	N	GND

**MEASUREMENT RESULT: "GM1903065005\_fin2"**

3/6/2019 9:04AM

Frequency MHz	Level dBµV	Transd dB	Limit dBµV	Margin dB	Detector	Line	PE
0.757500	32.20	9.9	46	13.8	AV	N	GND
0.784500	32.10	9.9	46	13.9	AV	N	GND
0.861000	32.10	9.9	46	13.9	AV	N	GND
0.888000	33.00	9.9	46	13.0	AV	N	GND
0.942000	32.70	9.9	46	13.3	AV	N	GND
0.991500	32.00	9.9	46	14.0	AV	N	GND

### 5.3. Conducted Peak Output Power

#### LIMIT

FCC CFR Title 47 Part 15 Subpart C Section 15.247 (b)(1):

For frequency hopping systems operating in the 2400-2483.5 MHz band employing at least 75 non-overlapping hopping channels, and all frequency hopping systems in the 5725-5850 MHz band: 1 watt.  
 For all other frequency hopping systems in the 2400-2483.5 MHz band: 0.125 watts.

#### TEST CONFIGURATION

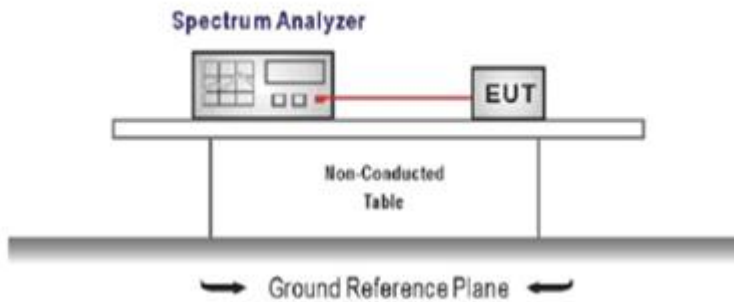

#### TEST PROCEDURE

1. The transmitter output was connected to the spectrum analyzer through an attenuator, the pathloss was compensated to the results for each measurement.
2. Set to the maximum power setting and enable the EUT transmit continuously
3. Use the following spectrum analyzer settings:  
 Span = approximately 5 times the 20 dB bandwidth, centered on a hopping channel  
 RBW ≥ the 20 dB bandwidth of the emission being measured, VBW ≥ RBW  
 Sweep = auto, Detector function = peak, Trace = max hold
4. Measure and record the results in the test report.

#### TEST MODE:

Please refer to the clause 3.3

#### TEST RESULTS

Passed       Not Applicable

Modulation type	Channel	Output power (dBm)	Limit (dBm)	Result
GFSK	00	1.08	≤ 30.00	Pass
	39	1.69		
	78	2.44		
π/4DQPSK	00	0.91	≤ 21.00	Pass
	39	1.78		
	78	2.42		
8DPSK	00	0.78	≤ 21.00	Pass
	39	1.37		
	78	2.43		

Modulation Type: GFSK	
CH00	<p>Spectrum plot for CH00. The plot shows a peak at 2.40213750 GHz with a power of 1.08 dBm. The y-axis represents power in dBm, ranging from -70 to 10. The x-axis represents frequency in GHz, with a span of 5.0 MHz. The plot includes a peak marker M1[1] and a peak value of 1.08 dBm. The center frequency (CF) is 2.402 GHz. The plot also shows a resolution bandwidth (RBW) of 1 MHz, a video bandwidth (VBW) of 3 MHz, and a sweep time (SWT) of 1 ms. The mode is set to Auto Sweep. The plot is titled 'Spectrum' and includes a '1Pk View' button. The plot also shows a reference level of 20.00 dBm and an attenuation (Att) of 30 dB. The plot is titled 'Spectrum' and includes a '1Pk View' button. The plot also shows a reference level of 20.00 dBm and an attenuation (Att) of 30 dB. The plot is titled 'Spectrum' and includes a '1Pk View' button. The plot also shows a reference level of 20.00 dBm and an attenuation (Att) of 30 dB.</p>
CH39	<p>Spectrum plot for CH39. The plot shows a peak at 2.44113750 GHz with a power of 1.69 dBm. The y-axis represents power in dBm, ranging from -70 to 10. The x-axis represents frequency in GHz, with a span of 5.0 MHz. The plot includes a peak marker M1[1] and a peak value of 1.69 dBm. The center frequency (CF) is 2.441 GHz. The plot also shows a resolution bandwidth (RBW) of 1 MHz, a video bandwidth (VBW) of 3 MHz, and a sweep time (SWT) of 1 ms. The mode is set to Auto Sweep. The plot is titled 'Spectrum' and includes a '1Pk View' button. The plot also shows a reference level of 20.00 dBm and an attenuation (Att) of 30 dB. The plot is titled 'Spectrum' and includes a '1Pk View' button. The plot also shows a reference level of 20.00 dBm and an attenuation (Att) of 30 dB. The plot is titled 'Spectrum' and includes a '1Pk View' button. The plot also shows a reference level of 20.00 dBm and an attenuation (Att) of 30 dB.</p>
CH78	<p>Spectrum plot for CH78. The plot shows a peak at 2.47988420 GHz with a power of 2.44 dBm. The y-axis represents power in dBm, ranging from -70 to 10. The x-axis represents frequency in GHz, with a span of 5.0 MHz. The plot includes a peak marker M1[1] and a peak value of 2.44 dBm. The center frequency (CF) is 2.48 GHz. The plot also shows a resolution bandwidth (RBW) of 1 MHz, a video bandwidth (VBW) of 3 MHz, and a sweep time (SWT) of 1 ms. The mode is set to Auto Sweep. The plot is titled 'Spectrum' and includes a '1Pk View' button. The plot also shows a reference level of 20.00 dBm and an attenuation (Att) of 30 dB. The plot is titled 'Spectrum' and includes a '1Pk View' button. The plot also shows a reference level of 20.00 dBm and an attenuation (Att) of 30 dB. The plot is titled 'Spectrum' and includes a '1Pk View' button. The plot also shows a reference level of 20.00 dBm and an attenuation (Att) of 30 dB.</p>

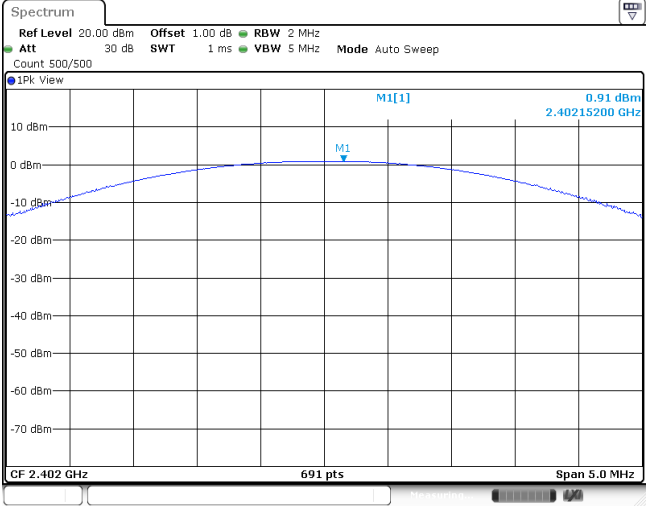
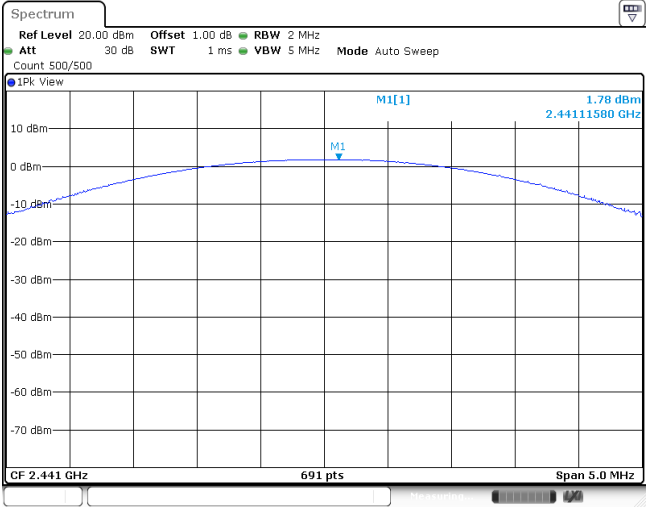
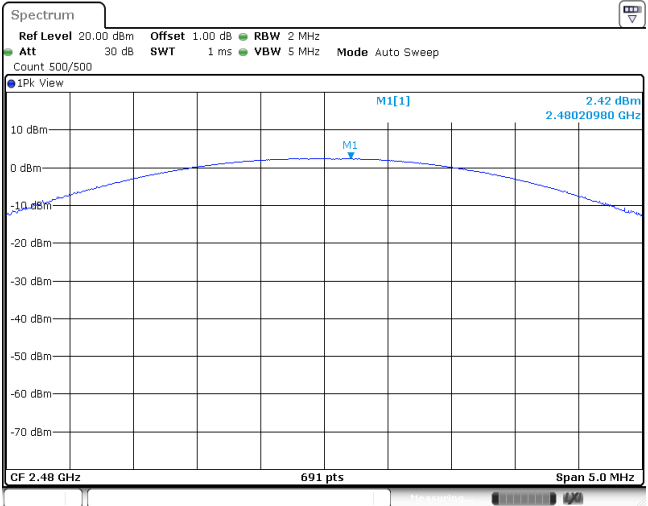

Modulation Type: $\pi/4$ DQPSK	
CH00	
CH39	
CH78	

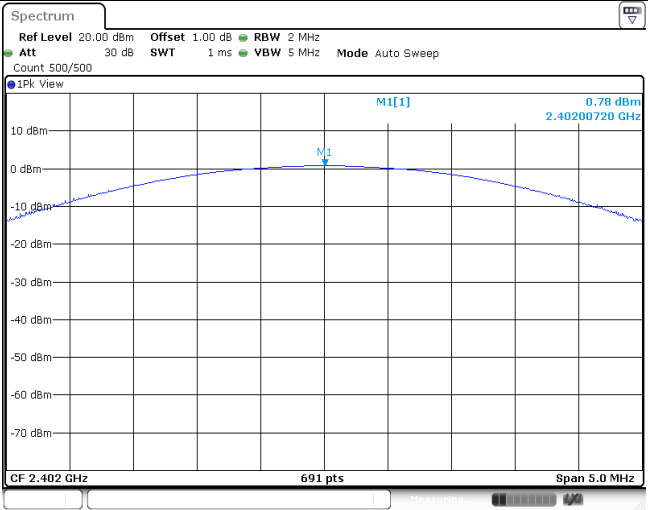
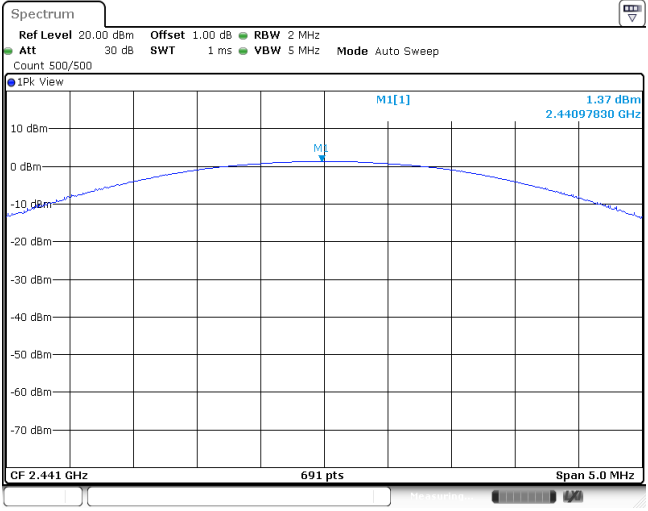
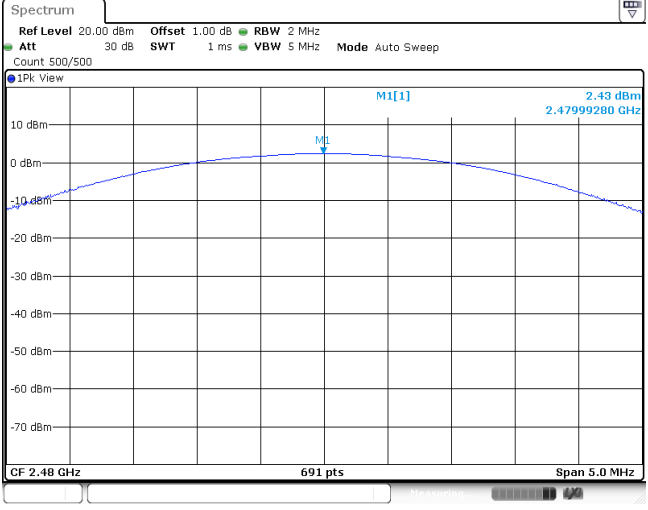
Modulation Type: 8DPSK	
CH00	
CH39	
CH78	

## 5.4. 20 dB Bandwidth

### LIMIT

N/A

### TEST CONFIGURATION

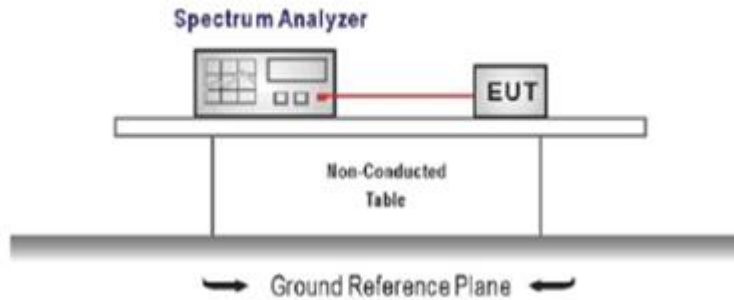

### TEST PROCEDURE

1. The transmitter output was connected to the spectrum analyzer through an attenuator, the path loss was compensated to the results for each measurement.
2. Set to the maximum power setting and enable the EUT transmit continuously
3. Use the following spectrum analyzer settings:  
Span = approximately 2 to 3 times the 20 dB bandwidth, centered on a hopping channel  
RBW  $\geq$  1% of the 20 dB bandwidth, VBW  $\geq$  RBW  
Sweep = auto, Detector function = peak, Trace = max hold
4. Measure and record the results in the test report.

### TEST MODE:

Please refer to the clause 3.3

### TEST RESULTS

 Passed       Not Applicable

Modulation type	Channel	20 dB Bandwidth (MHz)	Limit (MHz)	Result
GFSK	00	0.93	-	Pass
	39	0.93		
	78	0.93		
$\pi/4$ DQPSK	00	1.28	-	Pass
	39	1.28		
	78	1.28		
8DPSK	00	1.29	-	Pass
	39	1.29		
	78	1.28		

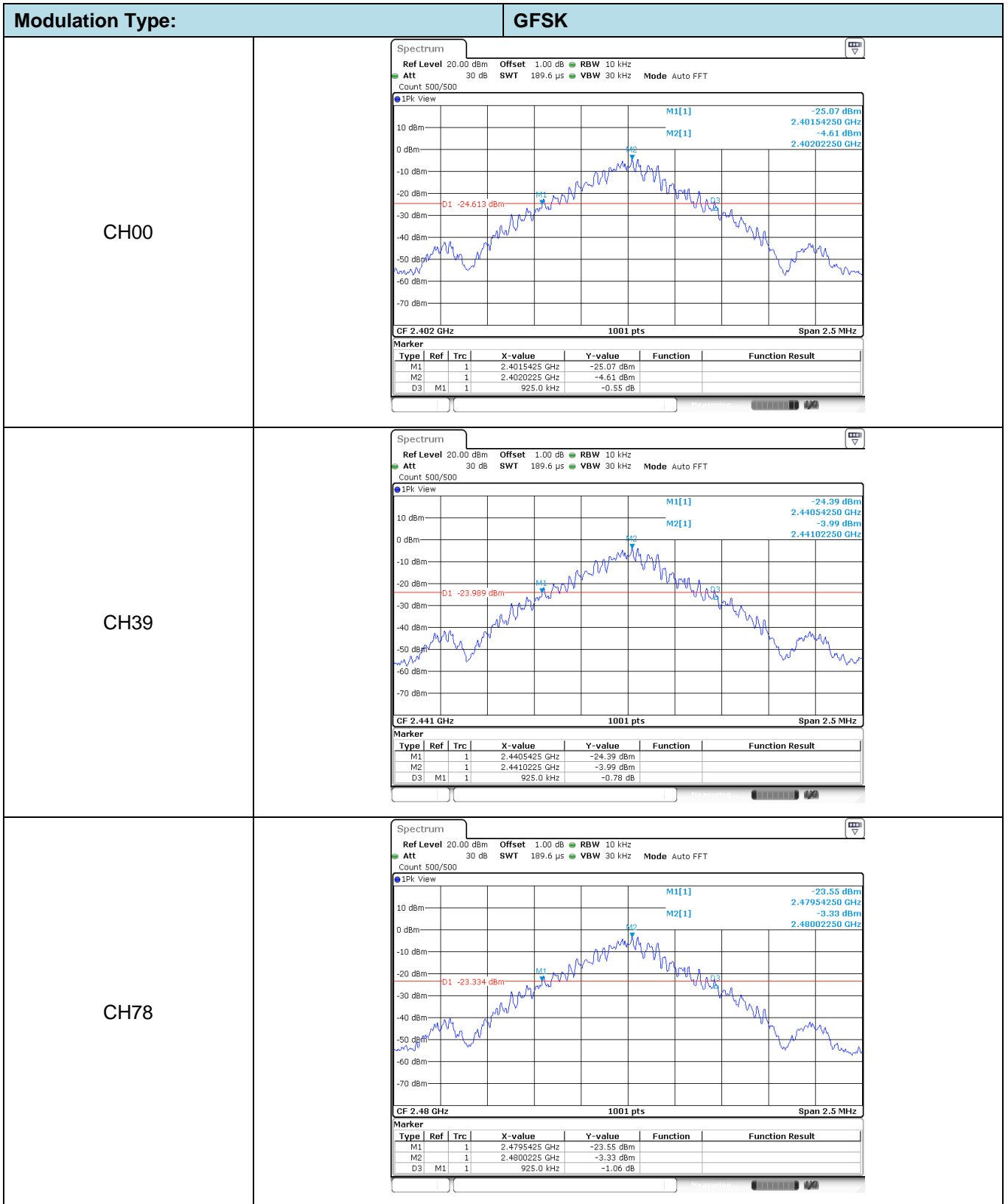

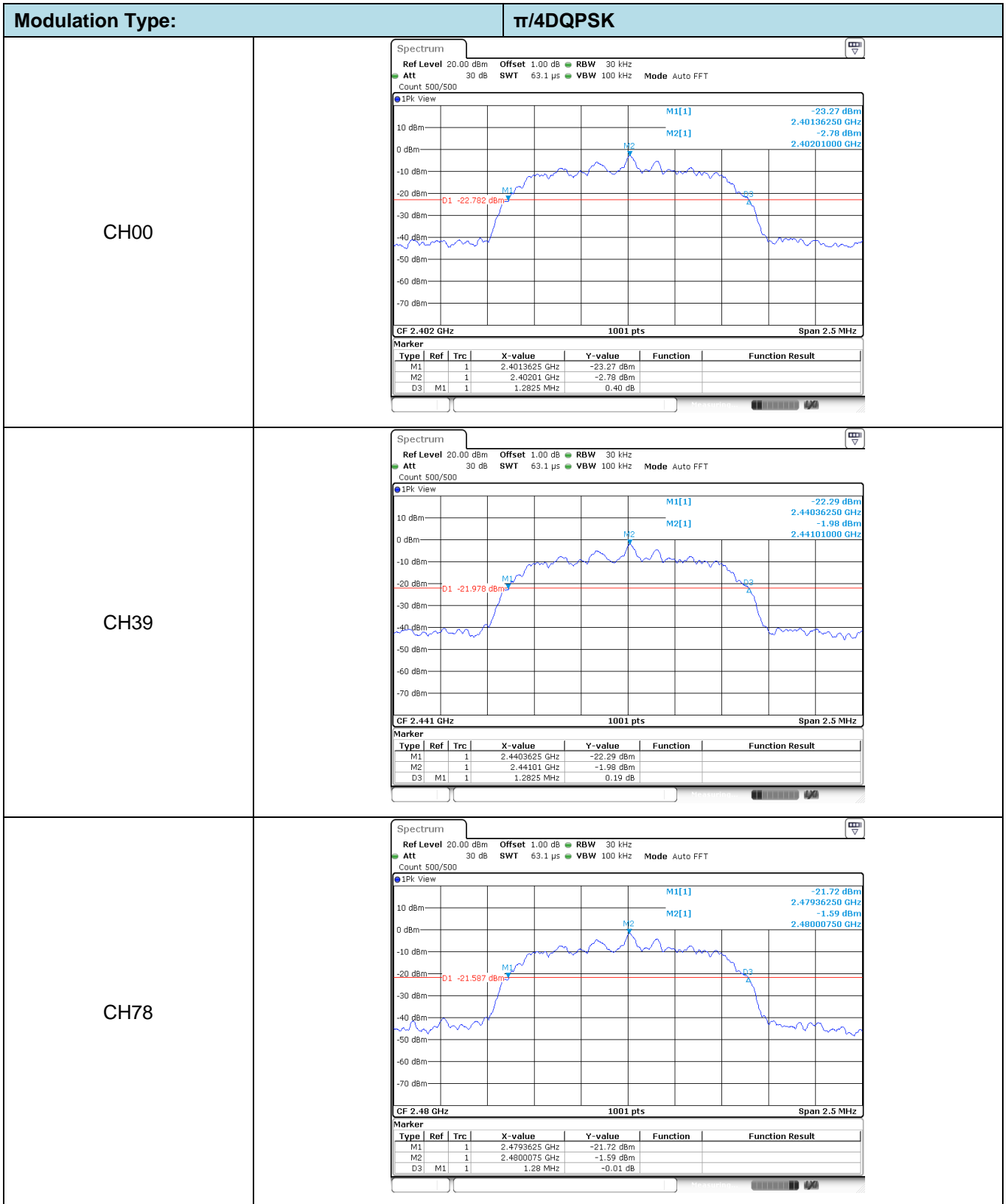

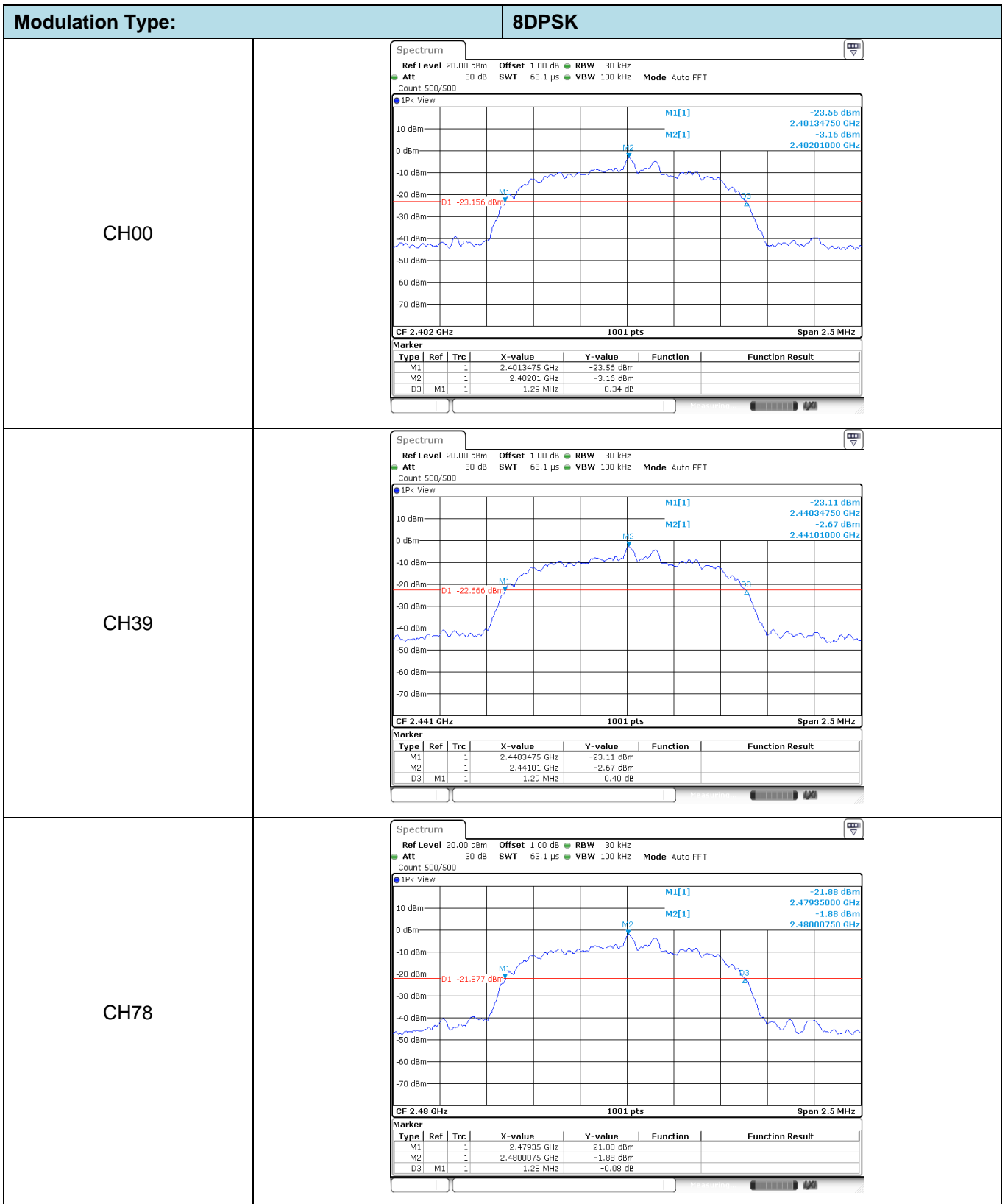

### 5.5. Carrier Frequencies Separation

#### LIMIT

FCC CFR Title 47 Part 15 Subpart C Section 15.247 (a)(1):

Frequency hopping systems shall have hopping channel carrier frequencies separated by a minimum of 25 kHz or the 20 dB bandwidth of the hopping channel, whichever is greater. Alternatively, Frequency hopping systems operating in the 2400-2483.5 MHz band may have hopping channel carrier frequencies that are separated by 25 kHz or two-thirds of the 20 dB bandwidth of the hopping channel, whichever is greater, provided the systems operate with an output power no greater than 125 mW.

#### TEST CONFIGURATION

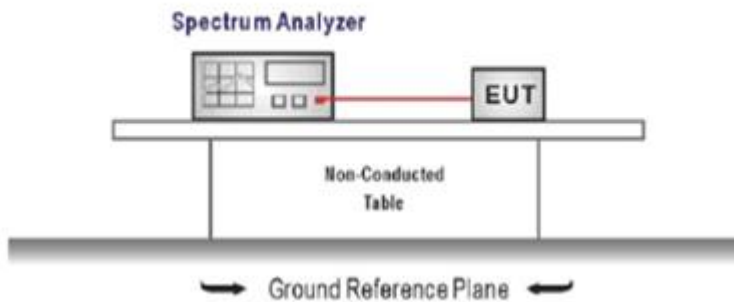

#### TEST PROCEDURE

1. The transmitter output was connected to the spectrum analyzer through an attenuator, the path loss was compensated to the results for each measurement.
2. Set to the maximum power setting and enable the EUT transmit continuously
3. Use the following spectrum analyzer settings:  
 Span = wide enough to capture the peaks of two adjacent channels  
 RBW  $\geq$  1% of the span, VBW  $\geq$  RBW  
 Sweep = auto, Detector function = peak, Trace = max hold
4. Measure and record the results in the test report.

#### TEST MODE:

Please refer to the clause 3.3

#### TEST RESULTS

Passed       Not Applicable

Modulation type	Channel	Carrier Frequencies Separation (MHz)	Limit (MHz) *	Result
GFSK	39	1.00	$\geq 0.93$	Pass
$\pi/4$ DQPSK	39	1.00	$\geq 0.85$	Pass
8DPSK	39	1.00	$\geq 0.86$	Pass

Note:

\*: GFSK limit = The maximum 20 dB Bandwidth for GFSK modulation on the section 5.4.

$\pi/4$ DQPSK limit =  $2/3$  \* The maximum 20 dB Bandwidth for  $\pi/4$ DQPSK modulation on the section 5.4.

8DPSK limit =  $2/3$  \* The maximum 20 dB Bandwidth for 8DPSK modulation on the section 5.4

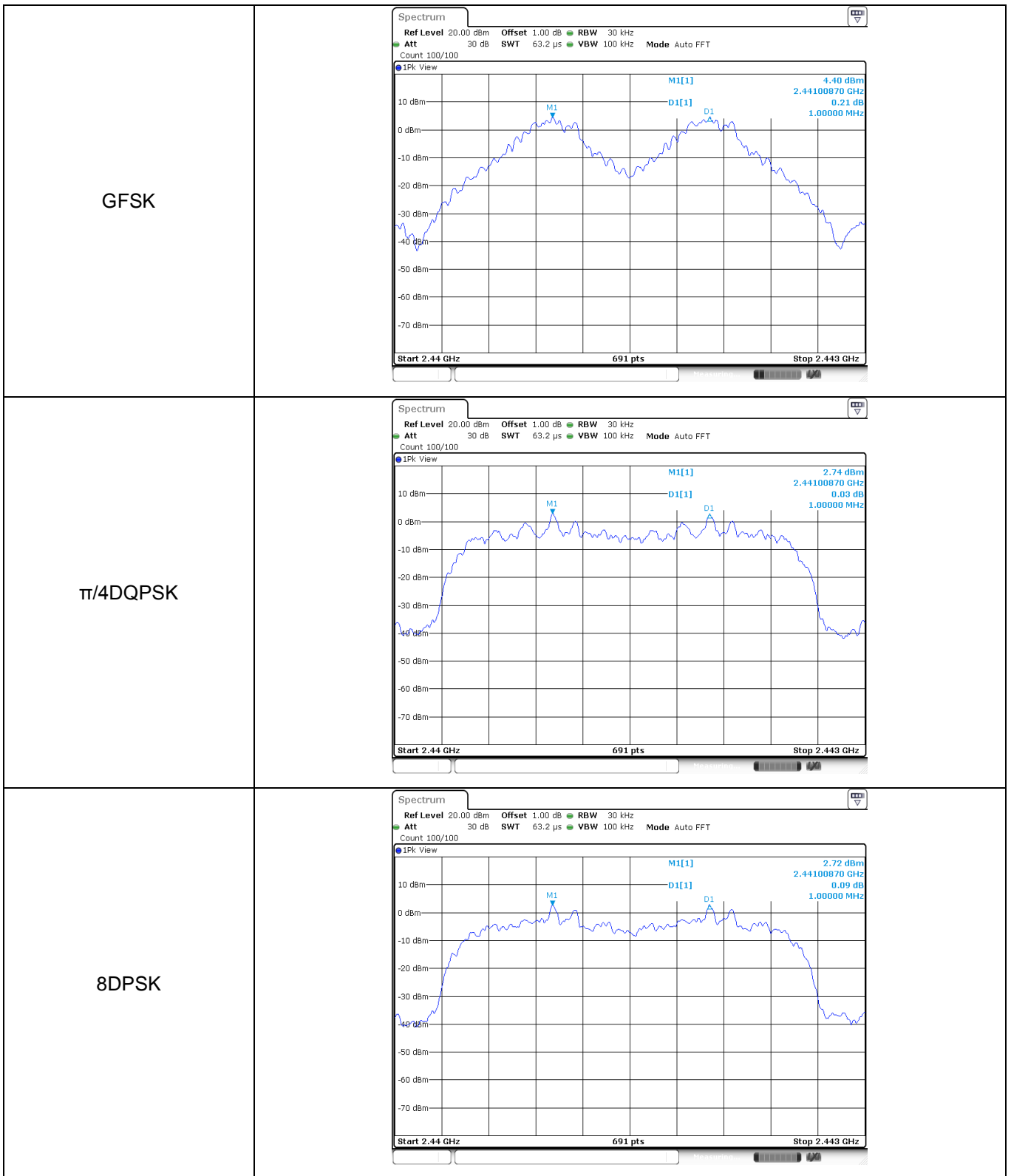



## 5.6. Hopping Channel Number

### LIMIT

FCC CFR Title 47 Part 15 Subpart C Section 15.247 (a)(1):Frequency hopping systems in the 2400–2483.5 MHz band shall use at least **15** channels.

### TEST CONFIGURATION

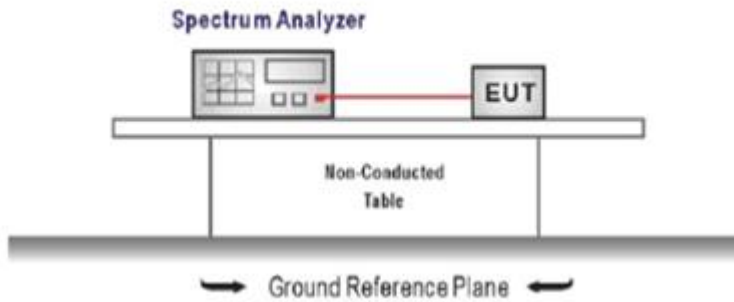

### TEST PROCEDURE

1. The transmitter output was connected to the spectrum analyzer through an attenuator, the path loss was compensated to the results for each measurement.
2. Set to the maximum power setting and enable the EUT transmit continuously
3. Use the following spectrum analyzer settings:  
 Span = the frequency band of operation  
 RBW  $\geq$  1% of the span, VBW  $\geq$  RBW  
 Sweep = auto, Detector function = peak, Trace = max hold
4. Measure and record the results in the test report.

### TEST MODE:

Please refer to the clause 3.3

### TEST RESULTS

Passed       Not Applicable

Modulation type	Channel number	Limit	Result
GFSK	79	$\geq 15.00$	Pass
$\pi/4$ DQPSK	79		
8DPSK	79		

<p>GFSK</p>	
<p><math>\pi/4</math>DQPSK</p>	
<p>8DPSK</p>	

## 5.7. Dwell Time

### LIMIT

FCC CFR Title 47 Part 15 Subpart C Section 15.247 (a)(1):The average time of occupancy on any channel shall not be greater than 0.4 seconds within a pe-riod of 0.4 seconds multiplied by the number of hopping channels employed.

### TEST CONFIGURATION

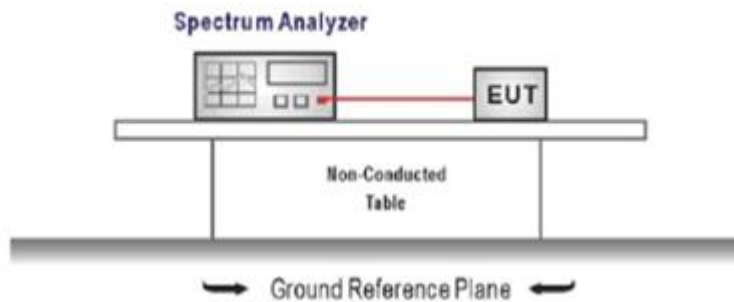

### TEST PROCEDURE

1. The transmitter output was connected to the spectrum analyzer through an attenuator, the path loss was compensated to the results for each measurement.
2. Set to the maximum power setting and enable the EUT transmit continuously
3. Use the following spectrum analyzer settings:  
Span = zero span, centered on a hopping channel, RBW= 1 MHz, VBW  $\geq$  RBW  
Sweep = as necessary to capture the entire dwell time per hopping channel,  
Detector function = peak, Trace = max hold
4. Measure and record the results in the test report.

### TEST MODE:

Please refer to the clause 3.3

### TEST RESULTS

Passed       Not Applicable

Modulation type	Channel	Burst Width [ms/hop/ch]	Total Hops[hop*ch]	Dwell time (Second)	Limit (Second)	Result
GFSK	DH1	0.38	318.00	0.12	$\leq 0.40$	Pass
	DH3	1.64	159.00	0.26		
	DH5	2.88	122.00	0.35		
$\pi/4$ DQPSK	2DH1	0.39	318.00	0.12	$\leq 0.40$	Pass
	2DH3	1.64	170.00	0.28		
	2DH5	2.89	114.00	0.33		
8DPSK	3DH1	0.39	317.00	0.12	$\leq 0.40$	Pass
	3DH3	1.64	151.00	0.25		
	3DH5	2.89	97.00	0.28		

Modulation Type: GFSK	
DH1 Burst width	
DH1 Burst number	
DH3 Burst width	

DH3  
Burst number

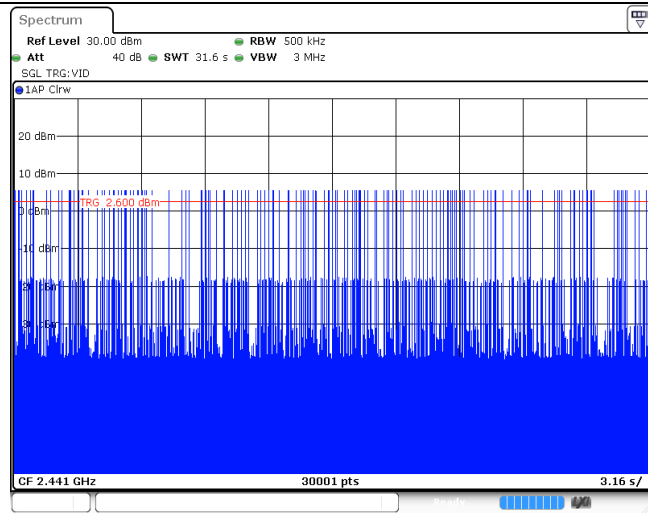

DH5  
Burst width

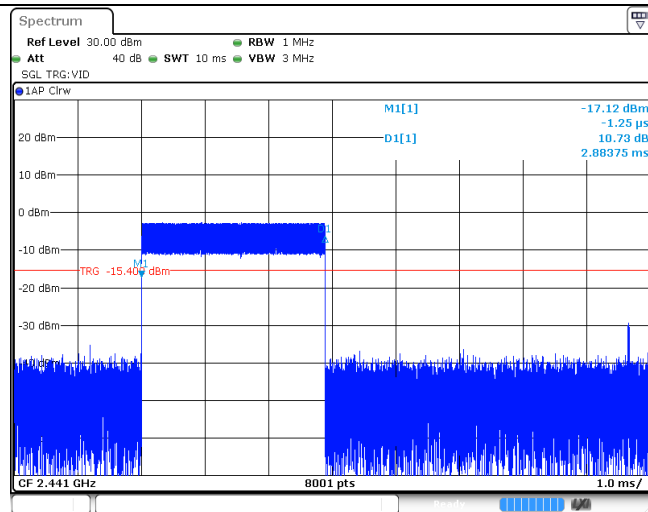

DH5  
Burst number

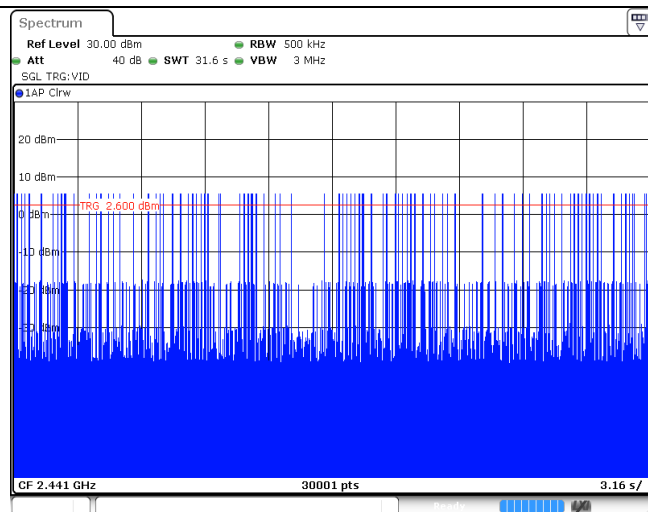

Modulation Type:		$\pi/4$ DQPSK
2DH1 Burst width	<p>Spectrum</p> <p>Ref Level 30.00 dBm RBW 1 MHz</p> <p>Att 40 dB SWT 10 ms VBW 3 MHz</p> <p>SGL TRG:VID</p> <p>IAP Cirw</p> <p>M1[1] -2.46 dBm 0.0000000 s</p> <p>D1[1] 6.23 dB 386.25 <math>\mu</math>s</p> <p>TRG -16.000 dBm</p> <p>CF 2.441 GHz 8001 pts 1.0 ms/</p>	
2DH1 Burst number	<p>Spectrum</p> <p>Ref Level 30.00 dBm RBW 500 kHz</p> <p>Att 40 dB SWT 31.6 s VBW 3 MHz</p> <p>SGL TRG:VID</p> <p>IAP Cirw</p> <p>TRG 2.000 dBm</p> <p>CF 2.441 GHz 30001 pts 3.16 s/</p>	
2DH3 Burst width	<p>Spectrum</p> <p>Ref Level 30.00 dBm RBW 1 MHz</p> <p>Att 40 dB SWT 10 ms VBW 3 MHz</p> <p>SGL TRG:VID</p> <p>IAP Cirw</p> <p>M1[1] -15.27 dBm 0.0000000 s</p> <p>D1[1] 6.93 dB 1.63750 ms</p> <p>TRG -16.000 dBm</p> <p>CF 2.441 GHz 8001 pts 1.0 ms/</p>	

2DH3  
Burst number

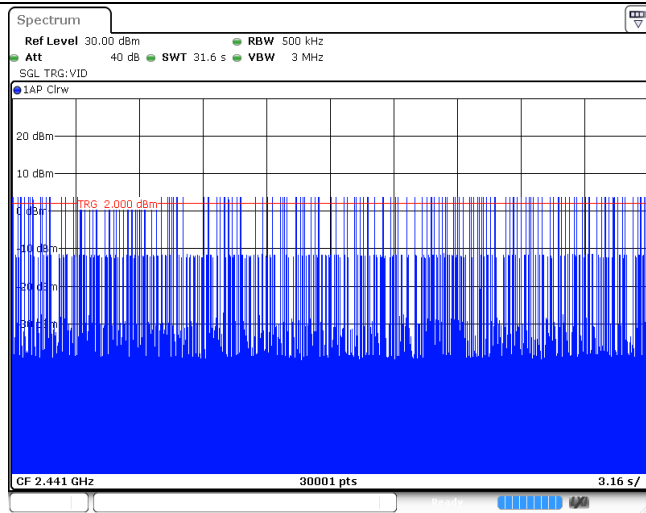

2DH5  
Burst width

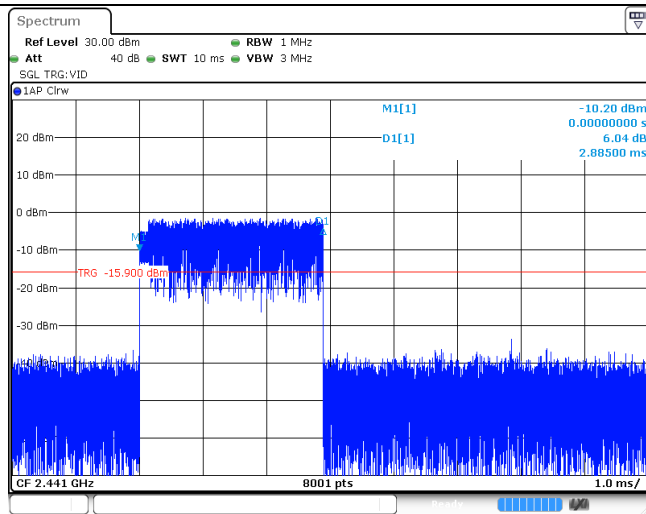

2DH5  
Burst number

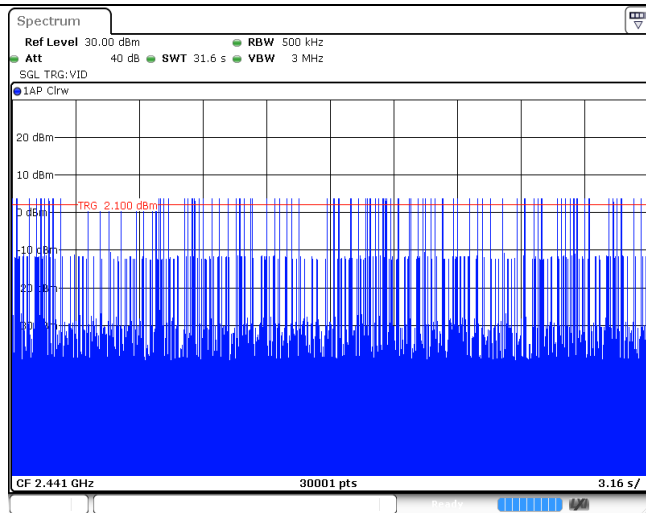

Modulation Type:		$\pi/4$ DQPSK
3DH1 Burst width		
3DH1 Burst number		
3DH3 Burst width		



3DH3  
Burst number

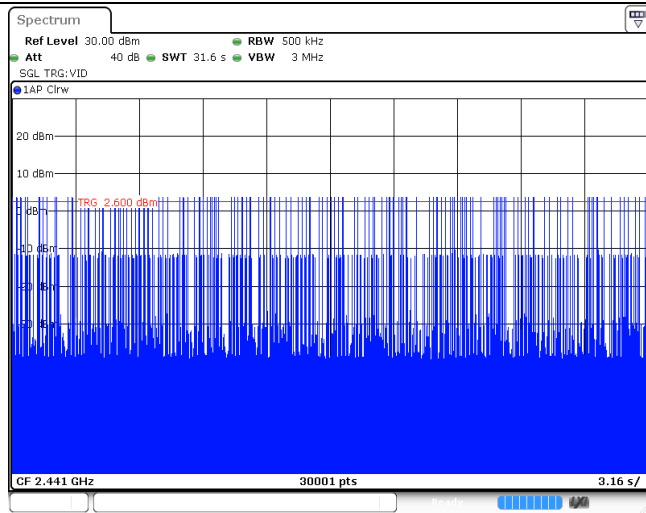

3DH5  
Burst width

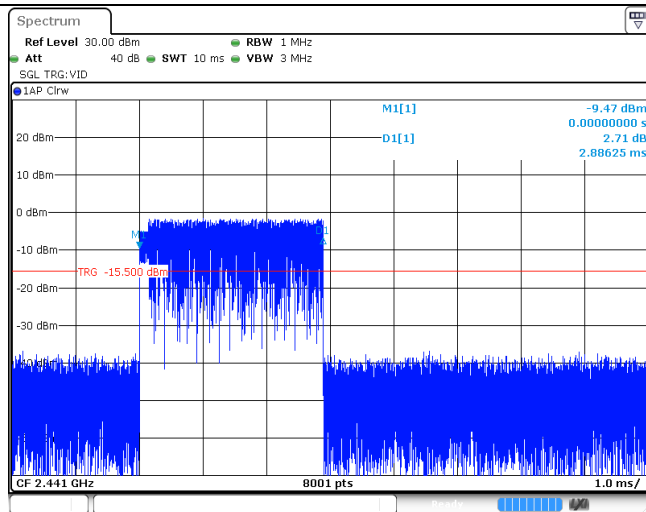

3DH5  
Burst number

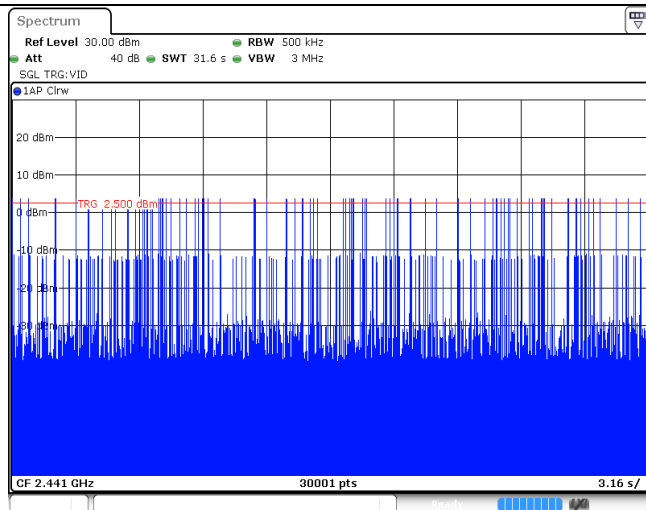

### 5.8. Pseudorandom Frequency Hopping Sequence

#### LIMIT

FCC CFR Title 47 Part 15 Subpart C Section 15.247 (a)(1):Frequency hopping systems shall have hopping channel carrier frequencies separated by a minimum of 25 kHz or the 20 dB bandwidth of the hopping channel, whichever is greater. Alternatively, frequency hopping systems operating in the 2400–2483.5 MHz band may have hopping channel carrier frequencies that are separated by 25 kHz or two-thirds of the 20 dB bandwidth of the hopping channel, whichever is greater, provided the systems operate with an output power no greater than 125 mW. The system shall hop to channel frequencies that are selected at the system hopping rate from a pseudo-randomly ordered list of hopping frequencies. Each frequency must be used equally on the average by each transmitter. The system receivers shall have input bandwidths that match the hopping channel bandwidths of their corresponding transmitters and shall shift frequencies in synchronization with the transmitted signals.

#### TEST RESULTS

The pseudorandom frequency hopping sequence may be generated in a nine-stage shift register whose 5<sup>th</sup> and 9<sup>th</sup> stage outputs are added in a modulo-two addition stage. And the result is fed back to the input of the first stage. The sequence begins with the first one of 9 consecutive ones, for example: the shift register is initialized with nine ones.

- Number of shift register stages: 9
- Length of pseudo-random sequence:  $2^9 - 1 = 511$  bits
- Longest sequence of zeros: 8 (non-inverted signal)

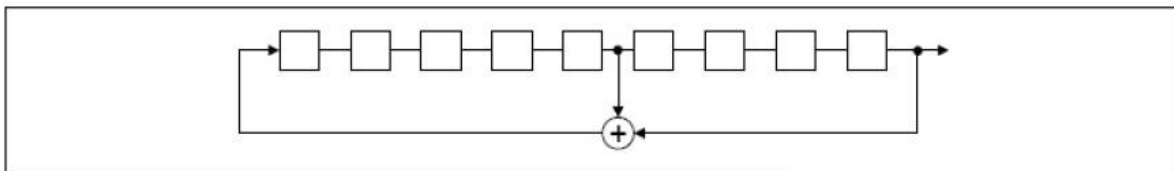

*Linear Feedback Shift Register for Generation of the PRBS sequence*

An example of pseudorandom frequency hopping sequence as follows:

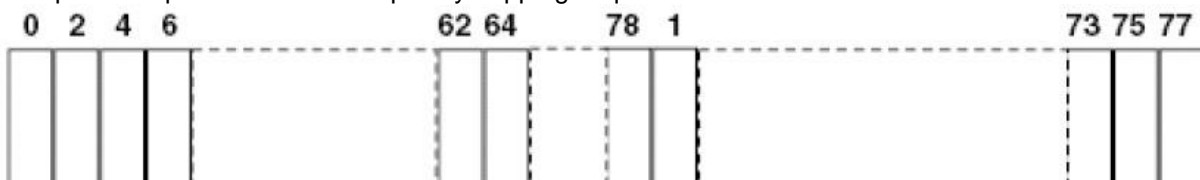

Each frequency used equally on the average by each transmitter. The system receiver has input bandwidths that match the hopping channel bandwidths of their corresponding transmitter and shift frequencies in synchronization with the transmitted signals.

**5.9. Restricted band (radiated)**

**LIMIT**

**FCC CFR Title 47 Part 15 Subpart C Section 15.247 (d):**

In any 100 kHz bandwidth outside the frequency band in which the spread spectrum or digitally modulated intentional radiator is operating, Radiated Emissions which fall in the restricted bands, as defined in §15.205(a), must also comply with the Radiated Emissions limits specified in §15.209(a) (see §15.205(c)).

**TEST CONFIGURATION**

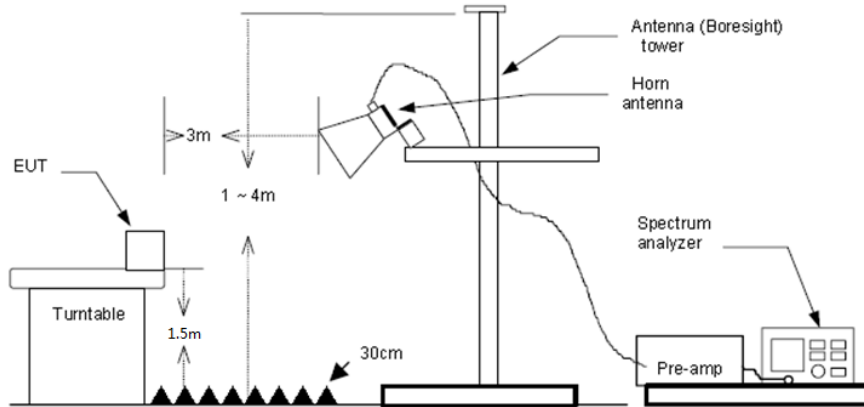

**TEST PROCEDURE**

1. The EUT was setup and tested according to ANSI C63.10:2013 for compliance to FCC 47CFR 15.247 requirements.
2. The EUT is placed on a turn table which is 1.5 meter above ground. The turn table is rotated 360 degrees to determine the position of the maximum emission level.
3. The EUT was positioned such that the distance from antenna to the EUT was 3 meters.
4. The antenna is scanned from 1 meter to 4 meters to find out the maximum emission level. This is repeated for both horizontal and vertical polarization of the antenna. In order to find the maximum emission, all of the interface cables were manipulated according to ANSI C63.10:2013 on radiated measurement.
5. The receiver set as follow:  
 RBW=1 MHz, VBW=3 MHz Peak detector for Peak value  
 RBW=1 MHz, VBW=10 Hz Peak detector for Average value.

**TEST MODE:**

Please refer to the clause 3.3

**TEST RESULTS**

Passed       Not Applicable

**Note:**

- 1) Final level= Read level + Antenna Factor+ Cable Loss- Preamp Factor
- 2) Have pre-scan all modulation mode, found the GFSK modulation which it was worst case, so only the worst case's data on the test report.
- 3) The peak level is lower than average limit(54 dBuV/m), this data is the too weak instrument of signal is unable to test.

Test channel:					CH00				
Frequency (MHz)	Read Level (dBuV)	Antenna Factor (dB/m)	Cable Loss (dB)	Preamp Factor (dB)	Level (dBuV/m)	Limit Line (dBuV/m)	Over Limit (dB)	Polarization	Test value
2310.00	32.29	28.05	6.62	37.59	29.37	74.00	-44.63	Horizontal	Peak
2325.25	39.16	27.97	6.65	37.59	36.19	74.00	-37.81	Horizontal	Peak
2390.00	36.74	27.65	6.75	37.59	33.55	74.00	-40.45	Horizontal	Peak
2310.00	31.45	28.05	6.62	37.59	28.53	74.00	-45.47	Vertical	Peak
2390.00	40.35	27.65	6.75	37.59	37.16	74.00	-36.84	Vertical	Peak
2310.00	20.57	28.05	6.62	37.59	17.65	54.00	-36.35	Horizontal	Average
2390.00	20.43	27.65	6.75	37.59	17.24	54.00	-36.76	Horizontal	Average
2310.00	19.42	28.05	6.62	37.59	16.50	54.00	-37.50	Vertical	Average
2390.00	20.21	27.65	6.75	37.59	17.02	54.00	-36.98	Vertical	Average

Test channel:					CH78				
Frequency (MHz)	Read Level (dBuV)	Antenna Factor (dB/m)	Cable Loss (dB)	Preamp Factor (dB)	Level (dBuV/m)	Limit Line (dBuV/m)	Over Limit (dB)	Polarization	Test value
2483.50	58.37	27.26	6.83	37.59	54.87	74.00	-19.13	Horizontal	Peak
2500.00	32.38	27.20	6.84	37.59	28.83	74.00	-45.17	Horizontal	Peak
2483.50	54.82	27.26	6.83	37.59	51.32	74.00	-22.68	Vertical	Peak
2500.00	33.40	27.20	6.84	37.59	29.85	74.00	-44.15	Vertical	Peak
2483.50	43.99	27.26	6.83	37.59	40.49	54.00	-13.51	Horizontal	Average
2500.00	19.94	27.20	6.84	37.59	16.39	54.00	-37.61	Horizontal	Average
2483.50	40.68	27.26	6.83	37.59	37.18	54.00	-16.82	Vertical	Average
2500.00	20.19	27.20	6.84	37.59	16.64	54.00	-37.36	Vertical	Average

## 5.10. Band edge and Spurious Emissions (conducted)

### LIMIT

FCC CFR Title 47 Part 15 Subpart C Section 15.247 (d): In any 100 kHz bandwidth outside the frequency band in which the spread spectrum intentional radiator is operating, the radio frequency power that is produced by the intentional radiator shall be at least 20 dB below that in the 100 kHz bandwidth within the band that contains the highest level of the desired power, based on either an RF conducted or a radiated measurement.

### TEST CONFIGURATION

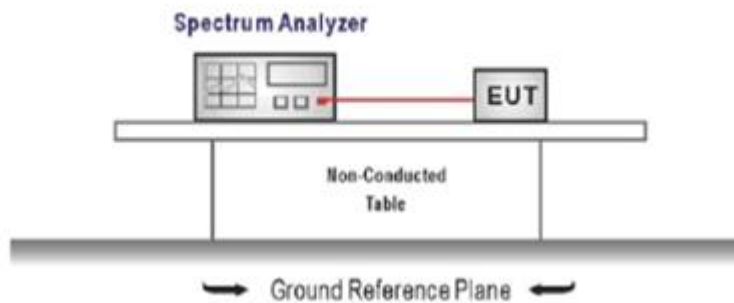

### TEST PROCEDURE

1. The transmitter output was connected to the spectrum analyzer through an attenuator, the path loss was compensated to the results for each measurement.
2. Set to the maximum power setting and enable the EUT transmit continuously
3. Use the following spectrum analyzer settings:  
RBW = 100 kHz, VBW  $\geq$  RBW, scan up through 10<sup>th</sup> harmonic.  
Sweep = auto, Detector function = peak, Trace = max hold
4. Measure and record the results in the test report.

### TEST MODE:

Please refer to the clause 3.3

### TEST RESULTS

Passed       Not Applicable

Test Item:	Band edge	Modulation type:	GFSK																																										
<p>CH00 No hopping mode</p>			<p>Spectrum                  Ref Level 20.00 dBm Offset 1.00 dB RBW 100 kHz                  Att 30 dB SWT 1.1 ms VBW 300 kHz Mode Auto Sweep                  Count 500/500                  1Pk Max                  10 dBm                  0 dBm                  -10 dBm                  -20 dBm -D1 -19.420 dBm                  -30 dBm                  -40 dBm                  -50 dBm                  -60 dBm                  -70 dBm                  Start 2.31 GHz 691 pts Stop 2.405 GHz                  Marker  <table border="1"> <thead> <tr> <th>Type</th> <th>Ref</th> <th>Trc</th> <th>X-value</th> <th>Y-value</th> <th>Function</th> <th>Function Result</th> </tr> </thead> <tbody> <tr> <td>M1</td> <td></td> <td>1</td> <td>2.40218 GHz</td> <td>0.58 dBm</td> <td></td> <td></td> </tr> <tr> <td>M2</td> <td></td> <td>1</td> <td>2.4 GHz</td> <td>-43.71 dBm</td> <td></td> <td></td> </tr> <tr> <td>M3</td> <td></td> <td>1</td> <td>2.39 GHz</td> <td>-55.71 dBm</td> <td></td> <td></td> </tr> <tr> <td>M4</td> <td></td> <td>1</td> <td>2.31 GHz</td> <td>-55.19 dBm</td> <td></td> <td></td> </tr> <tr> <td>M5</td> <td></td> <td>1</td> <td>2.399493 GHz</td> <td>-45.49 dBm</td> <td></td> <td></td> </tr> </tbody> </table> </p>	Type	Ref	Trc	X-value	Y-value	Function	Function Result	M1		1	2.40218 GHz	0.58 dBm			M2		1	2.4 GHz	-43.71 dBm			M3		1	2.39 GHz	-55.71 dBm			M4		1	2.31 GHz	-55.19 dBm			M5		1	2.399493 GHz	-45.49 dBm		
Type	Ref	Trc	X-value	Y-value	Function	Function Result																																							
M1		1	2.40218 GHz	0.58 dBm																																									
M2		1	2.4 GHz	-43.71 dBm																																									
M3		1	2.39 GHz	-55.71 dBm																																									
M4		1	2.31 GHz	-55.19 dBm																																									
M5		1	2.399493 GHz	-45.49 dBm																																									
<p>CH00 Hopping mode</p>			<p>Spectrum                  Ref Level 20.00 dBm Offset 1.00 dB RBW 100 kHz                  Att 30 dB SWT 1.1 ms VBW 300 kHz Mode Auto Sweep                  Count 500/500                  1Pk Max                  10 dBm                  0 dBm                  -10 dBm                  -20 dBm -D1 -14.530 dBm                  -30 dBm                  -40 dBm                  -50 dBm                  -60 dBm                  -70 dBm                  Start 2.31 GHz 691 pts Stop 2.405 GHz                  Marker  <table border="1"> <thead> <tr> <th>Type</th> <th>Ref</th> <th>Trc</th> <th>X-value</th> <th>Y-value</th> <th>Function</th> <th>Function Result</th> </tr> </thead> <tbody> <tr> <td>M1</td> <td></td> <td>1</td> <td>2.40411 GHz</td> <td>5.47 dBm</td> <td></td> <td></td> </tr> <tr> <td>M2</td> <td></td> <td>1</td> <td>2.4 GHz</td> <td>-50.92 dBm</td> <td></td> <td></td> </tr> <tr> <td>M3</td> <td></td> <td>1</td> <td>2.39 GHz</td> <td>-55.05 dBm</td> <td></td> <td></td> </tr> <tr> <td>M4</td> <td></td> <td>1</td> <td>2.31 GHz</td> <td>-54.96 dBm</td> <td></td> <td></td> </tr> <tr> <td>M5</td> <td></td> <td>1</td> <td>2.399768 GHz</td> <td>-45.98 dBm</td> <td></td> <td></td> </tr> </tbody> </table> </p>	Type	Ref	Trc	X-value	Y-value	Function	Function Result	M1		1	2.40411 GHz	5.47 dBm			M2		1	2.4 GHz	-50.92 dBm			M3		1	2.39 GHz	-55.05 dBm			M4		1	2.31 GHz	-54.96 dBm			M5		1	2.399768 GHz	-45.98 dBm		
Type	Ref	Trc	X-value	Y-value	Function	Function Result																																							
M1		1	2.40411 GHz	5.47 dBm																																									
M2		1	2.4 GHz	-50.92 dBm																																									
M3		1	2.39 GHz	-55.05 dBm																																									
M4		1	2.31 GHz	-54.96 dBm																																									
M5		1	2.399768 GHz	-45.98 dBm																																									
<p>CH78 No hopping mode</p>			<p>Spectrum                  Ref Level 20.00 dBm Offset 1.00 dB RBW 100 kHz                  Att 30 dB SWT 56.9 μs VBW 300 kHz Mode Auto FFT                  Count 500/500                  1Pk Max                  10 dBm                  0 dBm                  -10 dBm                  -20 dBm -D1 -17.840 dBm                  -30 dBm                  -40 dBm                  -50 dBm                  -60 dBm                  -70 dBm                  Start 2.478 GHz 691 pts Stop 2.5 GHz                  Marker  <table border="1"> <thead> <tr> <th>Type</th> <th>Ref</th> <th>Trc</th> <th>X-value</th> <th>Y-value</th> <th>Function</th> <th>Function Result</th> </tr> </thead> <tbody> <tr> <td>M1</td> <td></td> <td>1</td> <td>2.47999 GHz</td> <td>2.16 dBm</td> <td></td> <td></td> </tr> <tr> <td>M2</td> <td></td> <td>1</td> <td>2.4835 GHz</td> <td>-48.13 dBm</td> <td></td> <td></td> </tr> <tr> <td>M3</td> <td></td> <td>1</td> <td>2.5 GHz</td> <td>-59.31 dBm</td> <td></td> <td></td> </tr> <tr> <td>M4</td> <td></td> <td>1</td> <td>2.4840261 GHz</td> <td>-48.01 dBm</td> <td></td> <td></td> </tr> </tbody> </table> </p>	Type	Ref	Trc	X-value	Y-value	Function	Function Result	M1		1	2.47999 GHz	2.16 dBm			M2		1	2.4835 GHz	-48.13 dBm			M3		1	2.5 GHz	-59.31 dBm			M4		1	2.4840261 GHz	-48.01 dBm									
Type	Ref	Trc	X-value	Y-value	Function	Function Result																																							
M1		1	2.47999 GHz	2.16 dBm																																									
M2		1	2.4835 GHz	-48.13 dBm																																									
M3		1	2.5 GHz	-59.31 dBm																																									
M4		1	2.4840261 GHz	-48.01 dBm																																									

CH78  
Hopping mode

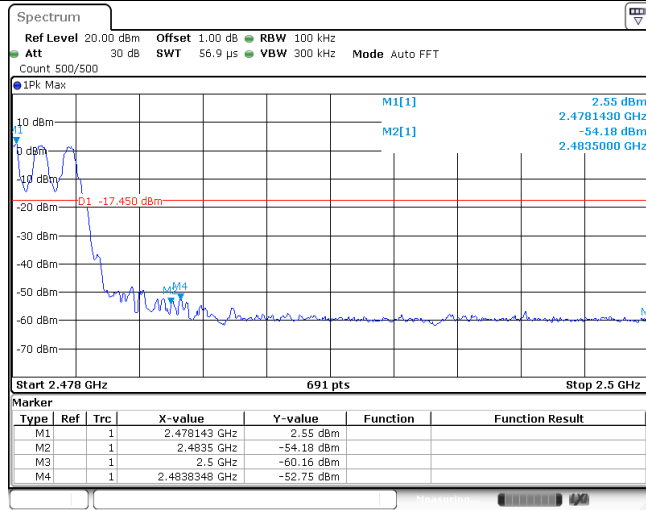

Test Item:	Band edge	Modulation type:	$\pi/4$ DQPSK
<p>CH00 No hopping mode</p>			
<p>CH00 Hopping mode</p>			
<p>CH78 No hopping mode</p>			



CH78  
Hopping mode

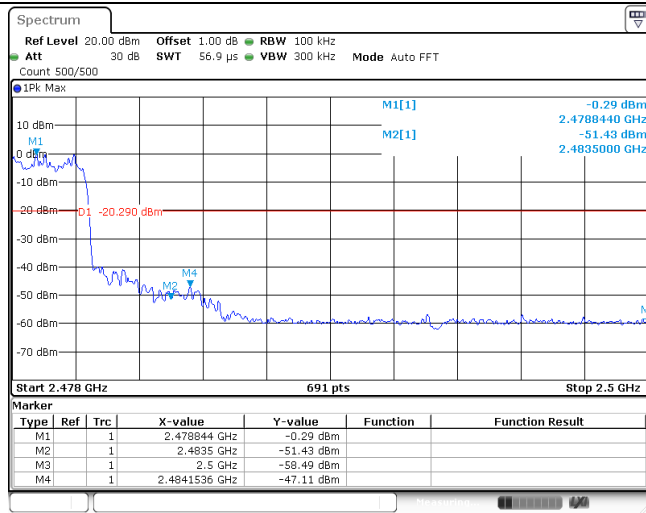

Test Item:	Band edge	Modulation type:	8DPSK																																										
<p>CH00 No hopping mode</p>			<table border="1"> <thead> <tr> <th>Type</th> <th>Ref</th> <th>Trc</th> <th>X-value</th> <th>Y-value</th> <th>Function</th> <th>Function Result</th> </tr> </thead> <tbody> <tr> <td>M1</td> <td></td> <td>1</td> <td>2.40218 GHz</td> <td>-1.40 dBm</td> <td></td> <td></td> </tr> <tr> <td>M2</td> <td></td> <td>1</td> <td>2.4 GHz</td> <td>-42.53 dBm</td> <td></td> <td></td> </tr> <tr> <td>M3</td> <td></td> <td>1</td> <td>2.39 GHz</td> <td>-56.63 dBm</td> <td></td> <td></td> </tr> <tr> <td>M4</td> <td></td> <td>1</td> <td>2.31 GHz</td> <td>-55.31 dBm</td> <td></td> <td></td> </tr> <tr> <td>M5</td> <td></td> <td>1</td> <td>2.399906 GHz</td> <td>-41.08 dBm</td> <td></td> <td></td> </tr> </tbody> </table>	Type	Ref	Trc	X-value	Y-value	Function	Function Result	M1		1	2.40218 GHz	-1.40 dBm			M2		1	2.4 GHz	-42.53 dBm			M3		1	2.39 GHz	-56.63 dBm			M4		1	2.31 GHz	-55.31 dBm			M5		1	2.399906 GHz	-41.08 dBm		
Type	Ref	Trc	X-value	Y-value	Function	Function Result																																							
M1		1	2.40218 GHz	-1.40 dBm																																									
M2		1	2.4 GHz	-42.53 dBm																																									
M3		1	2.39 GHz	-56.63 dBm																																									
M4		1	2.31 GHz	-55.31 dBm																																									
M5		1	2.399906 GHz	-41.08 dBm																																									
<p>CH00 Hopping mode</p>			<table border="1"> <thead> <tr> <th>Type</th> <th>Ref</th> <th>Trc</th> <th>X-value</th> <th>Y-value</th> <th>Function</th> <th>Function Result</th> </tr> </thead> <tbody> <tr> <td>M1</td> <td></td> <td>1</td> <td>2.40411 GHz</td> <td>3.61 dBm</td> <td></td> <td></td> </tr> <tr> <td>M2</td> <td></td> <td>1</td> <td>2.4 GHz</td> <td>-43.57 dBm</td> <td></td> <td></td> </tr> <tr> <td>M3</td> <td></td> <td>1</td> <td>2.39 GHz</td> <td>-56.63 dBm</td> <td></td> <td></td> </tr> <tr> <td>M4</td> <td></td> <td>1</td> <td>2.31 GHz</td> <td>-55.58 dBm</td> <td></td> <td></td> </tr> <tr> <td>M5</td> <td></td> <td>1</td> <td>2.399355 GHz</td> <td>-40.73 dBm</td> <td></td> <td></td> </tr> </tbody> </table>	Type	Ref	Trc	X-value	Y-value	Function	Function Result	M1		1	2.40411 GHz	3.61 dBm			M2		1	2.4 GHz	-43.57 dBm			M3		1	2.39 GHz	-56.63 dBm			M4		1	2.31 GHz	-55.58 dBm			M5		1	2.399355 GHz	-40.73 dBm		
Type	Ref	Trc	X-value	Y-value	Function	Function Result																																							
M1		1	2.40411 GHz	3.61 dBm																																									
M2		1	2.4 GHz	-43.57 dBm																																									
M3		1	2.39 GHz	-56.63 dBm																																									
M4		1	2.31 GHz	-55.58 dBm																																									
M5		1	2.399355 GHz	-40.73 dBm																																									
<p>CH78 No hopping mode</p>			<table border="1"> <thead> <tr> <th>Type</th> <th>Ref</th> <th>Trc</th> <th>X-value</th> <th>Y-value</th> <th>Function</th> <th>Function Result</th> </tr> </thead> <tbody> <tr> <td>M1</td> <td></td> <td>1</td> <td>2.47999 GHz</td> <td>-0.04 dBm</td> <td></td> <td></td> </tr> <tr> <td>M2</td> <td></td> <td>1</td> <td>2.4835 GHz</td> <td>-47.51 dBm</td> <td></td> <td></td> </tr> <tr> <td>M3</td> <td></td> <td>1</td> <td>2.5 GHz</td> <td>-59.86 dBm</td> <td></td> <td></td> </tr> <tr> <td>M4</td> <td></td> <td>1</td> <td>2.4835478 GHz</td> <td>-46.29 dBm</td> <td></td> <td></td> </tr> </tbody> </table>	Type	Ref	Trc	X-value	Y-value	Function	Function Result	M1		1	2.47999 GHz	-0.04 dBm			M2		1	2.4835 GHz	-47.51 dBm			M3		1	2.5 GHz	-59.86 dBm			M4		1	2.4835478 GHz	-46.29 dBm									
Type	Ref	Trc	X-value	Y-value	Function	Function Result																																							
M1		1	2.47999 GHz	-0.04 dBm																																									
M2		1	2.4835 GHz	-47.51 dBm																																									
M3		1	2.5 GHz	-59.86 dBm																																									
M4		1	2.4835478 GHz	-46.29 dBm																																									

CH78  
Hoppig mode

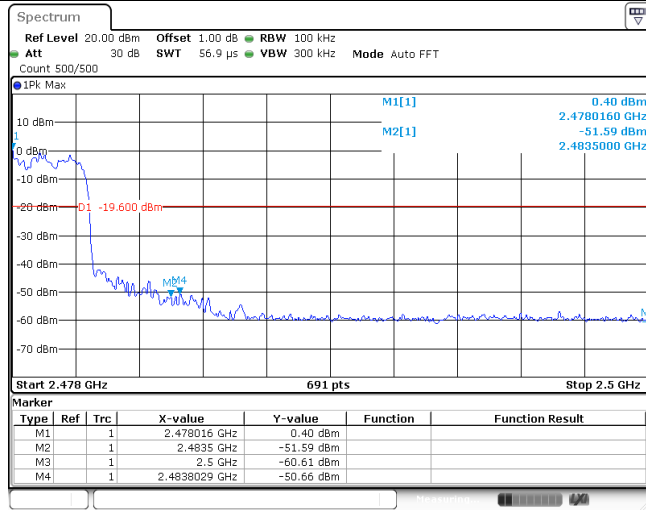

Test Item:	SE	Modulation type:	GFSK
<p>CH00 Reference level</p>			
<p>CH00 30MHz~1000MHz</p>			
<p>CH00 1GHz~26GHz</p>			

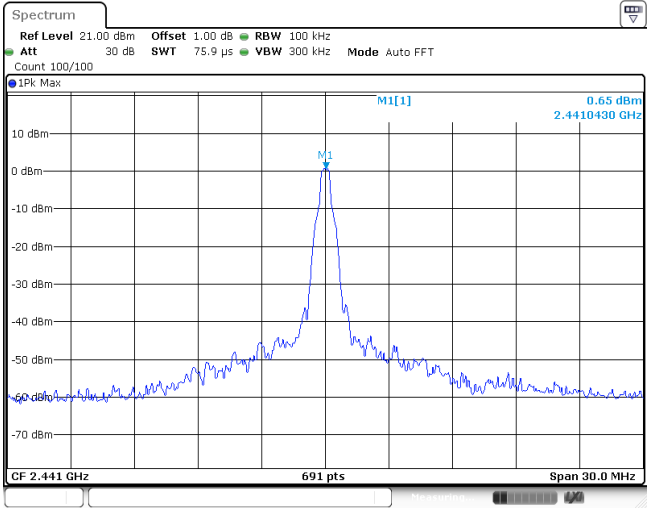
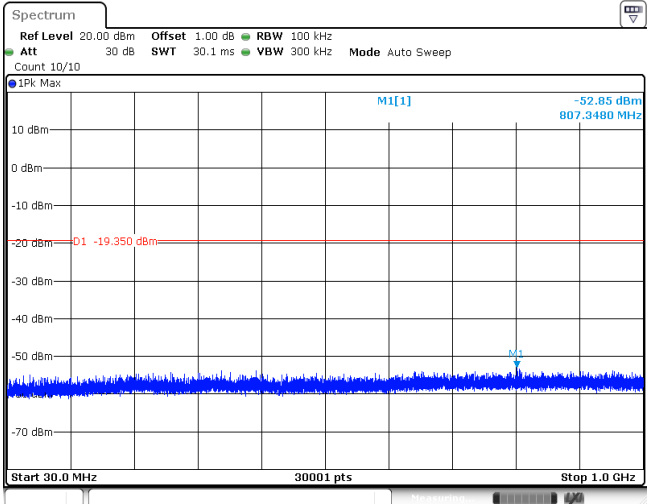
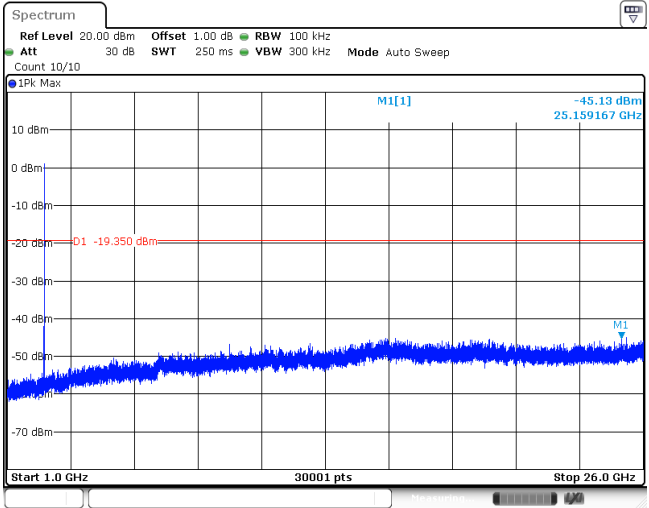
<p>CH39 Reference level</p>	
<p>CH39 30MHz~1000MHz</p>	
<p>CH39 1GHz~26GHz</p>	

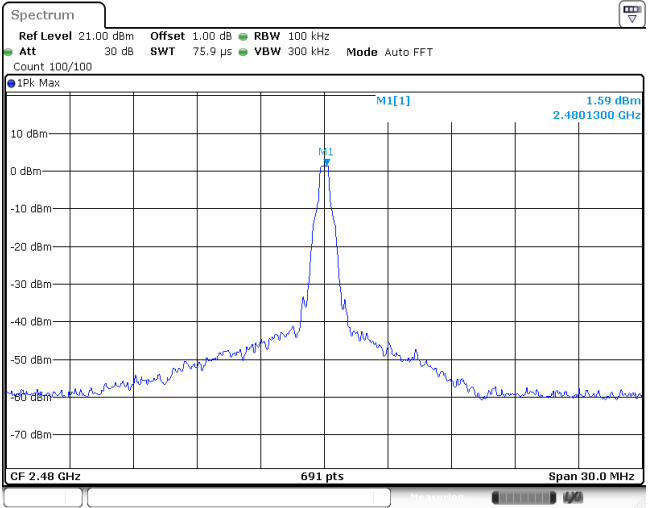
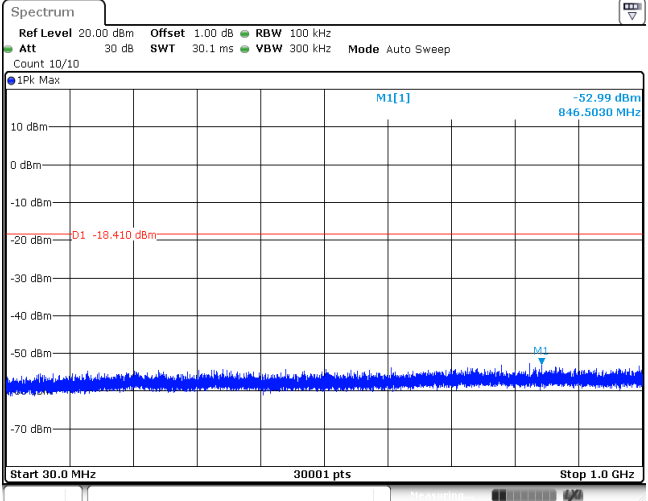
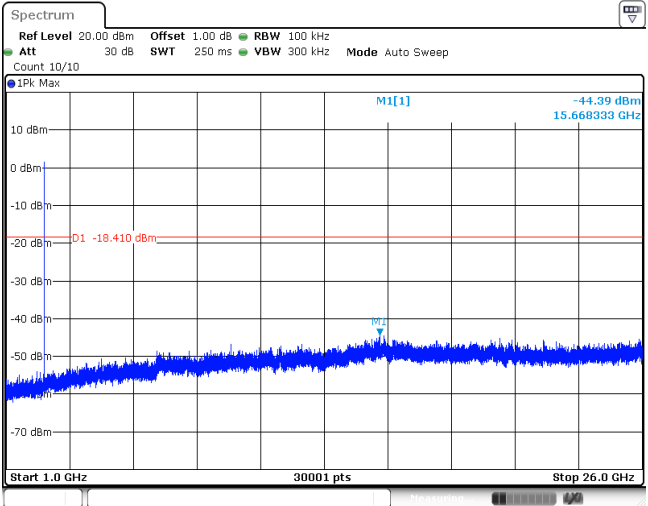
<p>CH78 Reference level</p>	
<p>CH78 30MHz~1000MHz</p>	
<p>CH78 1GHz~26GHz</p>	

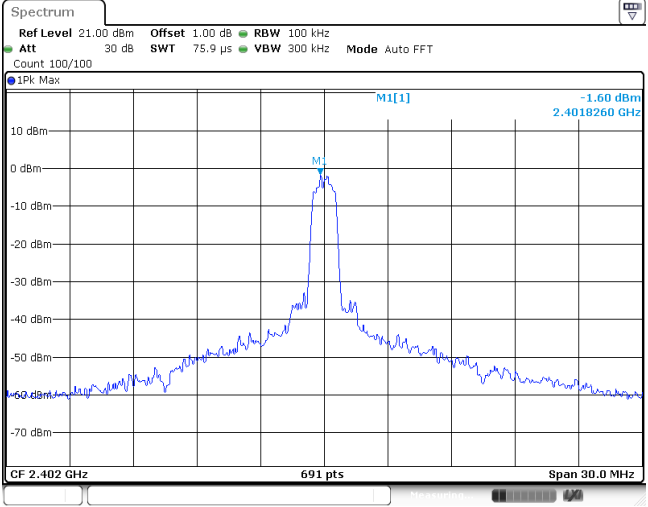
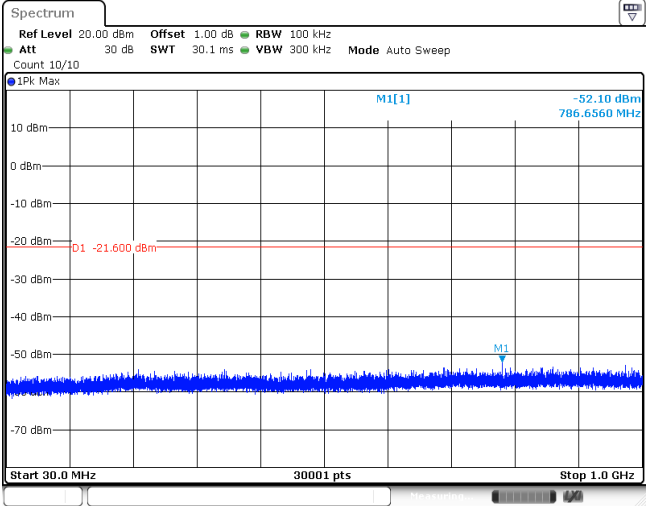
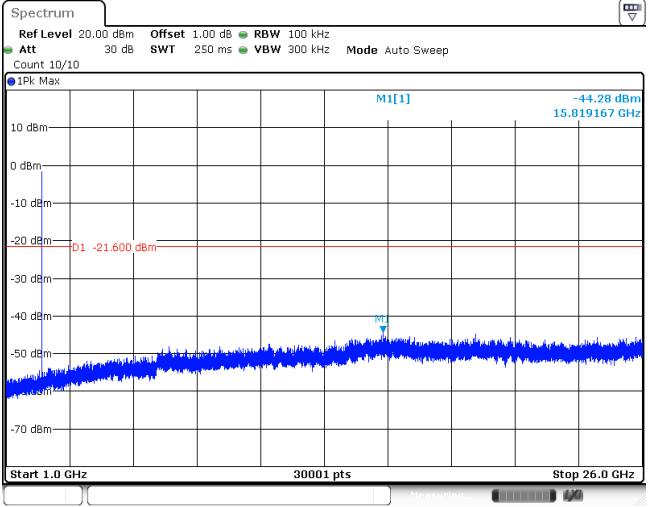
Test Item:	SE	Modulation type:	$\pi/4$ DQPSK
CH00 Reference level			
CH00 30MHz~1000MHz			
CH00 1GHz~26GHz			

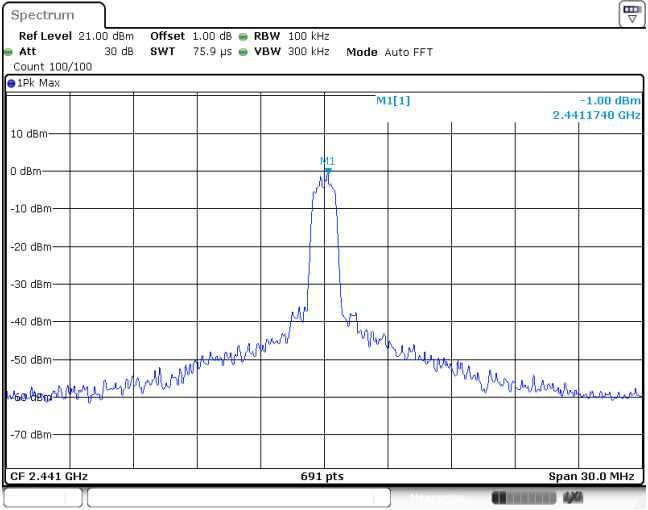
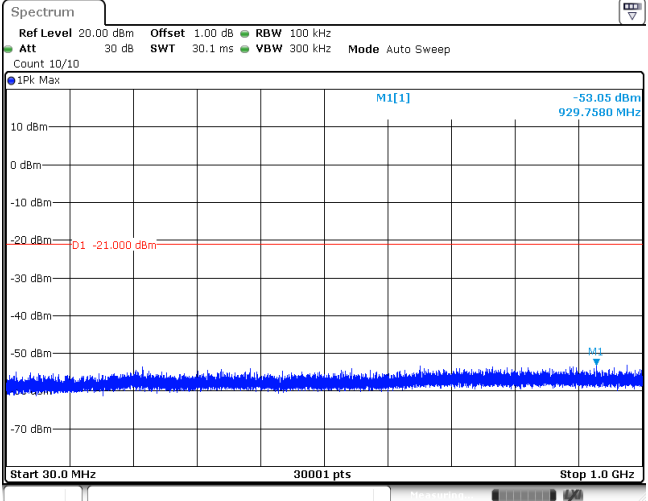
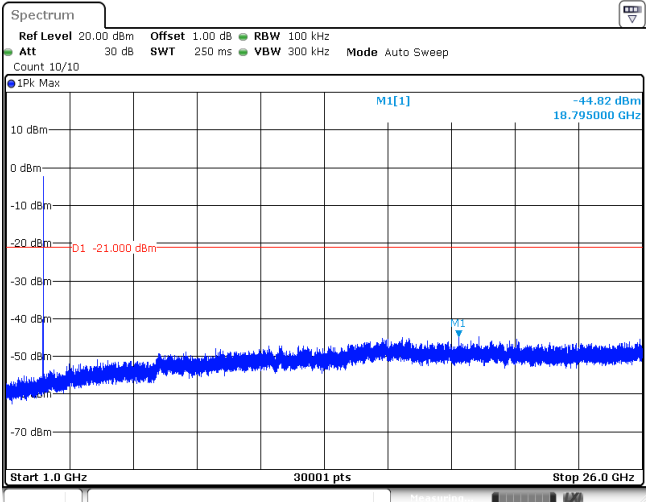
<p>CH39 Reference level</p>	
<p>CH39 30MHz~1000MHz</p>	
<p>CH39 1GHz~26GHz</p>	

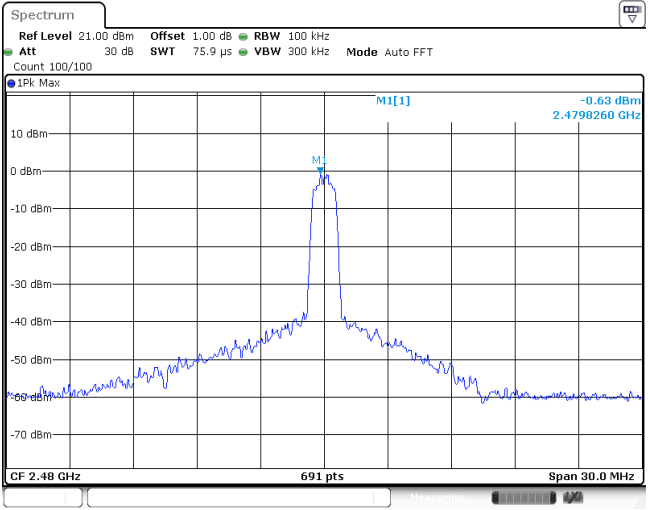
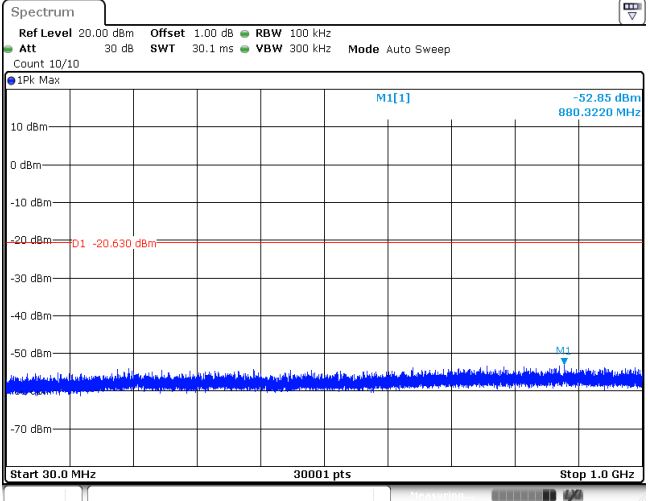
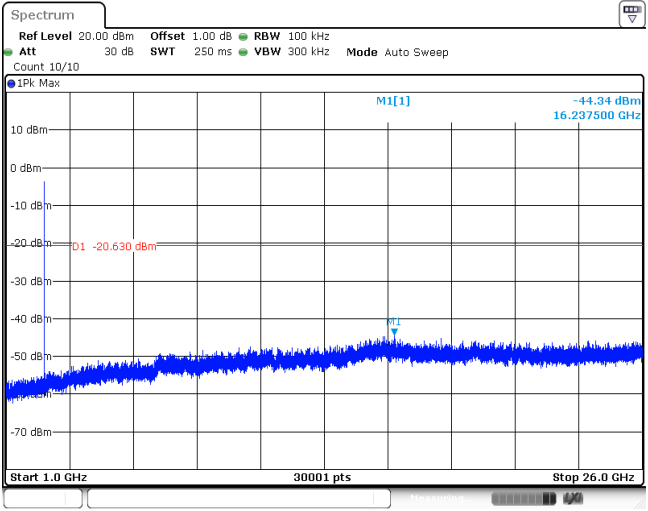

<p>CH78 Reference level</p>	
<p>CH78 30MHz~1000MHz</p>	
<p>CH78 1GHz~26GHz</p>	

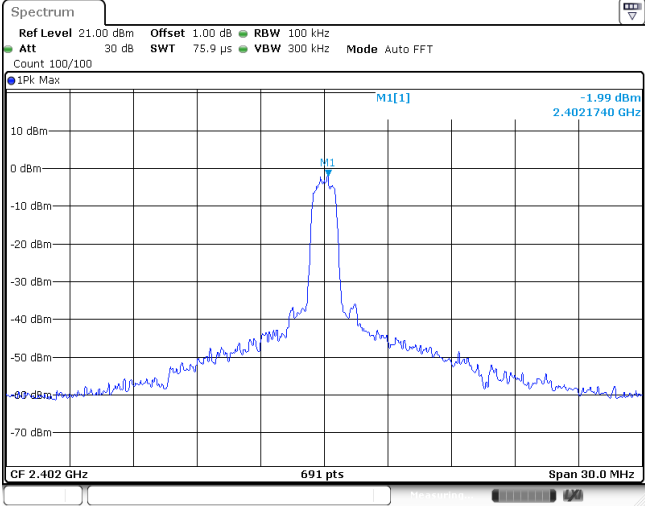
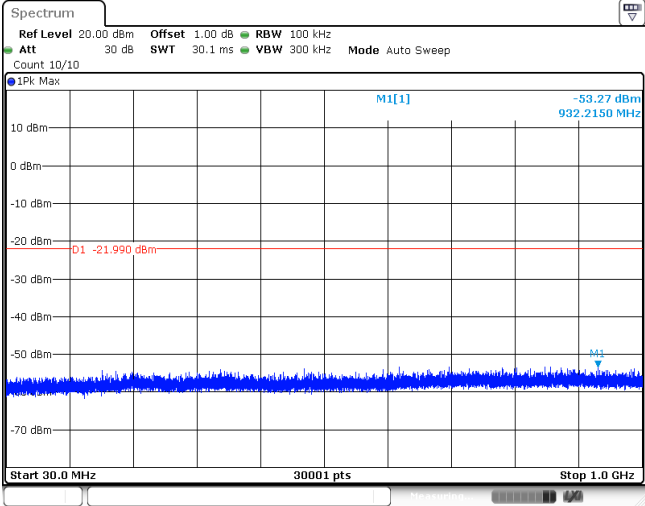
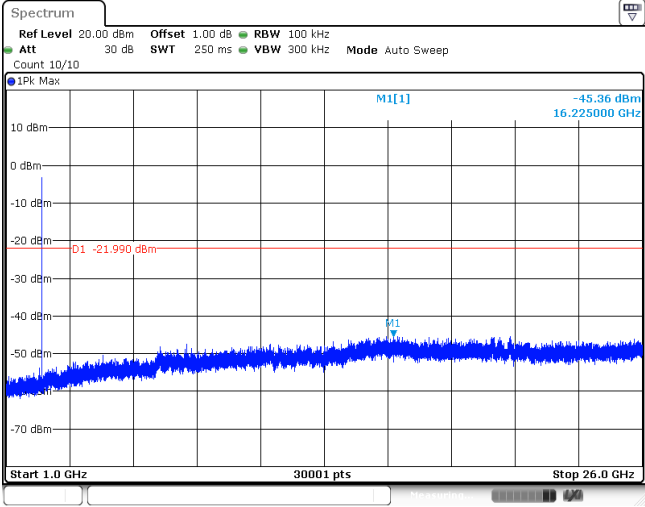
Test Item:	SE	Modulation type:	8DPSK
CH00 Reference level			
CH00 30MHz~1000MHz			
CH00 1GHz~26GHz			

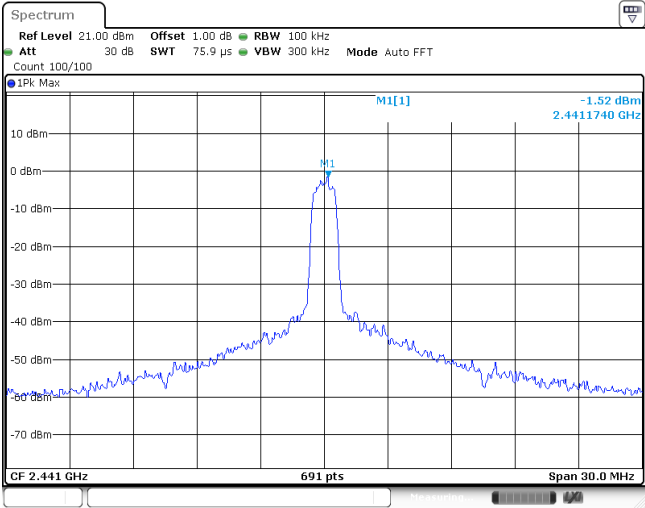
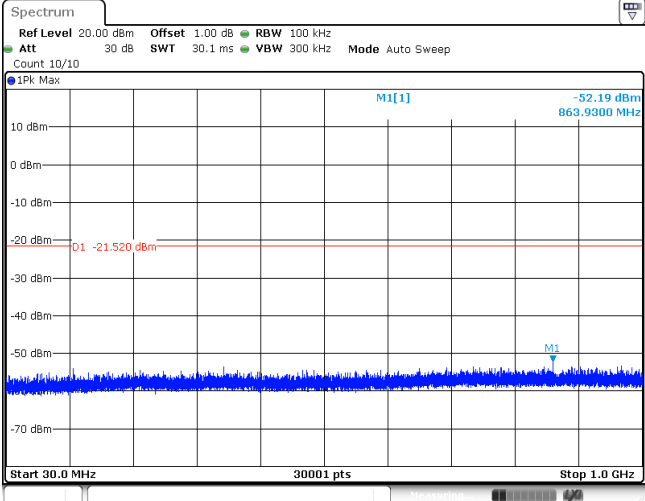
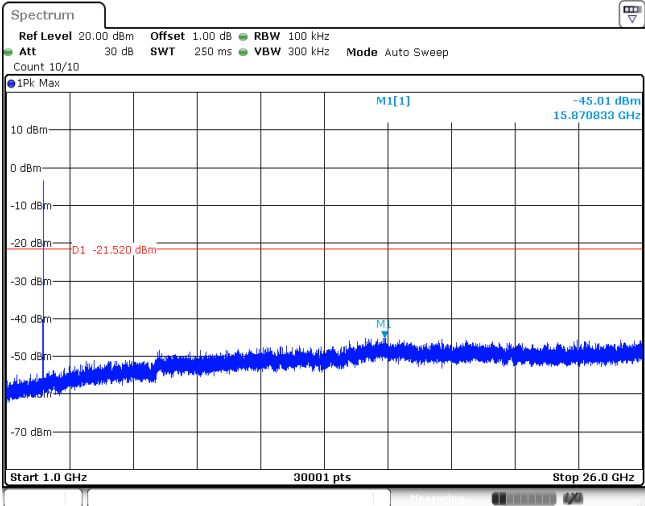
<p>CH39 Reference level</p>	
<p>CH39 30MHz~1000MHz</p>	
<p>CH39 1GHz~26GHz</p>	

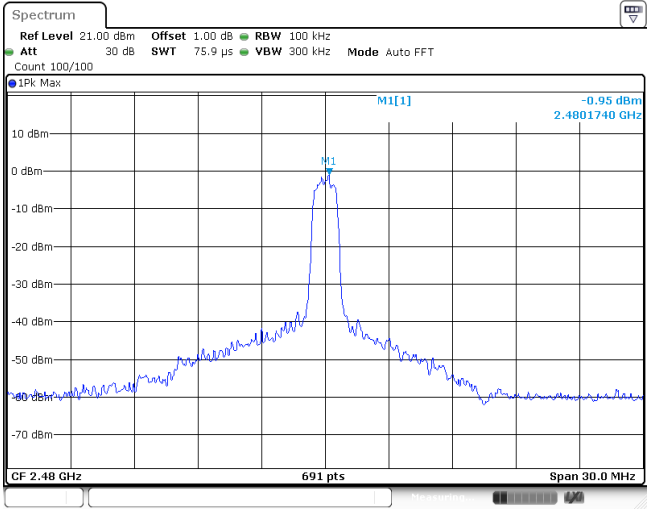
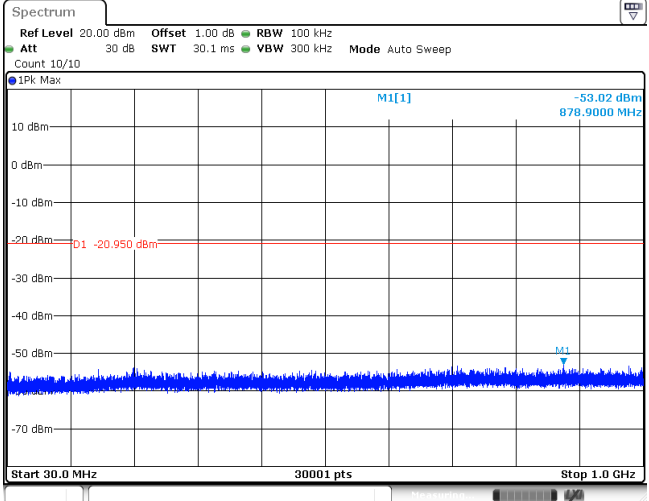
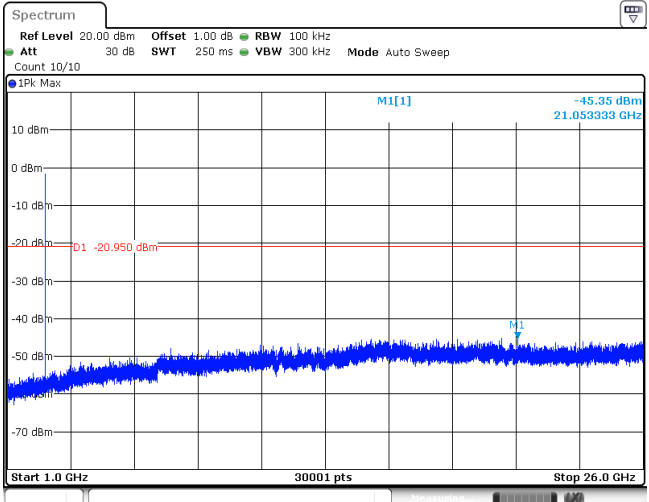
<p>CH78 Reference level</p>	
<p>CH78 30MHz~1000MHz</p>	
<p>CH78 1GHz~26GHz</p>	

### 5.11. Spurious Emissions (radiated)

#### LIMIT

#### FCC CFR Title 47 Part 15 Subpart C Section 15.209

Frequency	Limit (dBuV/m @3m)	Value
30 MHz ~ 88 MHz	40.00	Quasi-peak
88 MHz ~ 216 MHz	43.50	Quasi-peak
216 MHz ~ 960 MHz	46.00	Quasi-peak
960 MHz ~ 1 GHz	54.00	Quasi-peak
Above 1 GHz	54.00	Average
	74.00	Peak

#### TEST CONFIGURATION

- Below 30 MHz

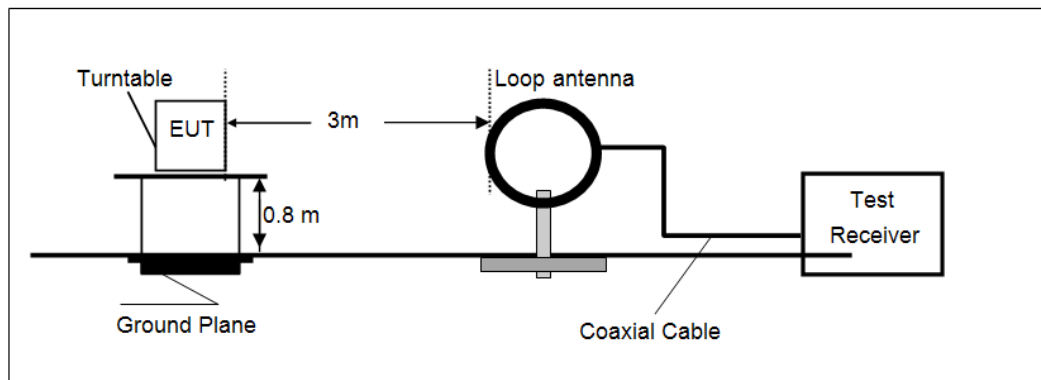

- 30 MHz ~1000 MHz

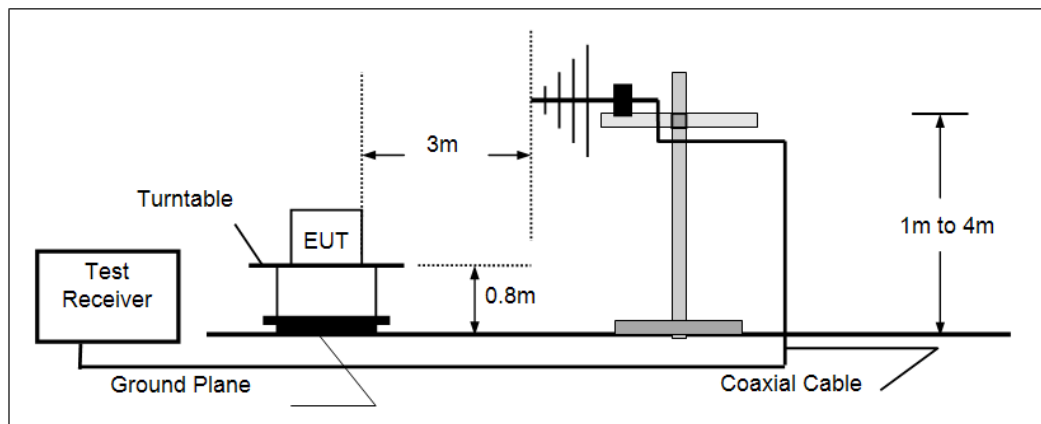

- Above 1 GHz

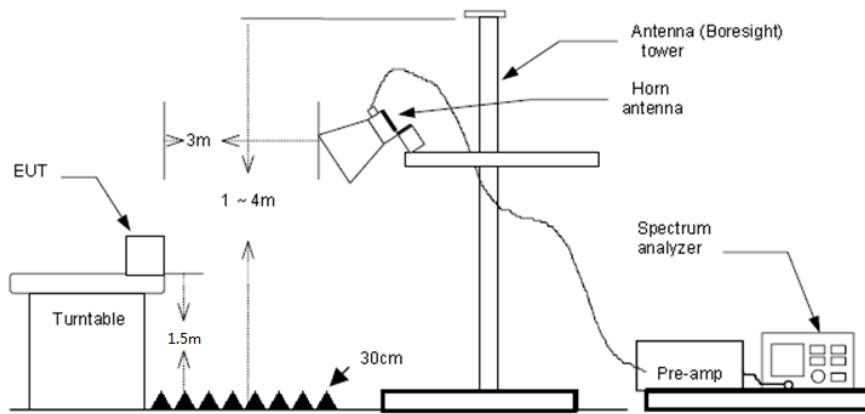

## TEST PROCEDURE

1. The EUT was tested according to ANSI C63.10:2013.
2. The EUT is placed on a turn table with 0.8 meter above ground for below 1GHz, 1.5 meter above ground for above 1GHz.
3. The EUT was set 3 meters from the receiving antenna, which was mounted on the top of a variable height antenna tower.
4. For each suspected emission, the EUT was arranged to its worst case and then tune the Antenna tower (from 1 m to 4 m) and turntable (from 0 degree to 360 degrees) to find the maximum reading. A pre-amp and a high pass filter are used for the test in order to get better signal level to comply with the guidelines.
5. Set to the maximum power setting and enable the EUT transmit continuously.
6. Use the following spectrum analyzer settings
  - (1) Span shall wide enough to fully capture the emission being measured;
  - (2) Below 1 GHz:
    - RBW=120 kHz, VBW=300 kHz, Sweep=auto, Detector function=peak, Trace=max hold;
    - If the emission level of the EUT measured by the peak detector is 3 dB lower than the applicable limit, the peak emission level will be reported. Otherwise, the emission measurement will be repeated using the quasi-peak detector and reported.
  - (3) From 1 GHz to 10<sup>th</sup> harmonic:
    - RBW=1 MHz, VBW=3 MHz Peak detector for Peak value
    - RBW=1 MHz, VBW=10 Hz Peak detector for Average value.

## TEST MODE:

Please refer to the clause 3.3

## TEST RESULTS

Passed       Not Applicable

Note:

- 1) Final Level = Receiver Read level + Antenna Factor + Cable Loss – Preamplifier Factor
- 2) The emission levels of other frequencies are very lower than the limit and not show in test report.
- 3) Below 1 GHz, Have pre-scan all modulation mode, found the GFSK modulation High channel which it was worst case, so only the worst case's data on the test report.
- 4) Above 1 GHz, Have pre-scan all modulation mode, found the GFSK modulation which it was worst case, so only the worst case's data on the test report
- 5) The peak level is lower than average limit(54 dBuV/m), this data is the too weak instrument of signal is unable to test.

### ➤ 9 kHz ~ 30 MHz

The low frequency, which started from 9 kHz to 30 MHz, was pre-scanned and the result which was 20 dB lower than the limit line per 15.31(o) was not reported.

➤ 30 MHz ~ 1 GHz

Polarization: Vertical

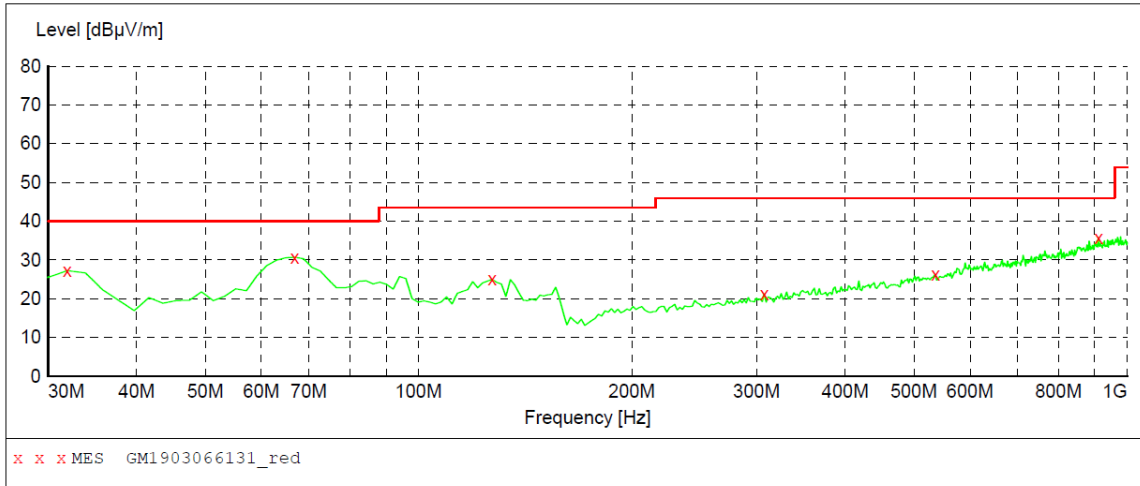

**MEASUREMENT RESULT: "GM1903066131\_red"**

3/6/2019 9:48PM

Frequency MHz	Level dBµV/m	Transd dB	Limit dBµV/m	Margin dB	Det.	Height cm	Azimuth deg	Polarization
31.940000	27.20	-13.2	40.0	12.8	QP	100.0	229.00	VERTICAL
66.860000	30.70	-11.9	40.0	9.3	QP	100.0	359.00	VERTICAL
127.000000	25.00	-12.8	43.5	18.5	QP	100.0	55.00	VERTICAL
307.420000	21.30	-6.8	46.0	24.7	QP	100.0	34.00	VERTICAL
536.340000	26.20	-0.4	46.0	19.8	QP	100.0	346.00	VERTICAL
910.760000	35.80	7.8	46.0	10.2	QP	100.0	90.00	VERTICAL

Polarization: Horizontal

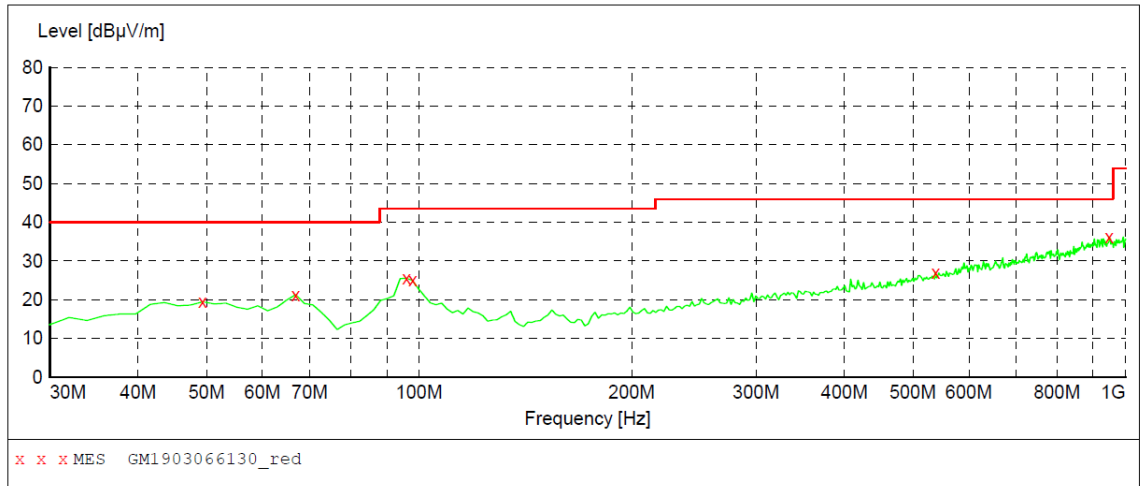

**MEASUREMENT RESULT: "GM1903066130\_red"**

3/6/2019 9:45PM

Frequency MHz	Level dBµV/m	Transd dB	Limit dBµV/m	Margin dB	Det.	Height cm	Azimuth deg	Polarization
49.400000	19.50	-8.7	40.0	20.5	QP	100.0	186.00	HORIZONTAL
66.860000	21.30	-11.9	40.0	18.7	QP	300.0	138.00	HORIZONTAL
95.960000	25.50	-11.0	43.5	18.0	QP	300.0	347.00	HORIZONTAL
97.900000	25.00	-10.6	43.5	18.5	QP	300.0	334.00	HORIZONTAL
538.280000	27.10	-0.4	46.0	18.9	QP	300.0	208.00	HORIZONTAL
947.620000	36.30	8.2	46.0	9.7	QP	100.0	197.00	HORIZONTAL

## ➤ 1 GHz ~ 25 GHz

CH00									
Frequency (MHz)	Read Level (dBuV)	Antenna Factor (dB/m)	Cable Loss (dB)	Preamp Factor (dB)	Level (dBuV/m)	Limit Line (dBuV/m)	Over Limit (dB)	Polarization	Test value
2995.54	49.81	28.60	7.48	37.58	48.31	74.00	-25.69	Vertical	Peak
3993.90	35.35	29.70	8.77	36.76	37.06	74.00	-36.94	Vertical	Peak
4983.99	38.09	31.48	9.66	35.41	43.82	74.00	-30.18	Vertical	Peak
7941.19	32.55	36.87	12.58	33.06	48.94	74.00	-25.06	Vertical	Peak
2995.54	40.13	28.60	7.48	37.58	38.63	74.00	-35.37	Horizontal	Peak
3570.71	35.81	29.21	8.22	37.08	36.16	74.00	-37.84	Horizontal	Peak
4996.69	36.94	31.50	9.67	35.39	42.72	74.00	-31.28	Horizontal	Peak
7376.08	31.50	36.30	12.04	33.23	46.61	74.00	-27.39	Horizontal	Peak

CH39									
Frequency (MHz)	Read Level (dBuV)	Antenna Factor (dB/m)	Cable Loss (dB)	Preamp Factor (dB)	Level (dBuV/m)	Limit Line (dBuV/m)	Over Limit (dB)	Polarization	Test value
2987.92	49.24	28.59	7.47	37.58	47.72	74.00	-26.28	Vertical	Peak
3983.75	37.60	29.70	8.76	36.77	39.29	74.00	-34.71	Vertical	Peak
4983.99	39.14	31.48	9.66	35.41	44.87	74.00	-29.13	Vertical	Peak
7357.33	31.91	36.30	12.03	33.26	46.98	74.00	-27.02	Vertical	Peak
2987.92	39.47	28.59	7.47	37.58	37.95	74.00	-36.05	Horizontal	Peak
3844.28	34.07	29.64	8.56	36.87	35.40	74.00	-38.60	Horizontal	Peak
4983.99	33.76	31.48	9.66	35.41	39.49	74.00	-34.51	Horizontal	Peak
7209.02	32.87	36.21	11.87	33.51	47.44	74.00	-26.56	Horizontal	Peak

CH78									
Frequency (MHz)	Read Level (dBuV)	Antenna Factor (dB/m)	Cable Loss (dB)	Preamp Factor (dB)	Level (dBuV/m)	Limit Line (dBuV/m)	Over Limit (dB)	Polarization	Test value
2987.92	48.89	28.59	7.47	37.58	47.37	74.00	-26.63	Vertical	Peak
3993.90	36.13	29.70	8.77	36.76	37.84	74.00	-36.16	Vertical	Peak
4996.69	38.87	31.50	9.67	35.39	44.65	74.00	-29.35	Vertical	Peak
7682.70	31.88	36.12	12.94	33.04	47.90	74.00	-26.10	Vertical	Peak
2995.54	39.97	28.60	7.48	37.58	38.47	74.00	-35.53	Horizontal	Peak
3690.85	34.70	29.30	8.37	36.99	35.38	74.00	-38.62	Horizontal	Peak
4996.69	42.13	31.50	9.67	35.39	47.91	74.00	-26.09	Horizontal	Peak
7357.33	31.13	36.30	12.03	33.26	46.20	74.00	-27.80	Horizontal	Peak

## Remark:

1. Final Level = Receiver Read level + Antenna Factor + Cable Loss – Preamplifier Factor
2. The peak level is lower than average limit(54 dBuV/m), this data is the too weak instrument of signal is unable to test.
3. The emission levels of other frequencies are very lower than the limit and not show in test report.



## 6. TEST SETUP PHOTOS

Conducted Emissions (AC Mains)



Radiated Emissions



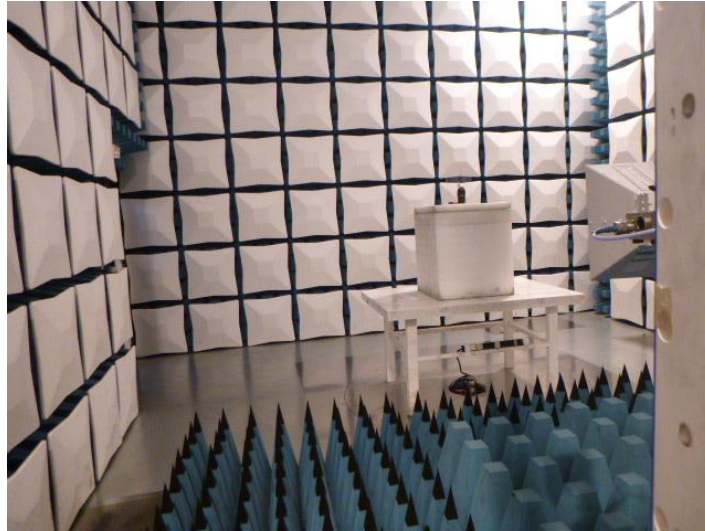

## **7. EXTERANAL AND INTERNAL PHOTOS**

Reference to the test report No.: CHTEW19030209

-----End of Report-----