

**ELECTROMAGNETIC EMISSIONS COMPLIANCE REPORT
INTENTIONAL RADIATOR CERTIFICATION TO
FCC PART 90 REQUIREMENTS**

OF

MOBILE RADIO

MODEL No.: PT8000-01

BRAND NAME: KIRISUN

FCC ID: Q5EPT800001

REPORT NO: WE09070026

ISSUE DATE: Aug 03, 2009

Prepared for

**KIRISUN ELECTRONICS(SHENZHEN) CO., LTD.
6/F., BLDG. H-2, EAST INDUSTRIAL ZONE OF OVERSEAS
CHINESE TOWN NANSHAN DIST.,
SHENZHEN P.R. CHINA**

Prepared by

**SHENZHEN HUATONGWEI INTERNATIONAL
INSPECTION CO., LTD**

d.b.a.

**SHENZHEN HUATONGWEI INTERNATIONAL INSPECTION CO., LTD
HUATONGWEI BUILDING, KEJI RD. 12 S., HIGH-TECH PARK,
NANSHAN DISTRICT, SHENZHEN,
GUANGDONG, P.R.CHINA**

TEL: 86-755-26748099

FAX: 86-755-26748005

VERIFICATION OF COMPLIANCE

Applicant:	KIRISUN ELECTRONICS (SHENZHEN) CO., LTD. 6/F.,Bldg.H-2,East Industrial Zone of Overseas Chinese Town,Nanshan Dist.,Shenzhen P.R.China
Product Description:	MOBILE RADIO
Brand Name:	KIRISUN
Model Number:	PT8000-01
Serial Number:	N/A
File Number:	WE09070026
Date of Test:	Jul 28, 2009 ~ Aug 03, 2009

We hereby certify that:

The above equipment was tested by SHENZHEN HUATONGWEI INTERNATIONAL INSPECTION CO., LTD. The test data, data evaluation, test procedures, and equipment configurations shown in this report were made in accordance with the procedures given in ANSI C63.4 (2003), TIA/EIA 603 and the energy emitted by the sample EUT tested as described in this report is in compliance with radiated emission limits of FCC Rules Part 90.

The test results of this report relate only to the tested sample identified in this report.

Approved By



Jimmy Li / Manager
SHENZHEN HUA TONG WEI
INTERNATIONAL INSPECTION CO., LTD

Reviewed By

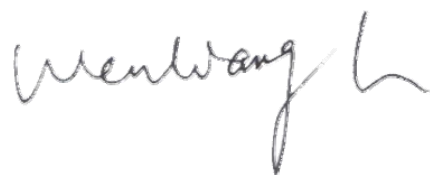

Wenliang Li / RF Engineer
SHENZHEN HUA TONG WEI
INTERNATIONAL INSPECTION CO., LTD

Table of Contents

1. GENERAL INFORMATION	5
1.1 PROCUCT DESCRIPTION	5
1.2 RELATED SUBMITTSL(S) / GRANT(S)	5
1.3 TEST METHODOLOGY	5
1.4 TEST FACILITY	5
1.5 SPECIAL ACCESSORIES	5
1.6 EQUIPMENT MODIFICATIONS	5
1.7 EQUIPENT	6
1.8 LABORATORY ACCREDITATIONS AND LISTINGS	6
2. SYSTEM TEST CONFIGURATION	8
2.1 EUT CONFIGURATION	8
2.2 EUT EXERCISE	8
2.3 GENERAL TECHNICAL REQUIREMENTS AND SUMMARY OF TEST RESULTS	8
2.4 CONFIGUARATION OF TESTED SYSTEM	8
3. DESCRIPTION OF TEST MODES	9
4. CONDUCTED EMISSION TEST	10
4.1 MEASUREMENT PROCEDURE	10
4.2 TEST SETUP BLOCK DIAGRAM	10
4.3 TEST EQUIPENT USED:	11
4.4 CONDUCTED POWER LINE EMISSION LIMITS	11
4.5 TEST RESULTS	11
5. OCCUPIED BANDWIDTH	12
5.1 PROVISIONS APPLICABLE	12
5.2 MEASUREMENT PROCEDURE	12
5.3 TEST SETUP BLOCK DIAGRAM	12
5.4 MEASUREMENT EQUIPMENT USED:	13
5.5 TEST RESULTS:	13
6. RADIATED SPURIOUS EMISSION	20
6.1 PROVISIONS APPLICABLE	20
6.2 MEASUREMENT PROCEDURE	20
6.3 TEST SETUP BLOCK DIAGRAM	22
6.4 MEASUREMENT EQUIPMENT USED:	23
6.5 TEST RESULTS:	24
7. SPURIOUS EMISSION ON ANTENNA PORT	29
7.1 PROVISIONS APPLICABLE	29
7.2 MEASUREMENT PROCEDURE	29
7.3 TEST SETUP BLOCK DIAGRAM	29
7.4 TEST RESULTS:	29
8. MODULATION CHARACTERISTICS	36
8.1 PROVISIONS APPLICABLE	36
8.2 MEASUREMENT METHOD	36
8.3 MEASUREMENT EQUIPMENT USED:	37
8.4 TEST RESULTS:	37
9. FREQUENCY STABILITY MEASUREMENT	40
9.1 PROVISIONS APPLICABLE	40
9.2 MEASUREMENT PROCEDURE	40
9.3 TEST SETUP BLOCK DIAGRAM	40
9.4 MEASUREMENT EQUIPMENT USED:	40
9.5 TEST RESULTS:	41
10. CONDUCTED OUTPUT POWER	45
10.1PROVISIONS APPLICABLE	45
10.2TEST PROCEDURE	45
10.3 TEST SETUP BLOCK DIAGRAM	45
10.4MEASUREMENT EQUIPMENT USED:	45

10.5 TEST RESULTS:.....	45
11. TRANSMITTER FREQUENCY BEHAVIOR.....	52
11.1 PROVISIONS APPLICABLE	52
11.2 TEST METHOD.....	52
11.3 TEST SETUP BLOCK DIAGRAM.....	52
11.4 MEASUREMENT EQUIPMENT USED:.....	53
11.5 TEST RESULTS:.....	53
APPENDIX 1	56
PHOTOGRAPHS OF TEST SETUP.....	56
APPENDIX 2	57
PHOTOGRAPHS OF EUT	57

1. GENERAL INFORMATION

1.1 PRODUCT DESCRIPTION

The KIRISUN ELECTRONICS (SHENZHEN) CO., LTD.'s Model: PT8000-01 or the "EUT" as referred to in this report is a single channel Mobile Radio designed for voice communication. It is designed by way of utilizing the FM modulation achieves the system operating.

* The test data gathered are from typical production samples provided by the manufacturer.

A major technical description of EUT is described as following:

- a). Modulation: FM
- b). Maximum Transmitter Power: 25W
- c). Antenna Designation: Detachable
- d). Power Supply: DC 13.6V
- e). Operating Frequency Range
Frequency Range: 136 ~ 174MHz
- f). Maximum Transmitter Power: 25.35 W for 25 KHz channel separation
25.35 W for 12.5 KHz channel separation

1.2 RELATED SUBMITTAL(S) / GRANT(S)

This submittal(s) (test report) is intended for FCC ID: Q5EPT800001 filing to comply with the FCC Part 90.

1.3 TEST METHODOLOGY

The radiated emission testing was performed according to the procedures of ANSI C63.4; TIA/EIA 603 and FCC CFR 47 2.1046, 2.1047, 2.1049, 2.1051, 2.1053 and 2.1055.

1.4 TEST FACILITY

The fully anechoic chamber test site and conducted measurement facility used to collect the radiated data is located on the address of SHENZHEN HUATONGWEI INTERNATIONAL INSPECTION CO., LTD Huatongwei Building, Keji Rd. 12 S., High-tech Park, Nanshan District, Shenzhen, Guangdong, P.R.China

The fully anechoic chamber Test Sites and the Line Conducted labs are constructed and calibrated to meet the FCC requirements in documents ANSI C63.4: 2003 and CISPR 22/EN 55022 requirements.

1.5 SPECIAL ACCESSORIES

Not available for this EUT intended for grant.

1.6 EQUIPMENT MODIFICATIONS

Not available for this EUT intended for grant.

1.7 EQUIPMENT

Radiated emissions are measured with one or more of the following types of linearly polarized antennas: tuned dipole, biconical, log periodic, bi-log, and/or ridged waveguide, horn. Spectrum analyzers with preselectors and quasi-peak detectors are used to perform radiated measurements.

Conducted emissions are measured with Line Impedance Stabilization Networks and EMI Test Receivers.

Calibrated wideband preamplifiers, coaxial cables, and coaxial attenuators are also used for making measurements.

All receiving equipment conforms to CISPR Publication 16-1, "Radio Interference Measuring Apparatus and Measurement Methods."

1.8 LABORATORY ACCREDITATIONS AND LISTINGS

The test facility is recognized, certified, or accredited by the following organizations:

CNAS-Lab Code: L1225

Shenzhen Huatongwei International Inspection Co., Ltd has been assessed and proved to be in compliance with CNAS-CL01 Accreditation Criteria for Testing and Calibration Laboratories (identical to ISO/IEC 17025: 2005 General Requirements) for the Competence of Testing and Calibration Laboratories, Date of Registration: August 02, 2007. Valid time is until March 29, 2012.

A2LA-Lab Cert. No. 2243.01

Shenzhen Huatongwei International Inspection Co., Ltd, EMC Laboratory has been accredited by A2LA for technical competence in the field of electrical testing, and proved to be in compliance with ISO/IEC 17025: 2005 General Requirements for the Competence of Testing and Calibration Laboratories and any additional program requirements in the identified field of testing. Valid time is from Aug 24, 2005 to Sept 30, 2009.

FCC-Registration No.: 662850

Shenzhen Huatongwei International Inspection Co., Ltd, EMC Laboratory has been registered and fully described in a report filed with the FCC (Federal Communications Commission). The acceptance letter from the FCC is maintained in our files. Registration 662850, Renewal date July 01, 2009.

IC-Registration No.: 5377

The 3m Alternate Test Site of Shenzhen Huatongwei International Inspection Co., Ltd has been registered by Certification and Engineering Bureau of Industry Canada for the performance of radiated measurements with Registration No. 5377 on February 13th, 2009.

ACA

Shenzhen Huatongwei International Inspection Co., Ltd, EMC Laboratory can also perform testing for the Australian C-Tick mark as a result of our A2LA accreditation.

NEMKO-Aut. No.: ELA125

Shenzhen Huatongwei International Inspection Co., Ltd has been assessed the quality assurance system, the testing facilities, qualifications and testing practices of the relevant parts of the organization. The quality assurance system of the Laboratory has been validated against ISO/IEC 17025:2005 or equivalent. The laboratory also fulfils the conditions described in Nemko Document NLA-10, the Authorization is valid through April 25, 2009.

VCCI

The 3m Semi-anechoic chamber (12.2m×7.95m×6.7m) and Shielded Room (8m×4m×3m) of Shenzhen Huatongwei International Inspection Co., Ltd has been registered in accordance with the Regulations for Voluntary Control Measures with Registration No.: R-2484. Date of Registration: December 20, 2006. Valid time is until December 19, 2009.

Main Ports Conducted Interference Measurement of Shenzhen Huatongwei International Inspection Co., Ltd has been registered in accordance with the Regulations for Voluntary Control Measures with Registration No.: C-2726. Date of Registration: December 20, 2006. Valid time is until December 19, 2009.

DNV

Shenzhen Huatongwei International Inspection Co Ltd has been found to comply with the requirements of DNV towards subcontractor of EMC and safety testing services in conjunction with the EMC and Low voltage Directives and in the voluntary field. The acceptance is based on a formal quality Audit and follow-ups according to relevant parts of ISO/IEC Guide 17025(2005), in accordance with the requirements of the DNV Laboratory Quality Manual towards subcontractors. Valid time is until 09 July, 2010.

2. SYSTEM TEST CONFIGURATION

2.1 EUT CONFIGURATION

The EUT configuration for testing is installed on RF field strength measurement to meet the Commission’s requirement and operating in a manner which intends to maximize its emission characteristics in a continuous normal application.

2.2 EUT EXERCISE

The Transmitter was operated in the normal operating mode. The TX frequency was fixed which was for the purpose of the measurements.

2.3 GENERAL TECHNICAL REQUIREMENTS AND SUMMARY OF TEST RESULTS

The EUT has been tested according to the following specifications:

Standard	Test Type	Result	Notes
FCC Part 15, Paragraph 15.107	AC Line Conducted Emission	N/A	Owing to the DC operation of EUT, this test item is not performed.
FCC 2.1046 & 90.205(h)	RF Output Power	PASS	Complies
FCC 2.1047 & 90.207 & 90.210(b)	Modulation Characteristics	PASS	Complies
FCC 2.1049 & 90.209(b)(5) & 90.210(b)	Occupied Bandwidth	PASS	Complies
FCC 2.1053 & 90.210(b)	Radiated Spurious Emission	PASS	Complies.
FCC 2.1051 & 90.210(b)	Spurious Emission on Antenna Port	PASS	Complies.
FCC 2.1055 & 90.213	Frequency Stability Vs. Temperature Vs. Voltage	PASS	Complies.
FCC Section 90.214	Transient Frequency Behavior	PASS	Complies.

2.4 CONFIGURATION OF TESTED SYSTEM

Fig. 2-1 Configuration of Tested System



3 DESCRIPTION OF TEST MODES

The EUT (MOBILE RADIO) has been tested under normal operating condition. Three channels (the top, the middle and the bottom) are chosen for testing at each channel separation (12.5 KHz/ 25KHz).

4. CONDUCTED EMISSION TEST

4.1 MEASUREMENT PROCEDURE

The EUT was tested according to ANSI C63.4 - 2003. The frequency spectrum from 0.15 MHz to 30 MHz was investigated. The LISN used was 50 ohm / 50 u Henry as specified by section 5.1 of ANSI C63.4 - 2003. Cables and peripherals were moved to find the maximum emission levels for each frequency.

Note: The EUT will not be operated during charging the battery with the power adapter.

4.2 TEST SETUP BLOCK DIAGRAM

(Block diagram of configuration)

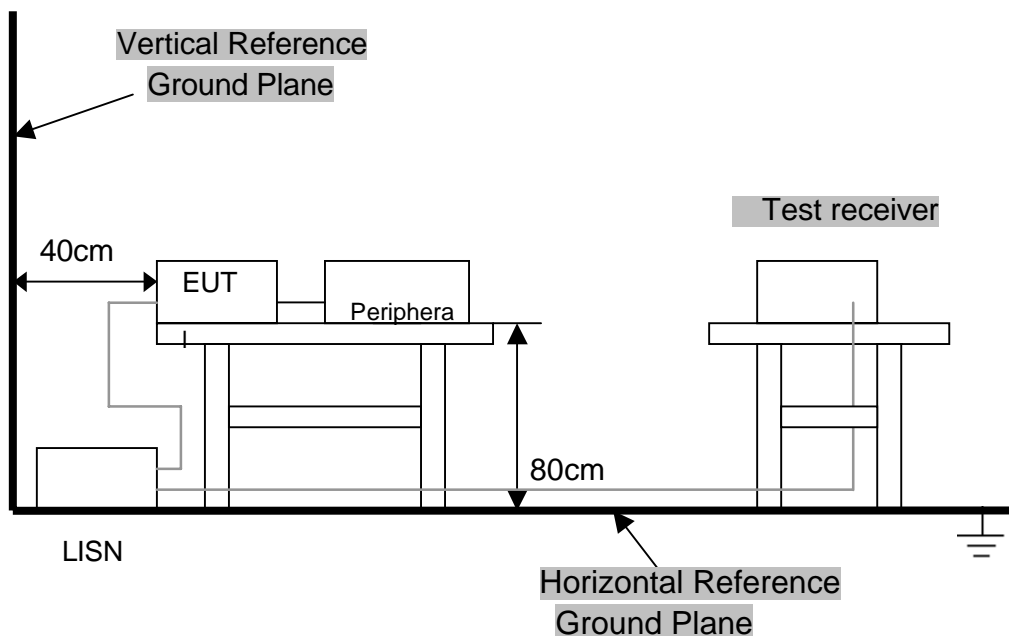

For the actual test configuration, Please refer to the related items – Photos of Testing.

4.3 TEST EQUIPMENT USED:

Conducted Emission Test Site # 3				
Name of Equipment	Manufacturer	Model	Serial Number	Calibration Due
ARTIFICIAL MAINS	ROHDE&SCHWARZ	ESH2-Z5	100028	11/2009
EMI TEST RECEIVER	ROHDE &SCHWARZ	ESCS 30	100038	11/2009
PULSE LIMITER	ROHDE&SCHWARZ	ESHSZ2	100044	11/2009
EMI TEST SOFTWARE	ROHDE&SCHWARZ	ES-K1 V1.71	N/A	11/2009

4.4 CONDUCTED POWER LINE EMISSION LIMITS

FCC Part 15 Paragraph 15.107 (dBuV)		
Frequency Range (MHz)	Class A QP/AV	Class B QP/AV
0.15 – 0.5	79/66	66-56/56-46
0.5 – 5.0	73/60	56/46
5.0 - 30	73/60	60/50

NOTE: In the above table, the tighter limit applies at the band edges.

4.5 TEST RESULTS

Owing to the DC operation of EUT, this test item is not performed.

5. OCCUPIED BANDWIDTH

5.1 PROVISIONS APPLICABLE

According to FCC Part 90 Section 90.209: The authorized bandwidth shall be 11.25 KHz for 12.5 KHz and 20 KHz for 25 KHz.

For any frequency removed from the center of the authorized bandwidth f_0 to 5.625 kHz removed from f_0 , 0dB.

On any frequency removed from the center of the authorized bandwidth by a displacement frequency (f_d in kHz) of more than 5.626 kHz but no more than 12.5 kHz, at least $7.27 (f_d - 2.88 \text{ kHz})$ dB.

On any frequency removed from the center of the authorized bandwidth by a displacement frequency (f_d in kHz) of more than 12.5 kHz at least:

$$50 + 10 \log P = 50 + 10 \log (25.35) = 64.04 \text{ dB}$$

For 25 KHz:

$$43 + 10 \log (25.35) = 57.04 \text{ dB}$$

5.2 MEASUREMENT PROCEDURE

- 1). The EUT was placed on a turntable which is 0.8m above ground plane.
- 2). Set EUT as normal operation
- 3). Set SPA Center Frequency = fundamental frequency, RBW=300Hz, VBW= 3 KHz, span =50 KHz.

5.3 TEST SETUP BLOCK DIAGRAM

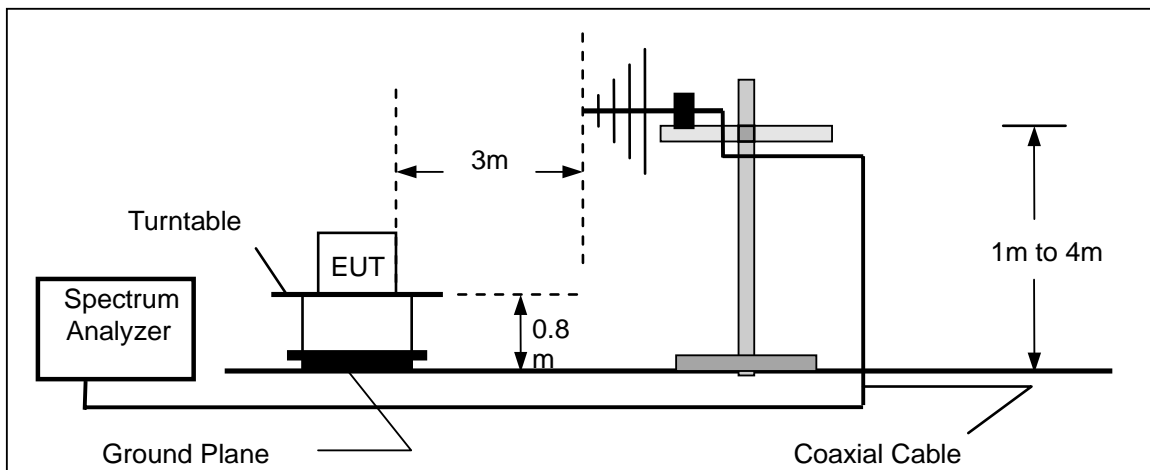

5.4 MEASUREMENT EQUIPMENT USED:

3/5 Anechoic Chamber Radiation Test Site # 4					
EQUIPMENT TYPE	MFR	MODEL NUMBER	SERIAL NUMBER	LAST CAL.	CAL DUE.
ULTRA-BROADBAND ANTENNA	ROHDE & SCHWARZ	HL562	100015	2008/11	2009/11
EMI TEST RECEIVER	ROHDE & SCHWARZ	ESI 26	100009	2008/11	2009/11
RF TEST PANEL	ROHDE & SCHWARZ	TS / RSP	335015/ 0017	N/A	N/A
TURNTABLE	ETS	2088	2149	N/A	N/A
ANTENNA MAST	ETS	2075	2346	N/A	N/A
EMI TEST SOFTWARE	ROHDE & SCHWARZ	ES-K1 V1.71	N/A	2008/11	2009/11

5.5 TEST RESULTS:

Referred as the attached plot hereinafter

Note: The blue curve represents unmodulated signal.

The black curve represents modulated signal.

For 25 KHz:

Occupied Bandwidth of Top Channel

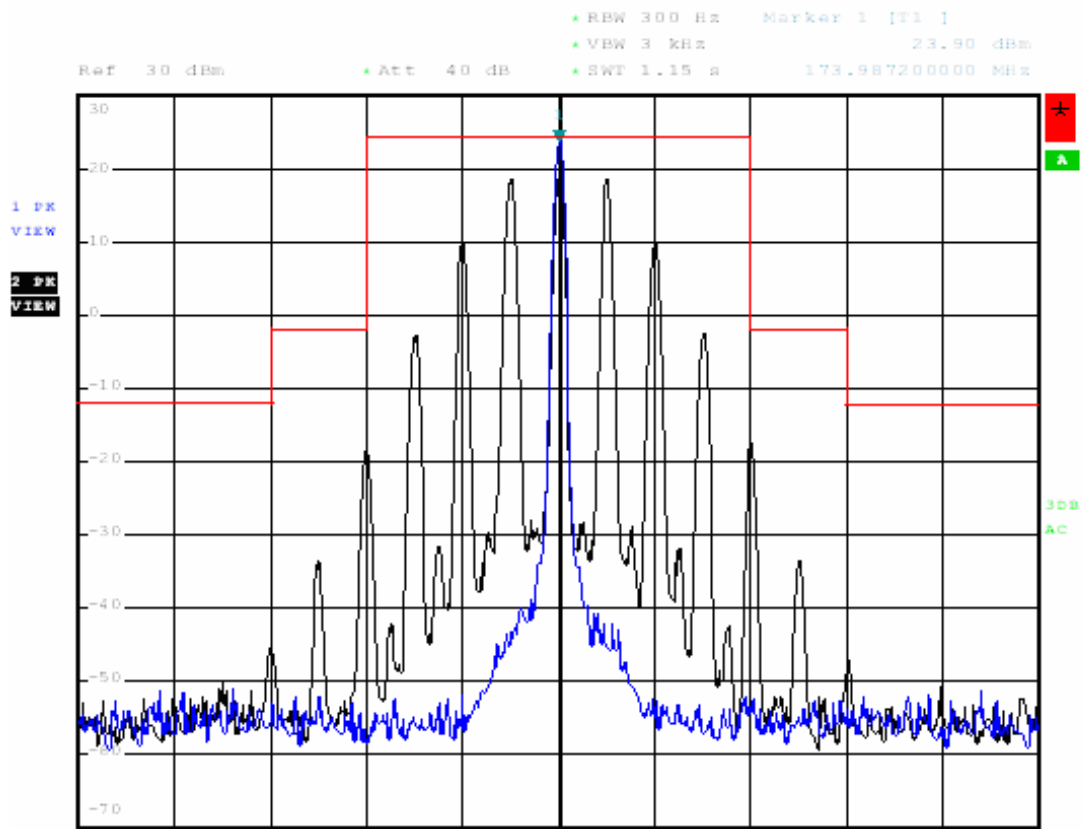

Date: 30.JUL.2009 21:19:05

25 kHz Channel Spacing, 173.98750MHz, 2500 Hz Audio Modulation Only

Occupied Bandwidth of Middle Channel

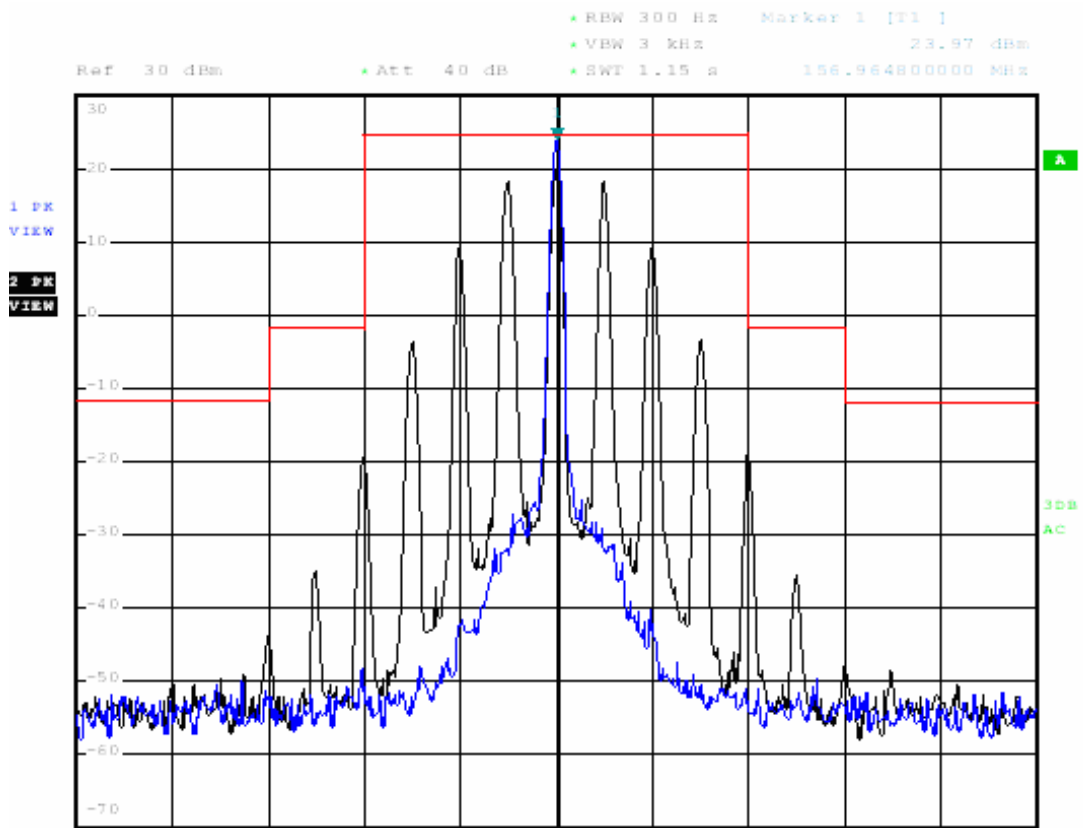

Date: 28.JUL.2009 21:03:01

25 kHz Channel Spacing, 156.96500MHz, 2500 Hz Audio Modulation Only

Occupied Bandwidth of Bottom Channel

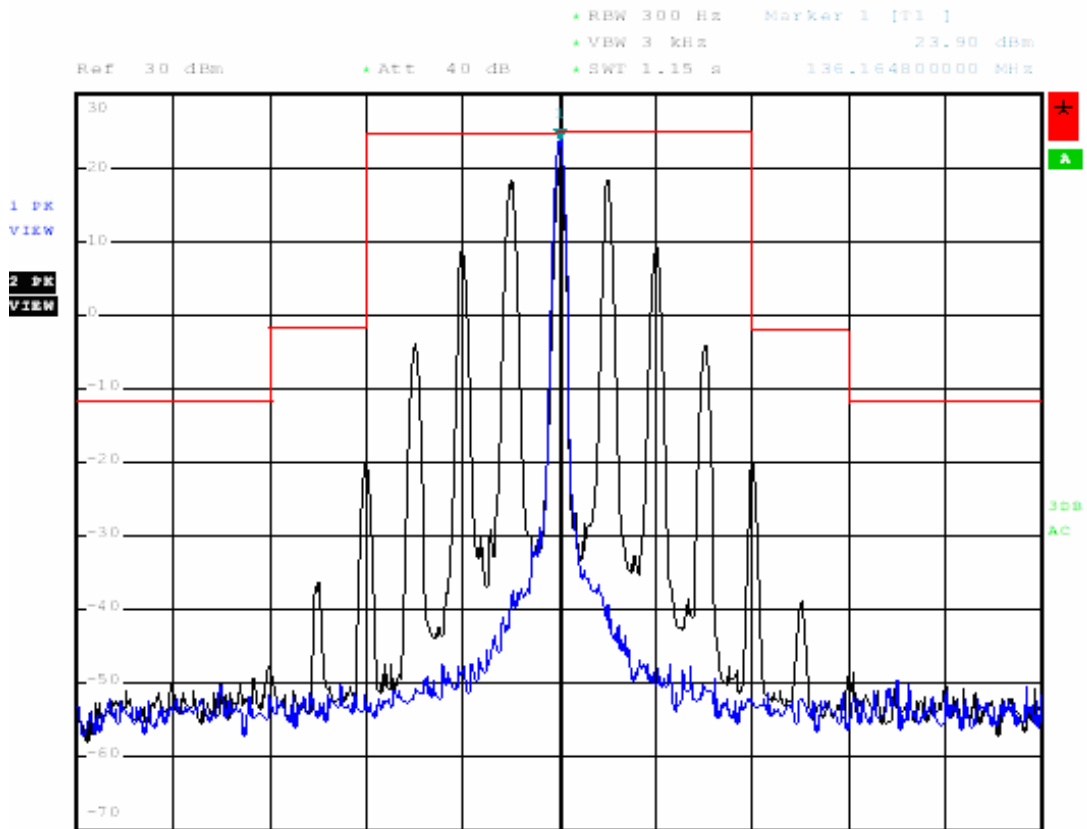

Date: 28.JUL.2009 21:00:54

25 kHz Channel Spacing, 136.16500MHz, 2500 Hz Audio Modulation Only

For 12.5 KHz

Occupied Bandwidth of Top Channel

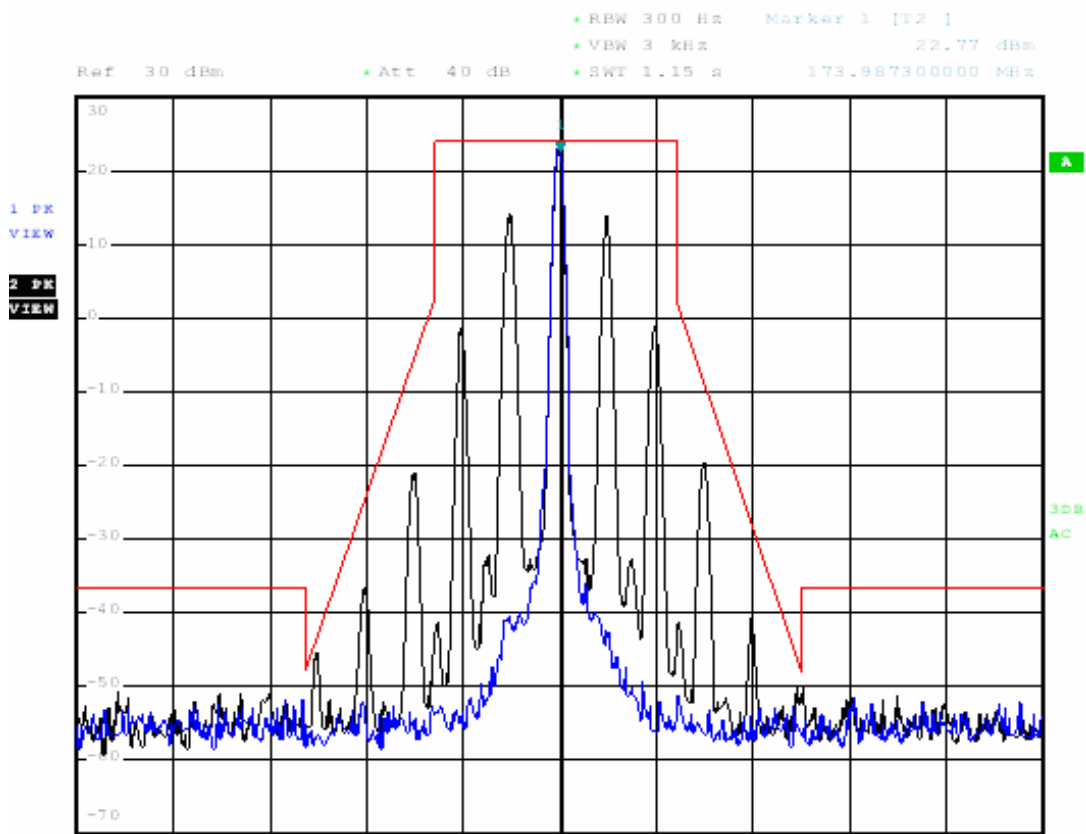

Date: 28.JUL.2009 21:09:40

12.5 kHz Channel Spacing, 173.98750MHz, 2500 Hz Audio Modulation Only

Occupied Bandwidth of Middle Channel

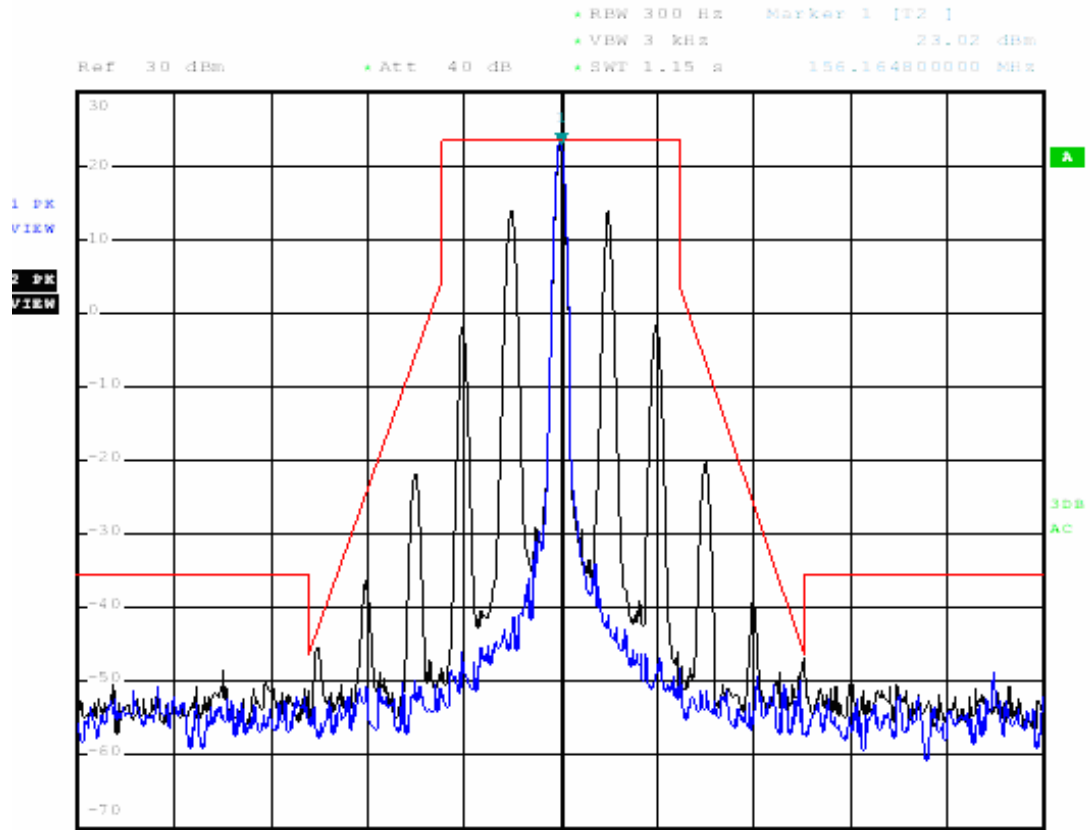

Date: 28.JUL.2009 21:07:10

12.5 kHz Channel Spacing, 156.16500MHz, 2500 Hz Audio Modulation Only

Occupied Bandwidth of Bottom Channel

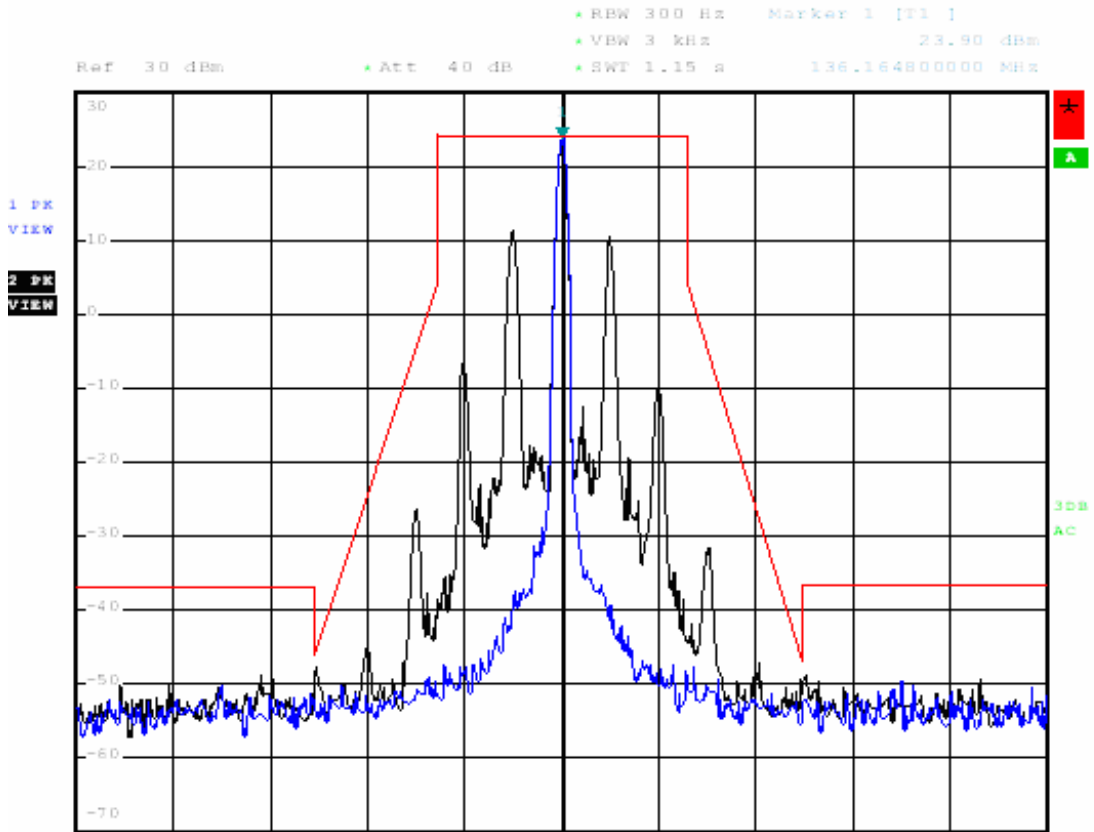

Date: 28.JUL.2009 20:59:04

12.5 kHz Channel Spacing, 136.16500 MHz, 2500 Hz Audio Modulation Only

6. RADIATED SPURIOUS EMISSION

6.1 PROVISIONS APPLICABLE

According to Section 90.210, the power of each unwanted emission shall be less than Transmitted Power as specified below for transmitters designed to operate with 12.5 KHz channel bandwidth:

- 1). On any frequency removed from the center of the authorized bandwidth f_0 to 5.625 KHz removed from f_0 : Zero dB
- 2). On any frequency removed from the center of the authorized bandwidth by a displacement frequency (f_d in KHz) f_0 of more than 5.625 KHz but no more than 12.5 KHz: At least 7.27dB
- 3). On any frequency removed from the center of the authorized bandwidth by a displacement frequency (f_d in KHz) f_0 of more than 12.5 KHz: At least $50+10 \log (P)$ dB or 70 dB, which ever is lesser attenuation.

For transmitters designed to transmit with 25 KHz channel separation and equipped with an audio low-pass filter, the power of any emission must be attenuated below the unmodulated carrier power (P) as following:

- 1). On any frequency removed from the assigned frequency by more than 50 percent, but no more than 100 percent of the authorized bandwidth: At least 25 dB.
- 2). On any frequency removed from the assigned frequency by more than 100 percent, but no more than 250 percent of the authorized bandwidth: At least 35 dB.
- 3). On any frequency removed from the assigned frequency by more than 250 percent of the authorized bandwidth: At least $43+10\text{Log} (P)$ dB.

6.2 MEASUREMENT PROCEDURE

- 1). On a test site, the EUT shall be placed on a turntable, and in the position closest to the normal use as declared by the user.
- 2). The test antenna shall be oriented initially for vertical polarization located 3m from the EUT to correspond to the transmitter.
- 3). The output of the antenna shall be connected to the measuring receiver and either a peak or quasi-peak detector was used for the measurement as in dicated on the report. The detector selection is based on how close the emission level was approaching the limit.
- 4). The transmitter shall be switched on; if possible, without the modulation and the measurement receiver shall be tuned to the frequency of the transmitter under test.
- 5). The test antenna shall be raised and lowered through the specified range of height until the measuring receiver detects a maximum signal level.
- 6). The transmitter shall than be rotated through 360° in the horizontal plane, until the

maximum signal level is detected by the measuring receiver.

7). The test antenna shall be raised and lowered again through the specified range of height until the measuring receiver detects a maximum signal level.

8). The maximum signal level detected by the measuring receiver shall be noted.

9). The measurement shall be repeated with the test antenna set to horizontal polarization.

10). Replace the antenna with a proper Antenna (substitution antenna).

11). The substitution antenna shall be oriented for vertical polarization and, if necessary, the length of the substitution antenna shall be adjusted to correspond to the frequency of transmitting.

12). The substitution antenna shall be connected to a calibrated signal generator.

13). If necessary, the input attenuator setting of the measuring receiver shall be adjusted in order to increase the sensitivity of the measuring receiver.

14). The test antenna shall be raised and lowered through the specified range of the height to ensure that the maximum signal is received.

15). The input signal to substitution antenna shall be adjusted to the level that produces a level detected by the measuring receiver, that is equal to the level noted while the transmitter radiated power was measured, corrected for the change of input attenuation setting of the measuring receiver.

16). The input level to the substitution antenna shall be recorded as power level in dBm, corrected for any change of input attenuator setting of the measuring receiver.

17). The measurement shall be repeated with the test antenna and the substitution antenna oriented for horizontal polarization

6.3 TEST SETUP BLOCK DIAGRAM

(Block diagram of configuration)

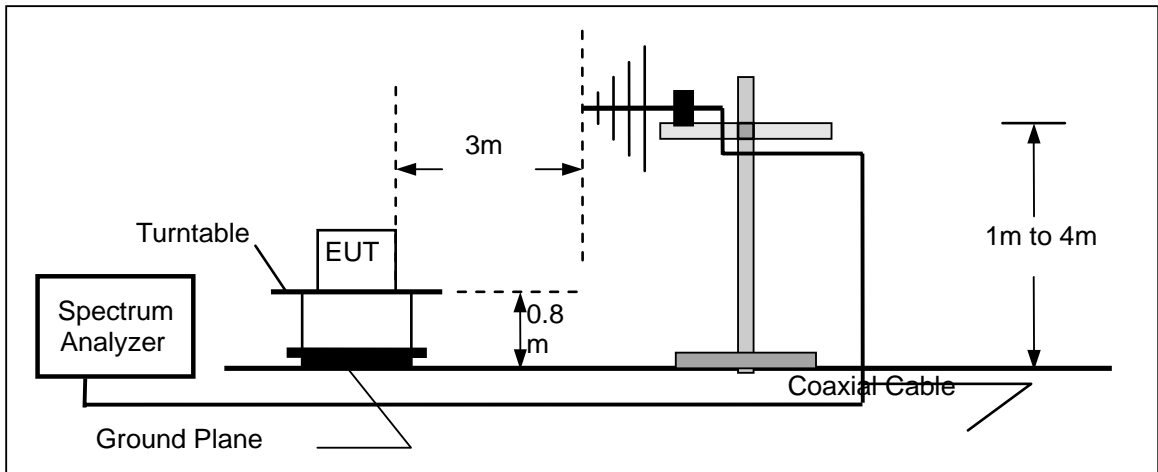

Radiation below 1GHz

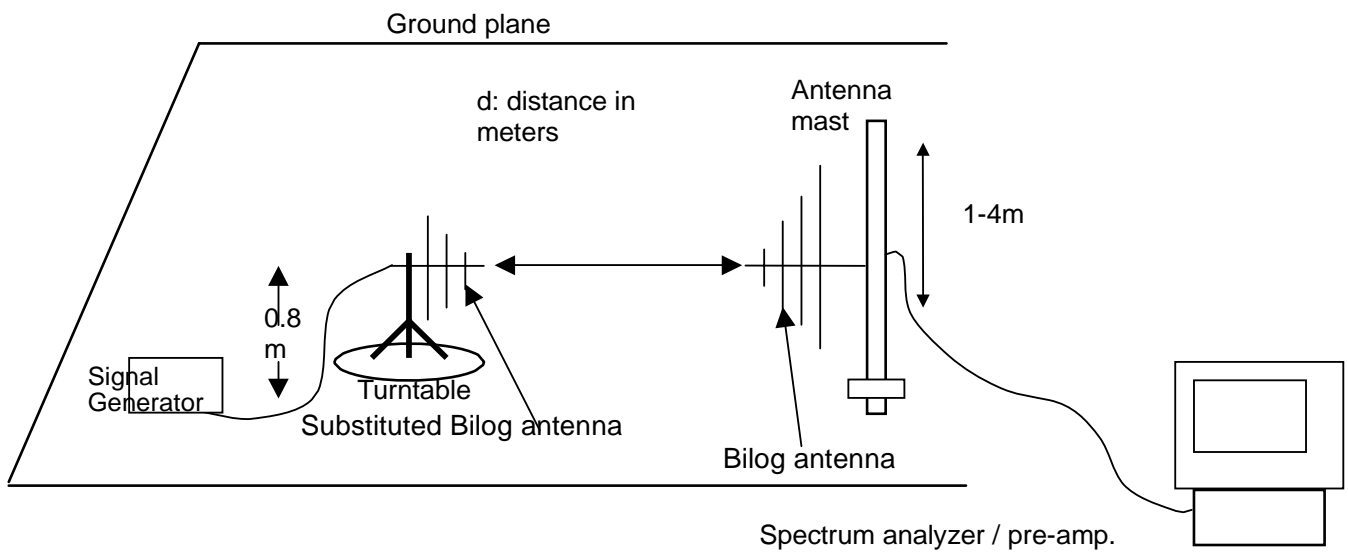

Radiation above 1GHz

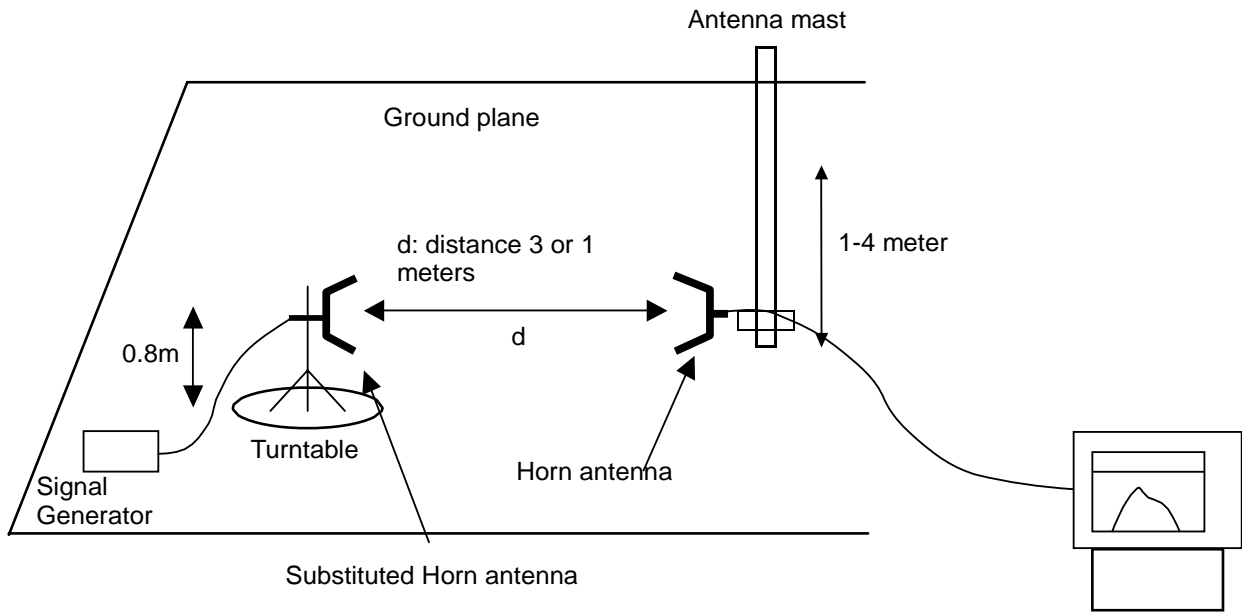

6.4 MEASUREMENT EQUIPMENT USED:

Radiated Emission Test Site # 4				
Name of Equipment	Manufacturer	Model	Serial Number	Calibration Due
ULTRA-BROADBAND ANTENNA	ROHDE & SCHWARZ	HL562	100015	11/2009
EMI TEST RECEIVER	ROHDE & SCHWARZ	ESI 26	100009	11/2009
RF TEST PANEL	ROHDE & SCHWARZ	TS / RSP	335015/ 0017	N/A
TURNTABLE	ETS	2088	2149	N/A
ANTENNA MAST	ETS	2075	2346	N/A
EMI TEST SOFTWARE	ROHDE & SCHWARZ	ES-K1 V1.71	N/A	11/2009

6.5 TEST RESULTS:

FCC Part 22.359, 74.462, 80.211 and 90.210 (25 kHz bandwidth only):

On any frequency removed from the center of the assigned channel by more than 250 percent at least:

Low: $43 + 10 \log (P_{\text{watts}}) = 43 + 10 \log (24.44) = 56.88 \text{ dB}$

High: $43 + 10 \log (P_{\text{watts}}) = 43 + 10 \log (25.35) = 57.04 \text{ dB}$

FCC Part 90.210 (12.5 kHz Bandwidth only):

On any frequency removed from the center of the authorized bandwidth by a displacement frequency (f d in kHz) of more than 12.5 kHz at least:

Low: $50 + 10 \log (P_{\text{watts}}) = 50 + 10 \log (24.44) = 63.88 \text{ dB}$

High: $50 + 10 \log (P_{\text{watts}}) = 50 + 10 \log (25.35) = 64.04 \text{ dB}$

Note: In general, the worse case attenuation requirement shown above was applied.

For 25 KHz

Calculation: Limit (dBm) = EL-43-10log10 (TP)

Notes: EL is the emission level of the Output Power expressed in dBm,
 In this application, the EL is 44.04 dBm.

Limit (dBm) = 44.04-43-10log10 (25.35) = -13 dBm

The Channel 4

Frequency (MHz)	Reading level (dBm)	Antenna Polarization	Transd (dB)	Emission level (dBm)	Limit (dBm)	Margin (dB)
272.33	-61.18	H	20.5	-40.68	-13	-27.68
816.99	-57.13	H	32.3	-24.83	-13	-11.83
953.16	-62.08	H	34.0	-28.08	-13	-15.08
***	--	H		--	-13	
272.33	-59.18	V	20.5	-38.68	-13	-25.68
816.99	-55.04	V	32.3	-22.74	-13	-9.74
953.16	-59.52	V	34.0	-25.52	-13	-12.52
***	--	V		--	-13	

The Channel 5

Frequency (MHz)	Reading level (dBm)	Antenna Polarization	Transd (dB)	Emission level (dBm)	Limit (dBm)	Margin (dB)
313.93	-62.77	H	24.0	-38.77	-13	-25.77
784.83	-55.72	H	31.8	-23.92	-13	-10.92
941.79	-59.49	H	33.9	-25.59	-13	-12.59
***	--	H		--	-13	
313.93	-58.44	V	24.0	-34.44	-13	-21.44
784.83	-55.84	V	31.8	-24.04	-13	-11.04
941.79	-57.57	V	33.9	-23.67	-13	-11.67
***	--	V		--	-13	

The Channel 6

Frequency (MHz)	Reading level (dBm)	Antenna Polarization	Transd (dB)	Emission level (dBm)	Limit (dBm)	Margin (dB)
347.93	-60.63	H	24.5	-36.13	-13	-23.13
695.95	-60.10	H	31.6	-28.50	-13	-15.50
869.83	-55.76	H	32.6	-23.16	-13	-10.16
***	--	H		--	-13	
347.93	-62.64	V	24.5	-37.74	-13	-24.74
695.95	-65.58	V	31.6	-33.98	-13	-20.98
869.83	-57.40	V	32.6	-24.80	-13	-11.80
***	--	V		--	-13	

***Note:**

*** means that the emission level is too low to be measured or at least 20 dB down than the limit.

For 12.5 KHz

Calculation: Limit (dBm) =EL-50-10log10 (TP)

Notes: EL is the emission level of the Output Power expressed in dBm,
 In this application, the EL is 44.04dBm.

Limit (dBm) =44.04-50-10log10 (25.35) = -20 dBm

The Channel 1

Frequency (MHz)	Reading level (dBm)	Antenna Polarization	Transd (dB)	Emission level (dBm)	Limit (dBm)	Margin (dB)
272.33	-58.51	H	20.5	-38.01	-20	-18.01
816.99	-55.77	H	32.3	-23.47	-20	-3.47
953.16	-61.31	H	34.0	-27.31	-20	-7.31
***	--	H		--	-20	
272.33	-61.84	V	20.5	-41.34	-20	-21.34
816.99	-55.83	V	32.3	-23.53	-20	-3.53
953.16	-62.04	V	34.0	-28.04	-20	-8.04
***	--	V		--	-20	

The Channel 2

Frequency (MHz)	Reading level (dBm)	Antenna Polarization	Transd (dB)	Emission level (dBm)	Limit (dBm)	Margin (dB)
312.33	-63.40	H	24.0	-39.40	-20	-19.40
780.83	-62.07	H	32.1	-29.97	-20	-9.97
936.99	-64.30	H	33.5	-30.80	-20	-10.80
***	--	H		--	-20	
312.33	-65.90	V	24.0	-41.90	-20	-21.90
780.83	-59.29	V	32.1	-27.19	-20	-7.19
936.99	-63.61	V	33.5	-30.11	-20	-10.11
***	--	V		--	-20	

The Channel 3

Frequency (MHz)	Reading level (dBm)	Antenna Polarization	Transd (dB)	Emission level (dBm)	Limit (dBm)	Margin (dB)
347.93	-63.02	H	24.5	-38.52	-20	-18.52
695.95	-62.96	H	31.6	-31.36	-20	-11.36
869.83	-56.21	H	32.6	-23.61	-20	-3.61
***	--	H		--	-20	
347.93	-65.08	V	24.5	-40.58	-20	-20.58
695.95	-60.70	V	31.6	-29.10	-20	-9.10
869.83	-57.74	V	32.6	-23.14	-20	-3.14
***	--	V		--	-20	

***Note:**

*** means that the emission level is too low to be measured or at least 20 dB down than the limit.

For Receiver Spurious radiation

The Radiated Measurement are performed to the three channels (the top channel, the middle channel and the bottom channel), the datum recorded below is the worst case for each channel separation.

The Top Channel is the worst case for 12.5 KHz Channel Separation

Frequency (MHz)	Reading level (dBm)	Antenna Polarization	Transd (dB)	Emission level (dBm)	Limit (dBm)	Margin (dB)
Below 1GHz	--	V				At least 20 dB down than the limit
Above 1GHz	--	V				
Below 1GHz	--	H				
Above 1GHz	--	H				

The Top Channel is the worst case for 25 KHz Channel Separation

Frequency (MHz)	Reading level (dBm)	Antenna Polarization	Transd (dB)	Emission level (dBm)	Limit (dBm)	Margin (dB)
Below 1GHz	--	V				At least 20 dB down than the limit
Above 1GHz	--	V				
Below 1GHz	--	H				
Above 1GHz	--	H				

Remark:

- (1) Corrected Power (dBm) = SG O/P-Cable + Ant Gain
- (2) Measuring frequencies from 30 MHz to the 5GHz.
- (3) Data of measurement within this frequency range shown "--" in the table above means the reading of emissions are attenuated more than 20dB below the permissible limits or the field strength is too small to be measured.

7. SPURIOUS EMISSION ON ANTENNA PORT

7.1 PROVISIONS APPLICABLE

The same as Section 6.1.

7.2 MEASUREMENT PROCEDURE

The RF output of the EUT was connected to a spectrum analyzer through appropriate attenuation. The resolution bandwidth of the spectrum analyzer was set to 100 kHz. Sufficient scans were taken to show any out of band emission up to 10th. Harmonic for the lower and the highest frequency range. RBW 100 kHz, VBW 300 kHz,
The audio input was set to 0 to get the unmodulated carrier, the resulting picture is print out for each channel separation.

7.3 TEST SETUP BLOCK DIAGRAM

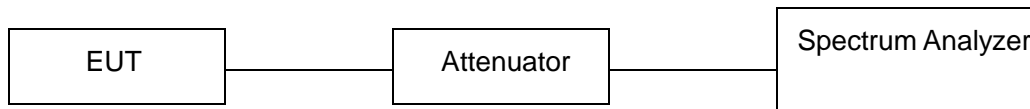

The EUT was directly connected to a RF Communication Test Set by a 20 dB attenuator

7.4 TEST RESULTS:

FCC Part 22.359, 74.462, 80.211, 90.210 and RSS Gen, RSS 119 Issue 8 section 5.8.1 (25 kHz bandwidth only):

On any frequency removed from the center of the assigned channel by more than 250 percent at least:

$$\text{Low: } 43 + 10 \log (\text{Pwatts}) = 43 + 10 \log (24.44) = 56.88 \text{ dB}$$

$$\text{High: } 43 + 10 \log (\text{Pwatts}) = 43 + 10 \log (25.35) = 57.04 \text{ dB}$$

$$\text{Calculation: Limit (dBm) = EL-43-10log10 (TP)}$$

Notes: EL is the emission level of the Output Power expressed in dBm, In this application, the EL is 44.04 dBm

$$\text{Limit (dBm) = 44.04-43-10log10 (25.35) = -13 dBm}$$

FCC Part 90.210 (12.5 kHz Bandwidth only):

On any frequency removed from the center of the authorized bandwidth by a displacement frequency (f d in kHz) of more than 12.5 kHz at least:

$$\text{Low: } 50 + 10 \log (\text{Pwatts}) = 50 + 10 \log (24.44) = 63.88 \text{ dB}$$

$$\text{High: } 50 + 10 \log (\text{Pwatts}) = 50 + 10 \log (25.35) = 64.04 \text{ dB}$$

$$\text{Calculation: Limit (dBm) = EL-50-10log10 (TP)}$$

Notes: EL is the emission level of the Output Power expressed in dBm, In this application, the EL is 44.04 dBm.

$$\text{Limit (dBm) = 44.04-50-10log10 (25.35) = -20 dBm}$$

Note: 1. In general, the worse case attenuation requirement shown above was applied.

2. The measurement frequency range from 30MHz to 2GHz.

For 25 KHz

Product : MOBILE RADIO

Test Mode : 173.98750MHz

Test Item : Spurious Emission on Antenna Port Temperature: 25 °C

Test Voltage: DC 13.6V (External Power Supply) Humidity : 56%RH

Test Result: **PASS**

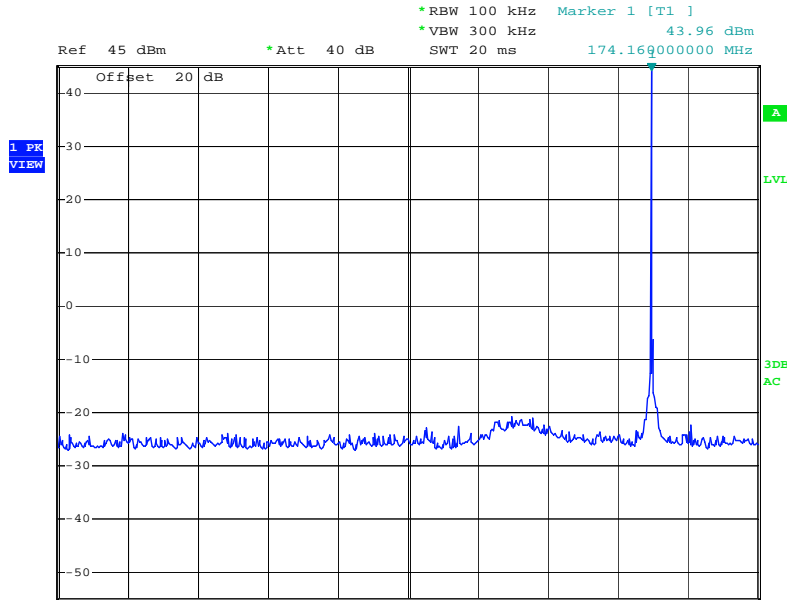

Date: 30.JUL.2009 21:12:51

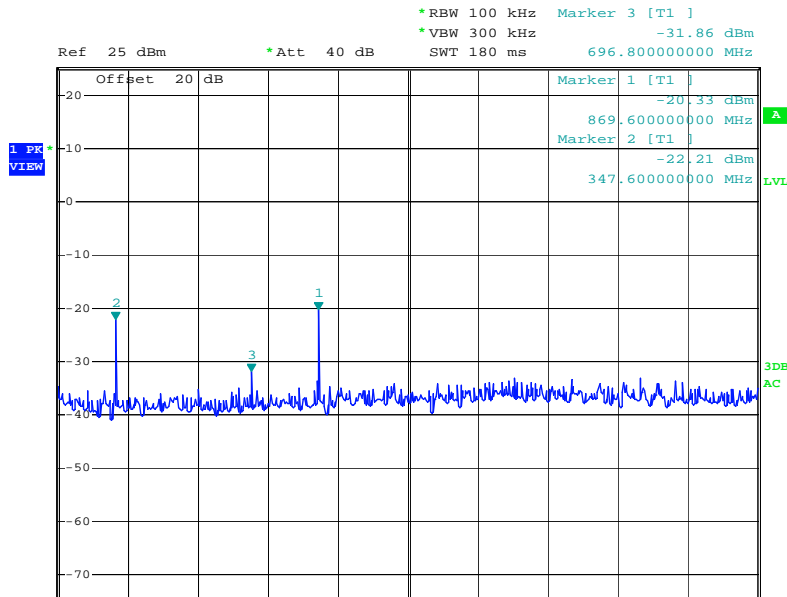

Date: 30.JUL.2009 21:14:14

Product :MOBILE RADIO Test Mode : 156.96500MHz
Test Item : Spurious Emission on Antenna PoTemperatur: 25 °C
Test Voltag: DC13.6V (External Power Supply)Humidity : 56%RH
Test Result: **PASS**

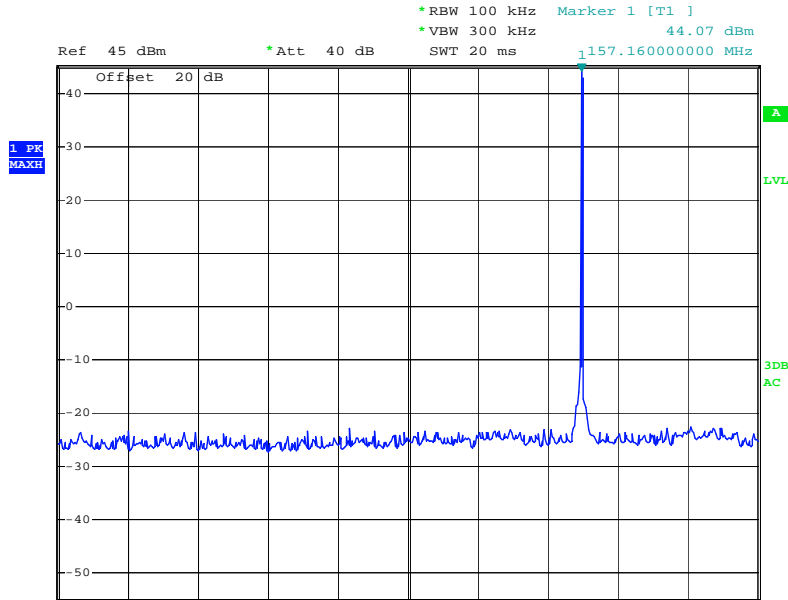

Date: 30.JUL.2009 21:10:14

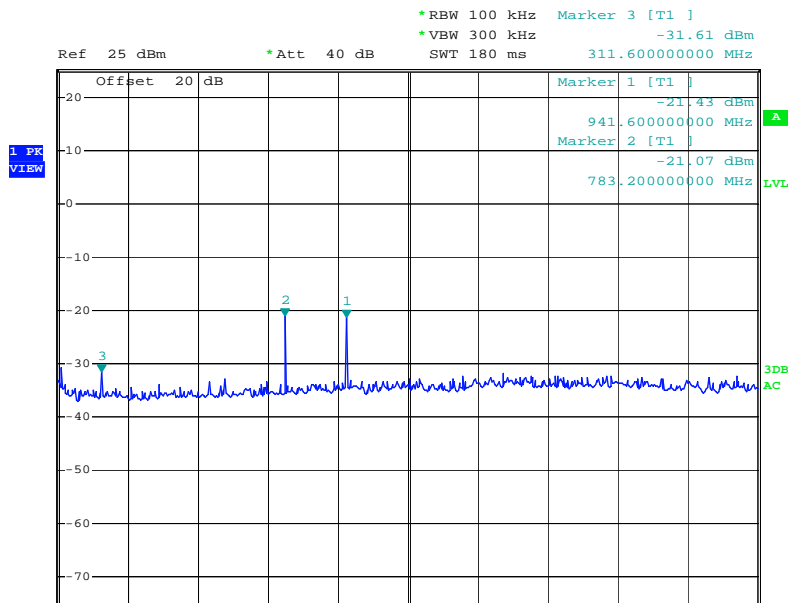

Date: 30.JUL.2009 21:12:06

Product : MOBILE RADIO Test Mode : 136.16500Hz
 Test Item : Spurious Emission on Antenna PoTemperatur: 25 °C
 Test Voltag: DC 13.6V (External Power SupplyHumidity : 56%RH
 Test Result: **PASS**

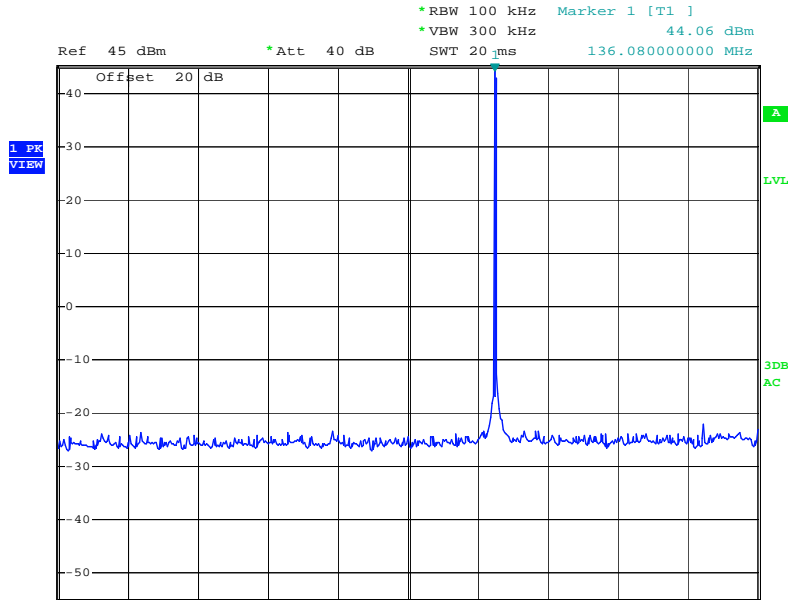

Date: 30.JUL.2009 21:08:08

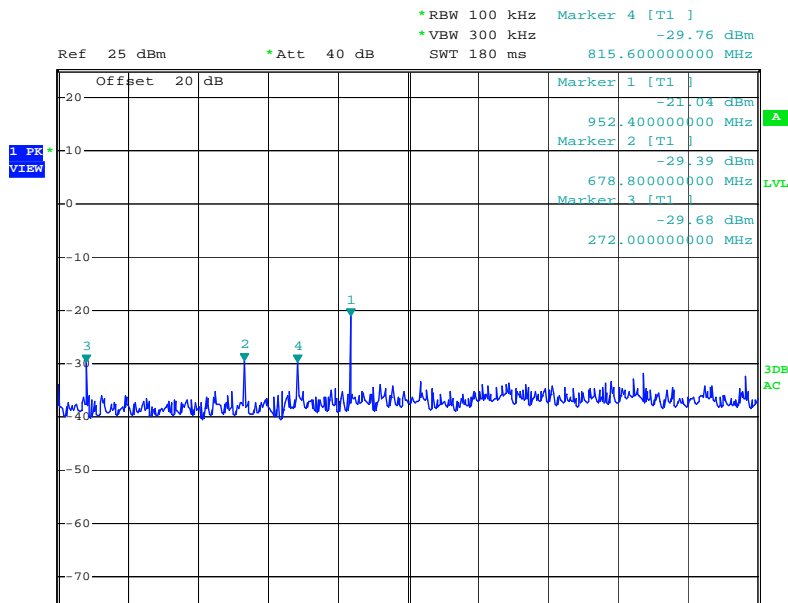

Date: 30.JUL.2009 21:09:12

For 12.5 KHz

Product : MOBILE RADIO Test Mode : 173.98750MHz
Test Item : Spurious Emission on Antenna PoTemperatur: 25 °C
Test Voltag: DC 13.6V (External Power SupplyHumidity : 56%RH
Test Result: **PASS**

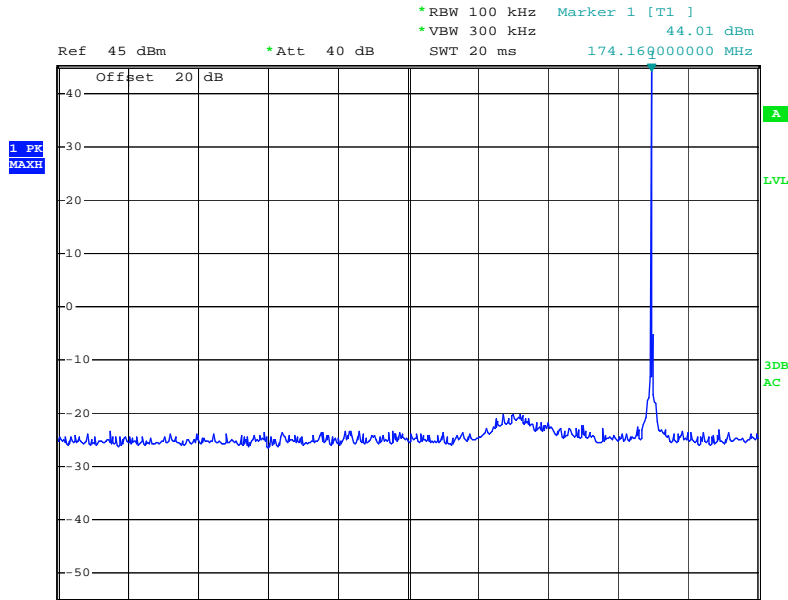

Date: 30.JUL.2009 21:05:49

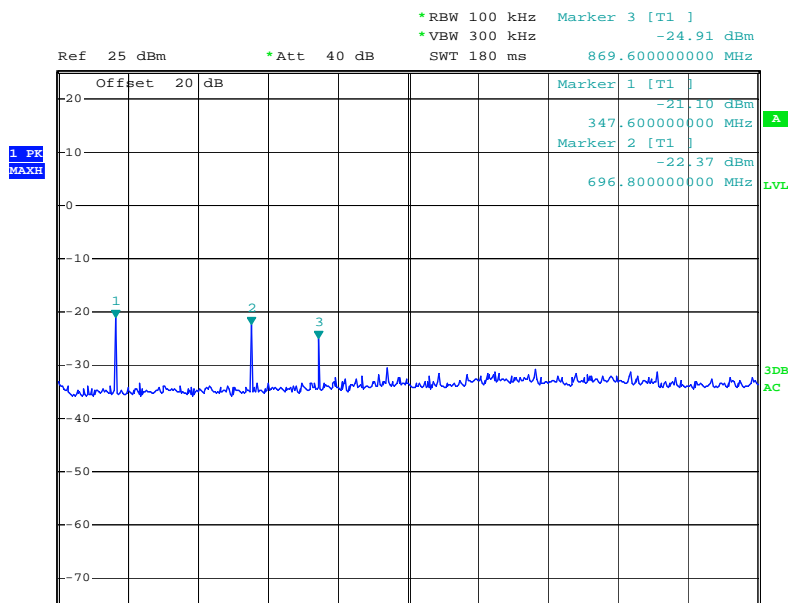

Date: 30.JUL.2009 21:07:23

Product : MOBILE RADIO Test Mode : 156.16500MHz
Test Item : Spurious Emission on Antenna PoTemperature: 25 °C
Test Voltage: DC 13.6V (External Power SupplyHumidity : 56%RH
Test Result: **PASS**

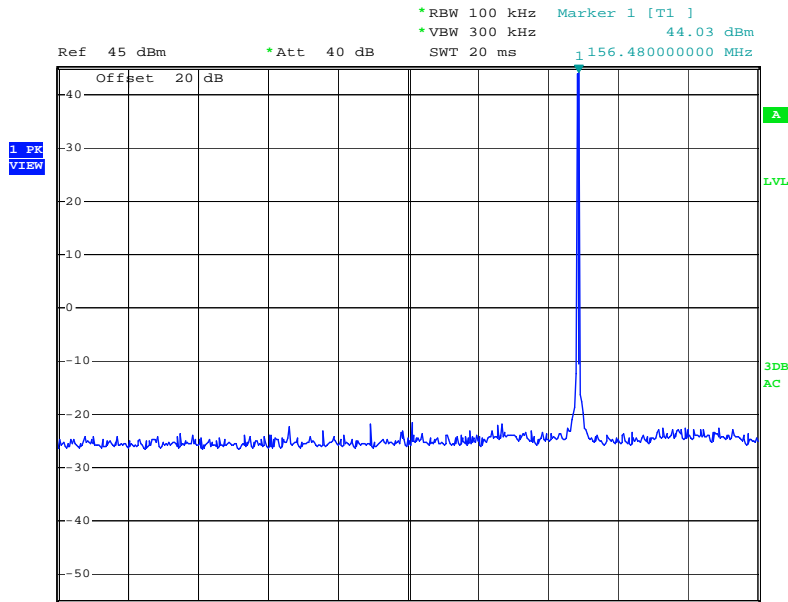

Date: 30.JUL.2009 21:03:19

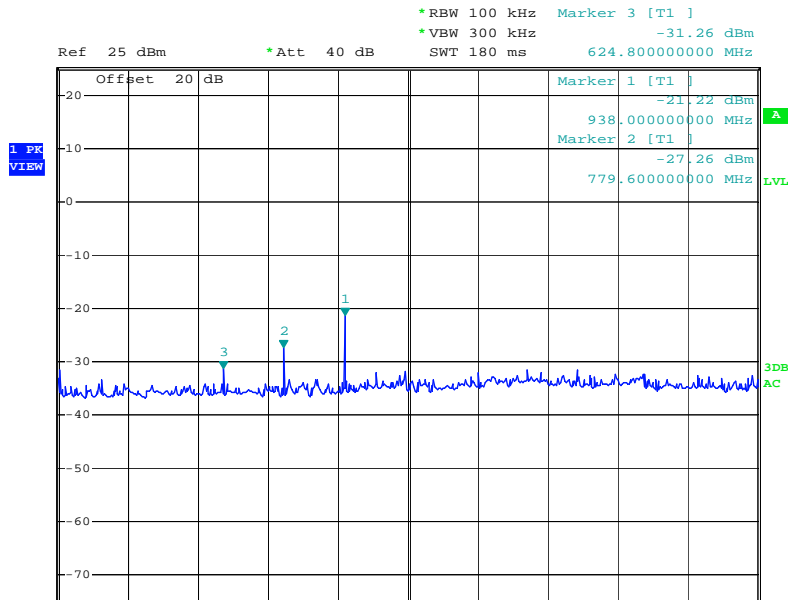

Date: 30.JUL.2009 21:05:03

Product : MOBILE RADIO Test Mode : 136.16500MHz
Test Item : Spurious Emission on Antenna PoTemperature: 25 °C
Test Voltage: DC 13.6V (External Power SupplyHumidity : 56%RH
Test Result: **PASS**

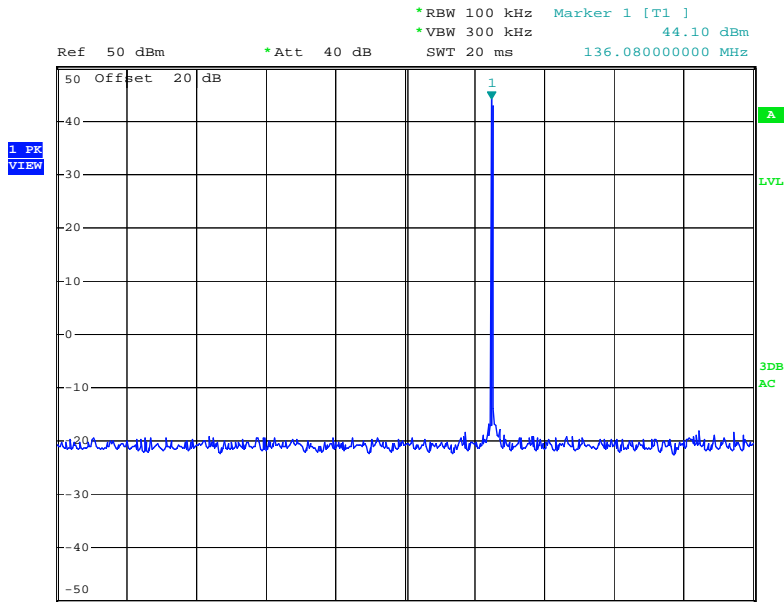

Date: 30.JUL.2009 18:49:41

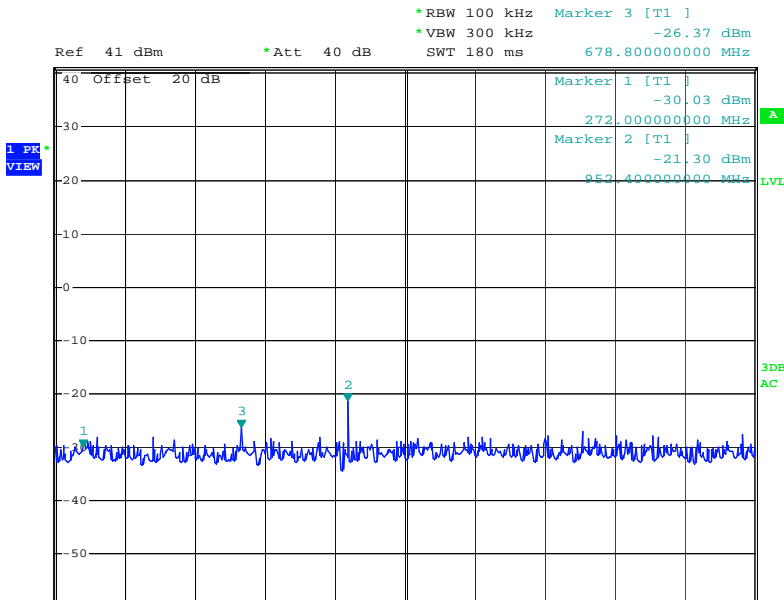

Date: 30.JUL.2009 21:02:13

8. MODULATION CHARACTERISTICS

8.1 PROVISIONS APPLICABLE

According to CFR47 section 2.1047(a), for Voice Modulation Communication Equipment, the frequency response of the audio modulation circuit over a range of 100 to 5000Hz shall be measured.

8.2 MEASUREMENT METHOD

8.2.1 Modulation Limit

- 1). Configure the EUT as shown in figure 1, adjust the audio input for 60% of rated system deviation at 1KHz using this level as a reference (0dB) and vary the input level from -20 to +20dB. Record the frequency deviation obtained as a function of the input level.
- 2). Repeat step 1 with input frequency changing to 300, 1004, and 2500Hz in sequence.

8.2.2 Audio Frequency Response

- 1). Configure the EUT as shown in figure 1.
- 2). Adjust the audio input for 20% of rated system deviation at 1 KHz using this level as a reference (0dB).
- 3). Vary the Audio frequency from 100 Hz to 10 KHz and record the frequency deviation.
- 4) Audio Frequency Response = $20\log_{10}$ (Deviation of test frequency/Deviation of 1 KHz reference).

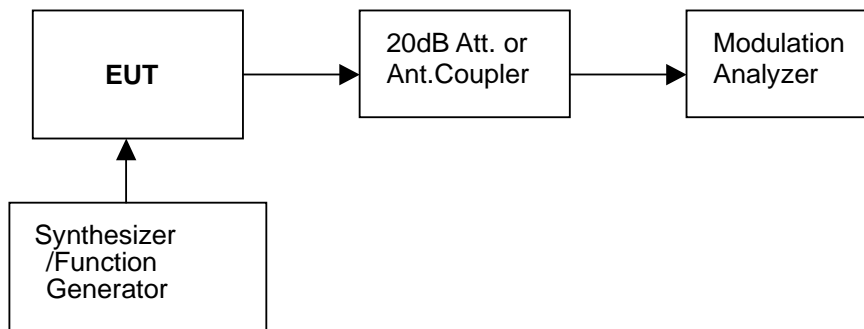

8.3 MEASUREMENT EQUIPMENT USED:

Name of Equipment	Manufacturer	Model	Serial Number	Calibration Due
Modulation Analyzer	HP	8901B	3104A03367	11/2009
Signal Generator	Rohde&Schwarz	SMT03	100059	11/2009

8.4 TEST RESULTS:

a). Modulation Limit:

25 KHz Channel Separation

Modulation Level (dB)	Peak Freq. Deviation At 300 Hz (KHz)	Peak Freq. Deviation At 1004 Hz (KHz)	Peak Freq. Deviation At 1500 Hz (KHz)	Peak Freq. Deviation At 2500 Hz (KHz)
-20	1.22	1.34	1.48	1.45
-15	1.35	1.48	1.62	1.78
-10	1.45	1.65	1.75	1.97
-5	1.57	1.89	2.66	2.90
0	1.80	3.08	3.88	3.78
+5	2.49	3.41	4.08	3.88
+10	2.86	3.96	4.10	3.99
+15	2.98	4.19	4.24	4.10
+20	3.14	4.32	4.45	4.15

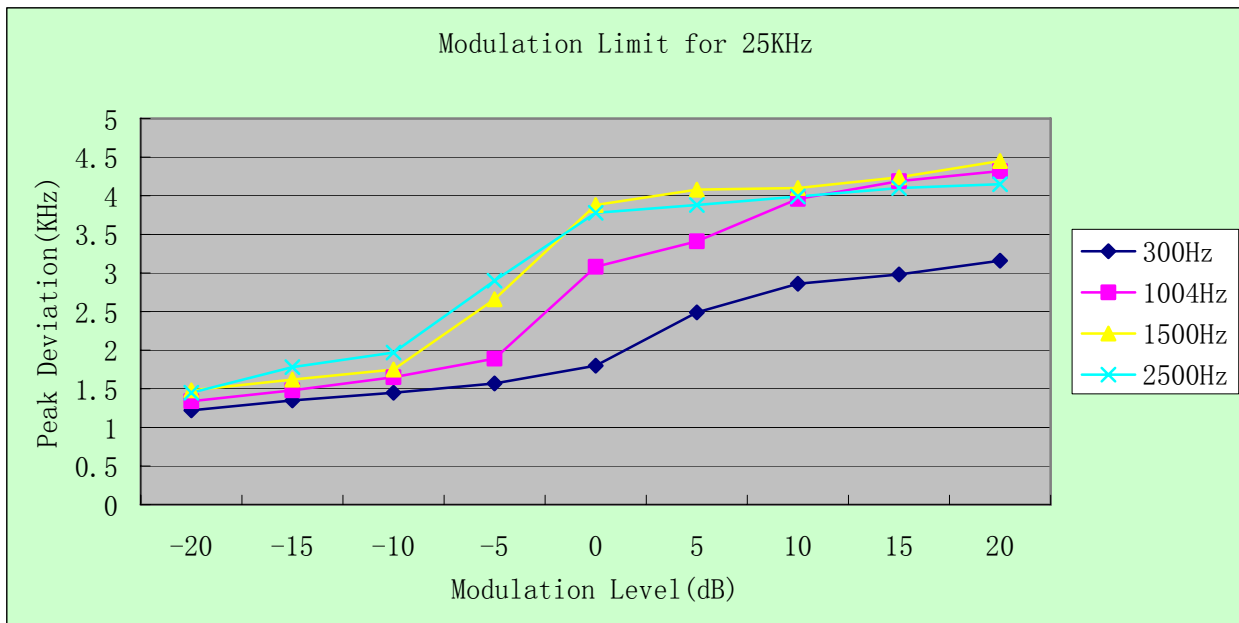

12.5 KHz Channel Separation

Modulation Level (dB)	Peak Freq. Deviation At 300 Hz	Peak Freq. Deviation At 1004 Hz	Peak Freq. Deviation At 1500 Hz	Peak Freq. Deviation At 2500 Hz
-20	0.83	0.90	0.97	1.01
-15	0.89	0.98	1.05	1.16
-10	1.06	1.13	1.21	1.37
-5	1.10	1.26	1.37	1.65
0	1.45	1.55	1.69	1.81
+5	1.57	1.64	1.78	1.90
+10	1.71	1.76	1.86	1.98
+15	1.78	1.87	1.97	2.05
+20	1.93	1.95	2.05	2.11

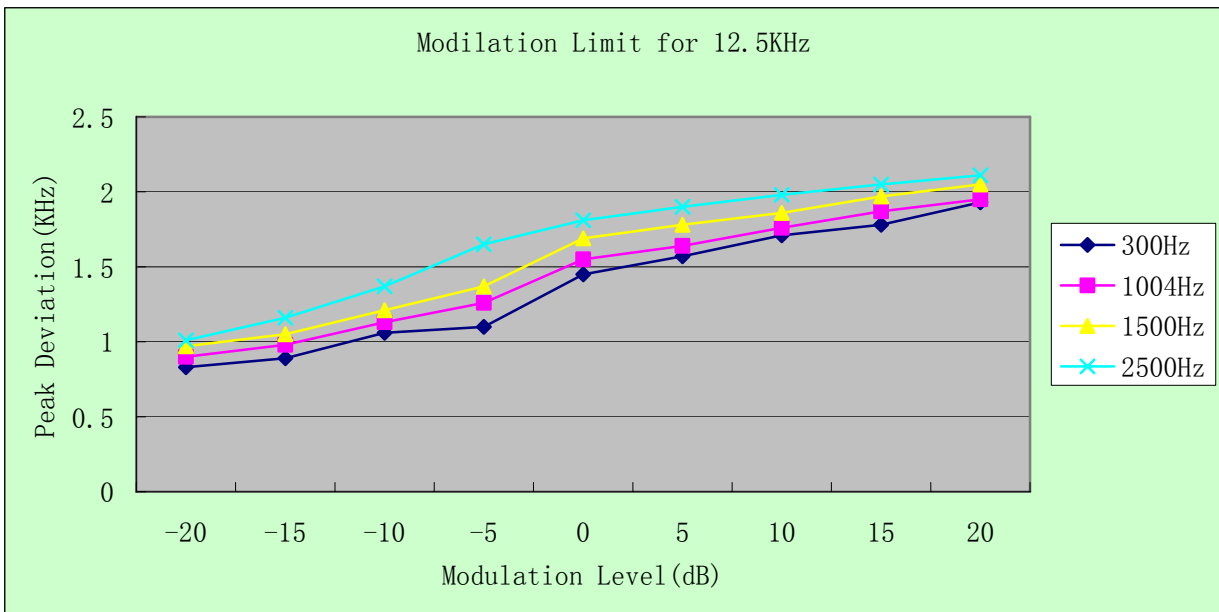

b). Audio Frequency Response:

Note: 1. Not applicable to new standard. However, tests are conducted under FCC's recommendation.

2. The Audio Frequency Response is identical for 12.5 KHz and 25 KHz channel separation

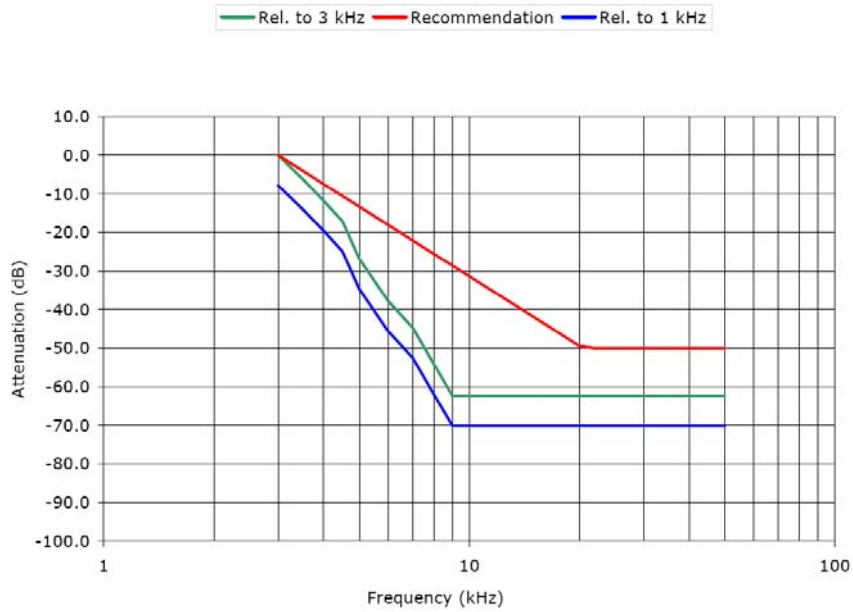

12.5KHz Channel Separation

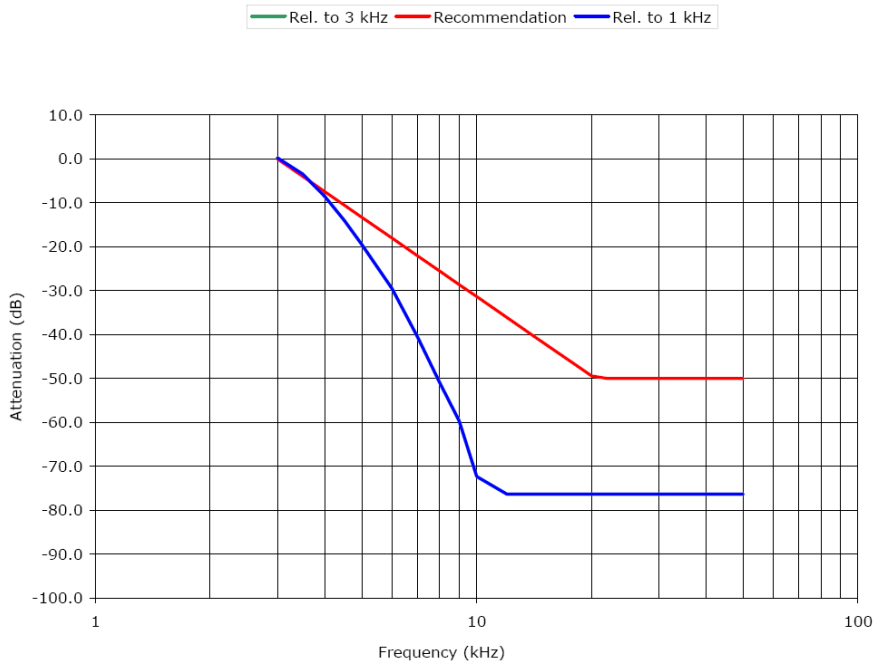

25 KHz Channel Separation

9. FREQUENCY STABILITY MEASUREMENT

9.1 PROVISIONS APPLICABLE

- a). According to FCC Part 2 Section 2.1055 (a)(1), the frequency stability shall be measured with variation of ambient temperature from -30°C to +60°C centigrade.
- b). According to FCC Part 2 Section 2.1055 (a)(2), for battery powered equipment, the frequency stability shall be measured with reducing primary supply voltage to the battery operating end point, which is specified by the manufacture.
- c). According to §90.213, the frequency stability limit is 2.5 ppm for 12.5KHz channel separation and 5 ppm for 25KHz channel separation.

9.2 MEASUREMENT PROCEDURE

The EUT was set in the climate chamber and connected to an external DC power supply. The RF output was directly connected to Spectrum Analyzer ESI 26. The coupling loss of the additional cables was recorded and taken in account for all the measurements. After temperature stabilization (approx. 20 min for each stage), the frequency for the lower, the middle and the highest frequency range was recorded. For Frequency stability Vs. Voltage the EUT was connected to an DC power supply and the voltage was adjusted in the required ranges. The result was recorded.

9.3 TEST SETUP BLOCK DIAGRAM

(Setup block diagram of configuration)

TEST SETUP:

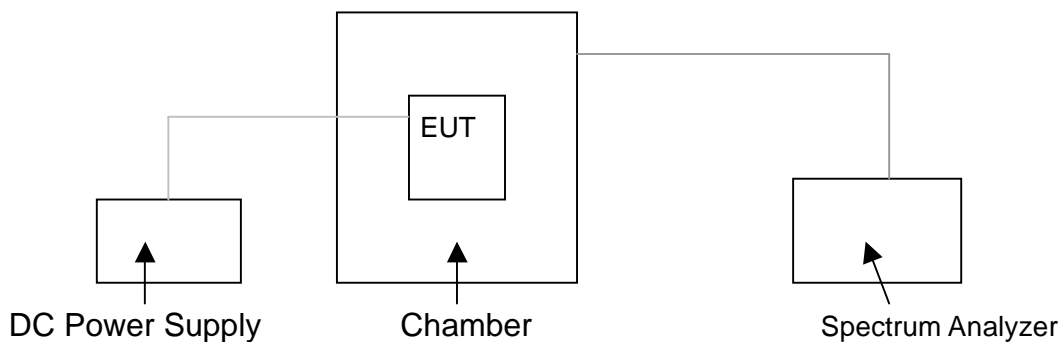

9.4 MEASUREMENT EQUIPMENT USED:

Name of Equipment	Manufacturer	Model	Serial Number	Calibration Due
Communication Test Set	HP	HP8920B	US35010135	11/2009
Signal Generator	Rohde&Schwarz	SMT03	100059	11/2009
Climate Chamber	ESPEC	EL-10KA	05107008	11/2009

9.5 TEST LIMITS:

According to 90.213, Transmitters used must have a minimum frequency stability as specified in the following table.

Frequency Range (MHz)	Channel Bandwidth (KHz)	Frequency Tolerance (ppm)		
		Fixed and Base Stations	Mobile Stations	
			> 2 W	≤ 2 W
150-174 MHz	6.25	1.0	2.0	2.0
	12.5	2.5	5.0	5.0
	25	5.0	5.0	50.0*
421-512 MHz	6.25	0.5	1.0	1.0
	12.5	1.5	2.5	2.5
	25	2.5	5.0	5.0

- Stations operating in the 154.45 to 154.49 MHz or the 173.2 to 173.4 MHz bands must have a frequency stability of 5 ppm.
- Paging transmitters operating on paging-only frequencies must operate with frequency stability of 5 ppm in the 150-174 MHz band and 2.5 ppm in the 421-512 MHz band.

9.6 TEST RESULTS:

a. Frequency stability versus input voltage (battery operation end point voltage is 11.24 V)

For 25 KHz:

Channel	Reference Frequency (MHz)	Frequency Measured at end point	Frequency Deviation (%)	Limit (%)
06	173.98750	173.98769	0.00011	0.0005
05	156.96500	156.96515	0.00010	0.0005
04	136.16500	136.16514	0.00010	0.0005

For 12.5 KHz:

Channel	Reference Frequency (MHz)	Frequency Measured at end point	Frequency Deviation (%)	Limit (%)
03	173.98750	173.98768	0.00010	0.00025
02	156.16500	156.16516	0.00010	0.00025
01	136.16500	136.16514	0.00010	0.00025

b. Frequency stability versus ambient temperature

For 25 KHz:

Channel 06

Reference Frequency: 173.98750MHz		Limit: 0.0005%	
Environment Temperature (°C)	Power Supply (DC)	Frequency deviation measured with time Elapse (10 minutes)	
		(MHz)	%
50	13.6 V	173.98774	0.00014
40	13.6 V	173.98768	0.00010
30	13.6 V	136.98745	-0.00004
20	13.6 V	136.98740	-0.00006
10	13.6 V	136.98757	0.00004
0	13.6 V	136.98763	0.00007
-10	13.6 V	173.98778	0.00016
-20	13.6 V	173.98790	0.00023
-30	13.6 V	173.98790	0.00023

Channel 05

Reference Frequency: 156.96500Hz		Limit: 0.0005%	
Environment Temperature (°C)	Power Supply (DC)	Frequency deviation measured with time Elapse (10 minutes)	
		(MHz)	%
50	13.6 V	156.96531	0.00020
40	13.6 V	156.96516	0.00010
30	13.6 V	156.96480	-0.00013
20	13.6 V	156.96480	-0.00013
10	13.6 V	156.96483	-0.00010
0	13.6 V	156.96514	0.00009
-10	13.6 V	156.96529	0.00018
-20	13.6 V	156.96537	0.00024
-30	13.6 V	156.96537	0.00024

Channel 04

Reference Frequency: 136.16500MHz		Limit: 0.0005%	
Environment Temperature (°C)	Power Supply (DC)	Frequency deviation measured with time Elapse (10 minutes)	
		(MHz)	%
50	13.6 V	136.16529	0.00021
40	13.6 V	136.16514	0.00010
30	13.6 V	136.16482	0.00013
20	13.6 V	136.16480	-0.00015
10	13.6 V	136.16484	-0.00012
0	13.6 V	136.16511	0.00009
-10	13.6 V	136.16527	0.00020
-20	13.6 V	136.16531	0.00023
-30	13.6 V	136.16531	0.00023

For 12.5 KHz:

Channel 03

Reference Frequency:173.98750MHz		Limit: 0.00025%	
Environment Temperature (°C)	Power Supply (DC)	Frequency deviation measured with time Elapse (10 minutes)	
		(MHz)	%
50	13.6 V	173.98774	0.00014
40	13.6 V	173.98768	0.00010
30	13.6 V	136.98745	-0.00004
20	13.6 V	136.98740	-0.00006
10	13.6 V	136.98757	0.00004
0	13.6 V	136.98763	0.00007
-10	13.6 V	173.98777	0.00015
-20	13.6 V	173.98788	0.00022
-30	13.6 V	173.98788	0.00022

Channel 02

Reference Frequency: 156.16500MHz		Limit: 0.00025%	
Environment Temperature (°C)	Power Supply (DC)	Frequency deviation measured with time Elapse (10 minutes)	
		(MHz)	%
50	13.6 V	156.16530	0.00019
40	13.6 V	156.16514	0.00009
30	13.6 V	156.16480	-0.00013
20	13.6 V	156.16480	-0.00013
10	13.6 V	156.16479	-0.00013
0	13.6 V	156.16513	0.00008
-10	13.6 V	156.16529	0.00018
-20	13.6 V	156.16535	0.00022
-30	13.6 V	156.16535	0.00022

Channel 01

Reference Frequency: 136.16500MHz		Limit: 0.00025%	
Environment Temperature (°C)	Power Supply (DC)	Frequency deviation measured with time Elapse (10 minutes)	
		(MHz)	%
50	13.6 V	136.16527	0.00020
40	13.6 V	136.16514	0.00010
30	13.6 V	136.16508	0.00006
20	13.6 V	136.16500	0.00000
10	13.6 V	136.16510	0.00007
0	13.6 V	136.16511	0.00009
-10	13.6 V	136.16527	0.00020
-20	13.6 V	136.16529	0.00021
-30	13.6 V	136.16529	0.00021

10 CONDUCTED OUTPUT POWER

10.1 PROVISIONS APPLICABLE

Per FCC <<2.1046 and <<90.205: Maximum ERP is dependent upon the station's antenna HAAT and required service area.

10.2 TEST PROCEDURE

Measurements shall be made to establish the radio frequency power delivered by the transmitter the standard output termination. The power output shall be monitored and recorded and no adjustment shall be made to the transmitter after the test has begun, except as noted bellow:

If the power output is adjustable, measurements shall be made for the highest and lowest power levels.

The EUT connect to the Receiver through 20 dB attenuator.

Measurement with Spectrum Analyzer ESI 26 conducted, external power supply with 13.6V stabilized supply voltage.

10.3 TEST SETUP BLOCK DIAGRAM

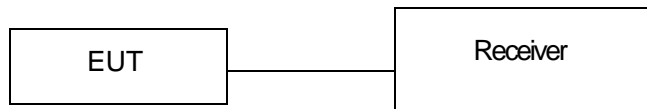

The EUT was directly connected to a RF Communication Test Set by a 20 dB attenuator

10.4 MEASUREMENT EQUIPMENT USED:

Open Area Test					
EQUIPMENT TYPE	MFR	MODEL NO.	SERIAL NO.	LAST CAL.	CAL DUE.
Receiver	ROHDE & SCHWARZ	ESI 26	100009	10/2007	11/2009
Attenuator	R&S	ESH3-22	10044	10/2007	11/2009

10.5 TEST RESULTS:

For 25 KHz

Freq.(MHz)	Measurement (dBm)	FCC Limit
173.98750	43.88	Varies

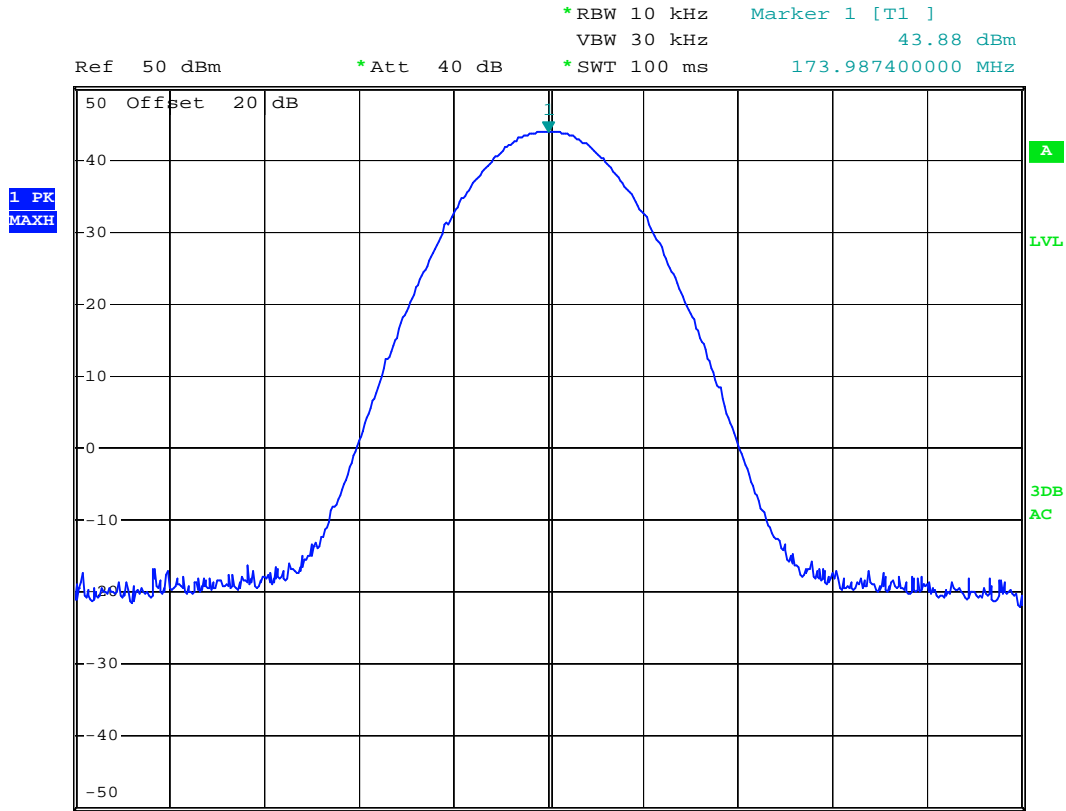

Date: 28.JUL.2009 18:43:00

Freq. (MHz)	Measurement (dBm)	FCC Limit
156.96500	44.04	Varies

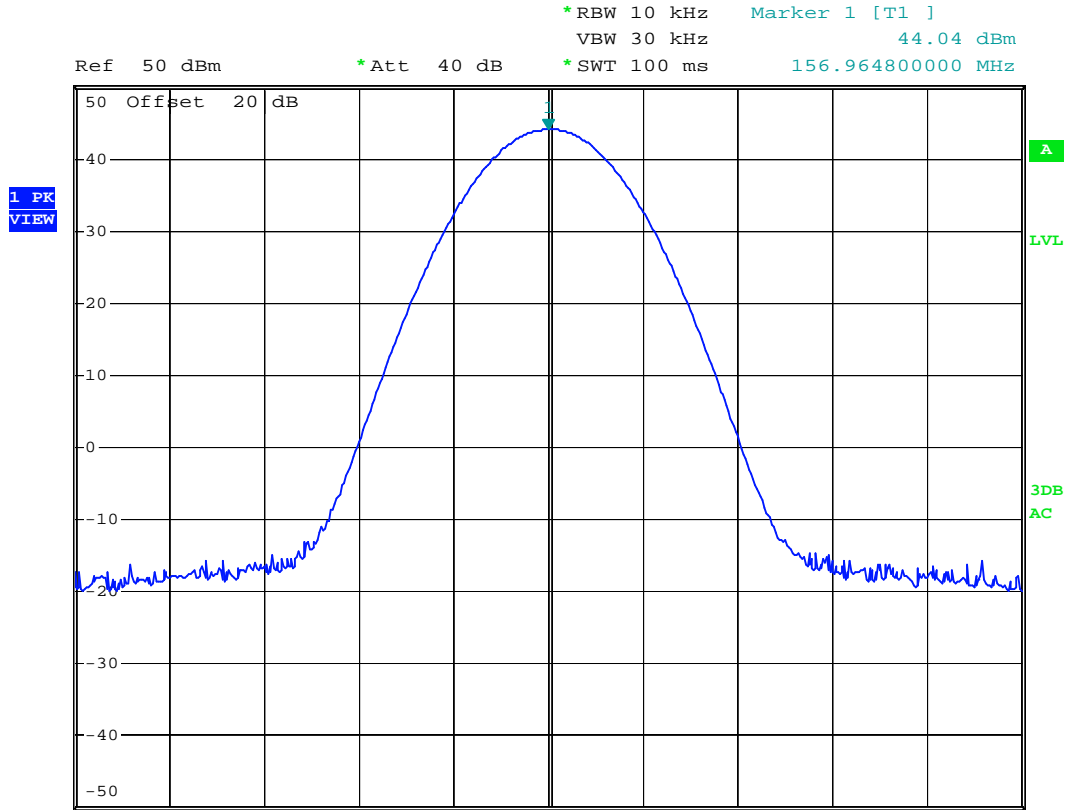

Date: 28.JUL.2009 18:42:30

Freq. (MHz)	Measurement (dBm)	FCC Limit
136.16500	44.03	Varies

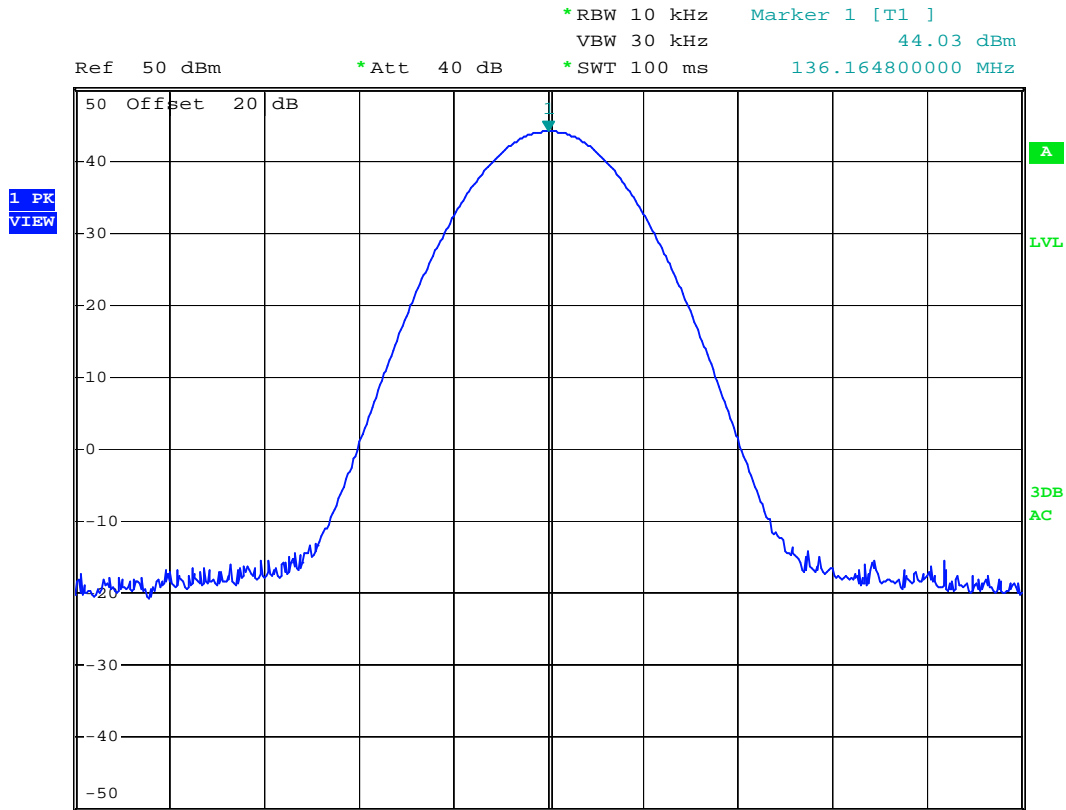

Date: 28.JUL.2009 18:41:36

For 12.5 KHz

Freq. (MHz)	Measurement (dBm)	FCC Limit
173.98750	43.88	Varies

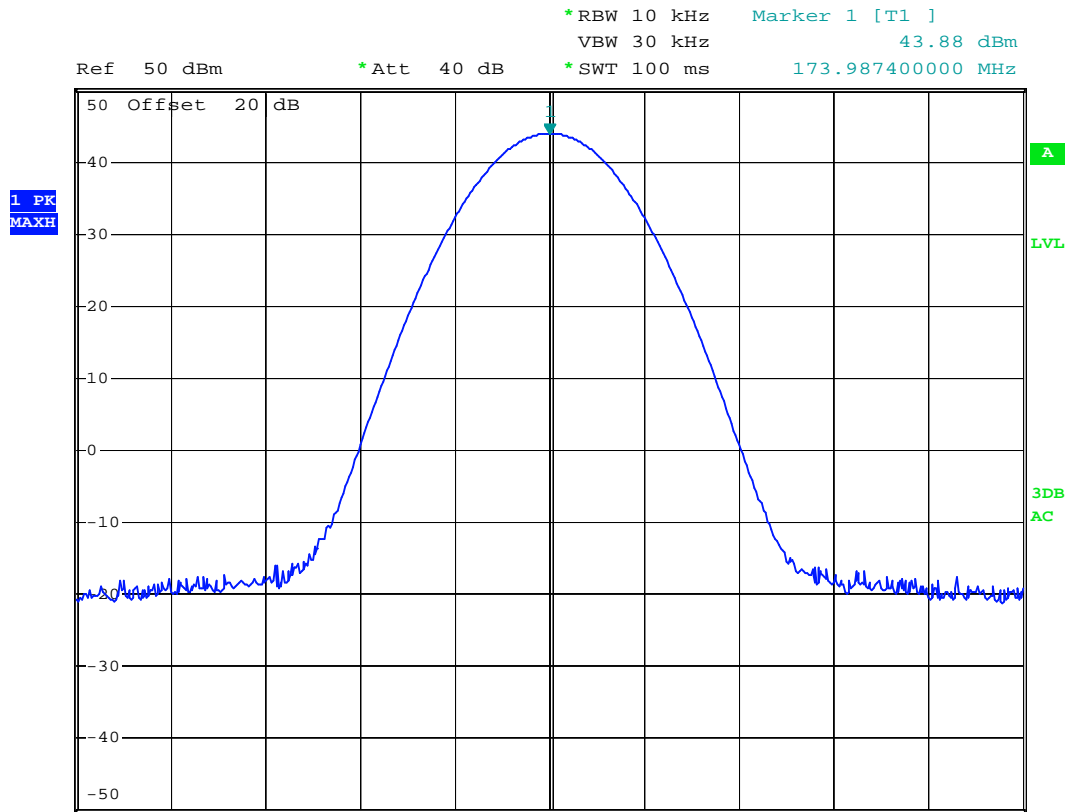

Date: 28.JUL.2009 18:40:41

Freq. (MHz)	Measurement (dBm)	FCC Limit
156.16500	44.01	Varies

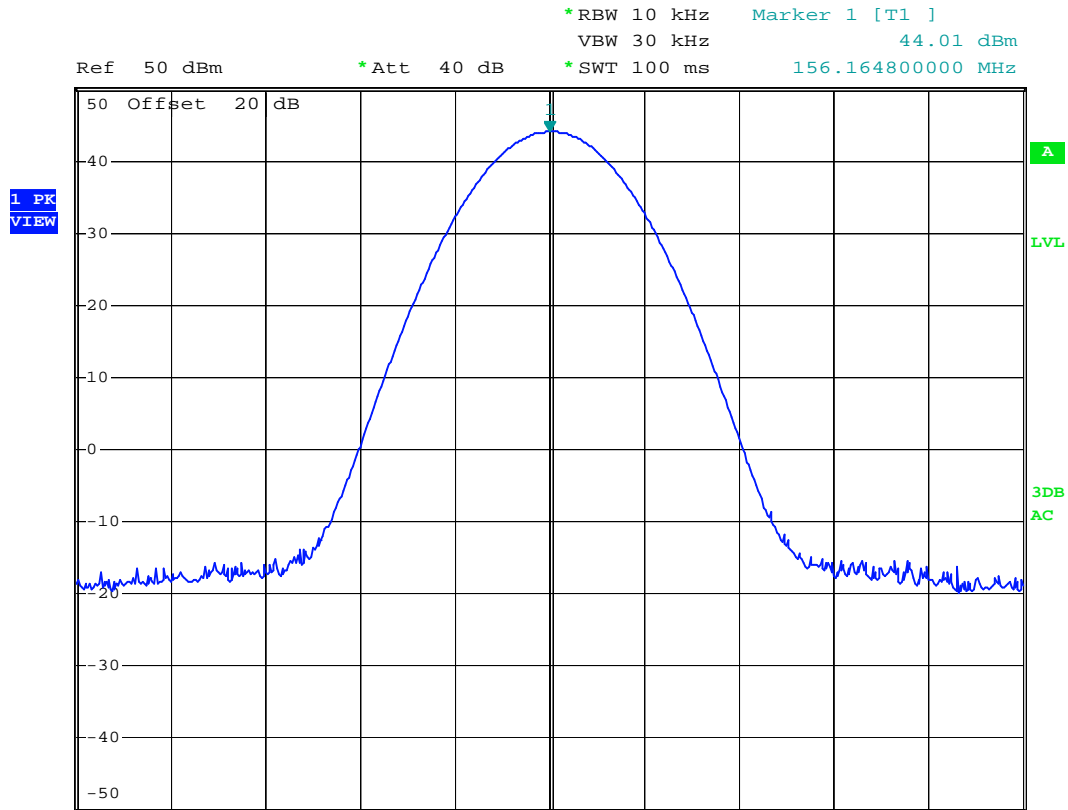

Date: 28.JUL.2009 18:39:53

Freq. (MHz)	Measurement (dBm)	FCC Limit
136.16500	44.04	Varies

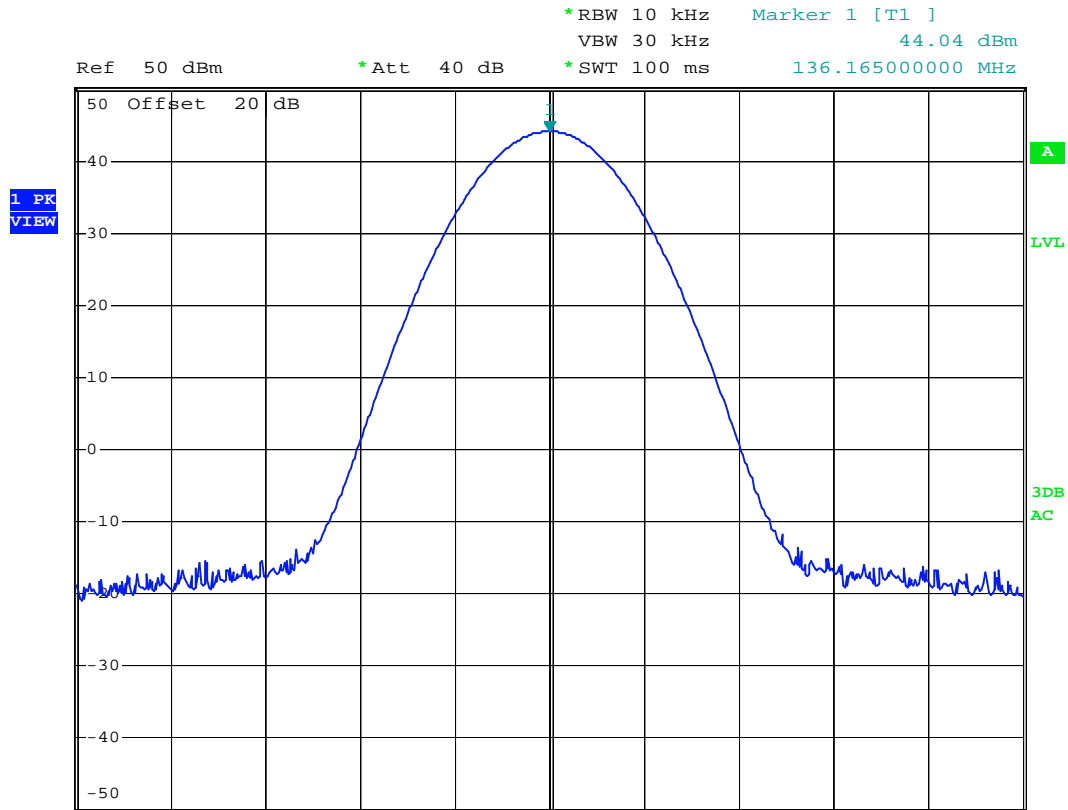

Date: 28.JUL.2009 18:38:51

11. TRANSMITTER FREQUENCY BEHAVIOR

11.1 PROVISIONS APPLICABLE

Section 90.214

The transient periods are given in following table:

Time intervals ^{1, 2}	Maximum frequency difference ³	All equipment	
		150 to 174 MHz	421 to 512MHz
Transient Frequency Behavior for Equipment Designed to Operate on 25 KHz Channels			
t ₁ ⁴	± 25.0 KHz	5.0 ms	10.0 ms
t ₂ ⁴	± 12.5 KHz	20.0 ms	25.0 ms
t ₃ ⁴	± 25.0 KHz	5.0 ms	10.0 ms
Transient Frequency Behavior for Equipment Designed to Operate on 12.5 KHz Channels			
t ₁ ⁴	± 12.5 KHz	5.0 ms	10.0 ms
t ₂ ⁴	± 6.25 KHz	20.0 ms	25.0 ms
t ₃ ⁴	± 12.5 KHz	5.0 ms	10.0 ms
Transient Frequency Behavior for Equipment Designed to Operate on 6.25 KHz Channels			
t ₁ ⁴	±6.25 KHz	5.0 ms	10.0 ms
t ₂ ⁴	±3.125 KHz	20.0 ms	25.0 ms
t ₃ ⁴	±6.25 KHz	5.0 ms	10.0 ms

- t_{on} is the instant when a 1 KHz test signal is completely suppressed, including any capture time due to phasing.
 t₁ is the time period immediately following t_{on}.
 t₂ is the time period immediately following t₁.
 t₃ is the time period from the instant when the transmitter is turned off until t_{off}.
 t_{off} is the instant when the 1 KHz test signal starts to rise.
- During the time from the end of t₂ to the beginning of t₃, the frequency difference must not exceed the limits specified in § 90.213.
- Difference between the actual transmitter frequency and the assigned transmitter frequency.
- If the transmitter carrier output power rating is 6 watts or less, the frequency difference during this time period may exceed the maximum frequency difference for this time period.

11.2 TEST METHOD

TIA/EIA-603 2.2.19

11.3 TEST SETUP BLOCK DIAGRAM

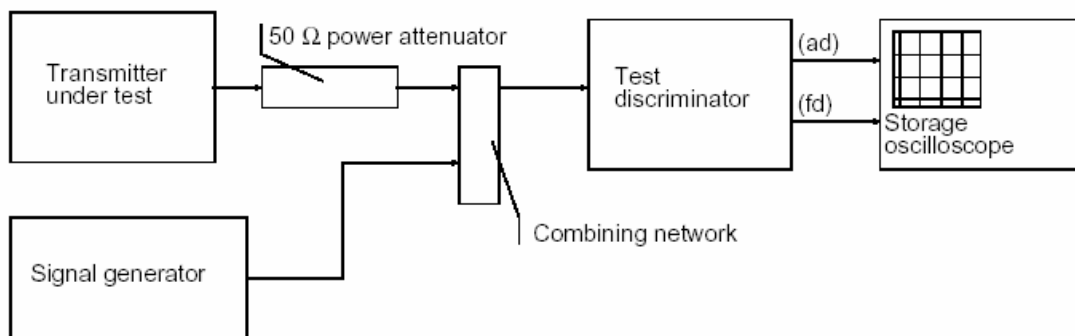

11.4 MEASUREMENT EQUIPMENT USED:

Name of Equipment	Manufacturer	Model	Serial Number	Calibration Due
Signal Generator	Rohde&Schwarz	SMT03	100059	11/2009
Storage Oscilloscope	Tektronix	TDS3052	B017447	11/2009

11.5 TEST RESULTS:

Please refer to the following plots.

Transmitter Frequency Behaviour @ 12.5 KHz Channel Separation-----Off – On

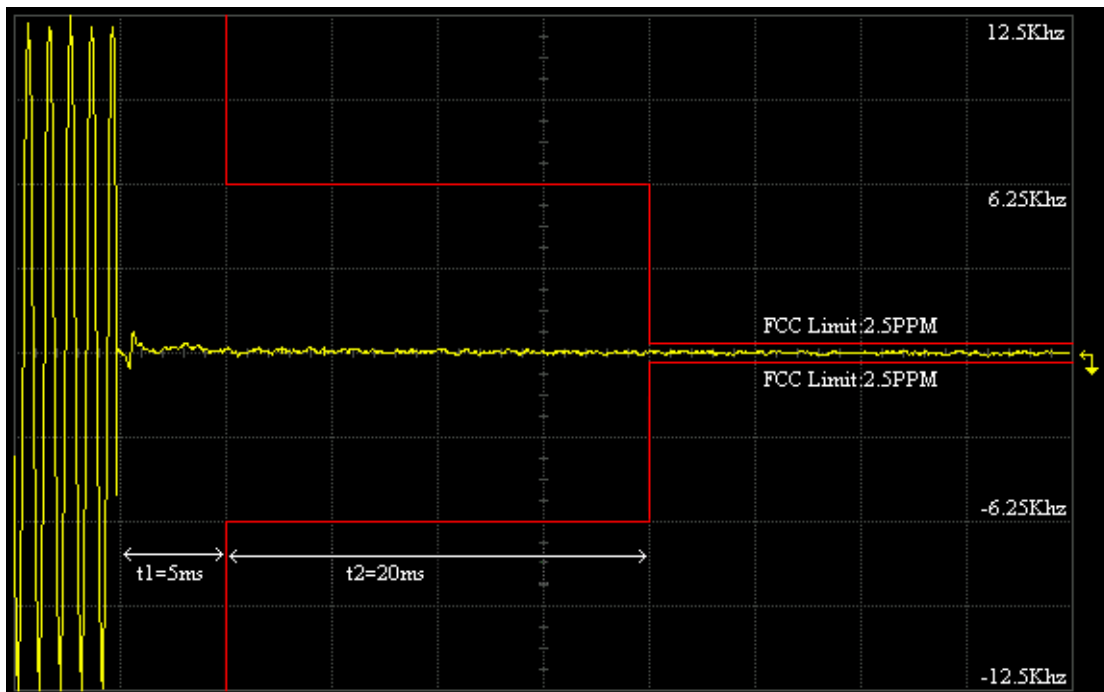

Transmitter Frequency Behaviour @ 12.5 KHz Channel Separation-----On - Off

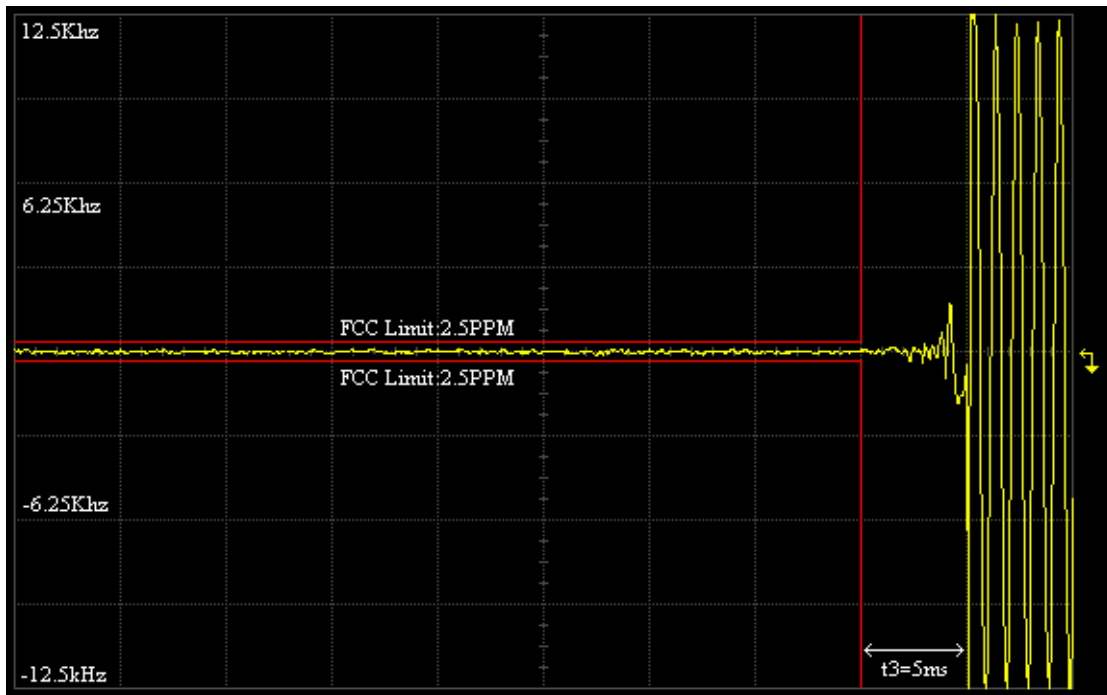

Transmitter Frequency Behaviour @ 25 KHz Channel Separation-----Off – On

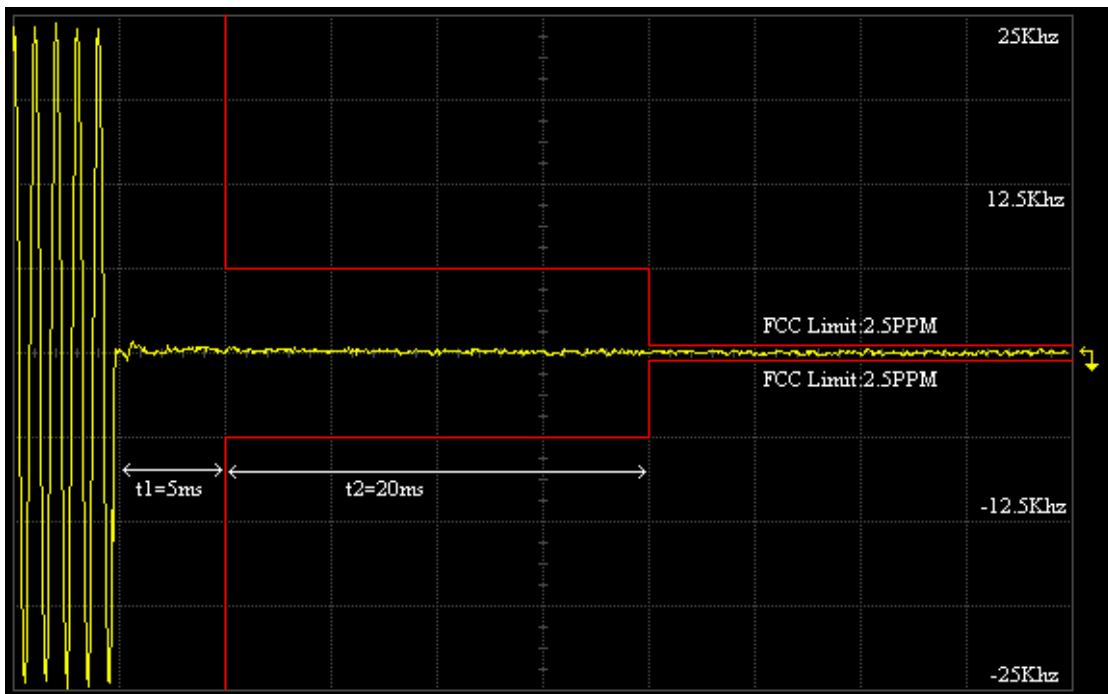

Transmitter Frequency Behaviour @ 12.5 KHz Channel Separation-----On – Off

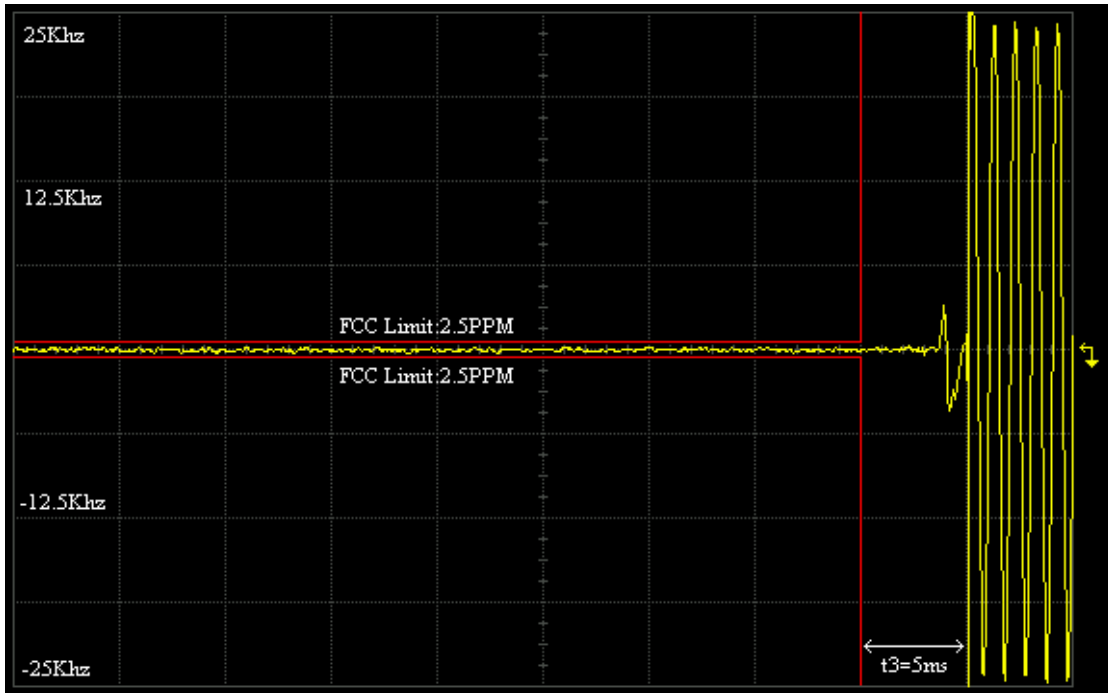

APPENDIX 1

PHOTOGRAPHS OF TEST SETUP

Test Setup Photo-1



Test Setup Photo-2



APPENDIX 2

PHOTOGRAPHS OF EUT

External Photos of EUT

Top view of EUT



Bottom view of EUT



Right view of EUT



Left view of EUT



Front view of EUT



Back view of EUT



Internal photos of the EUT





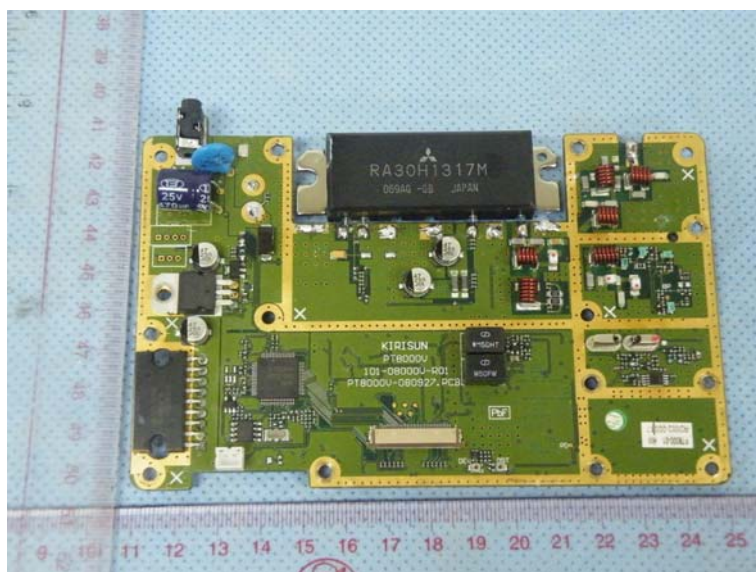
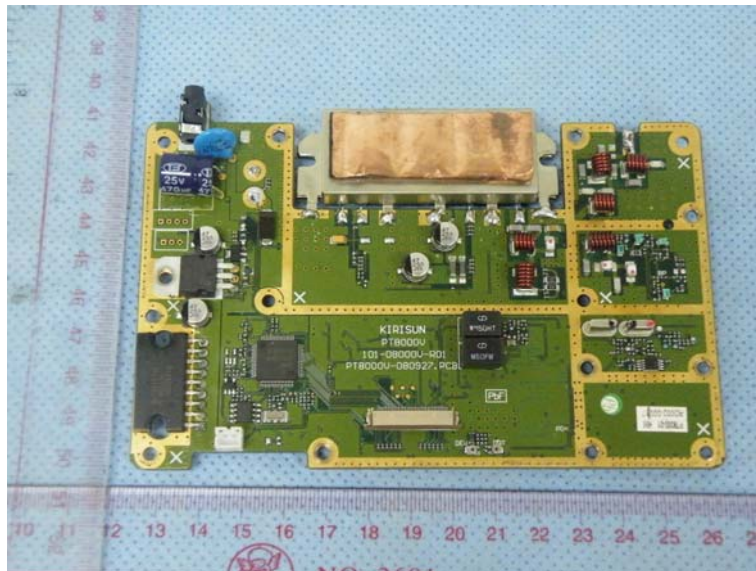



.....End of Report.....