

TEST REPORT

For

Two-way Radio

Model Number: PT7200-02

FCC ID: Q5EPT720002

Report Number : WT078001367

Test Laboratory : Shenzhen Academy of Metrology and
Quality Inspection EMC Laboratory
Guangdong EMC Compliance Test Center
Site Location : Bldg. of Metrology &Quality Inspection,
Longzhu Road, Shenzhen, Guangdong,
China
Tel : 0086-755-26941637, 26941529, 26941531
Fax : 0086-755-26941545
Email : emclab@sohu.com

TABLE OF CONTENTS

TEST REPORT DECLARATION	3
1. TEST RESULTS SUMMARY	4
2. GENERAL INFORMATION	5
2.1. Report information	5
2.2. Measurement Uncertainty	5
3. PRODUCT DESCRIPTION	6
3.1. EUT Description	6
3.2. Related Submittal(s) / Grant (s)	6
3.3. Block Diagram of EUT Configuration.....	7
3.4. Operating Condition of EUT	7
3.5. Special Accessories.....	7
3.6. Equipment Modifications.....	7
3.7. Support Equipment List	7
3.8. Test Conditions	7
4. TEST EQUIPMENT USED	8
5. RF OUTPUT POWER	9
5.1. PROVISIONS APPLICABLE	9
5.2. MEASUREMENT PROCEDURE	9
5.3. TEST SETUP BLOCK DAIGRAM(setup block diagram of configuration)	9
5.4. Test result:.....	9
6. TYPE OF EMISSION	10
6.1. MODULATION CHARACTERISTICS MEASUREMENT METHOD.....	10
6.2. MEASUREMENT RESULT	10
6.3. Emissions designator calculation:.....	16
7. EMISSION MASKS	18
7.1. PROVISIONS APPLICABLE	18
7.2. RADIATED EMISSION	18
7.3. CONDUCTED EMISSION	21
7.4. MEASUREMENT RESULTS:.....	22
8. FREQUENCY STABILITY	30
8.1. PROVISIONS APPLICABLE	30
8.2. MEASUREMENT PROCEDURE	30
8.3. TEST SETUP BLOCK DIAGRAM(block diagram of configuration).....	31
8.4. TEST RESULT	31
9. TRANSMITTER FREQUENCY BEHAVIOR	33
9.1. PROVISIONS APPLICABLE	33
9.2. MEASUREMENT PROCEDURE	34
9.3. TEST SETUP BLOCK DIAGRAM (Block Diagram of Configuration)	34
9.4. MEASUREMENT RESULT:.....	34
10. RF EXPOSURE	37
APPENDIX I TEST PHOTO	38
APPENDIX II EUT PHOTO	41

TEST REPORT DECLARATION

Applicant : KIRISUN ELECTRONICS (SHENZHEN) CO., LTD
 Address : 6/F., Bldg. H-2, East Industrial Zone of Overseas Chinese Town,
 Nanshan Dist., Shenzhen P.R. China
 Manufacturer : KIRISUN ELECTRONICS (SHENZHEN) CO., LTD
 Address : 6/F., Bldg. H-2, East Industrial Zone of Overseas Chinese Town,
 Nanshan Dist., Shenzhen P.R. China
 EUT Description : Two-way Radio
 Model Number PT7200-02
 FCC ID Number Q5EPT720002

Test Standards:

FCC Rules Part 90 Subpart I.

The EUT described above is tested by Shenzhen Academy of Metrology and Quality Inspection EMC Laboratory to determine the maximum emissions from the EUT. Shenzhen Academy of Metrology and Quality Inspection EMC Laboratory is assumed full responsibility for the accuracy of the test results. The test data, data evaluation, test procedures, and equipment configurations shown in this report were made in accordance with the procedures given in **part 2 and TIA 603C**. the energy emitted by the sample EUT tested as described in this report is in compliance with conducted and radiated emission limits of FCC Rules Part 90 Subpart I.

The test report is valid for above tested sample only and shall not be reproduced in part without written approval of the laboratory.

Tested by:	<u>Winnie Hou</u> (Winnie Hou)	Date:	<u>Jul.09, 2007</u>
Checked by:	<u>Louis Lin</u> (Louis Lin)	Date:	<u>Jul.09, 2007</u>
Approved by:	<u>Peter Lin</u> (Peter Lin)	Date:	<u>Jul.09, 2007</u>

1. TEST RESULTS SUMMARY

Table 1 Test Results Summary

Test Items	FCC Rules	Test Results
RF Output Power	90.205(h)	Pass
Type of emission	90.207	Pass
Emission Masks	90.210(b) (d)	Pass
Frequency Stability	90.213	Pass
Transient Frequency Behavior	90.214	Pass

2. GENERAL INFORMATION

2.1. Report information

- 2.1.1.This report is not a certificate of quality; it only applies to the sample of the specific product/equipment given at the time of its testing. The results are not used to indicate or imply that they are application to the similar items. In addition, such results must not be used to indicate or imply that SMQ approves recommends or endorses the manufacture, supplier or use of such product/equipment, or that SMQ in any way guarantees the later performance of the product/equipment.
- 2.1.2.The sample/s mentioned in this report is/are supplied by Applicant, SMQ therefore assumes no responsibility for the accuracy of information on the brand name, model number, origin of manufacture or any information supplied.
- 2.1.3.Additional copies of the report are available to the Applicant at an additional fee. No third part can obtain a copy of this report through SMQ, unless the applicant has authorized SMQ in writing to do so.

2.2. Measurement Uncertainty

Conducted Disturbance : 9kHz~30MHz 3.5dB

Radiated Disturbance: 30MHz~1000MHz 4.5dB
1GHz~18GHz 4.6dB

3. PRODUCT DESCRIPTION

3.1. EUT Description

Description : Two-way Radio
Manufacturer : KIRISUN ELECTRONICS (SHENZHEN) CO., LTD
Model Number : Two-way Radio
Input : DC 7.5V

Frequency Range: 406.1~454MHz 456-470MHz

RF Power output: 3.5W/1 W

Number of channels: 16

Operating Voltage: 7.5V ± 9%

f_{LO}=f_O - 51.65 (MHz)

The first IF: 51.65MHz

The second IF: 450kHz

channel 1 and 9 : 451.025MHz(Wide band)

channel 2 and 10 : 453.0125MHz(Wide band)

channel 3 and 11 : 468.200MHz(Wide band)

channel 4 and 12 : 451.025MHz(Narrow band)

channel 5 and 13 : 453.0125MHz(Narrow band)

channel 6 and 14 : 468.200MHz(Narrow band)

channel 7 and 15 : 452.100MHz(Wide band)

channel 8 and 16 : 452.100MHz(Narrow band)

Audio Power Output: 500mw (BTL OUT)

Speaker: 16 Ω, 0.5W

3.2. Related Submittal(s) / Grant (s)

This submittal(s) (test report) is intended for FCC ID: Q5EPT720002 filing to comply with FCC Part 90 Subpart I Rules.

3.3. Block Diagram of EUT Configuration



Figure 1 EUT setup

3.4. Operating Condition of EUT

Test mode 1: channel 2: 453.0125MHz(Wide band)
Test mode 2:channel 5: 453.0125MHz(Narrow band)

3.5. Special Accessories

There is not special accessories used for test.

3.6. Equipment Modifications

Not available for this EUT intended for grant.

3.7. Support Equipment List

N/A

3.8. Test Conditions

Date of test: Jun.11-Jul.9, 2007
Date of EUT Receive: Jun.10,2007
Temperature: 24~26 °C
Relative Humidity: 53~58%

4. TEST EQUIPMENT USED

Table 2 Test Equipment

No.	Equipment	Manufacturer	Model No.	Last Cal.	Cal. Interval
SB2603	EMI Test Receiver	Rohde & Schwarz	ESCS30	Jan.25, 2007	1 Year
SB3321	AMN	Rohde & Schwarz	ESH2-Z5	Jan.25, 2007	1 Year
SB2604	AMN	Rohde & Schwarz	ESH3-Z5	Jan.25, 2007	1 Year
SB3612	Audio generator	KENWOOD	AD-203D	Jun.20, 2006	1 Year
SB3436	EMI Test Receiver	Rohde & Schwarz	ESI26	Jan.25, 2007	1 Year
SB3440	Bilog Antenna	Chase	CBL6112B	Jan.25, 2007	1 Year
SB3435	Horn Antenna	Rohde & Schwarz	HF906	Jan.25, 2007	1 Year
SB3434	Horn Antenna	Rohde & Schwarz	HF906	Jan.25, 2007	1 Year
SB3435/01	Amplifier(1-18GHz)	Rohde & Schwarz	---	Jan.25, 2007	1 Year
SB3435/02	Amplifier(18-40GHz)	Rohde & Schwarz	---	May.06, 2007	1 Year
SB3435/03	Horn Antenna	Rohde & Schwarz	AT4560	May.06, 2007	1 Year
SB3450/01	3m Semi-anechoic chamber	Albatross Projects	9X6X6	Jan.25, 2007	1 Year
SB2541	RF Communication Tester	HP	8920A	May 23,2006	1 Year
SB2597/01	Dipole Antenna	Schwarzbeck	VHAP	Jan 30,2005	3 Years
SB2597/02	Dipole Antenna	Schwarzbeck	UHAP	Jan 30,2005	3 Years
SB3438	Signal generator	Rohde & Schwarz	SMR20	Jan.25, 2007	1Year
SB3732	Tem Chamber	Qingsheng	THS-C7C±100	Sep 25,2006	1Year
SB2599	Spectrum Analyzer	Anritsu	MS2661C	Jan.25, 2007	1 Year

5. RF OUTPUT POWER

5.1. PROVISIONS APPLICABLE

Applicants for licenses must request and use no more power than the actual power necessary for satisfactory operation

5.2. MEASUREMENT PROCEDURE

- 1). The eut antenna port connect to the RF Communication Tester.
- 2). Let the eut working in transmitter and used the RF Communication Tester to measure the output power.

5.3. TEST SETUP BLOCK DAIGRAM(setup block diagram of configuration)

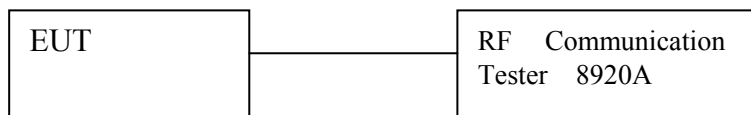

Figure 2 Radaited test setup

5.4. Test result:

Table 3 test result

channel	Ch2 453.0125MH z	Ch5 453.0125MH z
Power (W)	3.55	3.55

6. TYPE OF EMISSION

6.1. MODULATION CHARACTERISTICS MEASUREMENT METHOD

6.2.1 Modulation Limit

- 1). Configure the EUT as shown in figure 1, adjust the audio input for 60% of rated system deviation at 1KHz using this level as a reference (0dB) and vary the input level from -20 to +20dB. Record the frequency deviation obtained as a function of the input level.
- 2). Repeat step 1 with input frequency changing to 300,1000,3000, and 14000Hz in sequence.

6.2.2 Audio Frequency Response

- 1). Configure the EUT as shown in figure 1.
- 2). Adjust the audio input for 20% of rated system deviation at 1 KHz using this level as a reference (0 dB).
- 3). Vary the Audio frequency from 100 Hz to 30 KHz and record the frequency deviation

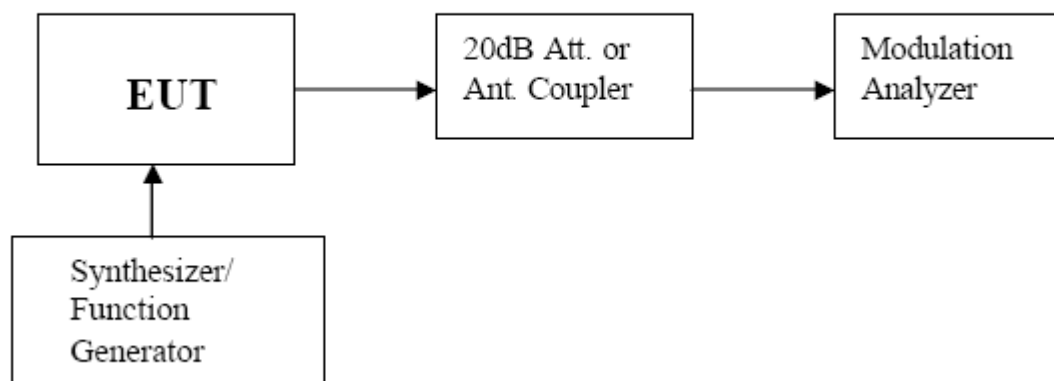

Figure 3 Modulation test setup

6.2. MEASUREMENT RESULT

6.2.1 Modulation Limit:

Wideband

Table 4 Modulation Test Results

Test Mode: 1

Modulation Level (dB)	Peak Deviation 300Hz	Freq At	Peak Deviation 1000Hz	Freq At	Peak Deviation 1500Hz	Freq At	Peak Deviation 3000Hz	Freq At
-20	0.10		0.45		0.26		0.43	
-15	0.10		0.49		0.49		0.85	
-10	0.10		0.49		0.70		1.27	
-5	0.15		0.95		1.58		2.50	
0	0.20		1.51		2.17		3.20	
5	0.35		2.82		3.12		3.30	
10	0.55		3.73		3.79		3.40	
15	0.85		3.88		3.85		3.46	
20	1.11		3.95		3.91		3.48	

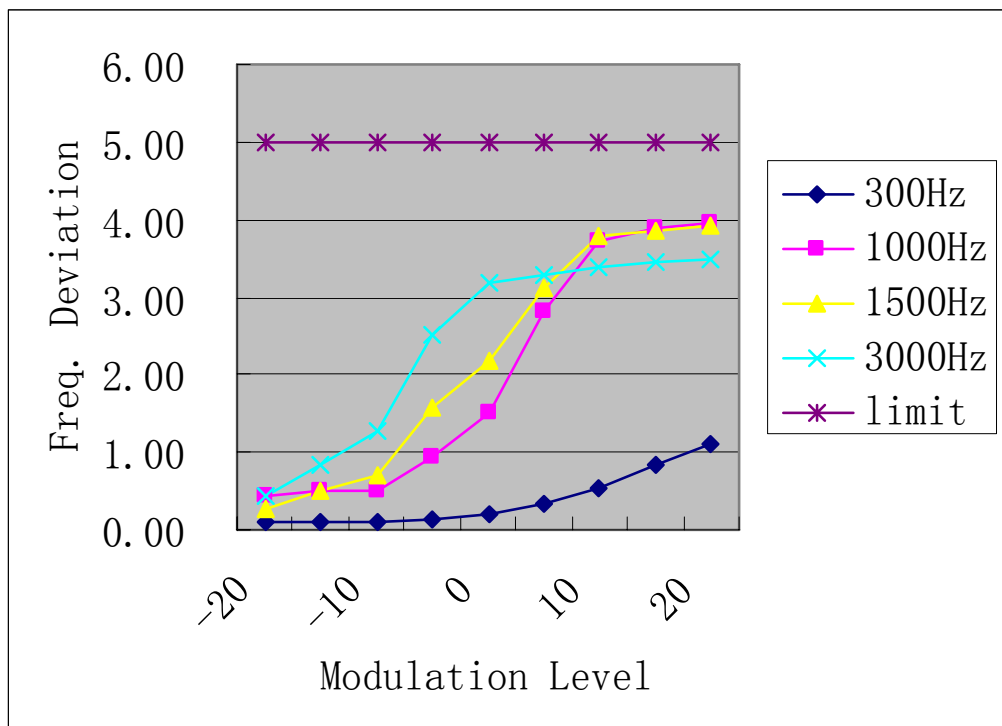

Figure 4 modulation test result

Table 5 Modulation Test Results

Test Mode:2

Modulation Level (dB)	Peak Deviation At 300Hz	Freq At	Peak Deviation At 1000Hz	Freq At	Peak Deviation At 1500Hz	Freq At	Peak Deviation At 3000Hz	Freq At
-20	0.10		0.19		0.26		0.34	
-15	0.10		0.30		0.55		0.68	
-10	0.10		0.50		0.71		1.00	
-5	0.10		0.98		1.20		1.10	
0	0.12		1.50		1.66		1.20	
5	0.20		1.75		1.70		1.25	
10	0.26		1.89		1.78		1.27	
15	0.30		2.00		1.79		1.30	
20	0.35		2.05		1.82		1.33	

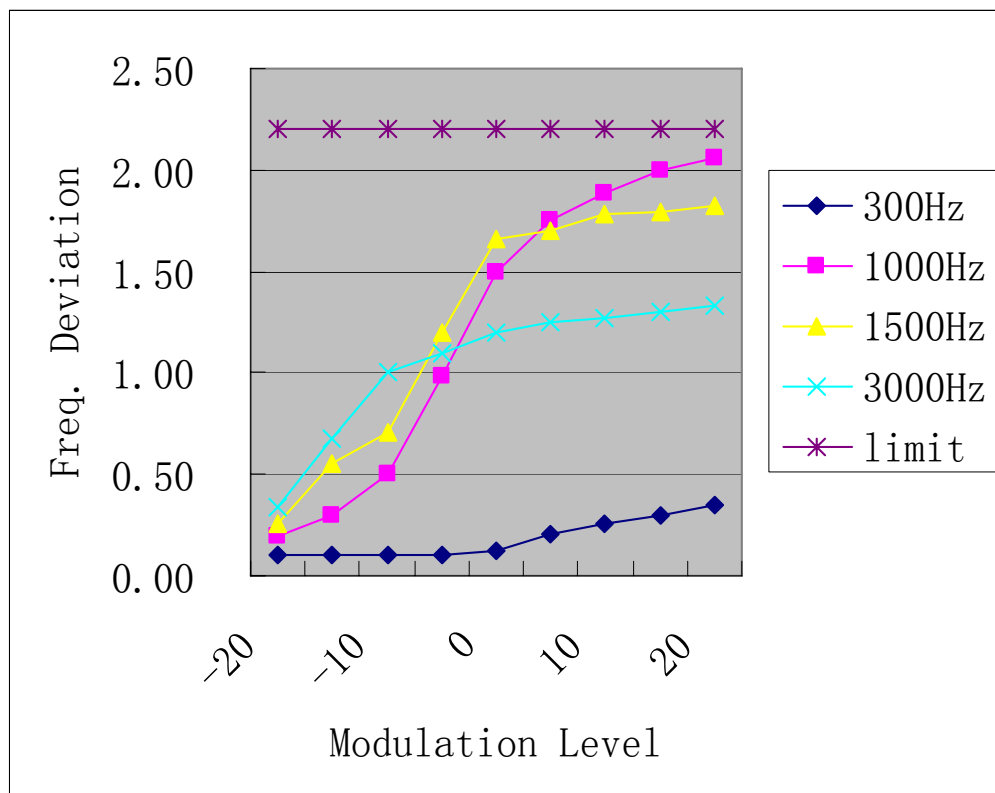

Figure 5 modulation test result

b). Audio Frequency Response:

Table 6 Modulation Test Results

Wideband

Frequency (Hz)	Ch2 Deviation (KHz)
100	0.05
200	0.05
300	0.15
400	0.54
500	0.66
600	0.83
700	0.98
800	1.16
900	1.30
1000	1.48
1200	1.77
1400	1.85
1600	1.90
1800	2.00
2000	2.05
2200	2.07
2400	2.48
2600	2.82
2800	3.08
3000	3.28
3200	3.35
3400	3.34
3600	3.24
3800	3.00
4000	2.73
4200	2.23
4400	1.89
4600	1.51
4800	1.26
5000	1.01
5500	0.77
6000	0.64
6500	0.48
7000	0.27
8500	0.10
10000	0.10

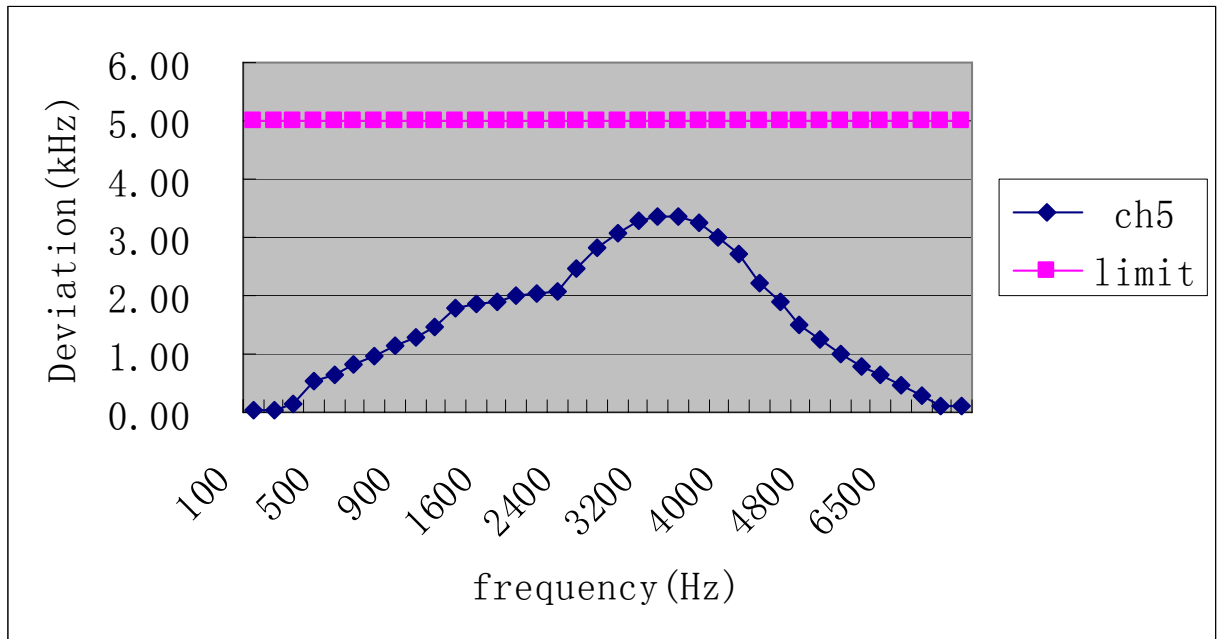

Figure 6 modulation test result

Table 7 Modulation Test Results

Narrowband

Frequency (Hz)	Ch5 Deviation (KHz)
100	0.05
200	0.05
300	0.15
400	0.47
500	0.63
600	0.80
700	0.97
800	1.16
900	1.31
1000	1.50
1200	1.61
1400	1.65
1600	1.69
1800	1.71
2000	1.80
2200	1.88
2400	1.70
2600	1.63
2800	1.52
3000	1.37
3200	1.19
3400	0.93
3600	0.61
3800	0.55
4000	0.42
4200	0.37
4400	0.27
4600	0.21
4800	0.20
5000	0.16
5500	0.14
6000	0.11
6500	0.10
7000	0.10
8500	0.10
10000	0.10

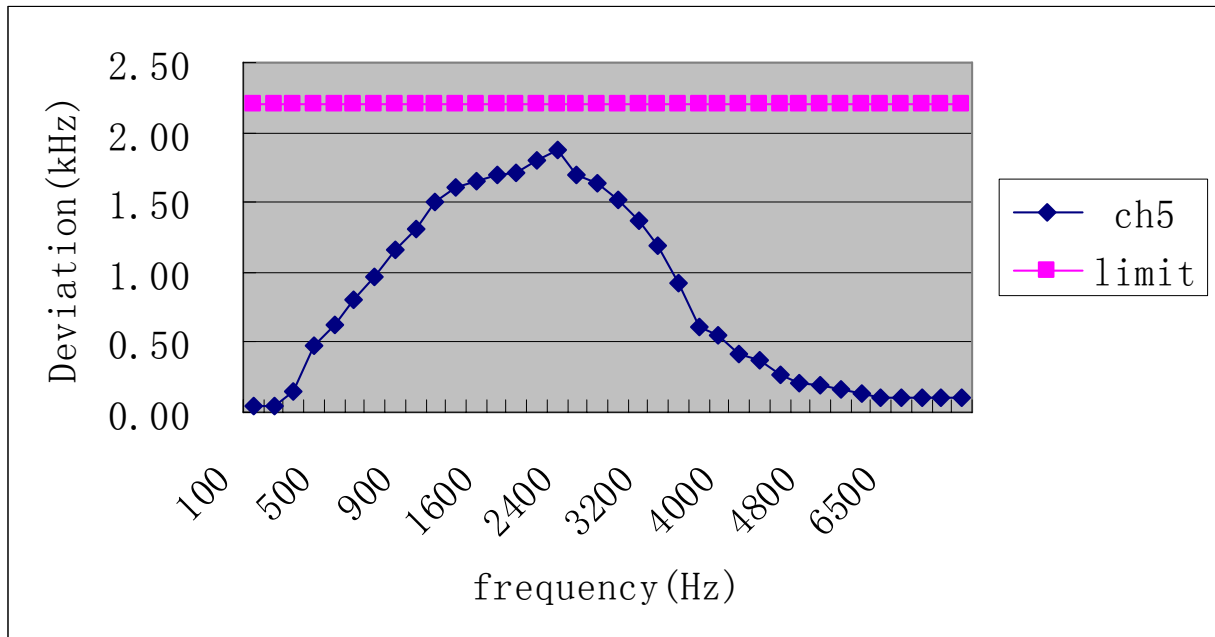

Figure 7 modulation test result

6.3. Emissions designator calculation:

(1) The first symbol indicates the type of modulation on the transmitter carrier.

A—Amplitude modulation, double sideband with identical information on each sideband.

F—Frequency modulation.

G—Phase modulation.

J—Single sideband with suppressed carrier.

P—Unmodulated pulse.

W—Cases not covered above, in which an emission consists of the main carrier modulated, either simultaneously or in a pre-established sequence, in a combination of two or more of the following modes: amplitude, angle, pulse.

(2) The second symbol indicates the type of signal modulating the transmitter carrier.

0—No modulation.

1—Digital modulation, no subcarrier.

2—Digital modulation, modulated subcarrier.

3—Analog modulation.

(3) The third symbol indicates the type of transmitted information.

A—Telegraphy for aural reception.

B—Telegraphy for machine reception.

C—Facsimile.

D—Data, telemetry, and telecommand.

E—Voice.

N—No transmitted information.

W—Combination of the above.

Wideband:

Emission designator: 14K3F3E (2M+2DK, M=3.95, D=3.20, K=1,
Necessary Bandwidth = 14.3 KHz)

Narrowband:

Emission designator: 8K50F3E (2M+2DK, M=2.05, D=2.20, K=1,
Necessary Bandwidth = 8.5 KHz)

7. EMISSION MASKS

7.1. PROVISIONS APPLICABLE

Emission Mask B. For transmitters that are equipped with an audio low-pass filter, the power of any emission must be attenuated below the unmodulated carrier power (P) as follows:

- (1) On any frequency removed from the assigned frequency by more than 50 percent, but not more than 100 percent of the authorized bandwidth: At least 25 dB.
- (2) On any frequency removed from the assigned frequency by more than 100 percent, but not more than 250 percent of the authorized bandwidth: At least 35 dB.
- (3) On any frequency removed from the assigned frequency by more than 250 percent of the authorized bandwidth: At least $43 + 10 \log (P)$ dB.

Emission Mask D—12.5 kHz channel bandwidth equipment. For transmitters designed to operate with a 12.5 kHz channel bandwidth, any emission must be attenuated below the power (P) of the highest emission contained within the authorized bandwidth as follows:

- (1) On any frequency from the center of the authorized bandwidth f_0 to 5.625 kHz removed from f_0 : Zero dB.
- (2) On any frequency removed from the center of the authorized bandwidth by a displacement frequency (f_d in kHz) of more than 5.625 kHz but no more than 12.5 kHz: At least $7.27(f_d - 2.88 \text{ kHz})$ dB.
- (3) On any frequency removed from the center of the authorized bandwidth by a displacement frequency (f_d in kHz) of more than 12.5 kHz: At least $50 + 10 \log (P)$ dB or 70 dB, whichever is the lesser attenuation.
- (4) The reference level for showing compliance with the emission mask shall be established using a resolution bandwidth sufficiently wide (usually two to three times the channel bandwidth) to capture the true peak emission of the equipment under test. In order to show compliance with the emissions mask up to and including 50 kHz removed from the edge of the authorized bandwidth, adjust the resolution bandwidth to 100 Hz with the measuring instrument in a peak hold mode. A sufficient number of sweeps must be measured to insure that the emission profile is developed. If video filtering is used, its bandwidth must not be less than the instrument resolution bandwidth. For emissions beyond 50 kHz from the edge of the authorized bandwidth, see paragraph (m) of this section. If it can be shown that use of the above instrumentation settings do not accurately represent the true interference potential of the equipment under test, then an alternate procedure may be used provided prior Commission approval is obtained.

7.2. RADIATED EMISSION

7.2.1. MEASUREMENT PROCEDURE

- 1). On a test site, the EUT shall be placed on a turntable, and in the XYZ three position.
- 2). The test antenna shall be oriented initially for vertical polarization located 3m from the EUT to correspond to the transmitter.
- 3). The output of the antenna shall be connected to the EMI test receiver(R&S ESIB26).

The setup of test receiver:

Detector: Peak

RBW: 120kHz for 30-1000MHz

1MHz for above1GHz

VBW: 300kHz for 30-1000MHz

3MHz for above1GHz

- 4). The transmitter shall be switched on; if possible, without the modulation and the measurement receiver shall be tuned to the frequency of the transmitter under test.
- 5). The test antenna shall be raised and lowered through the specified range of height until the measuring receiver detects a maximum signal level.
- 6). The transmitter shall than be rotated through 360° in the horizontal plane, until the maximum signal level is detected by the measuring receiver.
- 7). The test antenna shall be raised and lowered again through the specified range of height until the measuring receiver detects a maximum signal level.
- 8). The maximum signal level detected by the measuring receiver shall be noted.
- 9). The measurement shall be repeated with the test antenna set to horizontal polarization.
- 10). Replace the antenna with a proper Antenna (substitution antenna).
- 11). The substitution antenna shall be oriented for vertical polarization and, if necessary, the length of the substitution antenna shall be adjusted to correspond to the frequency of transmitting.
- 12). The substitution antenna shall be connected to a calibrated signal generator.
- 13). If necessary, the input attenuator setting of the measuring receiver shall be adjusted in order to increase the sensitivity of the measuring receiver.
- 14). The test antenna shall be raised and lowered through the specified range of the height to ensure that the maximum signal is received.
- 15). The input signal to substitution antenna shall be adjusted to the level that produces a level detected by the measuring receiver, that is equal to the level noted while the transmitter radiated power was measured, corrected for the change of input attenuation setting of the measuring receiver.

- 16). The input level to the substitution antenna shall be recorded as power level in dBm, corrected for any change of input attenuator setting of the measuring receiver.
- 17). The measurement shall be repeated with the test antenna and the substitution antenna oriented for horizontal polarization.

7.2.2.TEST SETUP BLOCK DIAGRAM (block diagram of configuration)

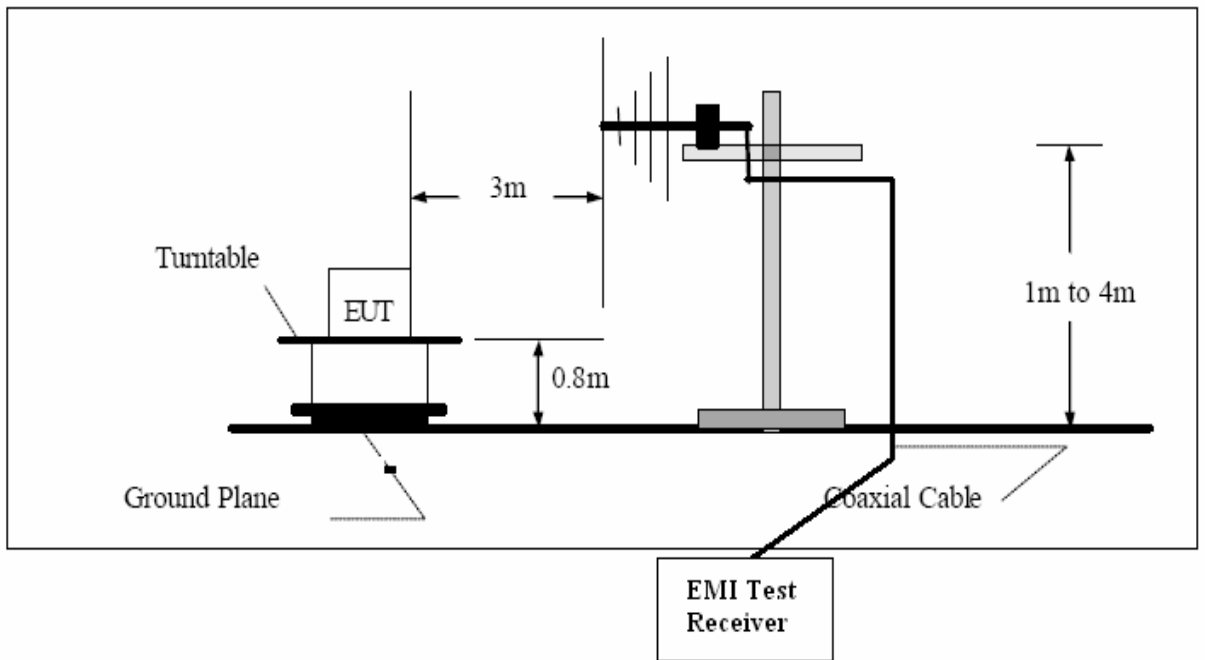

Figure 8 Radiation Test setup

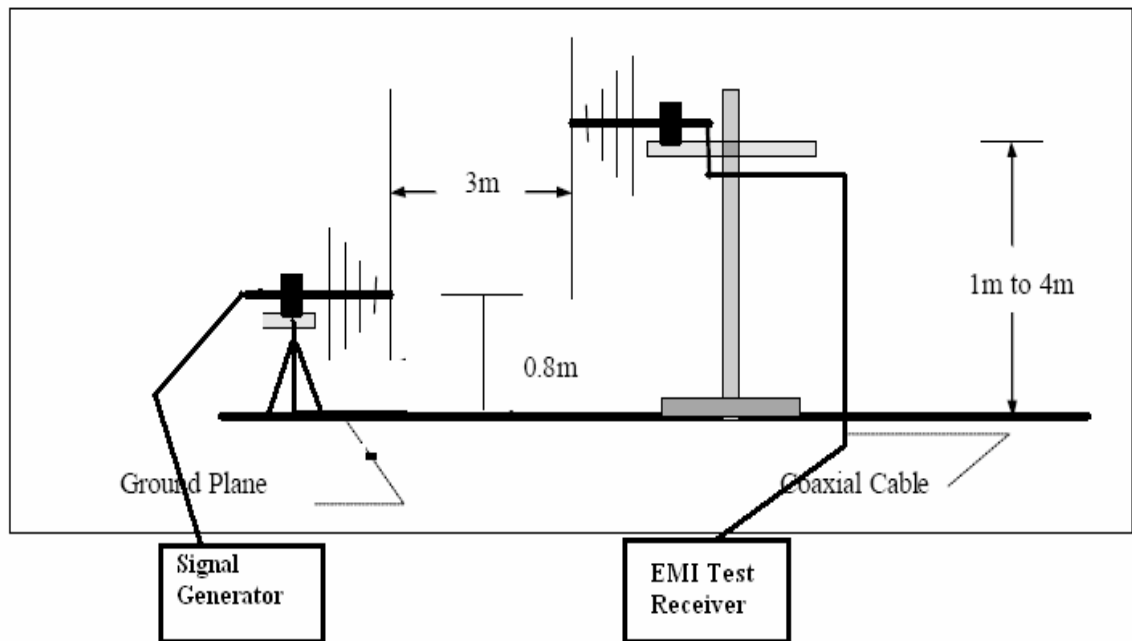

Figure 9 Substitution Method test setup

7.3. CONDUCTED EMISSION

7.3.1. MEASUREMENT PROCEDURE

- 1). The eut antenna port connect to the spectrum analyzer through a 20dB attenuator.
- 2). Let the eut working in transmitter and used the RF Communication Tester to measure the conducted emission.

- 3). The output of the antenna shall be connected to the EMI test receiver(R&S ESIB26).

The setup of test receiver:

Detector: Peak

RBW: 120kHz for 30-1000MHz

1MHz for above1GHz

VBW: 300kHz for 30-1000MHz

3MHz for above1GHz

7.3.2. TEST SETUP BLOCK DIAGRAM (block diagram of configuration)

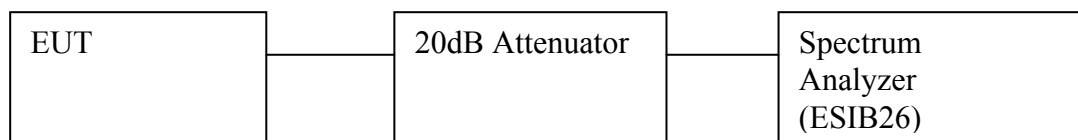

Figure 10 Conducted Test setup

7.4. MEASUREMENT RESULTS:

7.4.1. MEASUREMENT RESULTS NEAR CENTER FREQUENCY

Wideband (25kHz)

Ch2

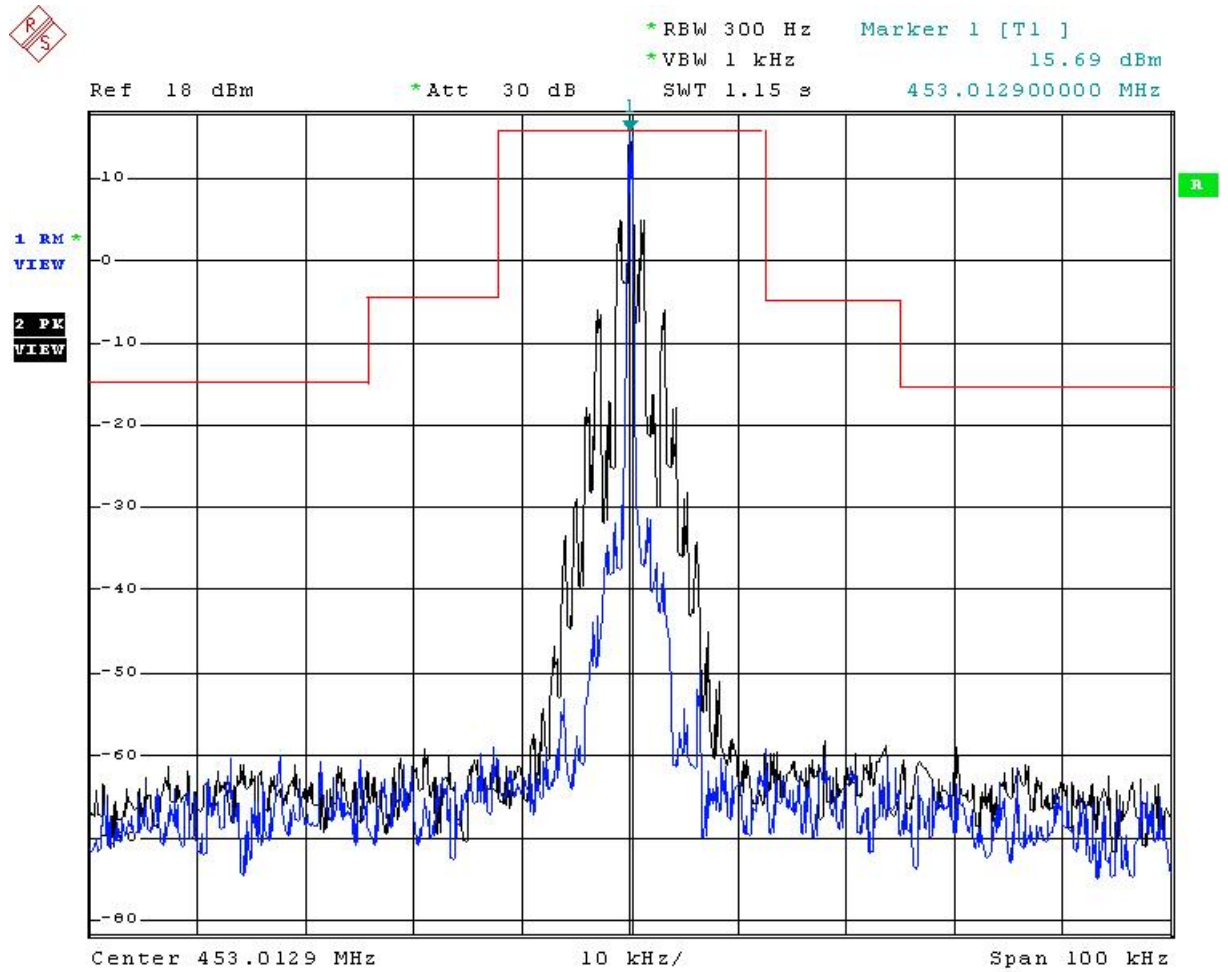

Comment: Conducted Disturbance
 Date: 20.JUN.2007 20:09:35

Narrowband

Ch5 (12.5kHz)

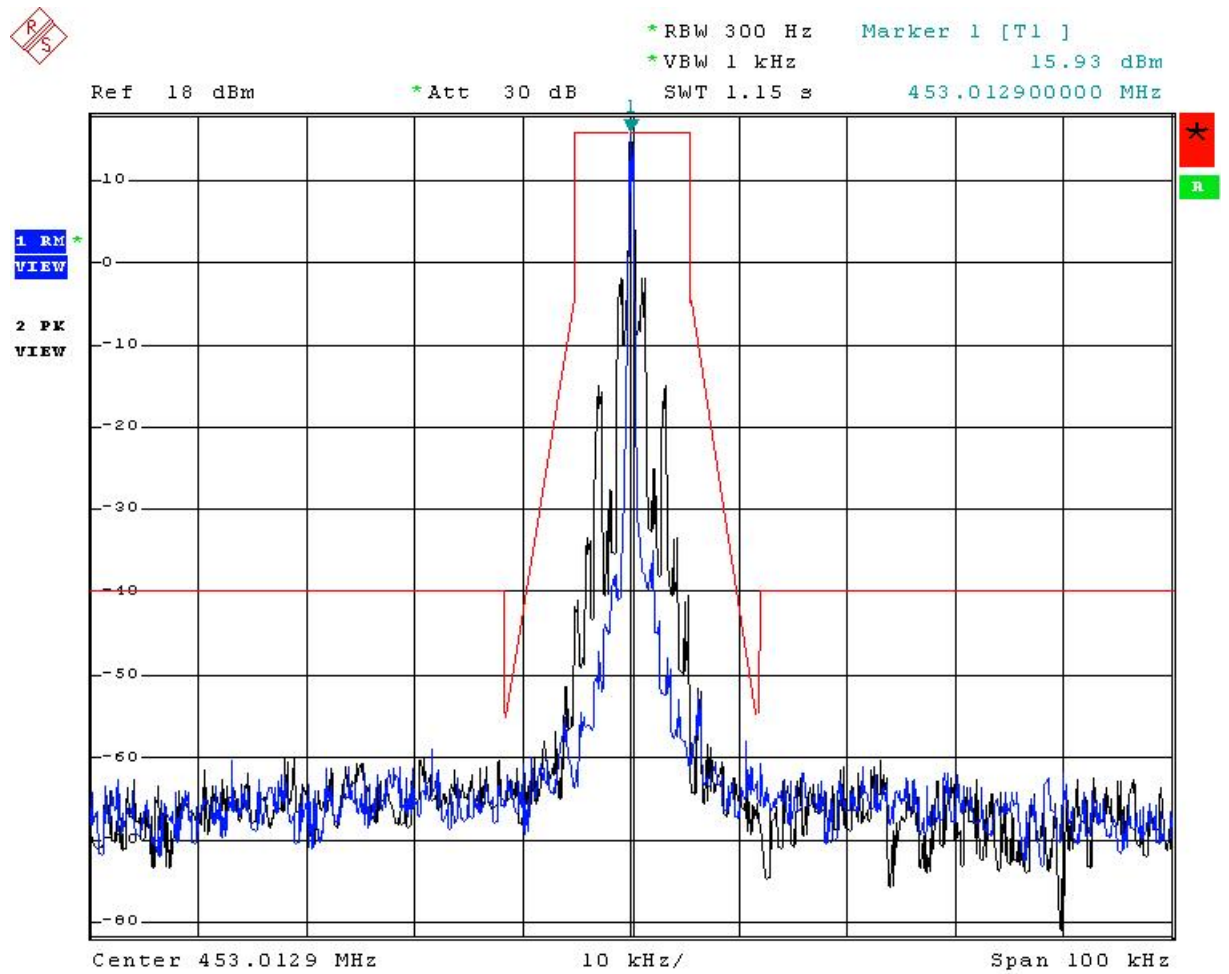

Comment: Conducted Disturbance
Date: 20.JUN.2007 20:10:57

7.4.2.RADIATED EMISSION MEASUREMENT RESULTS

Wideband(25kHz):

Ch2 power: $3.55\text{W}=35.5\text{dBm}$ $50 + 10 \log (P) \text{ dB}=55.5\text{dB}$ $\text{limit}=35.5-55.5=-20.0\text{dBm}$

Narrow(12.5kHz):

Ch5 power: $3.55\text{W}=35.5\text{dBm}$ $50 + 10 \log (P) \text{ dB}=55.5\text{dB}$ $\text{limit}=35.5-55.5=-20.0\text{dBm}$

Table 8 Test data

Working Mode: 1

Frequency (MHz)	Polarization	Reading (SG)(dBm)	Antenna Gain (dB)	Cable Loss (dB)	Transmit Power (dBm)	Limit (dBm)
489.014	V	-34.2	-0.88	3.7	-38.8	-20.0
1352.705	V	-37.1	6.55	3.3	-33.8	-20.0
1809.619	V	-35.3	7.05	3.5	-31.7	-20.0
2266.533	V	-39.1	7.95	3.7	-34.8	-20.0
1352.705	H	-45.3	6.55	3.3	-42.0	-20.0

Notes: 1.--- means the output power of all the spurious frequency is at least 15dB down to the limit.

2. Note: $\text{Transmit Power(dBm)}=\text{Reading(SG)(dBm)}+\text{Antenna Gain(dBm)}-\text{Cable Loss(dB)}$
 $\text{Transmit Power(dBm)}=10\text{Log}(\text{Transmit Power(mW)}/1\text{mW})$

Table 9 Test data

Working Mode: 2

Frequency (MHz)	Polarization	Reading (SG)(dBm)	Antenna Gain (dB)	Cable Loss (dB)	Transmit Power (dBm)	Limit (dBm)
1352.705	V	-37.1	6.55	3.3	-33.8	-20.0
1809.619	V	-35.3	7.05	3.5	-31.7	-20.0
2266.533	V	-40.2	7.95	3.7	-35.9	-20.0

Notes: 1.--- means the output power of all the spurious frequency is at least 15dB down to the limit.

2. Note: $\text{Transmit Power(dBm)}=\text{Reading(SG)(dBm)}+\text{Antenna Gain(dBm)}-\text{Cable Loss(dB)}$
 $\text{Transmit Power(dBm)}=10\text{Log}(\text{Transmit Power(mW)}/1\text{mW})$

Radiated Spurious

EUT: M/N:PT7200-02
 Manufacturer:
 Operating Condition: TX CH5
 Test Specification: HORIZONTAL & VERTICAL

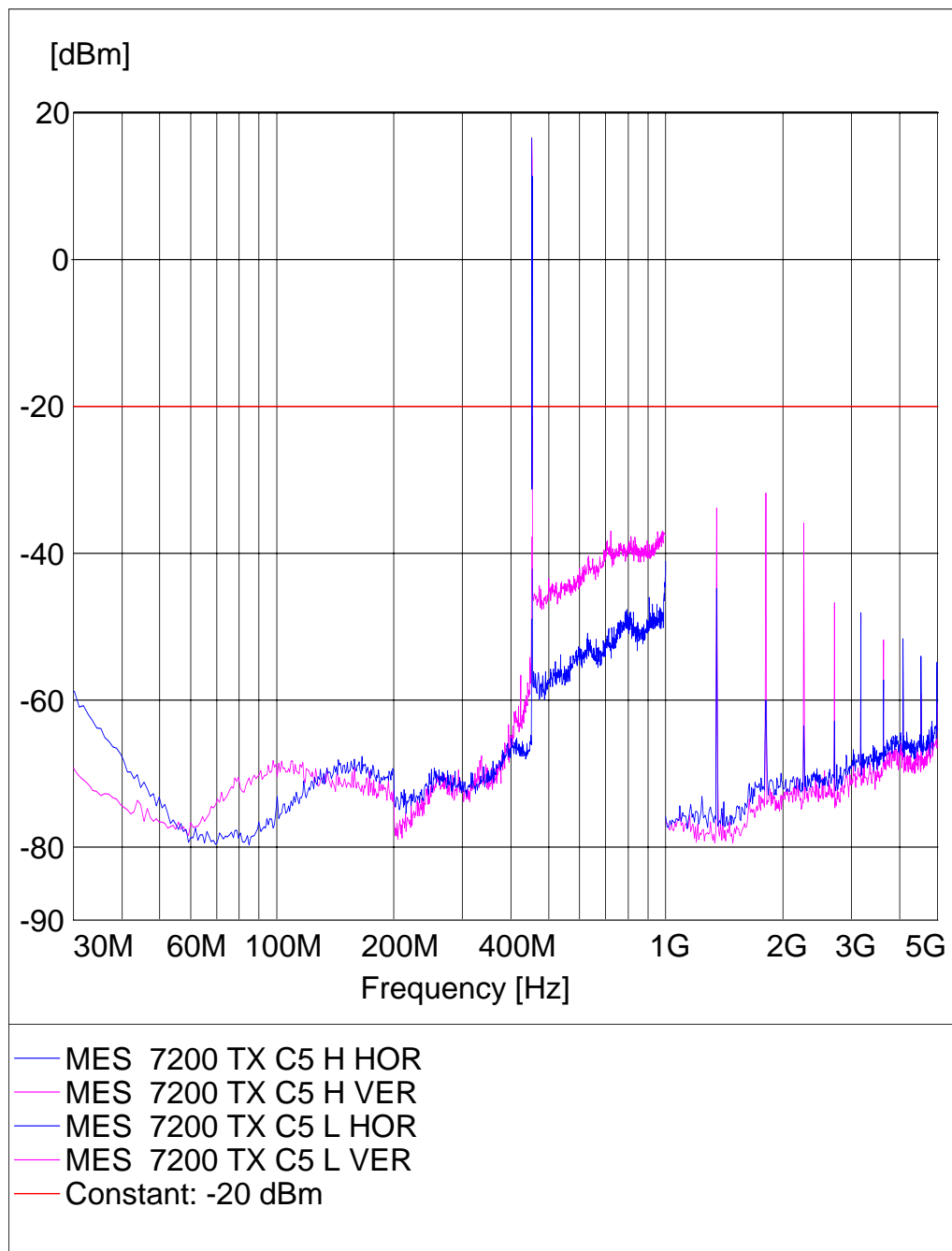

Radiated Spurious

EUT: M/N:PT7200-02
 Manufacturer:
 Operating Condition: TX CH2
 Test Specification: HORIZONTAL & VERTICAL

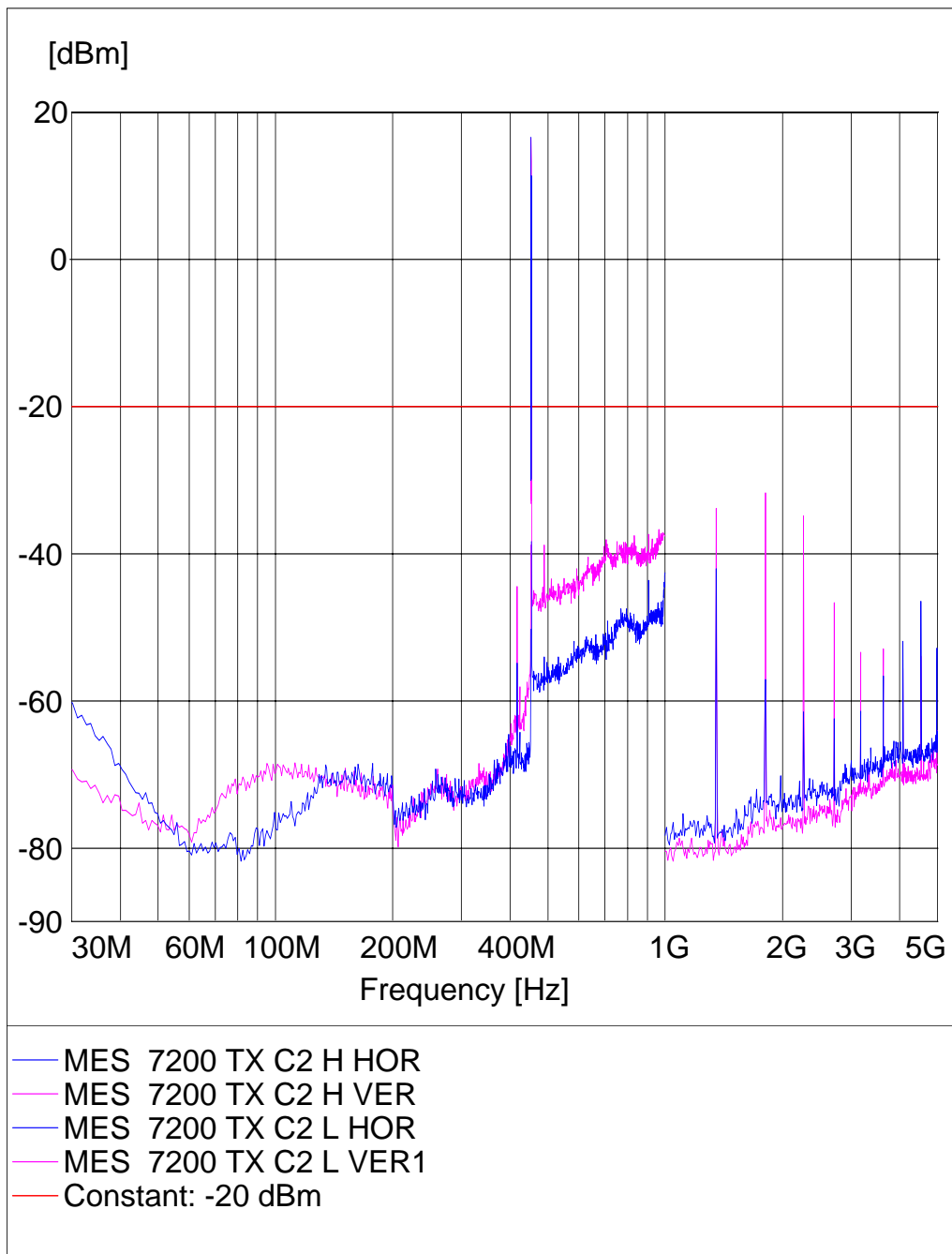

7.4.3. CONDUCTED EMISSION MEASUREMENT RESULTS

Wideband(25kHz):

Ch2 power: $3.55W=35.5dBm$ $50 + 10 \log (P) dB=55.5dB$ $limit=35.5-55.5=-20.0dBm$

Narrow(12.5kHz):

Ch5 power: $3.55W=35.5dBm$ $50 + 10 \log (P) dB=55.5dB$ $limit=35.5-55.5=-20.0dBm$

Table 10 Test data

Working Mode: 1

Frequency (MHz)	Reading (dBm)	Attenuator (dB)	Cable Loss (dB)	Transmit Power (dBm)	Limit (dBm)
1354.709	-54.2	20.0	0.3	-34.5	-20.0

Notes: 1.--- means the output power of all the spurious frequency is at least 10dB down to the limit.

2. Note: $Transmit\ Power(dBm)=Reading\ (dBm)+Attenuator(dBm)+Cable\ Loss(dB)$

Table 11 Test data

Working Mode: 2

Frequency (MHz)	Reading (dBm)	Attenuator (dB)	Cable Loss (dB)	Transmit Power (dBm)	Limit (dBm)
1360.721	-52.9	20.0	0.3	-33.2	-20.0

Notes: 1.--- means the output power of all the spurious frequency is at least 10dB down to the limit.

2. Note: $Transmit\ Power(dBm)=Reading\ (dBm)+Attenuator(dBm)+Cable\ Loss(dB)$

Conducted Spurious

EUT: M/N:PT7200-02
Manufacturer:
Operating Condition: TX CH5

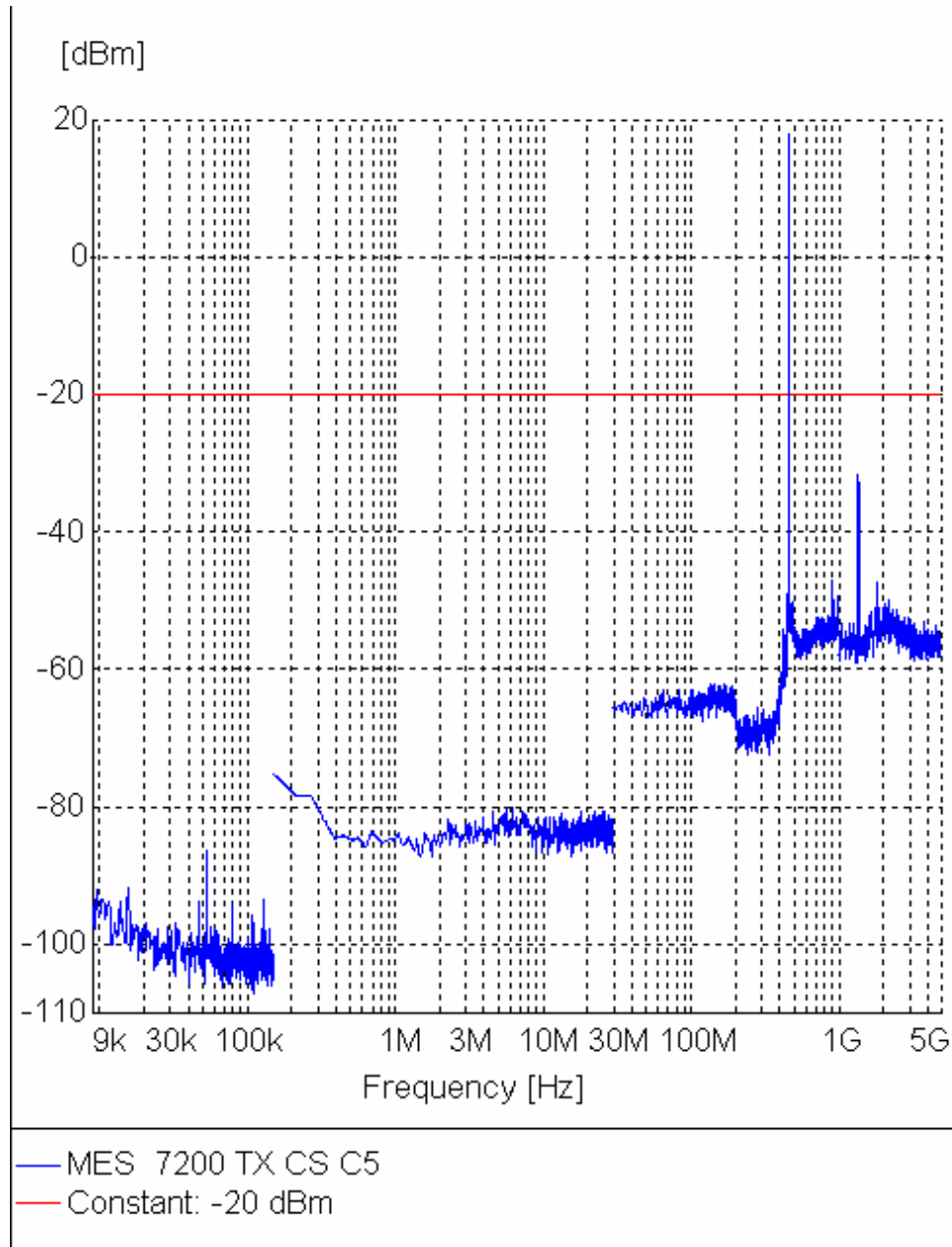

Conducted Spurious

EUT: M/N:PT7200-02
Manufacturer:
Operating Condition: TX CH2
Test Site:

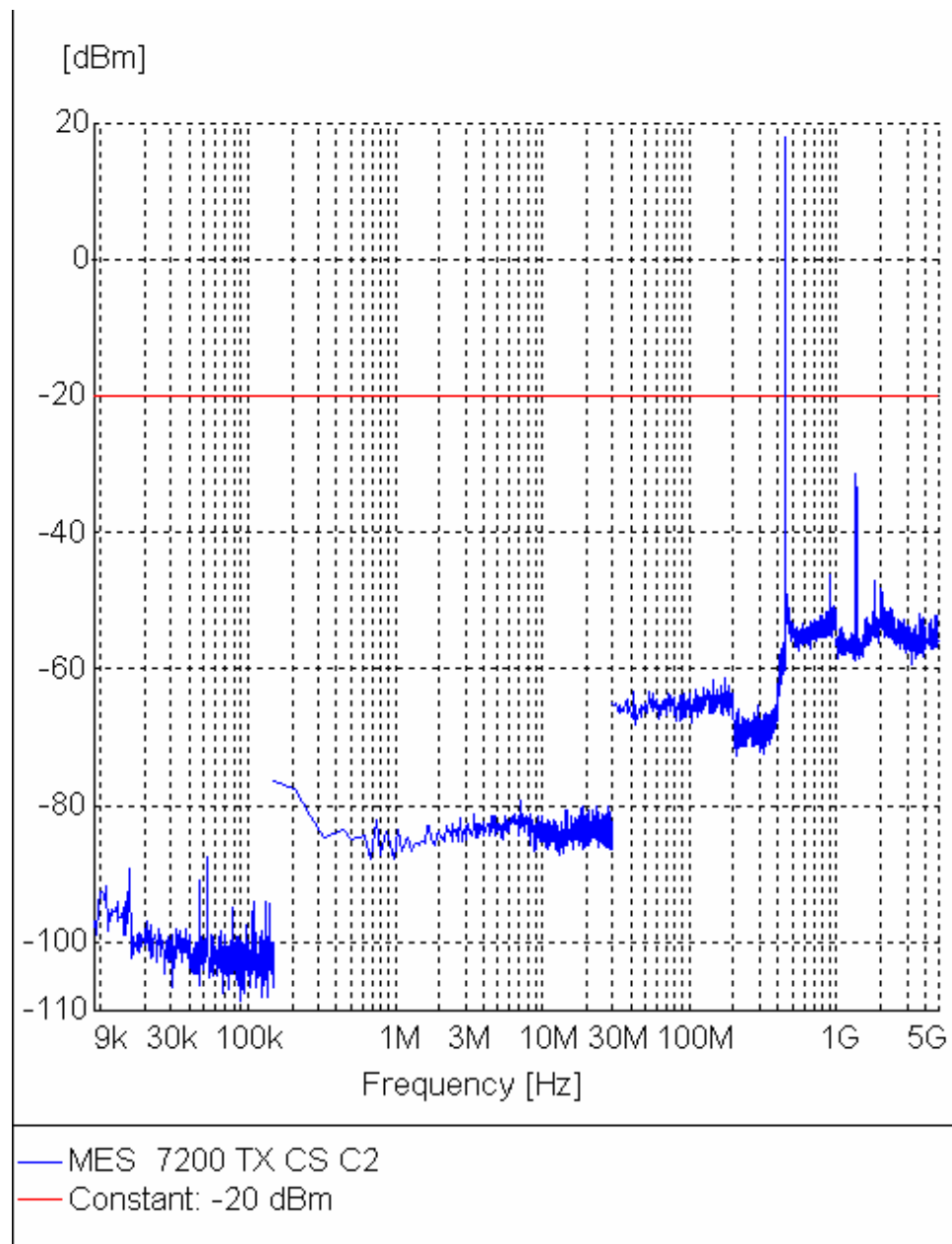

8. FREQUENCY STABILITY

8.1. PROVISIONS APPLICABLE

In the 406-470 MHz band, mobile stations designed to operate with a 12.5 kHz channel bandwidth must have a frequency stability of 2.5 ppm.

In the 406-470 MHz band, mobile stations designed to operate with a 25 kHz channel bandwidth must have a frequency stability of 5 ppm.

8.2. MEASUREMENT PROCEDURE

7.2.1 Frequency stability versus environmental temperature

1. Setup the configuration per figure 1 for frequencies measurement inside an environment chamber, Install new battery in the EUT.
2. Turn on EUT and set spectrum analyzer center frequency to the EUT radiated frequency. Set spectrum analyzer Resolution Bandwidth to 1KHz and Video Resolution Bandwidth to 1KHz and Frequency Span to 50KHz. Record this frequency as reference frequency.
3. Set the temperature of chamber to 50°C. Allow sufficient time (approximately 30 min) for the temperature of the chamber to stabilize. While maintaining a constant temperature inside the chamber, turn the EUT on and measure the EUT operating frequency.
4. Repeat step 2 with a 10°C decreased per stage until the lowest temperature -30°C is measured, record all measured frequencies on each temperature step.

7.2.2 Frequency stability versus input voltage

1. Setup the configuration per figure 1 for frequencies measured at temperature if it is within 15 °C to 25°C. Otherwise, an environment chamber set for a temperature of 20°C shall be used. Install new battery in the EUT.
2. Set spectrum analyzer center frequency to the EUT radiated frequency. Set spectrum analyzer Resolution Bandwidth to 1KHz and Video Resolution Bandwidth to 1KHz. Record this frequency as reference frequency.
3. For battery operated only device, supply the EUT primary voltage at the operating end point which is specified by manufacturer and record the frequency.

8.3. TEST SETUP BLOCK DIAGRAM(block diagram of configuration)

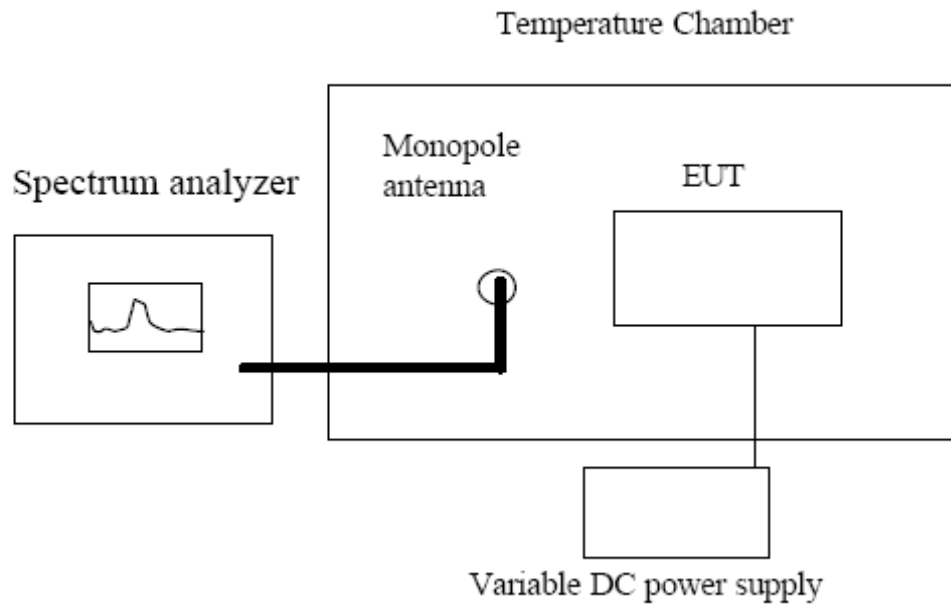

Figure 11 Frequency Tolerance test setup

8.4. TEST RESULT

a. Frequency stability versus input voltage (battery operation end point voltage is 6.5V)

Table 12 Frequency Tolerance Test Results

channel	Reference Frequency (MHz)	Frequency measured (MHz)	Frequency Error (ppm)	Limit (ppm)
Ch2	453.0125	453.012660	0.35	5
Ch5	453.0125	453.012654	0.34	2.5

b. Frequency stability versus ambient temperature

Table 13 Frequency Tolerance Test Results

Ch2 453.0125MHz			
Temperature	Power Supply	Frequency deviation measured with time Elapse (30 minutes)	
		MHz	ppm
50	New Battery	453.012668	0.37
40	New Battery	453.012661	0.36
30	New Battery	453.012658	0.35
20	New Battery	453.012659	0.35
10	New Battery	453.012662	0.36
0	New Battery	453.012666	0.37
-10	New Battery	453.012656	0.34
-20	New Battery	453.012658	0.35
-30	New Battery	453.012654	0.34

Table 14 Frequency Tolerance Test Results

Ch5 453.0125MHz			
Temperature	Power Supply	Frequency deviation measured with time Elapse (30 minutes)	
		MHz	ppm
50	New Battery	453.012658	0.35
40	New Battery	453.012660	0.35
30	New Battery	453.012656	0.34
20	New Battery	453.012658	0.35
10	New Battery	453.012652	0.34
0	New Battery	453.012660	0.35
-10	New Battery	453.012658	0.35
-20	New Battery	453.012659	0.35
-30	New Battery	453.012650	0.33

9. TRANSMITTER FREQUENCY BEHAVIOR

9.1. PROVISIONS APPLICABLE

Transmitters designed to operate in the 150–174 MHz and 421–512 MHz frequency bands must maintain transient frequencies within the maximum frequency difference limits during the time intervals indicated:

Time intervals 1, 2	Maximum frequency difference	All equipment	
		150 to 174 MHz	421 to 512 MHz

Transient Frequency Behavior for Equipment Designed to Operate on 25 kHz Channels			
t1 4.....	±25.0 kHz	5.0 ms	10.0 ms
t2.....	±12.5 kHz	20.0 ms	25.0 ms
t3 4.....	±25.0 kHz	5.0 ms	10.0 ms

Transient Frequency Behavior for Equipment Designed to Operate on 12.5 kHz Channels			
t1 4.....	±12.5 kHz	5.0 ms	10.0 ms
t2.....	±6.25 kHz	20.0 ms	25.0 ms
t3 4.....	±12.5 kHz	5.0 ms	10.0 ms

\1\on is the instant when a 1 kHz test signal is completely suppressed, including any capture time due to phasing.

t1 is the time period immediately following ton.

t2 is the time period immediately following t1.

t3 is the time period from the instant when the transmitter is turned off until toff.

toff is the instant when the 1 kHz test signal starts to rise.

2 During the time from the end of t2 to the beginning of t3, the frequency difference must not exceed the limits specified in § 90.213.

3 Difference between the actual transmitter frequency and the assigned transmitter frequency.

4 If the transmitter carrier output power rating is 6 watts or less, the frequency difference during this time period may exceed the maximum frequency difference for this time period.

9.2. MEASUREMENT PROCEDURE

- 1). The EUT was setup as 9.3.
- 2). Set EUT working on transmit mode
- 3). Use the oscilloscope to record the curve when the eut switch to ON and OFF Mode.

9.3. TEST SETUP BLOCK DIAGRAM (Block Diagram of Configuration)

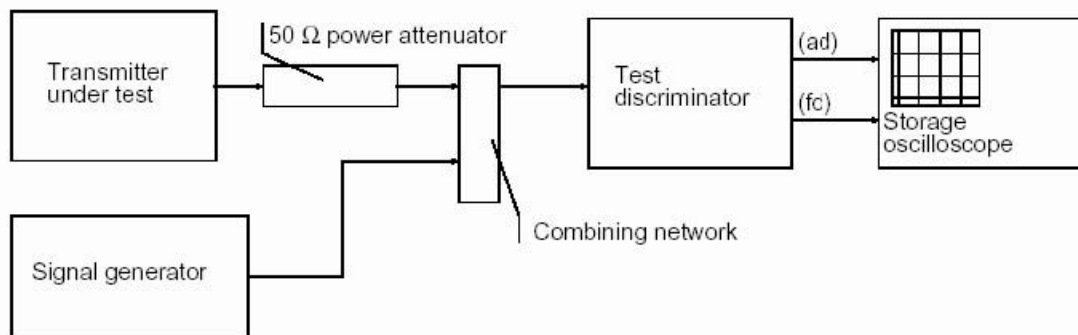

9.4. MEASUREMENT RESULT:

Refer to attached data chart.

Ch2 453.0125MHz bandwidth 25kHz (ON)

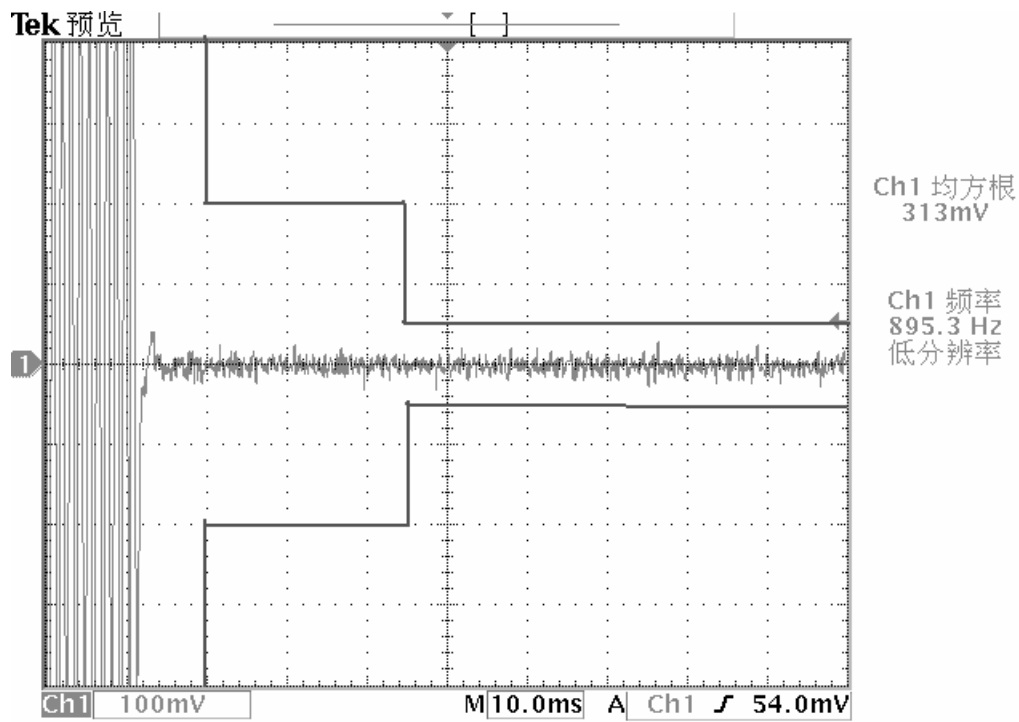

15 6月 2007
11:18:18

Ch2 453.0125MHz bandwidth 25kHz (OFF)

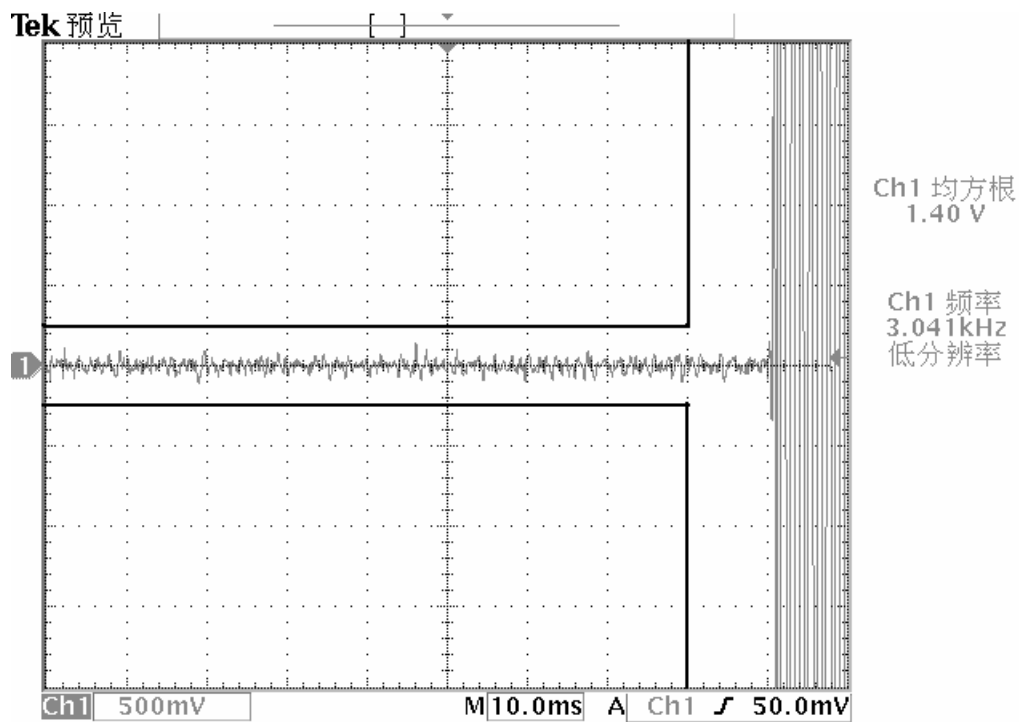

15 6月 2007
11:19:31

Ch5 453.0125MHz bandwidth 12.5kHz (ON)

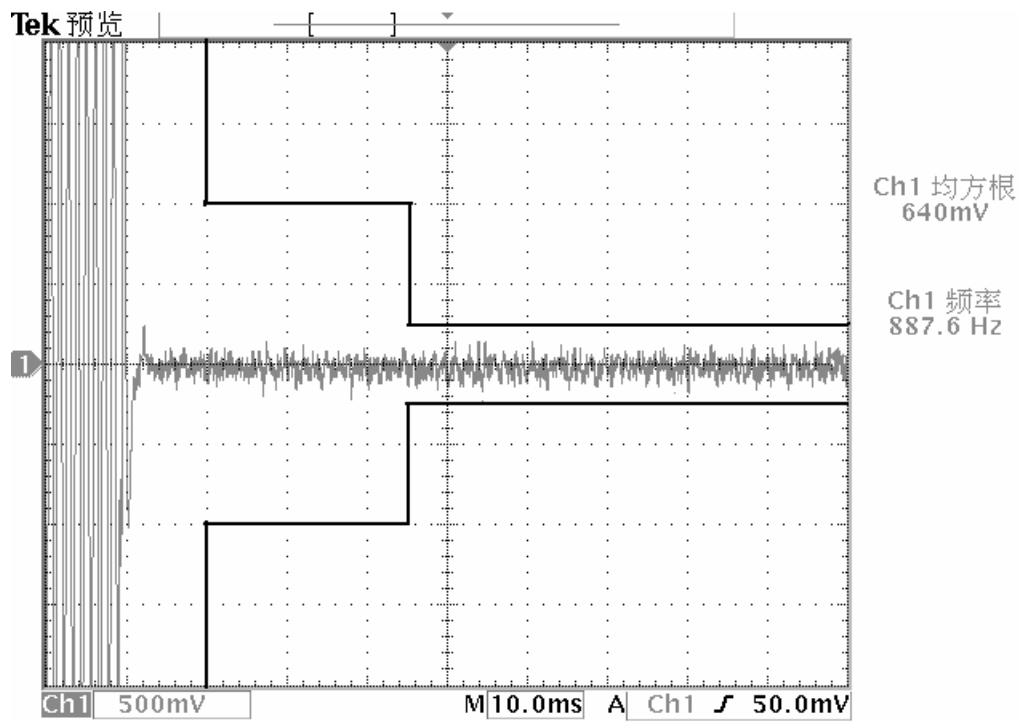

15 6月 2007
11:22:25

Ch5 453.0125MHz bandwidth 12.5kHz (OFF)

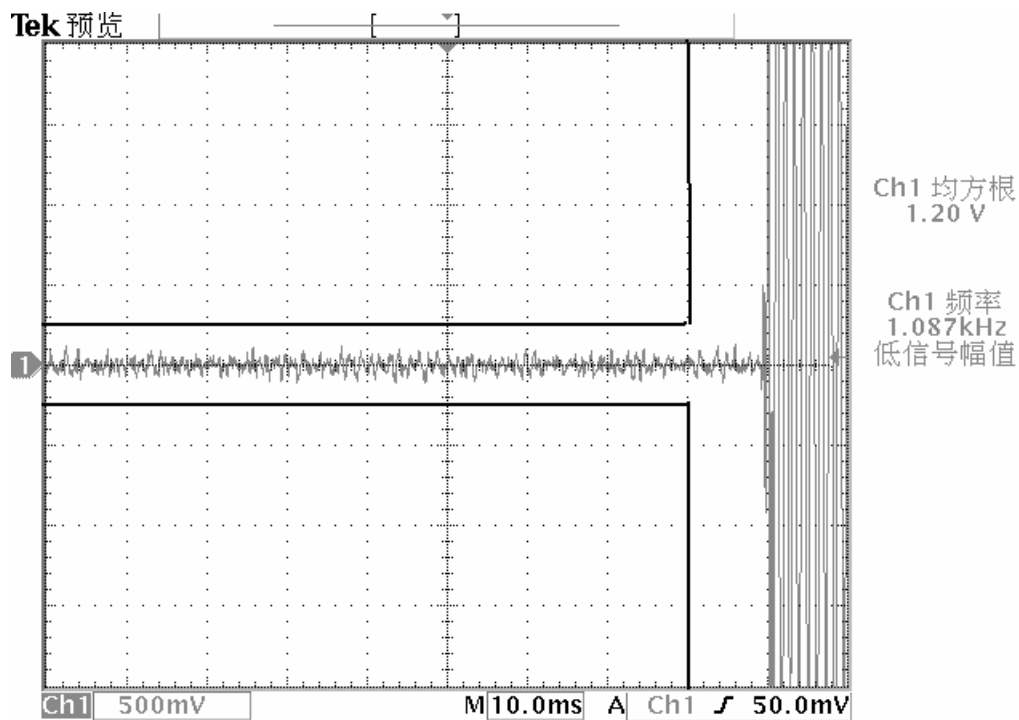

15 6月 2007
11:23:29

10. RF EXPOSURE

The EUT is a occupational equipment. And it operate with a duty factor not exceeding 50%.
The EUT cannot worn on the body.

According fcc requirements, the routine SAR evaluation is not required.

APPENDIX I TEST PHOTO

Photo 1 Radiated Emission Test



Photo 2 Radiated Emission Test



Photo 3 Frequency Stability test



Photo 4 Transient frequency behavior Test

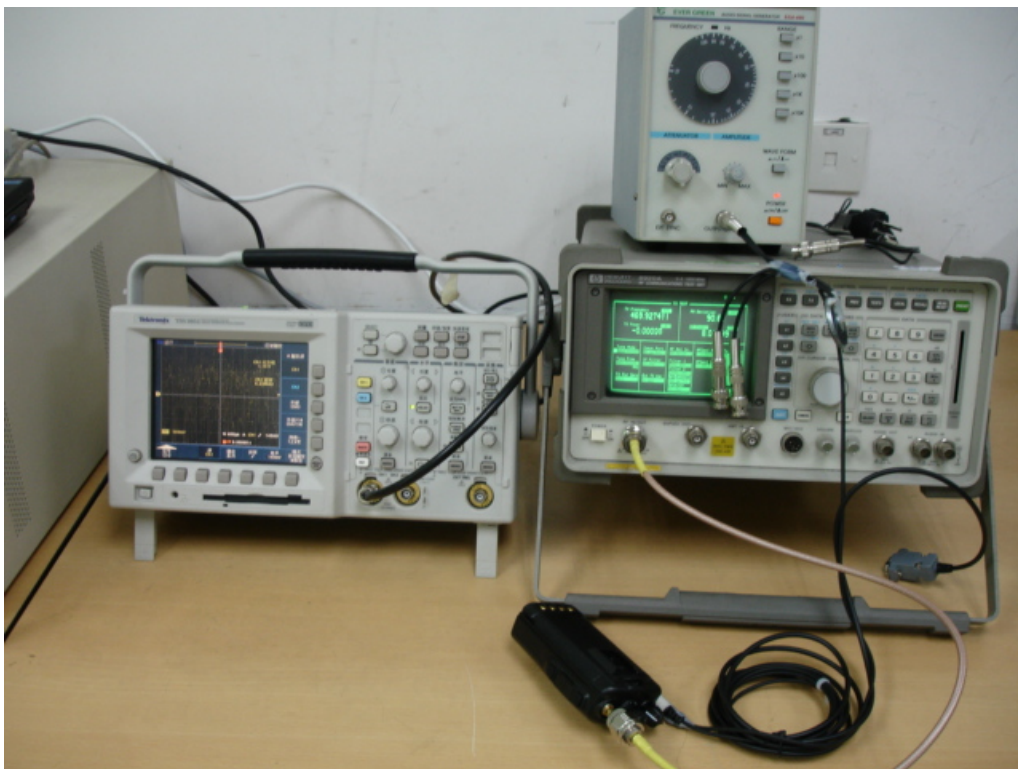

APPENDIX II EUT PHOTO

Photo 1 Appearance of EUT



Photo 2 Appearance of EUT



Photo 3 Appearance of EUT



Photo 4 Inside of EUT



Photo 5 Inside of EUT

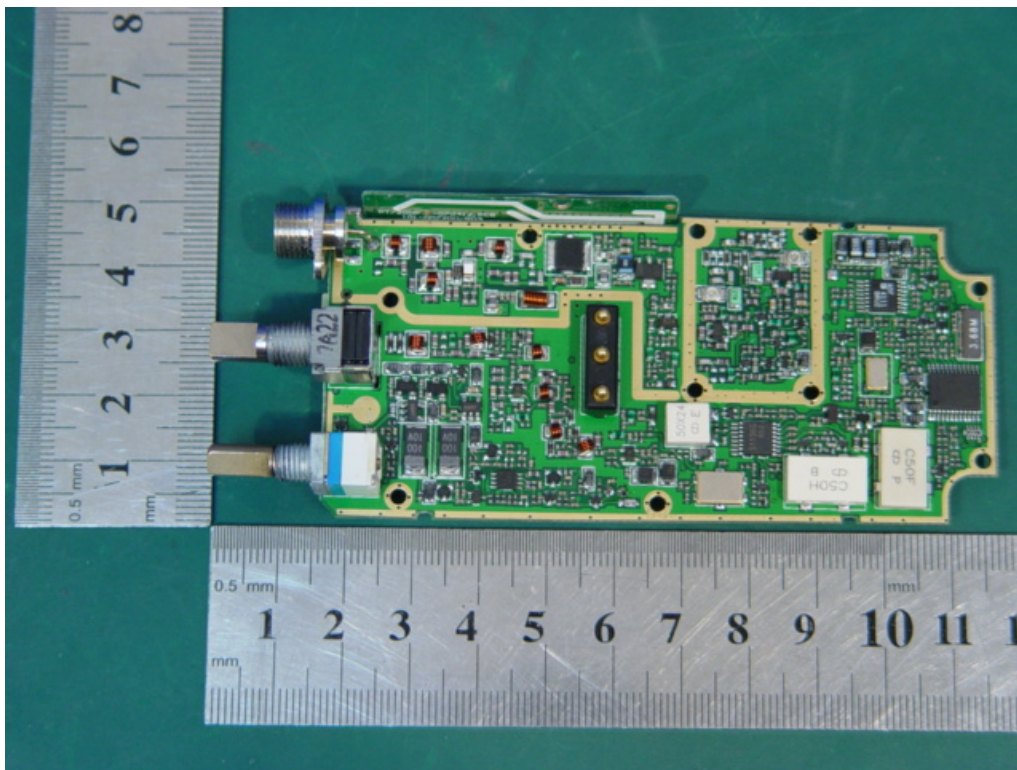

Photo 6 Inside of EUT

