

## FCC PART 90 TEST REPORT

### FCC Part 90

<b>Report Reference No.</b> .....	: <b>WE09110004</b>	
<b>FCC ID</b> .....	: <b>Q5EPT650003</b>	
Compiled by ( position+printed name+signature) ..	: File administrators Cary Li	<u>Cary Li</u>
Supervised by ( position+printed name+signature) ..	: Test Engineer Wenliang Li	<u>Wenliang Li</u>
Approved by ( position+printed name+signature) ..	: Manager Jimmy Li	<u>Jimmy Li</u>
Date of issue.....	: Nov 24, 2009	
<b>Testing Laboratory Name</b> .....	: <b>Shenzhen Huatongwei International Inspection Co., Ltd</b>	
Address .....	: Keji Nan No.12 Road, Hi-tech Park, Shenzhen, China	
<b>Applicant's name</b> .....	: <b>KIRISUN ELECTRONICS(SHENZHEN) CO., LTD</b>	
Address .....	: 6/F., BLDG. H-2, EAST INDUSTRIAL ZONE OF OVERSEAS CHINESE TOWN, NANSHAN DIST., SHENZHEN P.R. CHINA	
<b>Test specification:</b>		
Standard.....	: <b>FCC Part 90: PRIVATE LAND TWO-WAY RADIO SERVICES</b>	
TRF Originator.....	: Shenzhen Huatongwei International Inspection CO., Ltd	
Master TRF.....	: Dated 2006-06	
<b>Shenzhen Huatongwei International Inspection Co., Ltd. All rights reserved.</b>		
This publication may be reproduced in whole or in part for non-commercial purposes as long as the Shenzhen Huatongwei International Inspection Co., Ltd is acknowledged as copyright owner and source of the material. Shenzhen Huatongwei International Inspection Co., Ltd takes no responsibility for and will not assume liability for damages resulting from the reader's interpretation of the reproduced material due to its placement and context.		
<b>Test item description</b> .....	: Two-Way Radio	
Trade Mark .....	: Kirisun	
Model/Type reference .....	: PT6500-03	
Listed Models .....	: /	
Ratings .....	: DC 7.40V	
Modulation .....	: FM	
Result .....	: <b>Positive</b>	

# TEST REPORT

<b>Test Report No. :</b>	<b>WE09110004</b>	Nov 24, 2009
		Date of issue

Equipment under Test : Two-Way Radio

Model /Type : PT6500-03

Listed Models : /

**Applicant** : KIRISUN ELECTRONICS(SHENZHEN) CO., LTD

Address : 6/F., BLDG. H-2, EAST INDUSTRIAL ZONE OF  
OVERSEAS CHINESE TOWN, NANSHAN DIST.,  
SHENZHEN P.R. CHINA

**Manufacturer** : KIRISUN ELECTRONICS(SHENZHEN) CO., LTD

Address : 6/F., BLDG. H-2, EAST INDUSTRIAL ZONE OF  
OVERSEAS CHINESE TOWN, NANSHAN DIST.,  
SHENZHEN P.R. CHINA

<b>Test Result</b> according to the standards on page 4:	<b>Positive</b>
--	-----------------

The test report merely corresponds to the test sample.  
It is not permitted to copy extracts of these test result without the written permission of the test laboratory.

# Contents

<b>1.</b>	<b><u>TEST STANDARDS</u></b>	<b>4</b>
<b>2.</b>	<b><u>SUMMARY</u></b>	<b>5</b>
2.1.	General Remarks	5
2.2.	Product Description	5
2.3.	Equipment Under Test	5
2.4.	Short description of the Equipment under Test (EUT)	5
2.5.	EUT Configuration	5
2.6.	EUT operation mode	6
2.7.	EUT configuration	6
2.8.	Related Submittal(s) / Grant (s)	6
2.9.	Modifications	6
<b>3.</b>	<b><u>TEST ENVIRONMENT</u></b>	<b>7</b>
3.1.	Address of the test laboratory	7
3.2.	Test Facility	7
3.3.	Environmental conditions	8
3.4.	Configuration of Tested System	8
3.5.	Discription of Tested Modes	8
3.6.	Statement of the measurement uncertainty	8
3.7.	Test Description	9
3.8.	Equipments Used during the Test	9
<b>4.</b>	<b><u>TEST CONDITIONS AND RESULTS</u></b>	<b>11</b>
4.1.	Conducted Emissions Test	11
4.2.	Occupied Bandwidth Test	13
4.3.	Transmitter Radiated Spurious Emssion	22
4.4.	Spurious Emssion On Antenna Port	28
4.5.	Modulation Charcateristics	35
4.6.	Frequency Stability Test	38
4.7.	Maximum Transmitter Power	43
4.8.	Transmitter Frequency Behavior	47
4.9.	Receiver Radiated Spurious Emssion	50
<b>5.</b>	<b><u>TEST SETUP PHOTOS OF THE EUT</u></b>	<b>56</b>
<b>6.</b>	<b><u>EXTERNAL AND INTERNAL PHOTOS OF THE EUT</u></b>	<b>57</b>

# **1. TEST STANDARDS**

The tests were performed according to following standards:

**FCC Rules Part 90: PRIVATE LAND TWO-WAY RADIO SERVICES.**

**TIA/EIA 603: Land Mobile FM or PM Communications Equipment Measurement and Performance Standards.**

## 2. SUMMARY

### 2.1. General Remarks

Date of receipt of test sample : Nov 13, 2009

Testing commenced on : Nov 13, 2009

Testing concluded on : Nov 24, 2009

### 2.2. Product Description

The KIRISUN ELECTRONICS (SHENZHEN) CO., LTD's Model: PT568-03 or the "EUT" as referred to in this report is a single channel Two-Way Radio designed for voice communication. It is designed by way of utilizing the FM modulation achieves the system operating.

\* The test data gathered are from typical production samples provided by the manufacturer.

A major technical description of EUT is described as following:

- a). Modulation: FM
- b). Maximum Transmitter Power: 4W
- c). Antenna Designation: Detachable
- d). Power Supply: DC 7.40V by battery
- e). Operating Frequency Range  
Frequency Range: 450-520MHz
- f). Maximum Transmitter Power: 4.32 W for 25 KHz channel separation  
4.37 W for 12.5 KHz channel separation

### 2.3. Equipment Under Test

#### Power supply system utilised

Power supply voltage :   o 120V / 60 Hz                           o 115V / 60Hz  
                                  o 12 V DC                                   o 24 V DC  
                                  o Other (specified in blank below)

DC 7.40V from Battery

### 2.4. Short description of the Equipment under Test (EUT)

450-520MHz U frequency band Two-Way Radio (PT6500-03).

For more details, refer to the user's manual of the EUT.

Serial number: Prototype

### 2.5. EUT Configuration

The EUT configuration for testing is installed on RF field strength measurement to meet the Commission's requirement and operating in a manner which intends to maximize its emission characteristics in a continuous normal application.

## 2.6. EUT operation mode

The EUT has been tested under typical operating condition and The Transmitter was operated in the normal operating mode. The TX frequency was fixed which was for the purpose of the measurements.

## 2.7. EUT configuration

**The following peripheral devices and interface cables were connected during the measurement:**

- - supplied by the manufacturer
- o - supplied by the lab
- o Power Cable  
Length (m) : /  
Shield : /  
Detachable : /
- o Multimeter  
Manufacturer : /  
Model No. : /

## 2.8. Related Submittal(s) / Grant (s)

This submittal(s) (test report) is intended for FCC ID: **Q5EPT650003** filing to comply with FCC Part 90 Rules.

## 2.9. Modifications

No modifications were implemented to meet testing criteria.

## **3. TEST ENVIRONMENT**

### **3.1. Address of the test laboratory**

Shenzhen Huatongwei International Inspection Co., Ltd  
Keji Nan No.12 Road, Hi-tech Park, Shenzhen, China  
Phone: 86-755-26715686 Fax: 86-755-26748089

The sites are constructed in conformance with the requirements of ANSI C63.7, ANSI C63.4 (2003) and CISPR Publication 22.

### **3.2. Test Facility**

The test facility is recognized, certified, or accredited by the following organizations:

#### **CNAS-Lab Code: L1225**

Shenzhen Huatongwei International Inspection Co., Ltd has been assessed and proved to be in compliance with CNAS-CL01 Accreditation Criteria for Testing and Calibration Laboratories (identical to ISO/IEC 17025: 2005 General Requirements) for the Competence of Testing and Calibration Laboratories, Date of Registration: August 02, 2007. Valid time is until March 29, 2012.

#### **A2LA-Lab Cert. No. 2243.01**

Shenzhen Huatongwei International Inspection Co., Ltd, EMC Laboratory has been accredited by A2LA for technical competence in the field of electrical testing, and proved to be in compliance with ISO/IEC 17025: 2005 General Requirements for the Competence of Testing and Calibration Laboratories and any additional program requirements in the identified field of testing. Valid time is from Aug 24, 2005 to Dec 31, 2009.

#### **FCC-Registration No.: 662850**

Shenzhen Huatongwei International Inspection Co., Ltd, EMC Laboratory has been registered and fully described in a report filed with the FCC (Federal Communications Commission). The acceptance letter from the FCC is maintained in our files. Registration 662850, Renewal date July 01, 2009.

#### **IC-Registration No.: 5377**

The 3m Alternate Test Site of Shenzhen Huatongwei International Inspection Co., Ltd has been registered by Certification and Engineering Bureau of Industry Canada for the performance of radiated measurements with Registration No. 5377 on February 13th, 2009.

#### **ACA**

Shenzhen Huatongwei International Inspection Co., Ltd, EMC Laboratory can also perform testing for the Australian C-Tick mark as a result of our A2LA accreditation.

#### **NEMKO-Aut. No.: ELA125**

Shenzhen Huatongwei International Inspection Co., Ltd has been assessed the quality assurance system, the testing facilities, qualifications and testing practices of the relevant parts of the organization. The quality assurance system of the Laboratory has been validated against ISO/IEC 17025:2005 or equivalent. The laboratory also fulfils the conditions described in Nemko Document NLA-10, the Authorization is valid through July 07, 2009.

#### **VCCI**

The 3m Semi-anechoic chamber (12.2m×7.95m×6.7m) and Shielded Room (8m×4m×3m) of Shenzhen Huatongwei International Inspection Co., Ltd has been registered in accordance with the Regulations for Voluntary Control Measures with Registration No.: R-2484. Date of Registration: December 20, 2006. Valid time is until December 19, 2009.

Main Ports Conducted Interference Measurement of Shenzhen Huatongwei International Inspection Co., Ltd has been registered in accordance with the Regulations for Voluntary Control Measures with Registration No.: C-2726. Date of Registration: December 20, 2006. Valid time is until December 19, 2009.

## DNV

Shenzhen Huatongwei International Inspection Co Ltd has been found to comply with the requirements of DNV towards subcontractor of EMC and safety testing services in conjunction with the EMC and Low voltage Directives and in the voluntary field. The acceptance is based on a formal quality Audit and follow-ups according to relevant parts of ISO/IEC Guide 17025(2005), in accordance with the requirements of the DNV Laboratory Quality Manual towards subcontractors. Valid time is until 09 July, 2010.

### 3.3. Environmental conditions

During the measurement the environmental conditions were within the listed ranges:

Temperature:	<u>15-35 ° C</u>
Humidity:	<u>30-60 %</u>
Atmospheric pressure:	<u>950-1050mbar</u>

### 3.4. Configuration of Tested System

Fig. 2-1 Configuration of Tested System

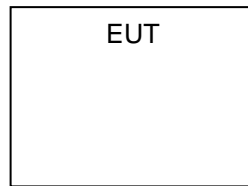

Table 2-1 Equipment Used in Tested System

No.	Product	Manufacturer	Model No.	Serial No.	FCC ID
	/				

### 3.5. Discription of Tested Modes

The EUT (Two-Way Radio) has been tested under normal operating condition. Three channels (the top, the middle and the bottom) are chosen for testing at each channel separation (12.5 KHz/ 25KHz).

### 3.6. Statement of the measurement uncertainty

The data and results referenced in this document are true and accurate. The reader is cautioned that there may be errors within the calibration limits of the equipment and facilities. The measurement uncertainty was calculated for all measurements listed in this test report acc. to CISPR 16 - 4 „Specification for radio disturbance and immunity measuring apparatus and methods – Part 4: Uncertainty in EMC Measurements“ and is documented in the Shenzhen Huatongwei International Inspection Co., Ltd quality system acc. to DIN EN ISO/IEC 17025. Furthermore, component and process variability of devices similar to that tested may result in additional deviation. The manufacturer has the sole responsibility of continued compliance of the device.



Hereafter the best measurement capability for Shenzhen Huatongwei laboratory is reported:

Test	Range	Measurement Uncertainty	Notes
Radiated Emission	30~1000MHz	4.22dB	(1)
Radiated Emission	1~12.75GHz	4.35dB	(1)
Conducted Disturbance	0.15~30MHz	3.29dB	(1)

(1) This uncertainty represents an expanded uncertainty expressed at approximately the 95% confidence level using a coverage factor of k=2.

### 3.7. Test Description

FCC Rules	Description of Test	Test Result
§ 15.107	Conducted Emission	N/A
§ 15.109	Receiver Radiated Spurious Emssion	Complies
§ 90.205	Maximum Transmitter Power	Complies
§ 90.207	Modulation Characteristic	Complies
§ 90.209	Occupied Bandwidth	Complies
§ 90.210	Emission Mask	Complies
§ 90.213	Frequency Stability	Complies
§ 90.214	Transmitter Frequency Behavior	Complies
§ 90.210	Transmitter Radiated Spurious Emssion	Complies
§ 90.210	Spurious Emssion On Antenna Port	Complies

### 3.8. Equipments Used during the Test

DC Power Conducted Emission				
Name of Equipment	Manufacturer	Model	Serial Number	Calibration Due
Artificial Mains	Rohde&Schwarz	ESH2-Z5	100028	11/2010
EMI Test Receiver	Rohde&Schwarz	ESCS 30	100038	11/2010
Pulse Limiter	Rohde&Schwarz	ESHSZ2	100044	11/2010
EMI Test Software	Rohde&Schwarz	ES-K1 V1.71	N/A	11/2010

Transmitter Radiated Spurious Emssion & Occupied Bandwidth & Emission Mask & Receiver Radiated Spurious Emssion				
Name of Equipment	Manufacturer	Model	Serial Number	Calibration Due
Ultra-Broadband Antenna	Rohde&Schwarz	HL562	100015	11/2010
EMI Test Receiver	Rohde&Schwarz	ESI 26	100009	11/2010
RF Test Panel	Rohde&Schwarz	TS / RSP	335015/ 0017	N/A
Turntable	ETS	2088	2149	N/A
Antenna Mast	ETS	2075	2346	N/A
EMI Test Software	Rohde&Schwarz	ES-K1 V1.71	N/A	11/2010

Modulation Characteristic				
Name of Equipment	Manufacturer	Model	Serial Number	Calibration Due
Modulation Analyzer	HP	8901B	3104A03367	11/2010
Signal Generator	Rohde&Schwarz	SMT03	100059	11/2010

Frequency Stability				
Name of Equipment	Manufacturer	Model	Serial Number	Calibration Due
Communication Test Set	HP	HP8920B	US35010135	11/2010
Signal Generator	Rohde&Schwarz	SMT03	100059	11/2010
Climate Chamber	ESPEC	EL-10KA	05107008	11/2010

Maximum Transmitter Power & Spurious Emssion On Antenna Port				
Name of Equipment	Manufacturer	Model	Serial Number	Calibration Due
Receiver	Rohde&Schwarz	ESI 26	100009	11/2010
Attenuator	R&S	ESH3-22	100449	11/2010

Transient Frequency Behavior				
Name of Equipment	Manufacturer	Model	Serial Number	Calibration Due
Signal Generator	Rohde&Schwarz	SMT03	100059	11/2010
Storage Oscilloscope	Tektronix	TDS3054B	B033027	11/2010

## **4. TEST CONDITIONS AND RESULTS**

### **4.1. Conducted Emissions Test**

#### **TEST APPLICABLE**

The EUT was tested according to ANSI C63.4 - 2003. The frequency spectrum from 0.15 MHz to 30 MHz was investigated. The LISN used was 50 ohm / 50 u Henry as specified by section 5.1 of ANSI C63.4 - 2003. Cables and peripherals were moved to find the maximum emission levels for each frequency.

**Note: The EUT will not be operated during charging the battery with the power adapter.**

#### **TEST CONFIGURATION**

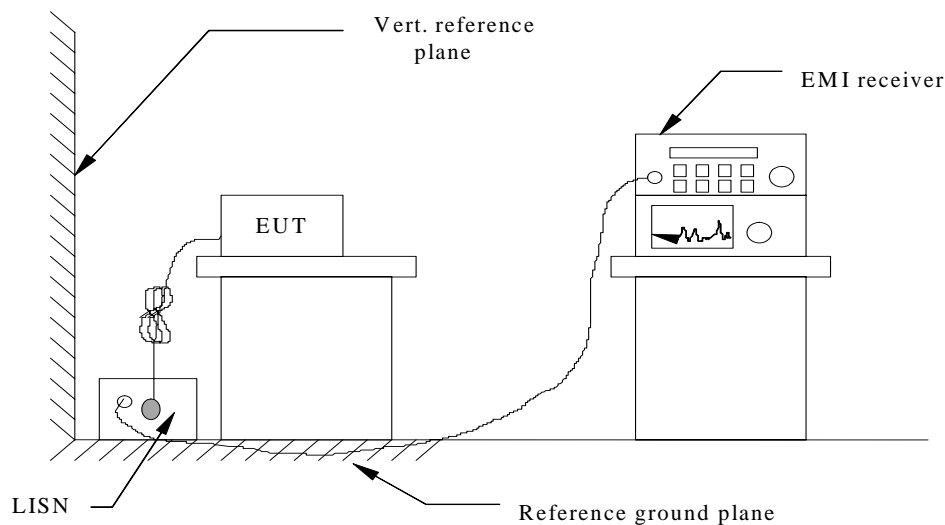

#### **TEST PROCEDURE**

- 1 The equipment was set up as per the test configuration to simulate typical actual usage per the user's manual. The EUT is a tabletop system, a wooden table with a height of 0.8 meters is used and is placed on the ground plane as per ANSI C63.4.
- 2 Support equipment, if needed, was placed as per ANSI C63.4.
- 3 All I/O cables were positioned to simulate typical actual usage as per ANSI C63.4.
- 4 If a EUT received DC power from the adapter, the adapter received AC120V/60Hz power through a Line Impedance Stabilization Network (LISN) which supplied power source and was grounded to the ground plane.
- 5 All support equipments received AC power from a second LISN, if any.
- 6 The EUT test program was started. Emissions were measured on each current carrying line of the EUT using a spectrum Analyzer / Receiver connected to the LISN powering the EUT. The LISN has two monitoring points: Line 1 (Hot Side) and Line 2 (Neutral Side). Two scans were taken: one with Line 1 connected to Analyzer / Receiver and Line 2 connected to a 50 ohm load; the second scan had Line 1 connected to a 50 ohm load and Line 2 connected to the Analyzer / Receiver.
- 7 Analyzer / Receiver scanned from 150 KHz to 30MHz for emissions in each of the test modes.
- 8 During the above scans, the emissions were maximized by cable manipulation.

**Conducted Power Line Emission Limit**

For unintentional device, according to § 15.107(a) Line Conducted Emission Limits is as following :

Frequency (MHz)	Maximum RF Line Voltage (dBµV)			
	CLASS A		CLASS B	
	Q.P.	Ave.	Q.P.	Ave.
0.15 - 0.50	79	66	66-56*	56-46*
0.50 - 5.00	73	60	56	46
5.00 - 30.0	73	60	60	50

\* Decreasing linearly with the logarithm of the frequency

For intentional device, according to §15.207(a) Line Conducted Emission Limit is same as above table.

**TEST RESULTS**

Not applicable (Since the EUT is powered by battery)

## 4.2. Occupied Bandwidth Test

### TEST APPLICABLE

- 1 According to FCC Part 90 Section 90.209: The authorized bandwidth shall be 11.25 KHz for 12.5 KHz and 20 KHz for 25 KHz.
- 2 For any frequency removed from the center of the authorized bandwidth  $f_0$  to 5.625 kHz removed from  $f_0$ , 0dB.
- 3 On any frequency removed from the center of the authorized bandwidth by a displacement frequency ( $f_d$  in kHz) of more than 5.626 kHz but no more than 12.5 kHz, at least 7.27 ( $f_d$  2.88 kHz) dB.
- 4 On any frequency removed from the center of the authorized bandwidth by a displacement frequency ( $f_d$  in kHz) of more than 12.5 kHz at least:  
 $50+10\log P=50+10\log (4.15) =56.40\text{dB}$
- 5 For 25 KHz:  
 $43+10\log (4.32) =49.35\text{dB}$

### TEST CONFIGURATION

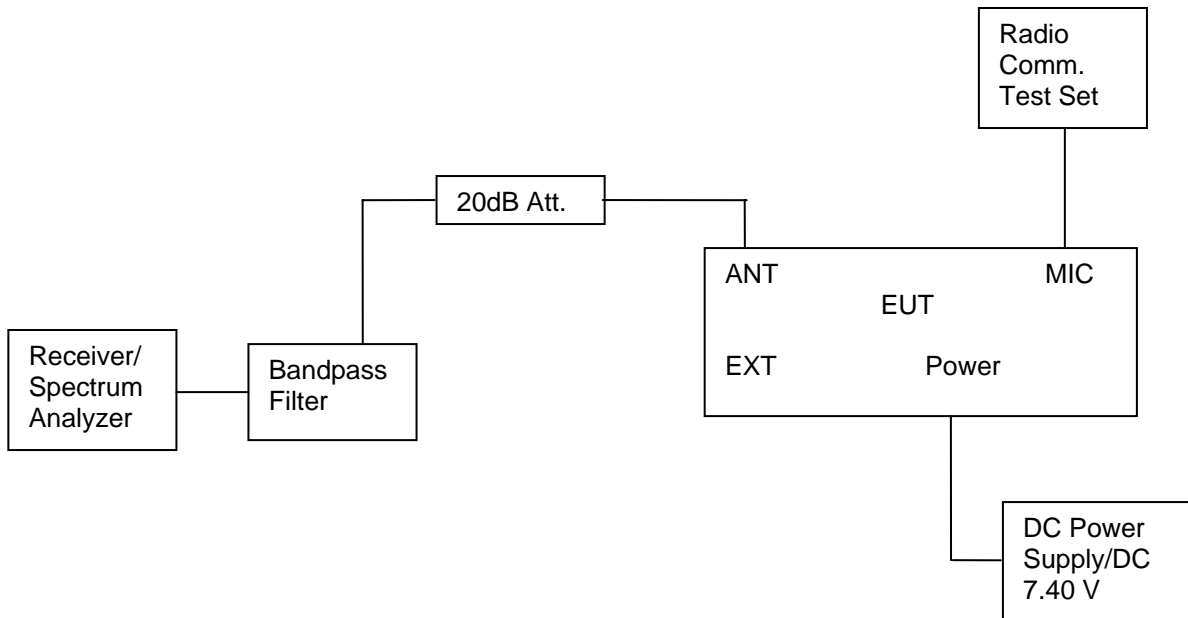

### TEST PROCEDURE

- 1 The EUT was placed on a turn table which is 0.8m above ground plane.
- 2 The EUT was modulated by 2.5 KHz Sine wave audio signal, The level of the audio signal employed is 16 dB greater than that necessary to produce 50% of rated system deviation. Rated system deviation is 2.5 kHz (12.5 kHz channel spacing) and 5 kHz (25 kHz channel spacing).
- 3 Set EUT as normal operation.
- 4 Set SPA Center Frequency = fundamental frequency, RBW=300Hz, VBW= 3 KHz, span =50 KHz.
- 5 Set SPA Max hold. Mark peak, Set 99% Occupied Bandwidth and 26dB Occupied Bandwidth.

### TEST RESULTS

99% Bandwidth Measurement Result						
Operation Frequency	12.5 KHz Channel Separation			25KHz Channel Separation		
	Test Data	Limits	Result	Test Data	Limits	Result
Bottom Channel	5.60KHz	11.25KHz	Pass	10.50KHz	20.00KHz	Pass
Middle Channel	5.60KHz	11.25KHz	Pass	10.50KHz	20.00KHz	Pass
Top Channel	5.60KHz	11.25KHz	Pass	10.60KHz	20.00KHz	Pass

26dB Bandwidth Measurement Result						
Operation Frequency	12.5 KHz Channel Separation			25KHz Channel Separation		
	Test Data	Limits	Result	Test Data	Limits	Result
Bottom Channel	10.30KHz	11.25KHz	Pass	15.50KHz	20.00KHz	Pass
Middle Channel	10.30KHz	11.25KHz	Pass	15.50KHz	20.00KHz	Pass
Top Channel	10.40KHz	11.25KHz	Pass	15.60KHz	20.00KHz	Pass

**Photos of 99% and 26dB Bandwidth Measurement**

**For 25KHz:**

**Top Channel**

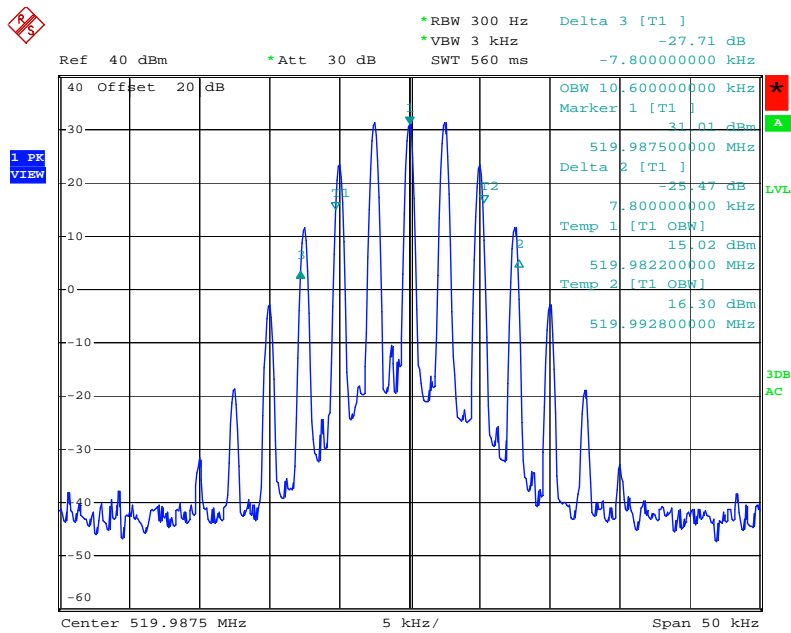

Date: 13.NOV.2009 21:47:48

## Middle Channel

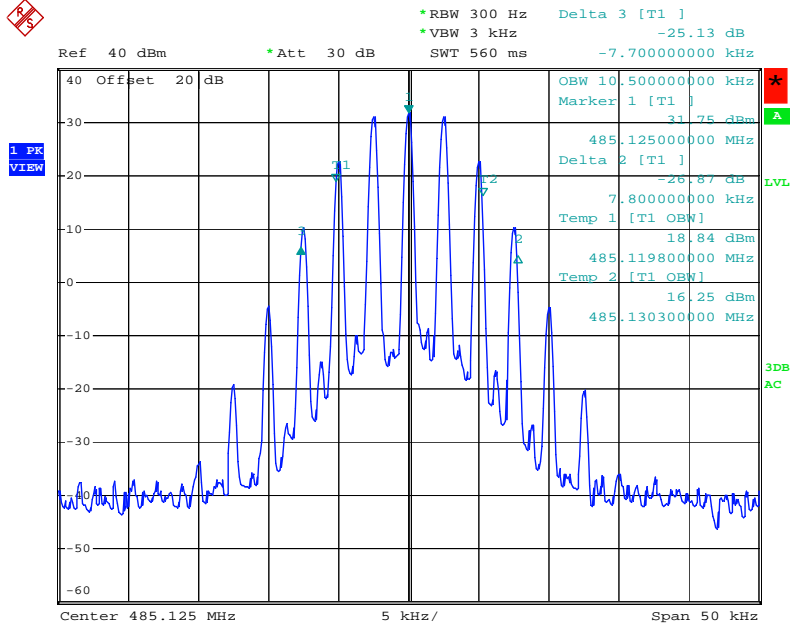

Date: 13.NOV.2009 21:43:35

## Bottom Channel

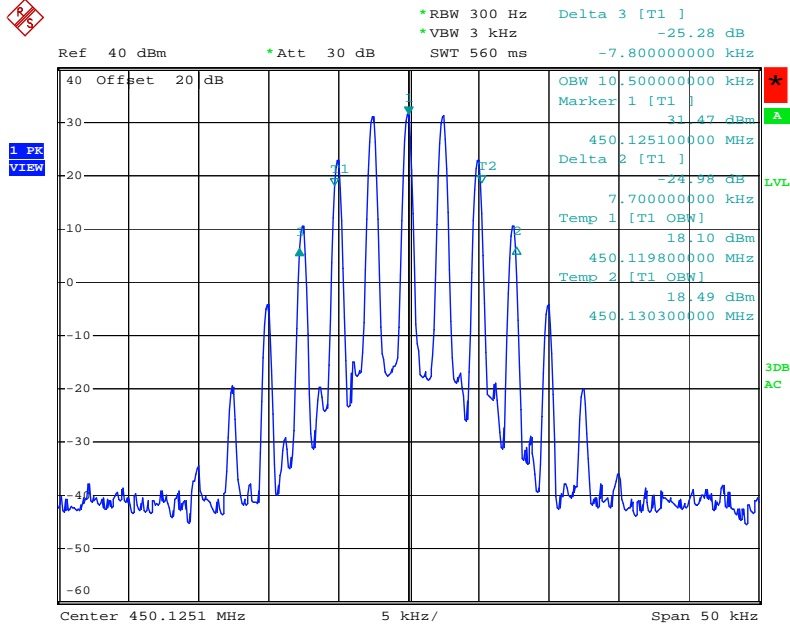

Date: 13.NOV.2009 21:34:59

For 12.5KHz:

### Top Channel

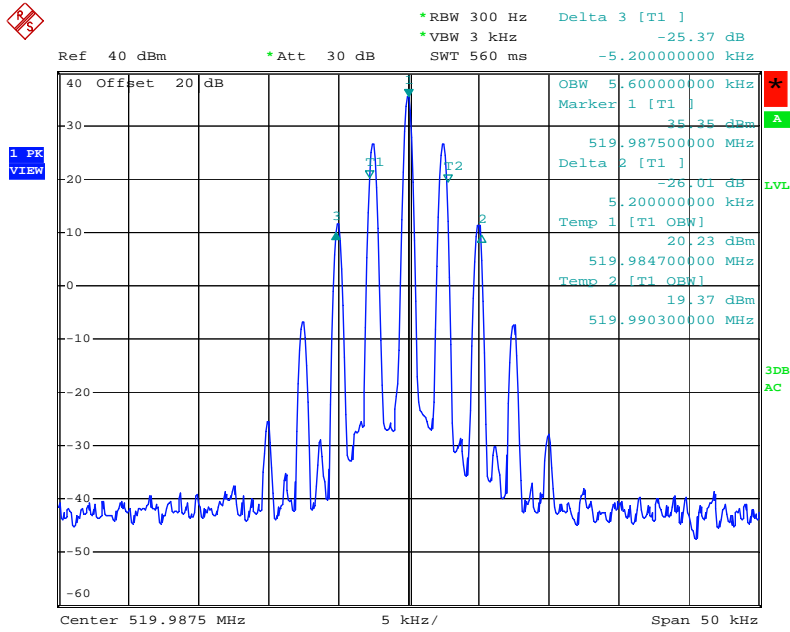

Date: 13.NOV.2009 21:48:30

### Middle Channel

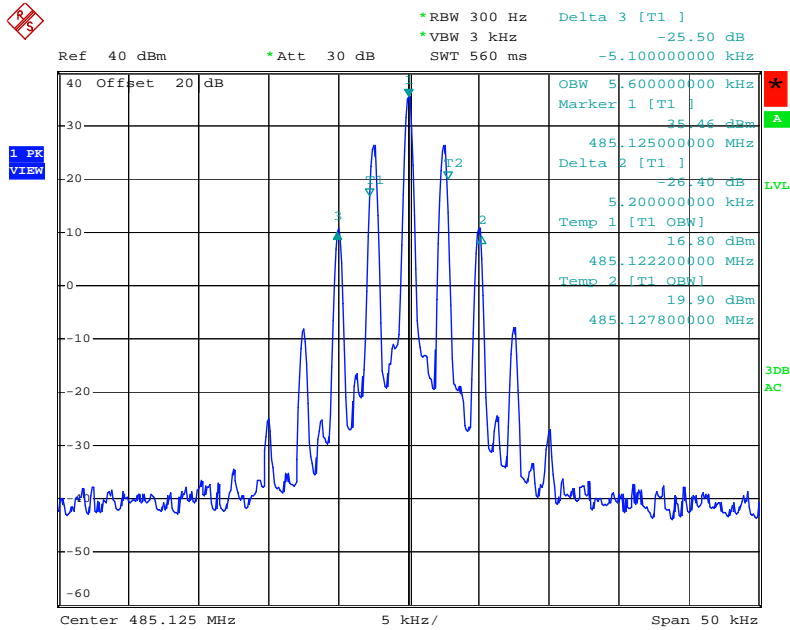

Date: 13.NOV.2009 21:42:44



# Bottom Channel



\*RBW 300 Hz    Delta 3 [T1 ]  
 \*VBW 3 kHz        -26.14 dB  
 SWT 560 ms        -5.200000000 kHz

Ref 40 dBm    \*Att 30 dB

1 PK  
 VIEW

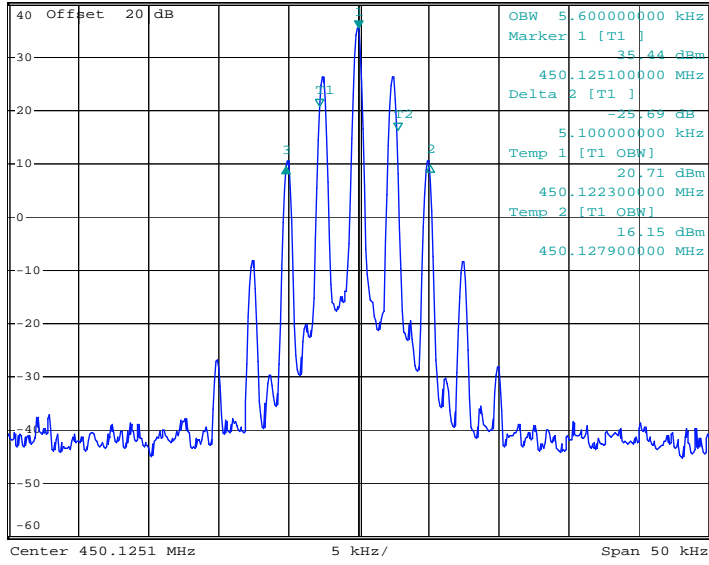

✖

▲

LVL

3DB

AC

Date: 13.NOV.2009 21:33:51

**Photos of Occupied Bandwidth Measurement**

Referred as the attached plot hereinafter

Note: The blue curve represents unmodulated signal.

The black curve represents modulated signal.

**For 25 KHz:**

***Occupied Bandwidth of Top Channel***

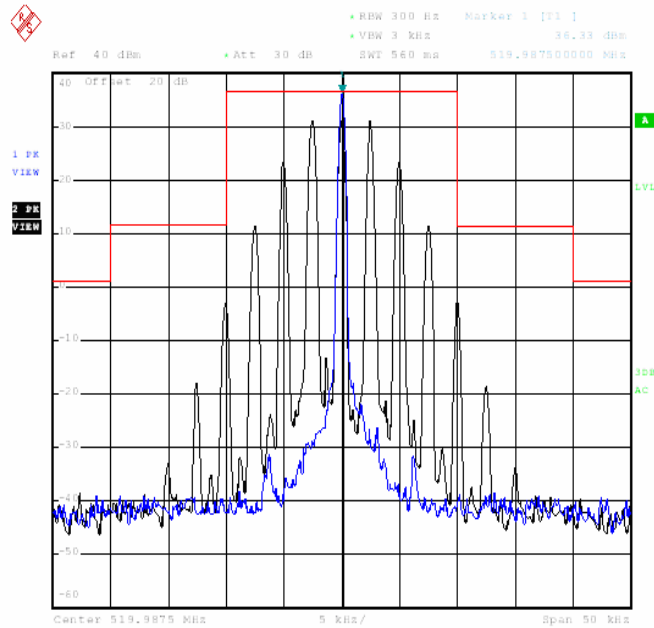

Date: 13.NOV.2009 21:46:59

25 kHz Channel Spacing, 519.9875 MHz, 2500 Hz Audio Modulation Only

## Occupied Bandwidth of Middle Channel

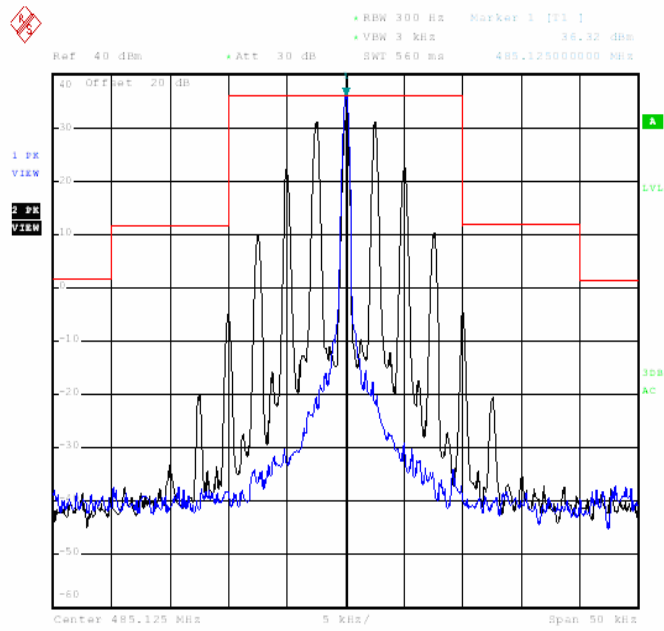

Date: 13.NOV.2009 21:44:43

25 kHz Channel Spacing, 485.1250 MHz, 2500 Hz Audio Modulation Only

## Occupied Bandwidth of Bottom Channel

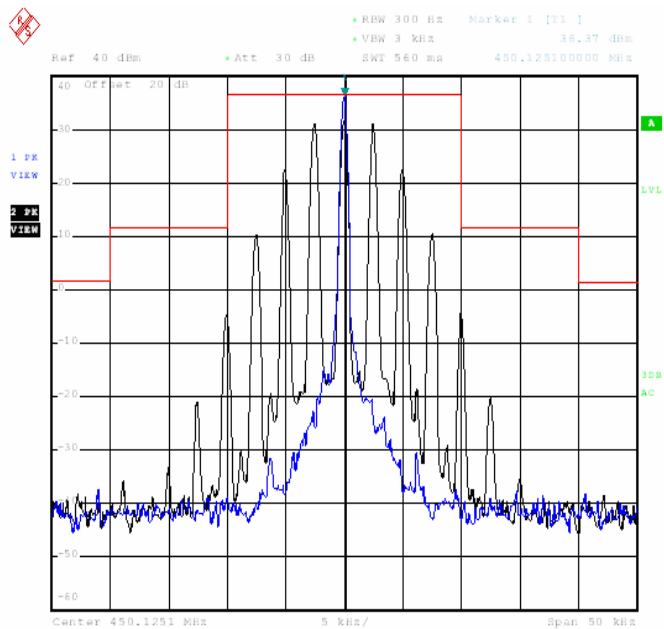

Date: 13.NOV.2009 21:32:13

25 kHz Channel Spacing, 450.1250MHz, 2500 Hz Audio Modulation Only

For 12.5 KHz

### Occupied Bandwidth of Top Channel

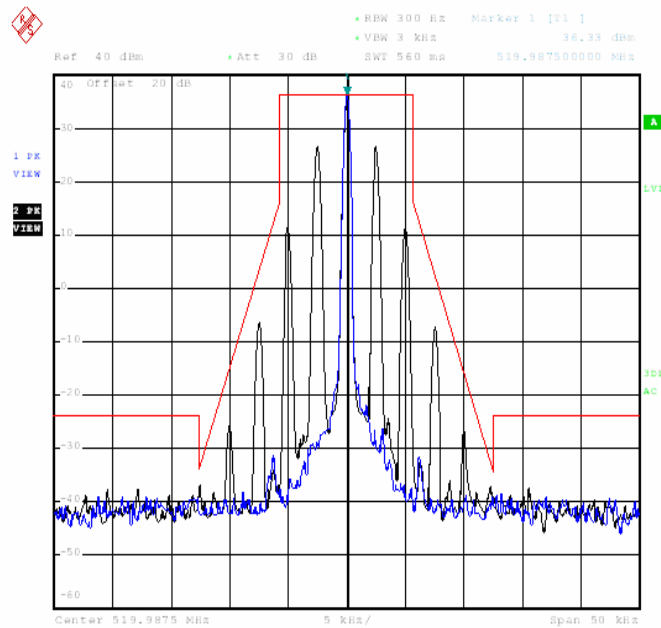

Date: 13.NOV.2009 21:46:28

12.5 kHz Channel Spacing, 519.9875MHz, 2500 Hz Audio Modulation Only

### Occupied Bandwidth of Middle Channel

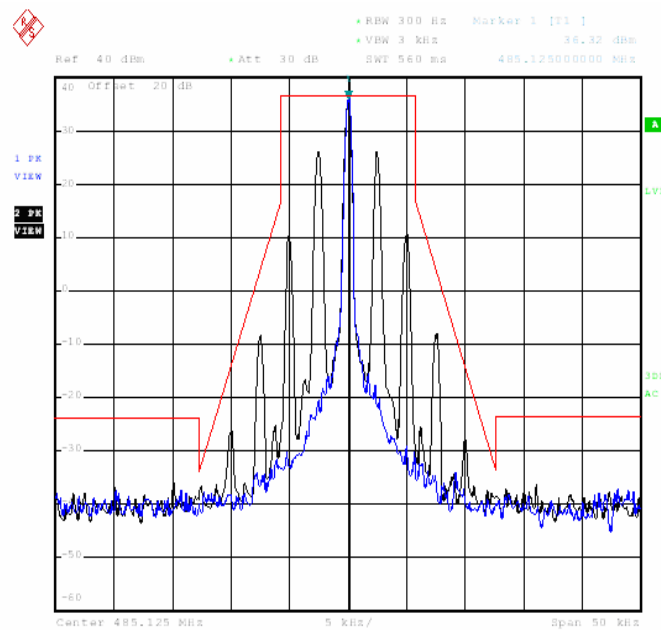

Date: 13.NOV.2009 21:45:14

12.5 kHz Channel Spacing, 485.1250 MHz, 2500 Hz Audio Modulation Only

## Occupied Bandwidth of Bottom Channel

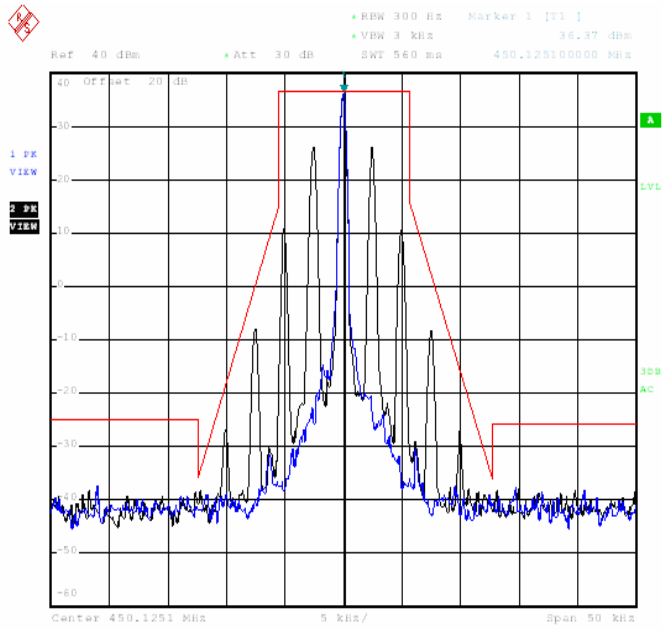

Date: 13.NOV.2009 21:32:53

12.5 kHz Channel Spacing, 450.1250 MHz, 2500 Hz Audio Modulation Only

### 4.3. Transmitter Radiated Spurious Emission

#### TEST APPLICABLE

According to the TIA/EIA 603 test method, and according to Section 90.210, the power of each unwanted emission shall be less than Transmitted Power as specified below for transmitters designed to operate with 12.5 KHz channel bandwidth:

- 1 On any frequency removed from the center of the authorized bandwidth  $f_0$  to 5.625 KHz removed from  $f_0$ : Zero dB
- 2 On any frequency removed from the center of the authorized bandwidth by a displacement frequency ( $f_d$  in KHz)  $f_0$  of more than 5.625 KHz but no more than 12.5 KHz: At least 7.27dB
- 3 On any frequency removed from the center of the authorized bandwidth by a displacement frequency ( $f_d$  in KHz)  $f_0$  of more than 12.5 KHz: At least  $50 + 10 \log(P)$  dB or 70 dB, which ever is lesser attenuation.

For transmitters designed to transmit with 25 KHz channel separation and equipped with an audio low-pass filter, the power of any emission must be attenuated below the unmodulated carrier power (P) as following:

- 1 On any frequency removed from the assigned frequency by more than 50 percent, but no more than 100 percent of the authorized bandwidth: At least 25 dB.
- 2 On any frequency removed from the assigned frequency by more than 100 percent, but no more than 250 percent of the authorized bandwidth: At least 35 dB.
- 3 On any frequency removed from the assigned frequency by more than 250 percent of the authorized bandwidth: At least  $43 + 10 \log(P)$  dB.

#### TEST CONFIGURATION

Below 1GHz

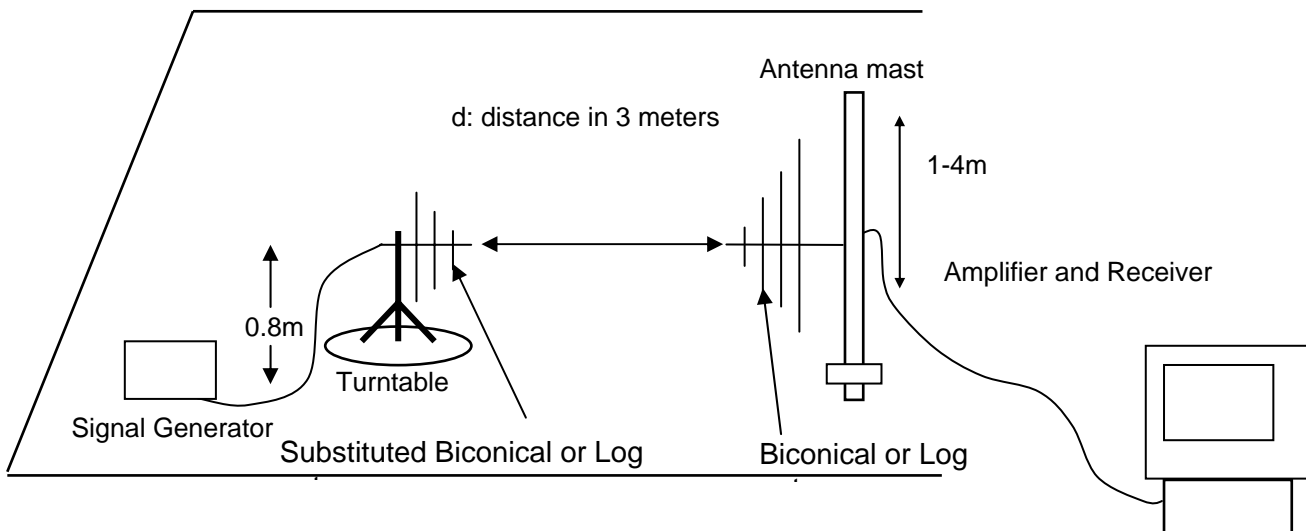
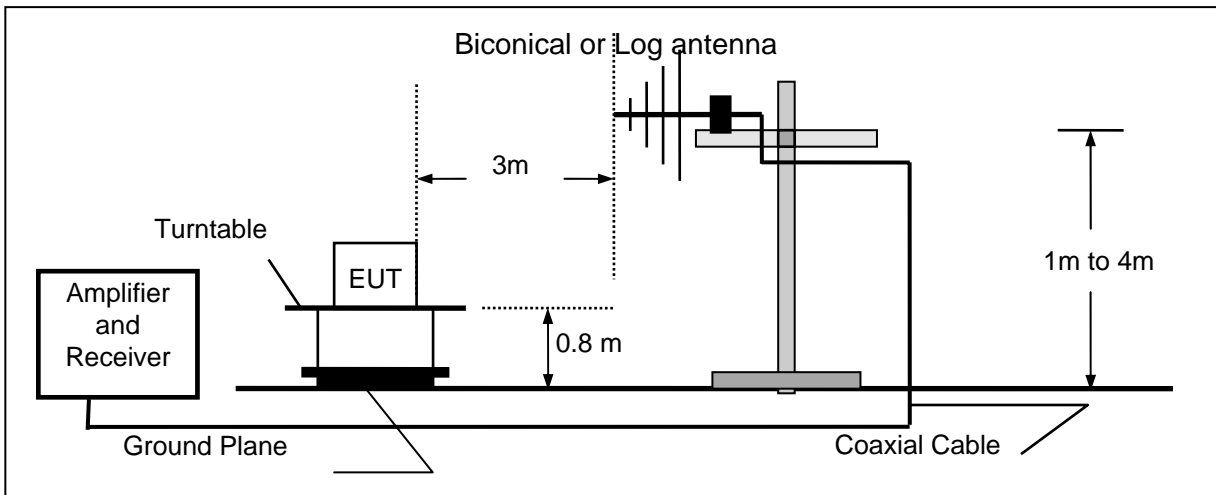

## Above 1GHz

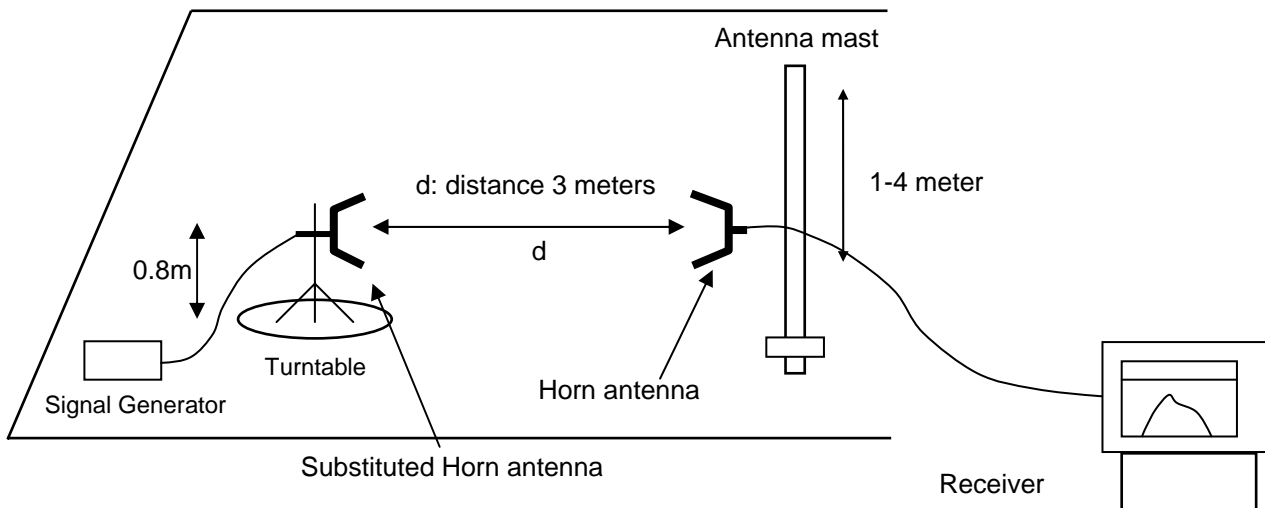
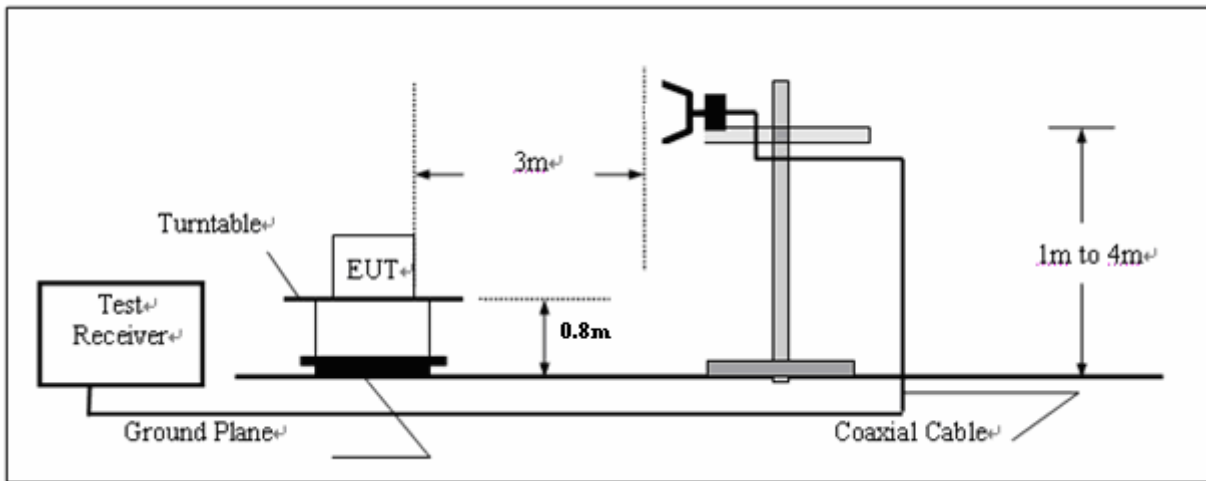

### **TEST PROCEDURE**

- 1 On a test site, the EUT shall be placed on a turntable, and in the position closest to the normal use as declared by the user.
- 2 The test antenna shall be oriented initially for vertical polarization located 3m from the EUT to correspond to the transmitter.
- 3 The output of the antenna shall be connected to the measuring receiver and either a peak or quasi-peak detector was used for the measurement as in dicated on the report. The detector selection is based on how close the emission level was approaching the limit.
- 4 The transmitter shall be switched on; if possible, without the modulation and the measurement receiver shall be tuned to the frequency of the transmitter under test.
- 5 The test antenna shall be raised and lowered through the specified range of height until the measuring receiver detects a maximum signal level.
- 6 The transmitter shall than be rotated through 360° in the horizontal plane, until the maximum signal level is detected by the measuring receiver.
- 7 The test antenna shall be raised and lowered again through the specified range of height until the measuring receiver detects a maximum signal level.
- 8 The maximum signal level detected by the measuring receiver shall be noted.
- 9 The measurement shall be repeated with the test antenna set to horizontal polarization.
- 10 Replace the antenna with a proper Antenna (substitution antenna).
- 11 The substitution antenna shall be oriented for vertical polarization and, if necessary, the length of the substitution antenna shall be adjusted to correspond to the frequency of transmitting.
- 12 The substitution antenna shall be connected to a calibrated signal generator.

- 13 If necessary, the input attenuator setting of the measuring receiver shall be adjusted in order to increase the sensitivity of the measuring receiver.
- 14 The test antenna shall be raised and lowered through the specified range of the height to ensure that the maximum signal is received.
- 15 The input signal to substitution antenna shall be adjusted to the level that produces a level detected by the measuring receiver, that is equal to the level noted while the transmitter radiated power was measured, corrected for the change of input attenuation setting of the measuring receiver.
- 16 The input level to the substitution antenna shall be recorded as power level in dBm, corrected for any change of input attenuator setting of the measuring receiver.
- 17 The measurement shall be repeated with the test antenna and the substitution antenna oriented for horizontal polarization

**TEST RESULTS**

FCC Part 22.359, 74.462, 80.211 and 90.210 (25 kHz bandwidth only):

On any frequency removed from the center of the assigned channel by more than 250 percent at least:

Low:  $43 + 10 \log (P_{\text{watts}}) = 43 + 10 \log (3.55) = 48.50 \text{ dB}$

High:  $43 + 10 \log (P_{\text{watts}}) = 43 + 10 \log (4.32) = 49.35 \text{ dB}$

FCC Part 90.210 (12.5 kHz Bandwidth only):

On any frequency removed from the center of the authorized bandwidth by a displacement frequency (f d in kHz) of more than 12.5 kHz at least:

Low:  $50 + 10 \log (P_{\text{watts}}) = 50 + 10 \log (3.59) = 55.55 \text{ dB}$

High:  $50 + 10 \log (P_{\text{watts}}) = 50 + 10 \log (4.37) = 56.40 \text{ dB}$

Note: In general, the worse case attenuation requirement shown above was applied.

For 25 KHz

Calculation:  $\text{Limit (dBm)} = \text{EL} - 43 - 10 \log_{10} (\text{TP})$

Notes: EL is the emission level of the Output Power expressed in dBm,

In this application, the EL is 36.02 dBm.

$\text{Limit (dBm)} = 36.02 - 43 - 10 \log_{10} (4.32) = -13 \text{ dBm}$

**The Channel 03**

Frequency (MHz)	Reading level (dBm)	Antenna Polarization	Transd (dB)	Emission level (dBm)	Limit (dBm)	Margin (dB)
1039.98	-39.21	H	2.07	-37.14	-13	-24.14
3119.93	-45.57	H	11.62	-33.95	-13	-20.95
3639.91	-41.72	H	12.26	-29.46	-13	-16.46
***	--	H		--	-13	
1039.98	-34.03	V	2.07	-31.96	-13	-18.96
3119.93	-42.44	V	11.62	-30.82	-13	-17.82
3639.91	-41.85	V	12.26	-29.59	-13	-16.59
***	--	V		--	-13	



### The Channel 02

Frequency (MHz)	Reading level (dBm)	Antenna Polarization	Transd (dB)	Emission level (dBm)	Limit (dBm)	Margin (dB)
1455.38	-44.18	H	3.68	-40.50	-13	-27.50
2910.75	-48.21	H	9.99	-38.22	-13	-25.22
3395.88	-44.29	H	11.82	-32.47	-13	-12.47
***	--	H		--	-13	
1455.38	-40.07	V	3.68	-36.39	-13	-23.39
2910.75	-49.81	V	9.99	-39.82	-13	-26.82
3395.88	-39.58	V	11.82	-27.76	-13	-7.76
***	--	V		--	-13	

### The Channel 01

Frequency (MHz)	Reading level (dBm)	Antenna Polarization	Transd (dB)	Emission level (dBm)	Limit (dBm)	Margin (dB)
1350.38	-36.75	H	3.20	-33.55	-13	-20.55
1800.50	-39.58	H	5.88	-33.70	-13	-20.70
3150.88	-42.85	H	10.69	-32.16	-13	-19.16
***	--	H		--	-13	
1350.38	-36.47	V	3.20	-33.27	-13	-20.27
3150.88	-46.84	V	10.69	-36.15	-13	-23.15
3601.00	-48.94	V	12.20	36.74	-13	-23.74
***	--	V		--	-13	

**\*Note:**

\*\*\* means that the emission level is too low to be measured or at least 20 dB down than the limit.

For 12.5 KHz

Calculation: Limit (dBm) =EL-50-10log10 (TP)

Notes: EL is the emission level of the Output Power expressed in dBm,

In this application, the EL is 36.02 dBm.

Limit (dBm) =36.02-50-10log10 (4.37) = -20 dBm

### The Channel 07

Frequency (MHz)	Reading level (dBm)	Antenna Polarization	Transd (dB)	Emission level (dBm)	Limit (dBm)	Margin (dB)
1039.98	-39.14	H	2.07	-37.07	-20	-17.07
3119.93	-45.77	H	11.62	-34.15	-20	-14.15
3639.91	-42.24	H	12.26	-29.98	-20	-9.98
***	--	H		--	-20	
1039.98	-36.14	V	2.07	-34.07	-20	-14.07
3119.93	-42.31	V	11.62	-30.69	-20	-10.69
3639.91	-40.70	V	12.26	-28.44	-20	-8.44
***	--	V		--	-20	

### The Channel 06

Frequency (MHz)	Reading level (dBm)	Antenna Polarization	Transd (dB)	Emission level (dBm)	Limit (dBm)	Margin (dB)
1455.38	-44.62	H	3.68	-40.94	-20	-20.94
2910.75	-49.80	H	9.99	-39.81	-20	-19.81
3395.88	-44.10	H	11.82	-32.28	-20	-12.28
***	--	H		--	-20	
1455.38	-38.93	V	3.68	-35.25	-20	-15.25
2910.75	-49.74	V	9.99	-39.75	-20	-19.75
3395.88	-38.55	V	11.82	-26.73	-20	-6.73
***	--	V		--	-20	

### The Channel 05

Frequency (MHz)	Reading level (dBm)	Antenna Polarization	Transd (dB)	Emission level (dBm)	Limit (dBm)	Margin (dB)
1350.38	-37.96	H	3.20	-34.76	-20	-14.76
3150.88	-45.71	H	10.69	-35.02	-20	-15.02
3601.00	-47.82	H	12.20	-35.62	-20	-15.62
***	--	H		--	-20	
1350.38	-36.76	V	3.20	-33.56	-20	-13.56
3150.88	-45.51	V	10.69	-34.82	-20	-14.82
3601.00	-48.93	V	12.20	-36.73	-20	-16.73
***	--	V		--	-20	

**\*Note:**

\*\*\* means that the emission level is too low to be measured or at least 20 dB down than the limit.

#### 4.4. Spurious Emission On Antenna Port

##### TEST APPLICABLE

The same as Section 4.3

##### TEST PROCEDURE

The RF output of the EUT was connected to a spectrum analyzer through appropriate attenuation. The resolution bandwidth of the spectrum analyzer was set to 100 kHz. Sufficient scans were taken to show any out of band emission up to 10th. Harmonic for the lower and the highest frequency range. RBW 100 kHz, VBW 300 kHz,

The audio input was set to 0 to get the unmodulated carrier, the resulting picture is print out for each channel separation.

##### TEST CONFIGURATION

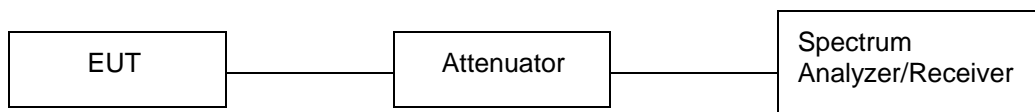

The EUT was directly connected to a RF Communication Test Set by a 20 dB attenuator

##### TEST RESULTS

FCC Part 22.359, 74.462, 80.211 and 90.210 and RSS Gen, RSS 119 Issue 9 (25 kHz bandwidth only):  
On any frequency removed from the center of the assigned channel by more than 250 percent at least:

Low:  $43 + 10 \log(\text{Pwatts}) = 43 + 10 \log(3.55) = 48.50 \text{ dB}$

High:  $43 + 10 \log(\text{Pwatts}) = 43 + 10 \log(4.32) = 49.35 \text{ dB}$

Calculation: Limit (dBm) =  $\text{EL} - 43 - 10 \log_{10}(\text{TP})$

Notes: EL is the emission level of the Output Power expressed in dBm,  
In this application, the EL is 36.02 dBm.

Limit (dBm) =  $36.02 - 43 - 10 \log_{10}(4.32) = -13 \text{ dBm}$

FCC Part 90.210 (12.5 kHz Bandwidth only):

On any frequency removed from the center of the authorized bandwidth by a displacement frequency (f d in kHz) of more than 12.5 kHz at least:

Low:  $50 + 10 \log(\text{Pwatts}) = 50 + 10 \log(3.59) = 55.55 \text{ dB}$

High:  $50 + 10 \log(\text{Pwatts}) = 50 + 10 \log(4.37) = 56.40 \text{ dB}$

Note: In general, the worse case attenuation requirement shown above was applied.

Calculation: Limit (dBm) =  $\text{EL} - 50 - 10 \log_{10}(\text{TP})$

Notes: EL is the emission level of the Output Power expressed in dBm,  
In this application, the EL is 36.02 dBm.

Limit (dBm) =  $36.02 - 50 - 10 \log_{10}(4.37) = -20 \text{ dBm}$

Note: 1. In general, the worse case attenuation requirement shown above was applied.

2. The measurement frequency range from 30MHz to 6GHz.

**For 25 KHz**

Product : Two-Way Radio Test Mode : 519.9875MHz  
 Test Item : Spurious Emission on Antenna Port Temperature : 25 °C  
 Test Voltage : DC 7.40V (External Power Supply) Humidity : 56%RH  
 Test Result : **PASS**

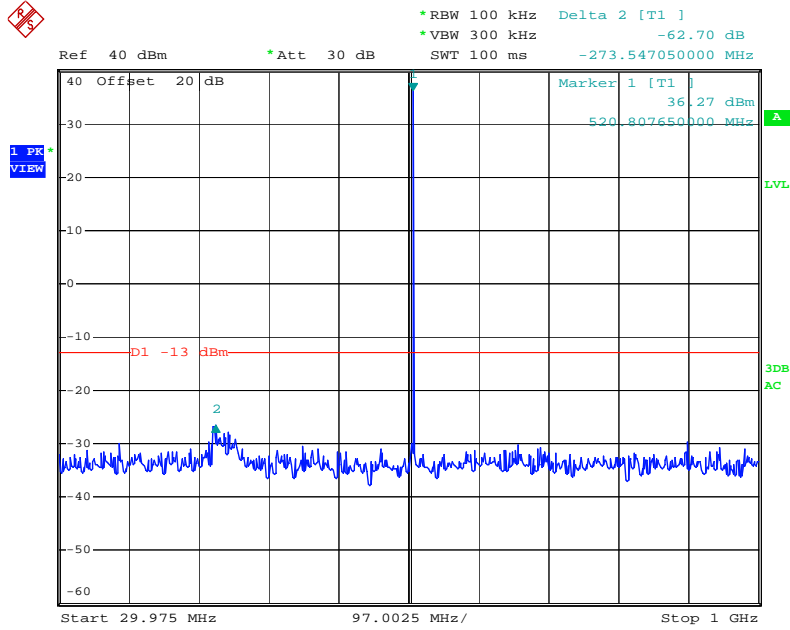

Date: 13.NOV.2009 21:52:32

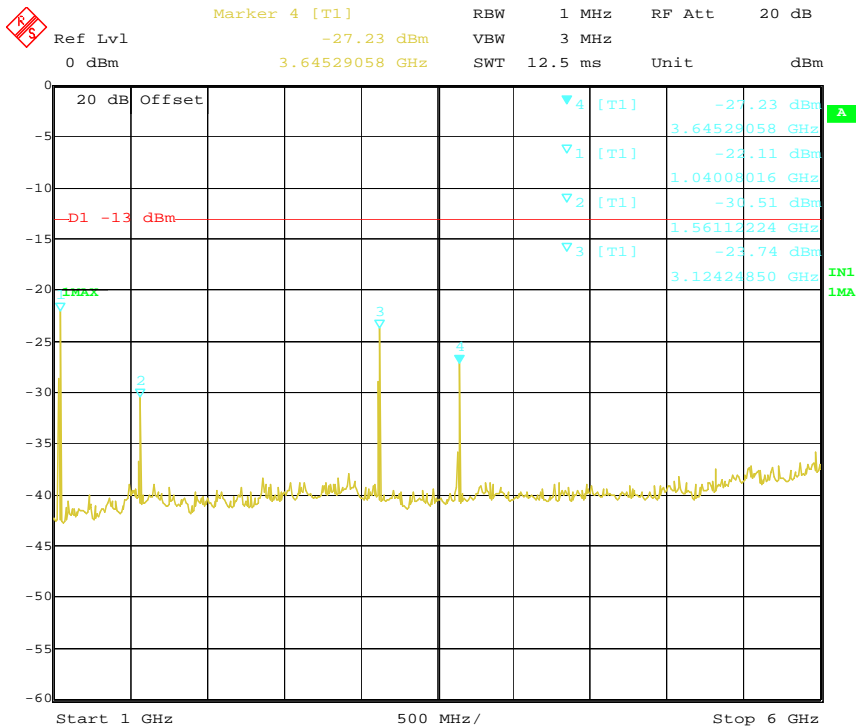

Date: 13.NOV.2009 22:12:10

Product : Two-Way Radio                      Test Mode : 485.1250MHz  
 Test Item : Spurious Emission on Antenna Port Temperature : 25 °C  
 Test Voltage : DC 7.40V (External Power Supply) Humidity : 56%RH  
 Test Result : **PASS**

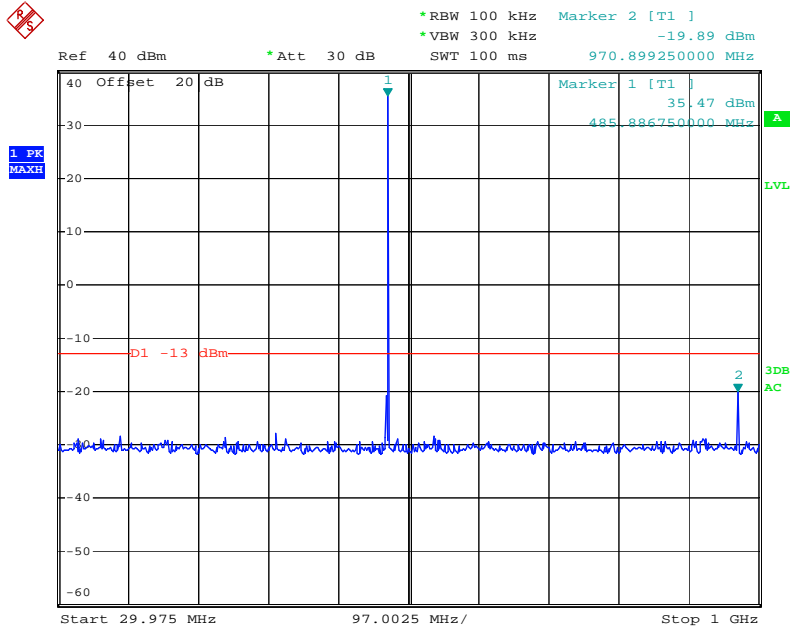

Date: 13.NOV.2009 21:51:43

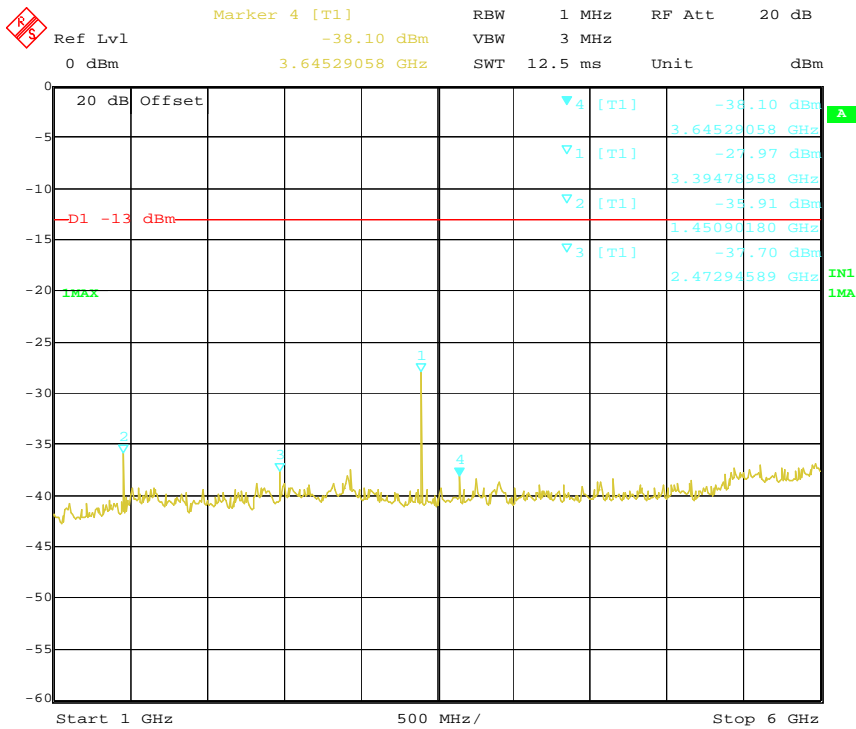

Date: 13.NOV.2009 22:11:07

Product : Two-Way Radio                      Test Mode : 450.1250MHz  
 Test Item : Spurious Emission on Antenna Port    Temperature : 25 °C  
 Test Voltage : DC 7.40V (External Power Supply)    Humidity : 56%RH  
 Test Result : **PASS**

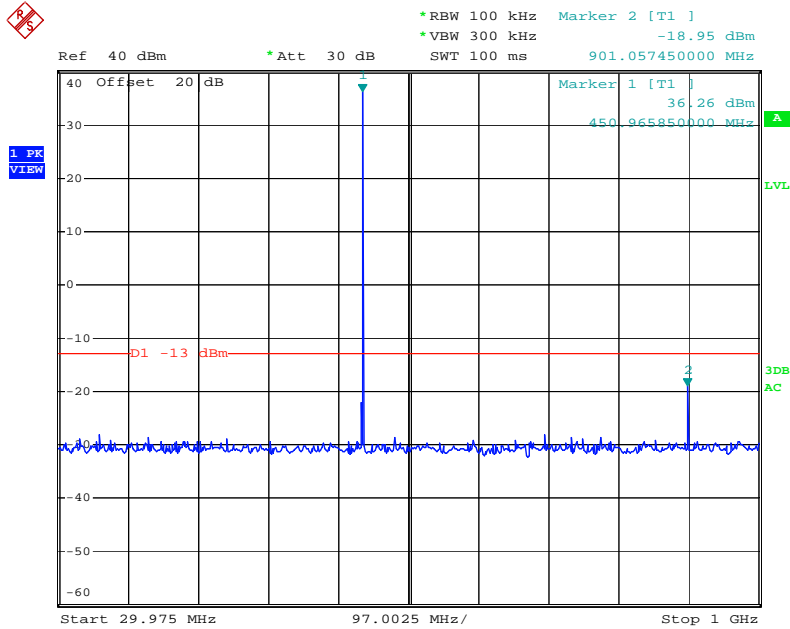

Date: 13.NOV.2009 21:51:16

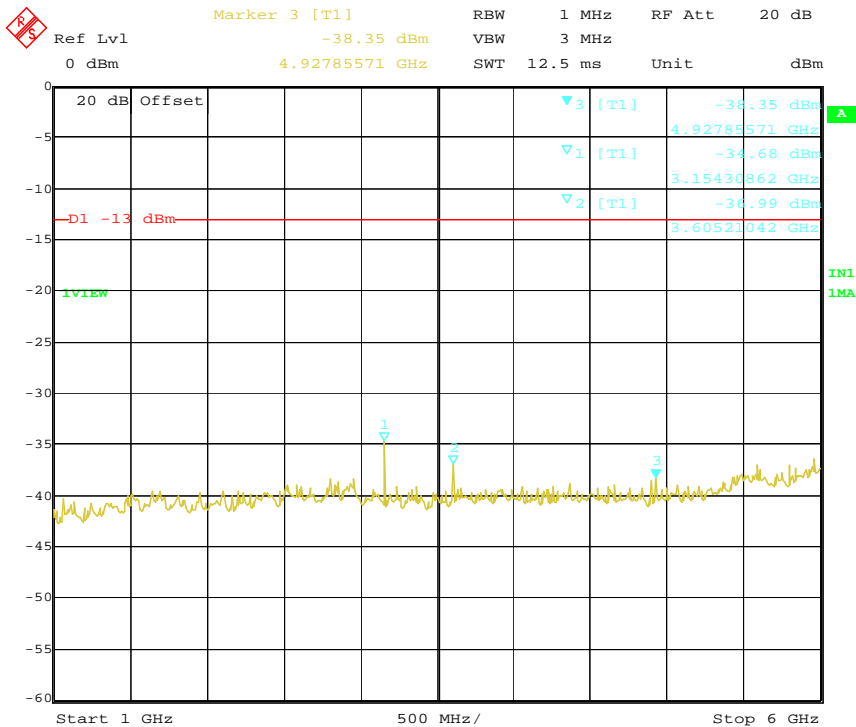

Date: 13.NOV.2009 22:10:02

**For 12.5 KHz**

Product : Two-Way Radio Test Mode : 519.9875MHz  
 Test Item : Spurious Emission on Antenna Port Temperature : 25 °C  
 Test Voltage : DC 7.40V (External Power Supply) Humidity : 56%RH  
 Test Result : **PASS**

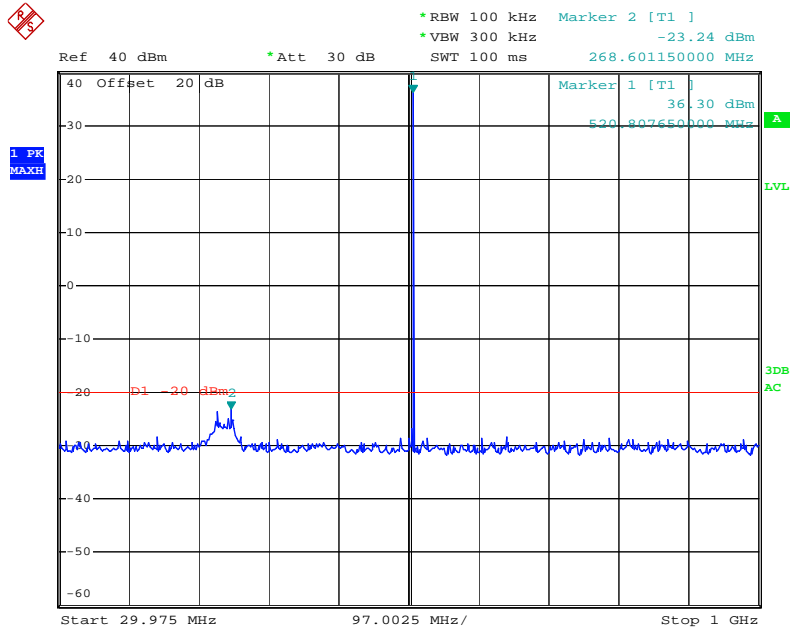

Date: 13.NOV.2009 21:54:21

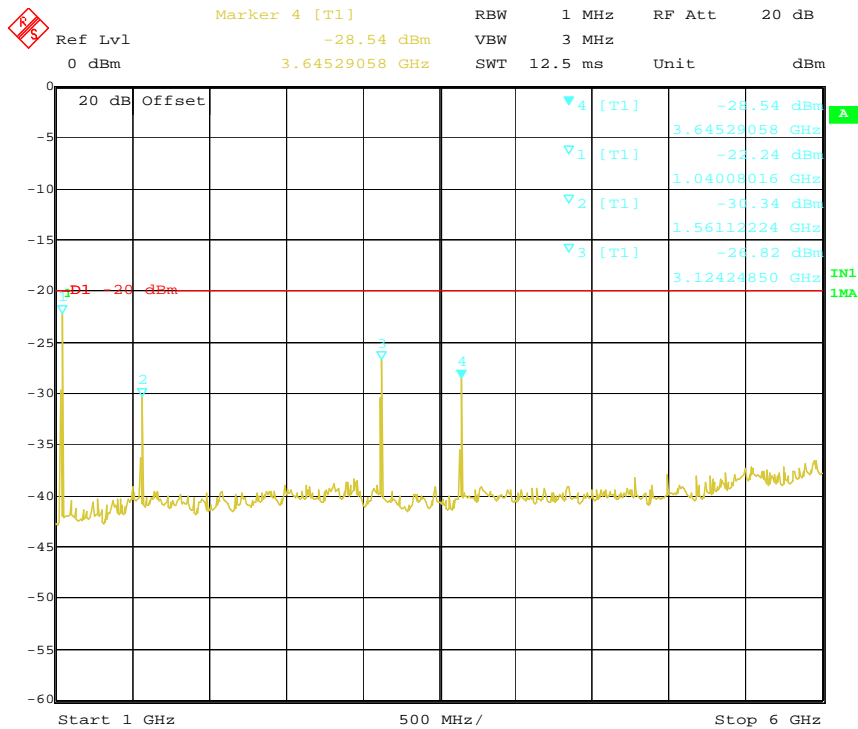

Date: 13.NOV.2009 22:15:11



Product : Two-Way Radio                      Test Mode : 485.1250MHz  
 Test Item : Spurious Emission on Antenna Port Temperature : 25 °C  
 Test Voltage : DC 7.40V (External Power Supply) Humidity : 56%RH  
 Test Result : **PASS**

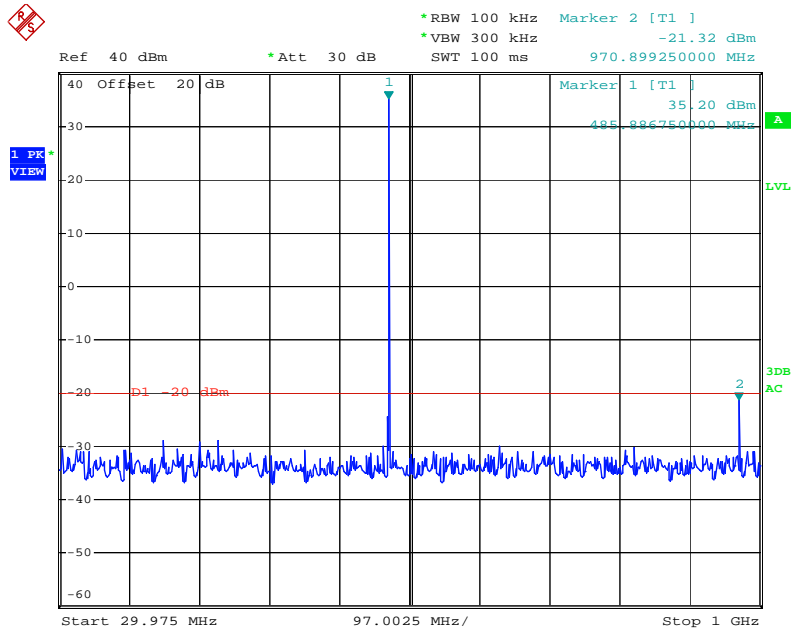

Date: 13.NOV.2009 21:53:36

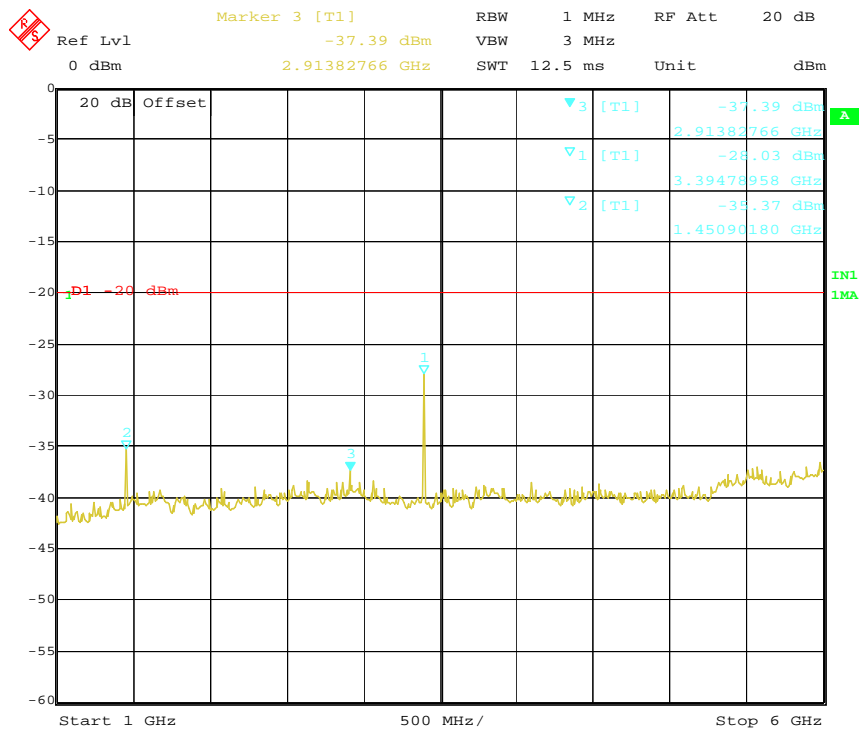

Date: 13.NOV.2009 22:14:11

Product : Two-Way Radio                      Test Mode : 450.1250MHz  
 Test Item : Spurious Emission on Antenna Port Temperature : 25 °C  
 Test Voltage : DC 7.40V (External Power Supply) Humidity : 56%RH  
 Test Result : **PASS**

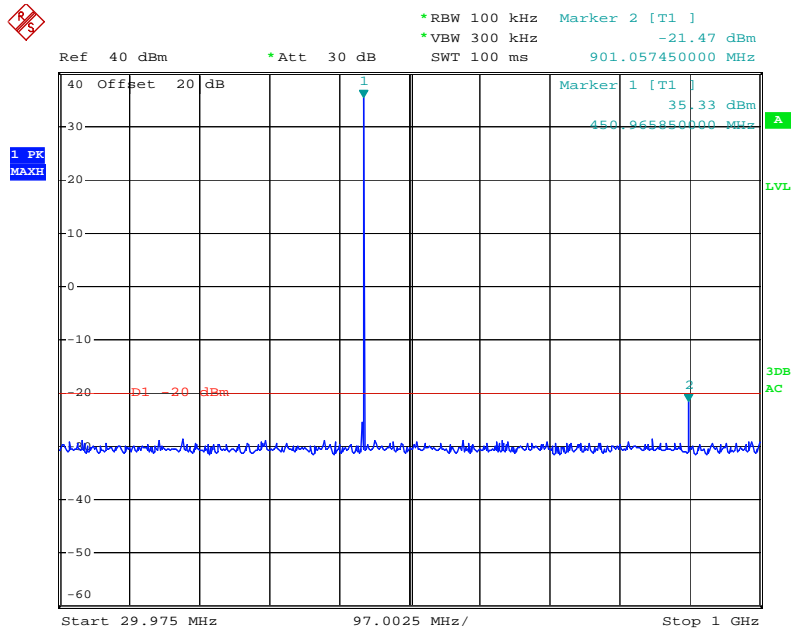

Date: 13.NOV.2009 21:53:08

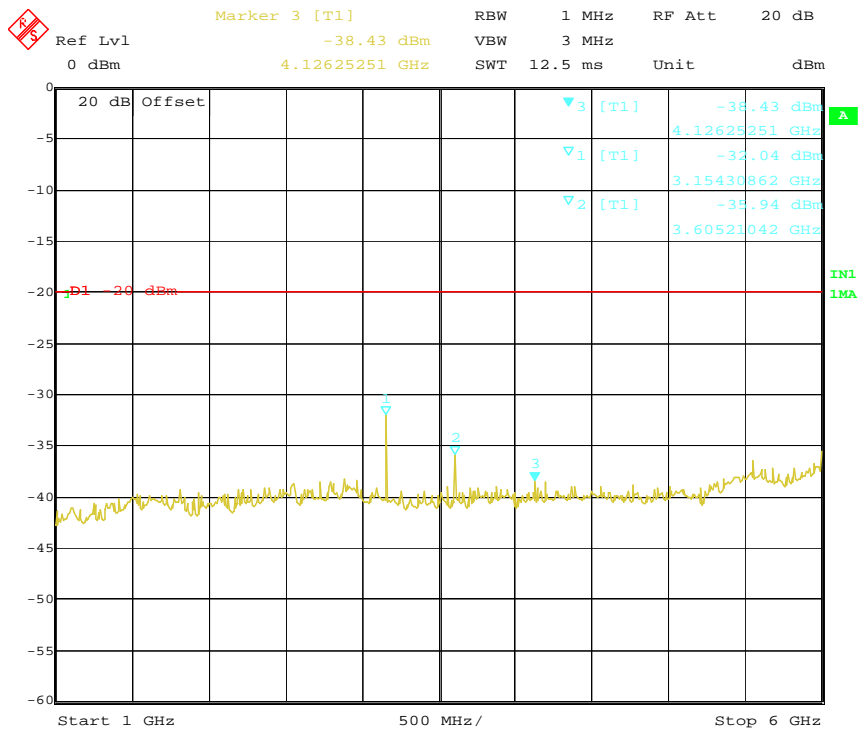

Date: 13.NOV.2009 22:16:14

## 4.5. Modulation Characteristics

### TEST APPLICABLE

According to CFR47 section 2.1047(a), for Voice Modulation Communication Equipment, the frequency response of the audio modulation circuit over a range of 100 to 5000Hz shall be measured.

### TEST PROCEDURE

#### Modulation Limit

- 1 Configure the EUT as shown in figure 1, adjust the audio input for 60% of rated system deviation at 1 KHz using this level as a reference (0dB) and vary the input level from -20 to +20dB. Record the frequency deviation obtained as a function of the input level.
- 2 Repeat step 1 with input frequency changing to 300, 1004, and 2500Hz in sequence.

#### Audio Frequency Response

- 1 Configure the EUT as shown in figure 1.
- 2 Adjust the audio input for 20% of rated system deviation at 1 KHz using this level as a reference (0dB).
- 3 Vary the Audio frequency from 100 Hz to 10 KHz and record the frequency deviation.
- 4 Audio Frequency Response =  $20\log_{10}$  (Deviation of test frequency / Deviation of 1 KHz reference).

### TEST CONFIGURATION

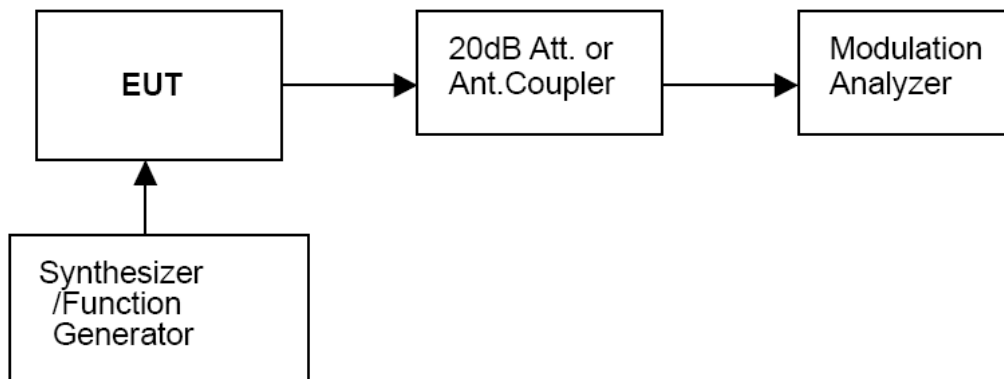

### TEST RESULTS

#### 25 KHz Channel Separation

Modulation Level(dB)	Peak Freq. Deviation At 300 Hz(KHz)	Peak Freq. Deviation At 1004 Hz(KHz)	Peak Freq. Deviation At 1500 Hz(KHz)	Peak Freq. Deviation At 2500 Hz(KHz)
-20	0.62	0.99	1.41	2.43
-15	0.88	1.96	2.29	3.45
-10	1.29	2.84	3.63	3.58
-5	1.57	3.53	4.08	3.76
0	1.69	3.78	4.10	3.98
+5	1.78	3.97	4.16	4.08
+10	1.87	4.10	4.16	4.08
+15	2.03	4.22	4.22	4.08
+20	2.15	4.35	4.22	4.08

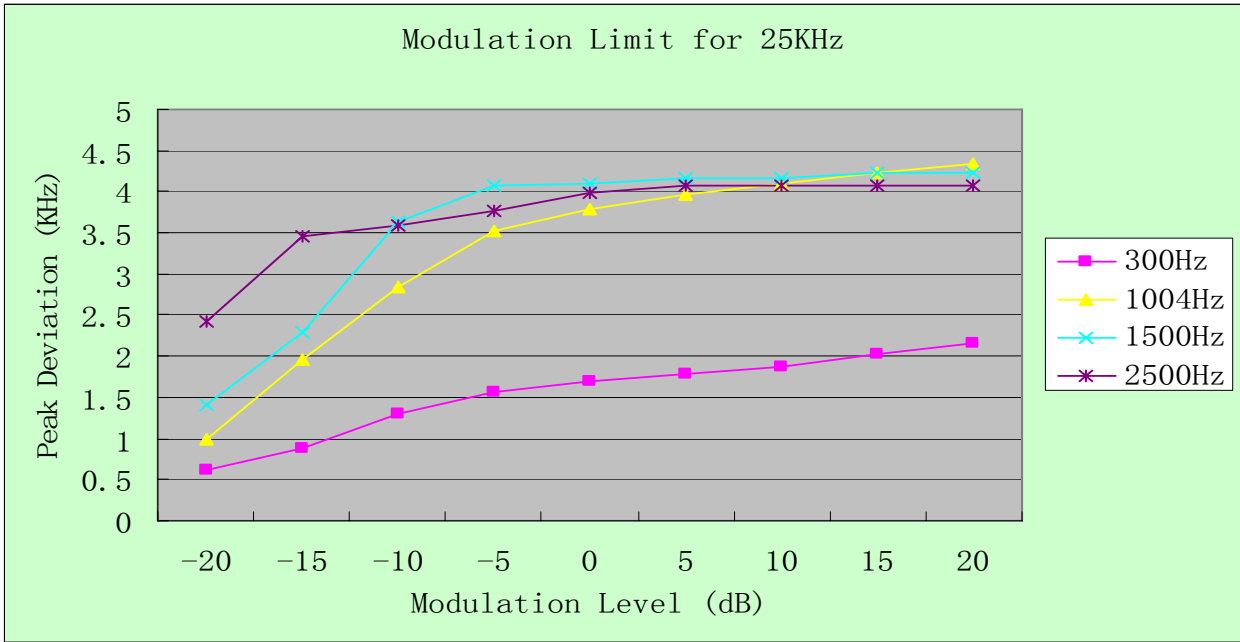

### 12.5 KHz Channel Separation

Modulation Level(dB)	Peak Freq. Deviation At 300 Hz(KHz)	Peak Freq. Deviation At 1004 H(KHz)	Peak Freq. Deviation At 1500 Hz(KHz)	Peak Freq. Deviation At 2500 Hz(KHz)
-20	0.43	0.67	0.89	1.07
-15	0.56	0.93	1.24	1.58
-10	0.71	1.45	1.98	1.96
-5	0.87	2.03	2.17	1.96
0	0.95	2.13	2.21	1.98
+5	1.03	2.18	2.21	1.98
+10	1.17	2.20	2.22	1.99
+15	1.29	2.27	2.23	1.99
+20	1.44	2.35	2.23	1.99

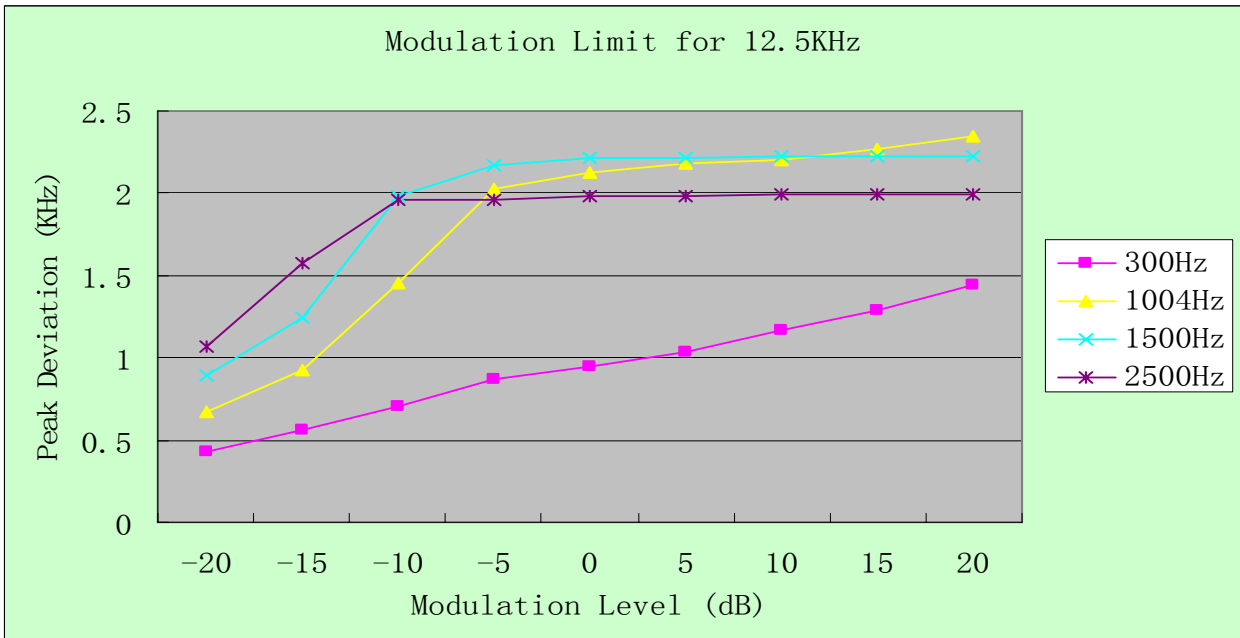

**b). Audio Frequency Response:**

**Note:**

- 1 Not applicable to new standard. However, tests are conducted under FCC's recommendation.
- 2 The Audio Frequency Response is identical for 12.5 KHz and 25 KHz channel separation

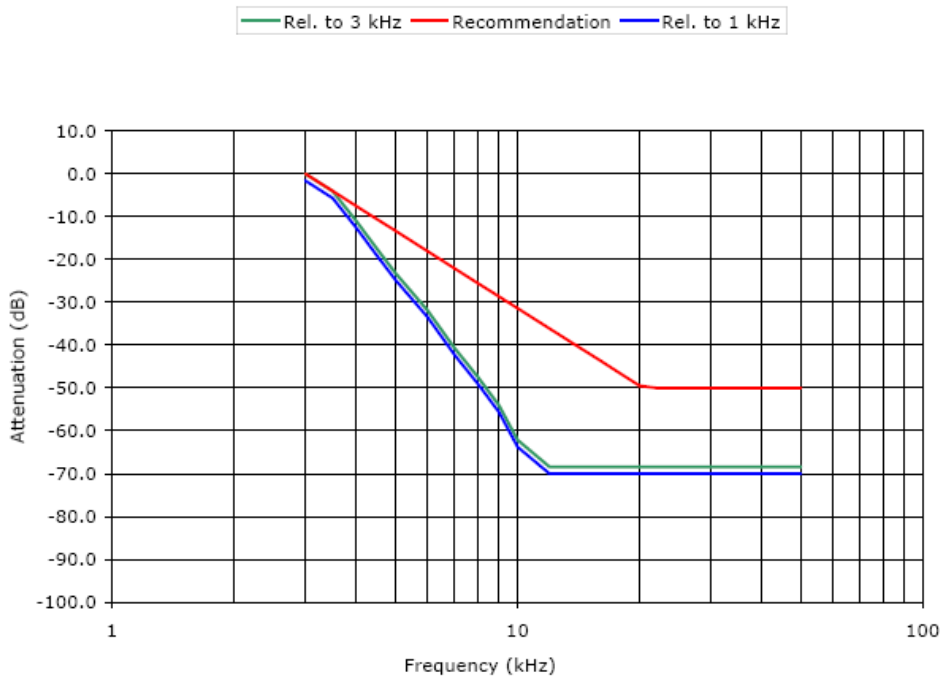

12.5KHz Channel Separation

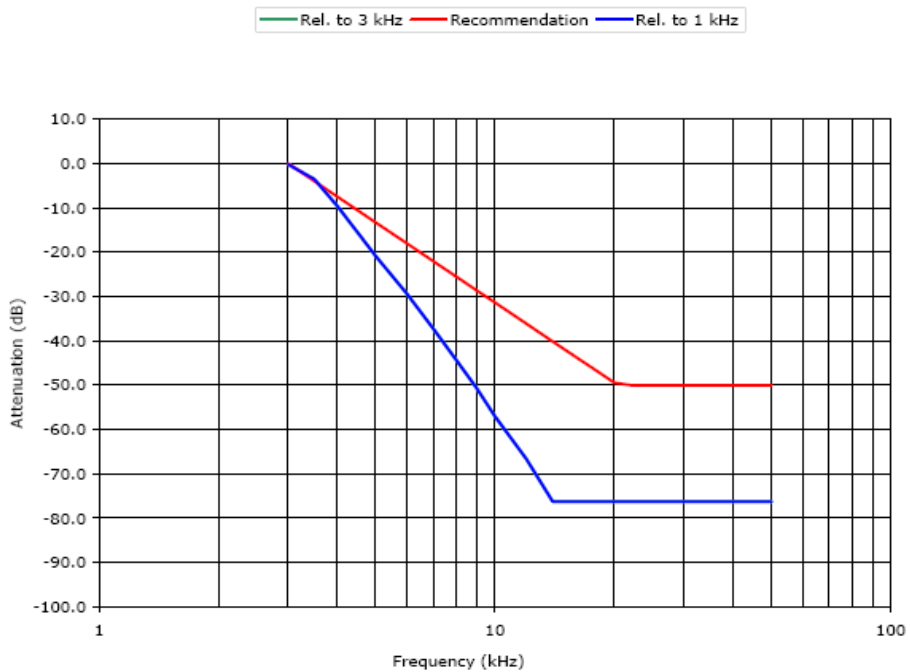

25 KHz Channel Separation

## 4.6. Frequency Stability Test

### TEST APPLICABLE

- 1 According to FCC Part 2 Section 2.1055 (a)(1), the frequency stability shall be measured with variation of ambient temperature from -30°C to +60°C centigrade.
- 2 According to FCC Part 2 Section 2.1055 (a) (2), for battery powered equipment, the frequency stability shall be measured with reducing primary supply voltage to the battery operating end point, which is specified by the manufacture.
- 3 According to §90.213, the frequency stability limit is 2.5 ppm for 12.5KHz channel separation and 5 ppm for 25KHz channel separation.

### TEST PROCEDURE

The EUT was set in the climate chamber and connected to an external DC power supply. The RF output was directly connected to Spectrum Analyzer ESI 26. The coupling loss of the additional cables was recorded and taken in account for all the measurements. After temperature stabilization (approx. 20 min for each stage), the frequency for the lower, the middle and the highest frequency range was recorded. For Frequency stability Vs. Voltage the EUT was connected to an DC power supply and the voltage was adjusted in the required ranges. The result was recorded.

### TEST CONFIGURATION

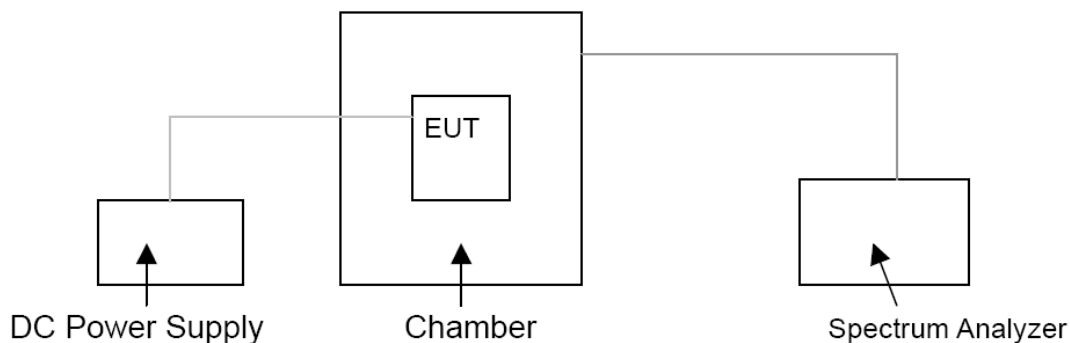

### TEST LIMITS

According to 90.213, Transmitters used must have minimum frequency stability as specified in the following table.

Frequency Range (MHz)	Channel Bandwidth (KHz)	Frequency Tolerance (ppm)		
		Fixed and Base Stations	Mobile Stations	
			> 2 W	≤ 2 W
150-174 MHz	6.25	1.0	2.0	2.0
	12.5	2.5	5.0	5.0
	25	5.0	5.0	50.0*
421-512 MHz	6.25	0.5	1.0	1.0
	12.5	1.5	2.5	2.5
	25	2.5	5.0	5.0

- Stations operating in the 154.45 to 154.49 MHz or the 173.2 to 173.4 MHz bands must have a frequency stability of 5 ppm.
- Paging transmitters operating on paging-only frequencies must operate with frequency stability of 5 ppm in the 150-174 MHz band and 2.5 ppm in the 421-512 MHz band.

**TEST RESULTS**

**a. Frequency stability versus input voltage** (battery operation end point voltage is 6.70 V)

For 25 KHz:

Channel	Reference Frequency (MHz)	Frequency Measured at end point	Frequency Deviation (%)	Limit (%)
03	519.9875	519.98840	0.00017	0.00050
02	485.1250	485.12528	0.00006	0.00050
01	450.1250	450.12523	0.00005	0.00050

For 12.5 KHz:

Channel	Reference Frequency (MHz)	Frequency Measured at end point	Frequency Deviation (%)	Limit (%)
07	519.9875	519.98784	0.00008	0.00025
06	485.1250	485.12482	-0.00004	0.00025
05	450.1250	450.12527	0.00006	0.00025

**b. Frequency stability versus ambient temperature**

For 25 KHz:

**Channel 03**

Reference Frequency: 519.9875MHz		Limit: 0.00050%	
Environment Temperature (°C)	Power Supply (DC)	Frequency deviation measured with time Elapse (10 minutes)	
		(MHz)	%
50	7.40 V	519.98869	0.00023
40	7.40 V	519.98857	0.00021
30	7.40 V	519.98840	0.00017
20	7.40 V	519.98840	0.00017
10	7.40 V	519.98758	0.00002
0	7.40 V	519.98657	-0.00018
-10	7.40 V	519.98703	-0.00009
-20	7.40 V	519.98793	0.00008
-30	7.40 V	519.98851	0.00019

**Channel 02**

Reference Frequency: 485.1250MHz		Limit: 0.0005%	
Environment Temperature (°C)	Power Supply (DC)	Frequency deviation measured with time Elapse (10 minutes)	
		(MHz)	%
50	7.40 V	485.12607	0.00022
40	7.40 V	485.12581	0.00017
30	7.40 V	485.12528	0.00006
20	7.40 V	485.12528	0.00006
10	7.40 V	485.12505	0.00001
0	7.40 V	485.12423	-0.00016
-10	7.40 V	485.12477	-0.00005
-20	7.40 V	485.12564	0.00013
-30	7.40 V	485.12590	0.00019

**Channel 01**

Reference Frequency: 450.1250MHz		Limit: 0.0005%	
Environment Temperature (°C)	Power Supply (DC)	Frequency deviation measured with time Elapse (10 minutes)	
		(MHz)	%
50	7.40 V	450.12588	0.00020
40	7.40 V	450.12569	0.00015
30	7.40 V	450.12523	0.00005
20	7.40 V	450.12523	0.00005
10	7.40 V	450.12491	-0.00002
0	7.40 V	450.12453	-0.00010
-10	7.40 V	450.12479	-0.00005
-20	7.40 V	450.12557	0.00013
-30	7.40 V	450.12583	0.00018



For 12.5 KHz:

**Channel 07**

Reference Frequency:519.9875MHz			Limit: 0.00025%
Environment Temperature (°C)	Power Supply (DC)	Frequency deviation measured with time Elapse (10 minutes)	
		(MHz)	%
50	7.40 V	519.98860	0.00021
40	7.40 V	519.98847	0.00019
30	7.40 V	519.98784	0.00008
20	7.40 V	519.98784	0.00008
10	7.40 V	519.98759	0.00002
0	7.40 V	519.98674	-0.00015
-10	7.40 V	519.98711	-0.00008
-20	7.40 V	519.98793	0.00008
-30	7.40 V	519.98843	0.00018

**Channel 06**

Reference Frequency: 485.1250MHz			Limit: 0.00025%
Environment Temperature (°C)	Power Supply (DC)	Frequency deviation measured with time Elapse (10 minutes)	
		(MHz)	%
50	7.40 V	485.12585	0.00018
40	7.40 V	485.12561	0.00013
30	7.40 V	485.12482	-0.00004
20	7.40 V	485.12482	-0.00004
10	7.40 V	485.12470	-0.00006
0	7.40 V	485.12425	-0.00015
-10	7.40 V	485.12477	-0.00009
-20	7.40 V	485.12567	0.00014
-30	7.40 V	485.12582	0.00017

**Channel 05**

Reference Frequency: 450.1250MHz		Limit: 0.00025%	
Environment Temperature (°C)	Power Supply (DC)	Frequency deviation measured with time Elapse (10 minutes)	
		(MHz)	%
50	7.40 V	450.12581	0.00018
40	7.40 V	450.12564	0.00014
30	7.40 V	450.12527	0.00006
20	7.40 V	450.12527	0.00006
10	7.40 V	450.12488	-0.00003
0	7.40 V	450.12457	-0.00010
-10	7.40 V	450.12479	-0.00003
-20	7.40 V	450.12559	0.00013
-30	7.40 V	450.12583	0.00016

## 4.7. Maximum Transmitter Power

### TEST APPLICABLE

Per FCC «2.1046 and «90.205: Maximum ERP is dependent upon the station's antenna HAAT and required service area..

### TEST PROCEDURE

Measurements shall be made to establish the radio frequency power delivered by the transmitter the standard output termination. The power output shall be monitored and recorded and no adjustment shall be made to the transmitter after the test has begun, except as noted bellow:

If the power output is adjustable, measurements shall be made for the highest and lowest power levels.

The EUT connect to the Receiver through 20 dB attenuator.

Measurement with Spectrum Analyzer ESI 26 conducted, external power supply with 7.50V stabilized supply voltage.

### TEST CONFIGURATION

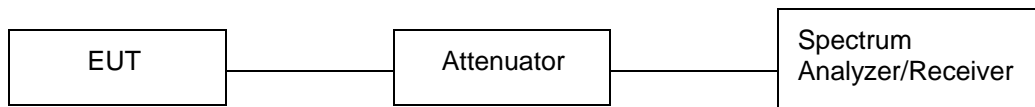

The EUT was directly connected to a RF Communication Test Set by a 20 dB attenuator

### TEST RESULTS

#### For 25 KHz:

Freq.(MHz)	Measurement (dBm)	FCC Limit
519.9875	36.35	Varies

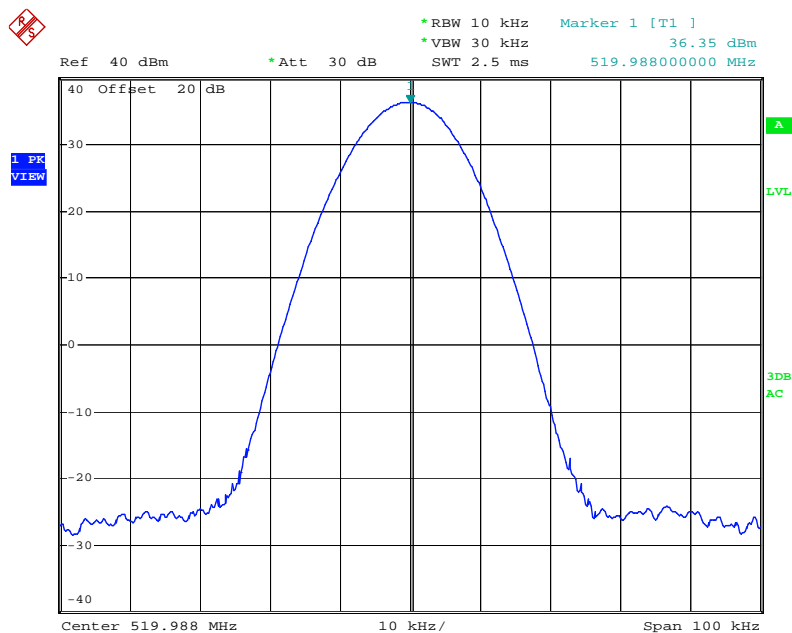

Freq. (MHz)	Measurement (dBm)	FCC Limit
485.1250	35.50	Varies

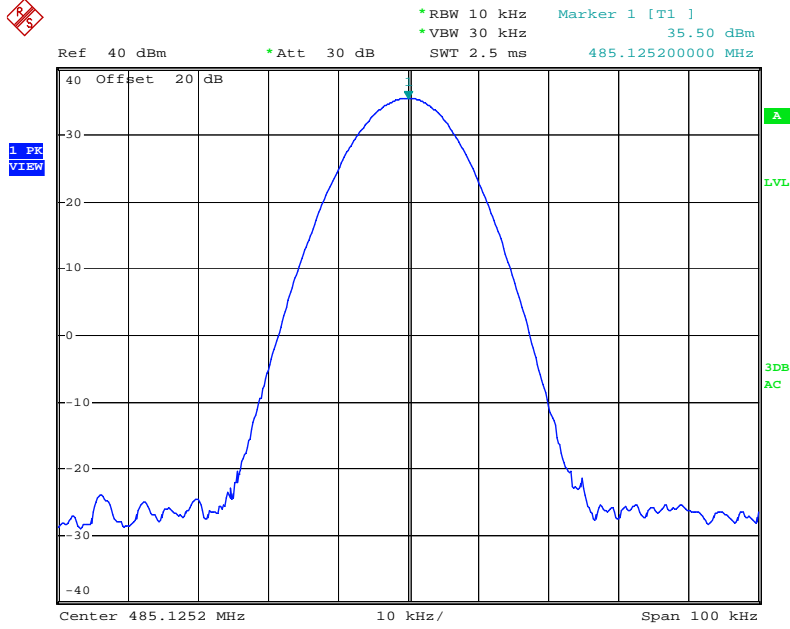

Date: 13.NOV.2009 21:25:17

Freq. (MHz)	Measurement (dBm)	FCC Limit
450.1250	36.29	Varies

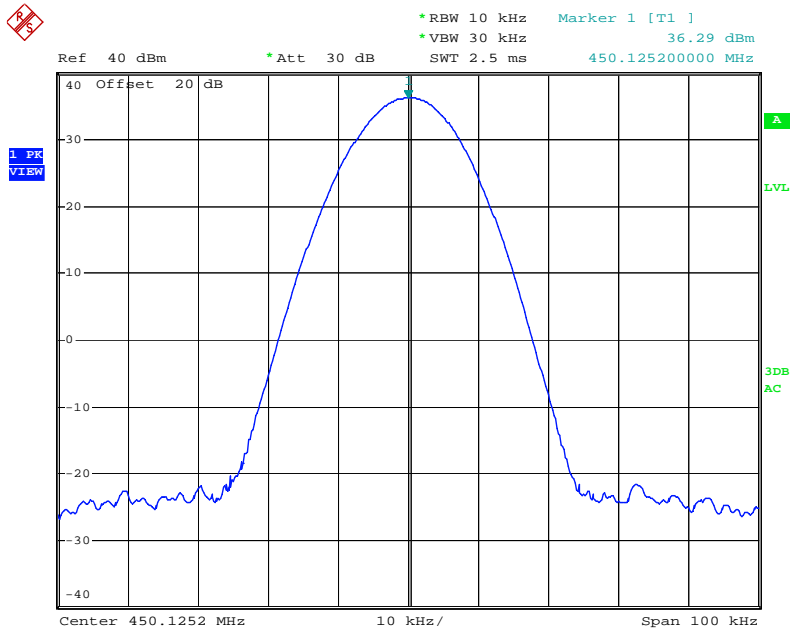

Date: 13.NOV.2009 21:22:57

## For 12.5 KHz

Freq. (MHz)	Measurement (dBm)	FCC Limit
519.9875	36.40	Varies

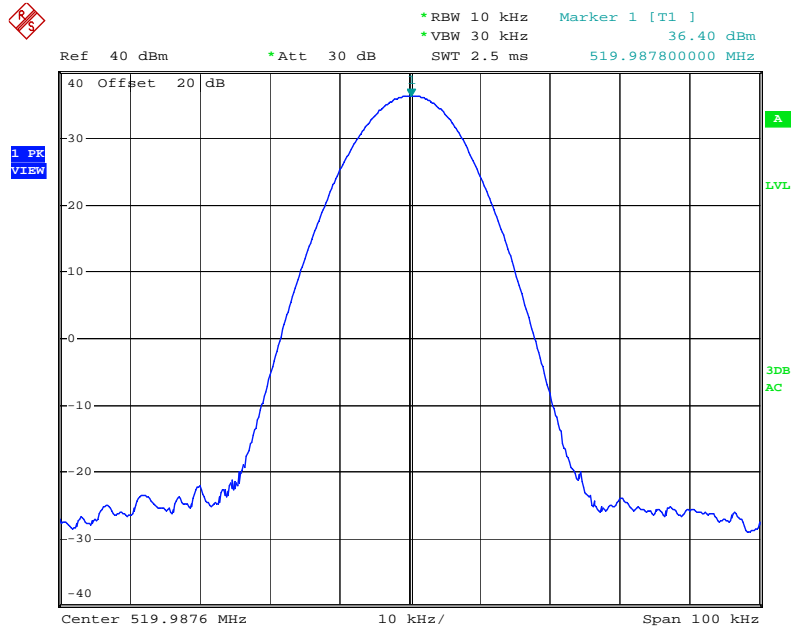

Date: 13.NOV.2009 21:30:16

Freq. (MHz)	Measurement (dBm)	FCC Limit
485.1250	35.55	Varies

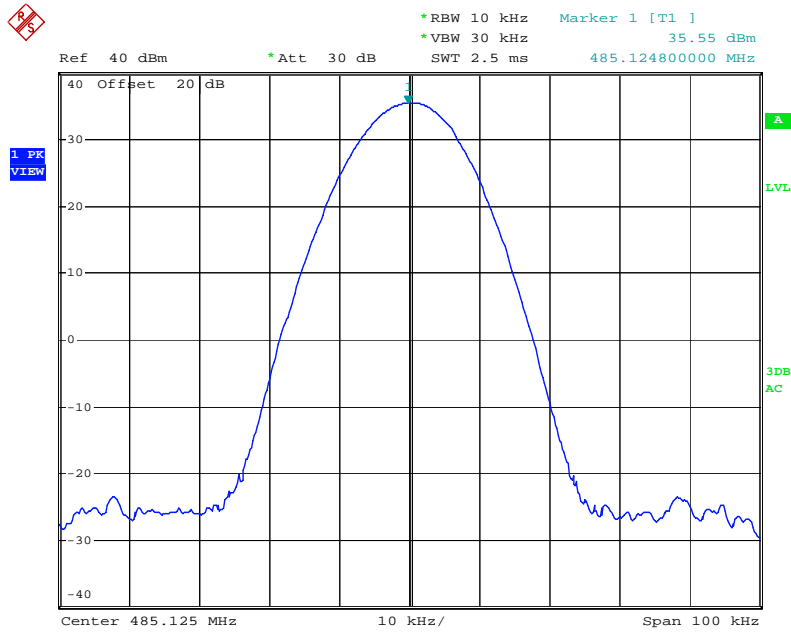

Date: 13.NOV.2009 21:29:28

Freq. (MHz)	Measurement (dBm)	FCC Limit
450.1250	36.30	Varies

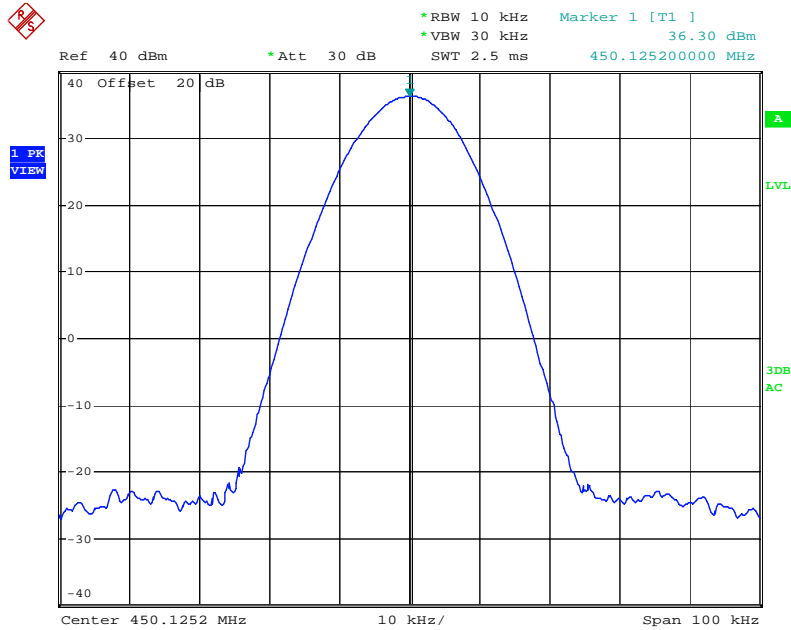

Date: 13.NOV.2009 21:28:17

## 4.8. Transmitter Frequency Behavior

### TEST APPLICABLE

Section 90.214

Transient frequencies must be within the maximum frequency difference limits during the time intervals indicated:

Time intervals <sup>1, 2</sup>	Maximum frequency difference <sup>3</sup>	All equipment	
		150 to 174 MHz	421 to 512MHz
Transient Frequency Behavior for Equipment Designed to Operate on 25 KHz Channels			
$t_1$ <sup>4</sup> .....	± 25.0 KHz	5.0 ms	10.0 ms
$t_2$ .....	± 12.5 KHz	20.0 ms	25.0 ms
$t_3$ <sup>4</sup> .....	± 25.0 KHz	5.0 ms	10.0 ms
Transient Frequency Behavior for Equipment Designed to Operate on 12.5 KHz Channels			
$t_1$ <sup>4</sup> .....	± 12.5 KHz	5.0 ms	10.0 ms
$t_2$ .....	± 6.25 KHz	20.0 ms	25.0 ms
$t_3$ <sup>4</sup> .....	± 12.5 KHz	5.0 ms	10.0 ms
Transient Frequency Behavior for Equipment Designed to Operate on 6.25 KHz Channels			
$t_1$ <sup>4</sup> .....	±6.25 KHz	5.0 ms	10.0 ms
$t_2$ .....	±3.125 KHz	20.0 ms	25.0 ms
$t_3$ <sup>4</sup> .....	±6.25 KHz	5.0 ms	10.0 ms

- $t_{on}$  is the instant when a 1 KHz test signal is completely suppressed, including any capture time due to phasing.  
 $t_1$  is the time period immediately following  $t_{on}$ .  
 $t_2$  is the time period immediately following  $t_1$ .  
 $t_3$  is the time period from the instant when the transmitter is turned off until  $t_{off}$ .  
 $t_{off}$  is the instant when the 1 KHz test signal starts to rise.
- During the time from the end of  $t_2$  to the beginning of  $t_3$ , the frequency difference must not exceed the limits specified in § 90.213.
- Difference between the actual transmitter frequency and the assigned transmitter frequency.
- If the transmitter carrier output power rating is 6 watts or less, the frequency difference during this time period may exceed the maximum frequency difference for this time period.

### TEST PROCEDURE

TIA/EIA-603 2.2.19

### TEST CONFIGURATION

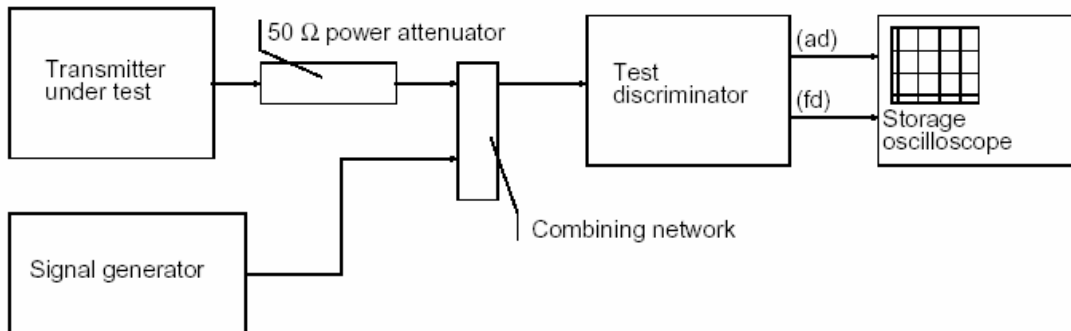

### TEST RESULTS

Please refer to the following plots.

Transmitter Frequency Behaviour @ 12.5 KHz Channel Separation-----Off – On

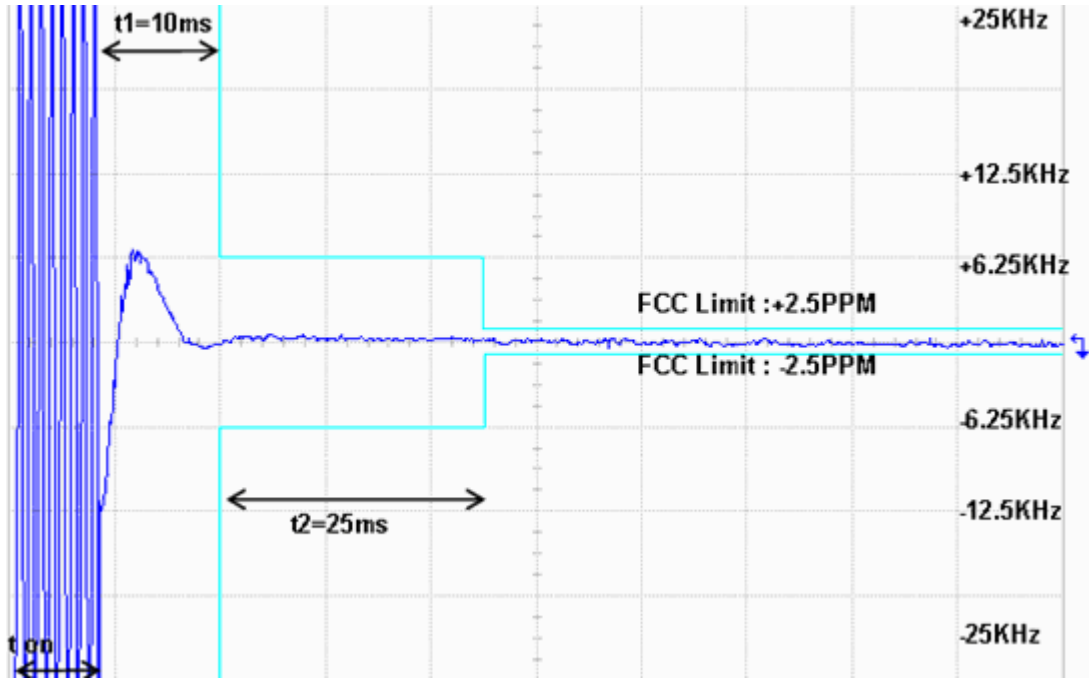

Transmitter Frequency Behaviour @ 12.5 KHz Channel Separation-----On - Off

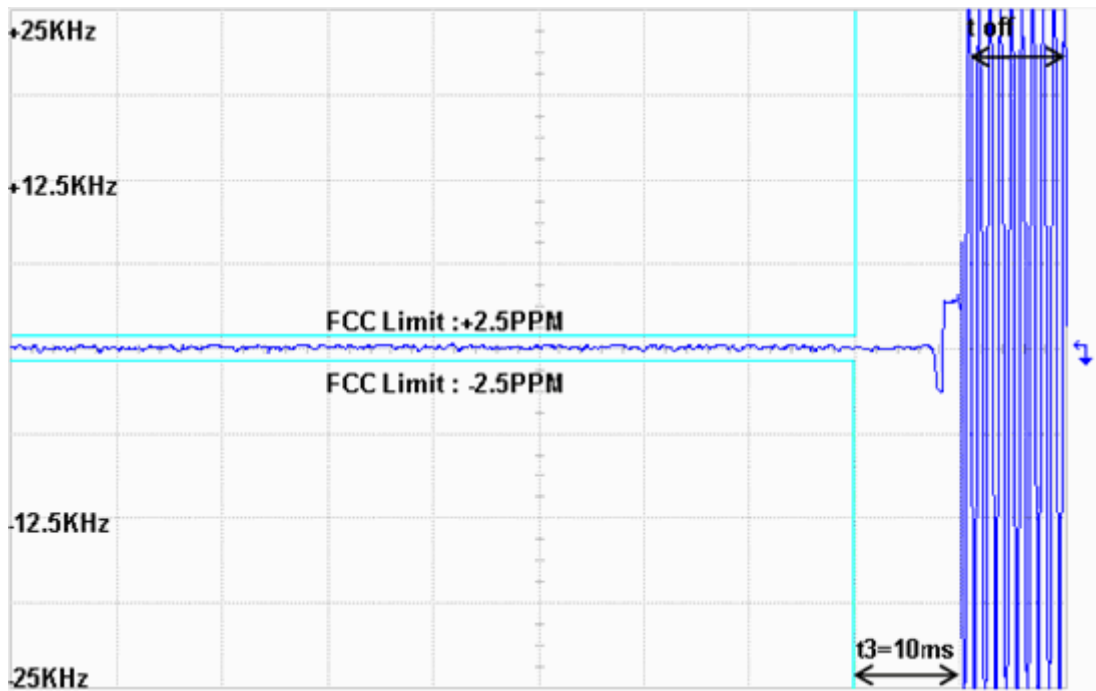



Transmitter Frequency Behaviour @ 25 KHz Channel Separation-----Off – On

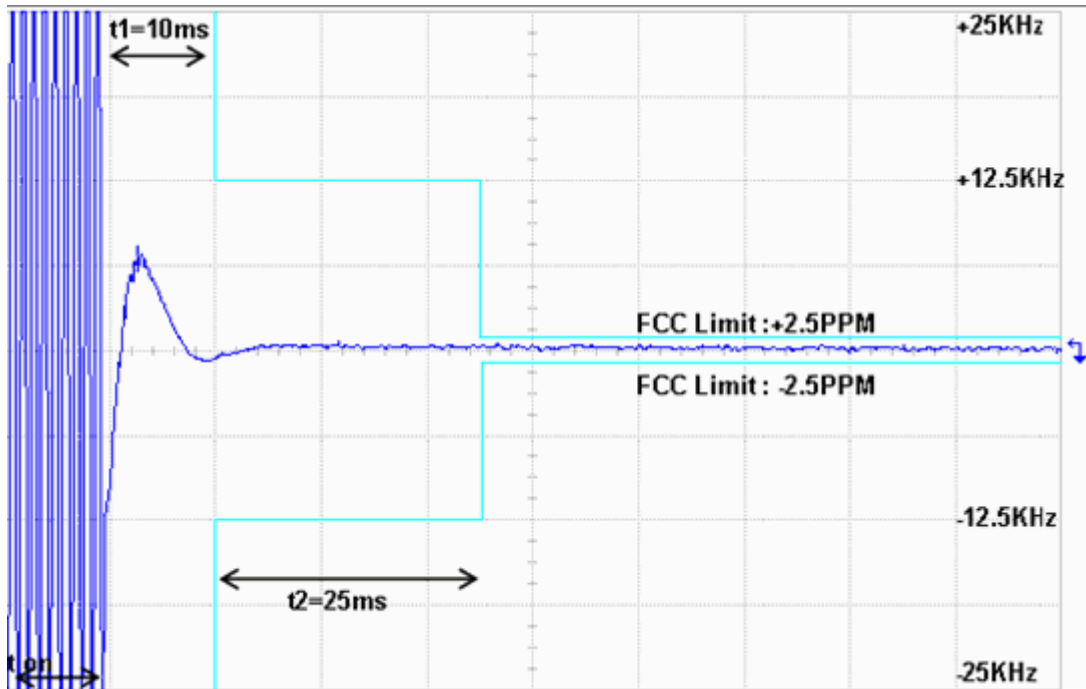

Transmitter Frequency Behaviour @25 KHz Channel Separation-----On – Off

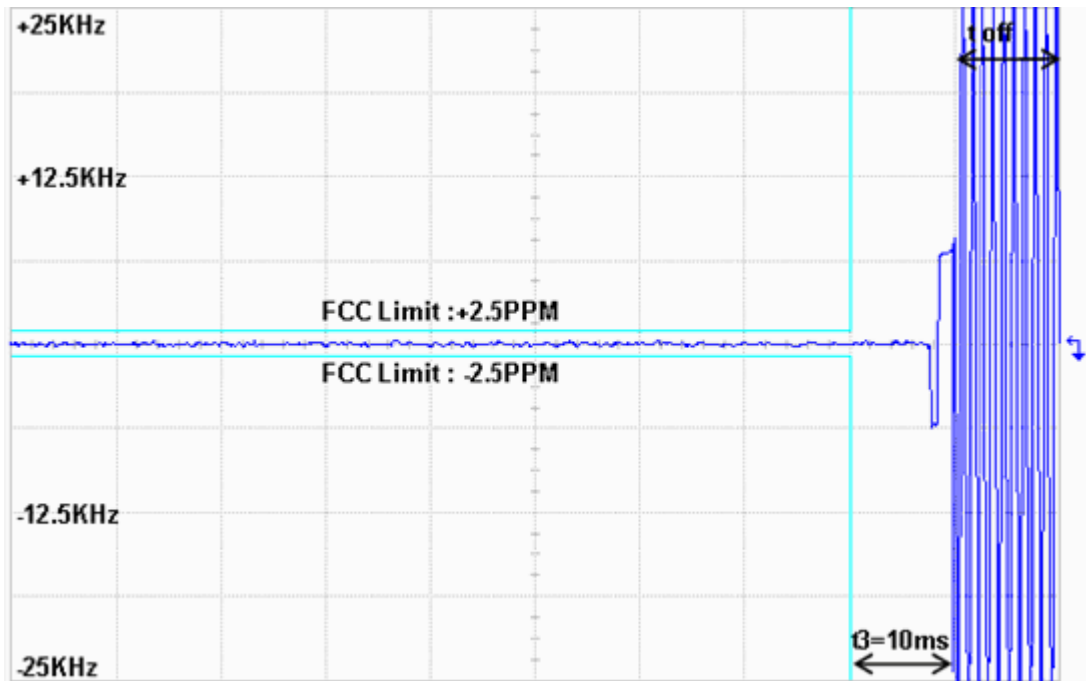

### 4.9. Receiver Radiated Spurious Emission

#### TEST APPLICABLE

The field strength is calculated by adding the Antenna Factor and Cable Factor and subtracting the Amplifier Gain and Duty Cycle Correction Factor(if any) from the measured reading. The basic equation with a sample calculation is as follows:

$$FS = RA + AF + CL - AG$$

Where FS = Field Strength	CL = Cable Attenuation Factor (Cable Loss)
RA = Reading Amplitude	AG = Amplifier Gain
AF = Antenna Factor	

#### TEST CONFIGURATION

(A) Radiated Emission Test Set-Up, Frequency Below 30MHz

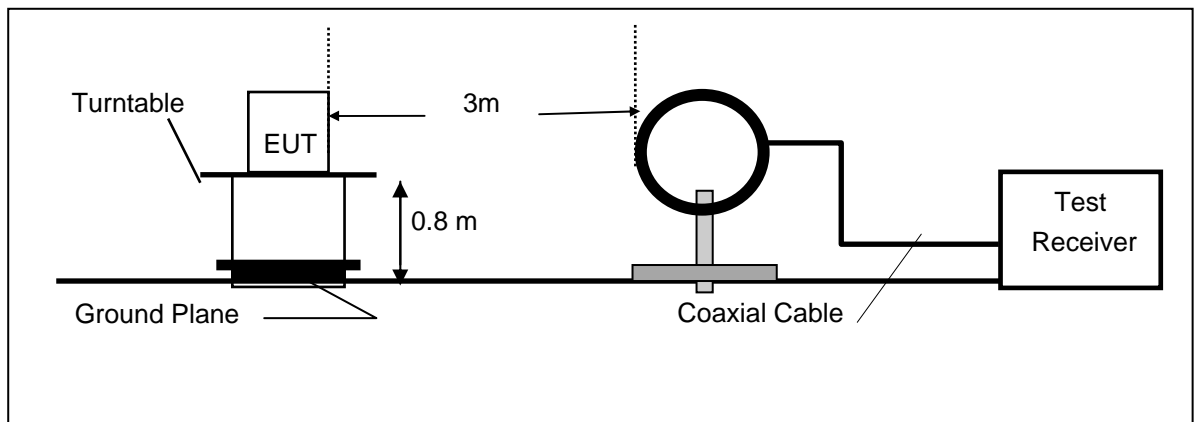

(B) Radiated Emission Test Set-Up, Frequency below 1000MHz

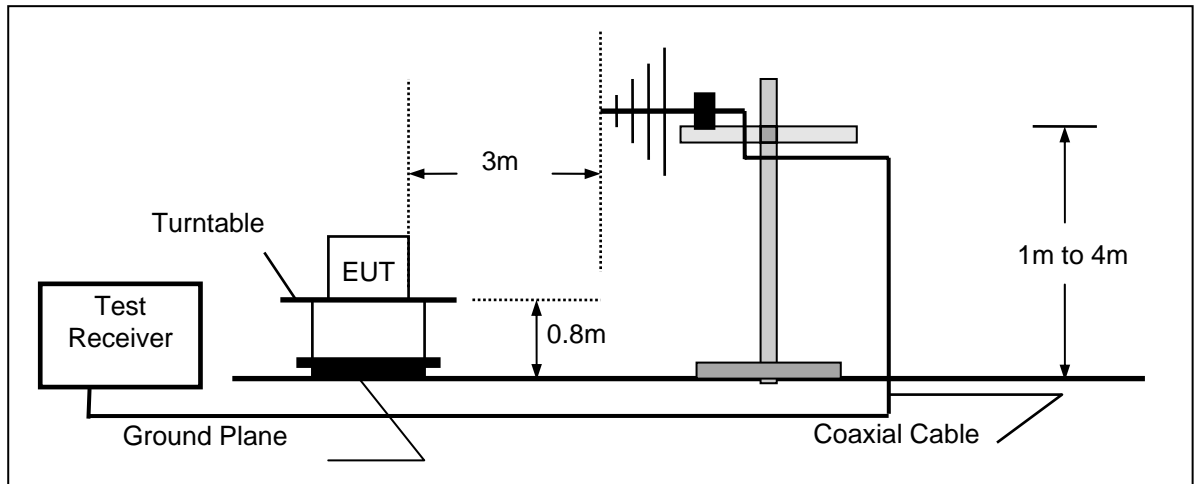

(C) Radiated Emission Test Set-Up, Frequency above 1000MHz

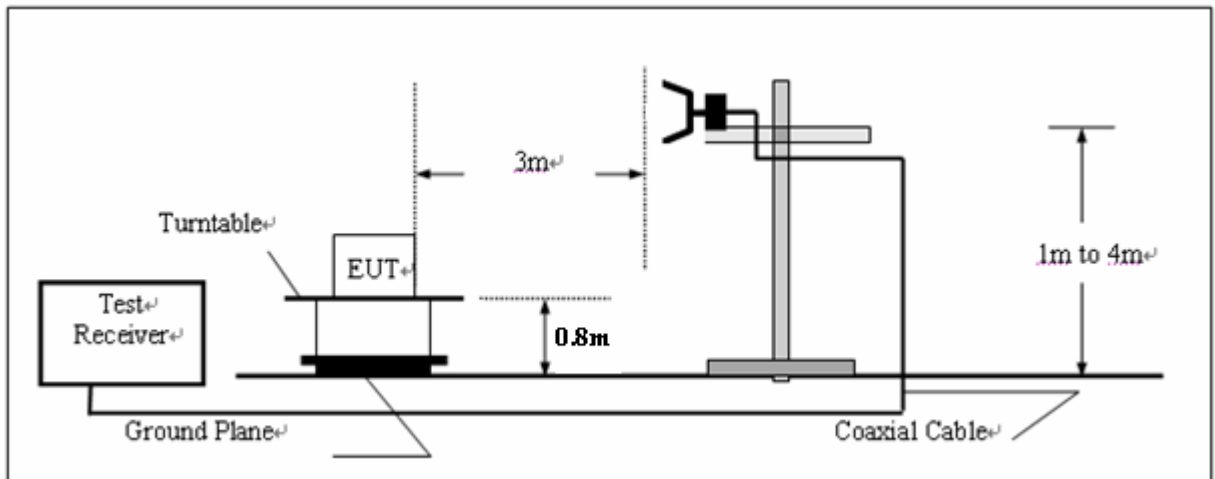

**TEST PROCEDURE**

- 1 The EUT was placed on a turn table which is 0.8m above ground plane.
- 2 Maximum procedure was performed by raising the receiving antenna from 1m to 4m and rotating the turn table from 0° to 360° to acquire the highest emissions from EUT
- 3 And also, each emission was to be maximized by changing the polarization of receiving antenna both horizontal and vertical.
- 4 Repeat above procedures until all frequency measurements have been completed.

**RECEIVER RADIATED SPOUIOUS LIMIT**

For unintentional device, according to § 15.109(a) and RSS-Gen, except for Class A digital devices, the field strength of radiated emissions from unintentional radiators at a distance of 3 meters shall not exceed the following values:

Frequency (MHz)	Distance (Meters)	Radiated (dBµV/m)	Radiated (µV/m)
30-88	3	40.0	100
88-216	3	43.5	150
216-960	3	46.0	200
Above 960	3	54.0	500

For intentional device, according to § 15.209(a), the general requirement of field strength of radiated emissions from intentional radiators at a distance of 3 meters shall not exceed the above table.

**TEST RESULTS**

The Radiated Measurement are performed to the three channels (the top channel, the middle channel and the bottom channel), the datum recorded below is the worst case for each channel separation; and the EUT shall be scanned from 30 MHz to the 5th harmonic of the highest oscillator frequency in the digital devices or 1 GHz whichever is higher.

**The Bottom Channel is the worst case for 25 KHz Channel Separation**

**SWEEP TABLE: "test (30M-1G)"**

Short Description:		Field Strength			
Start	Stop	Detector	Meas. Time	IF Bandw.	Transducer
Frequency	Frequency				
30.0 MHz	1.0 GHz	MaxPeak	Coupled	100 kHz	HL562 09

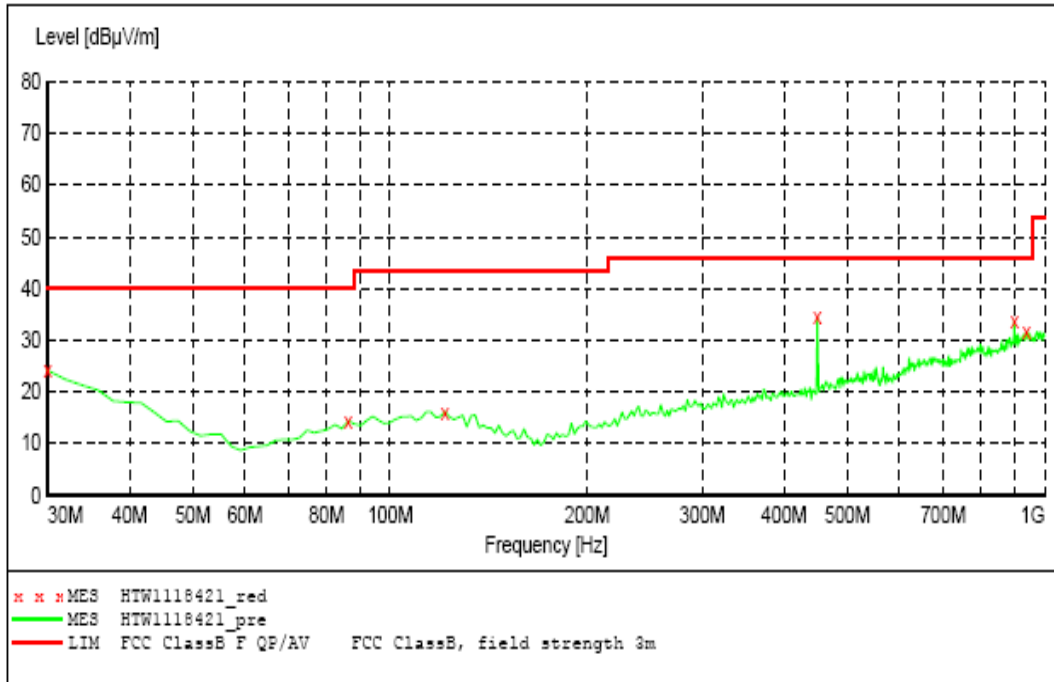

**MEASUREMENT RESULT: "HTW1118421\_red"**

11/18/2009 8:06PM

Frequency	Level	Transd	Limit	Margin	Det.	Height	Azimuth	Polarization
MHz	dBµV/m	dB	dBµV/m	dB		cm	deg	
30.000000	24.20	-4.7	40.0	15.8	Peak	300.0	303.00	HORIZONTAL
86.372745	14.40	-14.5	40.0	25.6	Peak	100.0	288.00	HORIZONTAL
121.362725	16.20	-12.9	43.5	27.3	Peak	300.0	212.00	HORIZONTAL
449.879600	34.50	-11.4	46.0	11.5	Peak	100.0	167.00	HORIZONTAL
898.917836	33.80	-5.9	46.0	14.2	Peak	300.0	7.00	HORIZONTAL
937.795591	31.50	2.7	46.0	14.5	Peak	300.0	303.00	HORIZONTAL

**SWEEP TABLE: "test (30M-1G)"**

Short Description:		Field Strength			
Start	Stop	Detector	Meas. Time	IF Bandw.	Transducer
30.0 MHz	1.0 GHz	MaxPeak	Coupled	100 kHz	HL562 09

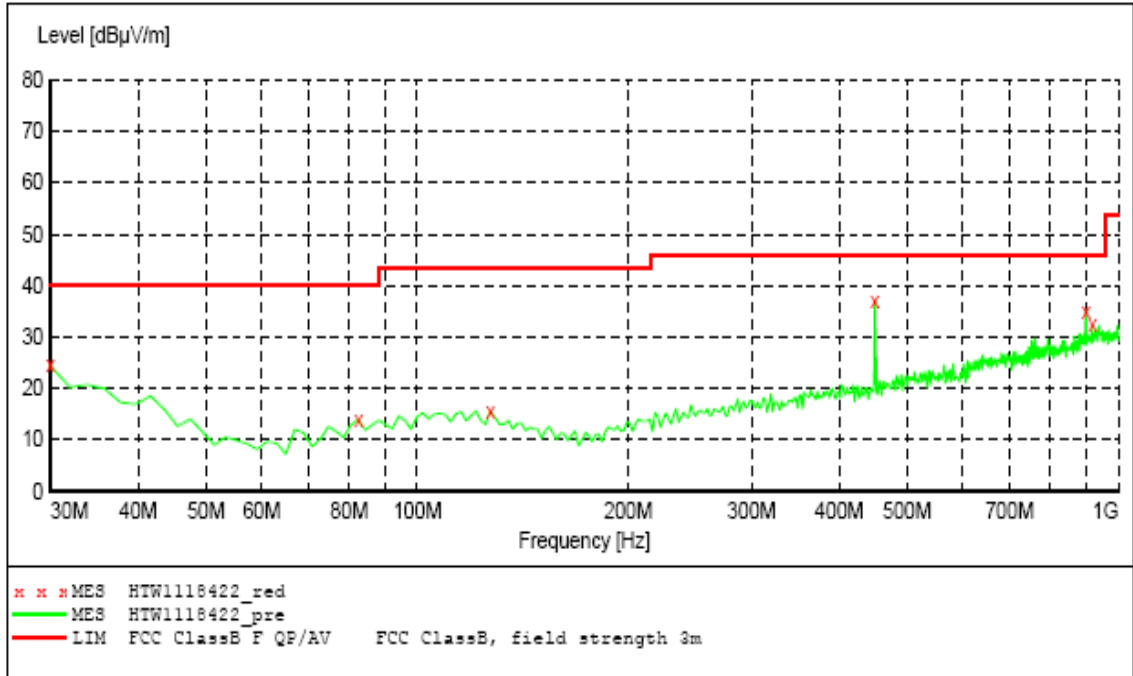

**MEASUREMENT RESULT: "HTW1118422\_red"**

11/18/2009 8:09PM

Frequency MHz	Level dBuV/m	Transd dB	Limit dBuV/m	Margin dB	Det.	Height cm	Azimuth deg	Polarization
30.000000	24.50	-4.7	40.0	15.5	Peak	100.0	15.00	VERTICAL
82.484970	14.00	-15.1	40.0	26.0	Peak	100.0	110.00	VERTICAL
127.194389	15.70	-13.7	43.5	27.8	Peak	100.0	184.00	VERTICAL
449.881326	37.20	-11.3	46.0	8.8	Peak	100.0	190.00	VERTICAL
898.963489	35.10	-5.8	46.0	10.9	Peak	100.0	83.00	VERTICAL
918.356713	32.40	2.3	46.0	13.6	Peak	100.0	157.00	VERTICAL

**The Bottom Channel is the worst case for 12.5 KHz Channel Separation**

**SWEEP TABLE: "test (30M-1G)"**

Short Description:		Field Strength			
Start	Stop	Detector	Meas. Time	IF Bandw.	Transducer
30.0 MHz	1.0 GHz	MaxPeak	Coupled	100 kHz	HL562 09

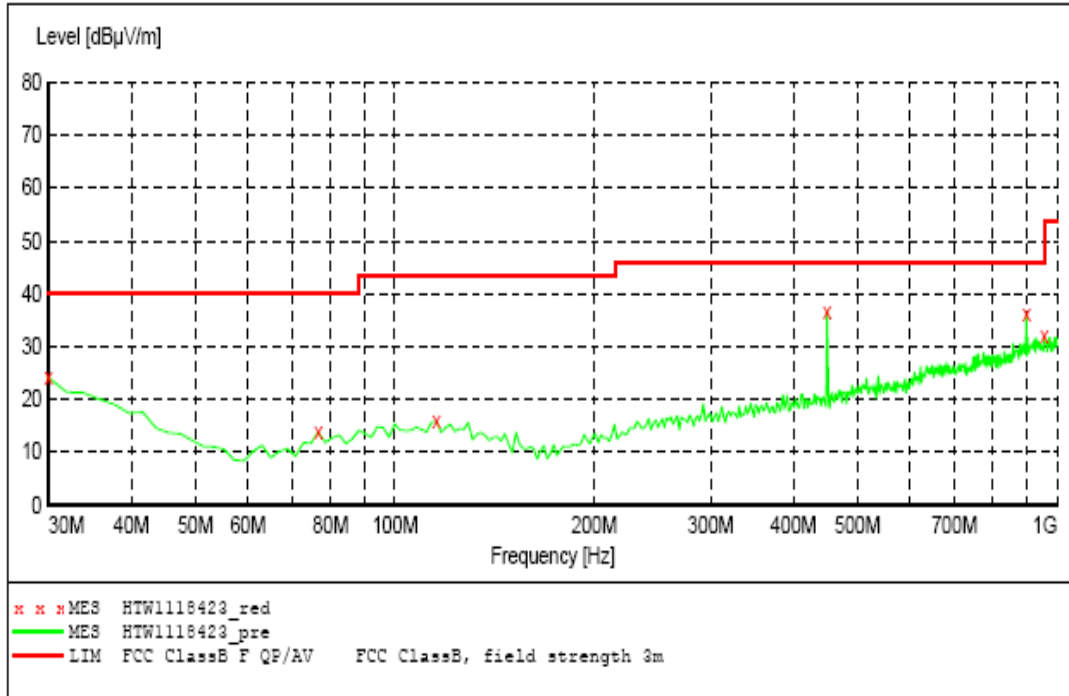

**MEASUREMENT RESULT: "HTW1118423\_red"**

11/18/2009 8:11PM

Frequency MHz	Level dBuV/m	Transd dB	Limit dBuV/m	Margin dB	Det.	Height cm	Azimuth deg	Polarization
30.000000	24.20	-4.7	40.0	15.8	Peak	100.0	122.00	VERTICAL
76.653307	13.80	-16.0	40.0	26.2	Peak	100.0	157.00	VERTICAL
115.531062	15.90	-12.9	43.5	27.6	Peak	100.0	36.00	VERTICAL
449.839670	36.80	-10.9	46.0	9.2	Peak	100.0	144.00	VERTICAL
898.962734	36.10	-5.8	46.0	9.9	Peak	100.0	359.00	VERTICAL
957.234469	31.90	2.7	46.0	14.1	Peak	100.0	23.00	VERTICAL

**SWEEP TABLE: "test (30M-1G)"**

Short Description:		Field Strength			
Start	Stop	Detector	Meas.	IF	Transducer
Frequency	Frequency		Time	Bandw.	
30.0 MHz	1.0 GHz	MaxPeak	Coupled	100 kHz	HL562 09

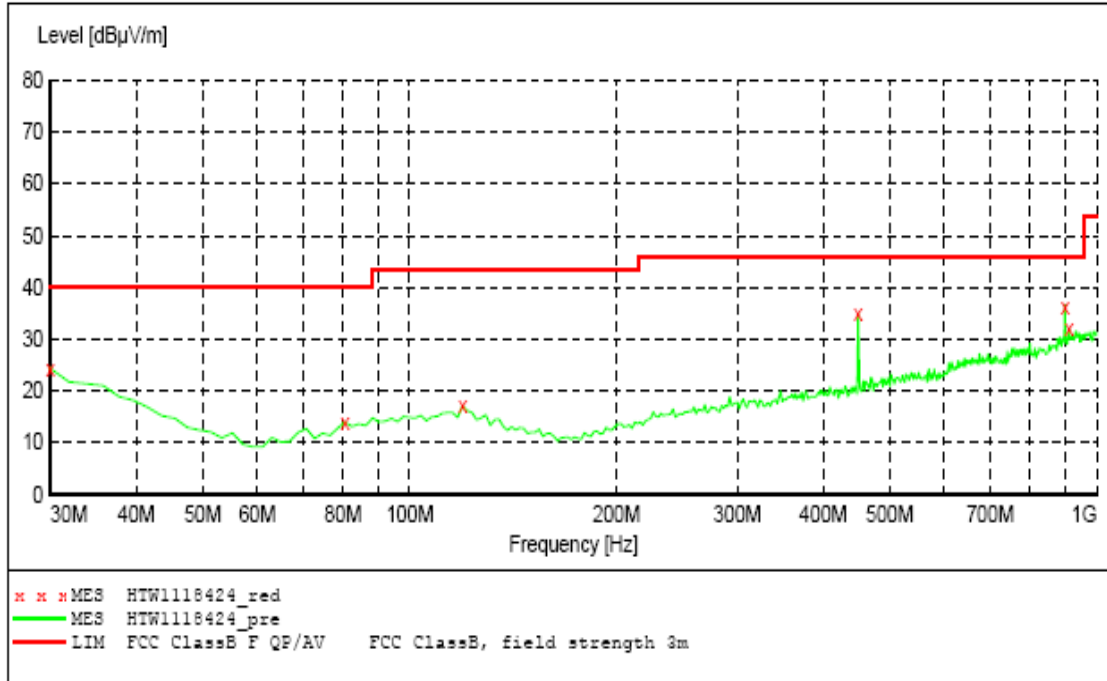

**MEASUREMENT RESULT: "HTW1118424\_red"**

11/18/2009 8:13PM

Frequency MHz	Level dBuV/m	Transd dB	Limit dBuV/m	Margin dB	Det.	Height cm	Azimuth deg	Polarization
30.000000	24.40	-4.7	40.0	15.6	Peak	100.0	49.00	HORIZONTAL
80.541082	14.00	-15.4	40.0	26.0	Peak	300.0	74.00	HORIZONTAL
119.418838	17.10	-12.8	43.5	26.4	Peak	300.0	3.00	HORIZONTAL
449.871635	34.90	-10.9	46.0	11.1	Peak	100.0	325.00	HORIZONTAL
898.982278	36.40	-5.9	46.0	9.6	Peak	100.0	0.00	HORIZONTAL
912.525050	31.90	2.1	46.0	14.1	Peak	100.0	356.00	HORIZONTAL

## 5. Test Setup Photos of the EUT

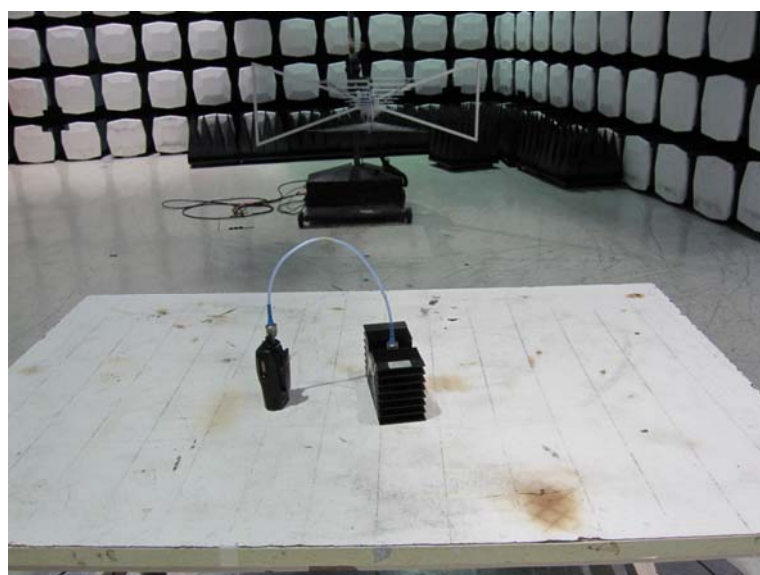



## 6. External and Internal Photos of the EUT

### External Photos

Top view of EUT



Bottom view of EUT



Right view of EUT



Left view of EUT



Front view of EUT



Back view of EUT





Internal Photos

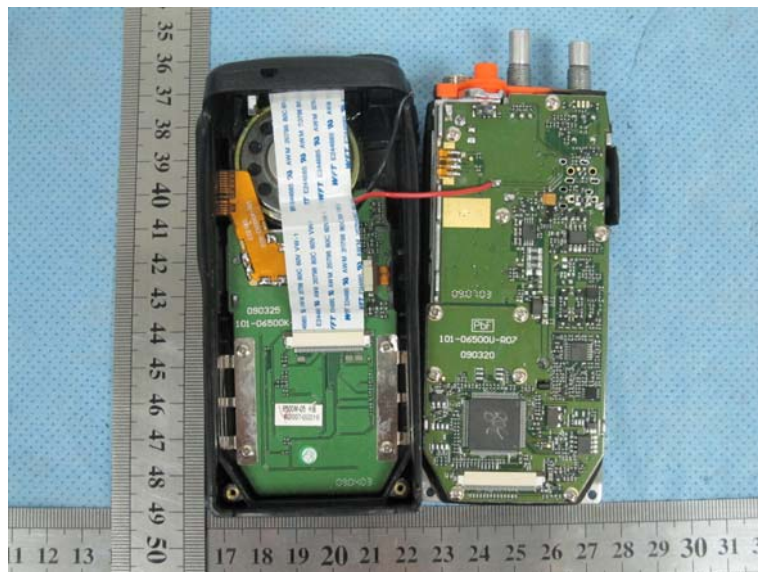





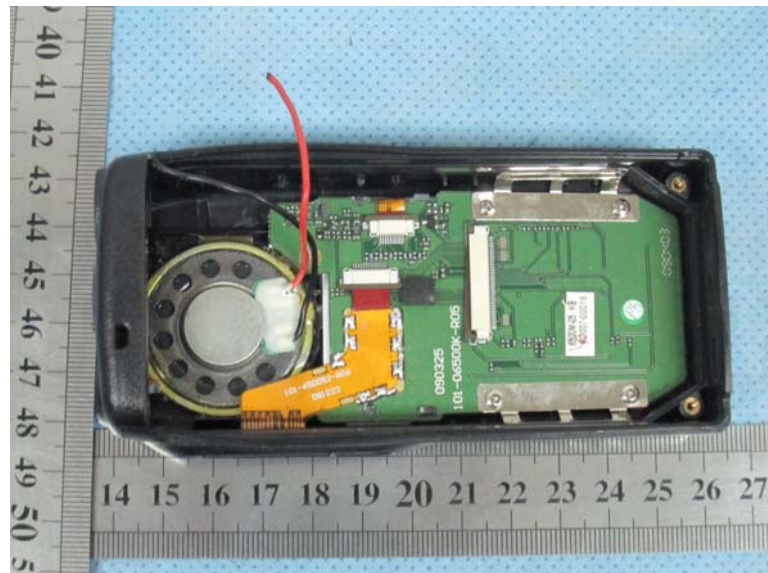

.....End of Report.....