



No. SAR09-018

ShenZhen Electronic Product Quality Testing Center

CONFORMANCE TEST REPORT FOR HUMAN EXPOSURE TO ELECTROMAGNETIC FIELDS

SAR REPORT

KIRISUN ELECTRONICS (SHENZHEN) CO., LTD

Two-way Radio

Type Name: PT4208-03

Hardware Version: --
Software Version: --

Date of Issue: 2009-06-12





GENERAL SUMMARY

Product Name	Two-way Radio	Development Stage	MP
Standard(s)	<p>47CFR § 2.1093: Radiofrequency Radiation Exposure Evaluation: Portable Devices FCC OET Bulletin 65 (Edition 97-01), Supplement C (Edition 01-01): Evaluating Compliance with FCC Guidelines for Human Exposure to Radiofrequency Electromagnetic Fields</p> <p>ANSI C95.1-1999: IEEE Standard for Safety Levels with Respect to Human Exposure to Radio Frequency Electromagnetic Fields, 3 kHz to 300 GHz.</p> <p>IEEE 1528-2003: Recommended Practice for Determining the Peak Spatial-Average Specific Absorption Rate (SAR) in the Human Body Due to Wireless Communications Devices: Experimental Techniques.</p>		
Conclusion	<p>Localized Specific Absorption Rate (SAR) of this portable wireless equipment has been measured in all cases requested by the relevant standards cited in Clause 5.2 of this test report. Maximum localized SAR is below exposure limits specified in the relevant standards cited in Clause 5.1 of this test report.</p> <p>General Judgment: Pass</p> <p style="text-align: right;">Date of issue: June 12th, 2009</p>		
Comment	<p>TX Freq. Band: 420-470MHz RX Freq. Band: 420-470MHz Antenna Character : Detachable</p> <p>The test result only responds to the measured sample.</p>		
Tested	<p>by: <u>Zhang Can</u> Zhang Can</p> <p style="text-align: right;">Date: <u>June 12, 2009</u></p>		
Checked	<p>by: <u>Smart Li</u> Smart Li</p> <p style="text-align: right;">Date: <u>June, 13, 2009</u></p>		
Approved by:	<p><u>[Signature]</u> Li'an Wu</p> <p style="text-align: right;">Date: <u>Jun. 13. 2009</u></p>		



Contents

- 1. GENERAL CONDITIONS**
- 2. ADMINISTRATIVE DATA**
 - 2.1. Identification of the Responsible Testing Laboratory
 - 2.2. Identification of the Responsible Testing Location(s)
 - 2.3. Organization Item
 - 2.4. Identification of Applicant
 - 2.5. Identification of Manufacture
- 3. EQUIPMENT UNDER TEST (EUT)**
 - 3.1. Identification of the Equipment under Test
 - 3.2. Identification of all used Test Sample of the Equipment under Test
- 4. OPERATIONAL CONDITIONS DURING TEST**
 - 4.1. Schematic Test Configuration
 - 4.2. SAR Measurement System
- 5. CHARACTERISTICS OF THE TEST**
 - 5.1. Applicable Limit Regulations
 - 5.2. Applicable Measurement Standards
- 6. LABORATORY ENVIRONMENT**
- 7. TEST RESULTS**
 - 7.1. Dielectric Performance
 - 7.2. Summary of Measurement Results
 - 7.3. Conclusion
- 8. MEASUREMENT UNCERTAINTY**
- 9. MAIN TEST INSTRUMENTS**

This Test Report consists of the following Annexes:

<p>Annex A: Accreditation Certificate</p> <p>Annex B: Test Layout</p> <p>Annex C: Sample Photographs</p> <p>Annex D: Graph Test Results</p> <p>Annex E: System Performance Check Data</p>
--



1. GENERAL CONDITIONS

1.1 This report only refers to the item that has undergone the test.

1.2 This report standalone dose not constitute or imply by its own an approval of the product by the certification Bodies or competent Authorities.

1.3 This document is only valid if complete; no partial reproduction can be made without written approval of Shenzhen Electronic Product Quality Testing Center.

1.4 This report cannot be used partially or in full for publicity and/or promotional purposes without previous written approval of Shenzhen Electronic Product Quality Testing Center and the Accreditation Bodies, if it applies.



2. Administrative Date

2.1. Identification of the Responsible Testing Laboratory

Company Name: ShenZhen Electronic Product Quality Testing Center
Department: Testing Department
Address: Electronic Testing Building, ShaHe Road, NanShan District,
ShenZhen, P. R. China
Telephone: +86-755-26628676
Fax: +86-755-26627238
**Responsible Test Lab
Managers:** Mr. Li'an Wu

2.2. Identification of the Responsible Testing Location(s)

Company Name: ShenZhen Electronic Product Quality Testing Center
Address: Electronic Testing Building, ShaHe Road, NanShan District,
ShenZhen, P. R. China

2.3. Organization Item

S.E.T Report No.: SAR REPORT
S.E.T Project Leader: Mr. Li Sixiong
**S.E.T Responsible for
accreditation scope:** Mr. Li'an Wu
Start of Testing: 2009-05-21
End of Testing: 2009-06-12

2.4. Identification of Applicant

Company Name: KIRISUN ELECTRONICS (SHENZHEN) CO., LTD
Address: 6/F., Bldg. H-2, East Industrial Zone of Overseas Chinese Town, Nanshan Dist.,
Shenzhen P.R. China
Contact person: /
Telephone: /
Fax: /

2.5. Identification of Manufacture

Company Name: KIRISUN ELECTRONICS (SHENZHEN) CO., LTD
Address: 6/F., Bldg. H-2, East Industrial Zone of Overseas Chinese Town, Nanshan Dist.,
Shenzhen P.R. China
Contact person: /
Telephone: /
Fax: /

Notes: This data is based on the information by the applicant.



3. Equipment Under Test (EUT)

3.1. Identification of the Equipment under Test

Brand Name: Kirisun
Type Name: PT4208-03
Marking Name: PT4208-03

Test frequency 450MHz
Development Stage Identical prototype
Accessories Charger; Battery
Battery Model KB-70B

General description: Battery specification 7.4V 1700mAh
Antenna type Detachable
Operation mode Tx mode
Modulation mode FM
Max. Power(EIRP) /

Note: According to FCC OET Bulletin 65 (Edition 97-01), Supplement C, the EUT is designed to operate in front of a person's face, in push-to-talk configuration, the EUT should be tested for SAR compliance with two mode: the front of the device positioned at 2.5cm from a flat phantom and the belt-clips positioned against a flat phantom.

The EUT operate in 25kHz channel separation(channel 1-3) and 12.5kHz channel separation(channel 4-6), the EUT should be tested for SAR compliance in all these channels.

3.2. Identification of all used Test Sample of the Equipment under Test

EUT Code	Serial Number	Hardware Version	Software Version
1#	R1942A1090100001	/	/

4 OPERATIONAL CONDITIONS DURING TEST

4.1 Schematic Test Configuration

During SAR test, EUT is in Traffic Mode (Channel Allocated) at Normal Voltage Condition.

The EUT operate in channel 1, 2, 3, 4, 5, 6.

The EUT shall use its internal transmitter. The antenna(s), battery and accessories shall be those specified by the manufacturer. The EUT battery must be fully charged and checked periodically during the test to ascertain uniform power output. If a wireless link is used, the antenna connected to the output of the base station simulator shall be placed at least 50 cm away from the handset.

The signal transmitted by the simulator to the antenna feeding point shall be lower than the output power level of the handset by at least 35 dB.

4.2 SAR Measurement System

The SAR measurement system being used is the IndexSAR SARA2 system, which consists of a

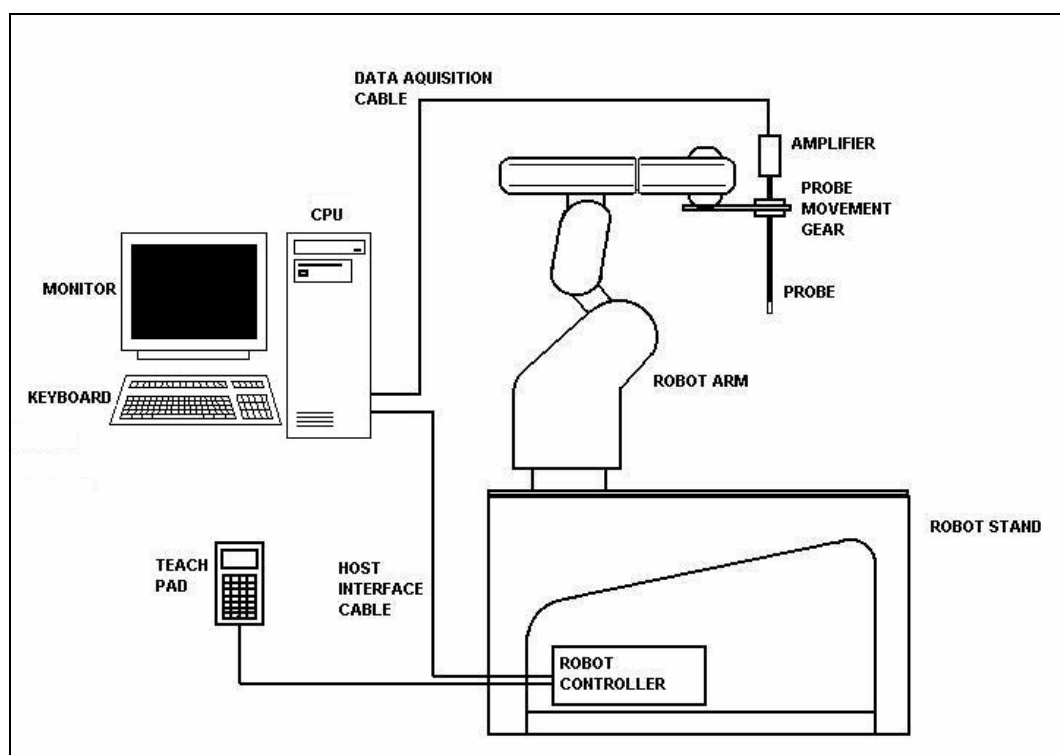

Figure1. SAR Lab Test Measurement Set-up

Mitsubishi RV-E2 6-axis robot arm and controller, IndexSAR probe and amplifier and SAM phantom Head Shape. The system is controlled remotely from a PC, which contains the software to control the robot and data acquisition equipment. The software also displays the data obtained from test scans, and determine the averaged SAR values (averaging region 1 gram or 10 gram) for compliance testing.

The measurements are done by two scan: first a coarse scan (2-Division) determines the region of the maximum SAR, afterwards the averaged SAR is measured in a second scan within the shape of a cube. The measurement time takes about 20 minutes.

4.2.1 Robot system specification

The robot is used to articulate the probe to programmed positions inside the phantom head to obtain the SAR readings from the DUT.



Robot and Stand

Type	Mitsubishi Movemaster RV-2A / 6 axis vertical articulated robot
Dimensions (robot)	Height: 790mm (in home position)
Dimensions (robot stand)	1010L x 450W x 820H mm
Weight	Approx. 36 kg
Position repeatability	+/- 0.04mm
Drive Method	AC servomotor
Expandability	Extra axis expansion capability for probe calibration applications E-Field probe



Robot Controller Unit

Type	CR1 - 571
Dimensions	212W x 290D x 151H mm
Weight	8 kg
Power source	single-phase 100 - 240 VAC

4.2.2 Probe and amplifier specification

IXP-050 Indexsar isotropic immersible SAR probe

The probes are constructed using three orthogonal dipole sensors arranged on an interlocking, triangular prism core. The probes have built-in shielding against static charges and are contained within a PEEK cylindrical enclosure material at the tip (showed in figure 2). The system uses diode compression potential (DCP) to determine SAR values for different types of modulation. Crest factor is not used for determining SAR values. The DCP for different types of modulation is determined during the probe

calibration procedure.

E-filed Probe	
Type	Three orthogonal dipole sensors arranged on triangular, interlocking substrates
Dimensions	Overall length: 350mm Tip length: 10mm Body diameter: 12mm Tip diameter: 5mm Distance from probe tip to dipole centers: 2.5mm
Interfacing	Lemo 6 pole latching connector for interfacing to high impedance amplifier
Isotropy	+/- 0.5dB in brain liquids (rotation about probe axis) typically +/- 0.15dB +/- 0.5dB in brain liquids (rotation normal to probe axis)
Calibration	Indexsar calibration in brain tissue simulating liquids at frequency of 900MHz, 1800MHz and 1800MHz
Dynamic Range	0.001W/kg to 100W/kg in liquid. Linearity +/- 0.2W/kg

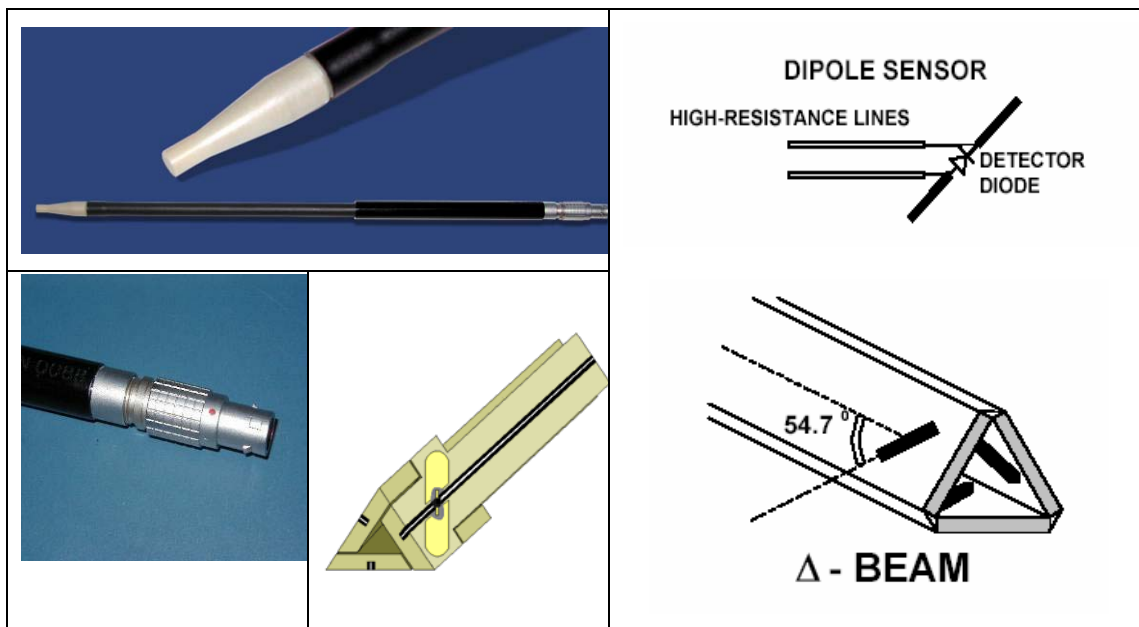
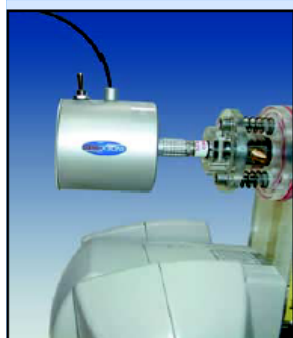

Figure2. Specification and characterisation parameters of indexsar probe

IFA-010 Amplifier

The amplifier unit has a multi-pole connector to connect to the probe and a multiplexer selects between the 3-channel single-ended inputs. A 16-bit AtoD converter with programmable gain is used along with an on-board micro-controller with non-volatile firmware. Battery life is around 150 hours and data are transferred to the PC via 3m of duplex optical fibre and a self-powered RS232 to optical converter.



Probe Amplifier and PC Interface

Type	High impedance inputs with 3 independent x,y,z sensor channels giving simultaneous measurement data every 2ms. Reads true average of modulated signals without the need for duty cycle corrections
Ranges	Software selectable of x1 to 63
Cable	Optical cable with self-powered 9 way RS232 converter. 3m cable length supplied as standard. Other lengths to order.
Power Requirements	2 x AAA batteries giving approximately 100 hours usage.

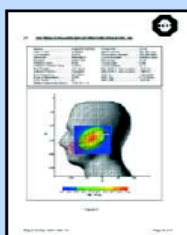

'Word' report format

The results of each frequency scan are presented in a Microsoft 'Word' document with all the necessary measurement parameters automatically tabulated. Users can customise the layout and in some cases language changes are possible.

4.2.3 Phantoms and simulant liquid

4.2.3.1 SAR head phantom (SAM)

The Indexsar SAM Upright Phantom is fabricated to the shape defined in these CAD files by Antennessa.



Head Phantom

Type 2	Upright SAM phantom
Dimensions	Height: 320mm Baseplate diameter: 275mm
Weight	empty: 1.2 kg filled: 7.2 kg
Wall thickness	2.0 mm \pm 0.2
Construction	Low loss resin / Strengthened saggital seam

It is mounted on the base table, which holds the robotic positioner. Both mechanical and laser-based

registration systems are utilised to register the phantom position in relationship to the robot co-ordinate system. In the SARA2 implementation, the SAM phantom is mounted on a supporting table made of low dielectric loss material, which includes mounting brackets for DUT positioners, dipole holders and (optionally) a shelf for supporting larger devices like laptop computers.

4.2.3.2 Box phantom

The box phantom used for body testing and for validation is manufactured from Perspex.

IXB – 070 Specification and characterisation parameters

	Constructional details	
	Internal dimensions:	200mm x 200mm x 200mm
	Thickness of base:	2mm +/- 0.2mm
	Wall thickness:	4mm
	Material:	PMMA
	Frequency range	300MHz – 6GHz
	Dielectric properties	Relative permittivity 2.7 Loss tangent <0.02

Tissue-simulant volume required for 150mm depth (6 litres)

4.2.3.3 Simulant liquids

Simulant liquids that are used for testing at frequencies of 450MHz, which are made mainly of sugar, salt and water solutions may be left in the phantoms. Approximately 7litres are needed for an upright head compared to about 27litres for a horizontal bath phantom.

Ingredients (% by weight)	Frequency(MHz)	
	450	
Tissue Type	Head	Body
Water	N.A	N.A
Salt(NaCl)	N.A	N.A
Sugar	N.A	N.A
HEC	N.A	N.A
Bacterial de	N.A	N.A
DGBE	N.A	N.A
Acticide SPX	N.A	N.A
Dielectric Constant	43.5	56.7
Conductivity (S/m)	0.87	0.94

4.2.4 SAR measurement procedure

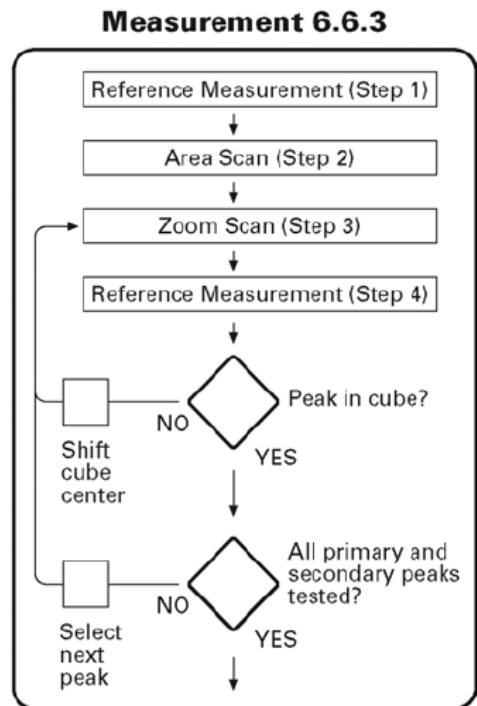
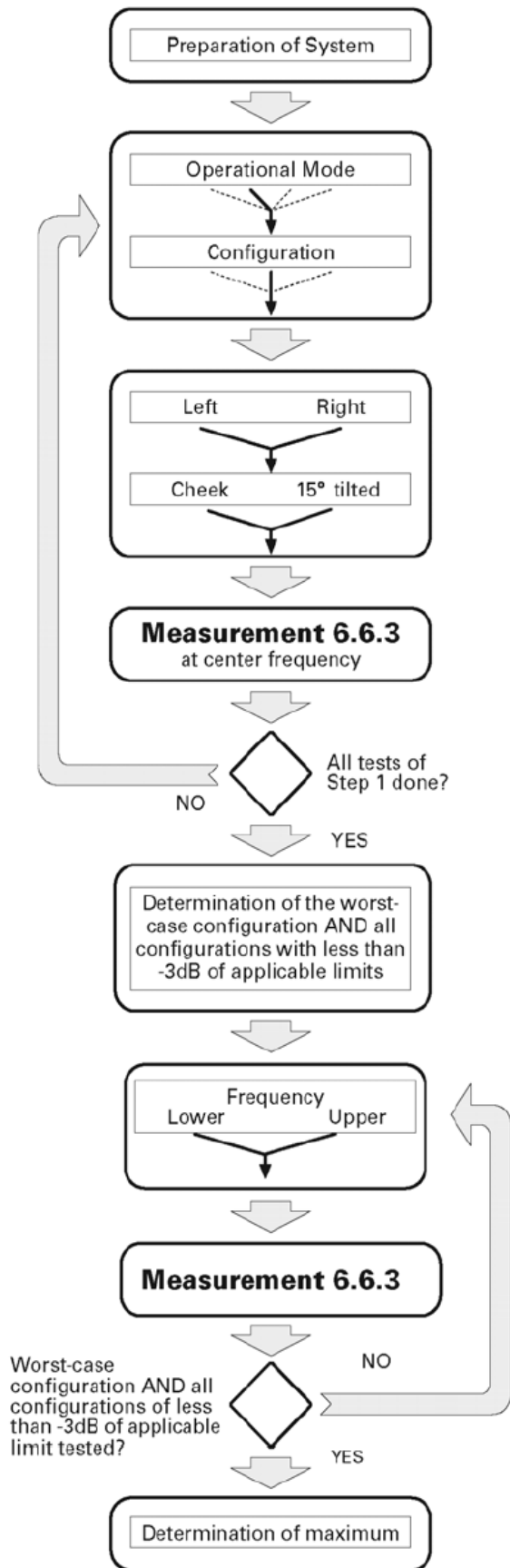

Channel	Left				Right			
	Check		Tilt		Check		Tilt	
	Retracted	Extended	Retracted	Extended	Retracted	Extended	Retracted	Extended
Mode 1:								
High			S2(-1.4dB)	S2(-0.4dB)			S2(-2.2dB)	S2(-1.4dB)
Middle	S1(-4dB)	S1(-4dB)	S1(-1.5dB)	S1(-0.5dB)	S1(-5dB)	S1(-5dB)	S1(-2.5dB)	S1(-1.5dB)
Low			S2(-1.3dB)	S2(-0.7dB)			S2(-2.7dB)	S2(-0.6dB)
Mode 2:								
High			S2(-2.7dB)	S2(-1.1dB)				
Middle	S1(-5dB)	S1(-5dB)	S1(-2.5dB)	S1(-1dB)	S1(-6dB)	S1(-6dB)	S1(-5dB)	S1(-5dB)
Low			S2(-2.2dB)	S2(-0.8dB)				

After an area scan has been done at a fixed distance of 8mm from the surface of the phantom on the source side, a 3D scan is set up around the location of the maximum spot SAR. First, a point within the scan area is visited by the probe and a SAR reading taken at the start of testing. At the end of testing, the probe is returned to the same point and a second reading is taken. Comparison between these start and end readings enables the power drift during measurement to be assessed.

Above is the scanning procedure flow chart and table from the IEEE p1528 standard. This is the procedure for which all compliant testing should be carried out to ensure that all variations of the device position and transmission behaviour are tested.

4.2.5 Validation testing using box phantoms

The following procedure, recommended for performing validation tests using box phantoms is based on the procedures described in the draft IEEE standard P1528. Setup according to the setup diagram below :

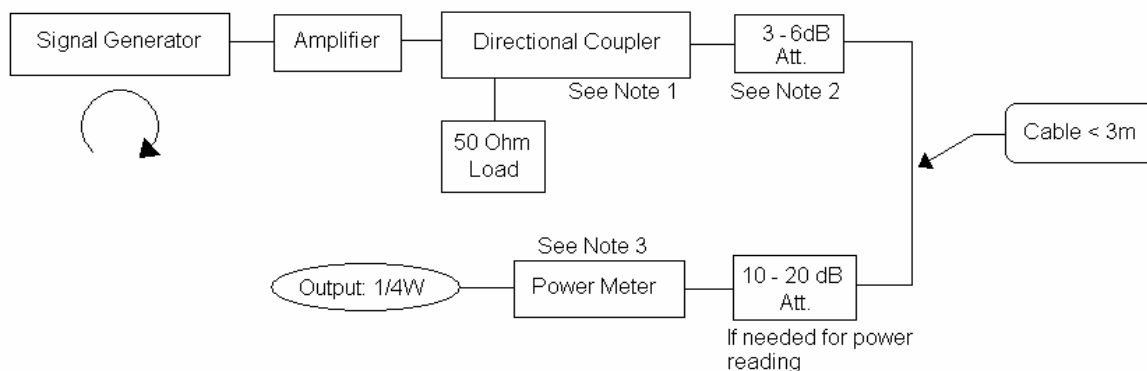

No. SAR09-018

With the SG and Amp and with directional coupler in place, set up the source signal at the relevant frequency and use a power meter to measure the power at the end of the SMA cable that you intend to connect to the balanced dipole. Adjust the SG to make this, say, 0.25W (24 dBm). If this level is too high to read directly with the power meter sensor, insert a calibrated attenuator (e.g. 10 or 20 dB) and make a suitable correction to the power meter reading.

Note 1: In this method, the directional coupler is used for monitoring rather than setting the exact feed power level. If, however, the directional coupler is used for power measurement, you should check the frequency range and power rating of the coupler and measure the coupling factor (referred to output) at the test frequency using a VNA.

Note 2: Remember that the use of a 3dB attenuator (as shown in Figure 8.1 of P1528) means that you need an RF amplifier of 2 times greater power for the same feed power. The other issue is the cable length. You might get up to 1dB of loss per meter of cable, so the cable length after the coupler needs to be quite short.

Note 3: For the validation testing done using CW signals, most power meters are suitable. However, if you are measuring the output of a modulated signal from either a signal generator or a handset, you must ensure that the power meter correctly reads the modulated signals.

4.2.5.1 Setting up the box phantom for validation testing

The main purpose of the box phantom is for validation of the system. By placing the box phantom in place of the upright head, using the box phantom dipole holder the system can now be used to check that the probe and software are giving accurate readings.

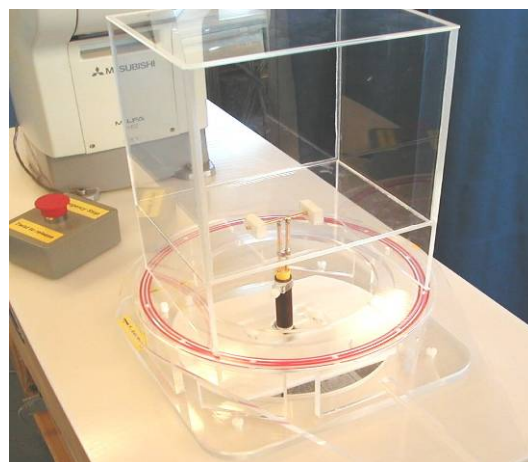

4.2.5.2 Equipments and results of validation testing

Equipments :

name	Type and specification
Signal generator	SML02
Directional coupler	450MHz-3GHz
Amplifier	3W 502(10-2500MHz)
Reference dipole	IXD-045 validation dipole

Results:

Frequency	Date	Target value(1g) W/kg	Test value(1g) W/kg
450MHz	2009.06.04	4.9	1.226*4=4.904 (Body)
		4.9	1.248*4=4.992 (Head)

4.2.6 Interpolation of 2D area scan

The 2D cubic B-spline interpolation is used after the initial area scan at fixed distance from the phantom shell wall. The initial scan data are collected with approx. 10mm spatial resolution and spline interpolation is used to find the location of the local maximum to within a 1mm resolution for positioning the subsequent 3D scanning.

4.2.7 Extrapolation of 3D scan

For the 3D scan, data are collected on a spatially regular 3D grid having (by default) 6.4 mm steps in the lateral dimensions and 3.5 mm steps in the depth direction (away from the source). SARA2 enables full control over the selection of alternative step sizes in all directions.

The digitised shape of the head is available to the SARA2 software, which decides which points in the 3D array are sufficiently well within the shell wall to be 'visited' by the SAR probe. After the data collection, the data are extrapolated in the depth direction to assign values to points in the 3D array closer to the shell wall. A notional extrapolation value is also assigned to the first point outside the shell wall so that subsequent interpolation schemes will be applicable right up to the shell wall boundary.

4.2.8 Interpolation of 3D scan and volume averaging

The procedure used for defining the shape of the volumes used for SAR averaging in the SARA2 software follow the method of adapting the surface of the 'cube' to conform with the curved inner surface of the phantom. This is called, here, the conformal scheme.

For each row of data in the depth direction, the data are extrapolated and interpolated to less than 1mm spacing and average values are calculated from the phantom surface for the row of data over distances corresponding to the requisite depth for 10g and 1g cubes. This results in two 2D arrays of data, which are then cubic B-spline interpolated to sub mm lateral resolution. A search routine then moves an averaging square around through the 2D array and records the maximum value of the corresponding 1g and 10g volume averages. For the definition of the surface in this procedure, the digitized position of the head shell surface is used for measurement in head-shaped phantoms. For measurements in rectangular, box phantoms, the distance between the phantom wall and the closest set of gridded data points is entered into the software. For measurements in box-shaped phantoms, this distance is under the control of the user. The effective distance must be greater than 2.5mm as this is the tip-sensor distance and to avoid interface proximity effects, it should be at least 5mm. A value of 6 or 8mm is recommended. This distance is called **dbe**.

For automated measurements inside the head, the distance cannot be less than 2.5mm, which is the radius of the probe tip and to avoid interface proximity effects, a minimum clearance distance of x mm is retained. The actual value of d_{be} will vary from point to point depending upon how the spatially regular 3D grid points fit within the shell. The greatest separation is when a grid point is just not visited due to the probe tip dimensions. In this case the distance could be as large as the step-size plus the minimum clearance distance (i.e with $x=5$ and a step size of 3.5, d_{be} will be between 3.5 and 8.5mm).

The default step size (d_{step}) used is 3.5mm, but this is under user-control. The compromise is with time of scan, so it is not practical to make it much smaller or scan times become long and power-drop influences become larger.

The robot positioning system specification for the repeatability of the positioning (d_{ss}) is ± 0.04 mm.

The phantom shell is made by an industrial moulding process from the CAD files of the SAM shape, with both internal and external moulds. For the upright phantoms, the external shape is subsequently digitized on a Mitutoyo CMM machine (Euro an ultrasonic sensor indicate that the shell thickness (d_{ph}) away from the ear is 2.0 ± 0.1 mm. The ultrasonic measurements were calibrated using additional mechanical measurements on available cut surfaces of the phantom shells. See support document IXS-020x.

For the upright phantom, the alignment is based upon registration of the rotation axis of the phantom on its 253mm diameter baseplate bearing and the position of the probe axis when commanded to go to the axial position. A laser alignment tool is provided (procedure detailed elsewhere). This enables the registration of the phantom tip (d_{mis}) to be assured to within approx. 0.2mm. This alignment is done with reference to the actual probe tip after installation and probe alignment. The rotational positioning of the phantom is variable – offering advantages for special studies, but locating pins ensure accurate repositioning at the principal positions (LH and RH ears).

4.2.9 Probe anisotropy and boundary proximity influence correction software (Virtual Probe Miniaturization VPM software)

Indexsar Report IXS0223 provides a background to the factors affecting measurements at high frequencies when using SAR probes of size 8 – 5mm tip diameter. Although the Indexsar probes are at the smaller end of this range, SAR probes are not isotropic in 5GHz phantom field gradients and additional precautions have to be taken in measurements. The following measures are recommended:

1) At >5 GHz, the SAR field decays to $1/e$ of its value within 3-4mm of the surface of a phantom with a



source adjacent. So, measurements are significantly affected by small errors in the separation distances employed between the probe and the phantom surface. The distance between the probe tip and the plane of the sensors should be allowed for using the same value as that declared in the probe calibration document. Distances between the probe tip and phantom surface should be measured accurately to 0.1mm. The best way to assure this is to use the robot to position the probe in light contact with the phantom wall and then to withdraw the probe by the selected amount under robot control.

2) The preferred test geometry at 5GHz is for testing at the bottom of an open phantom. If tests at the side of a phantom are performed, it will be necessary to apply VPM corrections as described below. In either case, careful monitoring of probe spacing from the phantom is required. Probe isotropy is improved for measuring fields polarized either normal to or parallel to the probe axis. If the source polarization is known, this arrangement should be established, if possible.

3) The probe calibration factors including boundary correction terms should be carefully entered from the calibration document. The probe calibration factors require that the probe be oriented in a known rotational position. The red spot on the Indexsar probe should be aligned facing away from the robot arm.

4) The latest SARA2 software (VPM editions) contain support for correcting for probe anisotropy in strong field gradients and include a procedure for correcting for boundary proximity influences. As noted above, the probe has to be oriented in a given rotational position and some familiarity with the new measurement procedures is necessary. The calculations can be performed either with or without the extended correction schemes applied.

5) If boundary corrections are used, it may be preferable to go rather closer to the phantom surface than is usually recommended and to perform scans using small steps between the measurement planes so that good data on the SAR profiles are collected within the first 10mm of the phantom depth.



5 CHARACTERISTICS OF THE TEST

5.1 Applicable Limit Regulations

47CFR § 2.1093: Radiofrequency Radiation Exposure Evaluation: Portable Devices

FCC OET Bulletin 65(Edition 97-01), Supplement C(Edition 01-01): Evaluating Compliance with FCC Guidelines for Human Exposure to Radiofrequency Electromagnetic Fields

ANSI C95.1–1999: IEEE Standard for Safety Levels with Respect to Human Exposure to Radio Frequency Electromagnetic Fields, 3 kHz to 300 GHz.

Table 1: Limits for Occupational/Controlled Exposure (W/kg)

Whole-Body	Partial-Body	Hands. Wrists. Feet and Ankles
0.4	8.0	20.0

Table 2: Limits for General Population/Uncontrolled Exposure (W/kg)

Whole-Body	Partial-Body	Hands. Wrists. Feet and Ankles
0.08	1.6	4.0

Note: Occupational/Controlled Exposure Partial-body limits 8 W/kg applied to EUT.

5.2 Applicable Measurement Standards

IEEE 1528–2003: Recommended Practice for Determining the Peak Spatial-Average Specific Absorption Rate (SAR) in the Human Body Due to Wireless Communications Devices: Experimental Techniques.

They specify the measurement method for demonstration of compliance with the SAR limits for such equipments.

6 LABORATORY ENVIRONMENT

Table: The Ambient Conditions during SAR Test

Temperature	Min. = 15 ° C, Max. = 30 ° C
Relative humidity	Min. = 30%, Max. = 70%
Ground system resistance	< 0.5 Ω
Ambient noise is checked and found very low and in compliance with requirement of standards.	
Reflection of surrounding objects is minimized and in compliance with requirement of standards.	

7 TEST RESULTS

7.1 Dielectric Performance

The measured 1-gram averaged SAR values of the device against the head is provided in Tables 1. The humidity and ambient temperature of test facility were 54% ~60% and 23.0°C ~23.9°C respectively. The flat phantom was full of the head tissue or body tissue simulating liquid. The EUT was supplied with full-charged battery for each measurement.

Table 1: Dielectric Performance of Body and Head Tissue Simulating Liquid

Temperature: 23.0~23.9° C, humidity: 54~60%.			
/	Frequency	Permittivity ϵ	Conductivity σ (S/m)
Target value	450 MHz(Body)	56.7	0.94
Validation value (June 11)	450 MHz(Body)	56.37	0.951
Target value	450 MHz(Head)	43.5	0.87
Validation value (June 10)	450 MHz(Head)	44.01	0.885

7.2 Summary of Measurement Results (450 MHz Band)

Temperature: 21.0~21.9° C, humidity: 48~58%.			
Limit of SAR (W/kg)	1 g Average		
	8.0		
Test Case	Measurement Result (W/kg)		
	1g Average 100% duty cycle (W/kg)	1g Average 50% duty cycle (W/kg)	Power level (dBm)
Side, Channel1_face	3.415	1.708	36.32
Side, Channel2_face	3.692	1.846	36.83
Side, Channel3_face	3.199	1.600	36.73
Side, Channel4_face	4.078	2.039	36.26
Side, Channel5_face	3.503	1.752	36.81
Side, Channel6_face	3.753	1.877	36.74
Side, Channel1_body	7.359	3.680	36.32
Side, Channel2_body	6.511	3.256	36.83
Side, Channel3_body	6.593	3.297	36.73
Side, Channel4_body	7.758	3.879	36.26
Side, Channel5_body	6.443	3.222	36.81
Side, Channel6_body	6.199	3.100	36.74

7.3 Conclusion

Localized Specific Absorption Rate (SAR) of this portable wireless device has been measured in all cases requested by the relevant standards cited in Clause 5.2 of this report. Maximum localized SAR is **below** exposure limits specified in the relevant standards cited in Clause 5.1 of this test report.

8 Measurement Uncertainty

No	Uncertainty Component	Type	Uncertainty Value (%)	Probability Distribution	k	c_i	Standard Uncertainty (%) $u_i(\%)$	Degree of freedom V_{eff} or v_i
Measurement System								
1	–Probe Calibration	B	3.6	N	1	1	3.60	∞
2	–Axial isotropy	B	4.23	R	$\sqrt{3}$	$\sqrt{1-cp}$	0.00	∞
3	–Hemispherical Isotropy	B	10.7	R	$\sqrt{3}$	\sqrt{cp}	6.18	∞
4	–Boundary Effect	B	1.7	R	$\sqrt{3}$	1	0.98	∞
5	–Linearity	B	2.98	R	$\sqrt{3}$	1	1.69	∞
6	–System Detection Limits	B	1.00	R	$\sqrt{3}$	1	0.60	∞
7	–Readout Electronics	B	1.00	N	1	1	1.00	∞
8	–Response Time	B	0.80	R	$\sqrt{3}$	1	0.50	∞
9	–Integration Time	B	2.60	R	$\sqrt{3}$	1	1.50	∞
10	–RF Ambient Conditions	B	3.00	R	$\sqrt{3}$	1	1.70	∞
11	–Probe Position Mechanical tolerance	B	1.14	R	$\sqrt{3}$	1	0.33	∞
12	–Probe Position with respect to Phantom Shell	B	2.86	R	$\sqrt{3}$	1	0.83	∞
13	–Extrapolation, Interpolation and Integration Algorithms for Max. SAR evaluation	B	3.6	R	$\sqrt{3}$	1	2.08	∞
Uncertainties of the DUT								



No. SAR09-018

14	–Position of the DUT	A	2.90	N	1	1	2.90	0
15	–Holder of the DUT	A	3.60	N	1	1	3.60	0
16	–Output Power Variation – SAR drift measurement	B	5.0	R	$\sqrt{3}$	1	2.89	∞
Phantom and Tissue Parameters								
17	–Phantom Uncertainty(shape and thickness tolerances)	B	1.43	R	$\sqrt{3}$	1	0.83	∞
18	–Liquid Conductivity Target – tolerance	B	5.0	R	$\sqrt{3}$	0.7	2.02	∞
19	–Liquid Conductivity – measurement Uncertainty)	B	2.0	R	$\sqrt{3}$	0.7	0.81	∞
20	–Liquid Permittivity Target tolerance	B	5.0	R	$\sqrt{3}$	0.6	1.73	∞
21	–Liquid Permittivity – measurement uncertainty	B	1.0	R	$\sqrt{3}$	0.6	0.35	∞
Combined Standard Uncertainty				RSS			$\pm 8.95\%$	
Expanded uncertainty (Confidence interval of 95 %)				K=	2.003935		$\pm 17.9\%$	

9 MAIN TEST INSTRUMENTS

No.	EQUIPMENT	TYPE	Due Date
1	E-Field SAR Probe	IXP-050 (SN 0201)	2010-03-27
2	Six-axis AC Servo industrial robot	RV-2A (SN AN406018)	2010-03-27
3	System Validation Dipole 450MHz	IXD-045(SN 0012)	2010-03-27
4	Probe Amplifier and PC Interface	IFA-010 (SN 0027)	2010-03-27
5	Flat Phantom	IXB-070	2010-03-27



ANNEX A
of
ShenZhen Electronic Product Quality Testing Center

CONFORMANCE TEST REPORT FOR
HUMAN EXPOSURE TO ELECTROMAGNETIC FIELDS

SAR REPORT
KIRISUN ELECTRONICS (SHENZHEN) CO., LTD
TWO-WAY RADIO
Accreditation Certificate

This Annex consists of 2 pages
Date of Report: 2009-06-12





China National Accreditation Service for Conformity Assessment

LABORATORY ACCREDITATION CERTIFICATE

(No. CNAS L1659)

China National Accreditation Service for Conformity Assessment has accredited

**Shenzhen Electronic Product Quality Testing Center
(CQCS Testing Co. Ltd.)**

Electronic Testing Building Wenguang Road, Shahe West, Xili Town, Nanshan
District, Shenzhen, Guangdong, China

to ISO/IEC 17025:1999 General Requirements for the Competence of Testing and Calibration Laboratories(CNAS-CL01 Accreditation Criteria for the Competence of Testing and Calibration Laboratories) for the competence in the field of testing and calibration.

The scope of accreditation is detailed in the attached schedule bearing the same accreditation number as above. The schedule forms an integral part of this certificate.

Date of Issue: 2007-01-17

Date of Expiry: 2009-10-08

Date of Initial Accreditation: 1999-08-03

Signed on behalf of China National Accreditation Service
for Conformity Assessment

China National Accreditation Service for Conformity Assessment(CNAS) is authorized by Certification and Accreditation Administration of the People's Republic of China (CNCA) to operate the national accreditation systems for conformity assessment. CNAS is the signatory to International Laboratory Accreditation Cooperation Multilateral Recognition Arrangement (ILAC MRA), and the signatory to Asia Pacific Laboratory Accreditation Cooperation Multilateral Recognition Arrangement (APLAC MRA).



ANNEX B
of
ShenZhen Electronic Product Quality Testing Center

CONFORMANCE TEST REPORT FOR
HUMAN EXPOSURE TO ELECTROMAGNETIC FIELDS

SAR REPORT

KIRISUN ELECTRONICS (SHENZHEN) CO., LTD

TWO-WAY RADIO

Type Name: PT4208-03

Hardware Version: --

Software Version: --

TEST LAYOUT

This Annex consists of 2 pages

Date of Report: 2009-06-12





Fig.1 SARA2 System Test Layout

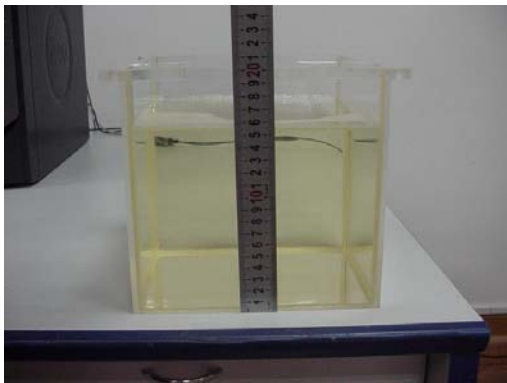

Fig.2 Depth of the head liquid

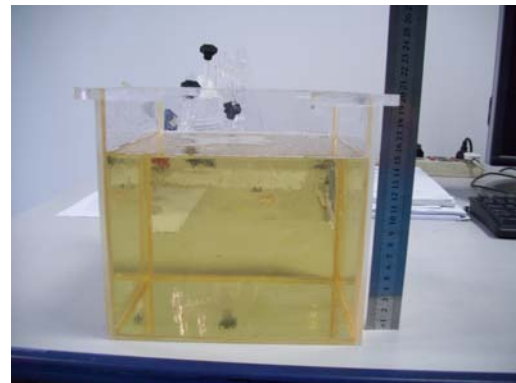

Fig.3 Depth of the body liquid



**Fig.4 Test position_face Position
(the EUT positioned 2.5cm from a flat phantom)**



**Fig.5 Test position_body Position
(the EUT's antenna positioned 2.8cm from a flat phantom)**



ANNEX C
of
ShenZhen Electronic Product Quality Testing Center

CONFORMANCE TEST REPORT FOR
HUMAN EXPOSURE TO ELECTROMAGNETIC FIELDS

SAR REPORT

KIRISUN ELECTRONICS (SHENZHEN) CO., LTD

TWO-way Radio

Type Name: PT4208-03

Sample Photographs

This Annex consists of 5 pages

Date of Report: 2009-06-12



No. SAR09-018

1. Photograph of the Equipment under Test

1.1. Appearance





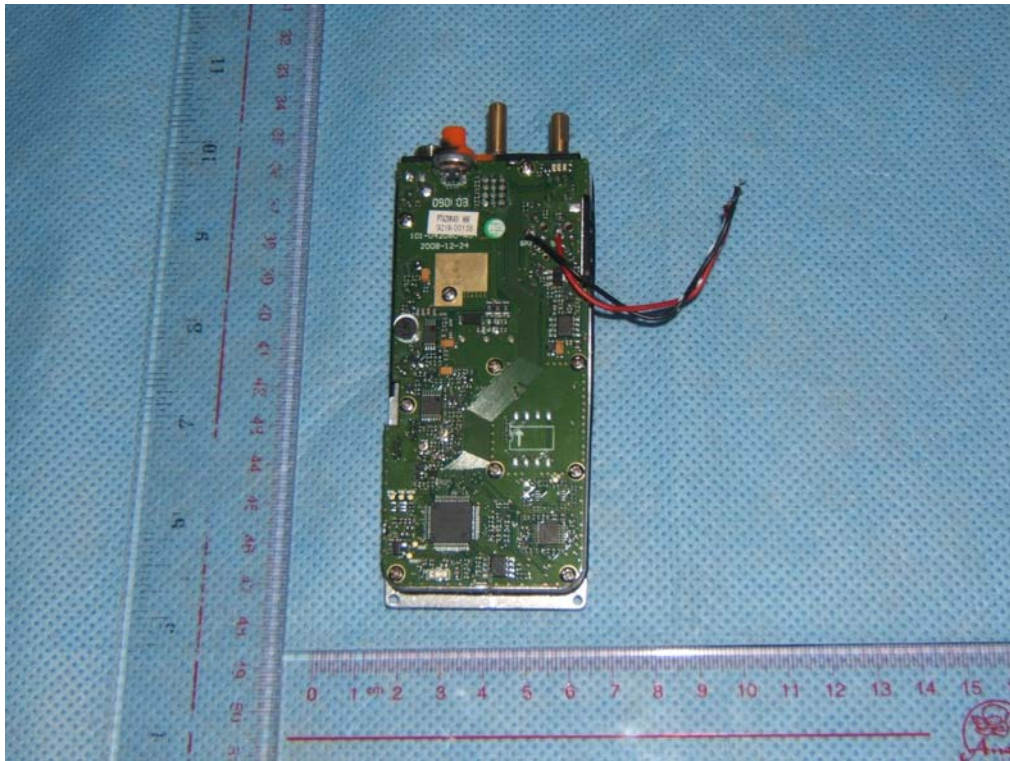

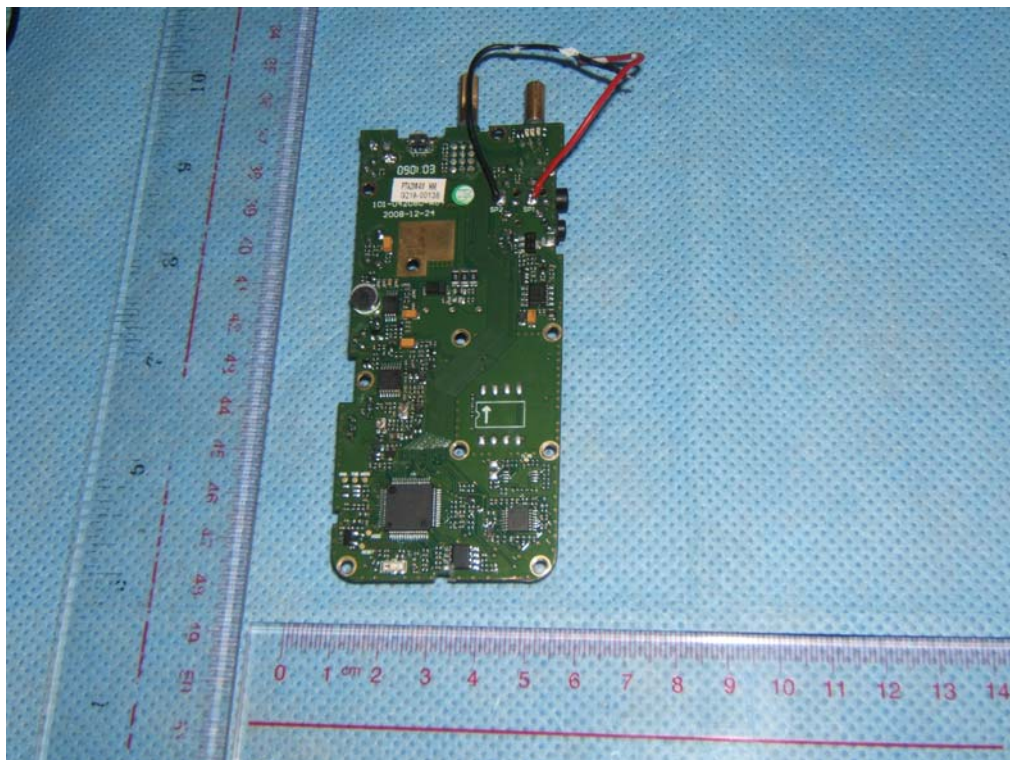
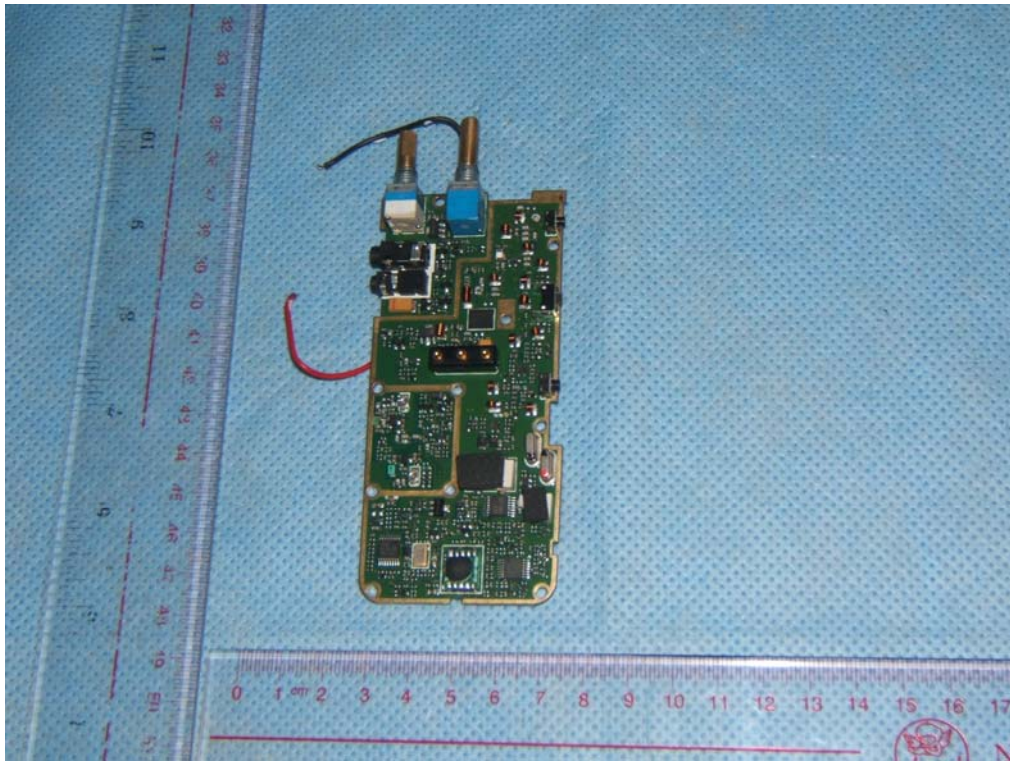



ANNEX D
of
ShenZhen Electronic Product Quality Testing Center

CONFORMANCE TEST REPORT FOR
HUMAN EXPOSURE TO ELECTROMAGNETIC FIELDS

SAR REPORT

KIRISUN ELECTRONICS (SHENZHEN) CO., LTD

TWO-WAY RADIO

Type Name: PT4208-03

Graph Test Results

This Annex consists of 7 pages

Date of Report: 2009-06-12



SAR Test PT4208-03 450MHz_face (Channel 1)

System / software:	SARA2 / 2.54 VPM	Input Power Drift:	0.15dB
Date / Time:	2009-6-10 14:32:49	DUT Battery Model/No:	
Filename:	PT4208_CHANNEL1_F ACETOMOUTH.txt	Probe Serial Number:	0201
Ambient Temperature:	23.4°C	Liquid Simulant:	HEAD LIQUID
Device Under Test:	PT4208	Relative Permittivity:	44.01
Relative Humidity:	56%	Conductivity:	.885
Phantom S/No:	HeadBox75mm.csv	Liquid Temperature:	23.4°C
Phantom Rotation:	0°	Max SAR X-axis Location:	-18.86 mm
DUT Position:	HEAD	Max SAR Y-axis Location:	-5.14 mm
Antenna Configuration:	BUILD INSIDE	Max E Field:	59.60 V/m
Test Frequency:	450MHz	SAR 1g:	3.415 W/kg
Air Factors:	354 / 376 / 470	SAR 10g:	2.829 W/kg
Conversion Factors:	.321 / .321 / .321	SAR Start:	1.657 W/kg
Type of Modulation:	FM	SAR End:	1.591 W/kg
Modn. Duty Cycle:	1	SAR Drift during Scan:	-4.02 %
Diode Compression Factors (V*200):	20 / 20 / 20	Probe battery last changed:	(2.90V)
Input Power Level:	MAX POWER	Extrapolation:	poly4

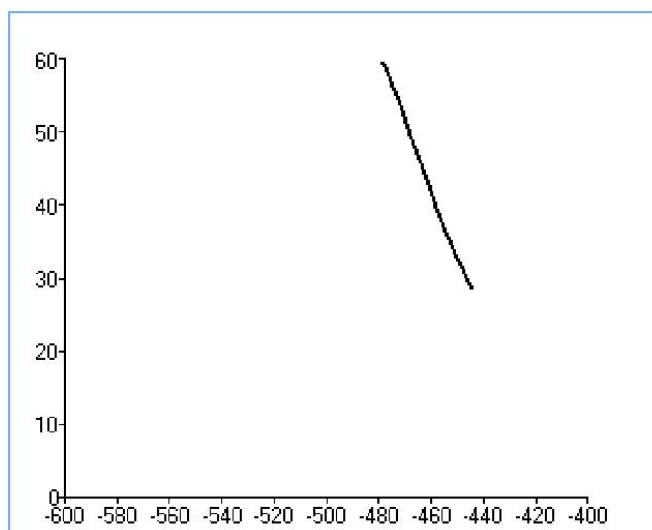
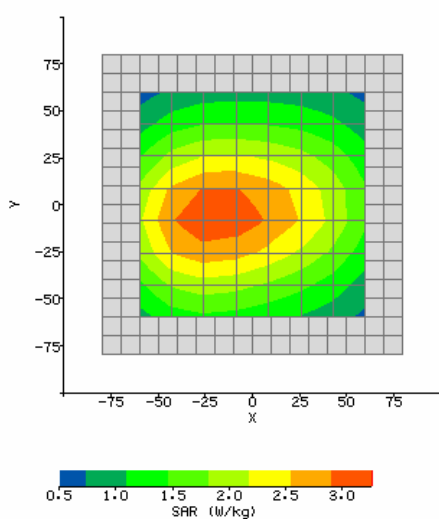

SAR Test PT4208-03 450MHz_face (Channel 2)

System / software:	SARA2 / 2.54 VPM	Input Power Drift:	0.12dB
Date / Time:	2009-6-10 14:10:14	DUT Battery Model/No:	
Filename:	PT4208_CHANNEL2_F ACETOMOUTH.txt	Probe Serial Number:	0201
Ambient Temperature:	23.4°C	Liquid Simulant:	HEAD LIQUID
Device Under Test:	PT4208	Relative Permittivity:	44.01
Relative Humidity:	56%	Conductivity:	.885
Phantom S/No:	HeadBox75mm.csv	Liquid Temperature:	23.4°C
Phantom Rotation:	0°	Max SAR X-axis Location:	-12.00 mm
DUT Position:	HEAD	Max SAR Y-axis Location:	-6.86 mm
Antenna Configuration:	BUILD INSIDE	Max E Field:	62.80 V/m
Test Frequency:	450MHz	SAR 1g:	3.692 W/kg
Air Factors:	354 / 376 / 470	SAR 10g:	2.923 W/kg
Conversion Factors:	.321 / .321 / .321	SAR Start:	2.374 W/kg
Type of Modulation:	FM	SAR End:	2.335 W/kg
Modn. Duty Cycle:	1	SAR Drift during Scan:	-2.09 %
Diode Compression Factors (V*200):	20 / 20 / 20	Probe battery last changed:	(2.90V)
Input Power Level:	MAX POWER	Extrapolation:	poly4

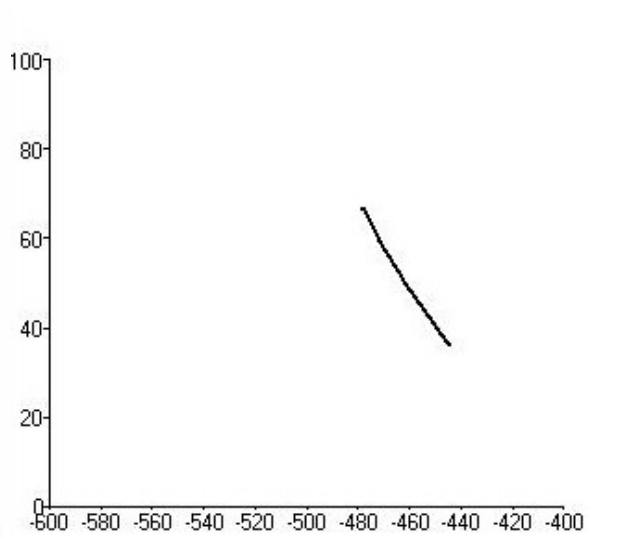
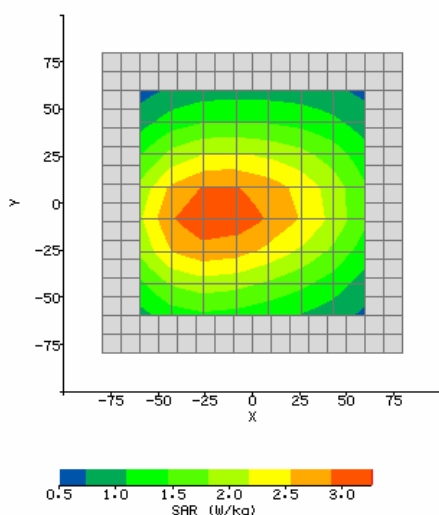

SAR Test PT4208-03 450MHz_face (Channel 3)

System / software:	SARA2 / 2.54 VPM	Input Power Drift:	0.11dB
Date / Time:	2009-6-10 14:53:46	DUT Battery Model/No:	
Filename:	PT4208_CHANNEL3_F ACETOMOUTH.txt	Probe Serial Number:	0201
Ambient Temperature:	23.4°C	Liquid Simulant:	HEAD LIQUID
Device Under Test:	PT4208	Relative Permittivity:	44.01
Relative Humidity:	56%	Conductivity:	.885
Phantom S/No:	HeadBox75mm.csv	Liquid Temperature:	23.4°C
Phantom Rotation:	0°	Max SAR X-axis Location:	-18.86 mm
DUT Position:	HEAD	Max SAR Y-axis Location:	-5.14 mm
Antenna Configuration:	BUILD INSIDE	Max E Field:	56.90 V/m
Test Frequency:	450MHz	SAR 1g:	3.199 W/kg
Air Factors:	354 / 376 / 470	SAR 10g:	2.615 W/kg
Conversion Factors:	.321 / .321 / .321	SAR Start:	1.647 W/kg
Type of Modulation:	FM	SAR End:	1.653 W/kg
Modn. Duty Cycle:	1	SAR Drift during Scan:	1.69 %
Diode Compression Factors (V*200):	20 / 20 / 20	Probe battery last changed:	(2.90V)
Input Power Level:	MAX POWER	Extrapolation:	poly4

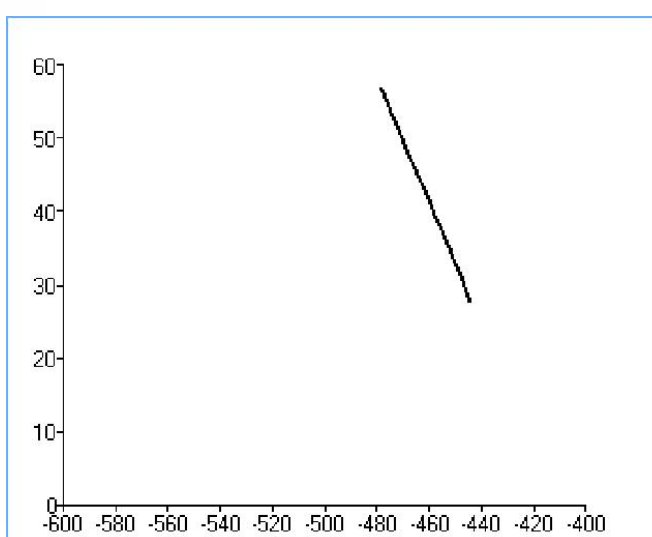
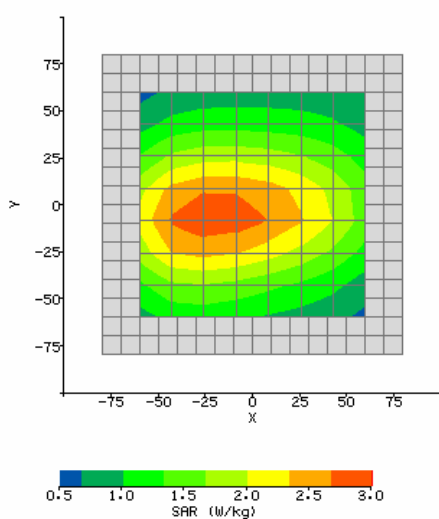

SAR Test PT4208-03 450MHz_face (Channel 4)

System / software:	SARA2 / 2.54 VPM	Input Power Drift:	0.16dB
Date / Time:	2009-6-10 15:22:16	DUT Battery Model/No:	
Filename:	PT4208_CHANNEL4_F ACETOMOUTH.txt	Probe Serial Number:	0201
Ambient Temperature:	23.4°C	Liquid Simulant:	HEAD LIQUID
Device Under Test:	PT4208	Relative Permittivity:	44.01
Relative Humidity:	56%	Conductivity:	.885
Phantom S/No:	HeadBox75mm.csv	Liquid Temperature:	23.4°C
Phantom Rotation:	0°	Max SAR X-axis Location:	-13.71 mm
DUT Position:	HEAD	Max SAR Y-axis Location:	-3.43 mm
Antenna Configuration:	BUILD INSIDE	Max E Field:	65.14 V/m
Test Frequency:	450MHz	SAR 1g:	4.078 W/kg
Air Factors:	354 / 376 / 470	SAR 10g:	3.380 W/kg
Conversion Factors:	.321 / .321 / .321	SAR Start:	1.976 W/kg
Type of Modulation:	FM	SAR End:	1.911 W/kg
Modn. Duty Cycle:	1	SAR Drift during Scan:	-3.31 %
Diode Compression Factors (V*200):	20 / 20 / 20	Probe battery last changed:	(2.90V)
Input Power Level:	MAX POWER	Extrapolation:	poly4

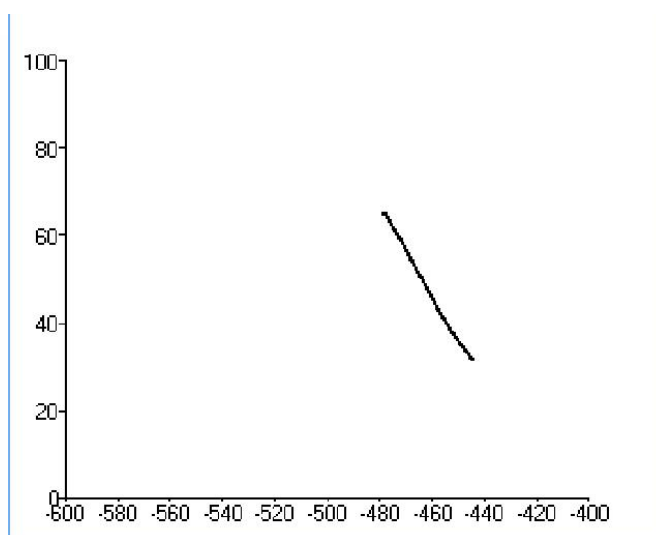
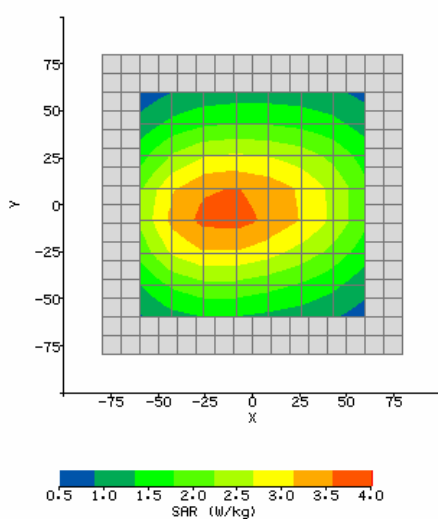

SAR Test PT4208-03 450MHz_face (Channel 5)

System / software:	SARA2 / 2.54 VPM	Input Power Drift:	0.09dB
Date / Time:	2009-6-10 15:44:56	DUT Battery Model/No:	
Filename:	PT4208_CHANNEL5_F ACETOMOUTH.txt	Probe Serial Number:	0201
Ambient Temperature:	23.4°C	Liquid Simulant:	HEAD LIQUID
Device Under Test:	PT4208	Relative Permittivity:	44.01
Relative Humidity:	56%	Conductivity:	.885
Phantom S/No:	HeadBox75mm.csv	Liquid Temperature:	23.4°C
Phantom Rotation:	0°	Max SAR X-axis Location:	-10.29 mm
DUT Position:	HEAD	Max SAR Y-axis Location:	-5.14 mm
Antenna Configuration:	BUILD INSIDE	Max E Field:	57.37 V/m
Test Frequency:	450MHz	SAR 1g:	3.503 W/kg
Air Factors:	354 / 376 / 470	SAR 10g:	2.421 W/kg
Conversion Factors:	.321 / .321 / .321	SAR Start:	1.720 W/kg
Type of Modulation:	FM	SAR End:	1.641 W/kg
Modn. Duty Cycle:	1	SAR Drift during Scan:	-2.50 %
Diode Compression Factors (V*200):	20 / 20 / 20	Probe battery last changed:	(2.90V)
Input Power Level:	MAX POWER	Extrapolation:	poly4

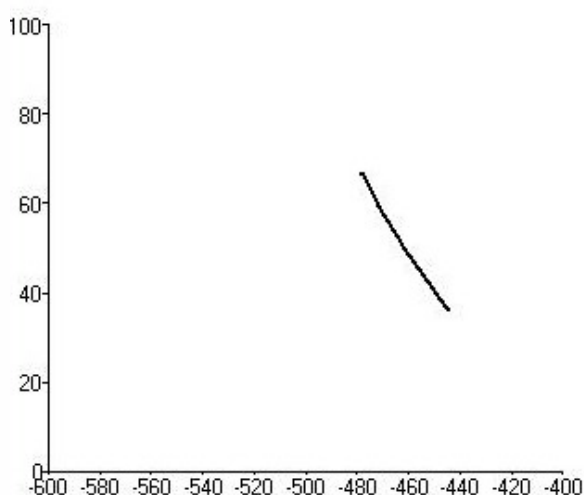
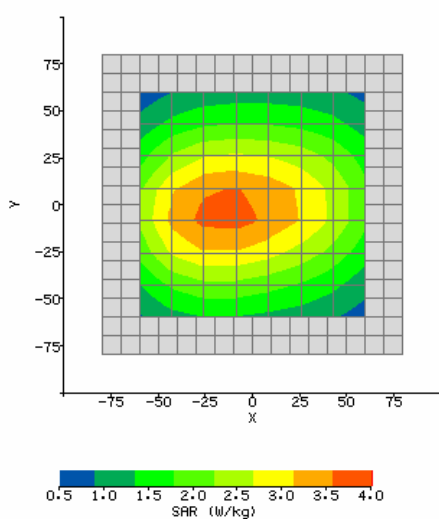

SAR Test PT4208-03 450MHz_face (Channel 6)

System / software:	SARA2 / 2.54 VPM	Input Power Drift:	0.11dB
Date / Time:	2009-6-10 16:04:46	DUT Battery Model/No:	
Filename:	PT4208_CHANNEL6_F ACETOMOUTH.txt	Probe Serial Number:	0201
Ambient Temperature:	23.4°C	Liquid Simulant:	HEAD LIQUID
Device Under Test:	PT4208	Relative Permittivity:	44.01
Relative Humidity:	56%	Conductivity:	.885
Phantom S/No:	HeadBox75mm.csv	Liquid Temperature:	23.4°C
Phantom Rotation:	0°	Max SAR X-axis Location:	-12.00 mm
DUT Position:	HEAD	Max SAR Y-axis Location:	-5.14 mm
Antenna Configuration:	BUILD INSIDE	Max E Field:	61.46 V/m
Test Frequency:	450MHz	SAR 1g:	3.753 W/kg
Air Factors:	354 / 376 / 470	SAR 10g:	3.039 W/kg
Conversion Factors:	.321 / .321 / .321	SAR Start:	1.889 W/kg
Type of Modulation:	FM	SAR End:	1.837 W/kg
Modn. Duty Cycle:	1	SAR Drift during Scan:	-3.05 %
Diode Compression Factors (V*200):	20 / 20 / 20	Probe battery last changed:	(2.90V)
Input Power Level:	MAX POWER	Extrapolation:	poly4

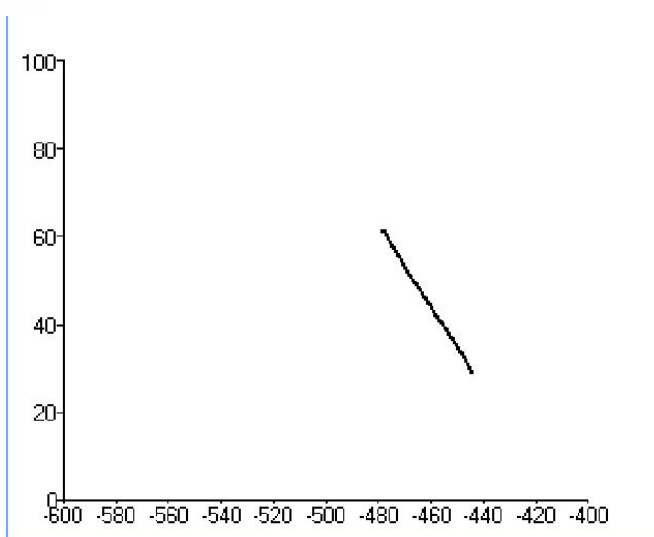
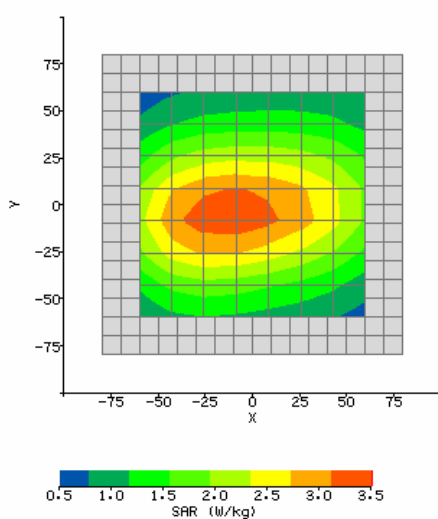

SAR Test PT4208-03 450MHz_body (Channel 1)

System / software:	SARA2 / 2.54 VPM	Input Power Drift:	0.09dB
Date / Time:	2009-6-11 15:31:07	DUT Battery Model/No:	
Filename:	PT4208_CHANNEL1_B ODY.txt	Probe Serial Number:	0201
Ambient Temperature:	23.4°C	Liquid Simulant:	BODY LIQUID
Device Under Test:	PT4208	Relative Permittivity:	56.37
Relative Humidity:	56%	Conductivity:	.951
Phantom S/No:	HeadBox75mm.csv	Liquid Temperature:	23.4°C
Phantom Rotation:	0°	Max SAR X-axis Location:	-20.57 mm
DUT Position:	BODY	Max SAR Y-axis Location:	13.71 mm
Antenna Configuration:	BUILD INSIDE	Max E Field:	80.06 V/m
Test Frequency:	450MHz	SAR 1g:	7.359 W/kg
Air Factors:	354 / 376 / 470	SAR 10g:	5.745 W/kg
Conversion Factors:	.326 / .326 / .326	SAR Start:	3.644 W/kg
Type of Modulation:	FM	SAR End:	3.687 W/kg
Modn. Duty Cycle:	1	SAR Drift during Scan:	1.98 %
Diode Compression Factors (V*200):	20 / 20 / 20	Probe battery last changed:	(2.90V)
Input Power Level:	MAX POWER	Extrapolation:	poly4

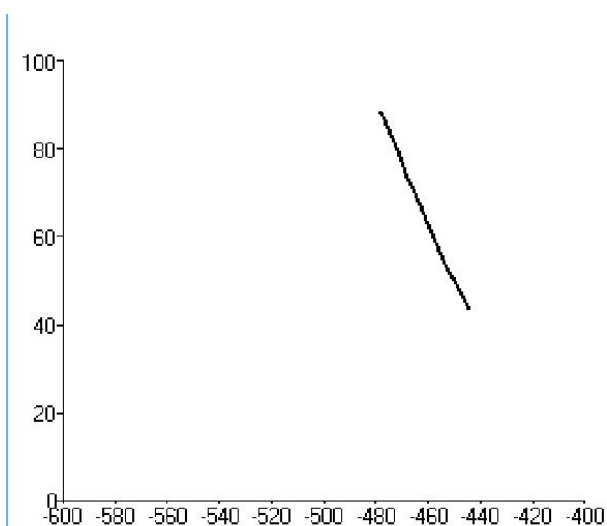
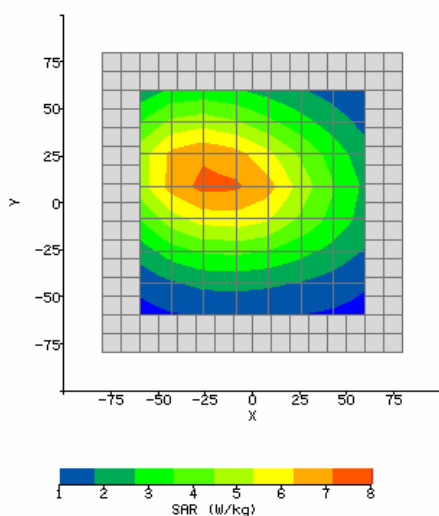

SAR Test PT4208-03 450MHz_ body (Channel 2)

System / software:	SARA2 / 2.54 VPM	Input Power Drift:	0.10dB
Date / Time:	2009-6-11 9:25:12	DUT Battery Model/No:	
Filename:	PT4208_CHANNEL2_B ODY.txt	Probe Serial Number:	0201
Ambient Temperature:	23.4°C	Liquid Simulant:	BODY LIQUID
Device Under Test:	PT4208	Relative Permittivity:	56.37
Relative Humidity:	56%	Conductivity:	.951
Phantom S/No:	HeadBox75mm.csv	Liquid Temperature:	23.4°C
Phantom Rotation:	0°	Max SAR X-axis Location:	0.00 mm
DUT Position:	BODY	Max SAR Y-axis Location:	8.57 mm
Antenna Configuration:	BUILD INSIDE	Max E Field:	78.73 V/m
Test Frequency:	450MHz	SAR 1g:	6.511 W/kg
Air Factors:	354 / 376 / 470	SAR 10g:	5.045 W/kg
Conversion Factors:	.326 / .326 / .326	SAR Start:	3.212 W/kg
Type of Modulation:	FM	SAR End:	3.186 W/kg
Modn. Duty Cycle:	1	SAR Drift during Scan:	-1.18 %
Diode Compression Factors (V*200):	20 / 20 / 20	Probe battery last changed:	(2.90V)
Input Power Level:	MAX POWER	Extrapolation:	poly4

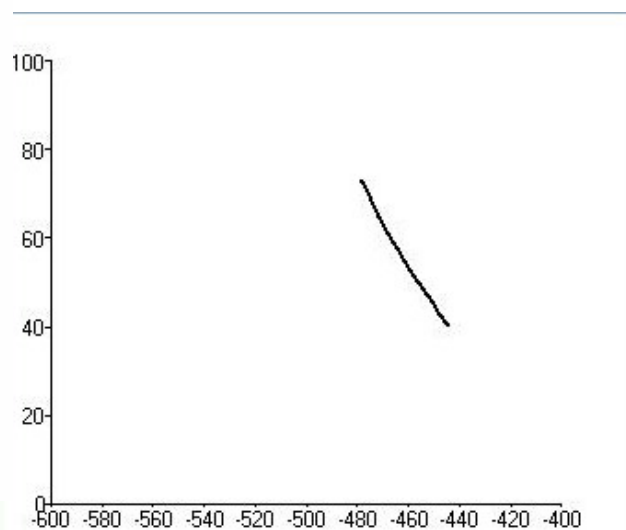
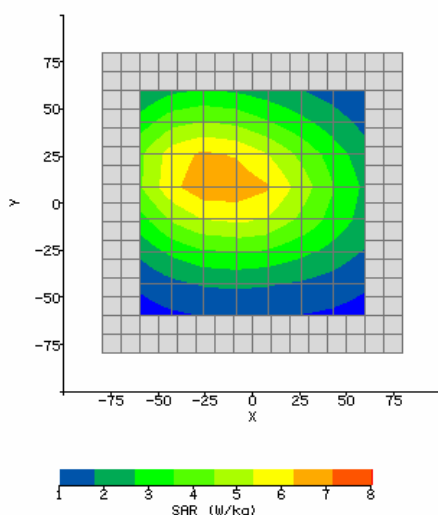

SAR Test PT4208-03 450MHz_ body (Channel 3)

System / software:	SARA2 / 2.54 VPM	Input Power Drift:	0.08dB
Date / Time:	2009-6-11 13:52:45	DUT Battery Model/No:	
Filename:	PT4208_CHANNEL1_F ACETOMOUTH.txt	Probe Serial Number:	0201
Ambient Temperature:	23.4°C	Liquid Simulant:	HEAD LIQUID
Device Under Test:	PT4208	Relative Permittivity:	44.01
Relative Humidity:	56%	Conductivity:	.885
Phantom S/No:	HeadBox75mm.csv	Liquid Temperature:	23.4°C
Phantom Rotation:	0°	Max SAR X-axis Location:	-6.86 mm
DUT Position:	HEAD	Max SAR Y-axis Location:	-6.86 mm
Antenna Configuration:	BUILD INSIDE	Max E Field:	81.12 V/m
Test Frequency:	450MHz	SAR 1g:	6.593 W/kg
Air Factors:	354 / 376 / 470	SAR 10g:	5.981 W/kg
Conversion Factors:	.321 / .321 / .321	SAR Start:	3.727 W/kg
Type of Modulation:	FM	SAR End:	3.663 W/kg
Modn. Duty Cycle:	1	SAR Drift during Scan:	-1.67 %
Diode Compression Factors (V*200):	20 / 20 / 20	Probe battery last changed:	(2.90V)
Input Power Level:	MAX POWER	Extrapolation:	poly4

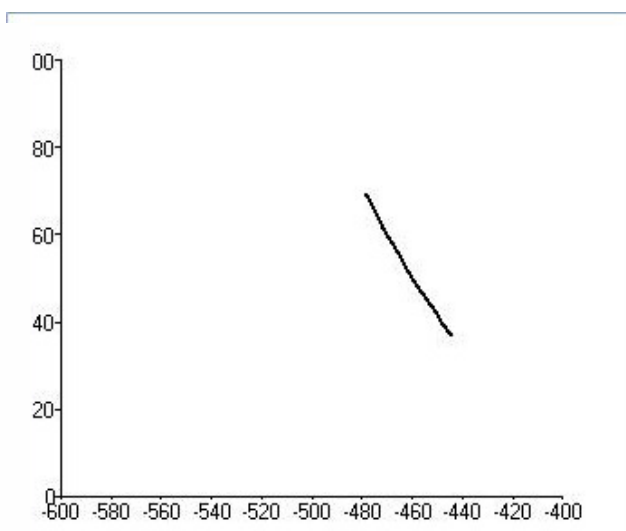
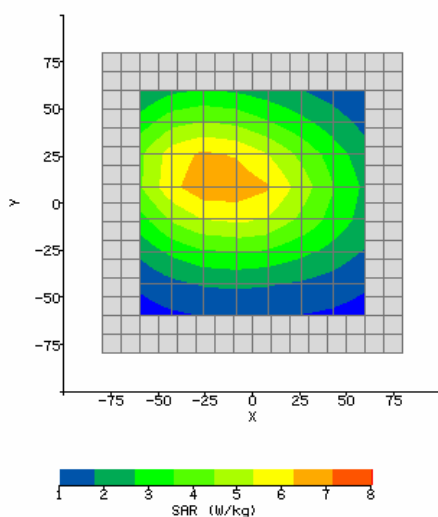

SAR Test PT4208-03 450MHz_body (Channel 4)

System / software:	SARA2 / 2.54 VPM	Input Power Drift:	0.07dB
Date / Time:	2009-6-11 14:27:27	DUT Battery Model/No:	
Filename:	PT4208_CHANNEL4_B ODY.txt	Probe Serial Number:	0201
Ambient Temperature:	23.4°C	Liquid Simulant:	BODY LIQUID
Device Under Test:	PT4208	Relative Permittivity:	56.37
Relative Humidity:	56%	Conductivity:	.951
Phantom S/No:	HeadBox75mm.csv	Liquid Temperature:	23.4°C
Phantom Rotation:	0°	Max SAR X-axis Location:	-17.14 mm
DUT Position:	BODY	Max SAR Y-axis Location:	12.00 mm
Antenna Configuration:	BUILD INSIDE	Max E Field:	85.84 V/m
Test Frequency:	450MHz	SAR 1g:	7.758 W/kg
Air Factors:	354 / 376 / 470	SAR 10g:	6.267 W/kg
Conversion Factors:	.326 / .326 / .326	SAR Start:	3.689 W/kg
Type of Modulation:	FM	SAR End:	3.614 W/kg
Modn. Duty Cycle:	1	SAR Drift during Scan:	-2.02 %
Diode Compression Factors (V*200):	20 / 20 / 20	Probe battery last changed:	(2.90V)
Input Power Level:	MAX POWER	Extrapolation:	poly4

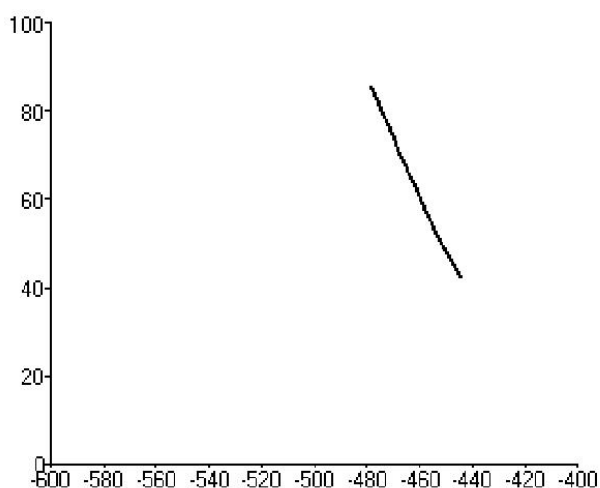
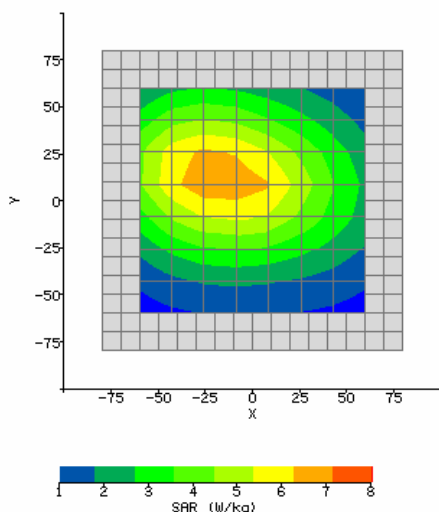

SAR Test PT4208-03 450MHz_body (Channel 5)

System / software:	SARA2 / 2.54 VPM	Input Power Drift:	0.09dB
Date / Time:	2009-6-11 9:40:14	DUT Battery Model/No:	
Filename:	PT4208_CHANNEL5_B ODY.txt	Probe Serial Number:	0201
Ambient Temperature:	23.4°C	Liquid Simulant:	BODY LIQUID
Device Under Test:	PT4208	Relative Permittivity:	56.37
Relative Humidity:	56%	Conductivity:	.951
Phantom S/No:	HeadBox75mm.csv	Liquid Temperature:	23.4°C
Phantom Rotation:	0°	Max SAR X-axis Location:	3.43 mm
DUT Position:	BODY	Max SAR Y-axis Location:	12.00 mm
Antenna Configuration:	BUILD INSIDE	Max E Field:	78.10 V/m
Test Frequency:	450MHz	SAR 1g:	6.443 W/kg
Air Factors:	354 / 376 / 470	SAR 10g:	4.993 W/kg
Conversion Factors:	.326 / .326 / .326	SAR Start:	3.178 W/kg
Type of Modulation:	FM	SAR End:	3.159 W/kg
Modn. Duty Cycle:	1	SAR Drift during Scan:	-0.60 %
Diode Compression Factors (V*200):	20 / 20 / 20	Probe battery last changed:	(2.90V)
Input Power Level:	MAX POWER	Extrapolation:	poly4

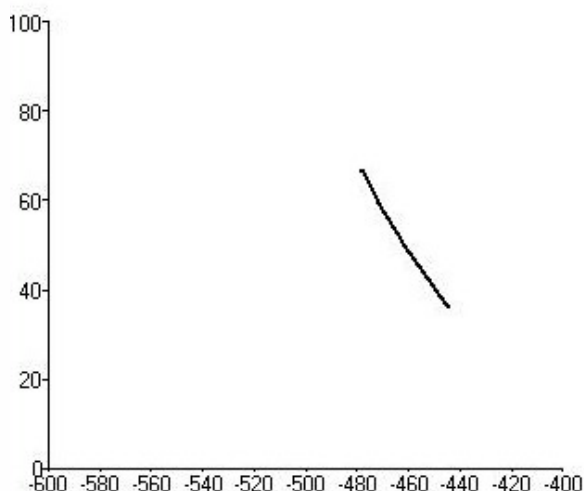
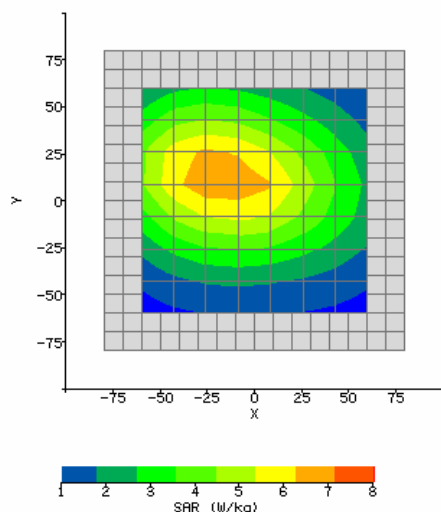

SAR Test PT4208-03 450MHz_body (Channel 6)

System / software:	SARA2 / 2.54 VPM	Input Power Drift:	0.07dB
Date / Time:	2009-6-11 16:04:46	DUT Battery Model/No:	
Filename:	PT4208_CHANNEL6_F ACETOMOUTH.txt	Probe Serial Number:	0201
Ambient Temperature:	23.4°C	Liquid Simulant:	BODY LIQUID
Device Under Test:	PT4208	Relative Permittivity:	56.37
Relative Humidity:	56%	Conductivity:	.951
Phantom S/No:	HeadBox75mm.csv	Liquid Temperature:	23.4°C
Phantom Rotation:	0°	Max SAR X-axis Location:	-20.57 mm
DUT Position:	BODY	Max SAR Y-axis Location:	10.29 mm
Antenna Configuration:	BUILD INSIDE	Max E Field:	75.29 V/m
Test Frequency:	450MHz	SAR 1g:	6.119 W/kg
Air Factors:	354 / 376 / 470	SAR 10g:	4.848 W/kg
Conversion Factors:	.326 / .326 / .326	SAR Start:	2.692 W/kg
Type of Modulation:	FM	SAR End:	2.678 W/kg
Modn. Duty Cycle:	1	SAR Drift during Scan:	-0.95 %
Diode Compression Factors (V*200):	20 / 20 / 20	Probe battery last changed:	(2.90V)
Input Power Level:	MAX POWER	Extrapolation:	poly4

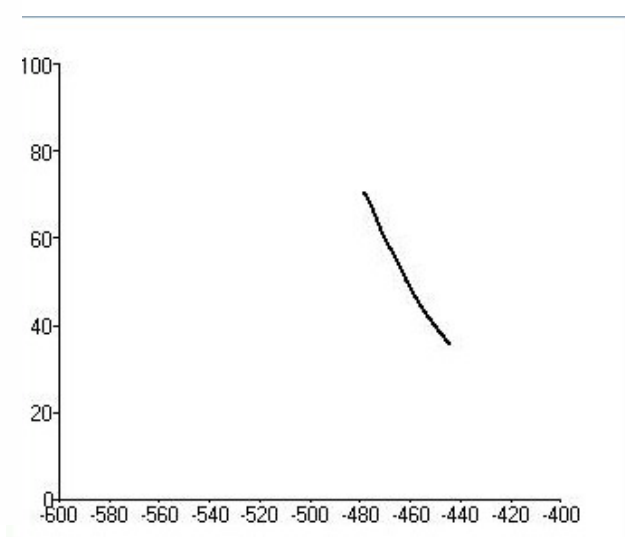
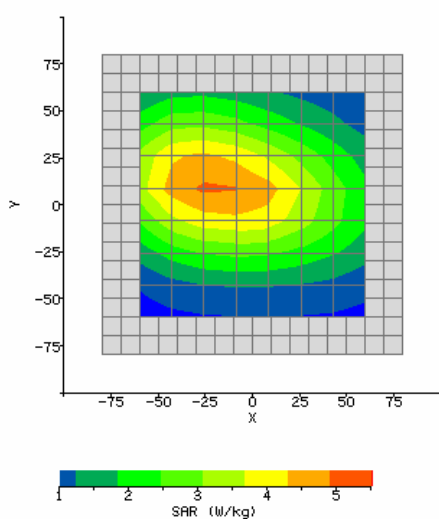



System Check Head 450MHz

System / software:	SARA2 / 2.54 VPM	Input Power Drift:	0.01dB
Date / Time:	2009-6-10 8:23:11	DUT Battery Model/No:	
Filename:	System Cheek_head _450MHz.txt	Probe Serial Number:	0201
Ambient Temperature:	23.4°C	Liquid Simulant:	BODY tissue
Device Under Test:	IXD-045	Relative Permittivity:	44.01
Relative Humidity:	56%	Conductivity:	.885
Phantom S/No:	HeadBox75mm.csv	Liquid Temperature:	23.4°C
Phantom Rotation:	180°	Max SAR X-axis Location:	0.00 mm
DUT Position:	450 head	Max SAR Y-axis Location:	0.00 mm
Antenna Configuration:	BUILD OUTSIDE	Max E Field:	21.71 V/m
Test Frequency:	450MHz	SAR 1g:	1.248 W/kg
Air Factors:	354 / 376 / 470	SAR 10g:	0.830 W/kg
Conversion Factors:	.321 / .321 / .321	SAR Start:	0.890 W/kg
Type of Modulation:	/	SAR End:	0.890 W/kg
Modn. Duty Cycle:	1	SAR Drift during Scan:	0.14 %
Diode Compression Factors (V*200):	20 / 20 / 20	Probe battery last changed:	(2.90V)
Input Power Level:	24dBm	Extrapolation:	poly4

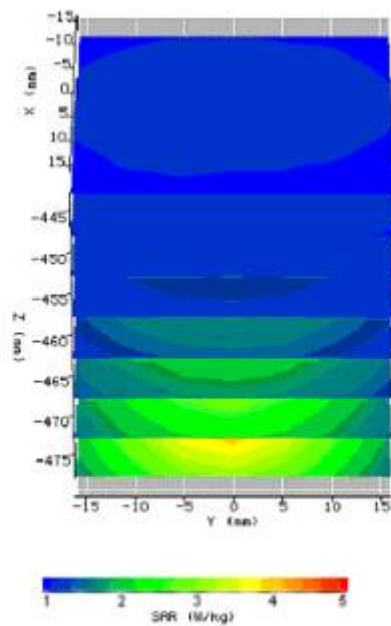

System Check Body 450MHz

System / software:	SARA2 / 2.54 VPM	Input Power Drift:	0.01dB
Date / Time:	2009-6-11 8:27:51	DUT Battery Model/No:	
Filename:	System Cheek_body _450MHz.txt	Probe Serial Number:	0201
Ambient Temperature:	23.4°C	Liquid Simulant:	HEAD tissue
Device Under Test:	IXD-045	Relative Permittivity:	56.37
Relative Humidity:	57%	Conductivity:	.951
Phantom S/No:	HeadBox75mm.csv	Liquid Temperature:	23.4°C
Phantom Rotation:	180°	Max SAR X-axis Location:	0.00 mm
DUT Position:	450 bday	Max SAR Y-axis Location:	0.00 mm
Antenna Configuration:	---	Max E Field:	23.08 V/m
Test Frequency:	450MHz	SAR 1g:	1.226 W/kg
Air Factors:	354 / 376 / 470	SAR 10g:	0.854 W/kg
Conversion Factors:	.326 / .326 / .326	SAR Start:	0.880 W/kg
Type of Modulation:	/	SAR End:	0.880 W/kg
Modn. Duty Cycle:	1	SAR Drift during Scan:	0.04 %
Diode Compression Factors (V*200):	20 / 20 / 20	Probe battery last changed:	20/05/05
Input Power Level:	24dBm	Extrapolation:	poly4

