



PT3800(1)
FM HANDHELD TRANSCEIVER
USER'S MANUAL

USER'S MANUAL

PT-3800(1)

FM HANDHELD TRANSCEIVER

Greeting!

We are grateful for your purchase of this transceiver. We believe the transceiver, which always incorporates the latest technology, can bring great convenience to your life and work; we also believe that the quality and functions of the transceiver can meet your demands for reliable communication.

To make sure you can get familiar with the functions and proper operating methods of the transceiver, please read this user's manual carefully.

Caution:

Please read this manual carefully before using this transceiver.

- Do not use the transceiver or charge the battery in a flammable, explosive environment or in the areas where transceiver is prohibited, such as gas station, hospital, or airport.
- Do not use the transceiver in the areas where government prohibits.

- Do not expose the transceiver to direct sunlight for a long time, or place it close to heating appliances.
- Do not place the transceiver in excessively dusty, humid, wet areas, or on unstable surface.
- If an abnormal odor or smoke is detected coming from the transceiver, turn it off and remove the battery from the transceiver and promptly contact your local dealer.
- The maintaining of transceiver only can be done by professional technician.

Battery and Safety

1. Warranty Exclusions

- The company will not be responsible for any failure or safety accident generating by using the battery without following the “Battery and Safety Directions” .
- The company will not be responsible for any failure generating by mismatching circuit which is caused by using no autonomous producing products, like battery pack, charger and transceiver.
- The battery is guaranteed for service for 6 months after leaving the factory. In this period, if there is any abnormal condition from the battery, you are allowed to change a new one for free, but that is based on using the battery in conformity with the directions.

2. Conditions and Environment

- Using the special charger appointed by the company.
- If the battery charging is full, do not charge it repeatedly in a short time, or that will shorten battery's life or bring safety trouble to you. Please stop charging, if the battery is charged overtime, but not full.
- Do not place, charge or use the battery under the strong sunlight for a long time, or the battery may become heat, fire or fail to use.
- The battery has a protecting system for the circuit, it is prohibited to use the battery in the areas of heavy static (more than 100V) or high magnetic field, or the protecting system will be damaged and bring Safety trouble.
- The charging temperature is from -10°C to 40°C , please charge within this range, or the charger may start automatic protection to stop charging or the battery may be damaged.
- If an abnormal odor, leak or any other abnormal situation is detected coming from the battery, please do not use it, but return it to the dealer.

- Please keep the battery in the clean, dry and ventilated room with the temperature of $-5^{\circ}\text{C} \sim 35^{\circ}\text{C}$ and the relative humidity not more than 75%, avoid to contacting with any corrosive substance and keep away from the origin of fire and heat.
- If the extended storage is needed, please keep the battery in the clean, dry environment without any corrosive substance in the temperature of $-5^{\circ}\text{C} \sim 25^{\circ}\text{C}$. If the time is over three months, the battery should have a charging. If keep the battery in the unventilated environment with a temperature of over 40°C , the battery may leak, self-ignite or be damaged by reason of quickening the self discharge. The battery kept under the temperature of 40°C should be charged once a month and the charging status should be 50% of the battery capacity.
- The battery life will be shortened if using under the maximum conditions, such as limiting temperature, deep charging and discharging circulation and overcharging / over discharging.
- In the extended storage, the battery may be write-off or the capacity may reduce seriously without any charging and discharging maintenance.

3. Safety

To avoid the leaking, heating, firing or exploding of the battery, please comply with the following protective measures.

- Do not place the battery in the water; do not keep the battery in the damp, unventilated environment with a high temperature for a long time.
- Do not burn or heat the battery; do not use, place or charge the battery near the fire or other heat source (over 70°C).
- Do not reverse the power polarities; do not short-circuit the battery.
- Do not connect the battery with battery socket or car battery directly.

- Do not keep or transit the battery with metals (like necklace).
- Do not press or throw the battery; do not use obviously defective or twisted battery.
- Do not use nail or sharp materials to puncture the battery; do not beat or trample on the battery.
- Do not weld the battery directly.
- To avoid damaging the safety system of the battery, do not destroy or modify it; do not disassemble and assemble or remodel the battery.
- Do not put the battery in a microwave oven or pressure cooker.
- Do not use the battery together with the following batteries, such as one-shot batteries (alkaline cell) or secondary batteries of different capacities, brands, and standards or factories. A new battery can not be used together with an old one, though they are the same model.
- If the battery sends out abnormal odor, becomes heat, discolours or twists; or finding any abnormal while using, charging or keeping it, please remove the battery from the equipment or the charger and stop using it.
- If the battery leaks or sends out abnormal odor, please remove it from any open fire immediately, or the leaked electrolyte may fire and the battery may explode.
- Please keep children away from the battery, if children swallow the battery, please see a doctor immediately.
- If the battery leaks and the electrolyte goes into the eyes, do not rub them, but clean them and see a doctor immediately, or that may hurt your eyes.
- Do not reverse charge or forcibly over discharge the battery.
- Do not use the battery in other inappropriate equipments.

FCC INFORMATION

Warning: Modifying, tampering and/or adjusting this or replacement of any transmitter component (crystal, semiconductor, etc.) in this unit could result in a violation of the rules. Changes or modifications to this unit not expressly approved by the party responsible for compliance could void the user's authority to operate the equipment.

FCC Warning:

In cloning mode a US transmitter cannot be cloned with a non-US transmitter and cannot be made to operate on non-US frequencies. The user cannot force non-US frequencies in this mode.

The US version of this transmitter operates solely on US frequencies. The user is not able to select on non-US frequencies.







PT3800(1) is a occupational equipment. And it operate with a duty factor not exceeding 50%.

1. Unpacking and Checking Equipments

Carefully unpack the transceiver. We recommend that you identify the items listed in the following table before discarding the packing material. If any items are missing or have been damaged during shipment, please contact the carrier or dealer immediately.

Supplied Accessories

ITEM	QUANTITY
Antenna	1
Adapter	1
Wrist Loop	1
Desktop Charger	1
Battery	1
Belt Clip	1
Instruction Manual	1

 Antenna	 Adapter	 Wrist Loop
 Desktop Charger	 Battery	 Belt Clip

2. Preparation

(1) Charging the Battery Pack

- Plug the AC adaptor cable into the adaptor jack located on the rear of the charger; plug the AC adaptor into power socket of 220V/50Hz, the light turn green.

- Adjust the mounting bracket of the charger and slide the battery pack or the transceiver with the battery pack into the charger.

- Make sure the battery pack contacts are in contact with the charging terminals.

- The charger LED turns red and charging begins. The charging time depends on the battery capacity. After charging, the charger LED turns green and the charging is full. (Figure 1)

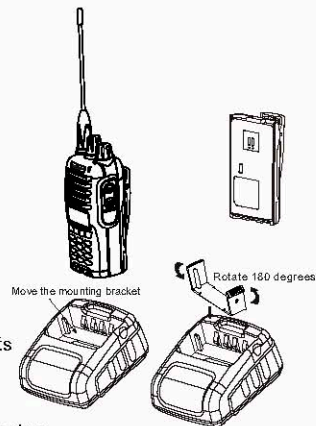

Caution:

- If the battery charging is full, do not charge it again. Overcharging will shorten battery's life or damage it.
- After purchasing or extended storage (more than 2 months), the battery cannot reach its maximum capacity for the first time recharging. After repeatedly charging and discharging the battery two or three times, the capacity will reach its normal status.
- The charger LED turns off when it detects that the battery has been damaged within the first 10 minutes of charging.
- The charger LED turns off when it is on the protecting status due to

over current or short circuit. Please cut off the power, and then turn on the power again to continue charging.

- If the charger tests out the temperature of the battery is too high (over 60°C), it will stop charging, and the charger LED turns yellow. After the temperature drops, remove the battery and re-put to continue charging.

(2) Installing / Removing the Battery Pack

- Match the two grooves of the battery pack with the corresponding guides on the back of the transceiver.
- Slide the battery pack along the back of the transceiver until the battery release latch on the base of the transceiver locks.
- To remove the battery pack, pull back on the release latch and slide the pack away from the transceiver (Figure2).

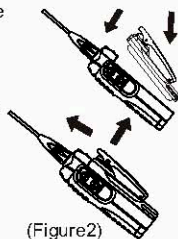

(Figure2)

Caution:

- * Do not short-circuit the battery terminals or dispose the battery into Fire.
- * Never attempt to remove the casing from the battery pack.
- * Do not install the battery pack in the dangerous environment, or sparks will cause explosion.
- * To avoid explosion, please do not place the battery in the high Temperature areas.

(3) Installing the Antenna

Screw the antenna into the connector on the top of the transceiver by holding the antenna at its base and turn it clockwise until secure (Figure3).



(Figure3)

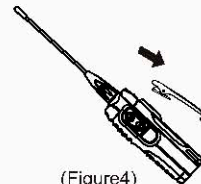

(Figure4)

(4) Installing / Removing the Belt Clip

Match the belt clip with the corresponding grooves on the battery and slide down the belt clip. To remove the belt clip, slide up the belt clip by your nail or tools (Figure4).

(5) Installing the Optional Speaker / Microphone

Remove the rubber cover and insert the speaker-microphone plugs into the SP/MIC jacks.

3. Getting Acquainted

(1) Exterior Figure

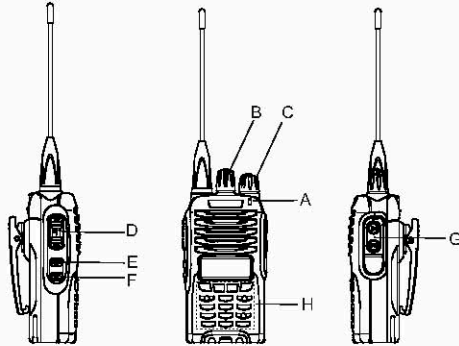

A.LED Indicator

LED lights red while transmitting; flashes red while the power appears low.

B.Channel Selector

Rotate to select channel or use with other keys to realize function setting.

C.Power / Volume Switch

Turn clockwise to switch ON the transceiver; to switch OFF,turn counterclockwise until a click is heard;rotate to adjust the volume Level.

D.PTT (Push-to-Talk)

To make a call,press and hold [PTT], then speak into the microphone with normal voice. Release [PTT] to receive a call.

E.Monitor Button

Press to disable the squelch, and release to enable the squelch

again.

F.Lamp Button

Press to light the screen and release for 5 seconds, auto light off; press again to turn off the light.

G.MIC-SP Jacks

For connecting external Microphone/ Speaker.

H.Keypad

Numeric Key: input numbers and function selection.

Function Key [F]: use with numeric keys to realize shortcut operation or function and parameter setting.

Menu Key [MENU]:press to enter the menu mode,use with the Channel Selector and [OK] or [PTT] to realize function setting.

Confirm Key [OK]:press to confirm or switch between the full-frequency display mode and the memory frequency mode.

Clear Key [CLR]: clear numbers or exit from the menu.

(2)LCD Display

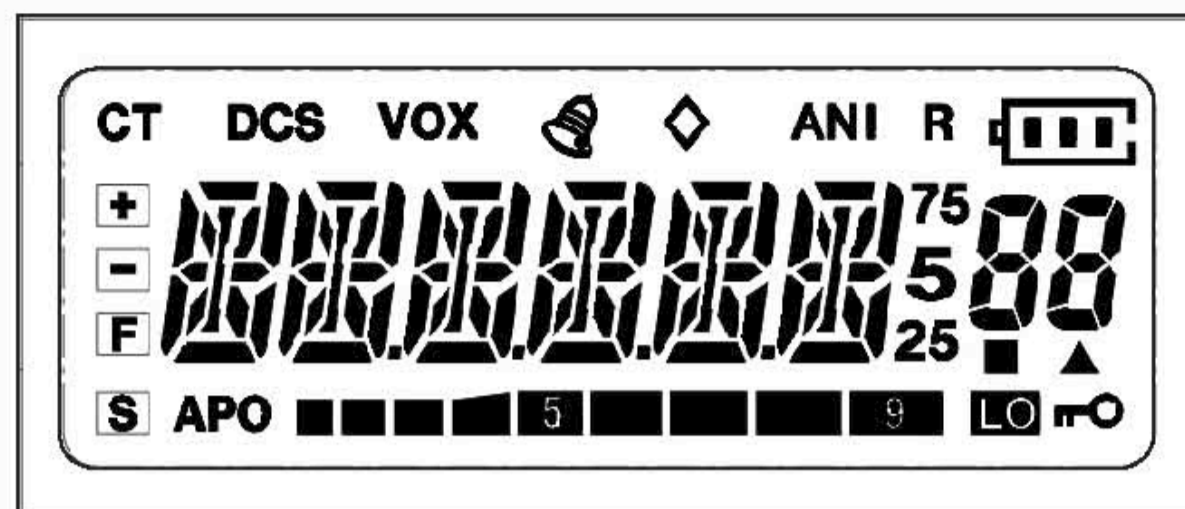

ICON	DESCRIPTION
F	Appear when [F] is pressed to enter the shortcut function menu.
LO	Appear when the transmitting output power is set low.
VOX	Appear when the Sound Control function is activated.
CT	Appear when the CTCSS function is activated.
DCS	Appear when the DCS function is activated.
+	Appear when “+” offset reverse frequency is set.
-	Appear when “-” offset reverse frequency is set.
R	Appear when the Reverse Frequency function is activated.
▲	Appear when the memory channel has contained data.
■	Appear when the channel number has been locked out.
S	Appear when the Battery Save function is activated.
APO	Appear when the Auto Power off function is activated.
■■■■■■■■	S-meter (RX) and relative RF power meter (TX).
1234567890	Display various alphanumeric information such as operating frequency or menu selection.
88	Display the channel number.
🔒	Appear when the keypad is locked.
🔋	Show the battery power.
🔊	Appear when the Beep function is activated.
◇	Appear when the Scrambler function is activated.
ANI	Appear when the ANI function is activated.

4.Basic Operation

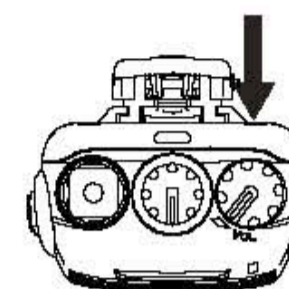

Switch on

Rotate Power / Volume Switch clockwise to turn on the transceiver. A “du” sounds and the transceiver is in the operational state.

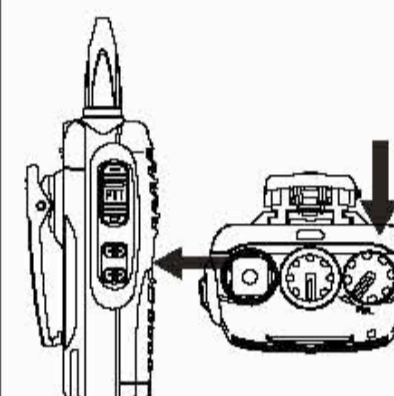

Adjust the Volume

Press and hold the Monitor Button and meanwhile rotate the Power / Volume Switch to adjust the volume.

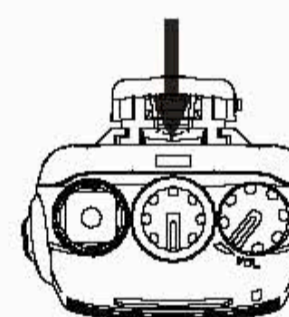

Select the Frequency/ Channel

In the full-frequency display mode, rotate the Channel Selector to select the desired frequency; in the memory frequency mode or the channel mode, rotate the Channel Selector to select the desired channel.

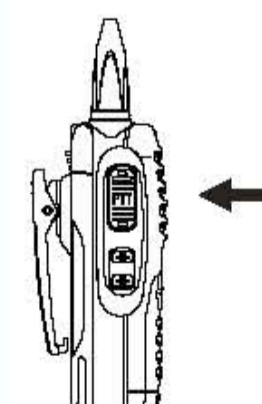

PTT Button

To make a call, press and hold [PTT], the red light appears, and then speaks into the microphone in your normal speaking voice.

● Adjusting the Squelch Level

- The purpose of the Squelch is to mute the speaker when no signals are present. While opening the squelch, you will hear the background noise from the speaker; while closing the squelch, you will not hear it.
- The selected squelch level will determine how strong the signal must be for opening and closing the squelch. If the selected squelch level is too high, you will fail to receive weak signals; if the selected squelch level is too low, you will open the squelch easily and hear the background noise.

● Adjusting the Squelch

- 1) Press [F], [1]
 - “SQL” and the current squelch level appear.
- 2) Rotate the Channel Selector to select the squelch level from 0 to 9.
 - Select the level at which the background noise is eliminated when no signal is present.
- 3) Press [OK] or [PTT] to keep the setting; press [CLR] to exit and quit the setting.

● Monitor

It is useful for you to use [MONI] when you want to receive weak signals or use with the Power/Volume Switch to adjust the volume level.

● Transmitting

To transmit, press and hold [PTT] and speak into the microphone.

- 1) Please keep the microphone about 3-5cm from your mouth, speak in your normal tone of voice to make sure that the receiver can get the

best tone.

- 2) When press [PTT], the status of the LED indicator on the top panel lights red.
- 3) Release [PTT] to receive.

● Receiving

When the channel is called, the LCD displays how strong the signal is, and you will hear the call. If the signal is weak and you have set a high squelch level, you may fail to hear the call.

If the CTCSS or DCS signaling has been programmed in your transceiver, you can only hear the call from the transmitter who has the same signaling. All the other calls will not be heard.

● Display Mode Selection

The transceiver has three display modes: memory frequency mode, full-frequency display mode and channel mode.

- 1) Turn off the transceiver, then press [MENU] and turn on the transceiver to switch between channel mode and memory frequency mode.
- 2) In the frequency mode, press [OK] to switch between full-frequency display mode and memory frequency mode.

● Selecting Channel

In the memory frequency mode or channel mode, selecting channel is available. Rotate the Channel Selector to select the desired channel. Rotate clockwise to increase the channel number, rotate counterclockwise to decrease it.

You can input the channel number directly by the keypad.

● Selecting Frequency

In the full-frequency display mode, selecting frequency is available. Rotate the Channel Selector to select the desired frequency. Rotate clockwise to increase the frequency; rotate counterclockwise to decrease the frequency, and then the selected frequency will appear on the screen (the frequencies change according to the step frequency).

Note: Please select a step frequency before selecting frequencies. For the setting of a step frequency, please refer to the “step” directions.

In the full-frequency display mode, inputting frequencies by the keypad is available. You can use the numeric keys of the transceiver to input frequencies directly. Press [CLR] to clear the wrong numbers.

5. Menu Setting

● Use Method

- 1) Press [MENU] to enter the menu mode, the menu items appear, the blinking digits on the right side is the item numbers.
- 2) Rotate the Channel Selector to select the desired item.
- 3) Press [OK] or [PTT] to confirm. Then rotate the Channel Selector to select function and parameter.
- 4) Press [OK] or [PTT] again to confirm.
- 5) Press [CLR] to exit from the menu.

● Menu Items

No.	Function	Option
1	SCAN (scan method)	CO / TO / SE
2	TOT (time-out timer)	OFF / 60 / 90 / 120 / 180
3	SAV (battery save setting)	ON / OFF
4	BP (Beep)	ON / OFF
5	KY (keypad lock)	MANU / AUTO
6	ENC (the Channel Selector on / off)	ON / OFF
7	APO (auto power off)	OFF / 30 / 60 / 120 / 240
8	ANI (identification display on / off)	ON / OFF

6. Channel Memory

● Memory Frequency

In the memory frequency, frequency memory and other parameters setting are available. There are 99 channels in the transceiver.

- 1) Enter the full-frequency display mode to select the frequency and other parameters (such as CTCSS, DCS, offset frequency, power, etc).
- 2) Press [MEMO], the memory channel number appears.
- 3) Rotate the Channel Selector or input the desired memory channel number directly. “▲” appears to show that the channel has contained data.
- 4) Press [OK] or [PTT] to keep the setting; press [CLR] to exit and quit the setting.

● CTCSS / DCS Setting

If the selected channel has been set CTCSS / DCS signaling, you will only hear the call from the transceiver with the same signaling. In the full-frequency display mode, changing CTCSS / DCS signaling is available.

● Change the CTCSS / DCS Code for Channel Receiving:

- 1) Press [F], [7].
CTCSS / DCS code or “OFF” appear on the screen.
- 2) Press [MENU] to switch between CTCSS and DCS.
 - While selecting CTCSS, “RC” or DCS code appear. Rotate the Channel Selector to select the desired CTCSS code, “OFF” means no CTCSS / DCS signaling.
 - While selecting DCS, “RD” or DCS code appear. Rotate the Channel Selector to select the desired DCS code, press [F] to select the positive or negative code. “OFF” means no CTCSS / DCS

signaling.

- 3) Press [OK] or [PTT] to keep the setting; press [CLR] to exit and quit the setting.
- 4) If CTCSS has been set, "CT" appears on the LCD while receiving; If DCS has been set, "DCS" appears.

● Change the CTCSS / DCS Code for Channel Transmitting:

- 1) Press [F], [8].
CTCSS / DCS code or "OFF" appear on the screen.
- 2) Press [MENU] to switch between CTCSS and DCS.
 - While selecting CTCSS, "TC" and CTCSS code appear. Rotate the Channel Selector to select the desired CTCSS code, "OFF" means no CTCSS / DCS signaling.
 - While selecting DCS, "TD" and DCS code appear. Rotate the Channel Selector to select the desired DCS code, press [F] to select the positive or negative code. "OFF" means no CTCSS / DCS signaling.
- 3) Press [OK] or [PTT] to keep the setting; press [CLR] to exit and quit the setting.
- 4) If CTCSS has been set, "CT" appears on the LCD while transmitting; If DCS has been set, "DCS" appears.

● Offset Frequency Setting

In the full-frequency display mode, offset frequency setting is available. Offset frequency setting makes the transmission frequency higher(+) or lower(-) than the received frequency to increase communication range by a repeater.

- 1) Press [F], [4]. Rotate the Channel Selector to select +/- offset frequency or "OFF". If "+" offset frequency is selected, "+" appears on the screen; if "-" offset frequency is selected, "-"

appears; if "OFF" is selected, the frequency for transmitting and receiving will be the same.

- 2) Press [OK] or [PTT] to keep the setting; press [CLR] to exit and quit the setting.
- 3) Press [F], [5] and rotate the Channel Selector or input the offset frequency directly by the keypad. The range 00.000 ~ 37.995MHz is available.
- 4) Press [OK] or [PTT] to keep the setting; press [CLR] to exit and quit the setting.

● Deleting Memory Channel

- 1) In the memory frequency mode, select the desired channel (the channel is not locked out).
- 2) Press and hold [CLR] for 2 seconds, LCD display "DEL-?".
- 3) Press [OK] or [PTT] again to delete the selected channel.

● Deleting All the Memory Channels

- 1) Switch off power.
- 2) Press [CLR] and meanwhile rotate the Power/Volume Switch to switch on power, LCD display "AL.DEL?".
- 3) Press [OK] or [PTT] again to delete all the memory channels.

● Channel Lockout

Channel Lockout is to avoid the channel being deleted or covered.

- 1) In the memory frequency mode, select the desired channel.
- 2) Press [F], [MENU], "■" appears below the channel number to show that the channel has been locked out.
- 3) To unlock, press [F], [MENU] again.

7. Scan

● Selecting Scan Resume Method

Before scanning, it is necessary to decide how to continue scanning after detecting a signal.

• Time-operated Mode (TO)

The transceiver stops scanning when detecting a signal, remains there for 5 seconds, and then continues to scan even if the signal is still present.

• Carrier-operated Mode (CO)

The transceiver stops scanning when detecting a signal until the signal drops out. There is a 5 seconds delay between signal drop-out and scan resumption unless the transceiver detects a new signal during this time.

• Search-operated Mode (SE)

The transceiver stops scanning when detecting a signal and pauses on the channel, and remains there even if the signal has disappeared.

Please select the first item in the “menu setting” to set a scan method.

● Memory Scan

In the memory frequency mode or channel mode, memory scanning is available.

- 1) Press [SCN] to start scanning.
- 2) Scan starts at the frequency currently displayed and increases.
- 3) To reverse the scan direction, rotate the Channel Selector clockwise or counterclockwise.
- 4) To end the scan and return to the stand-by channel, press any key other than [MONI]. Press and hold [MONI], the transceiver will work on the current channel; release for 5 seconds, continue to scan.

Note:

- The basic requirement for memory scanning: minimum need 2 or more memory channels which have been set and not to be locked.
- The squelch must be closed for scan to function.

● Frequency Scan

In the full-frequency display mode, frequency scanning is available.

- 1) Press [SCN] to start scanning.
- 2) Scan starts at the frequency currently displayed and steadily increases according to the “step”.
- 3) To reverse the scan direction, rotate the Channel Selector clockwise or counterclockwise.
- 4) To end the scan and return to the stand-by channel, press any key other than [MONI], [PTT].

Press [PTT], the transceiver will work at the current frequency and exit from the scan status.

Press [MONI], the transceiver will work at the current frequency, release for 5 seconds, continue to scan.

8. Auxiliary Functions

● Time-out Timer (TOT)

The purpose of the Time-out Timer is to prevent any single person from using a channel for an extended period of time. If the continuously transmission time overruns the limited time, the transceiver will stop transmitting and give out a warning tone.

The limited time can be set by the second item in the “menu setting”. (unit: second)

●Battery Save Function (SAV)

This function is useful to reduce the battery consumption while the transceiver is in the stand-by status. To set it ON or OFF, please select the third item in the “menu setting”.

●Beep Function (BP)

While pressing a key on the keypad, a tone will sound. This option controls low battery warning tone, TOT tone, channel busy tone and loss of lock tone. To set it ON or OFF, please select the fourth item in the “menu setting”.

●Keypad Lock Function (KY)

This function disables most of the keys to prevent you from accidentally activating a function. To set the lock mode (manual or automatic), please select the fifth item in the “menu setting”. When the keypad is locked, “**LO**” appears.

To lock manually, press [F] for about 2 seconds; while automatically lock has been set, if no operation is performed for 30 seconds, the keypad will be auto locked. To unlock, press [F] for about 2 seconds.

●Encoder (ENC)

To set the Encoder function ON or OFF while the keypad is locked, please select the sixth item in the “menu setting”.

●Auto Poweroff (APO)

When no operation is performed or no signal is received for the set period, the transceiver will turn power OFF automatically. A warning tone sounds and LCD displays “POW OFF” before turning the power off. To set the time, please select the seventh item

in the “menu setting”. (unit: minute)

●Automatic Number Identification (ANI)

This function is available in the transceiver. If a 3 digits ANI code has been set and the ANI transmission function has been selected by PC software, the LCD screen of the called transceiver will display the ANI code. To set the ANI function ON or OFF, the called transceiver can select the eighth item in the “menu setting”. While it is ON, LCD displays “ANI”.

●Busy Channel Lockout

While the function is activated. If not set up CTCSS / DCS, the speaker sounds while receiving the signal, press [PTT] failing to transmit. If set up CTCSS / DCS, the speaker doesn't sound while receiving the signal with incorrect CTCSS / DCS, press [PTT] failing to transmit; if the CTCSS / DCS is correct, the speaker sounds, press [PTT] to transmit.

Press [F], [MEMO] and rotate the Channel Selector to set the function ON or OFF, then press [OK] or [PTT] to keep the setting.

●High / Low Power

In a certain communication range, if receive the signal clearly, to reduce the battery consumption and prolong the service time, please select low output power.

Press [F], [2] and rotate the Channel Selector to select high or low power, then press [OK] or [PTT] to keep the setting. If select low power, LCD display “LO”; if select high power, “LO” disappear from the screen.

● Scrambler Function

Built in voice security system to avoid being wiretapped.

Press [F], [3] and rotate the Channel Selector to select the scrambler function ON or OFF, then press [OK] or [PTT] to keep the setting. If select ON, LCD display “◇”.

● VOX Function

In the stand-by status, if the VOX function is activated, LCD display “VOX”. If the voice higher than the default, the transceiver auto switch to the transmitting status; if lower than the default, the transceiver returns to the receiving mode within 2 seconds. In the strong noise surroundings, it may result in mis-transmission, so please set the VOX sensitivity in a suitable level.

Adjust VOX Sensitivity:

Press [F], [6], LCD display “VOX” and the current VOX sensitivity level, rotate the Channel Selector to select the VOX sensitivity level (0~9 or OFF), then press [OK] or [PTT] to keep the setting.

Note: This function will be more perfect with an earphone.

● Step Size

In the full-frequency display mode, rotate the Channel Selector to select the desired frequency, while scanning, the frequency will steadily increase or decrease according to the “step size” you have set.

Step Size Setting:

Press [F], [9] to enter the “step size” setting, rotate the Channel Selector to select a step size (5, 6.25, 10, 12.5, 25, unit: KHz), then press [OK] or [PTT] to keep the setting.

● Reverse Frequency Function

While the Reverse Frequency is activated, the transmitting frequency and receiving frequency are interchangeable, that's convenient for you to manually check the signal strength from the station which connects with the repeater.

Switch the Reverse Frequency Function:

Press [F], [0], LCD display “R”, the Reverse Frequency function is ON; press [F], [0] again, “R” disappears, the function is OFF.

Note: while changing the channel or switch the Scan function on, the Reverse Frequency function will be OFF automatically.

● Lamp Function

You can set lamp function AUTO, ON or OFF.

AUTO: To light the screen, press [Lamp], this moment, press any key other than [PTT] and [MONI], the light will be ON for about 5 seconds; press [Lamp] again to turn off the light immediately.

ON: press [F], [Lamp], the light will remain ON until you press [F], [Lamp] again.

● Alarm Function

Under the stand-by status, the transceiver will emit alert with high decibel, and meanwhile emit alert to other transceivers with the same frequency in the group and display its ANI code on them. Press [SCN] again to stop it.

● Wired Clone Function

This function is useful to clone data between transceivers.

- 1) Connect two transceivers by a data wire.
- 2) Turn on the sub-transceiver which will receive data and enter the user mode.

- 3) Press and hold [MONI] for 2 seconds to turn on the host transceiver and enter the clone mode, LCD display "CLONE?". Press [MONI] again to start to clone. If the data is successfully transmitted, LCD display "SUCCE".
- 4) If the sub-transceiver has received the clone signal, LCD display "PROGRA".
- 5) If fail to transmit, LCD of the host transceiver display "ERROR", this moment, turn off the two transceivers and then turn on again to restart the clone.

● Low Battery Power Warning

When the battery power appears low, the indicator flashes red for every 10 seconds and giving a warning tone to stop transmitting.

9. Specification

Specification	PT3800(1)
Frequency	150 -174MHz
RF Power	High: 2.0W / Low: 1W
Max Antenna Gain	2.0dBi
Transmitting Current	≤1.6 A
Working Temperature	-20℃ -- +60℃
Power Source	DC7.4V (Li-ion Battery 1100mAh)
Dimension	117mmX56mmX39mm
Weight	250 g with battery and antenna

10. Troubleshooting Guide

NO	Problem	Solution
1	Can not switch on	The battery power is low, please charge or replace it. The battery is not well connected, just remove the battery and reload it.
2	Standby time is short after full charging	Battery life is ending, please change a new one.
3	Unable to talk with others in the same group	It is out of communication range. Use different frequency or CTCSS / DCS, please reset it.
4	Hear other voices (not from the same group) in the channel	Please change the frequency or CTCSS and make sure to change the setting of the transceivers in your group.