



## FCC PART 90 TEST REPORT

### FCC Part 90

Report Reference No.....: **WE11020008**

FCC ID.....: **Q5EPT360002**

Compiled by

( position+printed name+signature)..: File administrators Wenliang Li

Supervised by

( position+printed name+signature)..: Test Engineer Eric Zhang

Approved by

( position+printed name+signature)..: Manager Jimmy Li

Date of issue.....: Mar 30, 2011

Testing Laboratory Name .....: **Shenzhen Huatongwei International Inspection Co., Ltd**

Address .....: Keji Nan No.12 Road, Hi-tech Park, Shenzhen, China

Applicant's name .....: **SHENZHEN KIRISUN ELECTRONICS CO., LTD.**

Address .....: 2/F, Bldg. H-3, East Industrial Zone of Overseas Chinese Town, Shenzhen, Guangdong, China

#### Test specification:

Standard.....: **FCC Part 90: PRIVATE LAND MOBILE RADIO SERVICES**

TRF Originator.....: Shenzhen Huatongwei International Inspection CO., Ltd

Master TRF.....: Dated 2006-06

#### Shenzhen Huatongwei International Inspection Co., Ltd. All rights reserved.

This publication may be reproduced in whole or in part for non-commercial purposes as long as the Shenzhen Huatongwei International Inspection Co., Ltd is acknowledged as copyright owner and source of the material. Shenzhen Huatongwei International Inspection Co., Ltd takes no responsibility for and will not assume liability for damages resulting from the reader's interpretation of the reproduced material due to its placement and context.

Test item description .....: Two-way Radio

Trade Mark .....:

Model/Type reference.....: PT3600-02

Listed Models .....: /

Manufacturer .....: **SHENZHEN KIRISUN ELECTRONICS CO., LTD.**

Ratings .....: DC 7.40V

Modulation .....: FM

Channel Separation.....: 12.5KHz

Rated Power .....: 4 Watts(36.02 dBm)/0.5 Watts(26.99 dBm)

Operation Frequency Range .....: From 400 MHz to 470 MHz

Result.....: **Positive**

**TEST REPORT**

<b>Test Report No. :</b>	<b>WE11020008</b>	Mar 30, 2011
		Date of issue

Equipment under Test : Two-way Radio

Model /Type : PT3600-02

Listed Models : /

**Applicant** : **SHENZHEN KIRISUN ELECTRONICS CO., LTD.**

Address : 2/F, Bldg. H-3, East Industrial Zone of Overseas Chinese Town, Shenzhen, Guangdong, China

**Manufacturer** : **SHENZHEN KIRISUN ELECTRONICS CO., LTD.**

Address : 2/F, Bldg. H-3, East Industrial Zone of Overseas Chinese Town, Shenzhen, Guangdong, China

<b>Test Result</b> according to the standards on page 4:	<b>Positive</b>
--	-----------------

The test report merely corresponds to the test sample.  
It is not permitted to copy extracts of these test result without the written permission of the test laboratory.

## Contents

<b>1.</b>	<b><u>TEST STANDARDS</u></b>	<b>4</b>
<b>2.</b>	<b><u>SUMMARY</u></b>	<b>5</b>
2.1.	General Remarks	5
2.2.	Product Description	5
2.3.	Equipment under Test	5
2.4.	Short description of the Equipment under Test (EUT)	5
2.5.	EUT Configuration	6
2.6.	EUT operation mode	6
2.7.	EUT configuration	6
2.8.	Related Submittal(s) / Grant (s)	6
2.9.	Modifications	6
2.10.	Note	6
<b>3.</b>	<b><u>TEST ENVIRONMENT</u></b>	<b>7</b>
3.1.	Address of the test laboratory	7
3.2.	Test Facility	7
3.3.	Environmental conditions	8
3.4.	Configuration of Tested System	8
3.5.	Discription of Tested Modes	8
3.6.	Statement of the measurement uncertainty	8
3.7.	Test Description	9
3.8.	Equipments Used during the Test	9
<b>4.</b>	<b><u>TEST CONDITIONS AND RESULTS</u></b>	<b>11</b>
4.1.	Conducted Emissions Test	11
4.2.	Occupied Bandwidth and Emission Mask Test	14
4.3.	Transmitter Radiated Spurious Emssion	23
4.4.	Spurious Emssion on Antenna Port	27
4.5.	Modulation Charcateristics	39
4.6.	Frequency Stability Test	42
4.7.	Maximum Transmitter Power	44
4.8.	Transmitter Frequency Behavior	50
4.9.	Receiver Radiated Spurious Emssion	52
4.10.	Receiver Conducted Spurious Emssion	58
<b>5.</b>	<b><u>TEST SETUP PHOTOS OF THE EUT</u></b>	<b>64</b>
<b>6.</b>	<b><u>EXTERNAL AND INTERNAL PHOTOS OF THE EUT</u></b>	<b>67</b>

## **1. TEST STANDARDS**

The tests were performed according to following standards:

**FCC Rules Part 90: PRIVATE LAND MOBILE RADIO SERVICES.**

**TIA/EIA 603: Land Mobile FM or PM Communications Equipment Measurement and Performance Standards.**

**ANSI C63.4-2009: American National Standard for Methods of Measurement of Radio-Noise Emissions from Low-Voltage Electrical and Electronic Equipment in the Range of 9 kHz to 40 GHz.**

## 2. SUMMARY

### 2.1. General Remarks

Date of receipt of test sample	:	Feb 25, 2011
Testing commenced on	:	Feb 25, 2011
Testing concluded on	:	Mar 30, 2011

### 2.2. Product Description

The SHENZHEN KIRISUN ELECTRONICS CO., LTD.'s Model: PT3600-02 or the "EUT" as referred to in this report; more general information as follows:

Name of EUT	Two-way Radio	
Model Number	PT3600-02	
FCC ID	Q5EPT360002	
Rated Output Power	4Watts(36.02 dBm)/0.5 Watts(26.99 dBm)	
Modulation Type	FM for Analog Voice	
	Analog	8K50F3E for 12.5KHz Channel Separation
Channel Separation	Analog Voice	12.5KHz
Antenna Type	External	
Frequency Range	From 400 MHz to 470 MHz	
Maximum Output Power	Analog	<u>5.13W</u> for 12.5 KHz Channel Separation

### 2.3. Equipment under Test

#### Power supply system utilised

Power supply voltage	:	<input type="radio"/> 120V / 60 Hz	<input type="radio"/> 115V / 60Hz
		<input type="radio"/> 12 V DC	<input type="radio"/> 24 V DC
		<input checked="" type="radio"/> Other (specified in blank below)	

DC 7.40V from battery

#### Test frequency list

Modulation Type	Test Channel	Test Frequency
Analog/FM	Low Channel	400.5000 MHz
	Low Channel	418.0000 MHz
	Middle Channel	435.5000 MHz
	High Channel	453.0000 MHz
	High Channel	469.5000 MHz

### 2.4. Short description of the Equipment under Test (EUT)

400-470 MHz U frequency band Two-way Radio (PT3600-02).

For more details, refer to the user's manual of the EUT.

Serial number: Prototype

**2.5. EUT Configuration**

The EUT configuration for testing is installed on RF field strength measurement to meet the Commission’s requirement and operating in a manner which intends to maximize its emission characteristics in a continuous normal application.

**2.6. EUT operation mode**

The EUT has been tested under typical operating condition and The Transmitter was operated in the normal operating mode. The TX frequency was fixed which was for the purpose of the measurements.

**2.7. EUT configuration**

**The following peripheral devices and interface cables were connected during the measurement:**

- - supplied by the manufacturer
- - supplied by the lab

<input type="radio"/>	Power Cable	Length (m) :	/
		Shield :	/
		Detachable :	/
<input type="radio"/>	Multimeter	Manufacturer :	/
		Model No. :	/

**2.8. Related Submittal(s) / Grant (s)**

This submittal(s) (test report) is intended for FCC ID: **Q5EPT360002** filing to comply with FCC Part 90 Rules

**2.9. Modifications**

No modifications were implemented to meet testing criteria.

**2.10. Note**

1. The EUT is a 400-470 MHz frequency band Two-way Radio (PT3600-02),The functions of the EUT listed as below:

	Test Standards	Reference Report
Radio	FCC Part 90	WE11020008

### **3. TEST ENVIRONMENT**

#### **3.1. Address of the test laboratory**

Shenzhen Huatongwei International Inspection Co., Ltd  
Keji Nan No.12 Road, Hi-tech Park, Shenzhen, China  
Phone: 86-755-26715686 Fax: 86-755-26748089

The sites are constructed in conformance with the requirements of ANSI C63.7, ANSI C63.4 (2009) and CISPR Publication 22.

#### **3.2. Test Facility**

The test facility is recognized, certified, or accredited by the following organizations:

##### **CNAS-Lab Code: L1225**

Shenzhen Huatongwei International Inspection Co., Ltd has been assessed and proved to be in compliance with CNAS-CL01 Accreditation Criteria for Testing and Calibration Laboratories (identical to ISO/IEC 17025: 2005 General Requirements) for the Competence of Testing and Calibration Laboratories, Date of Registration: August 02, 2007. Valid time is until March 29, 2012.

##### **A2LA-Lab Cert. No. 2243.01**

Shenzhen Huatongwei International Inspection Co., Ltd, EMC Laboratory has been accredited by A2LA for technical competence in the field of electrical testing, and proved to be in compliance with ISO/IEC 17025: 2005 General Requirements for the Competence of Testing and Calibration Laboratories and any additional program requirements in the identified field of testing. Valid time to Sep 30, 2011.

##### **FCC-Registration No.: 662850**

Shenzhen Huatongwei International Inspection Co., Ltd, EMC Laboratory has been registered and fully described in a report filed with the FCC (Federal Communications Commission). The acceptance letter from the FCC is maintained in our files. Registration 662850, Renewal date July 01, 2009.

##### **IC-Registration No.: 5377**

The 3m Alternate Test Site of Shenzhen Huatongwei International Inspection Co., Ltd has been registered by Certification and Engineering Bureau of Industry Canada for the performance of radiated measurements with Registration No. 5377 on Jan 24h, 2011.

##### **ACA**

Shenzhen Huatongwei International Inspection Co., Ltd, EMC Laboratory can also perform testing for the Australian C-Tick mark as a result of our A2LA accreditation.

##### **NEMKO-Aut. No.: ELA125**

Shenzhen Huatongwei International Inspection Co., Ltd has been assessed the quality assurance system, the testing facilities, qualifications and testing practices of the relevant parts of the organization. The quality assurance system of the Laboratory has been validated against ISO/IEC 17025:2005 or equivalent. The laboratory also fulfils the conditions described in Nemko Document NLA-10; the Authorization is valid through July 07, 2011.

##### **VCCI**

The 3m Semi-anechoic chamber (12.2m×7.95m×6.7m) and Shielded Room (8m×4m×3m) of Shenzhen Huatongwei International Inspection Co., Ltd has been registered in accordance with the Regulations for Voluntary Control Measures with Registration No.: R-2484. Date of Registration: December 20, 2009. Valid time is until December 19, 2012.

Main Ports Conducted Interference Measurement of Shenzhen Huatongwei International Inspection Co., Ltd has been registered in accordance with the Regulations for Voluntary Control Measures with Registration No.: C-2726. Date of Registration: December 20, 2009. Valid time is until December 19, 2012.

**DNV**

Shenzhen Huatongwei International Inspection Co Ltd has been found to comply with the requirements of DNV towards subcontractor of EMC and safety testing services in conjunction with the EMC and Low voltage Directives and in the voluntary field. The acceptance is based on a formal quality Audit and follow-ups according to relevant parts of ISO/IEC Guide 17025(2005), in accordance with the requirements of the DNV Laboratory Quality Manual towards subcontractors. Valid time is until 24 August, 2013.

**3.3. Environmental conditions**

During the measurement the environmental conditions were within the listed ranges:

Temperature:	15-35 ° C
Humidity:	30-60 %
Atmospheric pressure:	950-1050mbar

**3.4. Configuration of Tested System**

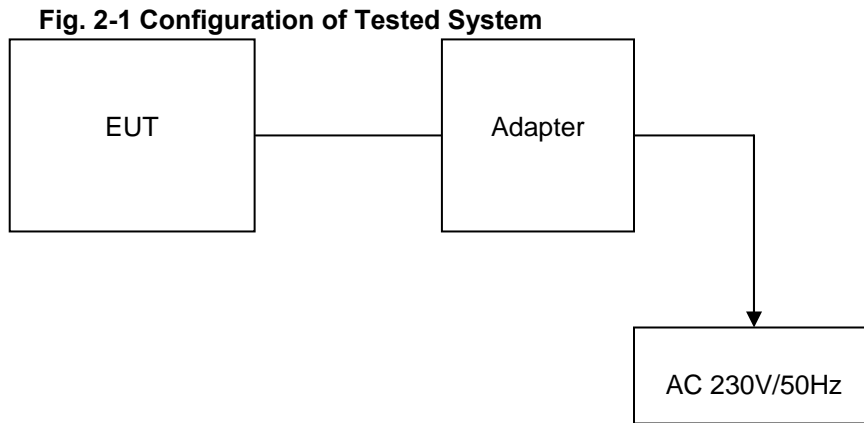

**Table 2-1 Equipment Used in Tested System**

**Adapter:** Model: RJ-AS120050E002  
 Input:100-240V~50/60Hz 0.3A  
 Output: +12V DC 05A  
 Power Cable: 150cm  
 ◇ Shielded      ◆ Unshielded

**3.5. Discription of Tested Modes**

The EUT (Two-way Radio) has been tested under normal operating condition. Five channels (the high, the middle and the low) are chosen for testing at each channel separation (12.5 KHz).

**3.6. Statement of the measurement uncertainty**

The data and results referenced in this document are true and accurate. The reader is cautioned that there may be errors within the calibration limits of the equipment and facilities. The measurement uncertainty was calculated for all measurements listed in this test report acc. to CISPR 16 - 4 „Specification for radio disturbance and immunity measuring apparatus and methods – Part 4: Uncertainty in EMC Measurements“ and is documented in the Shenzhen Huatongwei International Inspection Co., Ltd quality system acc. to DIN EN ISO/IEC 17025. Furthermore, component and process variability of devices similar to that tested may result in additional deviation. The manufacturer has the sole responsibility of continued compliance of the device.

Hereafter the best measurement capability for Shenzhen Huatongwei laboratory is reported:



Test Items	Measurement Uncertainty	Notes
Frequency stability	150 Hz	(1)
Transmitter power conducted	0.30 dB	(1)
Transmitter power Radiated	2.20 dB	(1)
Conducted spurious emission 9KHz-12.75 GHz	1.60 dB	(1)
Radiated spurious emission 9KHz-12.75 GHz	2.20 dB	(1)
Conducted Emission 9KHz-30MHz	3.39 dB	(1)
Radiated Emission 30~1000MHz	4.24 dB	(1)
Radiated Emissio 1~18GHz	5.16 dB	(1)
Radiated Emissio 18-40GHz	5.54 dB	(1)
Occupied Bandwidth	-----	(1)
Emission Mask	-----	(1)
Modulation Characteristic	-----	(1)
Transmitter Frequency Behavior	-----	(1)

(1) This uncertainty represents an expanded uncertainty expressed at approximately the 95% confidence level using a coverage factor of k=1.96.

### 3.7. Test Description

FCC Rules	Description of Test	Test Result
§ 15.107	Conducted Emission	Complies
§ 15.109	Receiver Radiated Spurious Emssion	Complies
§ 15.109	Receiver Conducted Spurious Emssion	Complies
§ 90.205	Maximum Transmitter Power	Complies
§ 90.207	Modulation Characteristic	Complies
§ 90.209	Occupied Bandwidth	Complies
§ 90.210	Emission Mask	Complies
§ 90.213	Frequency Stability	Complies
§ 90.214	Transmitter Frequency Behavior	Complies
§ 90.210	Transmitter Radiated Spurious Emssion	Complies
§ 90.210	Spurious Emssion On Antenna Port	Complies

### 3.8. Equipments Used during the Test

AC Power Conducted Emission				
Name of Equipment	Manufacturer	Model	Serial Number	Calibration Due
Artificial Mains	Rohde&Schwarz	ESH2-Z5	100028	11/2011
EMI Test Receiver	Rohde&Schwarz	ESCS 30	100038	11/2011
Pulse Limiter	Rohde&Schwarz	ESHSZ2	100044	11/2011
EMI Test Software	Rohde&Schwarz	ES-K1 V1.71	N/A	11/2011

Modulation Characteristic				
Name of Equipment	Manufacturer	Model	Serial Number	Calibration Due
Modulation Analyzer	HP	8901B	3104A03367	11/2011
Signal Generator	Rohde&Schwarz	SMT03	100059	11/2011
RF COMMUNICATION TEST SET	HP	8920A	3813A10206	11/2011

Transmitter Radiated Spurious Emission & Occupied Bandwidth & Emission Mask & Receiver Radiated Spurious Emission				
Name of Equipment	Manufacturer	Model	Serial Number	Calibration Due
Ultra-Broadband Antenna	Rohde&Schwarz	HL562	100015	11/2011
EMI Test Receiver	Rohde&Schwarz	ESI 26	100009	11/2011
RF Test Panel	Rohde&Schwarz	TS / RSP	335015/ 0017	N/A
HORN ANTENNA	Rohde&Schwarz	HF906	100039	11/2011
Turntable	ETS	2088	2149	N/A
Antenna Mast	ETS	2075	2346	N/A
EMI Test Software	Rohde&Schwarz	ES-K1 V1.71	N/A	11/2011
RF COMMUNICATION TEST SET	HP	8920A	3813A10206	11/2011

Frequency Stability				
Name of Equipment	Manufacturer	Model	Serial Number	Calibration Due
Communication Test Set	HP	HP8920B	US35010135	11/2011
Signal Generator	Rohde&Schwarz	SMT03	100059	11/2011
Climate Chamber	ESPEC	EL-10KA	05107008	11/2011

Maximum Transmitter Power & Spurious Emission On Antenna Port				
Name of Equipment	Manufacturer	Model	Serial Number	Calibration Due
Receiver	Rohde&Schwarz	ESI 26	100009	11/2011
Attenuator	R&S	ESH3-22	100449	11/2011
RF COMMUNICATION TEST SET	HP	8920A	3813A10206	11/2011
High-Pass Filter	Anritsu	MP526B	6220875256	11/2011
High-Pass Filter	Anritsu	MP526D	6220878392	11/2011

Transient Frequency Behavior				
Name of Equipment	Manufacturer	Model	Serial Number	Calibration Due
Signal Generator	Rohde&Schwarz	SMT03	100059	11/2011
Storage Oscilloscope	Tektronix	TDS3054B	B033027	11/2011
RF COMMUNICATION TEST SET	HP	8920A	3813A10206	11/2011

## 4. TEST CONDITIONS AND RESULTS

### 4.1. Conducted Emissions Test

#### TEST APPLICABLE

The EUT was tested according to ANSI C63.4 - 2009. The frequency spectrum from 0.15 MHz to 30 MHz was investigated. The LISN used was 50 ohm / 50 u Henry as specified by section 5.1 of ANSI C63.4 - 2009. Cables and peripherals were moved to find the maximum emission levels for each frequency.

#### TEST CONFIGURATION

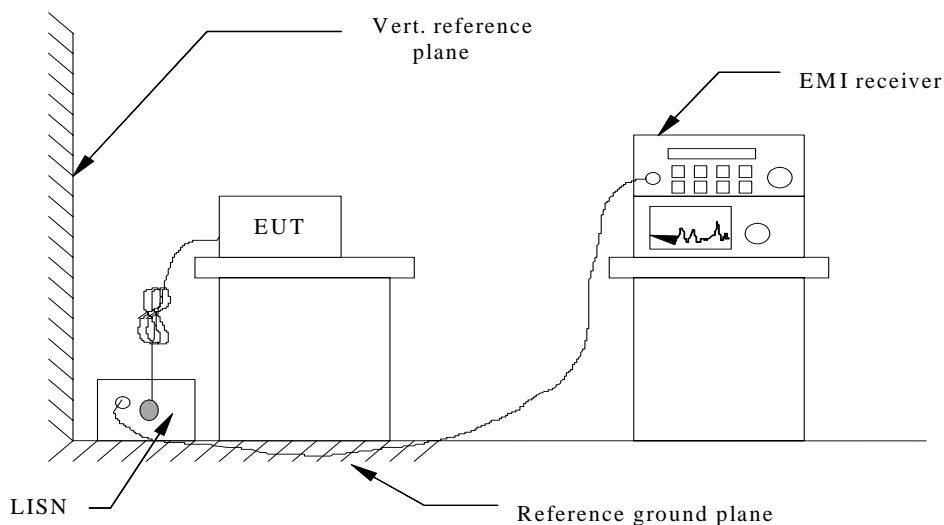

#### TEST PROCEDURE

- 1 The equipment was set up as per the test configuration to simulate typical actual usage per the user's manual. The EUT is a tabletop system; a wooden table with a height of 0.8 meters is used and is placed on the ground plane as per ANSI C63.4-2009.
- 2 Support equipment, if needed, was placed as per ANSI C63.4-2009.
- 3 All I/O cables were positioned to simulate typical actual usage as per ANSI C63.4-2009.
- 4 If a EUT received DC power from the adapter, the adapter received AC120V/60Hz power through a Line Impedance Stabilization Network (LISN) which supplied power source and was grounded to the ground plane.
- 5 All support equipments received AC power from a second LISN, if any.
- 6 The EUT test program was started. Emissions were measured on each current carrying line of the EUT using a spectrum Analyzer / Receiver connected to the LISN powering the EUT. The LISN has two monitoring points: Line 1 (Hot Side) and Line 2 (Neutral Side). Two scans were taken: one with Line 1 connected to Analyzer / Receiver and Line 2 connected to a 50 ohm load; the second scan had Line 1 connected to a 50 ohm load and Line 2 connected to the Analyzer / Receiver.
- 7 Analyzer / Receiver scanned from 150 KHz to 30MHz for emissions in each of the test modes.
- 8 During the above scans, the emissions were maximized by cable manipulation.

#### Conducted Power Line Emission Limit

For unintentional device, according to § 15.107(a) Line Conducted Emission Limits is as following :

Frequency (MHz)	Maximum RF Line Voltage (dBµV)			
	CLASS A		CLASS B	
	Q.P.	Ave.	Q.P.	Ave.
0.15 - 0.50	79	66	66-56*	56-46*
0.50 - 5.00	73	60	56	46
5.00 - 30.0	73	60	60	50

\* Decreasing linearly with the logarithm of the frequency

For intentional device, according to §15.207(a) Line Conducted Emission Limit is same as above table.

**TEST RESULTS**

**For FM Modulation @ 12.5 KHz**

**SCAN TABLE: "Voltage (9K-30M) FIN"**

Short Description: 150K-30M Voltage

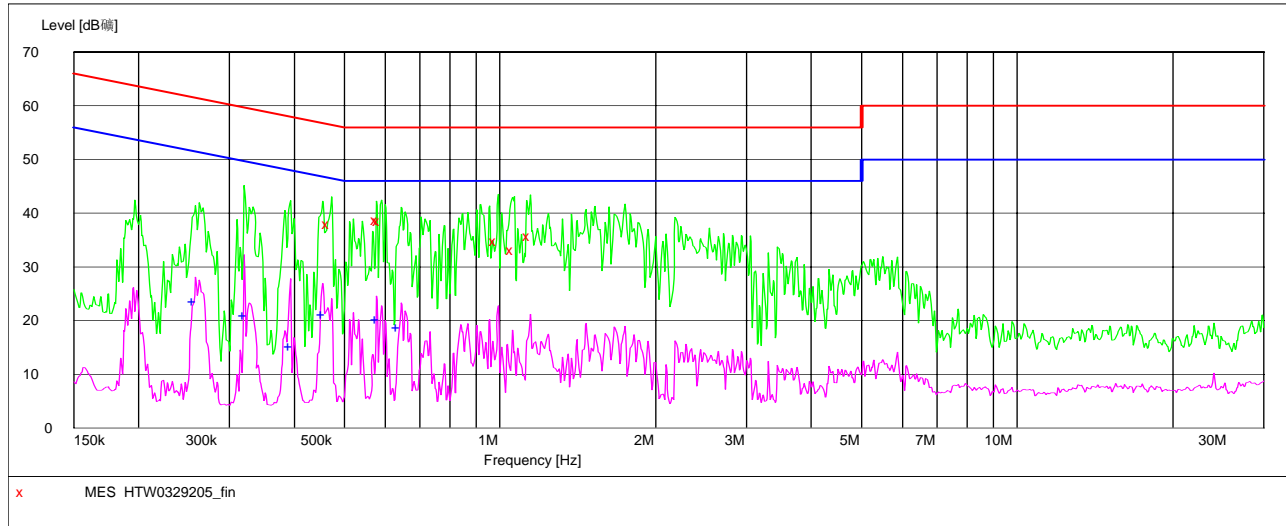

**MEASUREMENT RESULT: "HTW0329205\_fin"**

3/29/2011 8:58PM

Frequency MHz	Level dBµV	Transd dB	Limit dBµV	Margin dB	Detector	Line	PE
0.468750	37.90	10.2	57	18.6	QP	N	GND
0.581270	38.70	10.2	56	17.3	QP	N	GND
0.585920	38.50	10.2	56	17.5	QP	N	GND
0.983500	34.80	10.2	56	21.2	QP	N	GND
1.065070	33.20	10.2	56	22.8	QP	N	GND
1.144261	35.80	10.2	56	20.2	QP	N	GND

**MEASUREMENT RESULT: "HTW0329205\_fin2"**

3/29/2011 8:58PM

Frequency MHz	Level dBµV	Transd dB	Limit dBµV	Margin dB	Detector	Line	PE
0.257867	23.70	10.2	52	27.8	AV	N	GND
0.322330	21.00	10.2	50	28.6	AV	N	GND
0.396530	15.30	10.2	48	32.6	AV	N	GND
0.457680	21.30	10.2	47	25.4	AV	N	GND
0.581270	20.30	10.2	46	25.7	AV	N	GND
0.639590	18.70	10.2	46	27.3	AV	N	GND

**SCAN TABLE: "Voltage (9K-30M) FIN"**

Short Description: 150K-30M Voltage

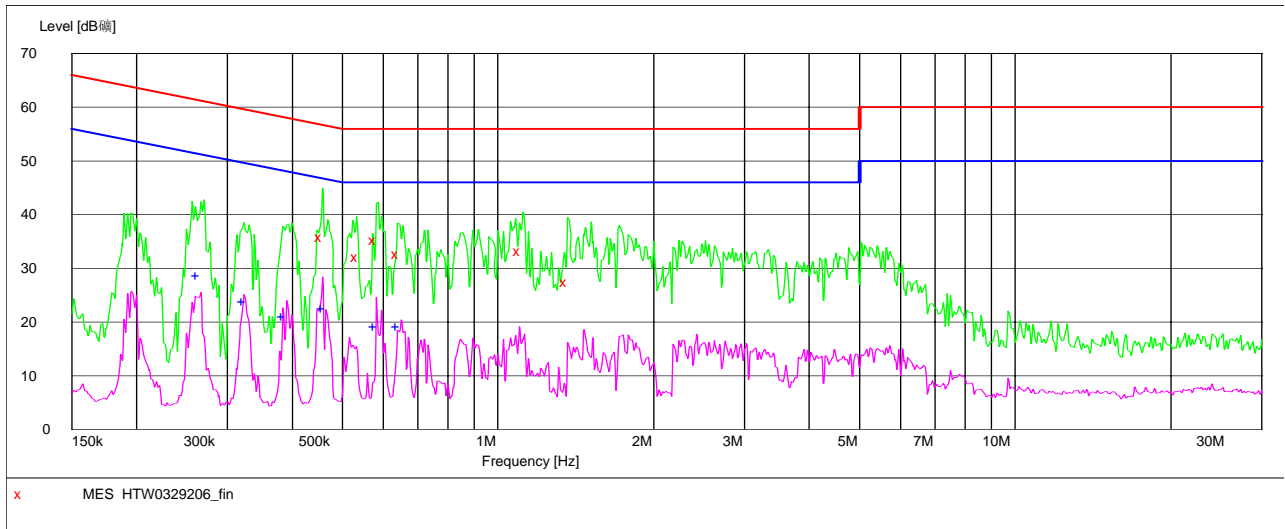

**MEASUREMENT RESULT: "HTW0329206\_fin"**

3/29/2011 9:05PM

Frequency MHz	Level dBμV	Transd dB	Limit dBμV	Margin dB	Detector	Line	PE
0.457682	35.80	10.2	57	20.9	QP	L1	GND
0.536750	32.10	10.2	56	23.9	QP	L1	GND
0.581270	35.30	10.2	56	20.7	QP	L1	GND
0.644710	32.70	10.2	56	23.3	QP	L1	GND
1.108370	33.20	10.2	56	22.8	QP	L1	GND
1.363501	27.50	10.2	56	28.5	QP	L1	GND

**MEASUREMENT RESULT: "HTW0329206\_fin2"**

3/29/2011 9:05PM

Frequency MHz	Level dBμV	Transd dB	Limit dBμV	Margin dB	Detector	Line	PE
0.264110	28.70	10.2	51	22.6	AV	L1	GND
0.324900	24.00	10.2	50	25.6	AV	L1	GND
0.387160	21.20	10.2	48	26.9	AV	L1	GND
0.461340	22.60	10.2	47	24.1	AV	L1	GND
0.581273	19.30	10.2	46	26.7	AV	L1	GND
0.644710	19.30	10.2	46	26.7	AV	L1	GND

## 4.2. Occupied Bandwidth and Emission Mask Test

### TEST APPLICABLE

- (a). Occupied Bandwidth: The EUT was connected to the audio signal generator and the spectrum analyzer via the main RF connector, and through an appropriate attenuator. The EUT was controlled to transmit its maximum power. Then the bandwidth of 99% power can be measured by the spectrum analyzer.
- (b). Emission Mask B: For transmitters that are equipped with an audio low-pass filter pursuant to §90.211(a), the power of any emission must be below the unmodulated carrier power (P) as follows:
- (1) On any frequency removed from the assigned frequency by more than 50 percent, but not more than 100 percent of the authorized bandwidth: At least 25 dB.
  - (2) On any frequency removed from the assigned frequency by more than 100 percent, but not more than 250 percent of the authorized bandwidth: At least 35 dB.
  - (3) On any frequency removed from the assigned frequency by more than 250 percent of the authorized bandwidth: At least  $43 + 10 \log (P)$  dB.
- (c). Emission Mask D, 12.5 kHz channel bandwidth equipment: For transmitters designed to operate with a 12.5 kHz channel bandwidth, any emission must be attenuated below the power (P) of the highest emission contained within the authorized bandwidth as follows:
- (1) On any frequency from the center of the authorized bandwidth  $f_0$  to 5.625 kHz removed from  $f_0$ : Zero dB.
  - (2) On any frequency removed from the center of the authorized bandwidth by a displacement frequency ( $f_d$  in kHz) of more than 5.625 kHz but no more than 12.5 kHz: At least  $7.27(f_d - 2.88 \text{ kHz})$  dB.
  - (3) On any frequency removed from the center of the authorized bandwidth by a displacement frequency ( $f_d$  in kHz) of more than 12.5 kHz: At least  $50 + 10 \log (P)$  dB or 70 dB, whichever is the lesser attenuation.

### TEST CONFIGURATION

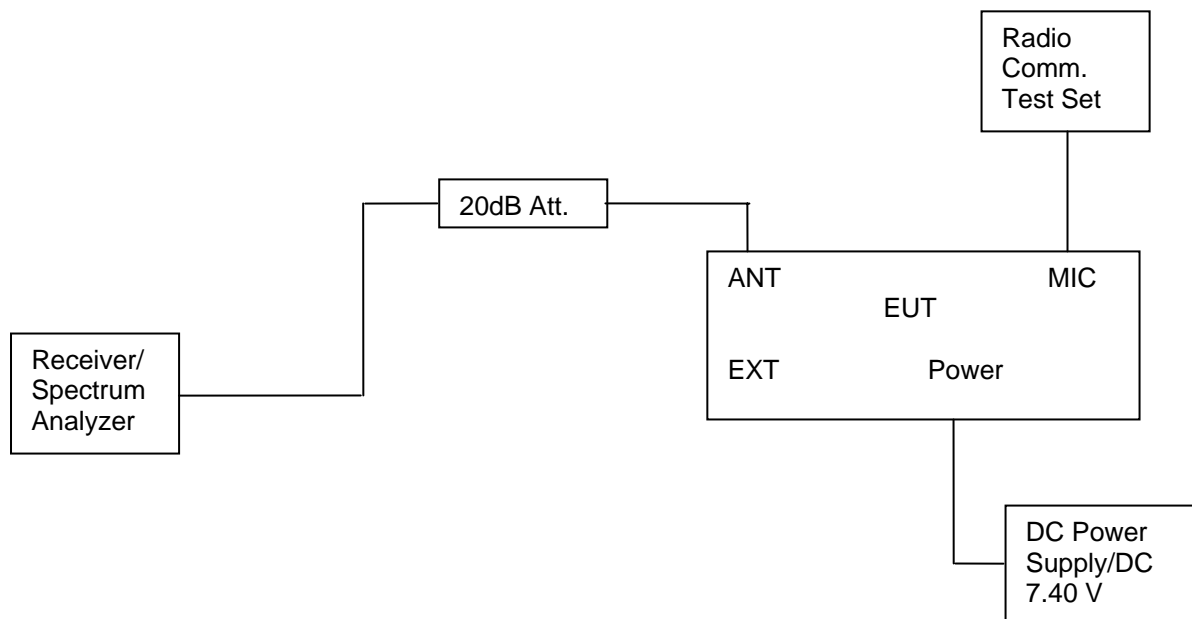

### TEST PROCEDURE

- 1 The EUT was placed on a turn table which is 0.8m above ground plane.
- 2 The EUT was modulated by 2.5 KHz Sine wave audio signal; the level of the audio signal employed is 16 dB greater than that necessary to produce 50% of rated system deviation. Rated system deviation is 2.5 kHz (12.5 kHz channel spacing).
- 3 Set EUT as normal operation.
- 4 Set SPA Center Frequency = fundamental frequency, RBW=300Hz, VBW= 3 KHz, span =50 KHz.
- 5 Set SPA Max hold. Mark peak, Set 99% Occupied Bandwidth and 26dB Occupied Bandwidth.
- 6 Set SPA Center Frequency=fundamental frequency, RBW=100Hz, VBW=1 KHz, span=50 KHz for 12.5 channel spacing.

**TEST RESULTS**

**4.2.1 Occupied Bandwidth**

Modulation Type	Channel Separation	Test Channel	Test Frequency	99% Occupied Bandwidth	26dB Occupied Band width
FM	12.5KHz	Low	400.5000 MHz	10.02 KHz	10.62 KHz
		Low	418.0000 MHz	10.02 KHz	10.62 KHz
		Middle	435.5000 MHz	10.02 KHz	10.62 KHz
		High	453.0000 MHz	10.02 KHz	10.62 KHz
		High	469.5000 MHz	10.02 KHz	10.62 KHz
Limit			11.25KHz for 12.5KHz Channel Separation		
Test Results			Compliance		

**Plots of 99% and 26dB Bandwidth Measurement**

Modulation Type	Channel Separation	Freq.(MHz)	99% Bandwidth (KHz)	26dB Bandwidth (KHz)	FCC Limit (KHz)	Results
FM	12.5 KHz	400.5000	10.02	10.62	11.25	Compliance

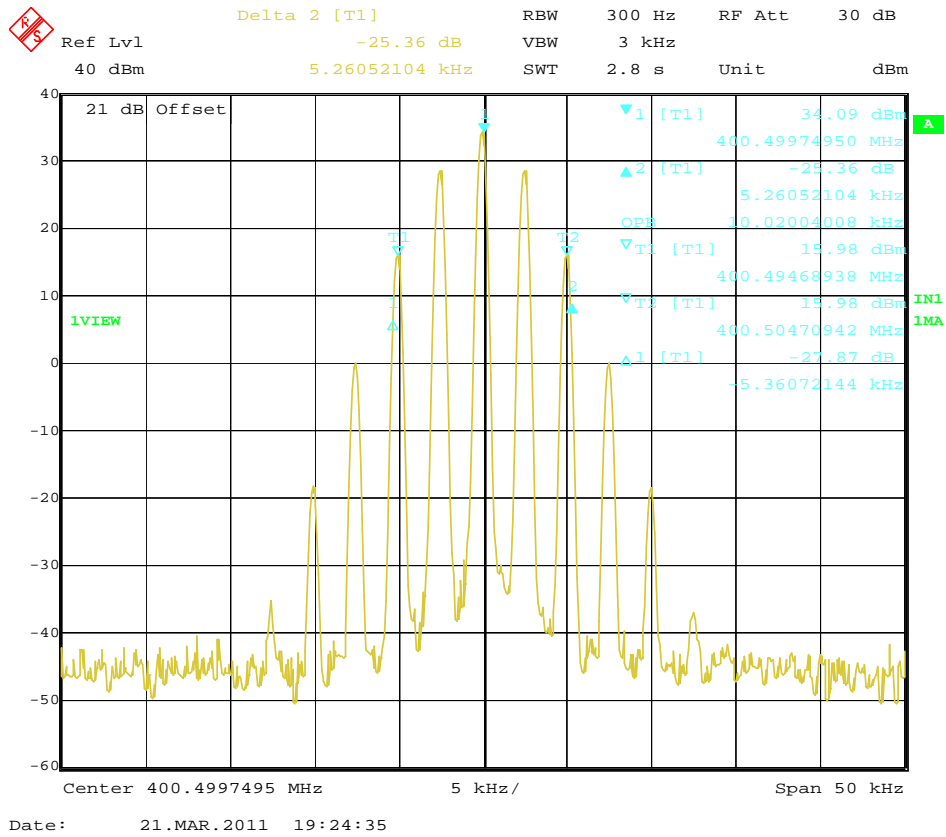

Modulation Type	Channel Separation	Freq.(MHz)	99% Bandwidth (KHz)	26dB Bandwidth (KHz)	FCC Limit (KHz)	Results
FM	12.5 KHz	418.0000	10.02	10.62	11.25	Compliance

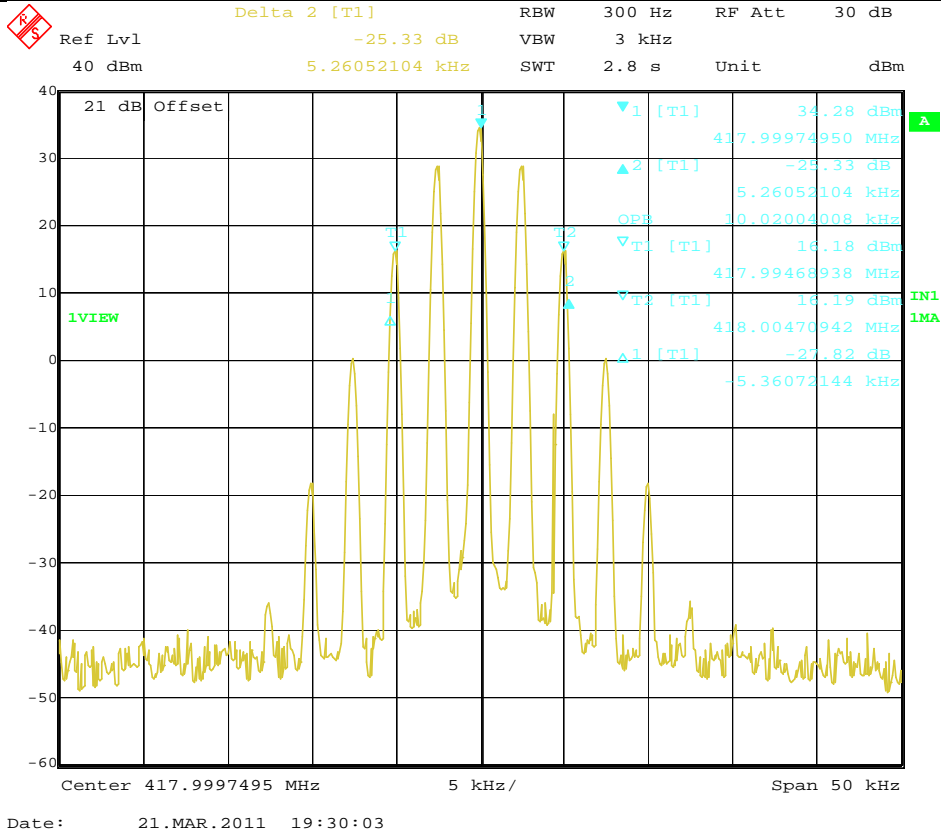

Modulation Type	Channel Separation	Freq.(MHz)	99% Bandwidth (KHz)	26dB Bandwidth (KHz)	FCC Limit (KHz)	Results
FM	12.5 KHz	435.50000	10.02	10.62	11.25	Compliance

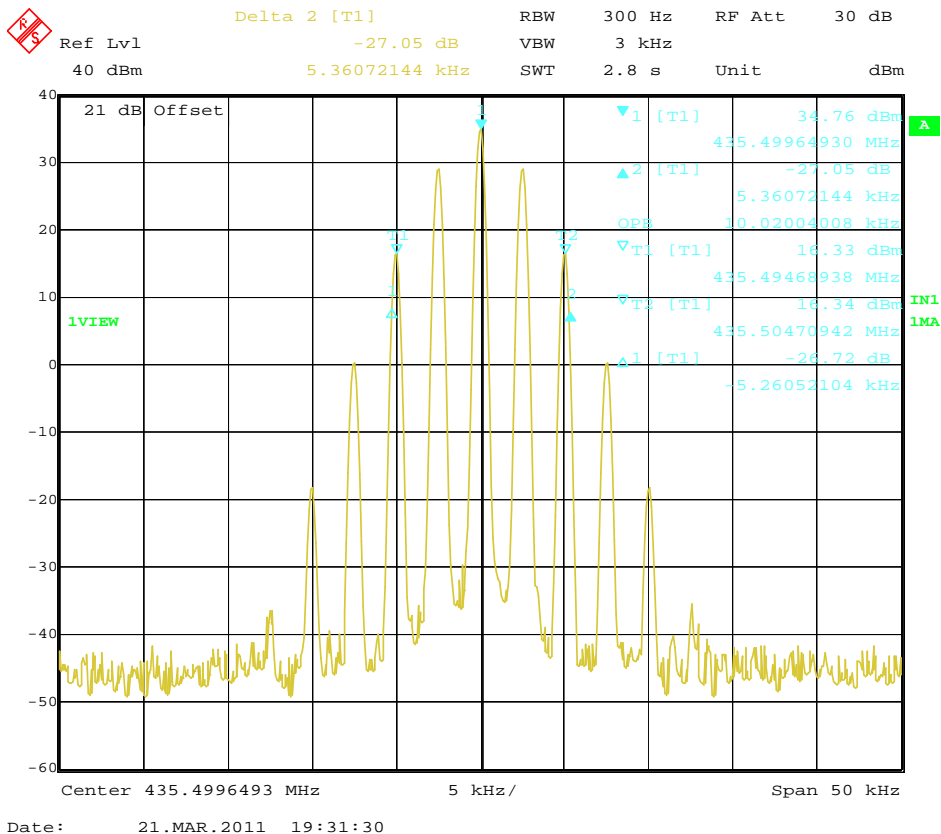



Modulation Type	Channel Separation	Freq.(MHz)	99% Bandwidth (KHz)	26dB Bandwidth (KHz)	FCC Limit (KHz)	Results
FM	12.5 KHz	453.0000	10.02	10.62	11.25	Compliance



Delta 2 [T1] RBW 300 Hz RF Att 30 dB  
 Ref Lvl -27.96 dB VBW 3 kHz  
 40 dBm 5.31062124 kHz SWT 2.8 s Unit dBm

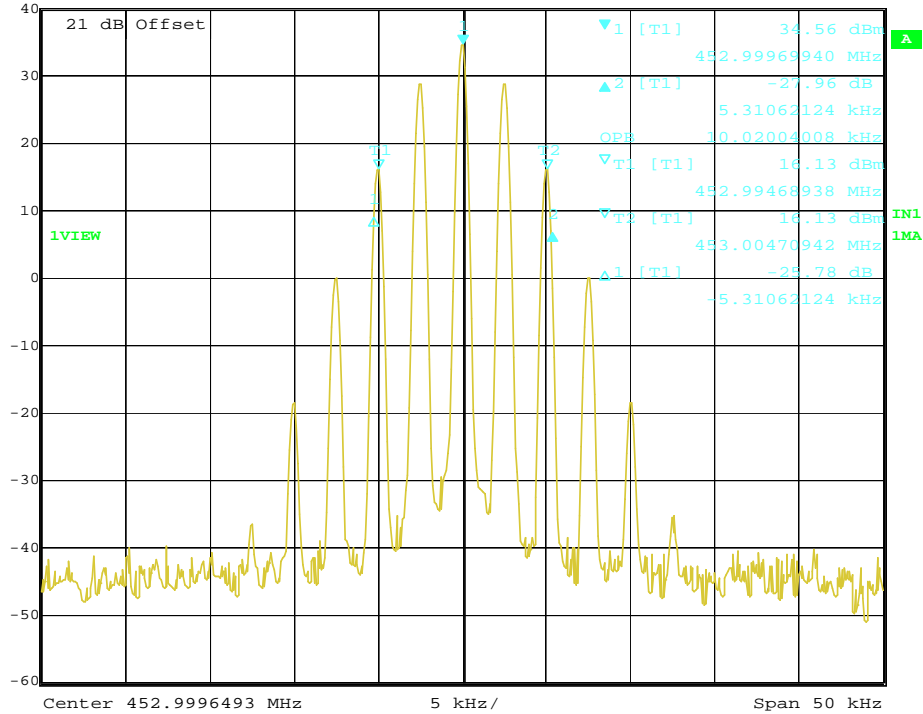

Date: 21.MAR.2011 19:32:25

Modulation Type	Channel Separation	Freq.(MHz)	99% Bandwidth (KHz)	26dB Bandwidth (KHz)	FCC Limit (KHz)	Results
FM	12.5 KHz	469.5000	10.02	10.62	11.25	Compliance



Delta 1 [T1] RBW 300 Hz RF Att 30 dB  
 Ref Lvl -24.32 dB VBW 3 kHz  
 40 dBm -5.31062124 kHz SWT 2.8 s Unit dBm

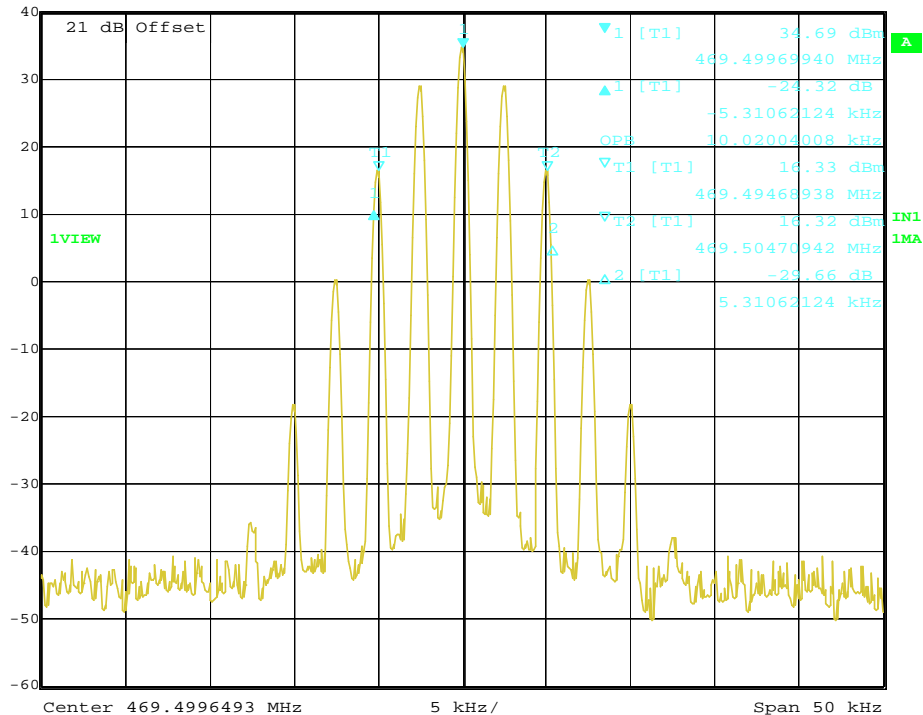

Date: 21.MAR.2011 19:34:01

**4.2.2 Emission Mask**

Modulation type	Channel Separation	Test Channel	Test Frequency	FCC Applicable Mask	RBW
FM	12.5KHz	Low	400.5000 MHz	D	100Hz
		Low	418.0000 MHz	D	100Hz
		Middle	435.5000 MHz	D	100Hz
		High	453.0000 MHz	D	100Hz
		High	469.5000 MHz	D	100Hz
Test Results		Compliance			

**Plots of Emission Mask Measurement**

Referred as the attached plot hereinafter

Note: The yellow curve represents unmodulated signal.  
The green curve represents modulated signal.

Modulation Type	Channel Separation	Freq.(MHz)	FCC Applicable Mask	RBW	Audio Freq. (KHz)	Results
FM	12.5 KHz	400.5000	D	100Hz	2.5	Compliance

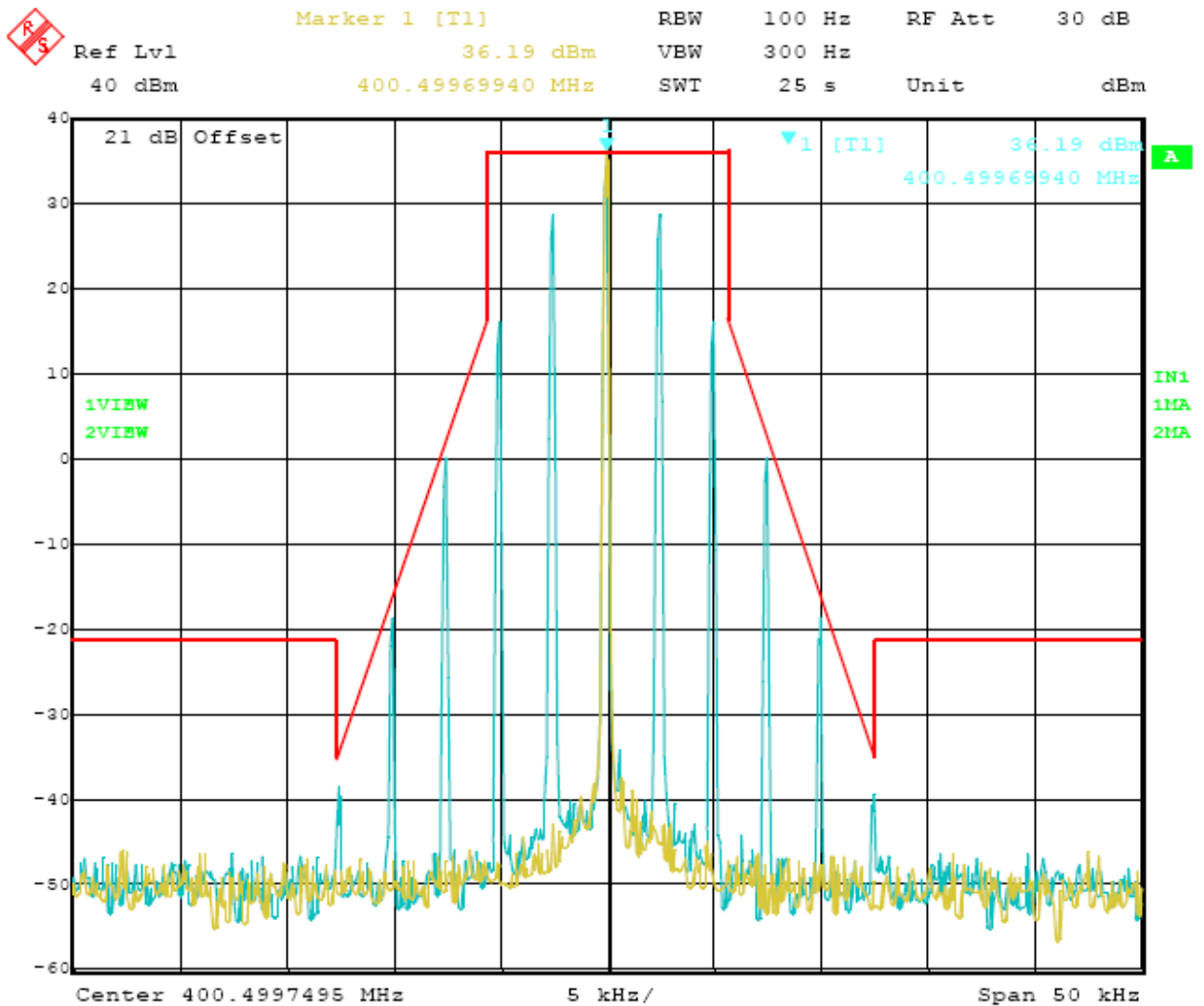

Date: 21.MAR.2011 19:47:58  
 12.5 kHz Channel Spacing, 400.5000 MHz, 2500 Hz Audio Modulation Only

Modulation Type	Channel Separation	Freq.(MHz)	FCC Applicable Mask	RBW	Audio Freq. (KHz)	Results
FM	12.5 KHz	418.0000	D	100	2.5	Compliance

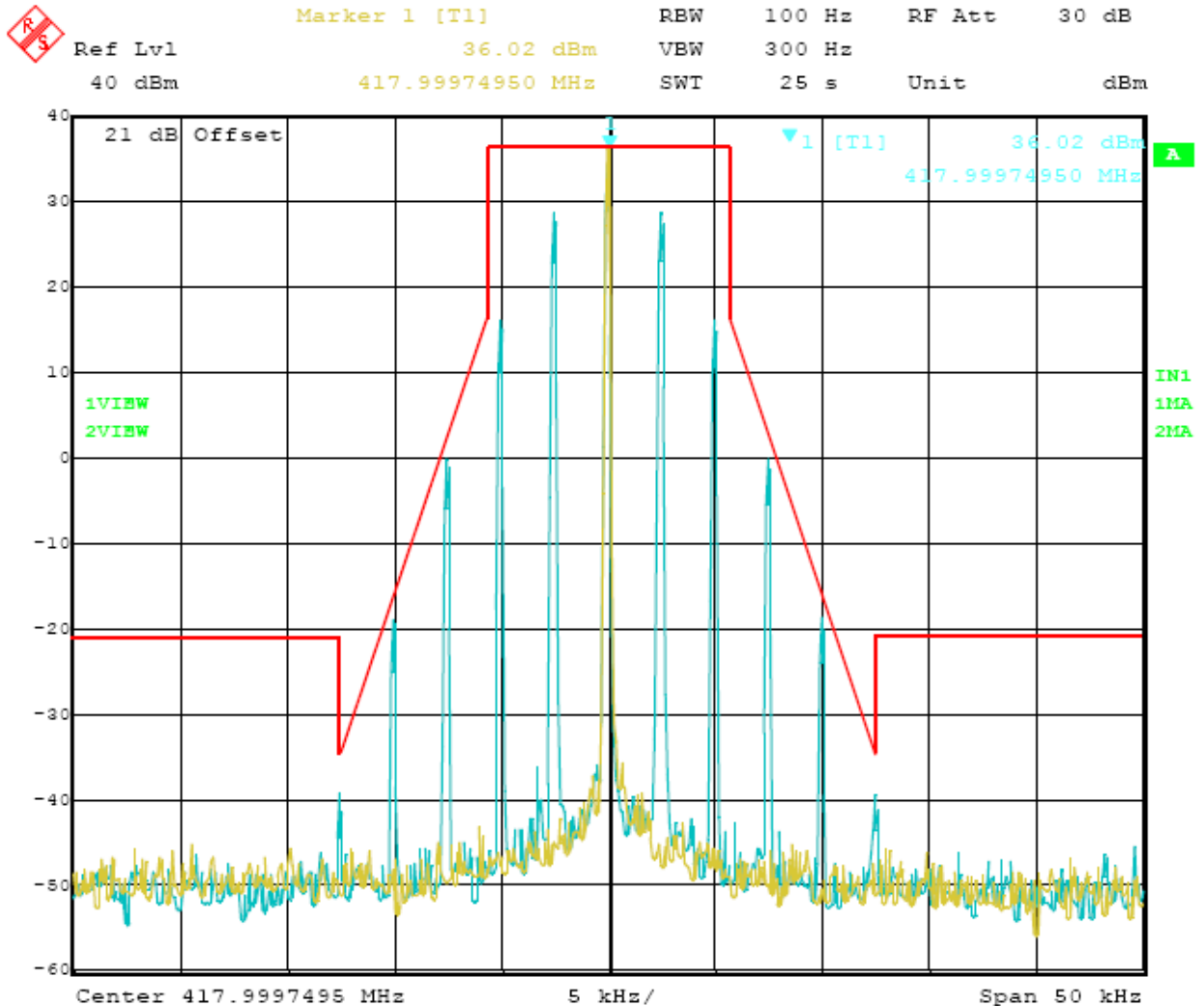

Date: 21.MAR.2011 19:46:06

12.5 kHz Channel Spacing, 418.0000 MHz, 2500 Hz Audio Modulation Only

Modulation Type	Channel Separation	Freq.(MHz)	FCC Applicable Mask	RBW	Audio Freq. (KHz)	Results
FM	12.5 KHz	435.5000	D	100Hz	2.5	Compliance

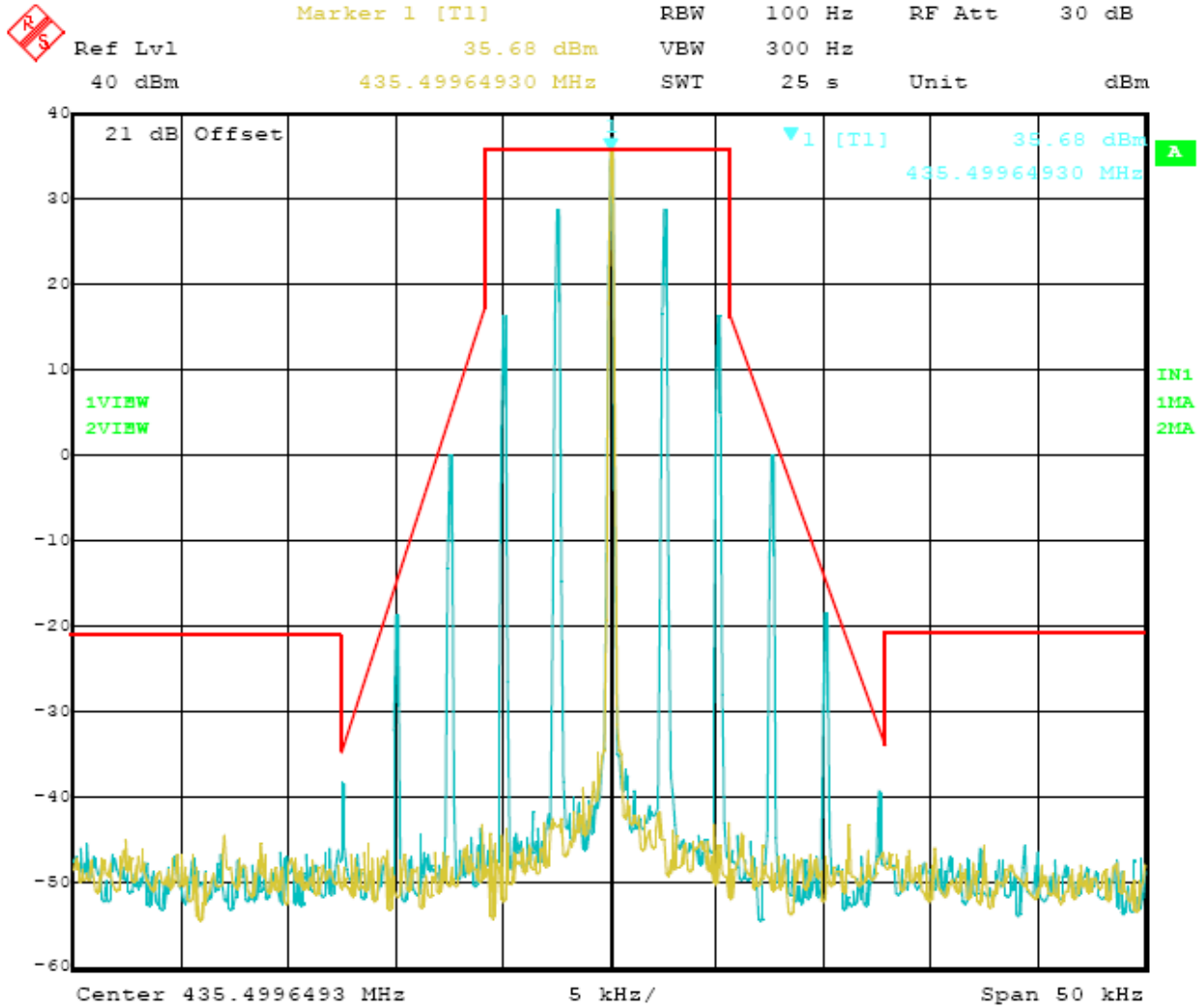

Date: 21.MAR.2011 19:44:17

12.5 kHz Channel Spacing, 435.5000 MHz, 2500 Hz Audio Modulation Only

Modulation Type	Channel Separation	Freq.(MHz)	FCC Applicable Mask	RBW	Audio Freq. (KHz)	Results
FM	12.5 KHz	453.0000	D	100Hz	2.5	Compliance

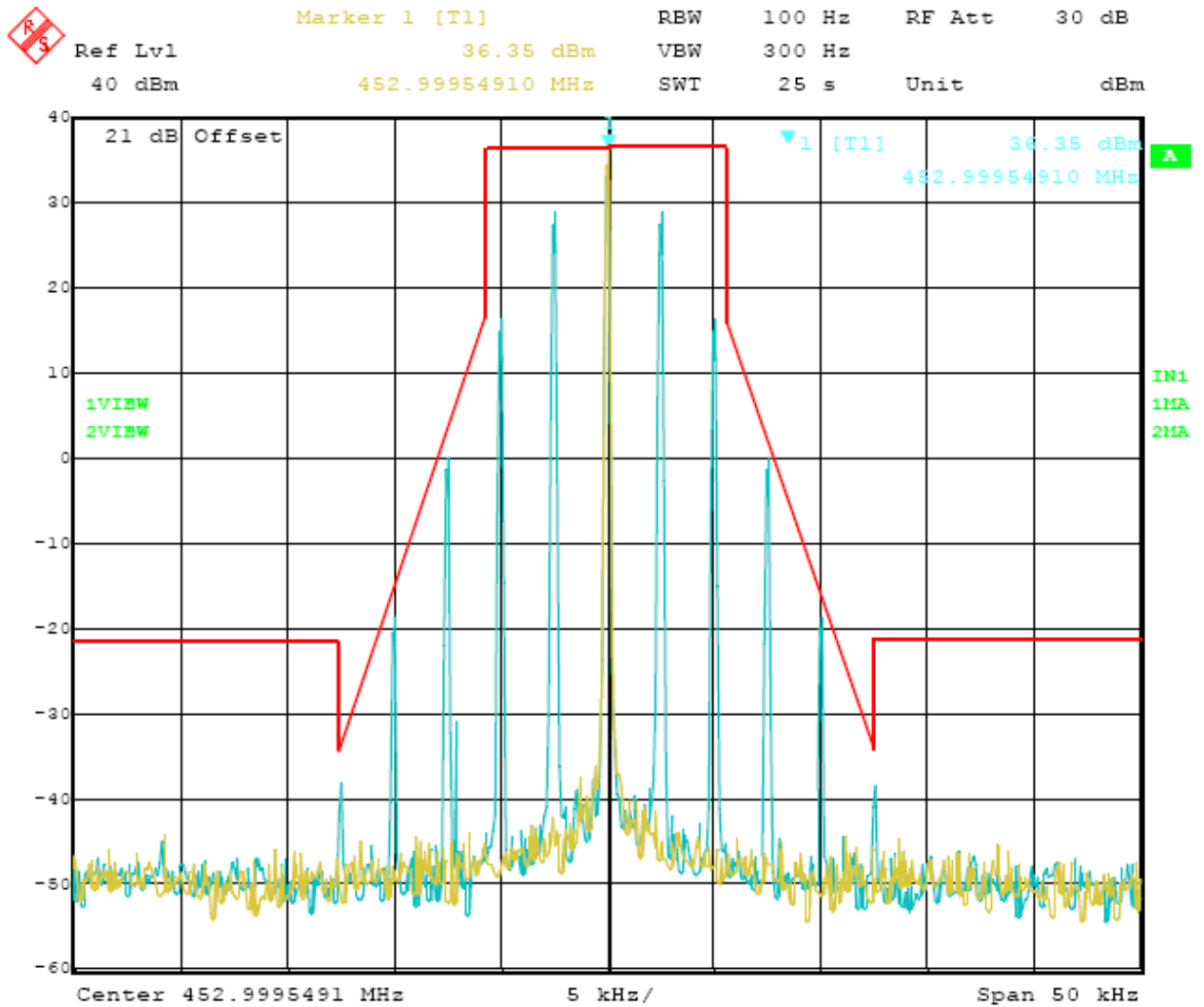

Date: 21.MAR.2011 19:39:38

12.5 kHz Channel Spacing, 453.0000 MHz, 2500 Hz Audio Modulation Only

Modulation Type	Channel Separation	Freq.(MHz)	FCC Applicable Mask	RBW	Audio Freq. (KHz)	Results
FM	12.5 KHz	469.5000	D	100Hz	2.5	Compliance

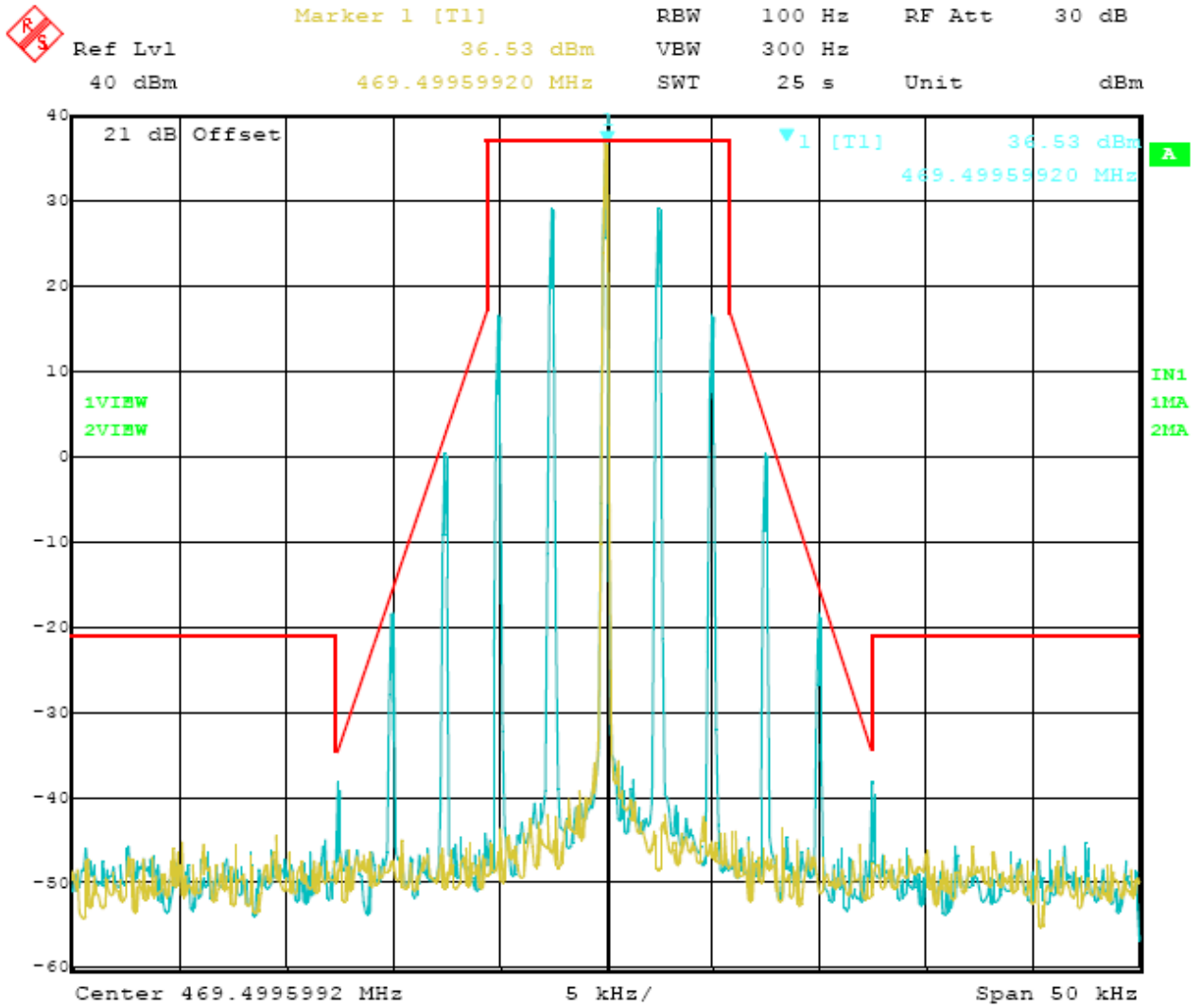

Date: 21.MAR.2011 19:37:26

12.5 kHz Channel Spacing, 469.5000 MHz, 2500 Hz Audio Modulation Only

### 4.3. Transmitter Radiated Spurious Emission

#### TEST APPLICABLE

According to the TIA/EIA 603 test method, and according to Section 90.210, the power of each unwanted emission shall be less than Transmitted Power as specified below for transmitters designed to operate with 12.5 KHz channel bandwidth:

- 1 On any frequency removed from the center of the authorized bandwidth  $f_0$  to 5.625 KHz removed from  $f_0$ : Zero dB
  - 2 On any frequency removed from the center of the authorized bandwidth by a displacement frequency ( $f_d$  in KHz)  $f_0$  of more than 5.625 KHz but no more than 12.5 KHz: At least 7.27dB
  - 3 On any frequency removed from the center of the authorized bandwidth by a displacement frequency ( $f_d$  in KHz)  $f_0$  of more than 12.5 KHz: At least  $50 + 10 \log(P)$  dB or 70 dB, which ever is lesser attenuation.
- For transmitters designed to transmit with 25 KHz channel separation and equipped with an audio low-pass filter, the power of any emission must be attenuated below the unmodulated carrier power (P) as following:

- 1 On any frequency removed from the assigned frequency by more than 50 percent, but no more than 100 percent of the authorized bandwidth: At least 25 dB.
- 2 On any frequency removed from the assigned frequency by more than 100 percent, but no more than 250 percent of the authorized bandwidth: At least 35 dB.
- 3 On any frequency removed from the assigned frequency by more than 250 percent of the authorized bandwidth: At least  $43 + 10 \log(P)$  dB.

#### TEST CONFIGURATION

Below 1GHz

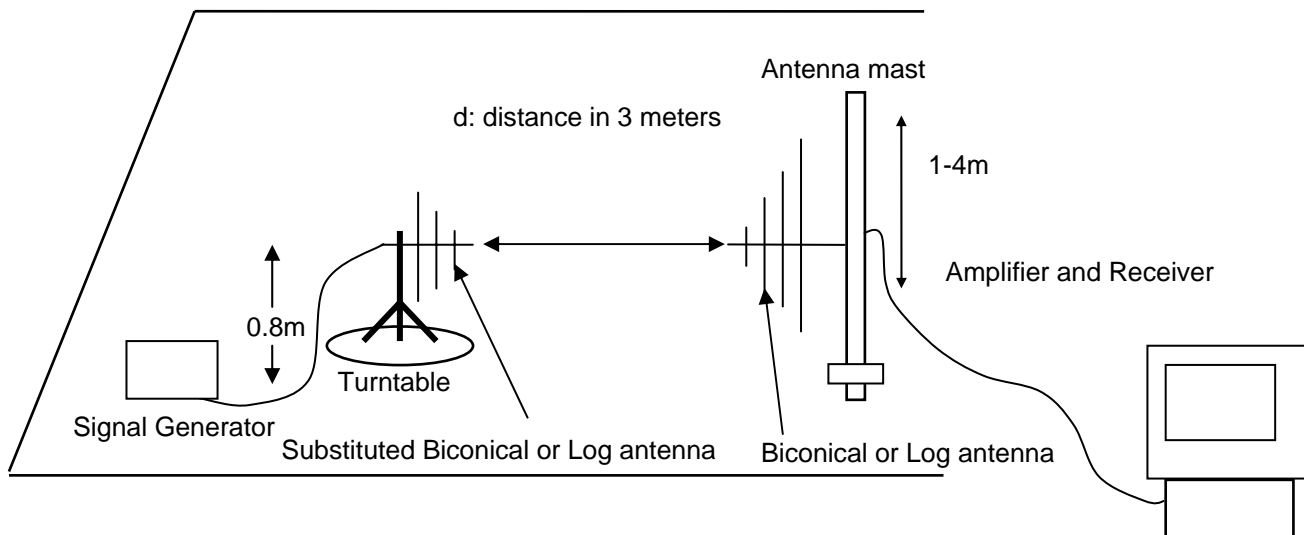
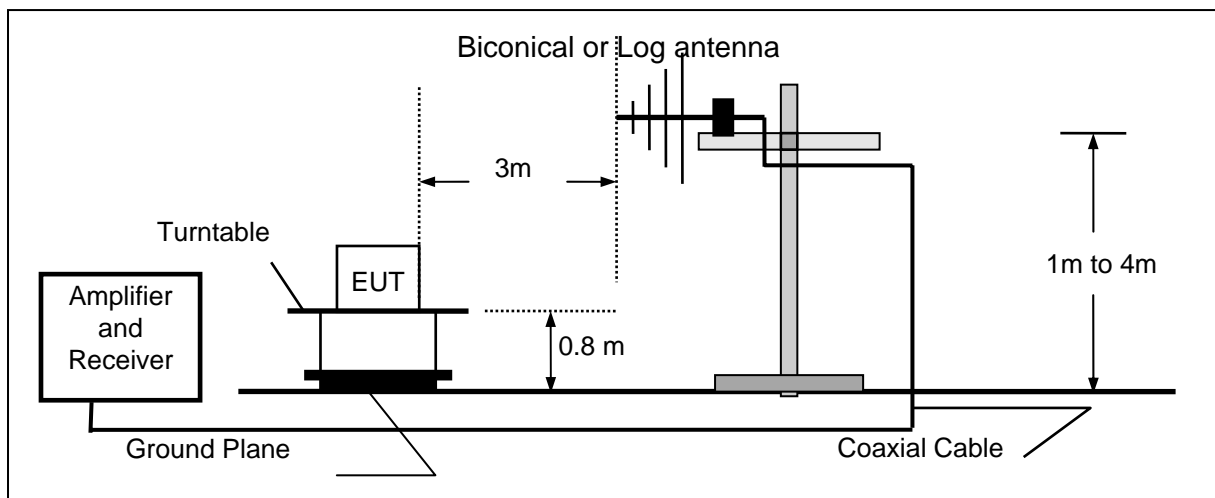

Above 1GHz

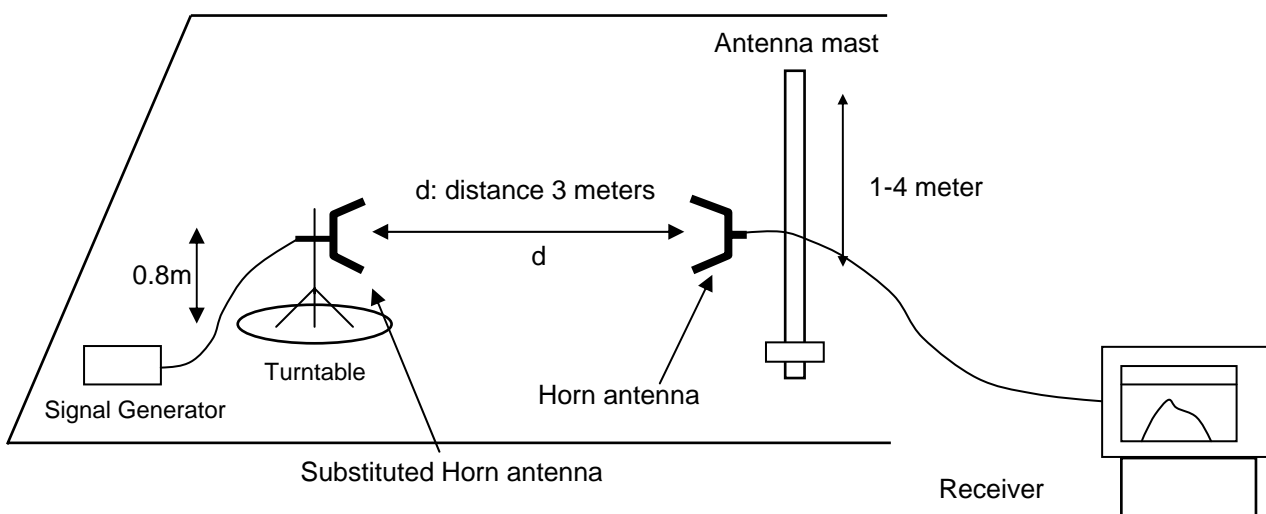
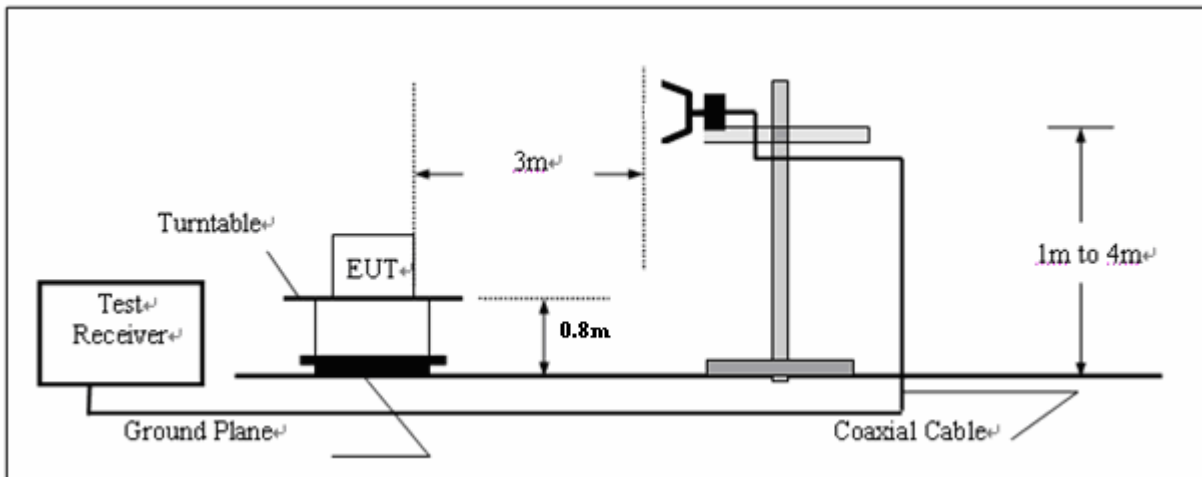

**TEST PROCEDURE**

- 1 On a test site, the EUT shall be placed on a turntable and in the position closest to the normal use as declared by the user.
- 2 The test antenna shall be oriented initially for vertical polarization located 3m from the EUT to correspond to the transmitter.
- 3 The output of the antenna shall be connected to the measuring receiver and either a peak or quasi-peak detector was used for the measurement as in dicated on the report. The detector selection is based on how close the emission level was approaching the limit.
- 4 The transmitter shall be switched on; if possible, without the modulation and the measurement receiver shall be tuned to the frequency of the transmitter under test.
- 5 The test antenna shall be raised and lowered through the specified range of height until the measuring receiver detects a maximum signal level.
- 6 The transmitter shall than be rotated through 360° in the horizontal plane, until the maximum signal level is detected by the measuring receiver.
- 7 The test antenna shall be raised and lowered again through the specified range of height until the measuring receiver detects a maximum signal level.
- 8 The maximum signal level detected by the measuring receiver shall be noted.
- 9 The measurement shall be repeated with the test antenna set to horizontal polarization.
- 10 Replace the antenna with a proper Antenna (substitution antenna).
- 11 The substitution antenna shall be oriented for vertical polarization and, if necessary, the length of the substitution antenna shall be adjusted to correspond to the frequency of transmitting.
- 12 The substitution antenna shall be connected to a calibrated signal generator.



- 13 If necessary, the input attenuator setting of the measuring receiver shall be adjusted in order to increase the sensitivity of the measuring receiver.
- 14 The test antenna shall be raised and lowered through the specified range of the height to ensure that the maximum signal is received.
- 15 The input signal to substitution antenna shall be adjusted to the level that produces a level detected by the measuring receiver, that is equal to the level noted while the transmitter radiated power was measured, corrected for the change of input attenuation setting of the measuring receiver.
- 16 The input level to the substitution antenna shall be recorded as power level in dBm, corrected for any change of input attenuator setting of the measuring receiver.
- 17 The measurement shall be repeated with the test antenna and the substitution antenna oriented for horizontal polarization

**TEST RESULTS**

The Transmitter Radiated Spurious Emission was performed to the Rated high power (4Watt) and Rated low power (0.5Watt) the datum that reported below is the worst case (Rated high power) of the two rated power conditions.

**Modulation Type: FM**

FCC Part 22.359, 74.462, 80.211 and 90.210 and RSS Gen, RSS 119 Issue 9 (12.5 kHz bandwidth only): On any frequency removed from the center of the authorized bandwidth by a displacement frequency (f d in kHz) of more than 12.5 kHz at least:

Low:  $50 + 10 \log (P_{\text{watts}}) = 50 + 10 \log (4.83) = 56.84 \text{ dB}$

High:  $50 + 10 \log (P_{\text{watts}}) = 50 + 10 \log (5.13) = 57.10 \text{ dB}$

Note: In general, the worse case attenuation requirement shown above was applied.

Calculation: Limit (dBm) =  $EL - 50 - 10 \log_{10} (TP)$

Notes: EL is the emission level of the Output Power expressed in dBm,

In this application, the EL is 36.02 dBm.

Limit (dBm) =  $36.02 - 50 - 10 \log_{10} (5.13) = -20 \text{ dBm}$

Note: 1. In general, the worse case attenuation requirement shown above was applied.

2. The measurement frequency range from 30 MHz to 5 GHz.

3. \*\*\* means that the emission level is too low to be measured or at least 20 dB down than the limit.

**Modulation Type: FM**

Test Channel		Low Channel		Test Frequency		400.5000 MHz		
Frequency (MHz)	E-Field Level (dBuV/m)	EMI Detector (Peak/QP)	Antenna Polarization	Antenna Height (cm)	Table Angle (Degree)	ERP measured by Substitution Method (dBm)	Limit (dBm)	Margin (dB)
801.72	70.36	Peak	H	1.00	175	-26.84	-20	6.84
2402.80	61.59	Peak	H	1.50	175	-35.21	-20	15.21
2803.61	73.24	Peak	H	1.50	256	-23.76	-20	3.76
...	...		H			...		
801.72	69.76	Peak	V	1.00	136	-27.44	-20	7.44
2803.61	71.01	Peak	V	2.00	136	-25.79	-20	5.79
3204.41	65.65	Peak	V	1.50	215	-31.35	-20	11.35
...	...		V			...		

Test Channel		Low Channel		Test Frequency		418.0000 MHz		
Frequency (MHz)	E-Field Level (dBuv/m)	EMI Detector (Peak/QP)	Antenna Polarization	Antenna Height (cm)	Table Angle (Degree)	ERP measured by Substitution Method (dBm)	Limit (dBm)	Margin (dB)
836.71	65.92	Peak	H	1.00	245	-31.28	-20	11.28
2923.84	67.27	Peak	H	1.50	25	-29.53	-20	9.53
3344.69	63.32	Peak	H	1.50	26	-33.68	-20	13.68
...			H					
836.71	70.24	Peak	V	1.00	168	-26.96	-20	6.96
2923.84	67.23	Peak	V	2.00	16	-29.57	-20	9.57
3344.69	63.75	Peak	V	1.50	45	-33.25	-20	13.25
...	...		V			...		

Test Channel		Low Channel		Test Frequency		435.5000 MHz		
Frequency (MHz)	E-Field Level (dBuv/m)	EMI Detector (Peak/QP)	Antenna Polarization	Antenna Height (cm)	Table Angle (Degree)	ERP measured by Substitution Method (dBm)	Limit (dBm)	Margin (dB)
871.70	57.65	Peak	H	1.00	163	-39.55	-20	19.55
2613.22	72.34	Peak	H	1.50	85	-24.46	-20	4.46
3484.97	64.79	Peak	H	1.50	76	-32.21	-20	12.21
...			H					
871.70	62.51	Peak	V	1.00	93	-34.69	-20	14.69
2613.22	65.19	Peak	V	2.00	85	-31.61	-20	11.61
3484.97	61.39	Peak	V	1.50	71	-35.61	-20	15.61
...	...		V			...		

Test Channel		Low Channel		Test Frequency		435.5000 MHz		
Frequency (MHz)	E-Field Level (dBuv/m)	EMI Detector (Peak/QP)	Antenna Polarization	Antenna Height (cm)	Table Angle (Degree)	ERP measured by Substitution Method (dBm)	Limit (dBm)	Margin (dB)
906.69	57.12	Peak	H	1.00	74	-40.08	-20	20.08
2713.42	74.77	Peak	H	1.50	175	-22.03	-20	2.03
3625.25	59.49	Peak	H	1.50	156	-37.51	-20	17.51
...			H					
906.69	61.61	Peak	V	1.00	75	-35.59	-20	15.59
2713.42	75.33	Peak	V	2.00	114	-21.47	-20	1.47
1811.62	56.39	Peak	V	1.50	352	-40.61	-20	20.61
...	...		V			...		

Test Channel		Low Channel		Test Frequency		435.5000 MHz		
Frequency (MHz)	E-Field Level (dBuv/m)	EMI Detector (Peak/QP)	Antenna Polarization	Antenna Height (cm)	Table Angle (Degree)	ERP measured by Substitution Method (dBm)	Limit (dBm)	Margin (dB)
939.74	69.87	Peak	H	1.00	223	-27.33	-20	7.33
2813.63	69.53	Peak	H	1.50	41	-27.27	-20	7.27
3755.51	60.49	Peak	H	1.50	63	-36.51	-20	16.51
...			H					
939.74	70.76	Peak	V	1.00	52	-26.44	-20	6.44
2813.63	67.42	Peak	V	2.00	41	-29.38	-20	9.38
1400.80	58.66	Peak	V	1.50	133	-38.34	-20	18.34
...	...		V			...		

### 4.4. Spurious Emssion on Antenna Port

#### TEST APPLICABLE

The same as Section 4.3

#### TEST PROCEDURE

The RF output of the EUT was connected to a spectrum analyzer through appropriate attenuation. The resolution bandwidth of the spectrum analyzer was set to 100 kHz. Sufficient scans were taken to show any out of band emission up to 10th. Harmonic for the lower and the highest frequency range. Set RBW 100 kHz, VBW 300 kHz in the frequency band 30MHz to 1GHz,while set RBW=1MHz.VBW=3MHz from the 1GHz to 10<sup>th</sup> Harmonic.

The audio input was set to 0 to get the unmodulated carrier, the resulting picture is print out for each channel separation.

#### TEST CONFIGURATION

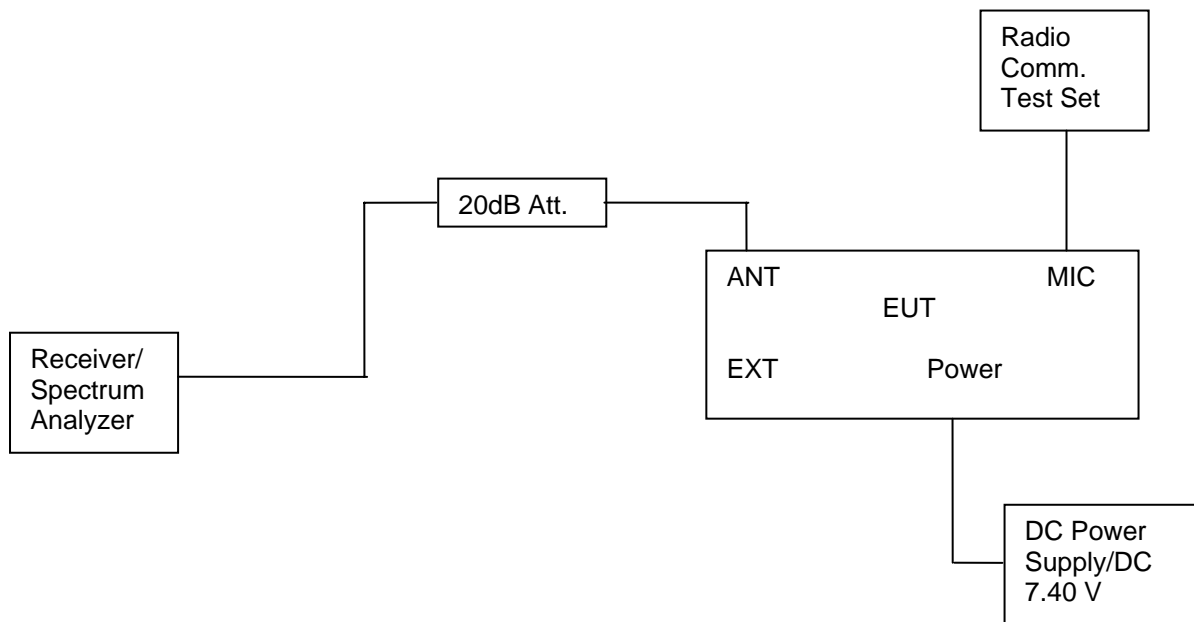

#### TEST RESULTS

##### Modulation Type: FM

FCC Part 22.359, 74.462, 80.211 and 90.210 and RSS Gen, RSS 119 Issue 9 (12.5 kHz bandwidth only): On any frequency removed from the center of the authorized bandwidth by a displacement frequency (f d in kHz) of more than 12.5 kHz at least:

Low:  $50 + 10 \log (P_{watts}) = 50 + 10 \log (4.83) = 56.84 \text{ dB}$

High:  $50 + 10 \log (P_{watts}) = 50 + 10 \log (5.13) = 57.10 \text{ dB}$

Note: In general, the worse case attenuation requirement shown above was applied.

Calculation: Limit (dBm) = EL-50-10log<sub>10</sub> (TP)

Notes: EL is the emission level of the Output Power expressed in dBm,

In this application, the EL is 36.02 dBm.

Limit (dBm) = 36.02-50-10log<sub>10</sub> (5.13) = -20 dBm

Note: 1. In general, the worse case attenuation requirement shown above was applied.

2. The measurement frequency range from 30MHz to 5GHz.

**For Rated High Power (4Watt)**

Modulation Type	Channel Separation	Test Channel	Test Frequency (MHz)	Maximum Conducted Spurious Emissions Below 1GHz		Maximum Conducted Spurious Emissions Above 1GHz	
				Frequency (MHz)	Datum (dBm)	Frequency (MHz)	Datum (dBm)
FM	12.5KHz	Low	400.5000	801.72	-28.57	4735.47	-26.86
		Low	418.0000	836.71	-28.97	1248.49	-26.07
		Middle	435.5000	871.70	-29.71	3877.75	-27.41
		High	453.0000	906.69	-30.40	4655.31	-27.35
		High	469.5000	939.74	-29.53	2803.61	-26.70
Limit		-20dBm for 12.5KHz Channel Separation					
Test Results		Compliance					

**For Rated Low Power (0.5Watt)**

Modulation Type	Channel Separation	Test Channel	Test Frequency (MHz)	Maximum Conducted Spurious Emissions Below 1GHz		Maximum Conducted Spurious Emissions Above 1GHz	
				Frequency (MHz)	Datum (dBm)	Frequency (MHz)	Datum (dBm)
FM	12.5KHz	Low	400.5000	801.72	-27.94	3941.88	-27.02
		Low	418.0000	848.38	-35.46	4022.04	-27.28
		Middle	435.5000	871.70	-37.06	1849.69	-26.61
		High	453.0000	906.69	-37.05	3052.10	-27.10
		High	469.5000	924.18	-36.21	2779.56	-27.48
Limit		-20dBm for 12.5KHz Channel Separation					
Test Results		Compliance					

**Plots of Spurious Emission on Antenna Port Measurement**

**For Rated High Power (4Watt)**

Modulation Type	Channel SpARATION	Test Channel	Test Frequency (MHz)	Maximum Conducted Spurious Emissions Below 1GHz		Maximum Conducted Spurious Emissions Above 1GHz		FCC Limit
				Frequency (MHz)	Datum (dBm)	Frequency (MHz)	Datum (dBm)	
FM	12.5KHz	Low	400.5000	801.72	-28.57	4735.47	-26.86	-20dBm
Test Results				Compliance				

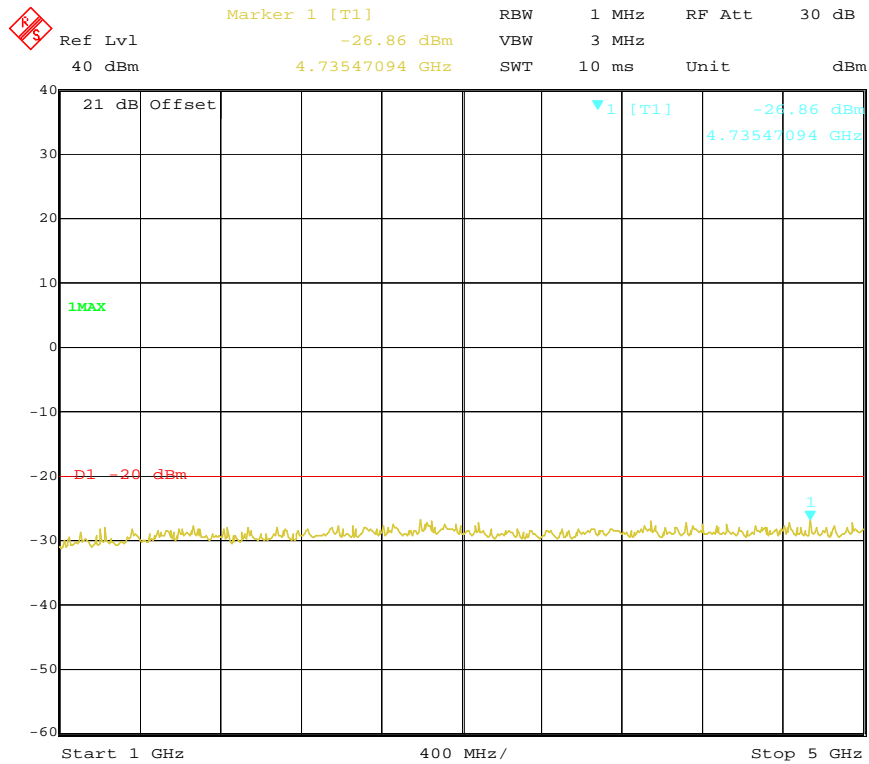
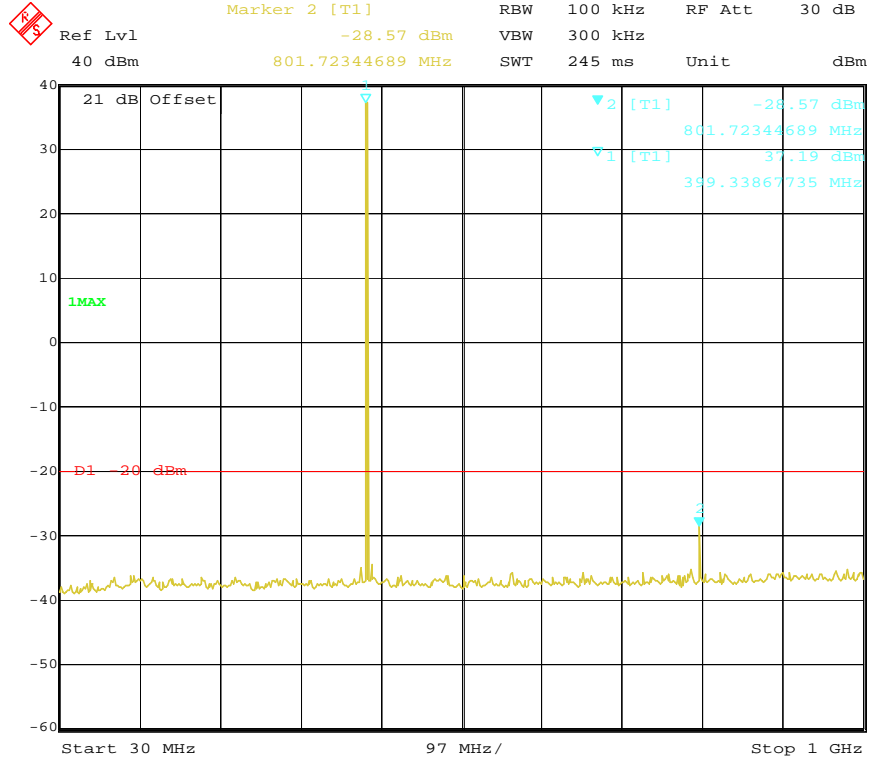

Modulation Type	Channel Separation	Test Channel	Test Frequency (MHz)	Maximum Conducted Spurious Emissions Below 1GHz		Maximum Conducted Spurious Emissions Above 1GHz		FCC Limit
				Frequency (MHz)	Datum (dBm)	Frequency (MHz)	Datum (dBm)	
FM	12.5KHz	Low	418.0000	836.71	-28.97	1248.49	-26.07	-20dBm
Test Results				Compliance				

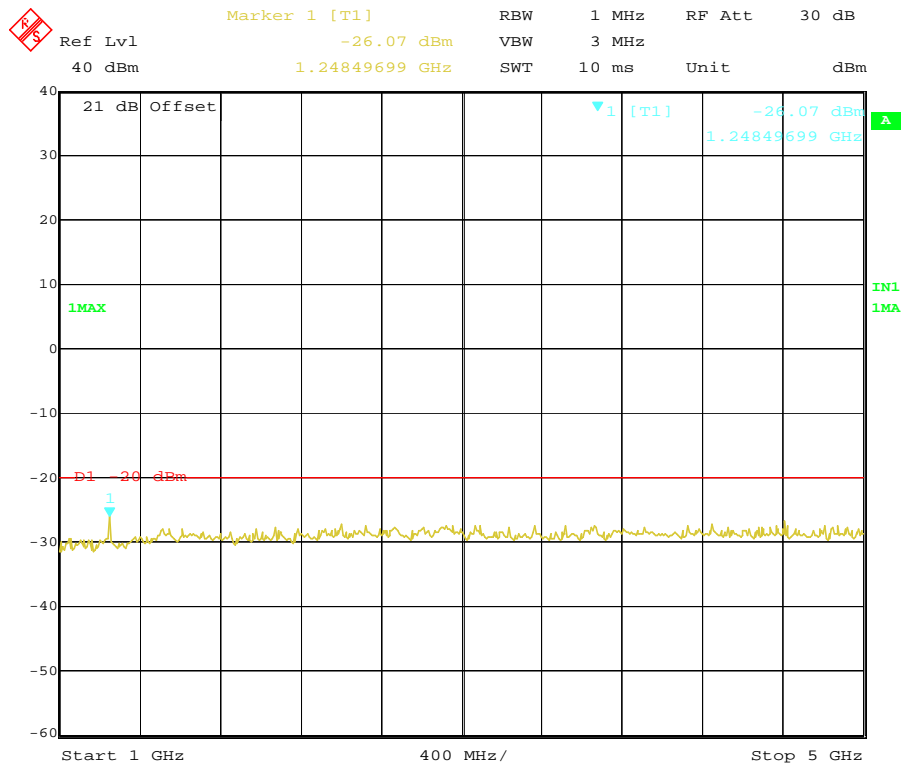
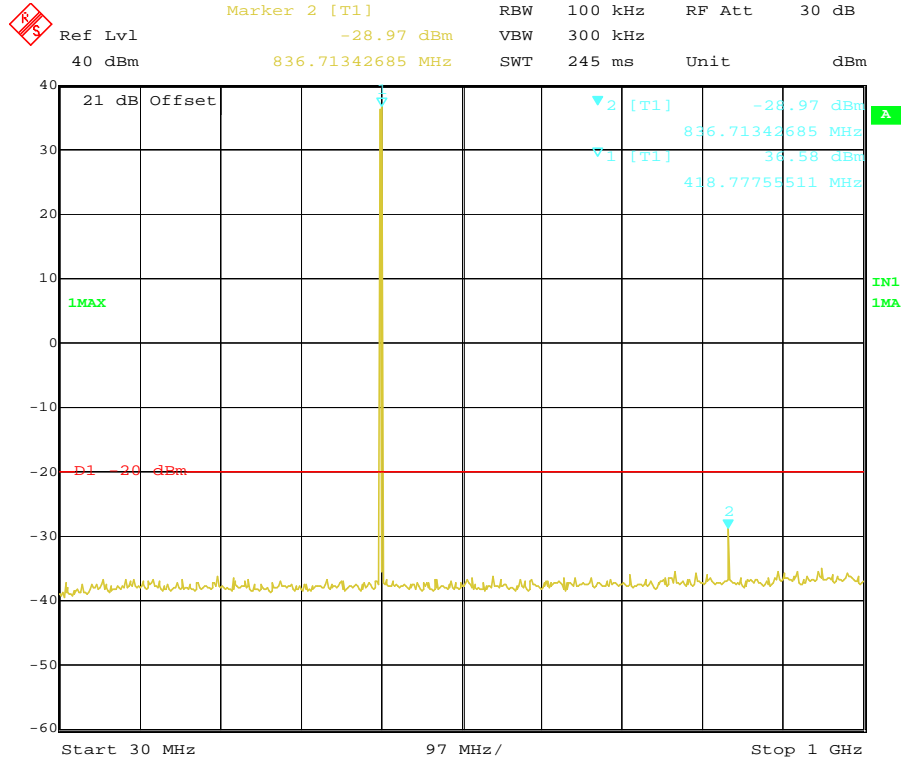

Modulation Type	Channel Separation	Test Channel	Test Frequency (MHz)	Maximum Conducted Spurious Emissions Below 1GHz		Maximum Conducted Spurious Emissions Above 1GHz		FCC Limit
				Frequency (MHz)	Datum (dBm)	Frequency (MHz)	Datum (dBm)	
FM	12.5KHz	Middle	435.5000	871.70	-29.71	3877.75	-27.41	-20dBm
Test Results				Compliance				

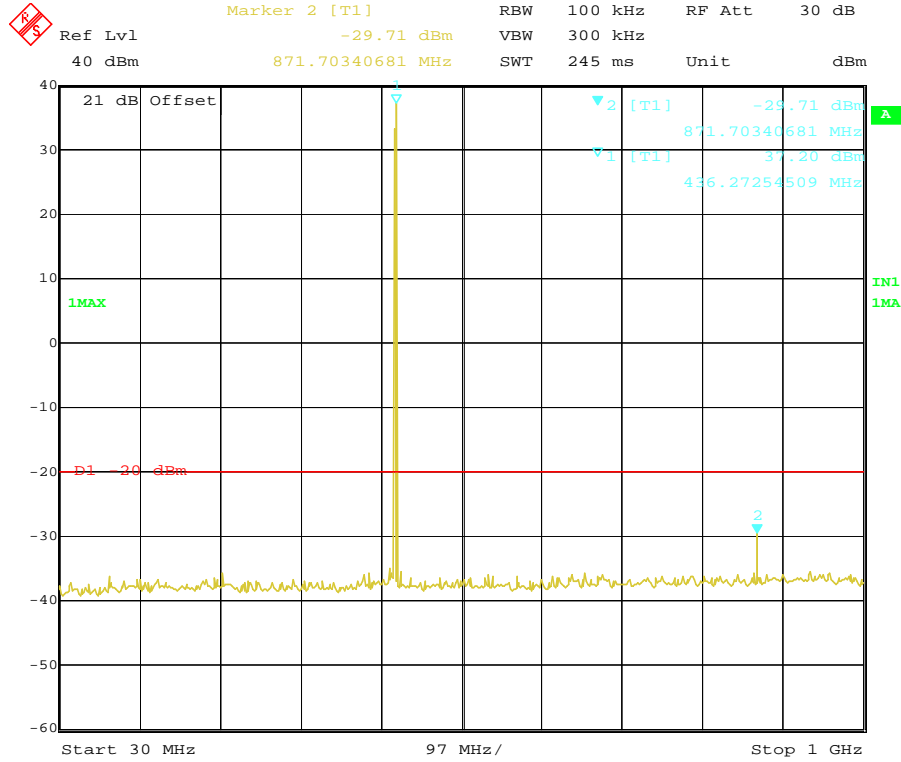

Date: 21.MAR.2011 19:09:04

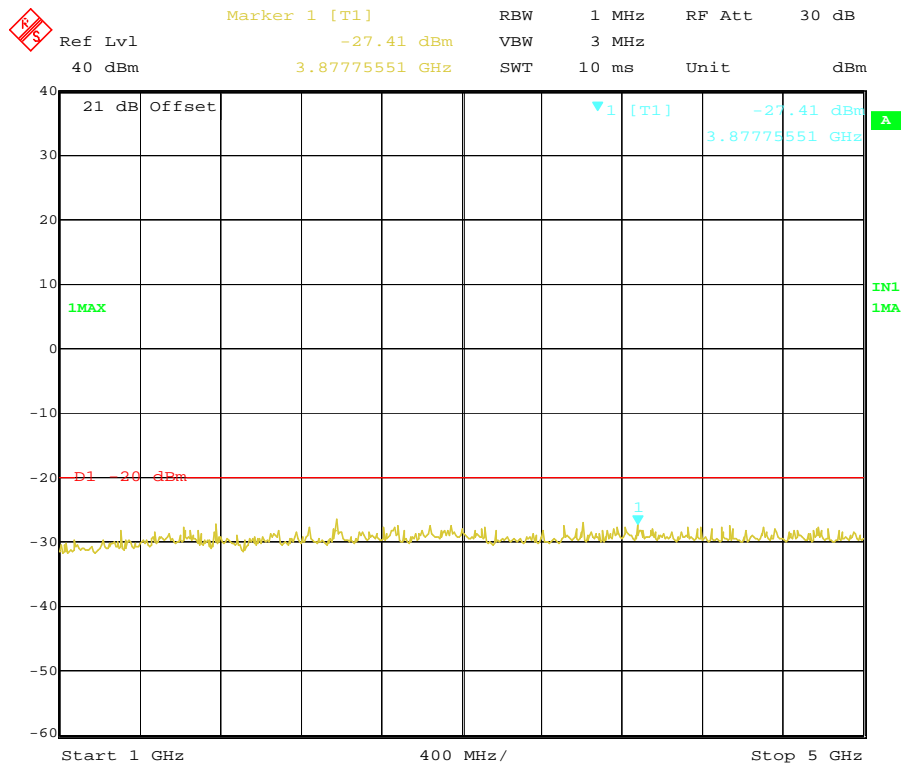

Date: 21.MAR.2011 19:14:50

Modulation Type	Channel Separation	Test Channel	Test Frequency (MHz)	Maximum Conducted Spurious Emissions Below 1GHz		Maximum Conducted Spurious Emissions Above 1GHz		FCC Limit
				Frequency (MHz)	Datum (dBm)	Frequency (MHz)	Datum (dBm)	
FM	12.5KHz	High	453.0000	906.69	-30.40	4655.31	-27.35	-20dBm
Test Results				Compliance				

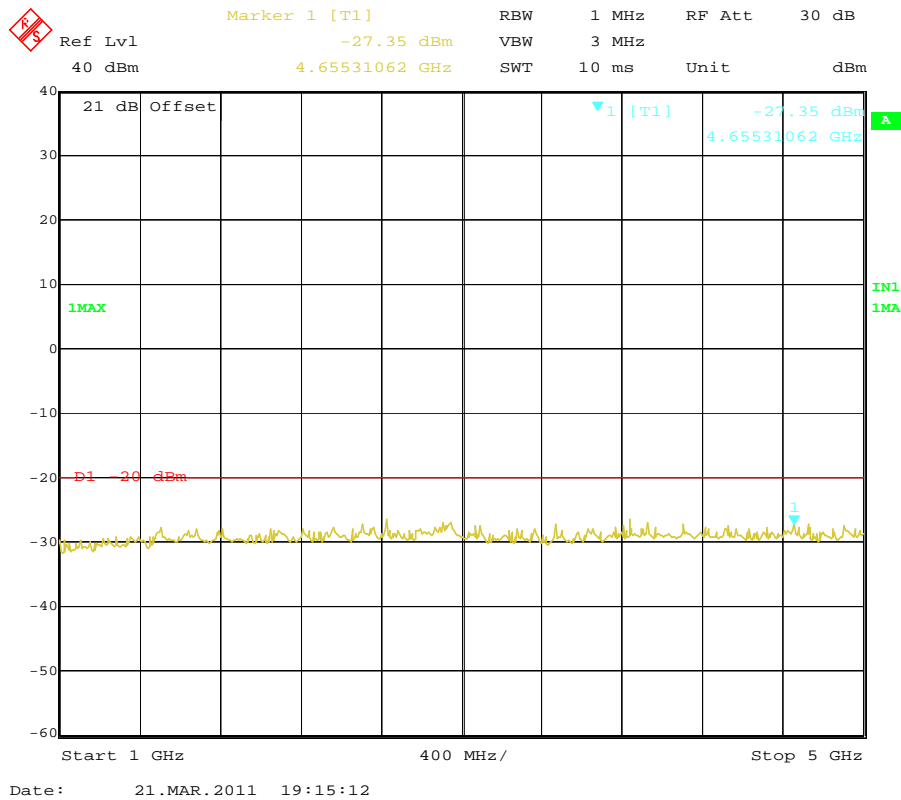
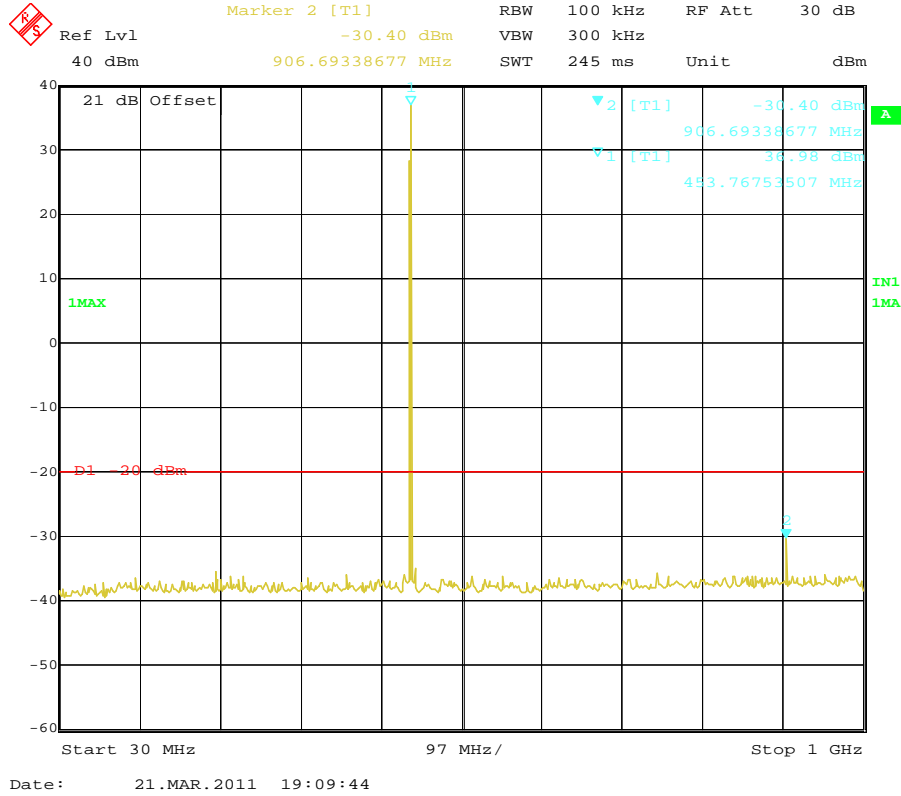



Modulation Type	Channel Separation	Test Channel	Test Frequency (MHz)	Maximum Conducted Spurious Emissions Below 1GHz		Maximum Conducted Spurious Emissions Above 1GHz		FCC Limit
				Frequency (MHz)	Datum (dBm)	Frequency (MHz)	Datum (dBm)	
FM	12.5KHz	High	469.5000	939.74	-29.53	2803.61	-26.70	-20dBm
Test Results				Compliance				

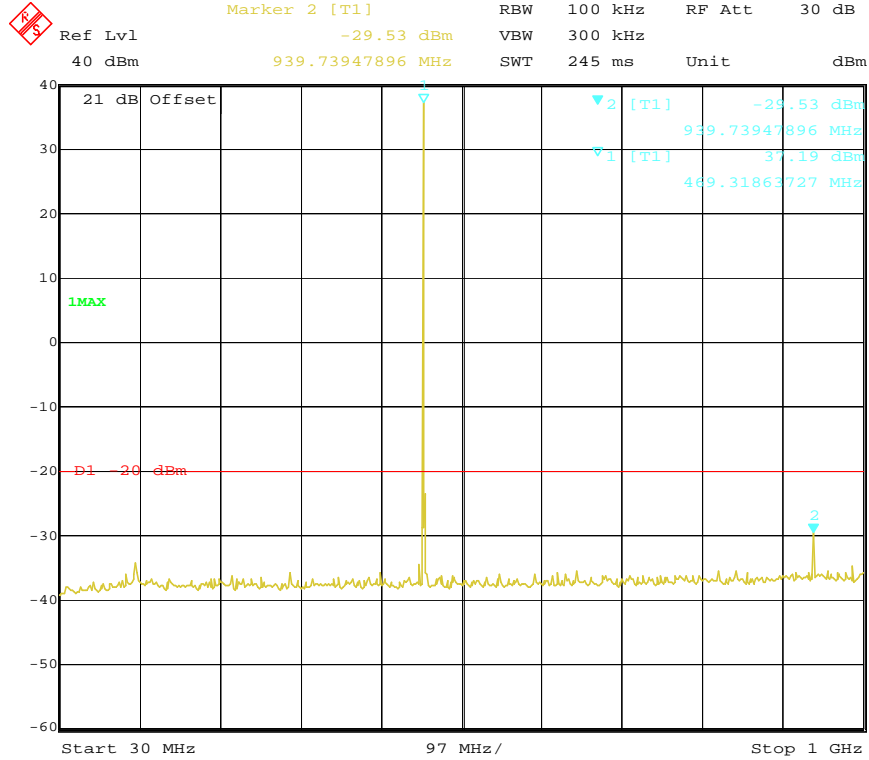

Date: 21.MAR.2011 19:10:37

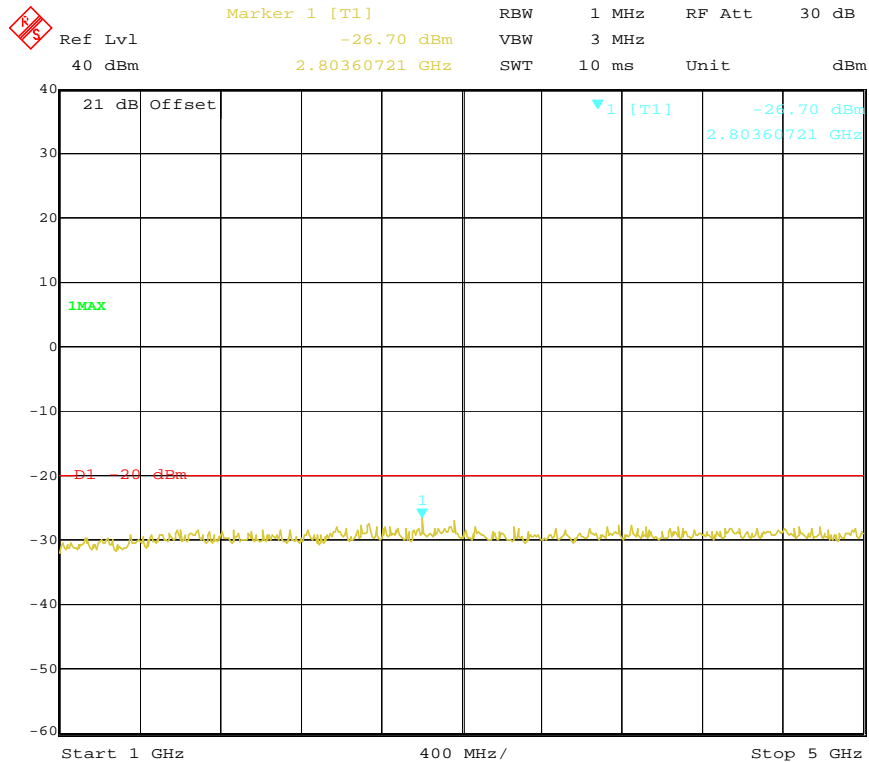

Date: 21.MAR.2011 19:15:36

For Rated Low Power (0.5Watt)

Modulation Type	Channel Separation	Test Channel	Test Frequency (MHz)	Maximum Conducted Spurious Emissions Below 1GHz		Maximum Conducted Spurious Emissions Above 1GHz		FCC Limit
				Frequency (MHz)	Datum (dBm)	Frequency (MHz)	Datum (dBm)	
FM	12.5KHz	Low	400.5000	801.72	-27.94	3941.88	-27.02	-20 dBm
Test Results				Compliance				

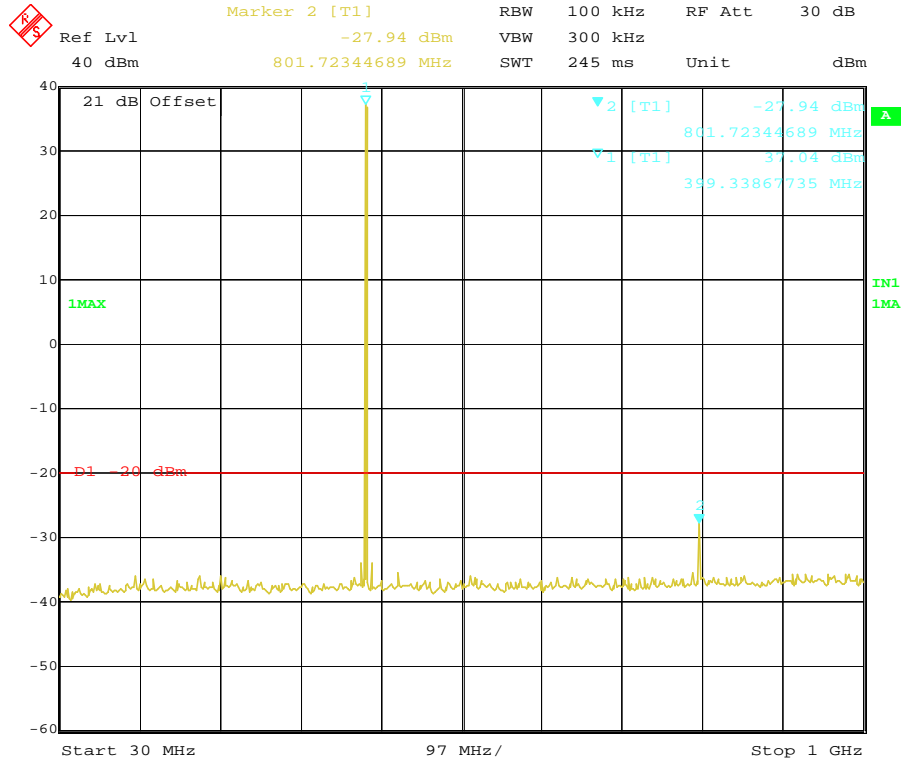

Date: 21.MAR.2011 19:07:35

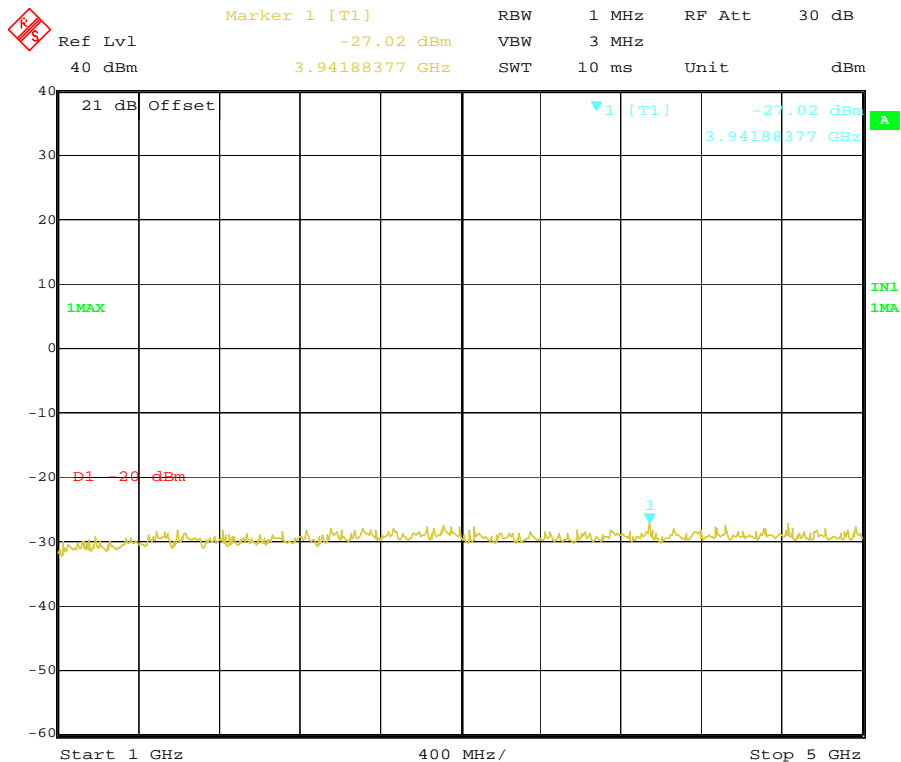

Date: 21.MAR.2011 19:13:50

Modulation Type	Channel Separation	Test Channel	Test Frequency (MHz)	Maximum Conducted Spurious Emissions Below 1GHz		Maximum Conducted Spurious Emissions Above 1GHz		FCC Limit
				Frequency (MHz)	Datum (dBm)	Frequency (MHz)	Datum (dBm)	
FM	12.5KHz	Low	418.0000	848.38	-35.46	4022.04	-27.25	-20 dBm
Test Results				Compliance				

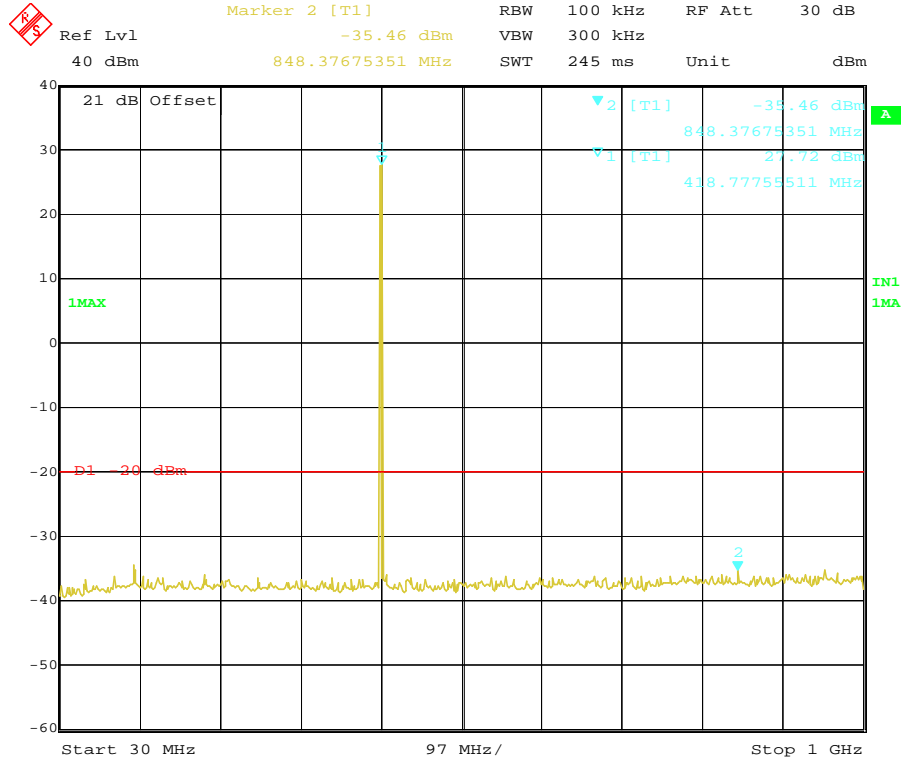

Date: 21.MAR.2011 19:08:01

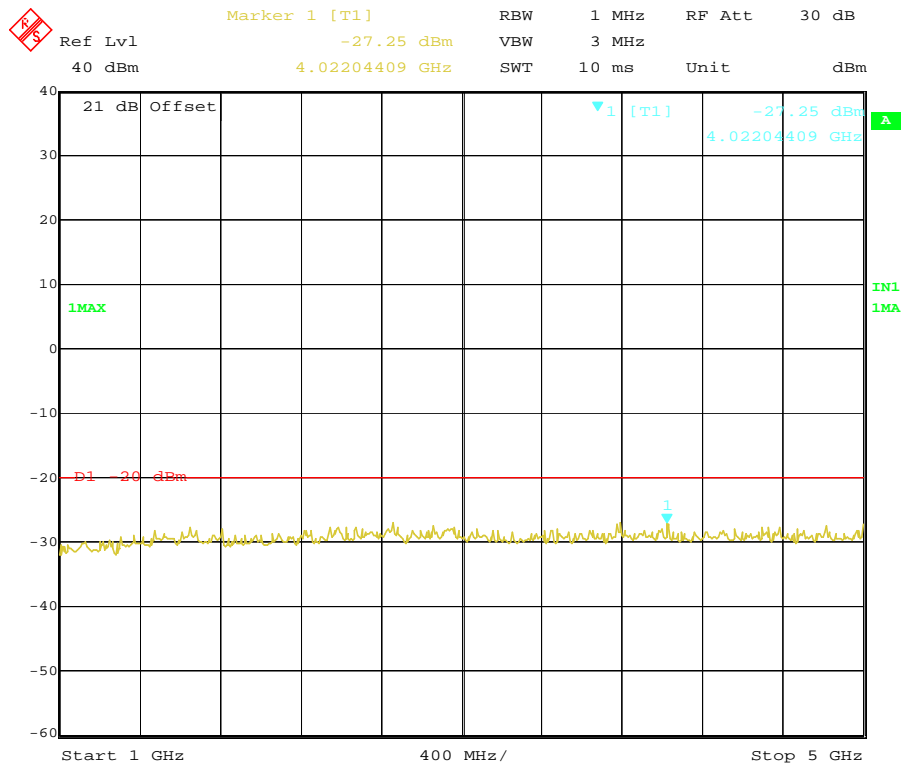

Date: 21.MAR.2011 19:14:31

Modulation Type	Channel SpARATION	Test Channel	Test Frequency (MHz)	Maximum Conducted Spurious Emissions Below 1GHz		Maximum Conducted Spurious Emissions Above 1GHz		FCC Limit
				Frequency (MHz)	Datum (dBm)	Frequency (MHz)	Datum (dBm)	
FM	12.5KHz	Middle	435.5000	871.70	-37.06	1849.69	-26.61	-20 dBm
Test Results				Compliance				

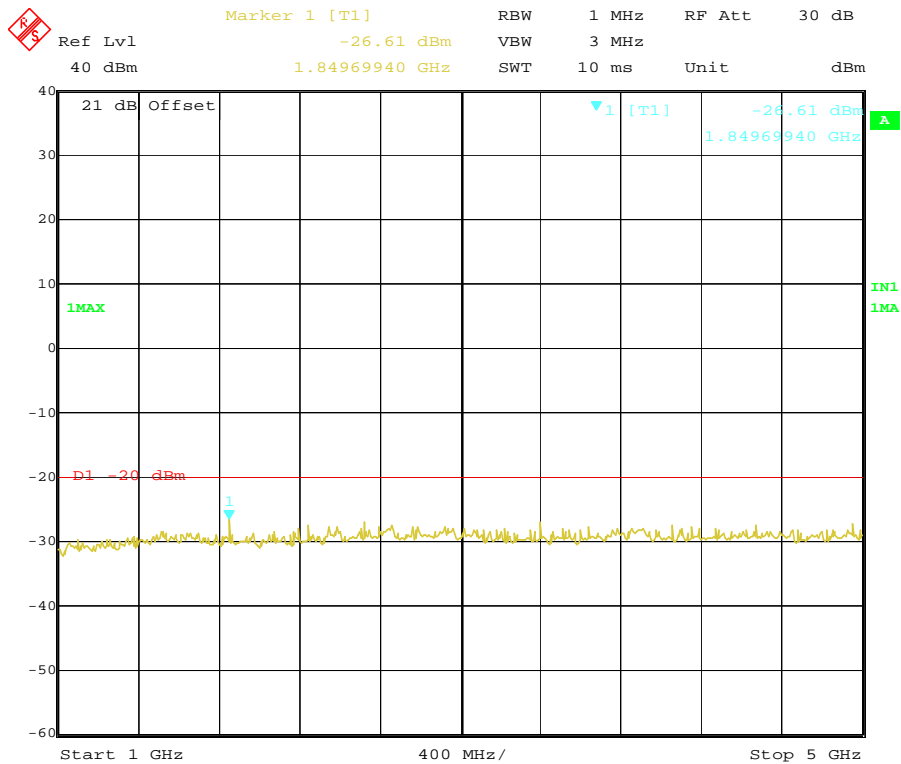
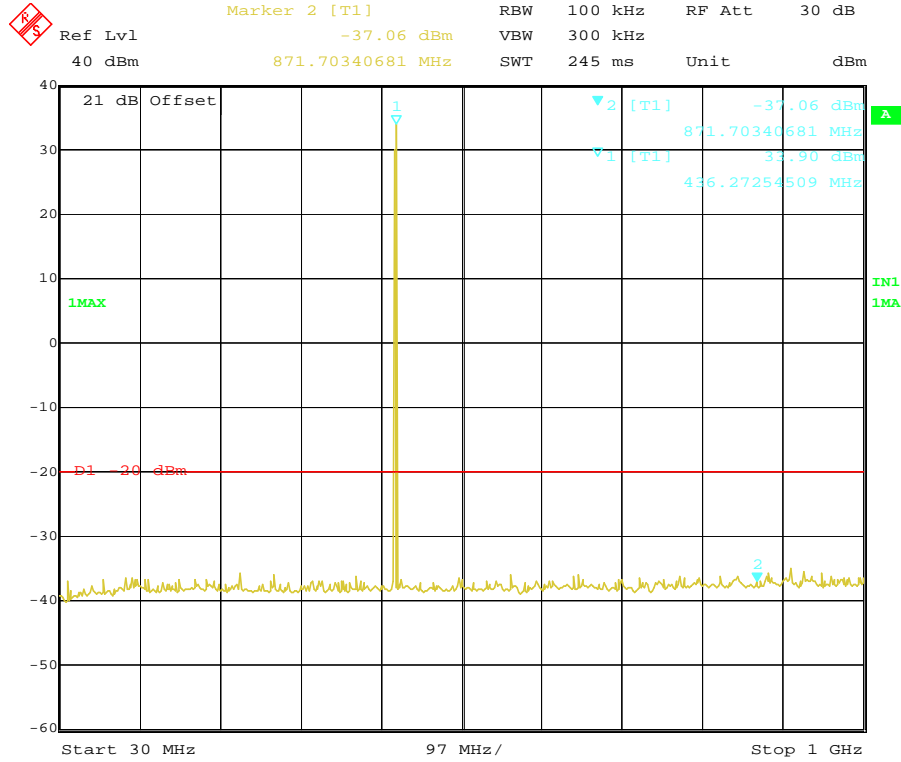

Modulation Type	Channel Separation	Test Channel	Test Frequency (MHz)	Maximum Conducted Spurious Emissions Below 1GHz		Maximum Conducted Spurious Emissions Above 1GHz		FCC Limit
				Frequency (MHz)	Datum (dBm)	Frequency (MHz)	Datum (dBm)	
FM	12.5KHz	High	453.0000	906.69	-37.05	3052.10	-27.10	-20dBm
Test Results				Compliance				

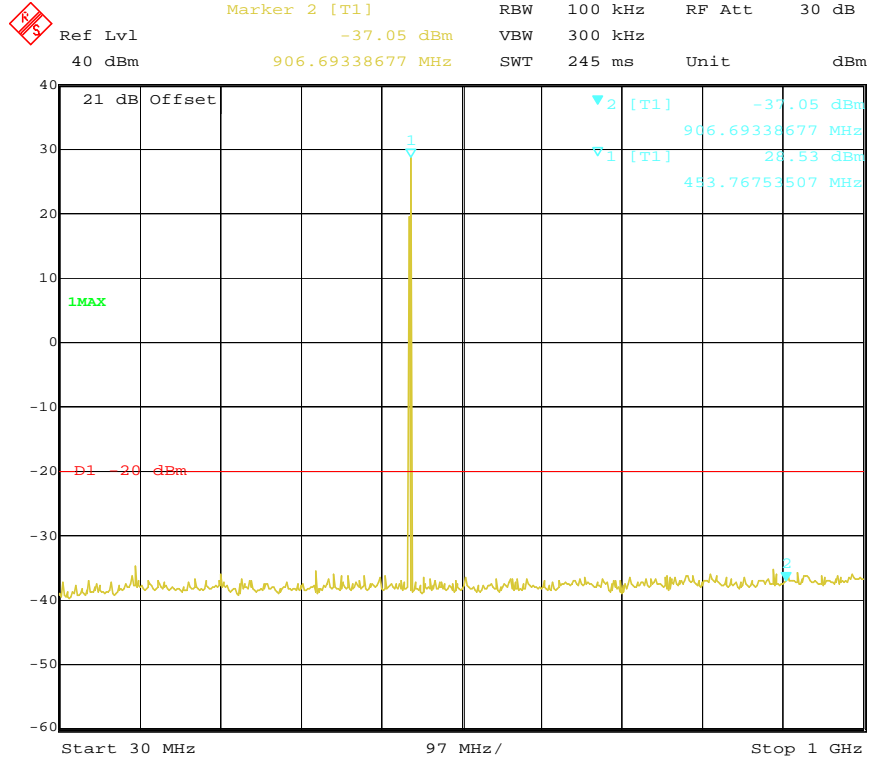

Date: 21.MAR.2011 19:10:02

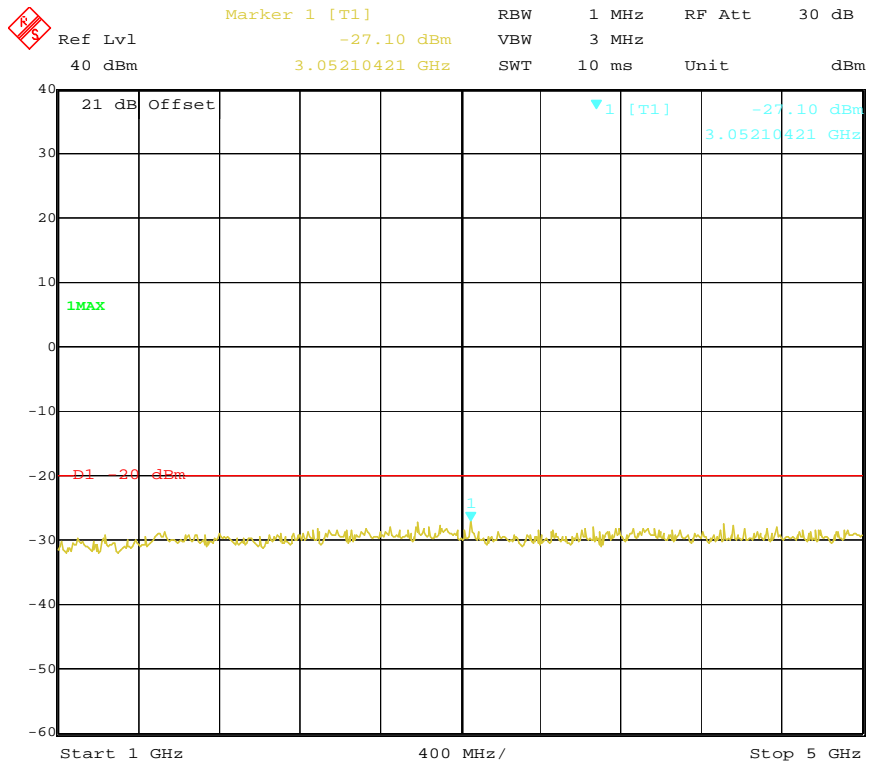

Date: 21.MAR.2011 19:14:59

Modulation Type	Channel SpARATION	Test Channel	Test Frequency (MHz)	Maximum Conducted Spurious Emissions Below 1GHz		Maximum Conducted Spurious Emissions Above 1GHz		FCC Limit
				Frequency (MHz)	Datum (dBm)	Frequency (MHz)	Datum (dBm)	
FM	12.5KHz	High	469.5000	924.18	-36.21	2779.56	-27.48	-20dBm
Test Results				Compliance				

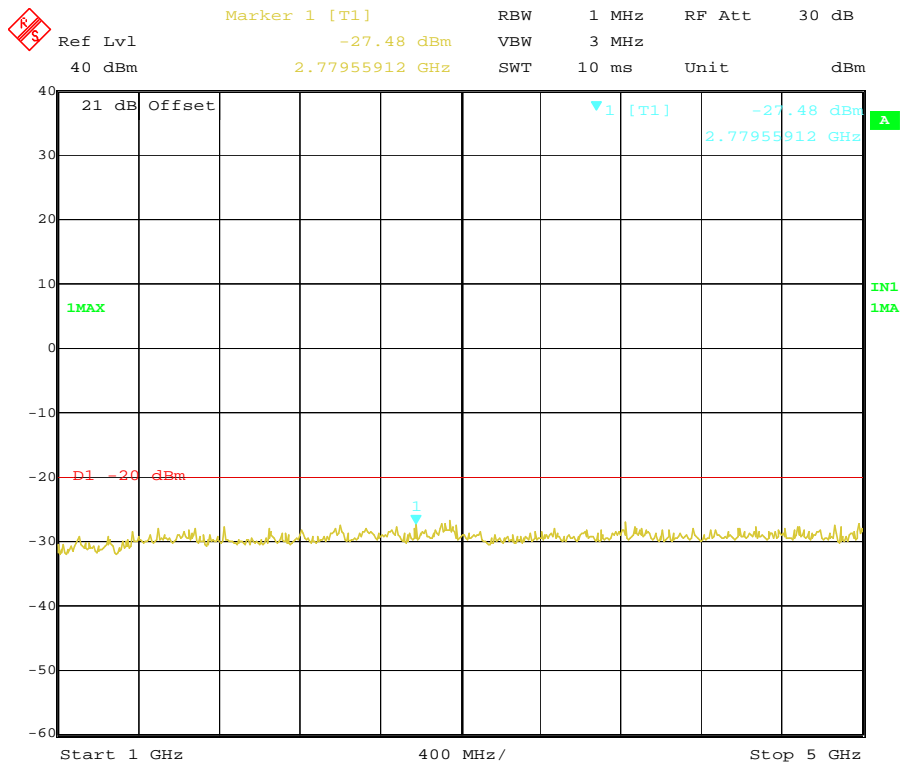
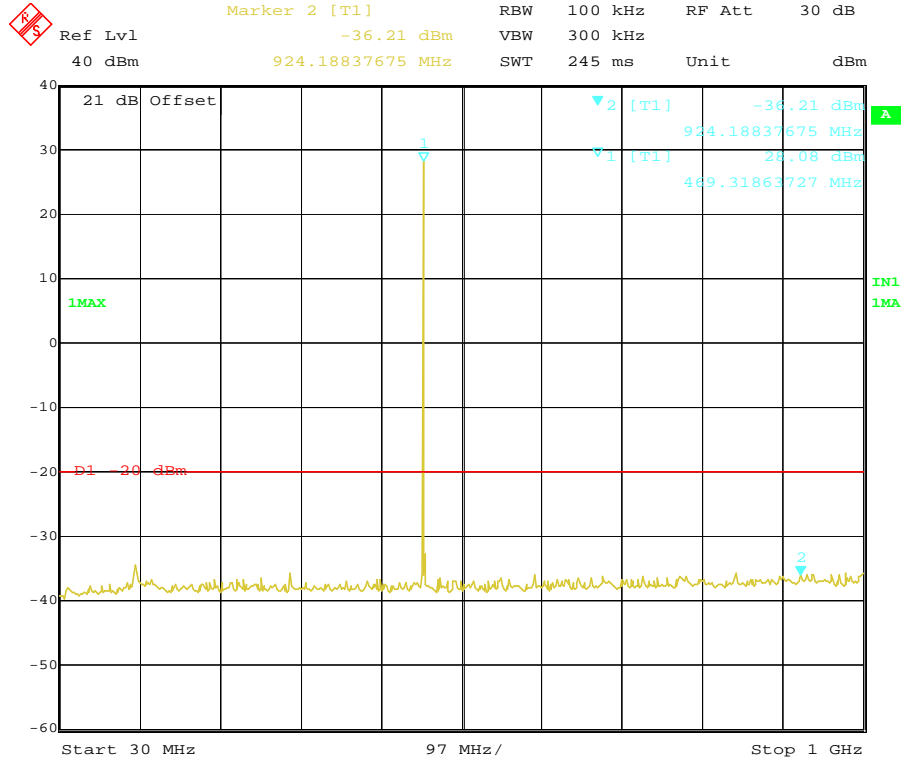

### 4.5. Modulation Characteristics

#### TEST APPLICABLE

According to CFR47 section 2.1047(a), for Voice Modulation Communication Equipment, the frequency response of the audio modulation circuit over a range of 100 to 5000Hz shall be measured.

#### TEST PROCEDURE

##### Modulation Limit

- 1 Configure the EUT as shown in figure 1, adjust the audio input for 60% of rated system deviation at 1 KHz using this level as a reference (0dB) and vary the input level from -20 to +20dB. Record the frequency deviation obtained as a function of the input level.
- 2 Repeat step 1 with input frequency changing to 300, 1004, 1500 and 2500Hz in sequence.

##### Audio Frequency Response

- 1 Configure the EUT as shown in figure 1.
- 2 Adjust the audio input for 20% of rated system deviation at 1 KHz using this level as a reference (0dB).
- 3 Vary the Audio frequency from 100 Hz to 3 KHz and record the frequency deviation.
- 4 Audio Frequency Response =  $20 \log_{10} (\text{Deviation of test frequency} / \text{Deviation of 1 KHz reference})$ .

#### TEST CONFIGURATION

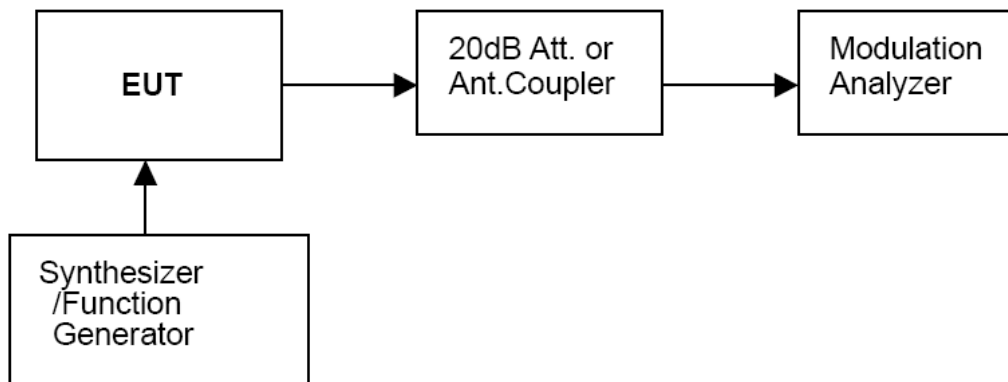

#### TEST RESULTS

##### Modulation Type: FM

##### 12.5 KHz Channel Separation

Modulation Level(dB)	Peak Freq. Deviation At 300 Hz(KHz)	Peak Freq. Deviation At 1004 H(KHz)	Peak Freq. Deviation At 1500 Hz(KHz)	Peak Freq. Deviation At 2500 Hz(KHz)
-20	0.05	0.17	0.25	0.37
-15	0.07	0.29	0.41	0.65
-10	0.10	0.50	0.73	1.14
-5	0.14	0.85	1.26	1.96
0	0.24	1.46	2.07	2.26
+5	0.40	2.20	2.32	2.33
+10	0.39	2.12	2.23	2.33
+15	0.32	2.02	2.26	2.32
+20	0.31	1.86	2.21	2.30

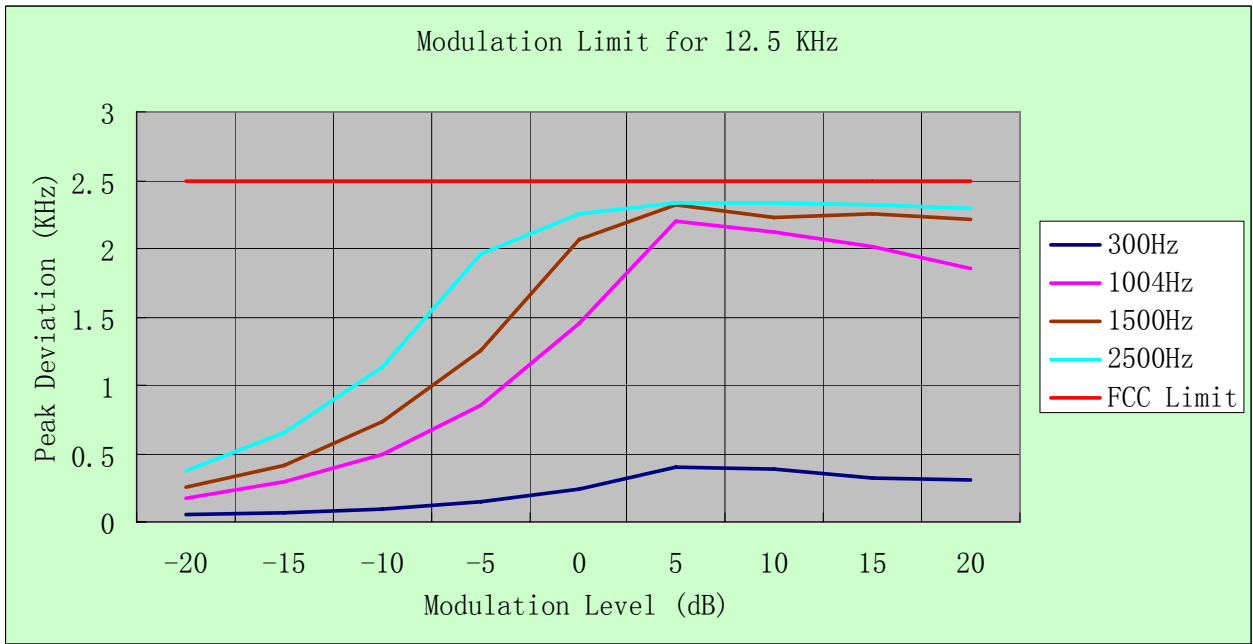

**b). Audio Frequency Response:**

**Rule Part No.: Part 2.1407(a) (b)**

**Method of Measurement:**

The audio frequency response was measured in accordance with TIA/EIA Specification 603 with no exception. A curve or equivalent data showing the frequency response of the audio modulating circuit over a range of 300-3000Hz shall be submitted and Audio Post Limiter Low Pass Filter Response from 3.0 KHz to 50KHz. However, the audio frequency response should test from 100Hz to 5.0 KHz according to FCC Part 90.

**Modulation Type: FM**

The audio frequency response curve is show below.and

**Test Audio Level (1 KHz and 20% maximum deviation) is 4.10mv for 12.5 KHz channel separation.**

**Note:**

- 1 Not applicable to new standard. However, tests are conducted under FCC's recommendation.
- 2 The Audio Frequency Response is identical for 12.5 KHz channel separation



**12.5 KHz Channel Separation**

Frequency (KHz)	Frequency Deviation (KHz)	1KHz Reference Deviation (KHz)	Audio Frequency Response (dB)
0.1	0.05	0.5	-20.00
0.2	0.05	0.5	-20.00
0.3	0.11	0.5	-13.15
0.4	0.15	0.5	-10.46
0.5	0.2	0.5	-7.96
0.6	0.27	0.5	-5.35
0.7	0.29	0.5	-4.73
0.8	0.33	0.5	-3.61
0.9	0.39	0.5	-2.16
1.0	0.45	0.5	-0.92
1.2	0.51	0.5	0.17
1.4	0.63	0.5	2.01
1.6	0.72	0.5	3.17
1.8	0.89	0.5	5.01
2.0	0.99	0.5	5.93
2.2	1.03	0.5	6.28
2.4	1.12	0.5	7.00
2.6	1.19	0.5	7.53
2.7	1.2	0.5	7.60
2.8	1.21	0.5	7.68
3.0	1.16	0.5	7.31
3.5	0.07	0.5	-17.08
4.0	0.05	0.5	-20.00
4.5	0.05	0.5	-20.00
5.0	0.05	0.5	-20.00

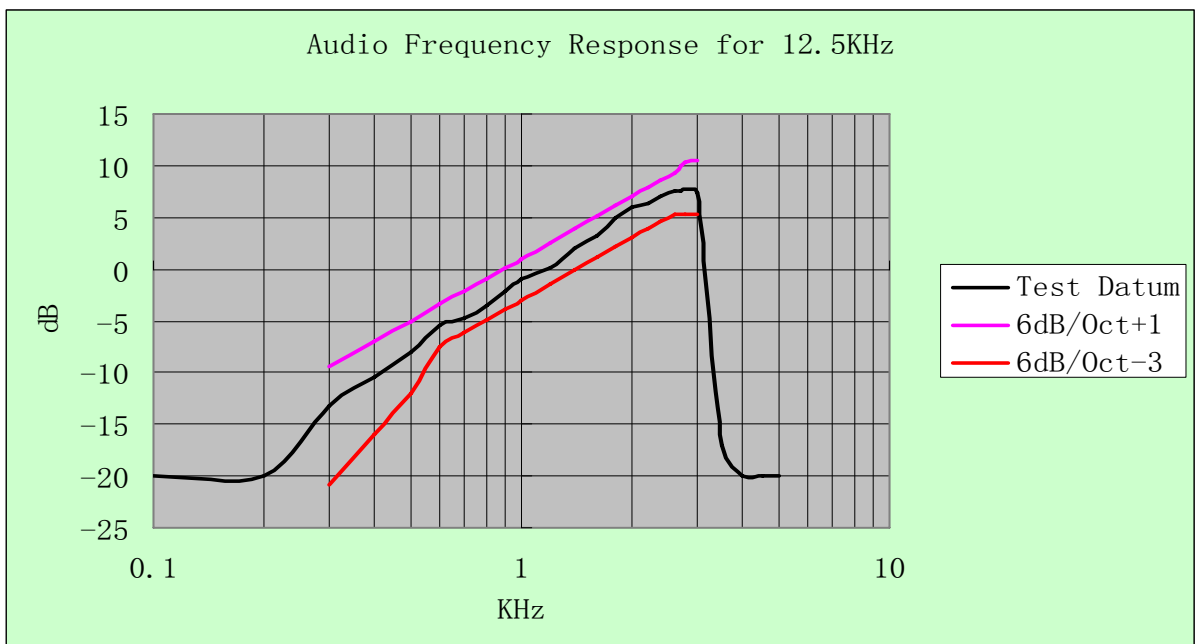

### 4.6. Frequency Stability Test

#### TEST APPLICABLE

- 1 According to FCC Part 2 Section 2.1055 (a)(1), the frequency stability shall be measured with variation of ambient temperature from -30°C to +60°C centigrade.
- 2 According to FCC Part 2 Section 2.1055 (a) (2), for battery powered equipment, the frequency stability shall be measured with reducing primary supply voltage to the battery operating end point, which is specified by the manufacture.
- 3 Vary primary supply voltage from 85 to 115 percent of the nominal value for other than hand carried battery equipment.
- 4 According to §90.213, the frequency stability limit is 2.5 ppm for 12.5 KHz channel separation.

#### TEST PROCEDURE

The EUT was set in the climate chamber and connected to an external DC power supply. The RF output was directly connected to Spectrum Analyzer ESI 26. The coupling loss of the additional cables was recorded and taken in account for all the measurements. After temperature stabilization (approx. 20 min for each stage), the frequency for the lower, the middle and the highest frequency range was recorded. For Frequency stability Vs. Voltage the EUT was connected to a DC power supply and the voltage was adjusted in the required ranges. The result was recorded.

#### TEST CONFIGURATION

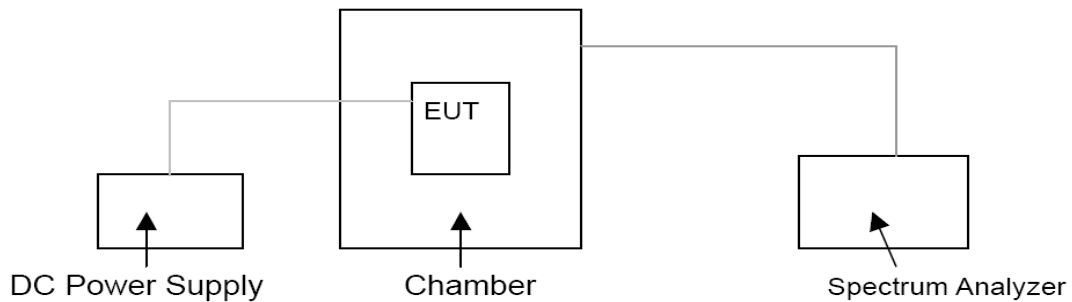

#### TEST LIMITS

According to 90.213, Transmitters used must have minimum frequency stability as specified in the following table.

Frequency Range (MHz)	Channel Bandwidth (KHz)	Frequency Tolerance (ppm)		
		Fixed and Base Stations	Mobile Stations	
			> 2 W	≤ 2 W
150-174 MHz	6.25	1.0	2.0	2.0
	12.5	2.5	5.0	5.0
	25	5.0	5.0	50.0*
421-512 MHz	6.25	0.5	1.0	1.0
	12.5	1.5	2.5	2.5
	25	2.5	5.0	5.0

- Stations operating in the 154.45 to 154.49 MHz or the 173.2 to 173.4 MHz bands must have a frequency stability of 5 ppm.
- Paging transmitters operating on paging-only frequencies must operate with frequency stability of 5 ppm in the 150-174 MHz band and 2.5 ppm in the 421-512 MHz band.

**TEST RESULTS**

Modulation Type	Channel Separation	Test conditions		Frequency error (ppm)				
		Voltage(V)	Temp(°C)	400.5	418.0	435.5	453.0	469.5
Analog/FM	12.5KHz	7.40	-30	1.01	1.26	1.32	1.23	1.26
			-20	1.11	1.13	1.42	1.11	1.12
			-10	1.08	1.04	1.18	1.08	0.91
			0	0.90	0.94	1.00	0.69	0.85
			10	0.71	0.73	0.82	0.66	0.77
			20	0.73	0.78	0.73	0.70	0.74
			30	0.72	0.76	0.75	0.62	0.75
			40	0.81	0.90	0.96	0.80	0.86
			50	1.05	1.08	1.12	1.03	1.07
		6.67 (End point)	20	1.15	1.20	1.41	1.35	1.17
		6.29 (85% Rated)	20	0.77	0.72	0.79	0.66	0.68
		8.51 (115% Rated)	20	1.16	1.21	1.33	1.11	1.10
Limit			2.5 ppm					
Conclusion			Complies					

### 4.7. Maximum Transmitter Power

#### TEST APPLICABLE

Per FCC «2.1046 and «90.205: Maximum ERP is dependent upon the station’s antenna HAAT and required service area.

#### TEST PROCEDURE

Measurements shall be made to establish the radio frequency power delivered by the transmitter the standard output termination. The power output shall be monitored and recorded and no adjustment shall be made to the transmitter after the test has begun, except as noted bellow:

If the power output is adjustable, measurements shall be made for the highest and lowest power levels.

The EUT connect to the Receiver through 20 dB attenuator.

Measurement with Spectrum Analyzer ESI 26 conducted, external power supply with 7.40 V stabilized supply voltage.

#### TEST CONFIGURATION

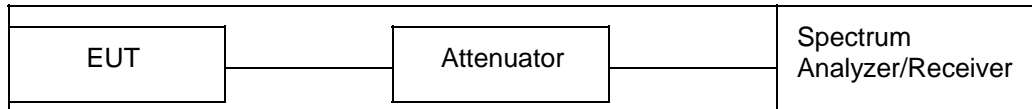

The EUT was directly connected to a RF Communication Test set by a 20 dB attenuator

#### TEST RESULTS

Modulation Type	Channel Separation	Test Channel	Test Frequency	Maximum Transmitter Power at Rated High Power Level(dBm)	Maximum Transmitter Power at Rated Low Power Level(dBm)
Analog/FM	12.5KHz	Low Channel	400.5000 MHz	36.84	28.27
		Low Channel	418.0000 MHz	37.02	27.95
		Middle Channel	435.5000 MHz	37.10	28.27
		High Channel	453.0000 MHz	36.89	28.48
		High Channel	469.5000 MHz	37.02	28.01
Limit	The limit is dependent upon the station’s antenna HAAT and required service area.				
Test Results	Complicance				

#### Plots of Maximum Transmitter Power Measurement

Modulation Type	Channel Separation	Freq.(MHz)	Rated Power (Watt)	Measurement (dBm)	FCC Limit	Results
FM	12.5 KHz	400.5000	4	36.84	Varies	Complicance

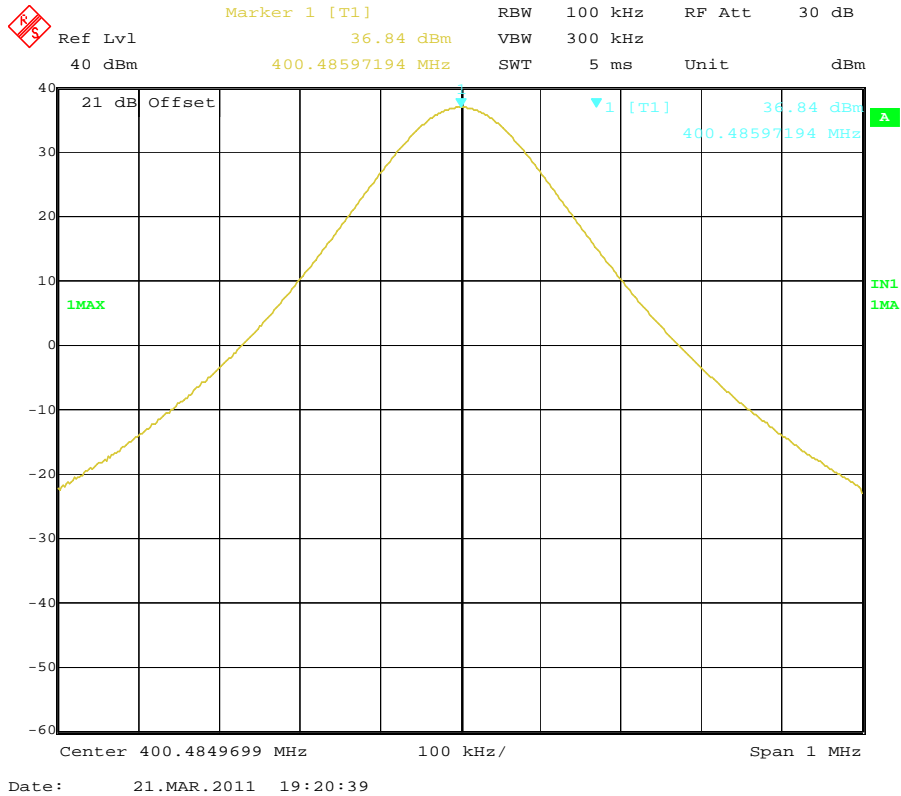

Modulation Type	Channel Separation	Freq.(MHz)	Rated Power (Watt)	Measurement (dBm)	FCC Limit	Results
FM	12.5 KHz	418.0000	4	37.02	Varies	Complicance

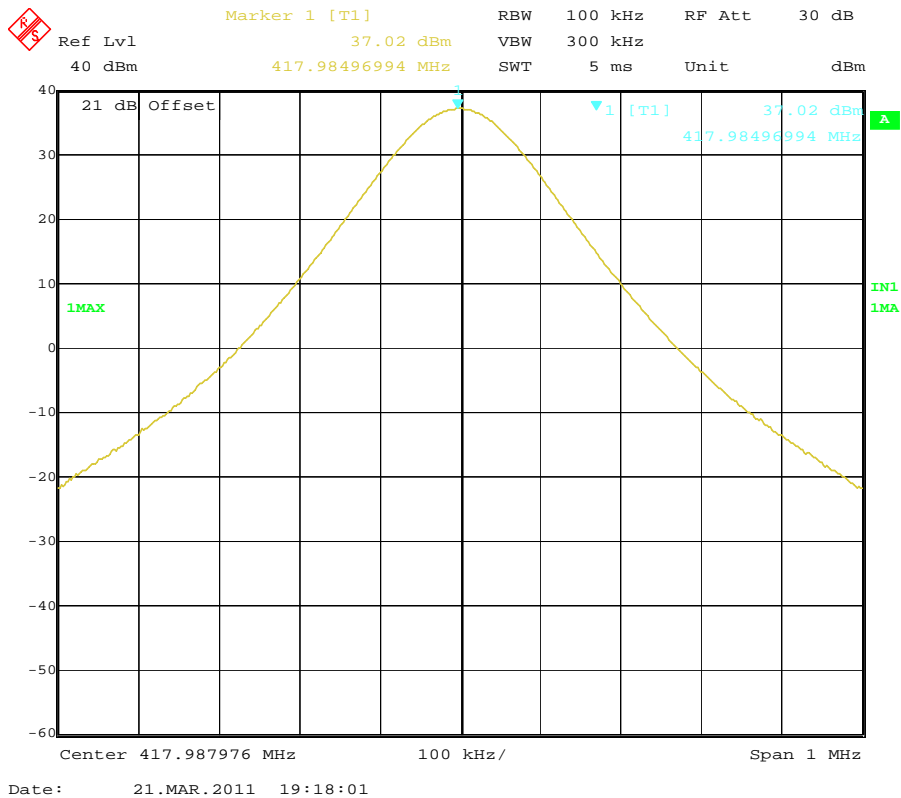

Modulation Type	Channel Separation	Freq.(MHz)	Rated Power (Watt)	Measurement (dBm)	FCC Limit	Results
FM	12.5 KHz	435.5000	4	37.10	Varies	Complicance

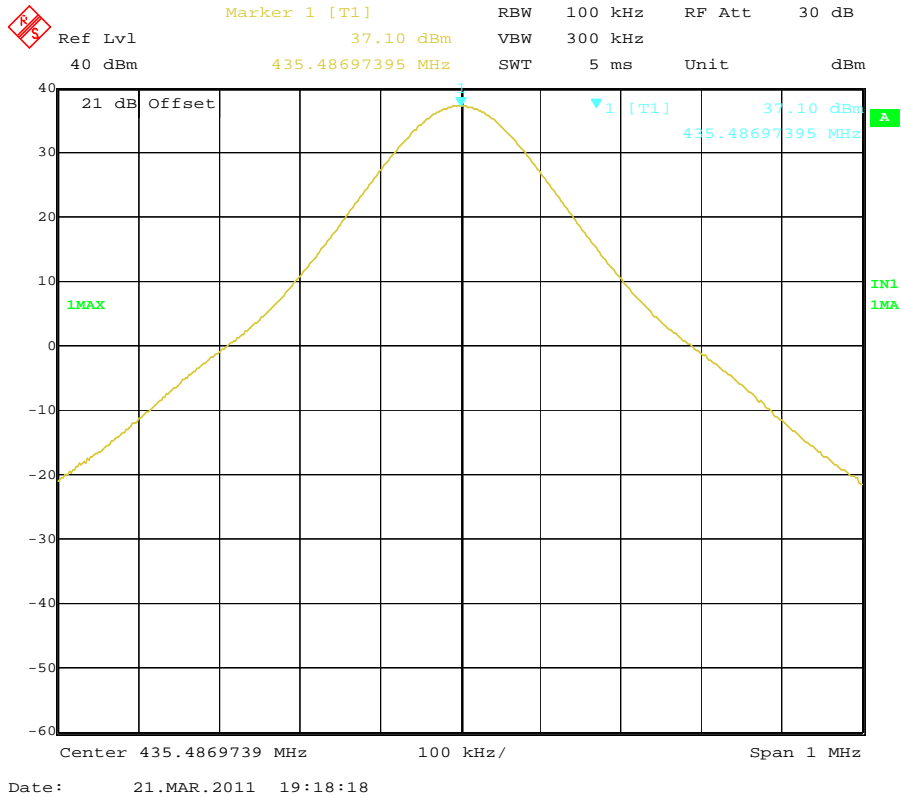

Modulation Type	Channel Separation	Freq.(MHz)	Rated Power (Watt)	Measurement (dBm)	FCC Limit	Results
FM	12.5 KHz	453.0000	4	36.89	Varies	Complicance

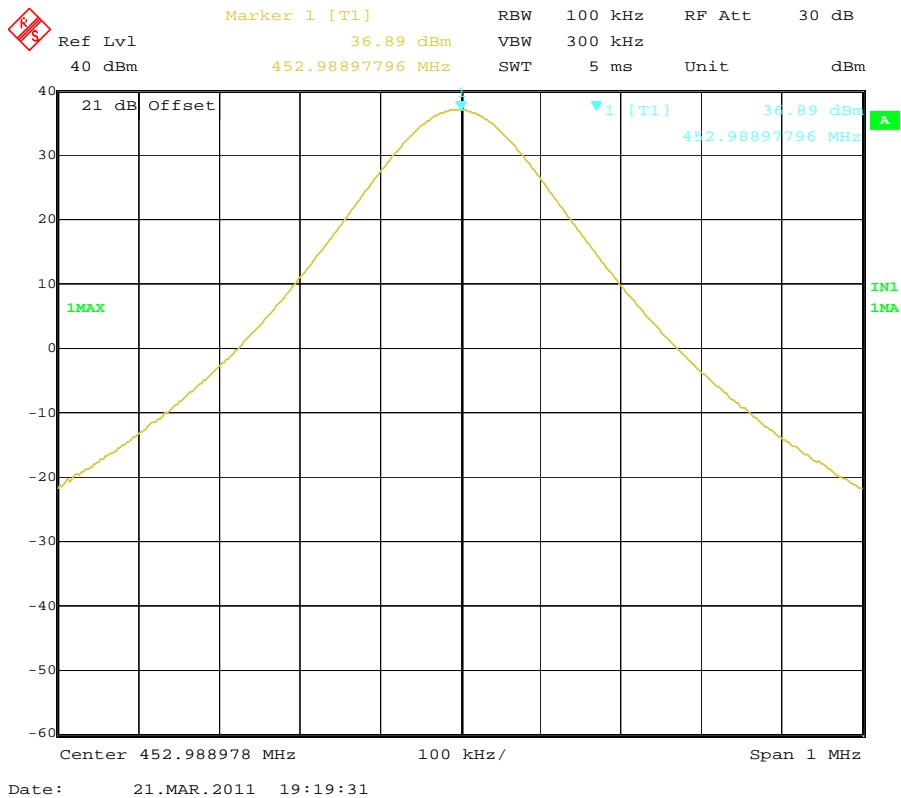

Modulation Type	Channel Separation	Freq.(MHz)	Rated Power (Watt)	Measurement (dBm)	FCC Limit	Results
FM	12.5 KHz	469.5000	4	37.02	Varies	Complicance

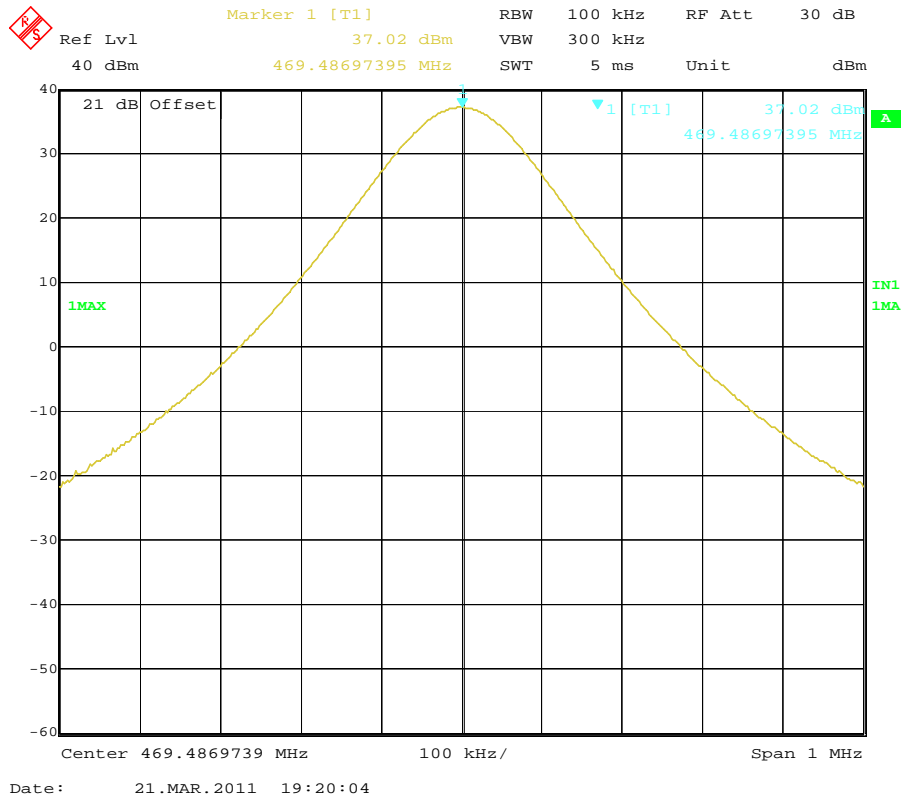

Modulation Type	Channel Separation	Freq.(MHz)	Rated Power (Watt)	Measurement (dBm)	FCC Limit	Results
FM	12.5 KHz	400.5000	0.5	28.27	Varies	Complicance

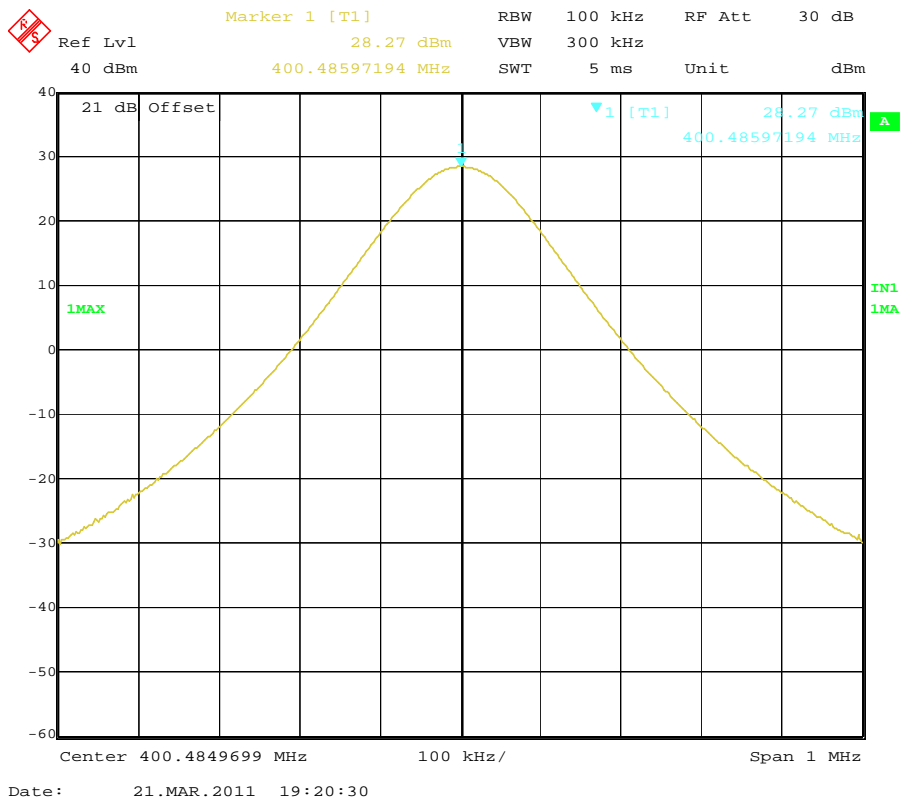

Modulation Type	Channel Separation	Freq.(MHz)	Rated Power (Watt)	Measurement (dBm)	FCC Limit	Results
FM	12.5 KHz	418.0000	0.5	27.95	Varies	Complicance

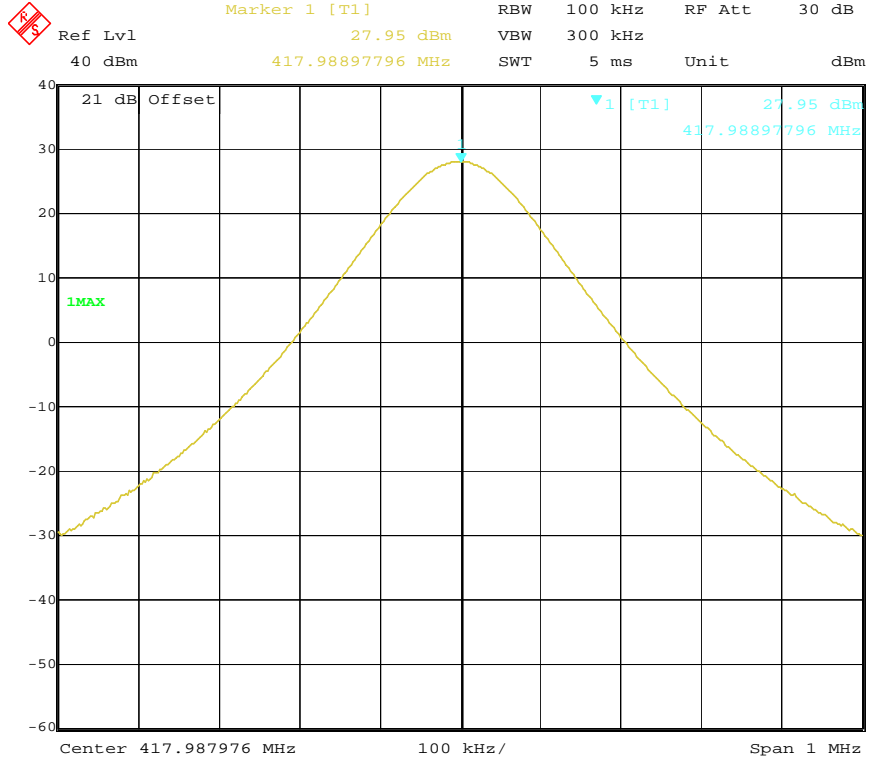

Date: 21.MAR.2011 19:17:50

Modulation Type	Channel Separation	Freq.(MHz)	Rated Power (Watt)	Measurement (dBm)	FCC Limit	Results
FM	12.5 KHz	435.5000	0.5	28.27	Varies	Complicance

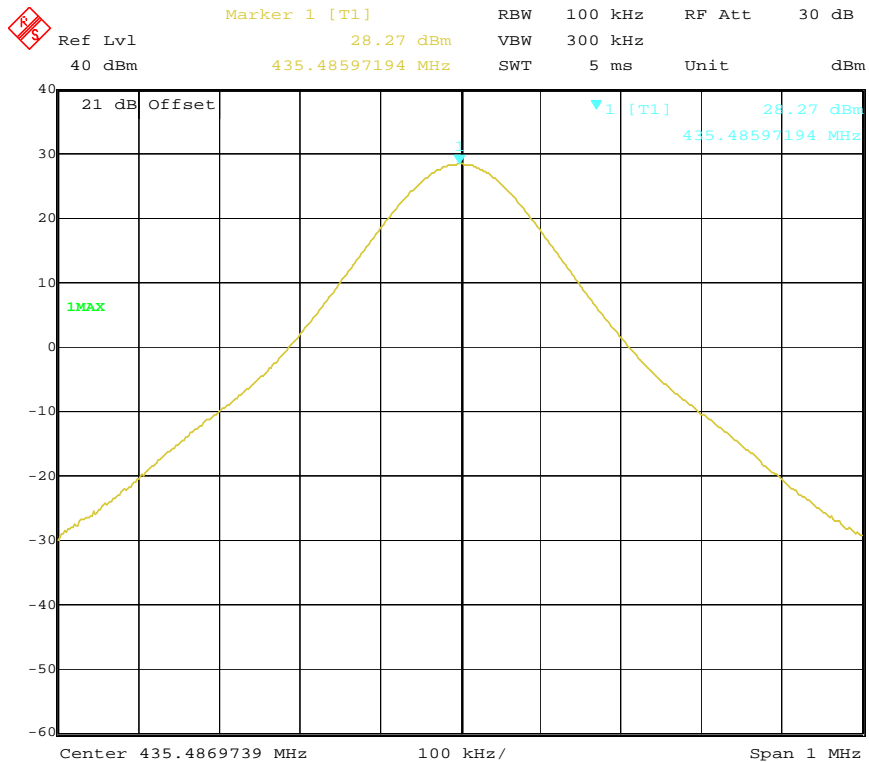

Date: 21.MAR.2011 19:18:38



Modulation Type	Channel Separation	Freq.(MHz)	Rated Power (Watt)	Measurement (dBm)	FCC Limit	Results
FM	12.5 KHz	453.0000	0.5	28.48	Varies	Complicance

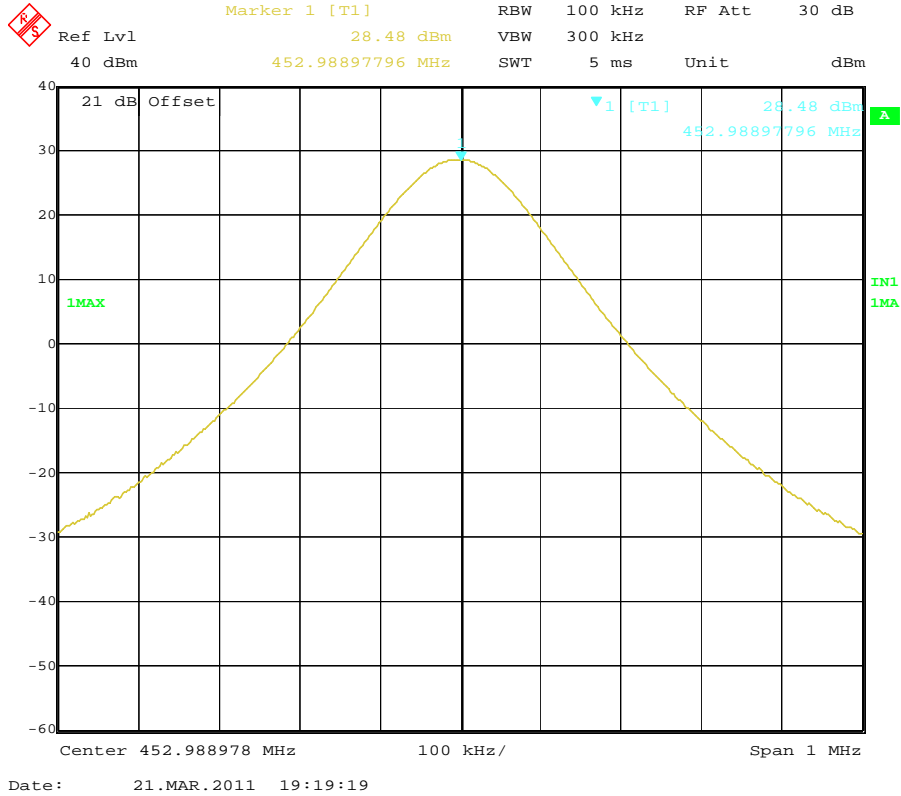

Modulation Type	Channel Separation	Freq.(MHz)	Rated Power (Watt)	Measurement (dBm)	FCC Limit	Results
FM	12.5 KHz	469.5000	0.5	28.01	Varies	Complicance

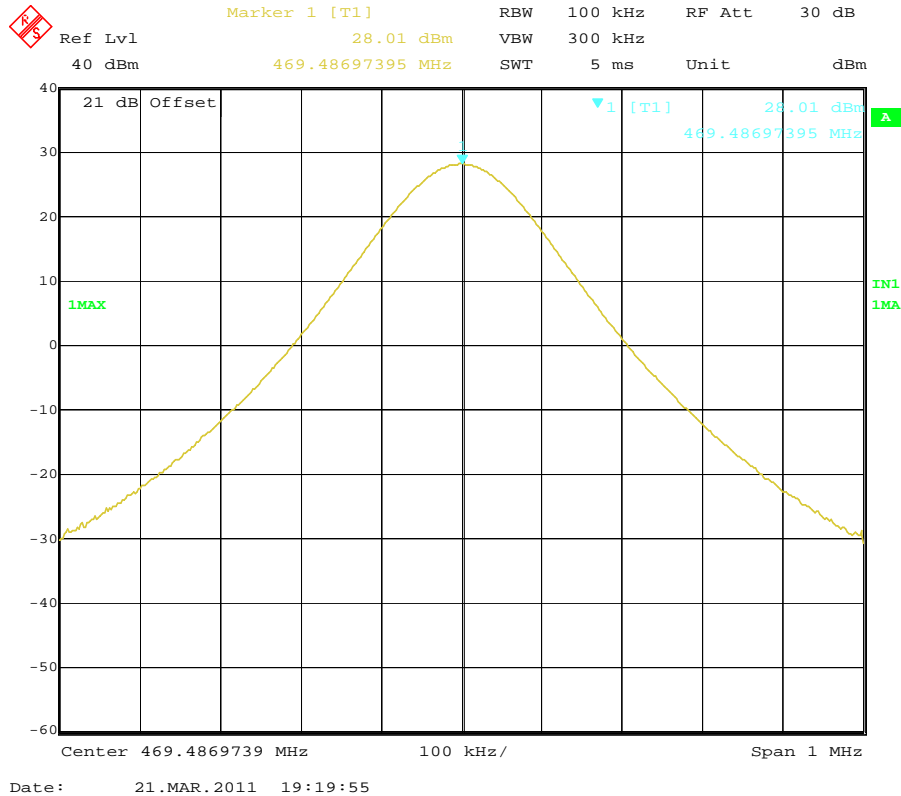

### 4.8. Transmitter Frequency Behavior

#### TEST APPLICABLE

Section 90.214

Transient frequencies must be within the maximum frequency difference limits during the time intervals indicated:

Time intervals <sup>1, 2</sup>	Maximum frequency difference <sup>3</sup>	All equipment	
		150 to 174 MHz	421 to 512MHz
Transient Frequency Behavior for Equipment Designed to Operate on 25 KHz Channels			
$t_1$ <sup>4</sup> .....	± 25.0 KHz	5.0 ms	10.0 ms
$t_2$ .....	± 12.5 KHz	20.0 ms	25.0 ms
$t_3$ <sup>4</sup> .....	± 25.0 KHz	5.0 ms	10.0 ms
Transient Frequency Behavior for Equipment Designed to Operate on 12.5 KHz Channels			
$t_1$ <sup>4</sup> .....	± 12.5 KHz	5.0 ms	10.0 ms
$t_2$ .....	± 6.25 KHz	20.0 ms	25.0 ms
$t_3$ <sup>4</sup> .....	± 12.5 KHz	5.0 ms	10.0 ms
Transient Frequency Behavior for Equipment Designed to Operate on 6.25 KHz Channels			
$t_1$ <sup>4</sup> .....	±6.25 KHz	5.0 ms	10.0 ms
$t_2$ .....	±3.125 KHz	20.0 ms	25.0 ms
$t_3$ <sup>4</sup> .....	±6.25 KHz	5.0 ms	10.0 ms

- $t_{on}$  is the instant when a 1 KHz test signal is completely suppressed, including any capture time due to phasing.  
 $t_1$  is the time period immediately following  $t_{on}$ .  
 $t_2$  is the time period immediately following  $t_1$ .  
 $t_3$  is the time period from the instant when the transmitter is turned off until  $t_{off}$ .  
 $t_{off}$  is the instant when the 1 KHz test signal starts to rise.
- During the time from the end of  $t_2$  to the beginning of  $t_3$ , the frequency difference must not exceed the limits specified in § 90.213.
- Difference between the actual transmitter frequency and the assigned transmitter frequency.
- If the transmitter carrier output power rating is 6 watts or less, the frequency difference during this time period may exceed the maximum frequency difference for this time period.

#### TEST PROCEDURE

TIA/EIA-603 2.2.19

#### TEST CONFIGURATION

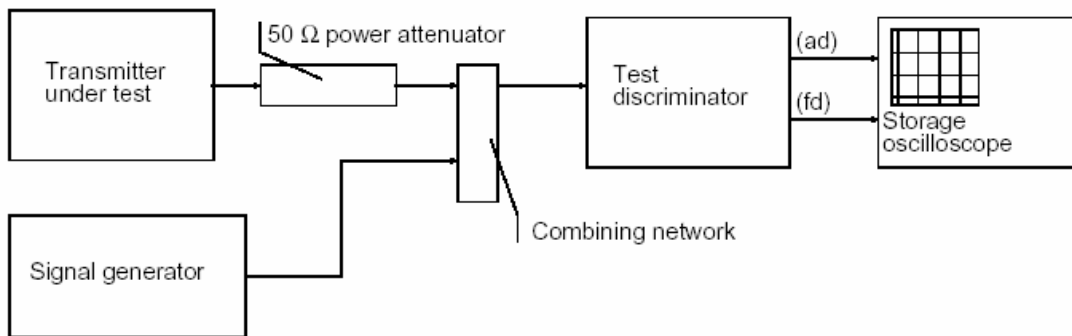

#### TEST RESULTS

Please refer to the following plots.

Modulation Type: FM

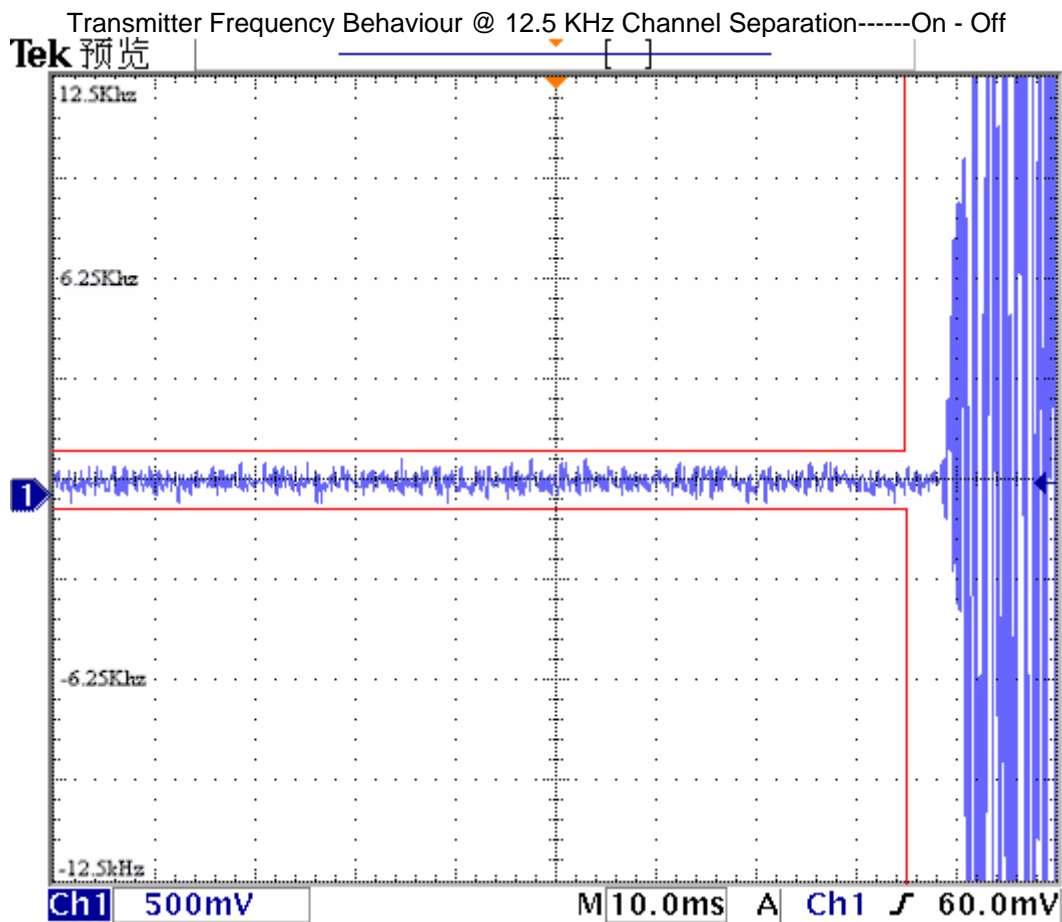
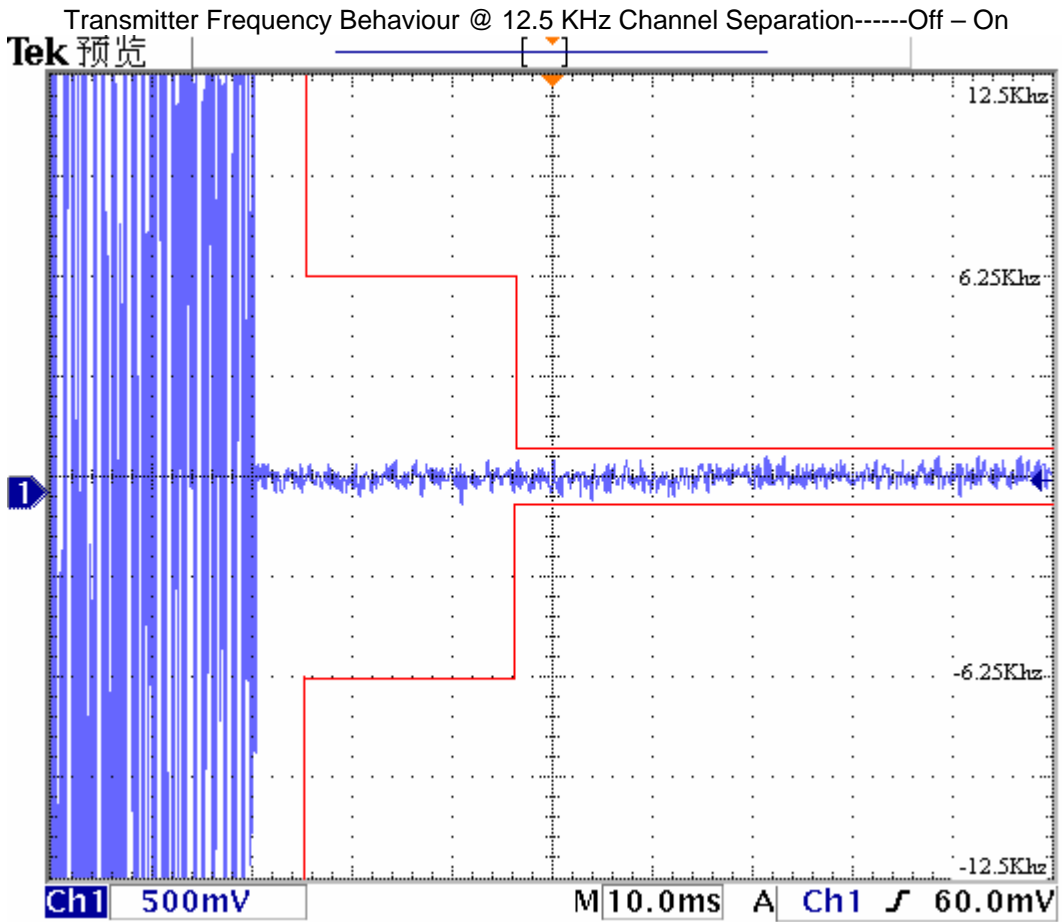

### 4.9. Receiver Radiated Spurious Emission

#### TEST APPLICABLE

The field strength is calculated by adding the Antenna Factor and Cable Factor and subtracting the Amplifier Gain and Duty Cycle Correction Factor (if any) from the measured reading. The basic equation with a sample calculation is as follows:

$$FS = RA + AF + CL - AG$$

Where FS = Field Strength	CL = Cable Attenuation Factor (Cable Loss)
RA = Reading Amplitude	AG = Amplifier Gain
AF = Antenna Factor	

#### TEST CONFIGURATION

(A) Radiated Emission Test Set-Up, Frequency below 1000MHz

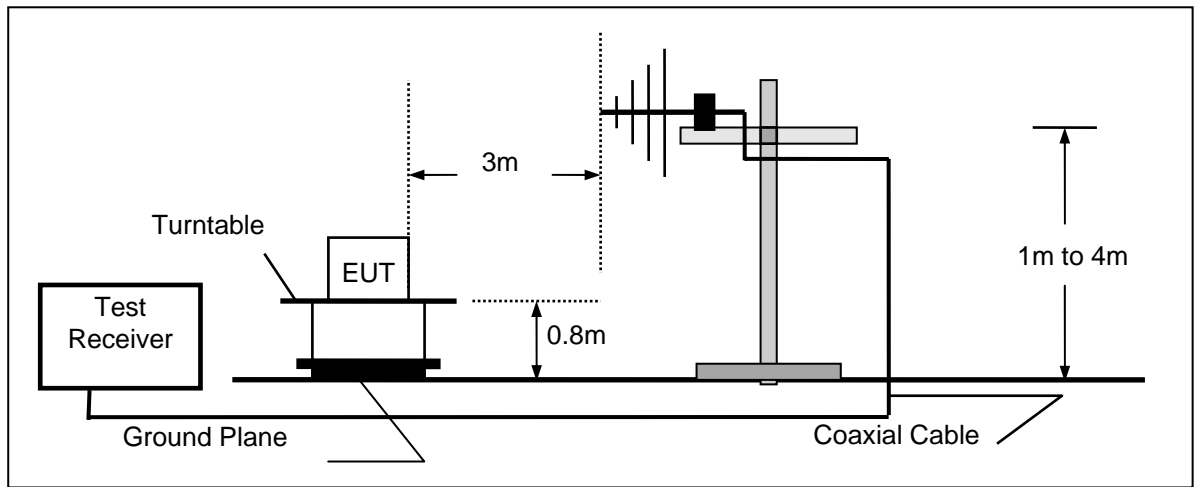

(B) Radiated Emission Test Set-Up, Frequency above 1000MHz

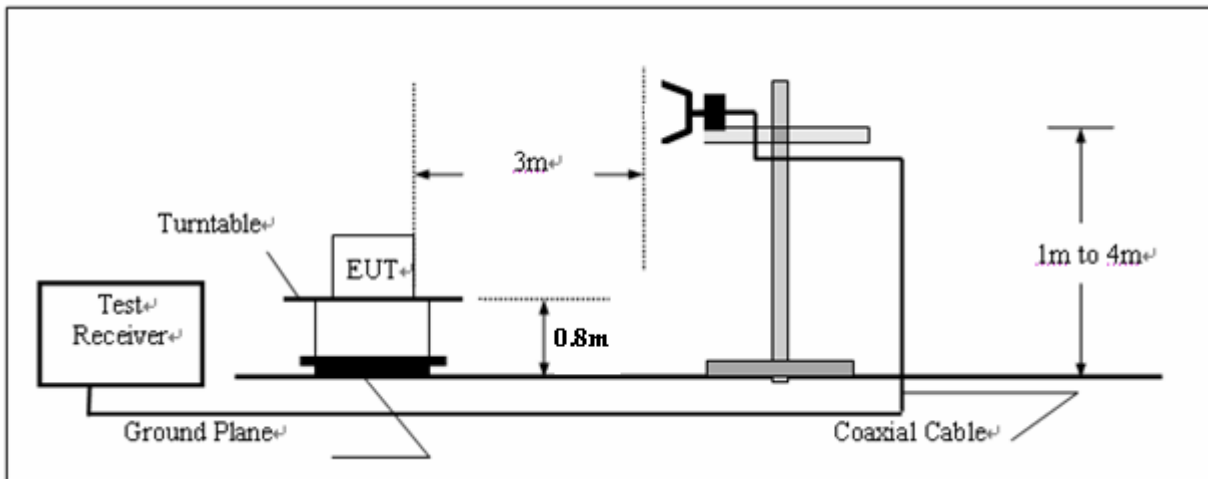

#### TEST PROCEDURE

- 1 The EUT was placed on a turn table which is 0.8m above ground plane.
- 2 Maximum procedure was performed by raising the receiving antenna from 1m to 4m and rotating the turn table from 0° to 360° to acquire the highest emissions from EUT
- 3 And also, each emission was to be maximized by changing the polarization of receiving antenna both horizontal and vertical.
- 4 Repeat above procedures until all frequency measurements have been completed.

**RECEIVER RADIATED SPOUIOUS LIMIT**

For unintentional device, according to § 15.109(a) and RSS-Gen, except for Class A digital devices, the field strength of radiated emissions from unintentional radiators at a distance of 3 meters shall not exceed the following values:

Frequency (MHz)	Distance (Meters)	Radiated (dB $\mu$ V/m)	Radiated ( $\mu$ V/m)
30-88	3	40.0	100
88-216	3	43.5	150
216-960	3	46.0	200
Above 960	3	54.0	500

For intentional device, according to § 15.209(a), the general requirement of field strength of radiated emissions from intentional radiators at a distance of 3 meters shall not exceed the above table.

**TEST RESULTS**

The Radiated Measurement are performed to the five channels (the top channel, the middle channel and the bottom channel), the datum recorded below is the worst case for each channel separation; and the EUT shall be scanned from 30 MHz to the 5th harmonic of the highest oscillator frequency in the digital devices or 1 GHz whichever is higher.

Modulation Type	Channel Separation	Test Frequency (MHz)	Polar.	Maximum Radiated Emissions		FCC Limit (dBuV/m)
				Frequency (MHz)	Datum (dBuV/m)	
FM	12.5 KHz	400.5000	H	939.74	28.40	46.00
			V	41.66	25.20	40.00
Test Results			Compliance			

**SWEEP TABLE: "test (30M-1G)"**

Short Description: Field Strength  
 Start Stop Detector Meas. IF Transducer  
 Frequency Frequency Time Bandw.  
 30.0 MHz 1.0 GHz MaxPeak Coupled 120 kHz HL562 2011

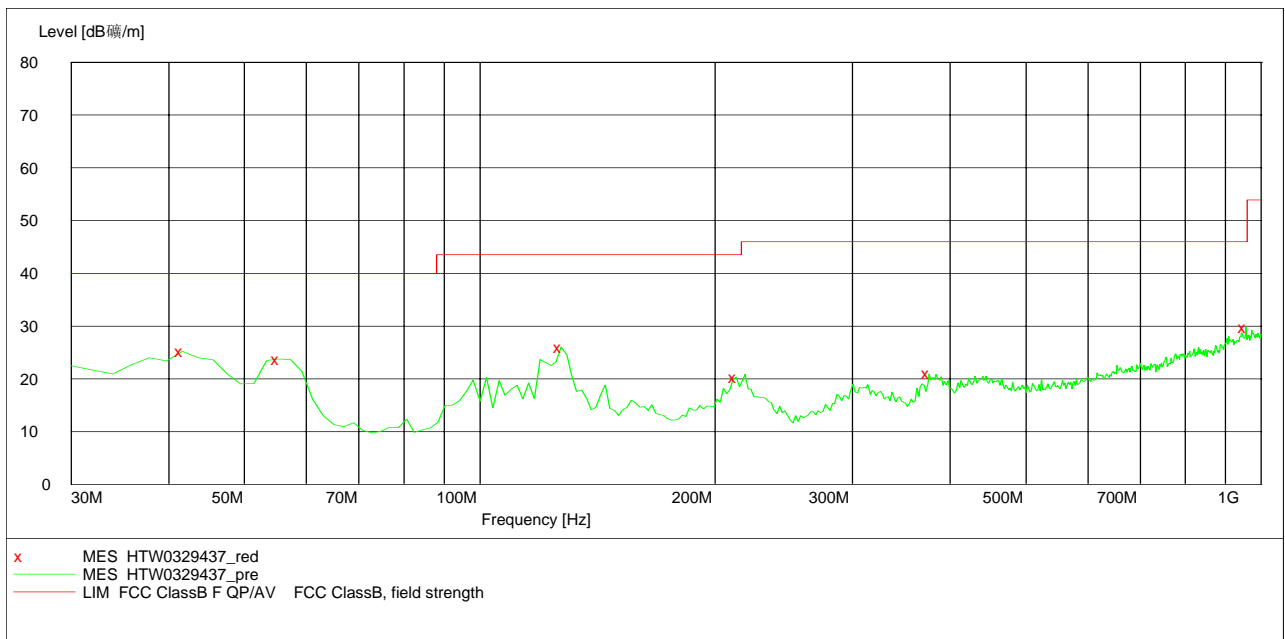

**MEASUREMENT RESULT: "HTW0329437\_red"**

3/30/2011 2:11AM

Frequency MHz	Level dBμV/m	Transd dB	Limit dBμV/m	Margin dB	Det.	Height cm	Azimuth deg	Polarization
41.663327	25.20	-16.9	40.0	14.8	Peak	100.0	239.00	VERTICAL
55.270541	23.70	-23.6	40.0	16.3	Peak	100.0	80.00	VERTICAL
127.194389	26.00	-18.9	43.5	17.5	Peak	100.0	140.00	VERTICAL
212.725451	20.30	-21.1	43.5	23.2	Peak	100.0	229.00	VERTICAL
376.012024	21.00	-15.9	46.0	25.0	Peak	100.0	294.00	VERTICAL
955.290581	29.80	-5.2	46.0	16.2	Peak	100.0	166.00	VERTICAL

**SWEEP TABLE: "test (30M-1G)"**

Short Description:		Field Strength			
Start	Stop	Detector	Meas.	IF	Transducer
Frequency	Frequency		Time	Bandw.	
30.0 MHz	1.0 GHz	MaxPeak	Coupled	120 kHz	HL562 2011

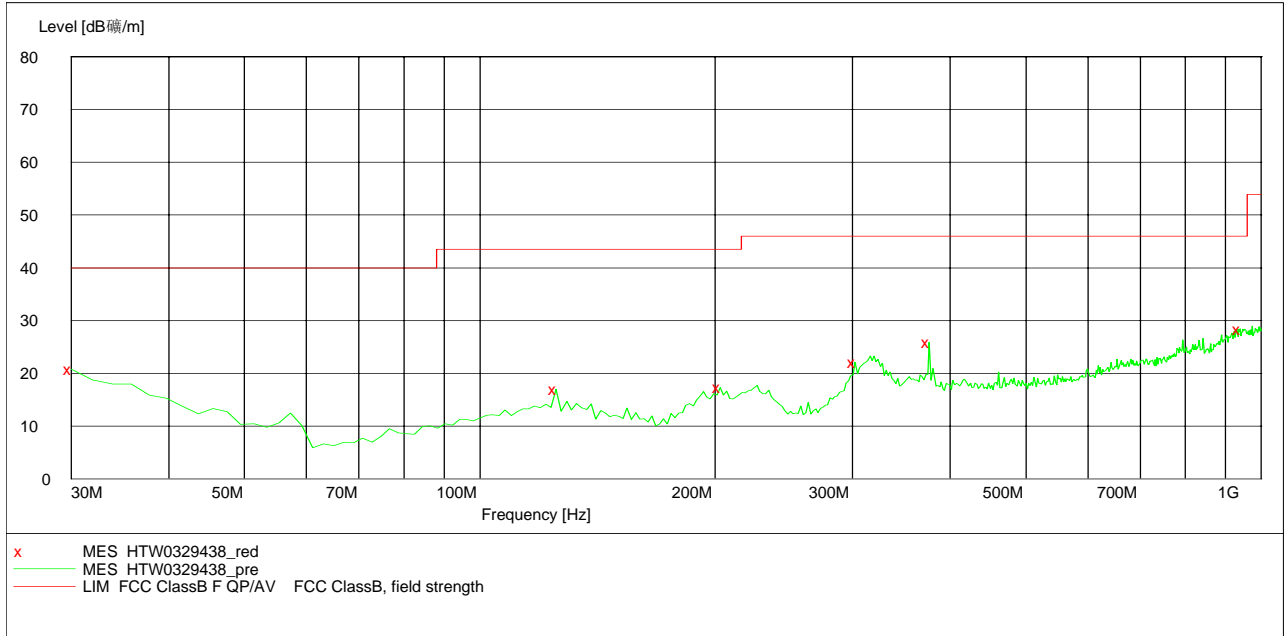

**MEASUREMENT RESULT: "HTW0329438\_red"**

3/30/2011 2:12AM

Frequency MHz	Level dBµV/m	Transd dB	Limit dBµV/m	Margin dB	Det.	Height cm	Azimuth deg	Polarization
30.000000	20.80	-10.2	40.0	19.2	Peak	100.0	234.00	HORIZONTAL
125.250501	17.00	-18.5	43.5	26.5	Peak	100.0	99.00	HORIZONTAL
203.006012	17.30	-21.4	43.5	26.2	Peak	100.0	250.00	HORIZONTAL
302.144289	22.10	-18.0	46.0	23.9	Peak	100.0	201.00	HORIZONTAL
376.012024	25.90	-15.9	46.0	20.1	Peak	100.0	116.00	HORIZONTAL
939.739479	28.40	-5.6	46.0	17.6	Peak	100.0	224.00	HORIZONTAL

Modulation Type	Channel Separation	Test Frequency (MHz)	Polar.	Maximum Radiated Emissions		FCC Limit (dBuV/m)
				Frequency (MHz)	Datum (dBuV/m)	
FM	12.5 KHz	400.5000	H	5709.42	48.60	53.90
			V	5599.20	48.00	53.90
Test Results			Compliance			

**SWEEP TABLE: "test (1G-18G) P"**

Short Description: EN 55022 Field Strength  
 Start Stop Detector Meas. IF Transducer  
 Frequency Frequency Time Bandw.  
 1.0 GHz 18.0 GHz MaxPeak Coupled 1 MHz HF906 2011

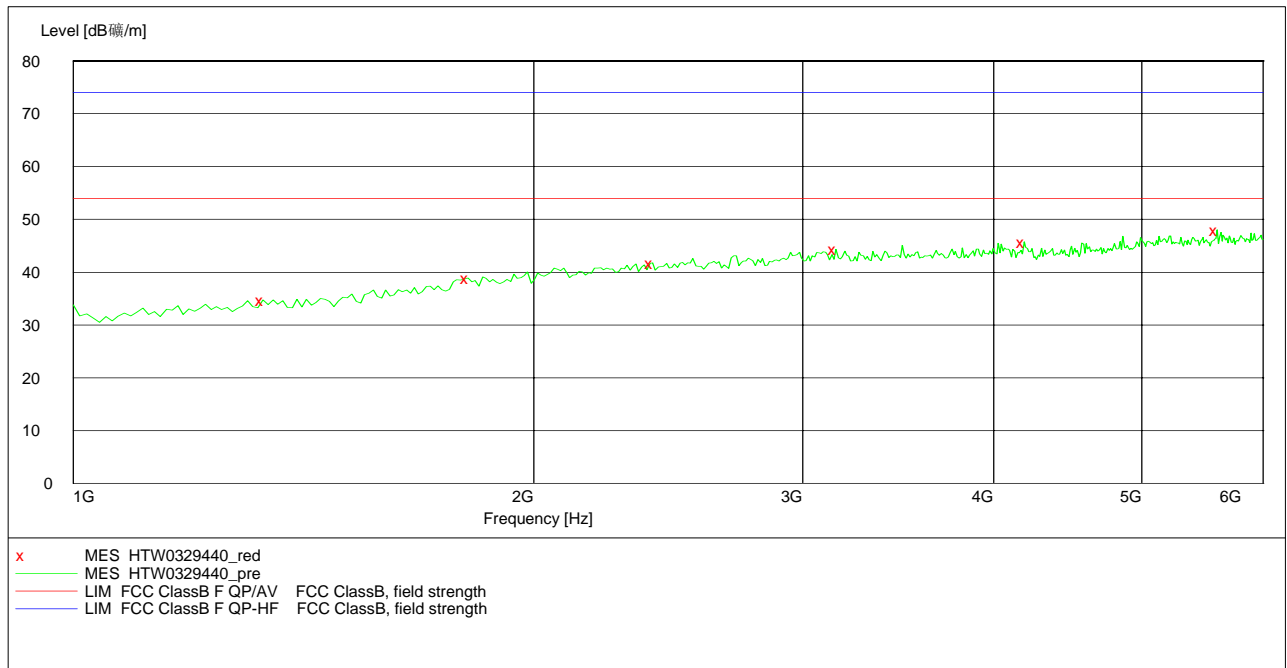

**MEASUREMENT RESULT: "HTW0329440\_red"**

3/30/2011 2:25AM

Frequency MHz	Level dBμV/m	Transd dB	Limit dBμV/m	Margin dB	Det.	Height cm	Azimuth deg	Polarization
1330.661323	34.70	-7.1	53.9	19.2	Peak	100.0	129.00	VERTICAL
1811.623246	38.90	-3.0	53.9	15.0	Peak	100.0	86.00	VERTICAL
2392.785571	41.80	0.4	53.9	12.1	Peak	100.0	42.00	VERTICAL
3154.308617	44.40	2.3	53.9	9.5	Peak	100.0	338.00	VERTICAL
4186.372745	45.70	3.5	53.9	8.2	Peak	100.0	50.00	VERTICAL
5599.198397	48.00	6.7	53.9	5.9	Peak	100.0	228.00	VERTICAL



**SWEEP TABLE: "test (1G-18G) P"**

Short Description: EN 55022 Field Strength  
 Start Stop Detector Meas. IF Transducer  
 Frequency Frequency Time Bandw.  
 1.0 GHz 18.0 GHz MaxPeak Coupled 1 MHz HF906 2011

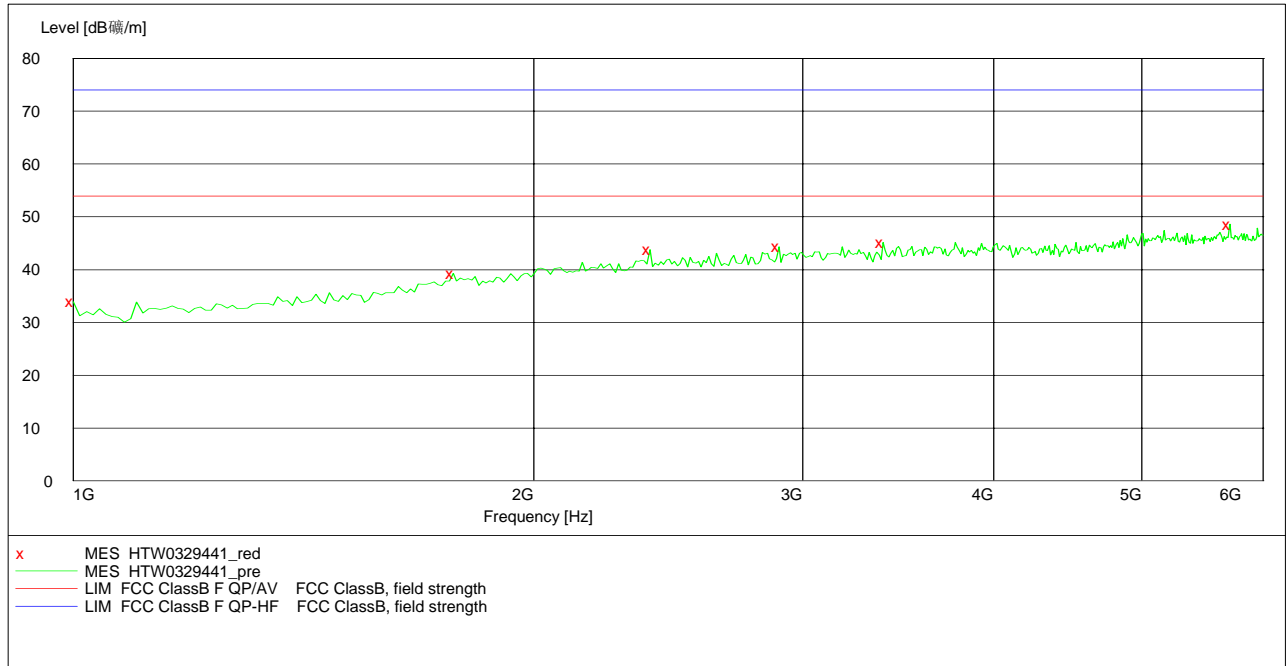

**MEASUREMENT RESULT: "HTW0329441\_red"**

3/30/2011 2:27AM

Frequency MHz	Level dBμV/m	Transd dB	Limit dBμV/m	Margin dB	Det.	Height cm	Azimuth deg	Polarization
1000.000000	33.90	-9.8	53.9	20.0	Peak	0.0	113.00	HORIZONTAL
1771.543086	39.30	-3.3	53.9	14.6	Peak	0.0	154.00	HORIZONTAL
2382.765531	43.80	0.4	53.9	10.1	Peak	0.0	119.00	HORIZONTAL
2893.787575	44.40	1.9	53.9	9.5	Peak	0.0	276.00	HORIZONTAL
3384.769539	45.10	2.5	53.9	8.8	Peak	0.0	154.00	HORIZONTAL
5709.418838	48.60	6.9	53.9	5.3	Peak	0.0	352.00	HORIZONTAL

### 4.10. Receiver Conducted Spurious Emission

#### TEST APPLICABLE

The same as Section 4.3

#### TEST PROCEDURE

The spectrum analyzer was connected to the RF output power of the EUT, the EUT was setup in receiving mode; The RBW of the spectrum analyzer was set to 100 kHz and the VBW set to 300 KHz below the test frequency 1GHz. While the RBW of the spectrum analyzer was set to the 1MHz and VBW set to the 3MHz from 1GHz to the 10<sup>th</sup> harmonic.

#### TEST CONFIGURATION

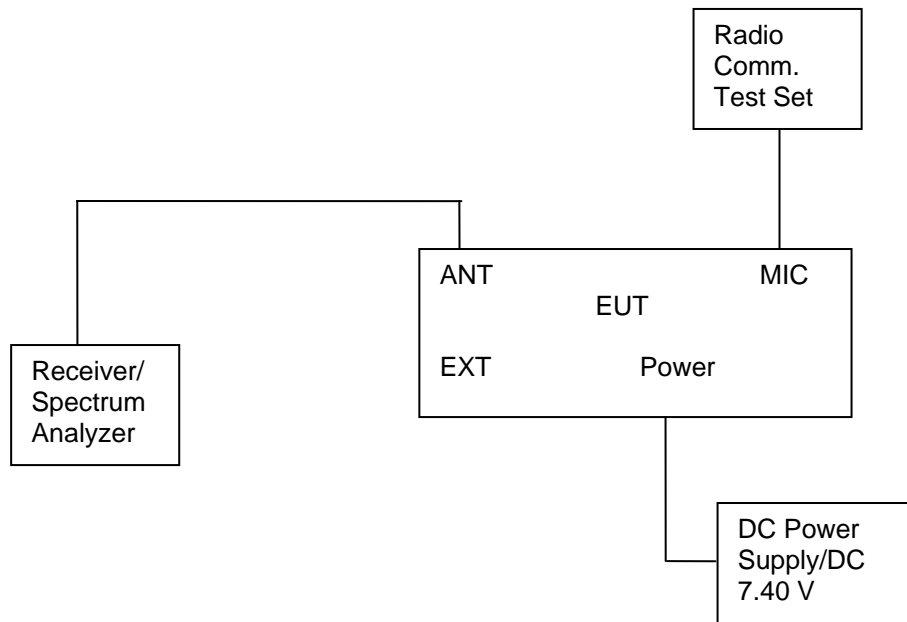

#### LIMIT

The power at the antenna terminal shall not exceed 2.0 nanowatts (-57dBm).

#### TEST RESULTS

The Receiver Conducted Spurious Emissions Measurement is performed to the five channels (the top channel, the middle channel and the bottom channel), the datums recorded below were for the three channels; and the EUT shall be scanned from 30 MHz to the 6 GHz.

Modulation Type	Channel Separation	Test Channel	Test Frequency (MHz)	Maximum Conducted Spurious Emissions Below 1GHz		Maximum Conducted Spurious Emissions Above 1GHz		FCC Limit
				Frequency (MHz)	Datum (dBm)	Frequency (MHz)	Datum (dBm)	
FM	12.5KHz	Low	400.5000	1000.00	-85.85	3204.41	-73.22	-57dBm
Test Results				Compliance				

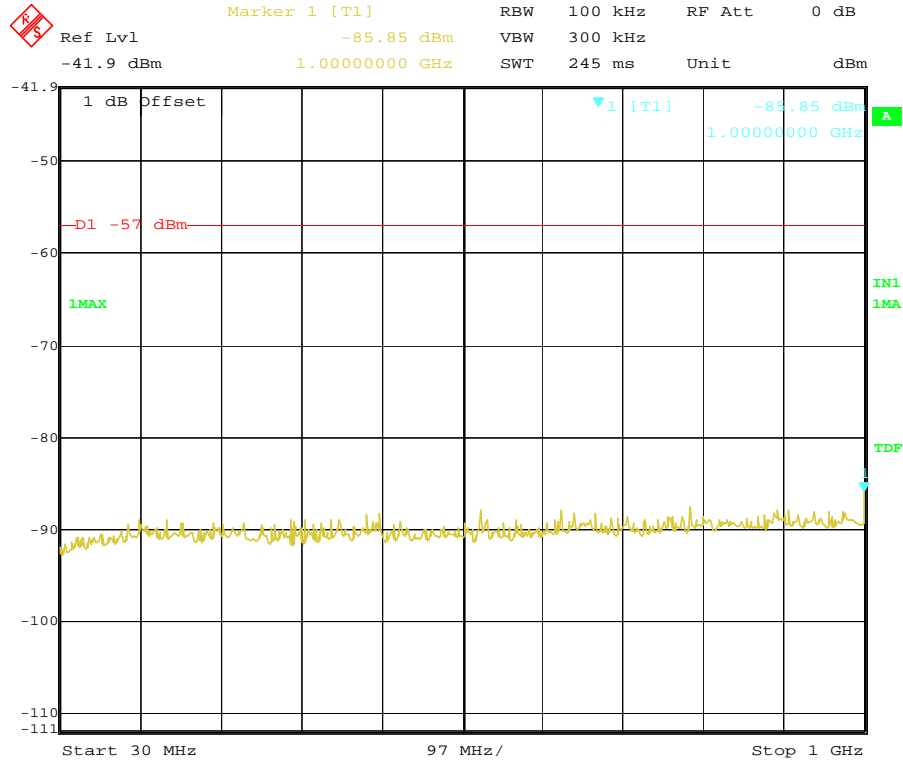

Date: 21.MAR.2011 18:52:02

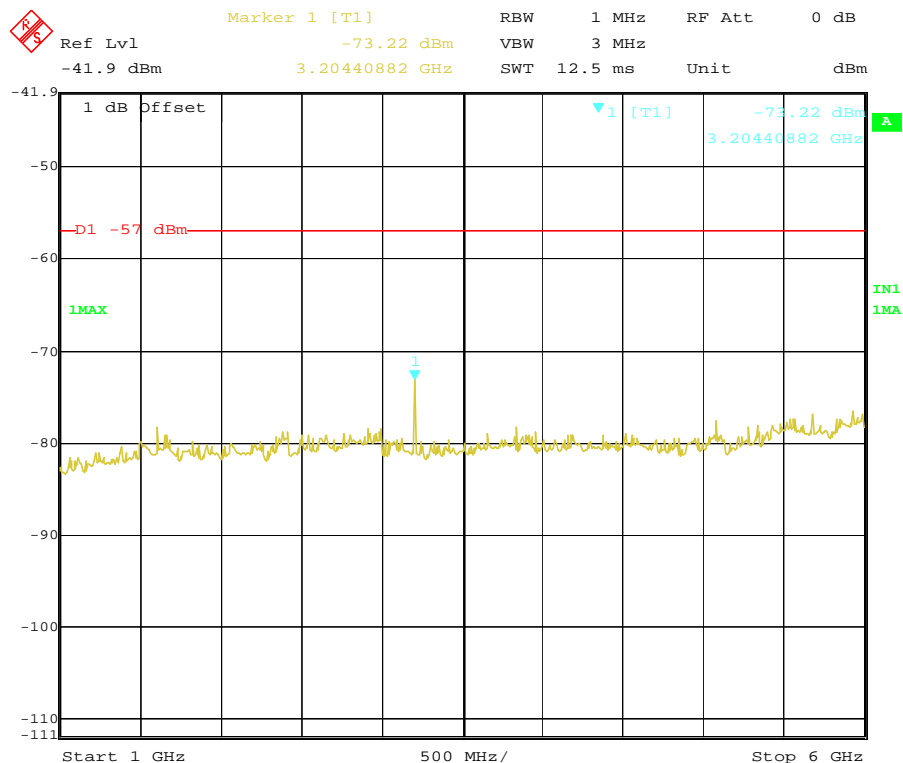

Date: 21.MAR.2011 18:57:12

Modulation Type	Channel Separation	Test Channel	Test Frequency (MHz)	Maximum Conducted Spurious Emissions Below 1GHz		Maximum Conducted Spurious Emissions Above 1GHz		FCC Limit
				Frequency (MHz)	Datum (dBm)	Frequency (MHz)	Datum (dBm)	
FM	12.5KHz	Low	418.0000	873.65	-87.47	3344.69	-68.20	-57dBm
Test Results				Compliance				

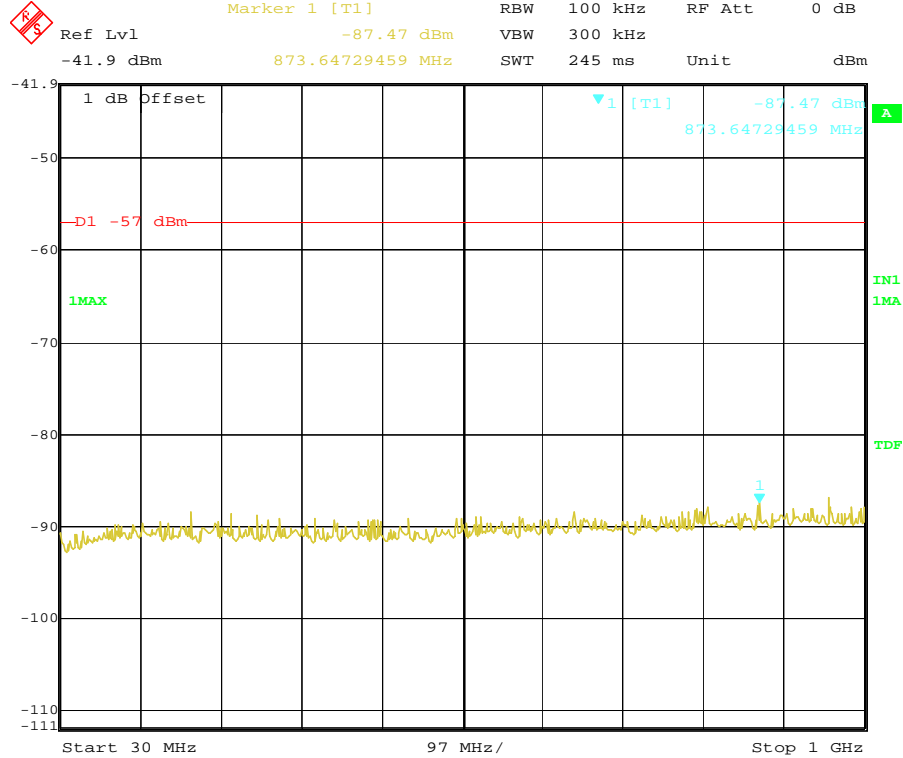

Date: 21.MAR.2011 18:52:37

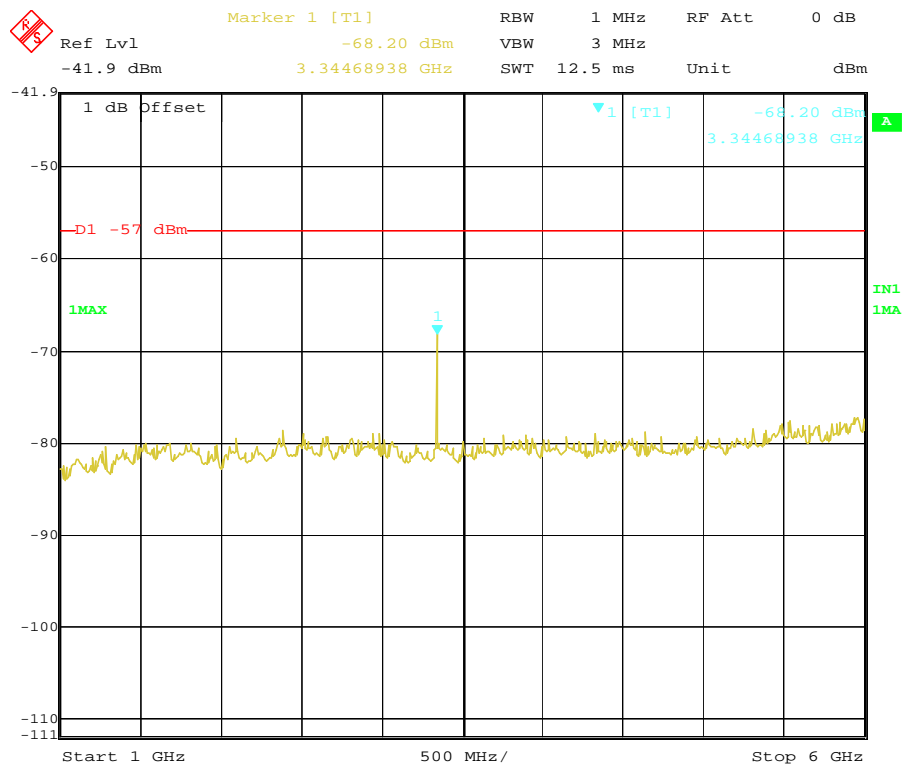

Date: 21.MAR.2011 18:57:21

Modulation Type	Channel Separation	Test Channel	Test Frequency (MHz)	Maximum Conducted Spurious Emissions Below 1GHz		Maximum Conducted Spurious Emissions Above 1GHz		FCC Limit
				Frequency (MHz)	Datum (dBm)	Frequency (MHz)	Datum (dBm)	
FM	12.5KHz	Middle	435.5000	537.35	-86.93	3484.97	-69.22	-57dBm
Test Results				Compliance				

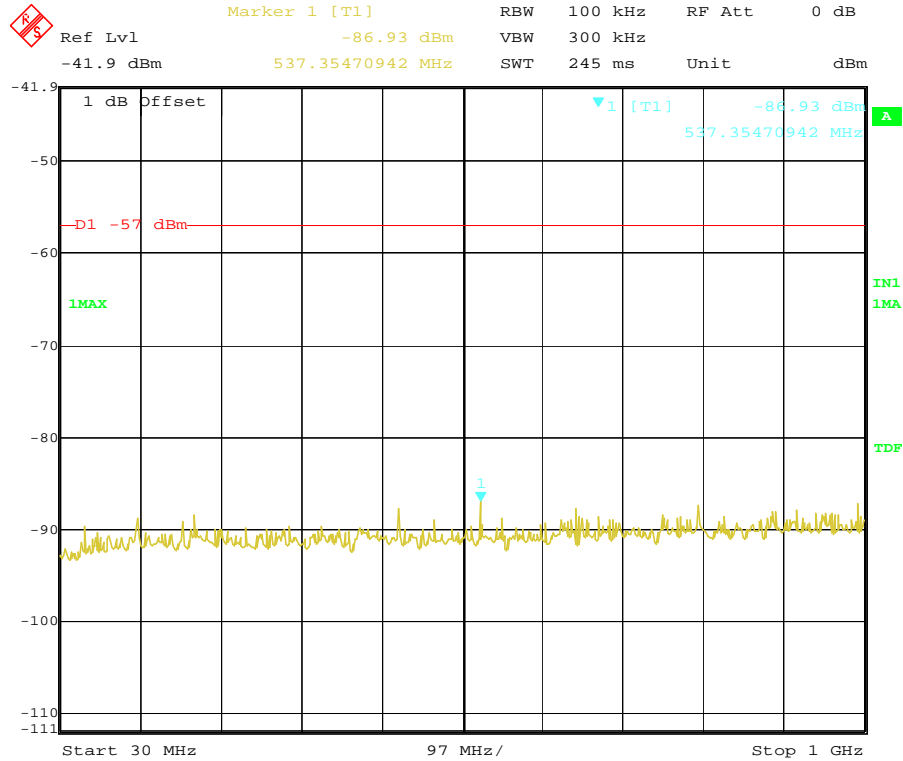

Date: 21.MAR.2011 18:52:44

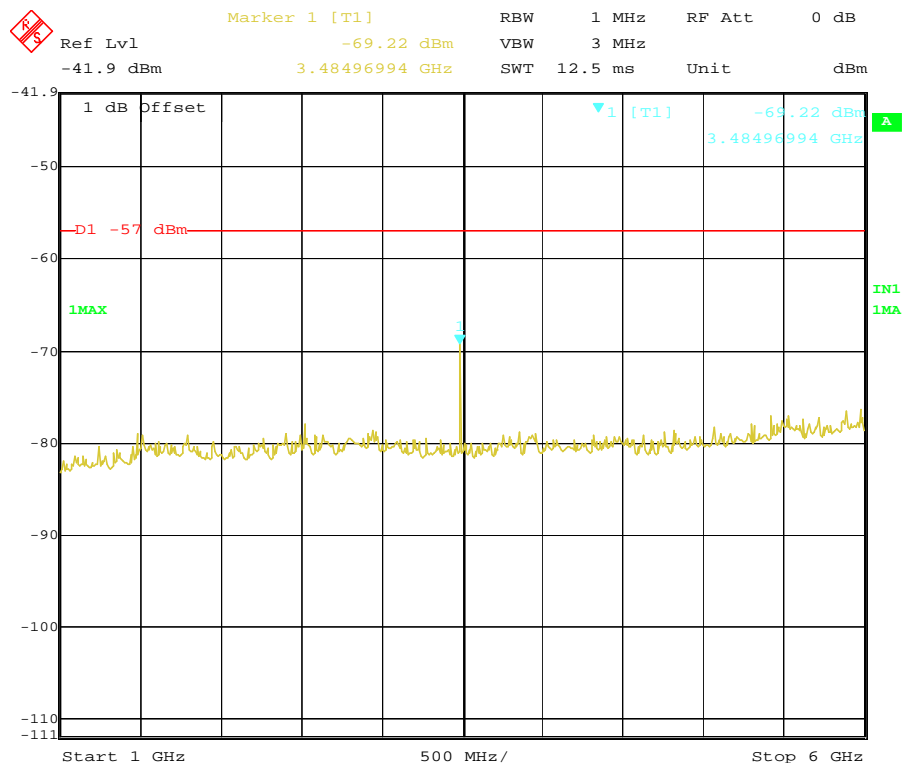

Date: 21.MAR.2011 18:57:36

Modulation Type	Channel Separation	Test Channel	Test Frequency (MHz)	Maximum Conducted Spurious Emissions Below 1GHz		Maximum Conducted Spurious Emissions Above 1GHz		FCC Limit
				Frequency (MHz)	Datum (dBm)	Frequency (MHz)	Datum (dBm)	
FM	12.5KHz	High	453.0000	941.68	-87.19	5829.66	-77.33	-57dBm
Test Results				Compliance				

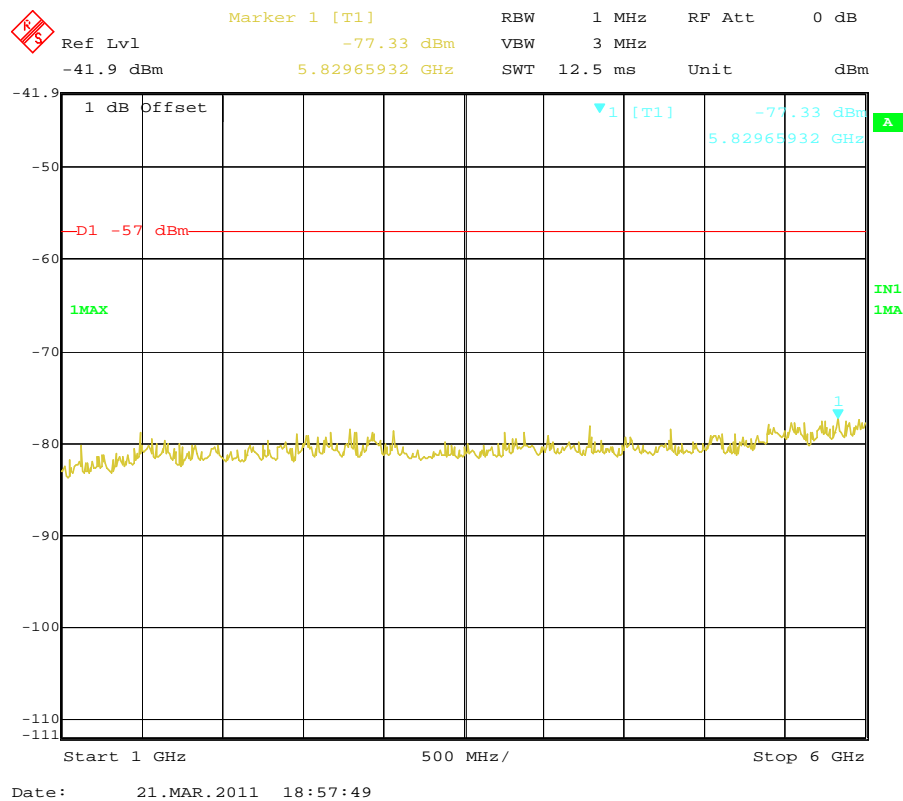
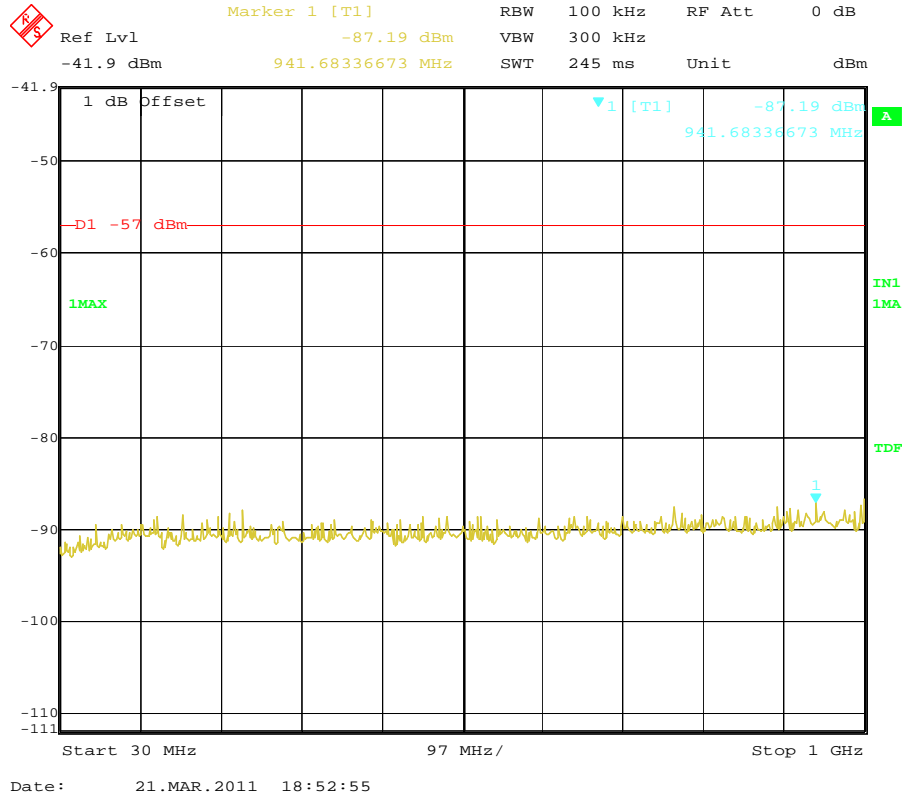

Modulation Type	Channel Separation	Test Channel	Test Frequency (MHz)	Maximum Conducted Spurious Emissions Below 1GHz		Maximum Conducted Spurious Emissions Above 1GHz		FCC Limit
				Frequency (MHz)	Datum (dBm)	Frequency (MHz)	Datum (dBm)	
FM	12.5KHz	High	469.5000	961.12	-87.25	3755.51	-72.98	-57dBm
Test Results				Compliance				

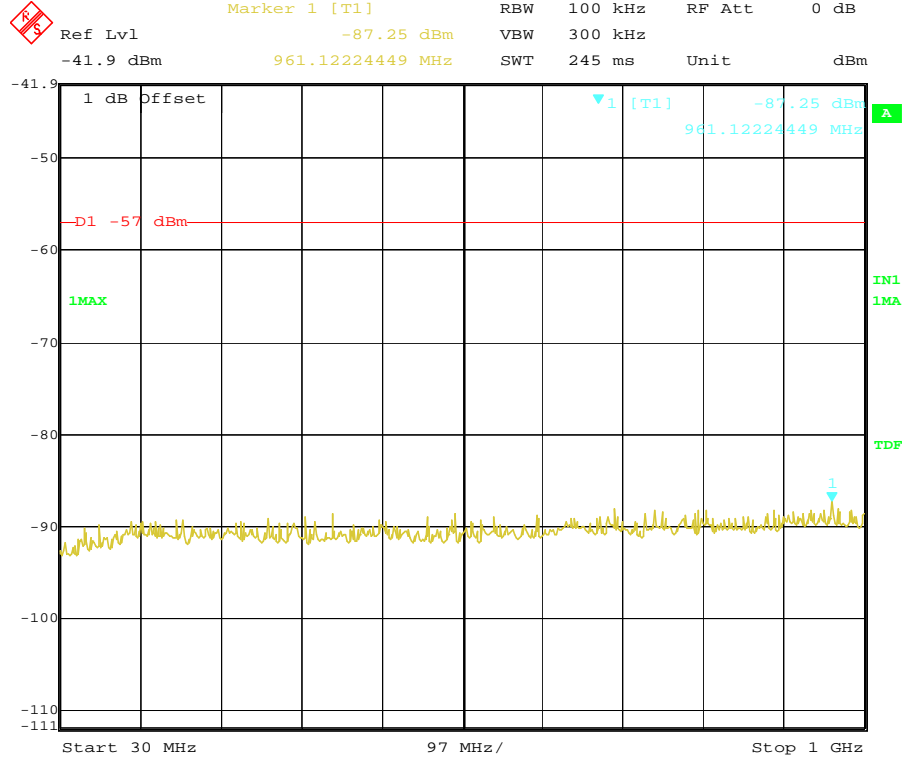

Date: 21.MAR.2011 18:53:03

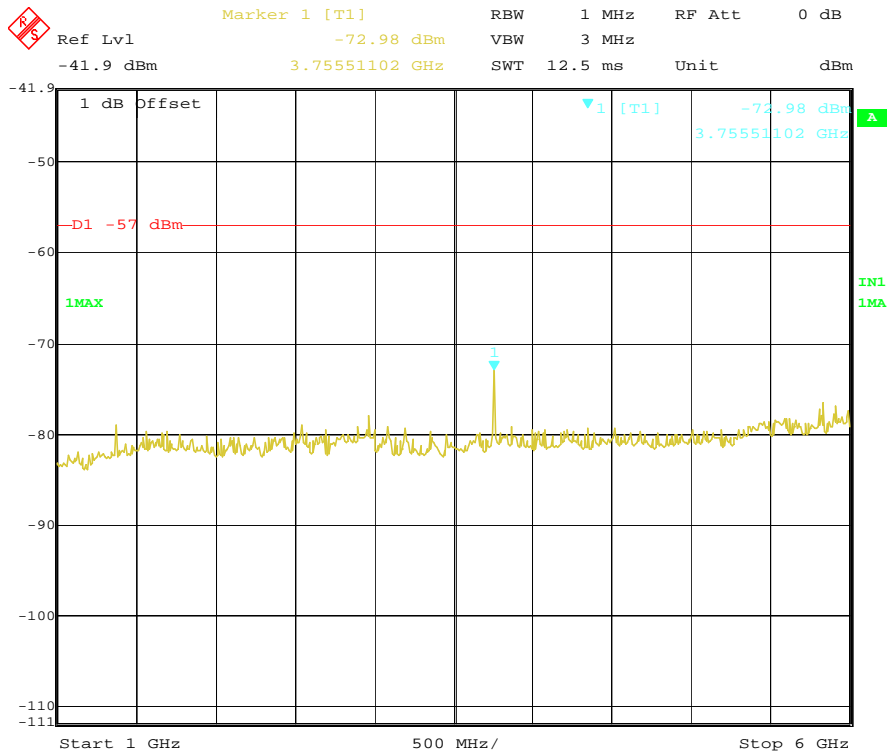

Date: 21.MAR.2011 18:57:55

### 5. Test Setup Photos of the EUT

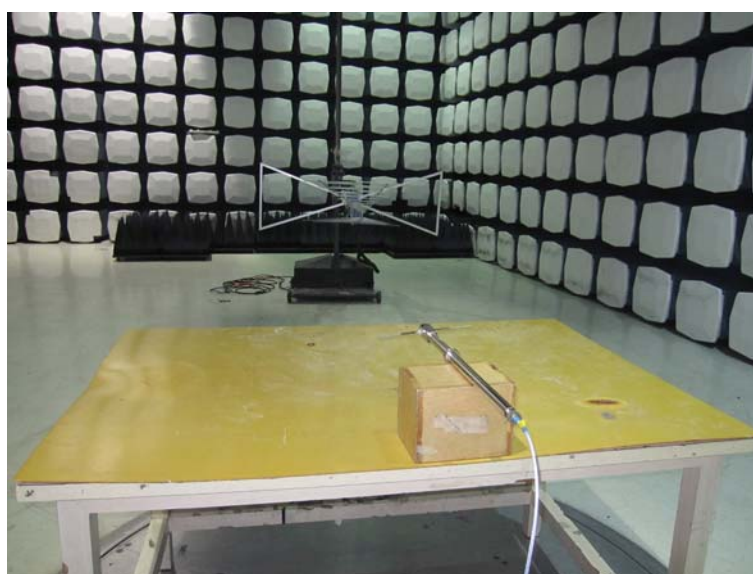
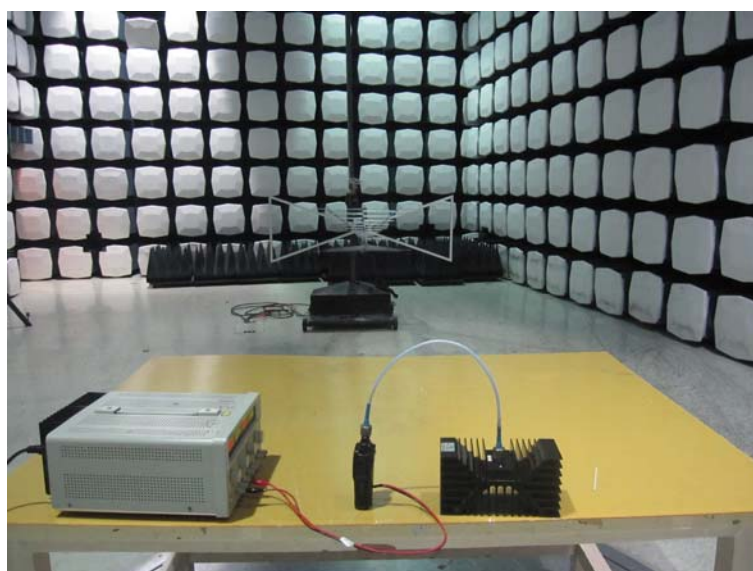



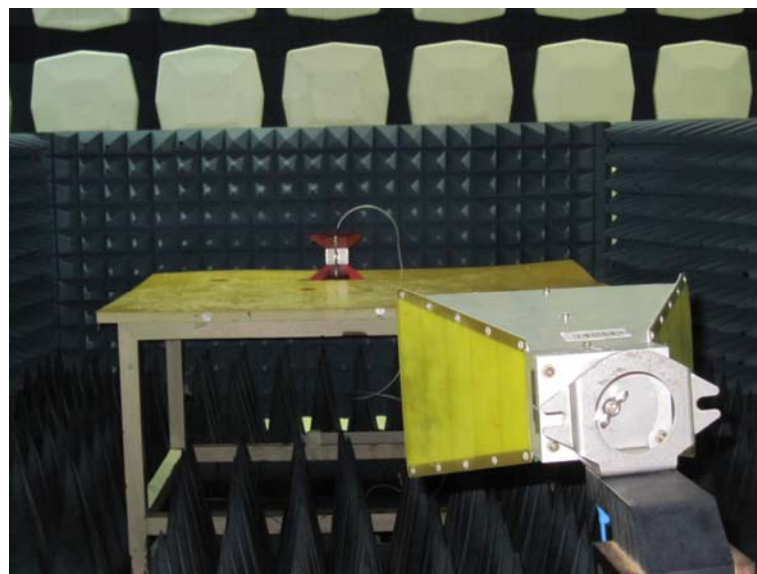
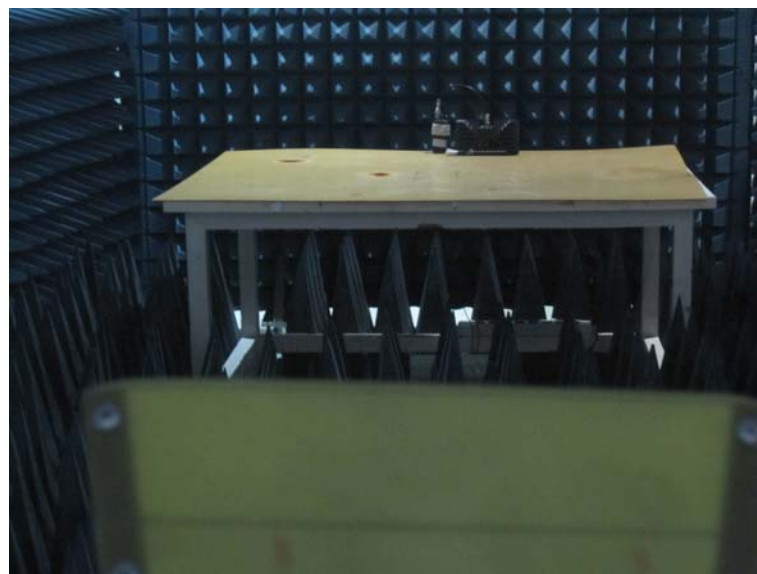
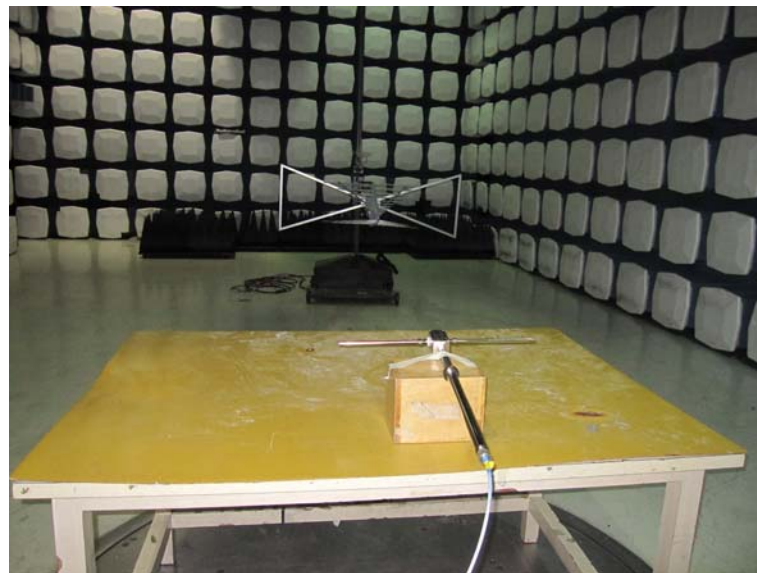

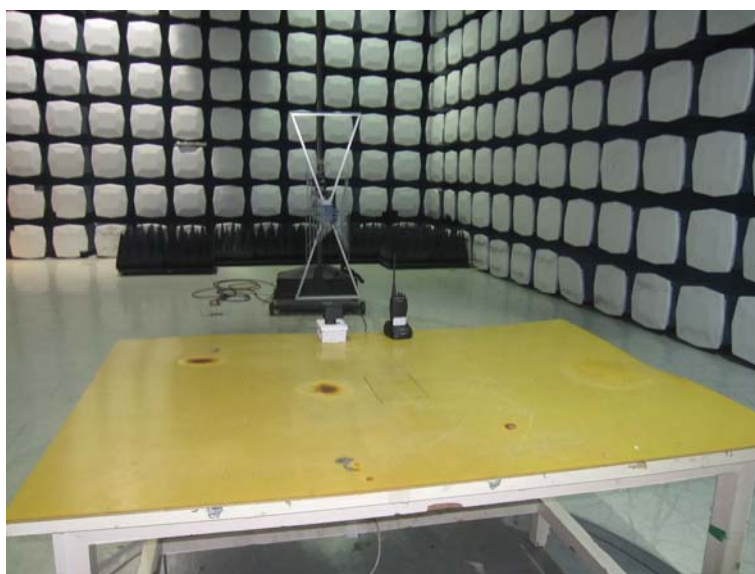
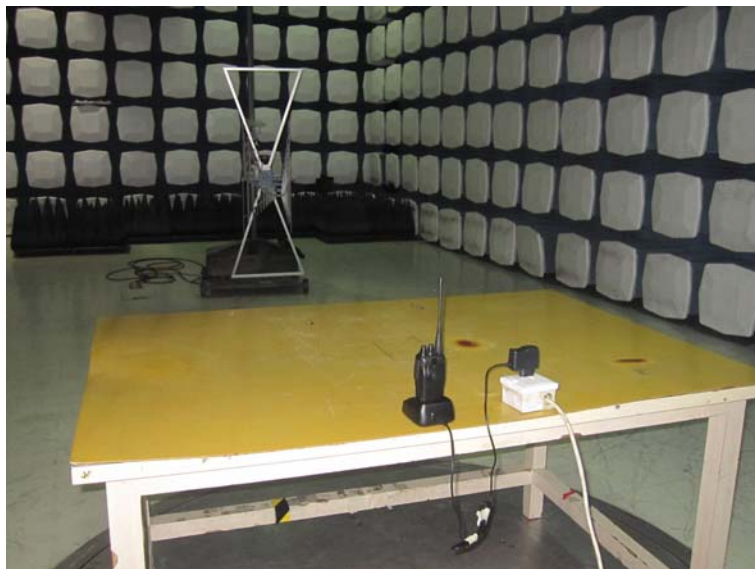

## 6. External and Internal Photos of the EUT

### External Photos









Internal Photos



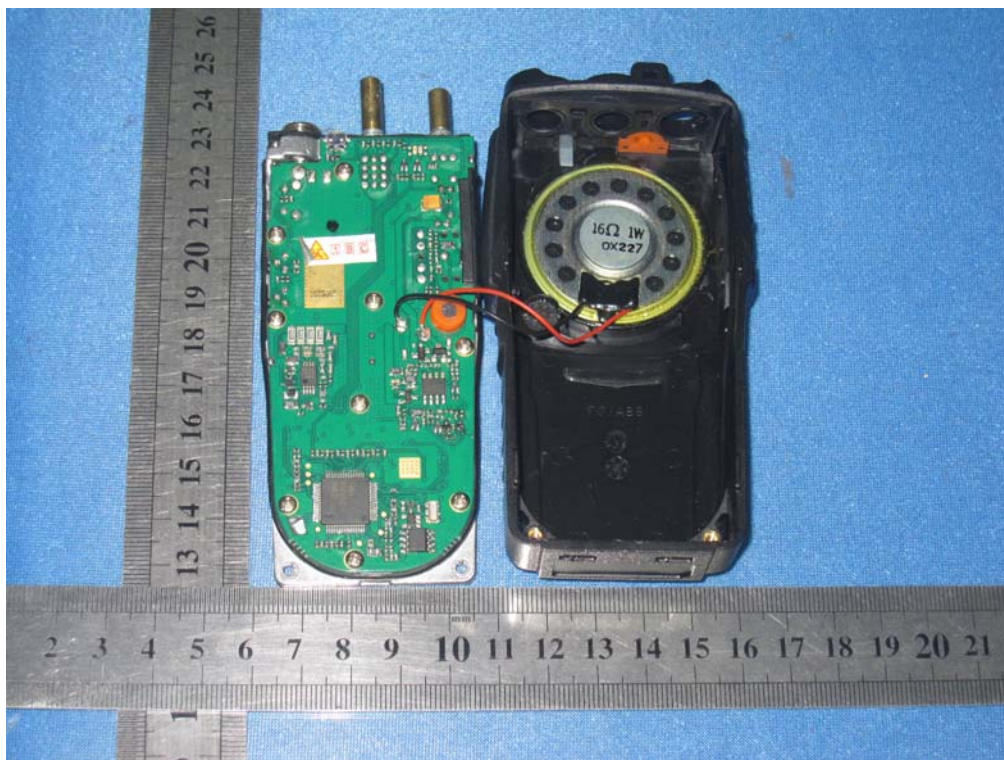



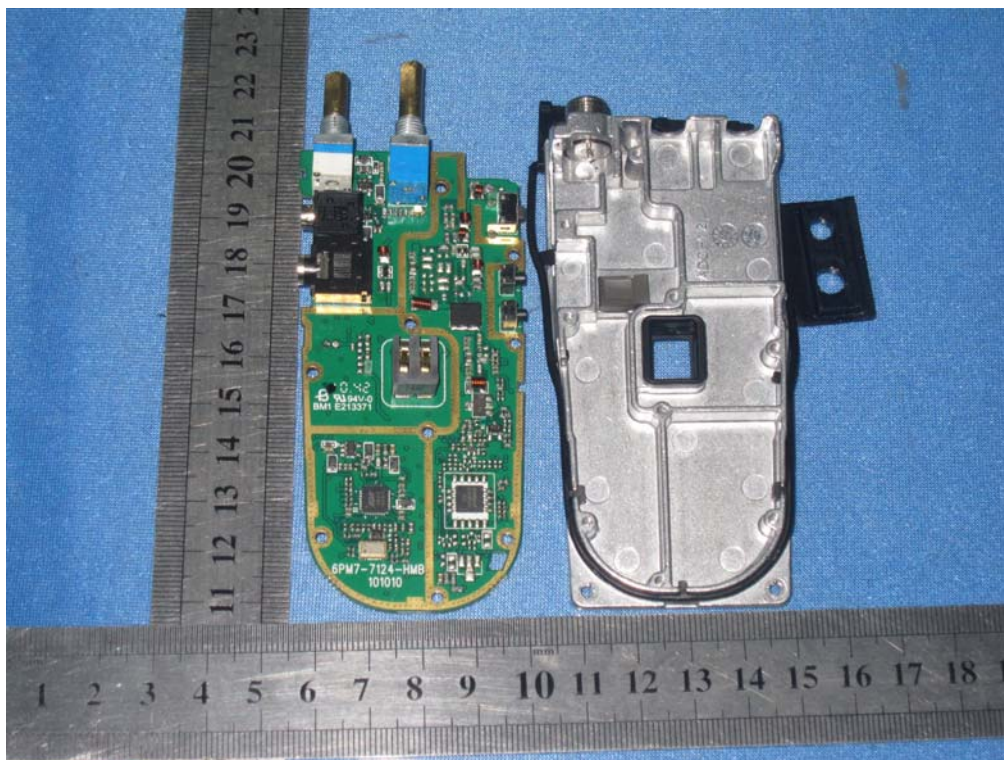
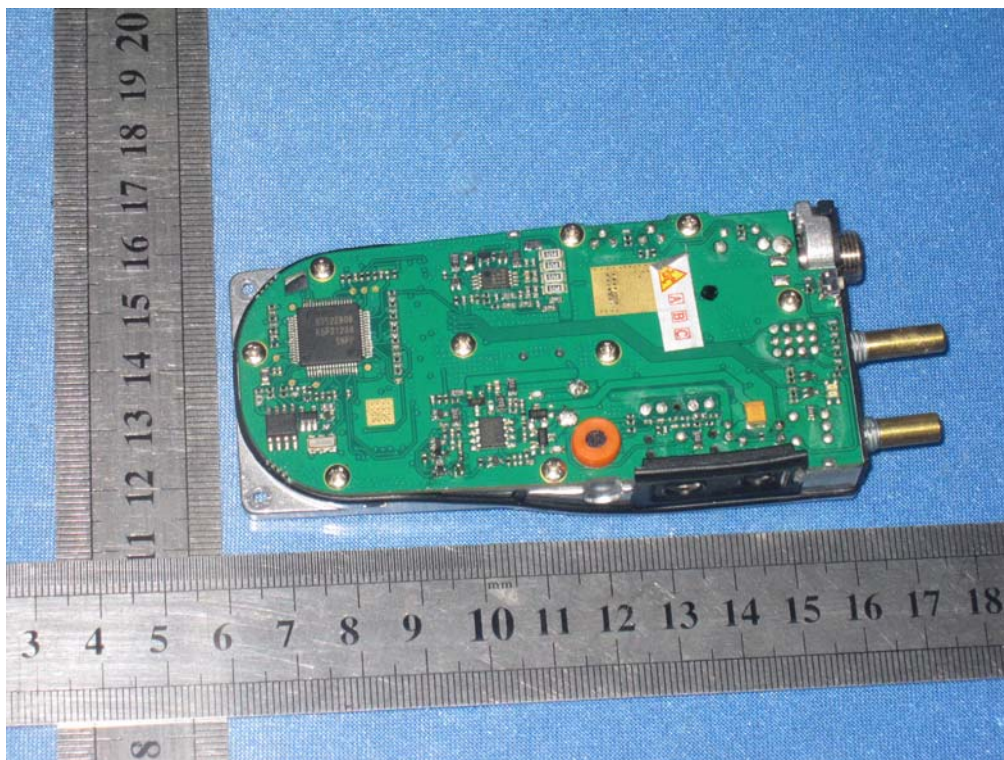

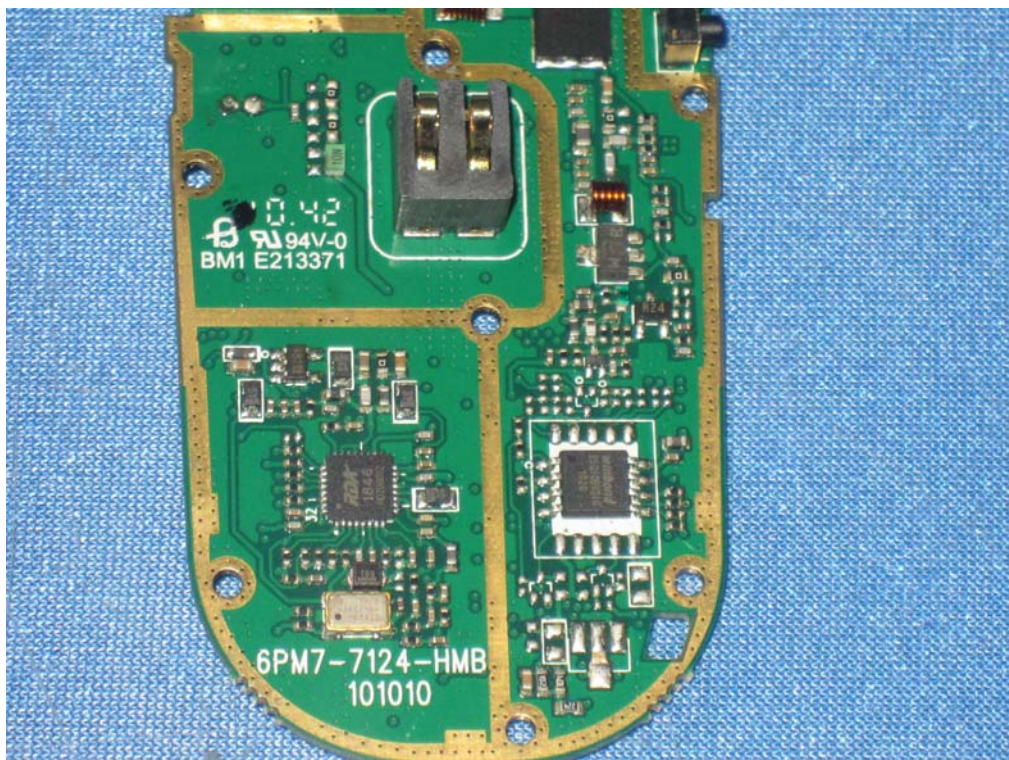
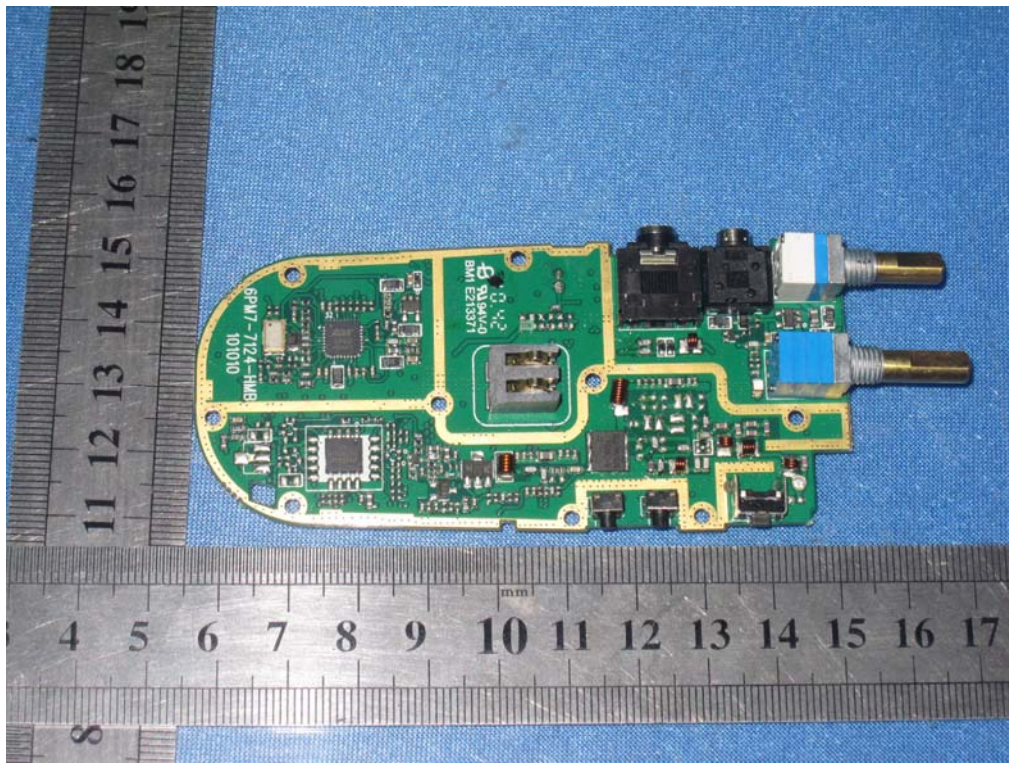

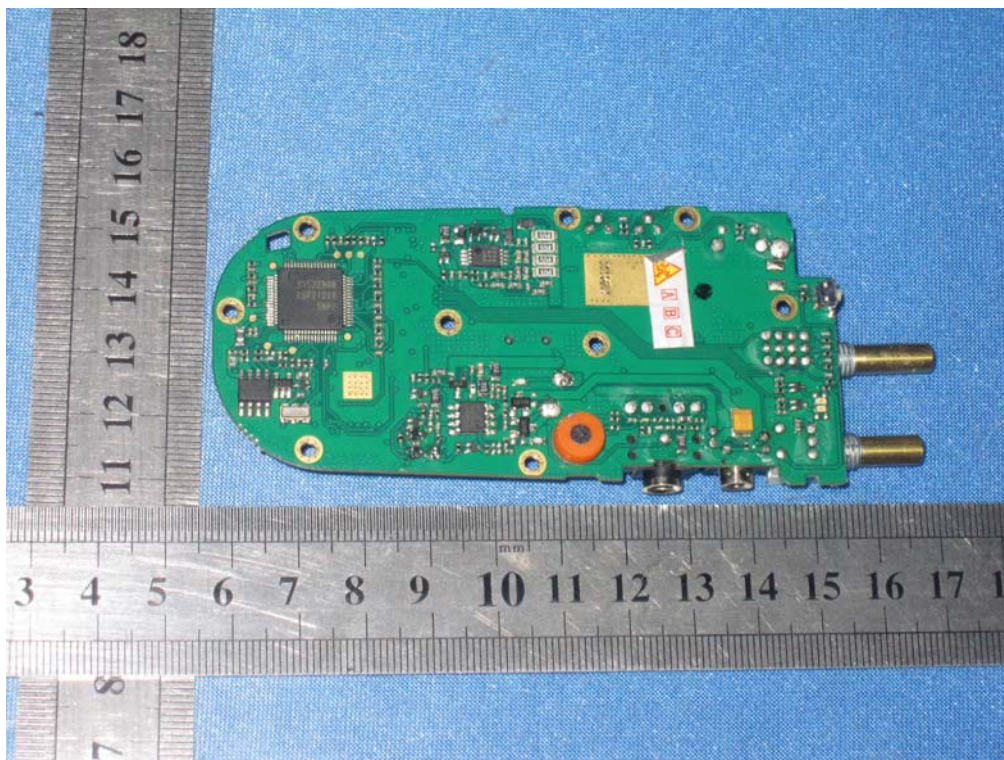
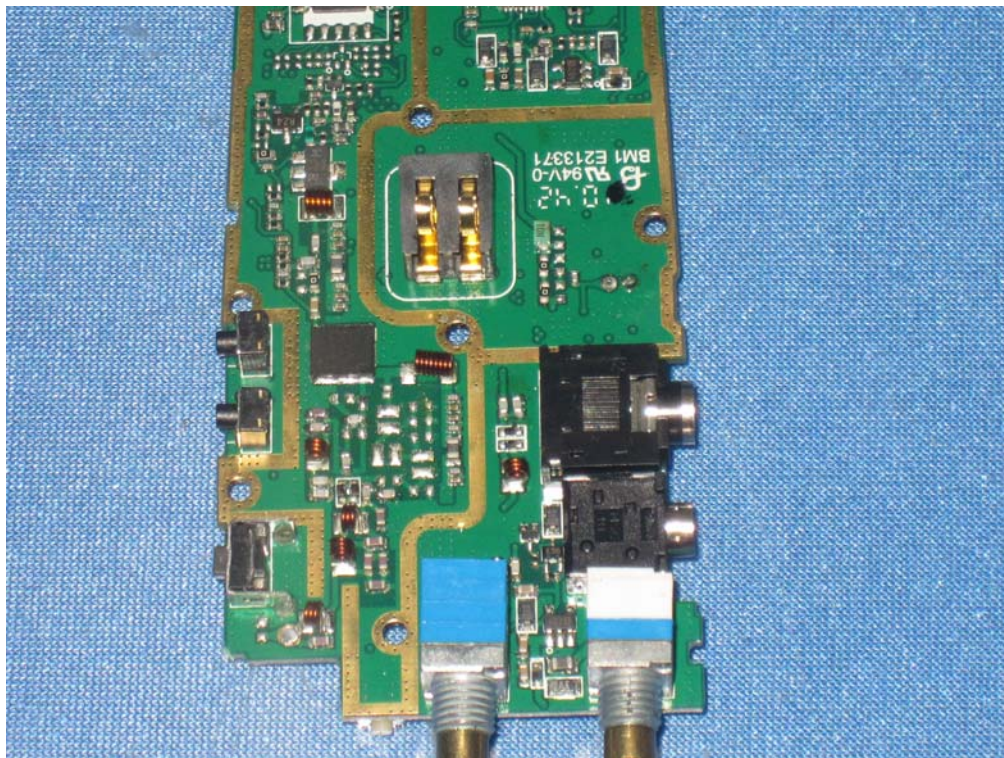

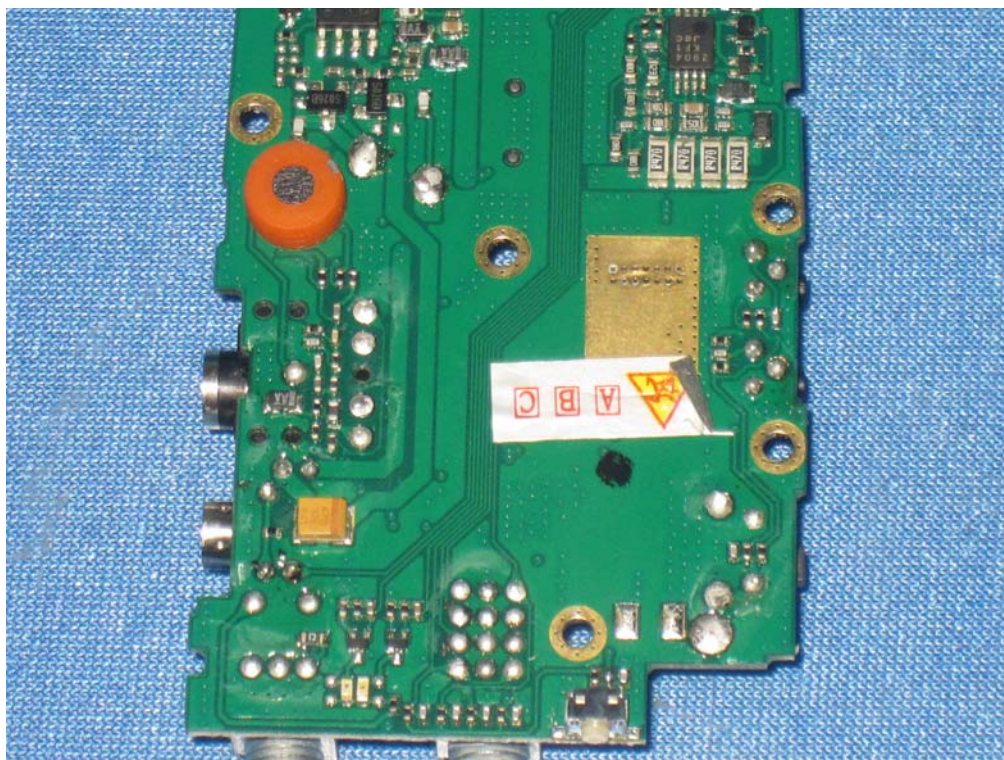
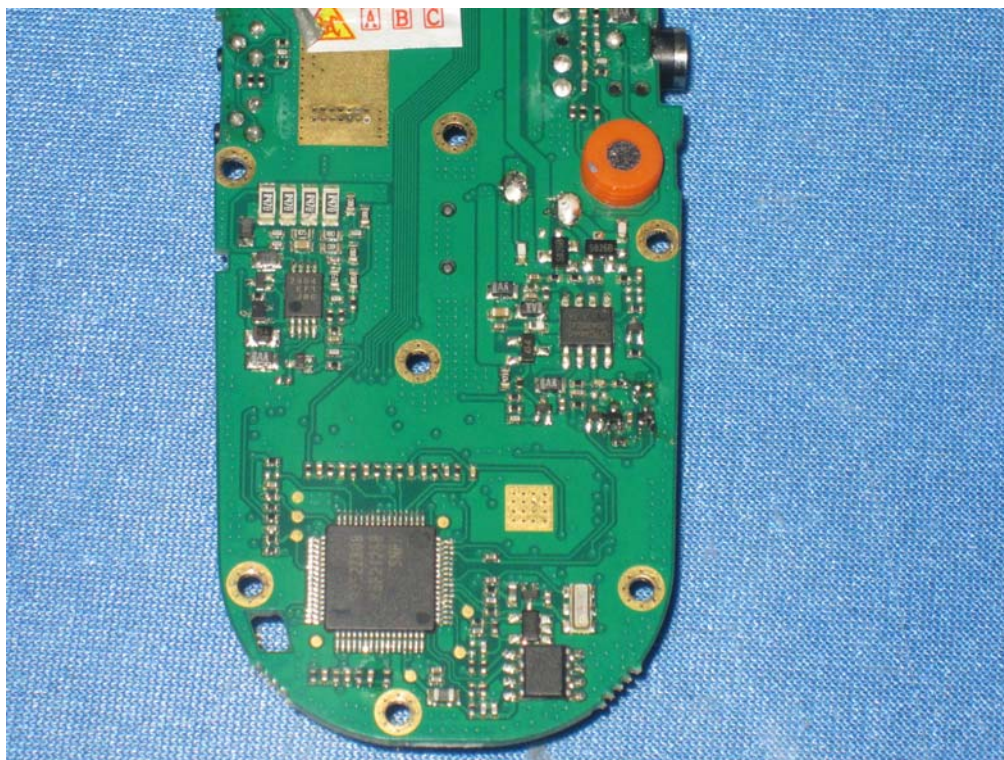

.....End of Report.....