



TEST REPORT

Report Reference No...... : **TRE1711018604** R/C.....: 80658

FCC ID..... : **Q5EM50**

Applicant's name..... : **Shenzhen Kirisun Communications Co., Ltd.**

Address..... : 3rd Floor, Building A, Tongfang Information Harbour, No.11
Langshan Road, Nanshan District,Shenzhen, China

Manufacturer..... : Shenzhen Kirisun Communications Co., Ltd.

Address..... : 3rd Floor, Building A, Tongfang Information Harbour, No.11
Langshan Road, Nanshan District,Shenzhen, China

Test item description : **POC Trunked Mobile Radio**

Trade Mark : KIRISUN

Model/Type reference..... : M50

Listed Model(s) : iTALK450

Standard : **FCC CFR Title 47 Part 15 Subpart C Section 15.247**

Date of receipt of test sample..... : Nov. 28, 2017

Date of testing..... : Nov. 29, 2017 – Jan. 05, 2018

Date of issue..... : Jan. 05, 2018

Result..... : **PASS**

Compiled by
(position+printedname+signature).... : File administrators Shayne Zhu

Supervised by
(position+printedname+signature)..... : Project Engineer Jerry Wang

Approved by
(Position+Printed name+Signature): RF Manager Hans Hu

Testing Laboratory Name : **Shenzhen Huatongwei International Inspection Co., Ltd.**

Address..... : 1/F, Bldg 3, Hongfa Hi-tech Industrial Park, Genyu Road,
Tianliao, Gongming, Shenzhen, China

Shenzhen Huatongwei International Inspection Co., Ltd. All rights reserved.

This publication may be reproduced in whole or in part for non-commercial purposes as long as the Shenzhen Huatongwei International Inspection Co., Ltd. is acknowledged as copyright owner and source of the material. Shenzhen Huatongwei International Inspection Co., Ltd. takes no responsibility for and will not assume liability for damages resulting from the reader's interpretation of the reproduced material due to its placement and context.

The test report merely correspond to the test sample.

Contents

1.	<u>TEST STANDARDS AND REPORT VERSION</u>	3
1.1.	Test Standards	3
1.2.	Report version	3
2.	<u>TEST DESCRIPTION</u>	4
3.	<u>SUMMARY</u>	5
3.1.	Client Information	5
3.2.	Product Description	5
3.3.	Operation state	6
3.4.	EUT configuration	6
3.5.	Modifications	6
4.	<u>TEST ENVIRONMENT</u>	7
4.1.	Address of the test laboratory	7
4.2.	Test Facility	7
4.3.	Environmental conditions	8
4.4.	Statement of the measurement uncertainty	8
4.5.	Equipments Used during the Test	9
5.	<u>TEST CONDITIONS AND RESULTS</u>	11
5.1.	Antenna requirement	11
5.2.	Conducted Emissions (AC Main)	12
5.3.	Conducted Peak Output Power	13
5.4.	20 dB Bandwidth	17
5.5.	Carrier Frequencies Separation	21
5.6.	Hopping Channel Number	23
5.7.	Dwell Time	25
5.8.	Pseudorandom Frequency Hopping Sequence	32
5.9.	Restricted band (radiated)	33
5.10.	Band edge and Spurious Emissions (conducted)	35
5.11.	Spurious Emissions (radiated)	51
6.	<u>TEST SETUP PHOTOS OF THE EUT</u>	56
7.	<u>EXTERANAL AND INTERNAL PHOTOS OF THE EUT</u>	56

1. TEST STANDARDS AND REPORT VERSION

1.1. Test Standards

The tests were performed according to following standards:

[FCC Rules Part 15.247](#): Frequency Hopping, Direct Spread Spectrum and Hybrid Systems that are in operation within the bands of 902-928 MHz, 2400-2483.5 MHz, and 5725-5850 MHz

[ANSI C63.10-2013](#): American National Standard for Testing Unlicensed Wireless Devices

1.2. Report version

Version No.	Date of issue	Description
00	Jan. 05, 2018	Original

2. TEST DESCRIPTION

Test Item	Section in CFR 47	Result	Test Engineer
Antenna Requirement	15.203/15.247 (c)	PASS	Jiuru Pan
AC Power Line Conducted Emissions	15.207	N/A	
Conducted Peak Output Power	15.247 (b)(1)	PASS	Jiuru Pan
20 dB Bandwidth	15.247 (a)(1)	PASS	Jiuru Pan
Carrier Frequencies Separation	15.247 (a)(1)	PASS	Jiuru Pan
Hopping Channel Number	15.247 (a)(1)	PASS	Jiuru Pan
Dwell Time	15.247 (a)(1)	PASS	Jiuru Pan
Pseudorandom Frequency Hopping Sequence	15.247(b)(4)	PASS	Jiuru Pan
Restricted band	15.247(d)/15.205	PASS	Jiuru Pan
Radiated Emissions	15.247(d)/15.209	PASS	Michael Jie

Note:

N/A means not applicable

The measurement uncertainty is not included in the test result.

3. SUMMARY

3.1. Client Information

Applicant:	Shenzhen Kirisun Communications Co., Ltd.
Address:	3rd Floor, Building A, Tongfang Information Harbour, No.11 Langshan Road, Nanshan District, Shenzhen, China
Manufacturer:	Shenzhen Kirisun Communications Co., Ltd.
Address:	3rd Floor, Building A, Tongfang Information Harbour, No.11 Langshan Road, Nanshan District, Shenzhen, China

3.2. Product Description

Name of EUT:	POC Trunked Mobile Radio
Trade Mark:	KIRISUN
Model No.:	M50
Listed Model(s):	iTALK450
IMEI:	865746030000260
Power supply:	12-24Vd.c., 2A
Adapter information:	-
Hardware version:	V1.0
Software version:	V1.0
Bluetooth	
Version:	Supported BT3.0+HS
Modulation:	GFSK, $\pi/4$ DQPSK, 8DPSK
Operation frequency:	2402MHz~2480MHz
Channel number:	79
Channel separation:	1MHz
Antenna type:	PIFA antenna
Antenna gain:	-0.5 dBi

Remark:

We tested DC 12V and DC 24V, recorded worst case for DC 12V.

3.3. Operation state

➤ **Test frequency list**

According to section 15.31(m), regards to the operating frequency range over 10 MHz, must select three channel which were tested. the Lowest frequency, the middle frequency, and the highest frequency of channel were selected to perform the test, please see the above gray bottom.

Channel	Frequency (MHz)
00	2402
01	2403
⋮	⋮
39	2441
⋮	⋮
77	2479
78	2480

➤ **TEST MODE**

For RF test items:
The engineering test program was provided and enabled to make EUT continuous transmit
For AC power line conducted emissions:
The EUT was set to connect with the Bluetooth instrument under large package sizes transmission.
For Radiated suprious emissions test item:
The engineering test program was provided and enabled to make EUT continuous transmit. The EUT in each of three orthogonal axis emissions had been tested ,but only the worst case (X axis) data recorded in the report.

3.4. EUT configuration

The following peripheral devices and interface cables were connected during the measurement:

- - supplied by the manufacturer
- - supplied by the lab

/	Manufacturer:	/
	Model No.:	/
/	Manufacturer:	/
	Model No.:	/

3.5. Modifications

No modifications were implemented to meet testing criteria.

4. TEST ENVIRONMENT

4.1. Address of the test laboratory

Laboratory: Shenzhen Huatongwei International Inspection Co., Ltd.

Address: 1/F, Bldg 3, Hongfa Hi-tech Industrial Park, Genyu Road, Tianliao, Gongming, Shenzhen, China

4.2. Test Facility

CNAS-Lab Code: L1225

Shenzhen Huatongwei International Inspection Co., Ltd. has been assessed and proved to be in compliance with CNAS-CL01 Accreditation Criteria for Testing and Calibration Laboratories (identical to ISO/IEC17025: 2005 General Requirements) for the Competence of Testing and Calibration Laboratories.

A2LA-Lab Cert. No.: 3902.01

Shenzhen Huatongwei International Inspection Co., Ltd. EMC Laboratory has been accredited by A2LA for technical competence in the field of electrical testing, and proved to be in compliance with ISO/IEC 17025: 2005 General Requirements for the Competence of Testing and Calibration Laboratories and any additional program requirements in the identified field of testing.

FCC-Registration No.: 762235

Shenzhen Huatongwei International Inspection Co., Ltd. EMC Laboratory has been registered and fully described in a report filed with the FCC (Federal Communications Commission). The acceptance letter from the FCC is maintained in our files.

IC-Registration No.:5377B-1

Two 3m Alternate Test Site of Shenzhen Huatongwei International Inspection Co., Ltd. has been registered by Certification and Engineering Bureau of Industry Canada for the performance of radiated measurements with Registration No.: 5377B-1.

ACA

Shenzhen Huatongwei International Inspection Co., Ltd. EMC Laboratory can also perform testing for the Australian C-Tick mark as a result of our A2LA accreditation.

4.3. Environmental conditions

During the measurement the environmental conditions were within the listed ranges:

Temperature:	15~35°C
Relative Humidity:	30~60 %
Air Pressure:	950~1050mba

4.4. Statement of the measurement uncertainty

The data and results referenced in this document are true and accurate. The reader is cautioned that there may be errors in calibration limits of the equipment and facilities. The measurement uncertainty was calculated for all measurements listed in this test report according to TR-100028-01 "Electromagnetic compatibility and Radio spectrum Matters (ERM); Uncertainties in the measurement of mobile radio equipment characteristics; Part 1" and TR-100028-02 "Electromagnetic compatibility and Radio spectrum Matters (ERM); Uncertainties in the measurement of mobile radio equipment characteristics; Part 2" and is documented in the Shenzhen Huatongwei International Inspection Co., Ltd. quality system according to ISO/IEC 17025. Furthermore, component and process variability of devices similar to that tested may result in additional deviation. The manufacturer has the sole responsibility of continued compliance of the device.

Here after the best measurement capability for Shenzhen Huatongwei International Inspection Co., Ltd. is reported:

Test Items	Measurement Uncertainty	Notes
Transmitter power conducted	0.57 dB	(1)
Transmitter power Radiated	2.20 dB	(1)
Conducted spurious emissions 9kHz~40GHz	1.60 dB	(1)
Radiated spurious emissions 9kHz~40GHz	2.20 dB	(1)
Conducted Emissions 9kHz~30MHz	3.39 dB	(1)
Radiated Emissions 30~1000MHz	4.24 dB	(1)
Radiated Emissions 1~18GHz	5.16 dB	(1)
Radiated Emissions 18~40GHz	5.54 dB	(1)
Occupied Bandwidth	-----	(1)

(1) This uncertainty represents an expanded uncertainty expressed at approximately the 95% confidence level using a coverage factor of $k=1.96$.

4.5. Equipments Used during the Test

Conducted Emissions						
Item	Test Equipment	Manufacturer	Model No.	Serial No.	Last Cal. (mm-dd-yy)	Next Cal. (mm-dd-yy)
1	EMI Test Receiver	R&S	ESCI	101247	11/11/2017	11/10/2018
2	Artificial Mains	SCHWARZBECK	NNLK 8121	573	11/11/2017	11/10/2018
3	2-Line V-Network	R&S	ESH3-Z5	100049	11/11/2017	11/10/2018
4	Pulse Limiter	R&S	ESH3-Z2	101488	11/11/2017	11/10/2018
5	RF Connection Cable	HUBER+SUHNER	EF400	N/A	11/21/2017	11/20/2018
6	Test Software	R&S	ES-K1	N/A	N/A	N/A

Radiated Emissions						
Item	Test Equipment	Manufacturer	Model No.	Serial No.	Last Cal. (mm-dd-yy)	Next Cal. (mm-dd-yy)
1	EMI Test Receiver	R&S	ESCI	101247	11/11/2017	11/10/2018
2	Loop Antenna	R&S	HFH2-Z2	100020	11/20/2017	11/19/2018
3	Ultra-Broadband Antenna	SCHWARZBECK	VULB9163	538	4/5/2017	4/4/2018
4	Preamplifier	SCHWARZBECK	BBV 9743	9743-0022	10/18/2017	10/17/2018
5	RF Connection Cable	HUBER+SUHNER	RE-7-FL	N/A	11/21/2017	11/20/2018
6	EMI Test Software	R&S	ESK1	N/A	N/A	N/A
7	Spectrum Analyzer	R&S	FSP40	100597	11/11/2017	11/10/2018
8	Horn Antenna	SCHWARZBECK	9120D	1011	3/27/2017	3/26/2018
9	Horn Antenna	SCHWARZBECK	BBHA9170	25841	3/27/2017	3/26/2018
10	Broadband Preamplifier	SCHWARZBECK	BBV 9718	9718-248	10/18/2017	10/17/2018
11	High pass filter	Compliance Direction systems	BSU-6	34202	11/11/2017	11/10/2018
12	RF Connection Cable	HUBER+SUHNER	RE-7-FH	N/A	11/21/2017	11/20/2018
13	EMI Test Software	Audix	E3	N/A	N/A	N/A
14	Turntable	MATURO	TT2.0	/	N/A	N/A
15	Antenna Mast	MATURO	TAM-4.0-P	/	N/A	N/A

RF Conducted Test						
Item	Test Equipment	Manufacturer	Model No.	Serial No.	Last Cal. (mm-dd-yy)	Next Cal. (mm-dd-yy)
1	Spectrum Analyzer	R&S	FSV40	100048	11/11/2017	11/10/2018
2	EXA Signal Analyzer	Agilent	N9020A	184247	9/22/2017	9/21/2018
3	Power Meter	Agilent	U2021XA	178231	9/22/2017	9/21/2018
4	OSP	R&S	OSP120	101317	N/A	N/A

The Cal.Interval was one year.

5. TEST CONDITIONS AND RESULTS

5.1. Antenna requirement

Requirement

FCC CFR Title 47 Part 15 Subpart C Section 15.203:

An intentional radiator shall be designed to ensure that no antenna other than that furnished by the responsible party shall be used with the device. The use of a permanently attached antenna or of an antenna that uses a unique coupling to the intentional radiator, the manufacturer may design the unit so that a broken antenna can be replaced by the user, but the use of a standard antenna jack or electrical connector is prohibited.

FCC CFR Title 47 Part 15 Subpart C Section 15.247(c) (1)(i):

(i) Systems operating in the 2400~2483.5 MHz band that is used exclusively for fixed. Point-to-point operations may employ transmitting antennas with directional gain greater than 6 dBi provided the maximum conducted output power of the intentional radiator is reduced by 1 dB for every 3 dB that the directional gain of the antenna exceeds 6 dBi.

Test Result:

Passed **Not Applicable**

The directional gain of the antenna less than 6 dBi, please refer to the below antenna photo.

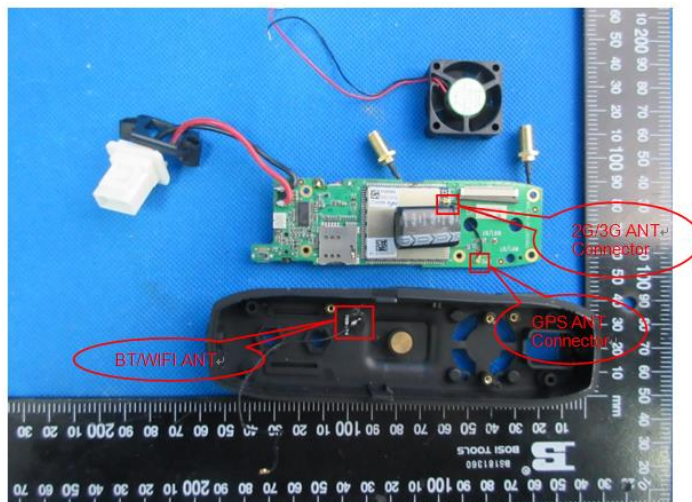

5.2. Conducted Emissions (AC Main)

LIMIT

FCC CFR Title 47 Part 15 Subpart C Section 15.207

Frequency range (MHz)	Limit (dBuV)	
	Quasi-peak	Average
0.15-0.5	66 to 56*	56 to 46*
0.5-5	56	46
5-30	60	50

* Decreases with the logarithm of the frequency.

TEST CONFIGURATION

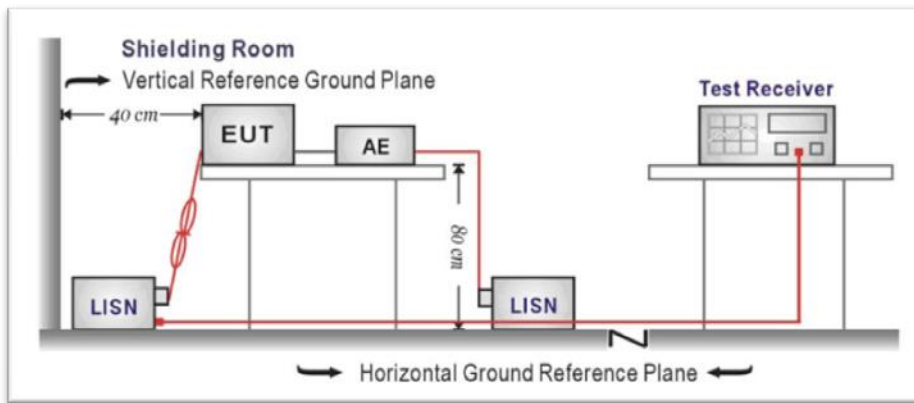

TEST PROCEDURE

1. The EUT was setup according to ANSI C63.10:2013 requirements.
2. The EUT was placed on a platform of nominal size, 1 m by 1.5 m, raised 80 cm above the conducting ground plane. The vertical conducting plane was located 40 cm to the rear of the EUT. All other surfaces of EUT were at least 80 cm from any other grounded conducting surface.
3. The EUT and simulators are connected to the main power through a line impedances stabilization network (LISN). The LISN provides a 50 ohm /50uH coupling impedance for the measuring equipment.
4. The peripheral devices are also connected to the main power through a LISN. (Please refer to the block diagram of the test setup and photographs)
5. Each current-carrying conductor of the EUT power cord, except the ground (safety) conductor, was individually connected through a LISN to the input power source.
6. The excess length of the power cord between the EUT and the LISN receptacle were folded back and forth at the center of the lead to form a bundle not exceeding 40 cm in length.
7. Conducted emissions were investigated over the frequency range from 0.15MHz to 30MHz using a receiver bandwidth of 9 kHz.
8. During the above scans, the emissions were maximized by cable manipulation.

TEST RESULTS

Passed Not Applicable

5.3. Conducted Peak Output Power

LIMIT

FCC CFR Title 47 Part 15 Subpart C Section 15.247 (b)(1):

For frequency hopping systems operating in the 2400-2483.5 MHz band employing at least 75 non-overlapping hopping channels, and all frequency hopping systems in the 5725-5850 MHz band: 1 watt. For all other frequency hopping systems in the 2400-2483.5 MHz band: 0.125 watts.

TEST CONFIGURATION

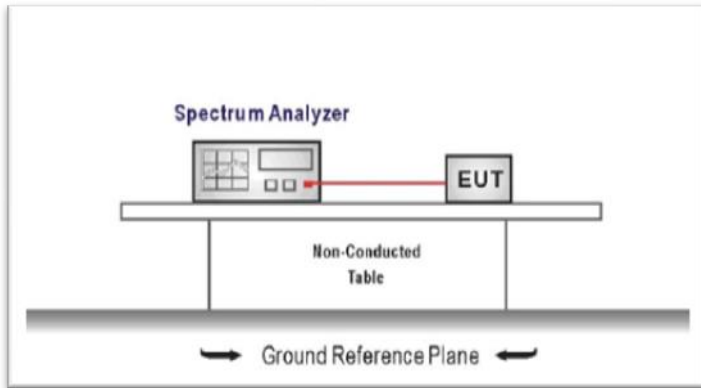

TEST PROCEDURE

1. The transmitter output was connected to the spectrum analyzer through an attenuator, the pathloss was compensated to the results for each measurement.
2. Set to the maximum power setting and enable the EUT transmit continuously
3. Use the following spectrum analyzer settings:
 Span = approximately 5 times the 20 dB bandwidth, centered on a hopping channel
 RBW ≥ the 20 dB bandwidth of the emission being measured, VBW ≥ RBW
 Sweep = auto, Detector function = peak, Trace = max hold
4. Measure and record the results in the test report.

TEST MODE:

Please refer to the clause 3.3

TEST RESULTS

Passed Not Applicable

Modulation type	Channel	Output power (dBm)	Limit (dBm)	Result
GFSK	00	5.41	≤ 30.00	Pass
	39	5.10		
	78	4.94		
π/4DQPSK	00	4.67	≤ 21.00	Pass
	39	4.50		
	78	4.19		
8DPSK	00	4.78	≤ 21.00	Pass
	39	4.60		
	78	4.31		

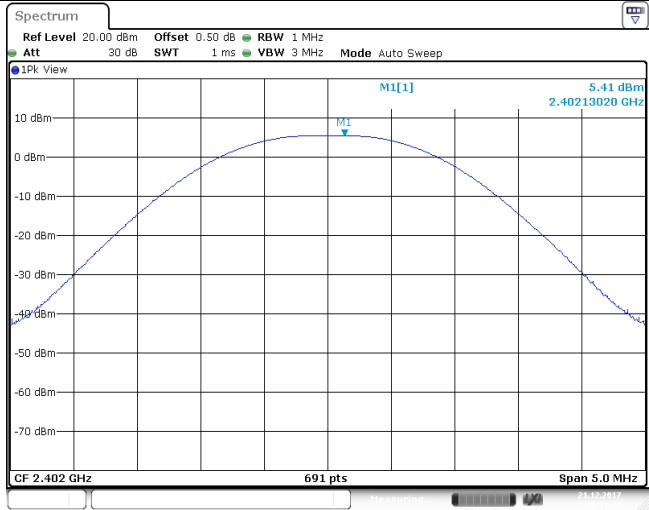
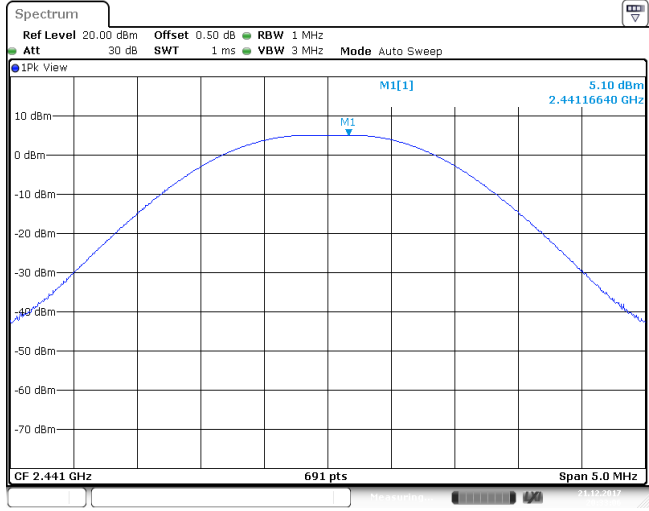
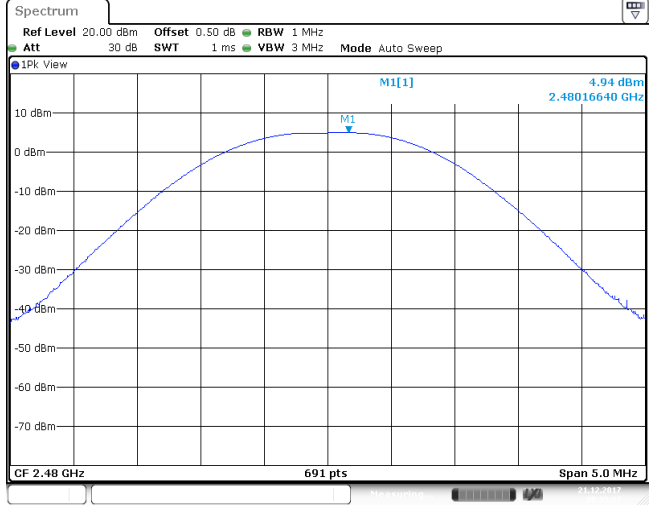
Modulation Type: GFSK	
CH00	
CH39	
CH78	

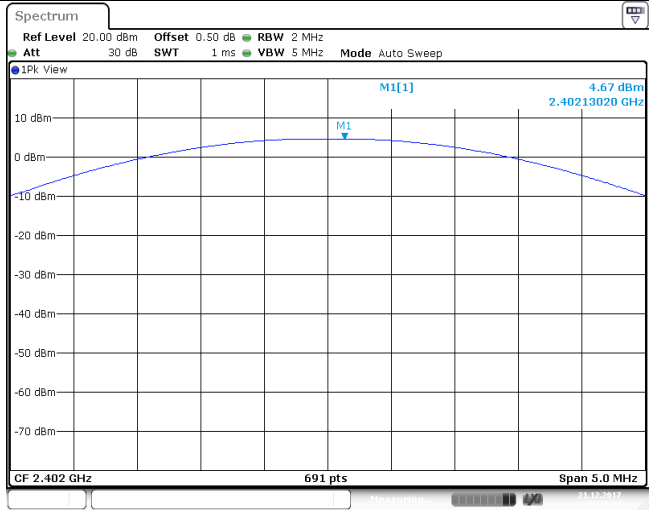
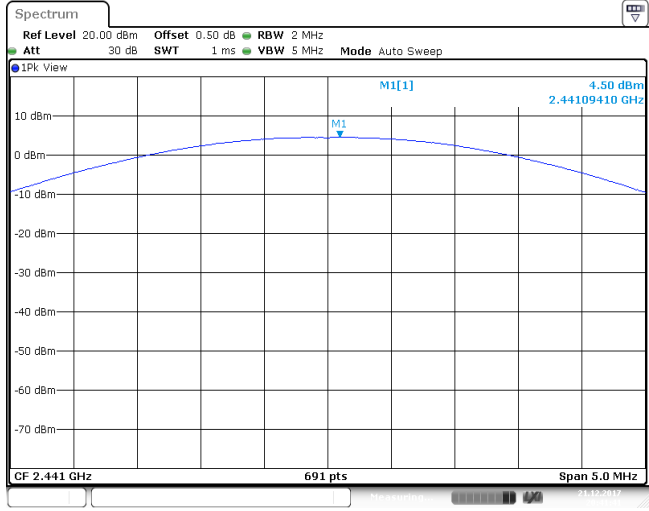
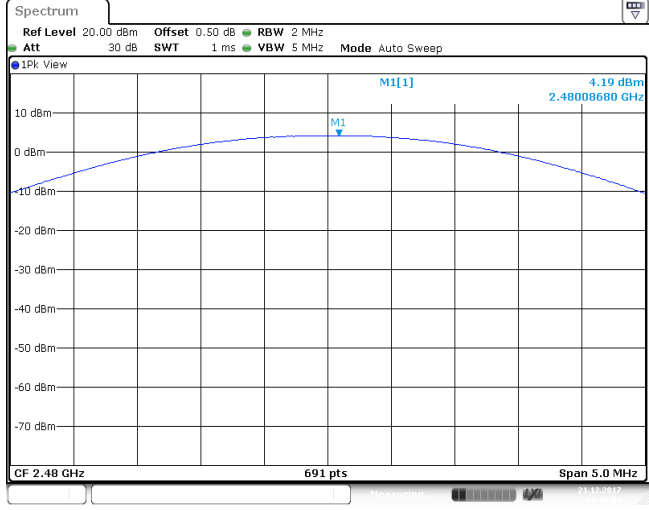
Modulation Type: $\pi/4$ DQPSK	
CH00	
CH39	
CH78	

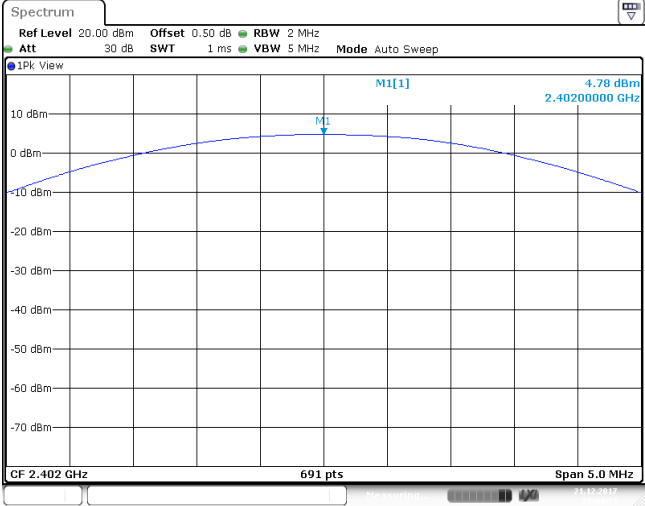
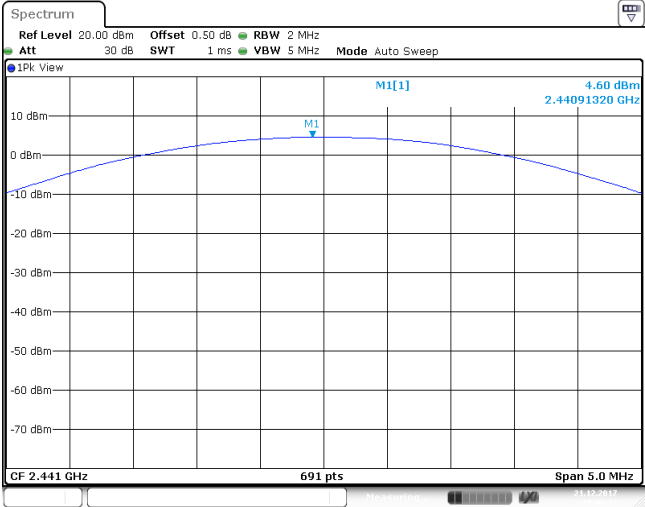
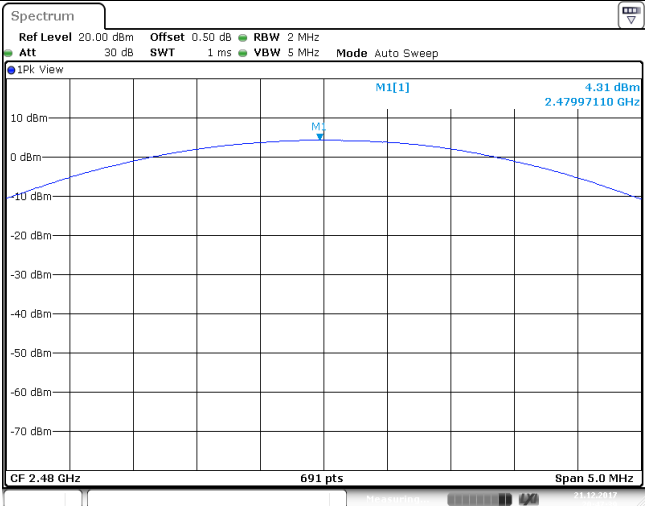
Modulation Type: 8DPSK	
CH00	
CH39	
CH78	

5.4. 20 dB Bandwidth

LIMIT

N/A

TEST CONFIGURATION

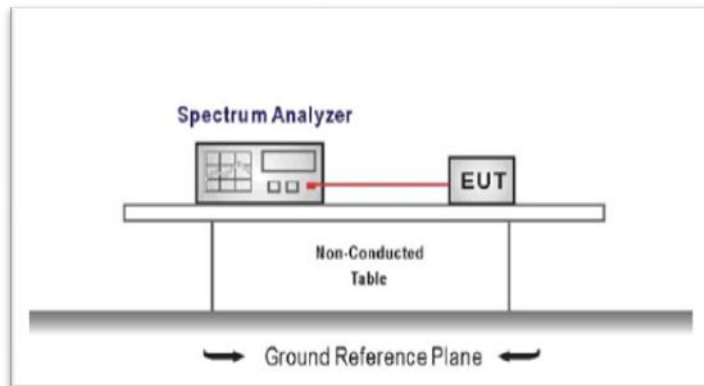

TEST PROCEDURE

1. The transmitter output was connected to the spectrum analyzer through an attenuator, the path loss was compensated to the results for each measurement.
2. Set to the maximum power setting and enable the EUT transmit continuously
3. Use the following spectrum analyzer settings:
Span = approximately 2 to 3 times the 20 dB bandwidth, centered on a hopping channel
RBW \geq 1% of the 20 dB bandwidth, VBW \geq RBW
Sweep = auto, Detector function = peak, Trace = max hold
4. Measure and record the results in the test report.

TEST MODE:

Please refer to the clause 3.3

TEST RESULTS

 Passed Not Applicable

Modulation type	Channel	20 dB Bandwidth (MHz)	Limit (MHz)	Result
GFSK	00	0.93	-	Pass
	39	0.93		
	78	0.93		
$\pi/4$ DQPSK	00	1.30	-	Pass
	39	1.31		
	78	1.29		
8DPSK	00	1.29	-	Pass
	39	1.29		
	78	1.29		

Modulation Type:		GFSK																												
CH00	<table border="1"> <thead> <tr> <th>Type</th> <th>Ref</th> <th>Trc</th> <th>X-value</th> <th>Y-value</th> <th>Function</th> <th>Function Result</th> </tr> </thead> <tbody> <tr> <td>M1</td> <td>1</td> <td></td> <td>2.4015475 GHz</td> <td>-20.81 dBm</td> <td></td> <td></td> </tr> <tr> <td>M2</td> <td>1</td> <td></td> <td>2.4020575 GHz</td> <td>-0.26 dBm</td> <td></td> <td></td> </tr> <tr> <td>D3</td> <td>M1</td> <td>1</td> <td>927.5 kHz</td> <td>-0.56 dB</td> <td></td> <td></td> </tr> </tbody> </table>		Type	Ref	Trc	X-value	Y-value	Function	Function Result	M1	1		2.4015475 GHz	-20.81 dBm			M2	1		2.4020575 GHz	-0.26 dBm			D3	M1	1	927.5 kHz	-0.56 dB		
Type	Ref	Trc	X-value	Y-value	Function	Function Result																								
M1	1		2.4015475 GHz	-20.81 dBm																										
M2	1		2.4020575 GHz	-0.26 dBm																										
D3	M1	1	927.5 kHz	-0.56 dB																										
CH39	<table border="1"> <thead> <tr> <th>Type</th> <th>Ref</th> <th>Trc</th> <th>X-value</th> <th>Y-value</th> <th>Function</th> <th>Function Result</th> </tr> </thead> <tbody> <tr> <td>M1</td> <td>1</td> <td></td> <td>2.4405475 GHz</td> <td>-21.30 dBm</td> <td></td> <td></td> </tr> <tr> <td>M2</td> <td>1</td> <td></td> <td>2.4410575 GHz</td> <td>-0.52 dBm</td> <td></td> <td></td> </tr> <tr> <td>D3</td> <td>M1</td> <td>1</td> <td>927.5 kHz</td> <td>-0.40 dB</td> <td></td> <td></td> </tr> </tbody> </table>		Type	Ref	Trc	X-value	Y-value	Function	Function Result	M1	1		2.4405475 GHz	-21.30 dBm			M2	1		2.4410575 GHz	-0.52 dBm			D3	M1	1	927.5 kHz	-0.40 dB		
Type	Ref	Trc	X-value	Y-value	Function	Function Result																								
M1	1		2.4405475 GHz	-21.30 dBm																										
M2	1		2.4410575 GHz	-0.52 dBm																										
D3	M1	1	927.5 kHz	-0.40 dB																										
CH78	<table border="1"> <thead> <tr> <th>Type</th> <th>Ref</th> <th>Trc</th> <th>X-value</th> <th>Y-value</th> <th>Function</th> <th>Function Result</th> </tr> </thead> <tbody> <tr> <td>M1</td> <td>1</td> <td></td> <td>2.4795475 GHz</td> <td>-21.64 dBm</td> <td></td> <td></td> </tr> <tr> <td>M2</td> <td>1</td> <td></td> <td>2.4800575 GHz</td> <td>-0.74 dBm</td> <td></td> <td></td> </tr> <tr> <td>D3</td> <td>M1</td> <td>1</td> <td>927.5 kHz</td> <td>-0.23 dB</td> <td></td> <td></td> </tr> </tbody> </table>		Type	Ref	Trc	X-value	Y-value	Function	Function Result	M1	1		2.4795475 GHz	-21.64 dBm			M2	1		2.4800575 GHz	-0.74 dBm			D3	M1	1	927.5 kHz	-0.23 dB		
Type	Ref	Trc	X-value	Y-value	Function	Function Result																								
M1	1		2.4795475 GHz	-21.64 dBm																										
M2	1		2.4800575 GHz	-0.74 dBm																										
D3	M1	1	927.5 kHz	-0.23 dB																										

Modulation Type:		$\pi/4$ DQPSK																												
CH00	<p>CF 2.402 GHz 1001 pts Span 2.5 MHz</p> <table border="1"> <thead> <tr> <th>Type</th> <th>Ref</th> <th>Trc</th> <th>X-value</th> <th>Y-value</th> <th>Function</th> <th>Function Result</th> </tr> </thead> <tbody> <tr> <td>M1</td> <td>1</td> <td></td> <td>2.40136 GHz</td> <td>-19.10 dBm</td> <td></td> <td></td> </tr> <tr> <td>M2</td> <td>1</td> <td></td> <td>2.402165 GHz</td> <td>0.91 dBm</td> <td></td> <td></td> </tr> <tr> <td>D3</td> <td>M1</td> <td>1</td> <td>1.295 MHz</td> <td>-0.33 dB</td> <td></td> <td></td> </tr> </tbody> </table>		Type	Ref	Trc	X-value	Y-value	Function	Function Result	M1	1		2.40136 GHz	-19.10 dBm			M2	1		2.402165 GHz	0.91 dBm			D3	M1	1	1.295 MHz	-0.33 dB		
Type	Ref	Trc	X-value	Y-value	Function	Function Result																								
M1	1		2.40136 GHz	-19.10 dBm																										
M2	1		2.402165 GHz	0.91 dBm																										
D3	M1	1	1.295 MHz	-0.33 dB																										
CH39	<p>CF 2.441 GHz 1001 pts Span 2.5 MHz</p> <table border="1"> <thead> <tr> <th>Type</th> <th>Ref</th> <th>Trc</th> <th>X-value</th> <th>Y-value</th> <th>Function</th> <th>Function Result</th> </tr> </thead> <tbody> <tr> <td>M1</td> <td>1</td> <td></td> <td>2.44035 GHz</td> <td>-19.11 dBm</td> <td></td> <td></td> </tr> <tr> <td>M2</td> <td>1</td> <td></td> <td>2.441165 GHz</td> <td>0.93 dBm</td> <td></td> <td></td> </tr> <tr> <td>D3</td> <td>M1</td> <td>1</td> <td>1.305 MHz</td> <td>-0.26 dB</td> <td></td> <td></td> </tr> </tbody> </table>		Type	Ref	Trc	X-value	Y-value	Function	Function Result	M1	1		2.44035 GHz	-19.11 dBm			M2	1		2.441165 GHz	0.93 dBm			D3	M1	1	1.305 MHz	-0.26 dB		
Type	Ref	Trc	X-value	Y-value	Function	Function Result																								
M1	1		2.44035 GHz	-19.11 dBm																										
M2	1		2.441165 GHz	0.93 dBm																										
D3	M1	1	1.305 MHz	-0.26 dB																										
CH78	<p>CF 2.48 GHz 1001 pts Span 2.5 MHz</p> <table border="1"> <thead> <tr> <th>Type</th> <th>Ref</th> <th>Trc</th> <th>X-value</th> <th>Y-value</th> <th>Function</th> <th>Function Result</th> </tr> </thead> <tbody> <tr> <td>M1</td> <td>1</td> <td></td> <td>2.4793675 GHz</td> <td>-19.68 dBm</td> <td></td> <td></td> </tr> <tr> <td>M2</td> <td>1</td> <td></td> <td>2.480165 GHz</td> <td>0.48 dBm</td> <td></td> <td></td> </tr> <tr> <td>D3</td> <td>M1</td> <td>1</td> <td>1.2875 MHz</td> <td>-0.16 dB</td> <td></td> <td></td> </tr> </tbody> </table>		Type	Ref	Trc	X-value	Y-value	Function	Function Result	M1	1		2.4793675 GHz	-19.68 dBm			M2	1		2.480165 GHz	0.48 dBm			D3	M1	1	1.2875 MHz	-0.16 dB		
Type	Ref	Trc	X-value	Y-value	Function	Function Result																								
M1	1		2.4793675 GHz	-19.68 dBm																										
M2	1		2.480165 GHz	0.48 dBm																										
D3	M1	1	1.2875 MHz	-0.16 dB																										

Modulation Type:		8DPSK																												
CH00	<p>CF 2.402 GHz 1001 pts Span 2.5 MHz</p> <table border="1"> <thead> <tr> <th>Type</th> <th>Ref</th> <th>Trc</th> <th>X-value</th> <th>Y-value</th> <th>Function</th> <th>Function Result</th> </tr> </thead> <tbody> <tr> <td>M1</td> <td>1</td> <td></td> <td>2.401355 GHz</td> <td>-18.91 dBm</td> <td></td> <td></td> </tr> <tr> <td>M2</td> <td>1</td> <td></td> <td>2.4021625 GHz</td> <td>1.46 dBm</td> <td></td> <td></td> </tr> <tr> <td>D3</td> <td>M1</td> <td>1</td> <td>1.2875 MHz</td> <td>0.33 dB</td> <td></td> <td></td> </tr> </tbody> </table>		Type	Ref	Trc	X-value	Y-value	Function	Function Result	M1	1		2.401355 GHz	-18.91 dBm			M2	1		2.4021625 GHz	1.46 dBm			D3	M1	1	1.2875 MHz	0.33 dB		
Type	Ref	Trc	X-value	Y-value	Function	Function Result																								
M1	1		2.401355 GHz	-18.91 dBm																										
M2	1		2.4021625 GHz	1.46 dBm																										
D3	M1	1	1.2875 MHz	0.33 dB																										
CH39	<p>CF 2.441 GHz 1001 pts Span 2.5 MHz</p> <table border="1"> <thead> <tr> <th>Type</th> <th>Ref</th> <th>Trc</th> <th>X-value</th> <th>Y-value</th> <th>Function</th> <th>Function Result</th> </tr> </thead> <tbody> <tr> <td>M1</td> <td>1</td> <td></td> <td>2.440355 GHz</td> <td>-18.51 dBm</td> <td></td> <td></td> </tr> <tr> <td>M2</td> <td>1</td> <td></td> <td>2.4411625 GHz</td> <td>1.53 dBm</td> <td></td> <td></td> </tr> <tr> <td>D3</td> <td>M1</td> <td>1</td> <td>1.2925 MHz</td> <td>-0.15 dB</td> <td></td> <td></td> </tr> </tbody> </table>		Type	Ref	Trc	X-value	Y-value	Function	Function Result	M1	1		2.440355 GHz	-18.51 dBm			M2	1		2.4411625 GHz	1.53 dBm			D3	M1	1	1.2925 MHz	-0.15 dB		
Type	Ref	Trc	X-value	Y-value	Function	Function Result																								
M1	1		2.440355 GHz	-18.51 dBm																										
M2	1		2.4411625 GHz	1.53 dBm																										
D3	M1	1	1.2925 MHz	-0.15 dB																										
CH78	<p>CF 2.48 GHz 1001 pts Span 2.5 MHz</p> <table border="1"> <thead> <tr> <th>Type</th> <th>Ref</th> <th>Trc</th> <th>X-value</th> <th>Y-value</th> <th>Function</th> <th>Function Result</th> </tr> </thead> <tbody> <tr> <td>M1</td> <td>1</td> <td></td> <td>2.479355 GHz</td> <td>-19.24 dBm</td> <td></td> <td></td> </tr> <tr> <td>M2</td> <td>1</td> <td></td> <td>2.4801625 GHz</td> <td>1.16 dBm</td> <td></td> <td></td> </tr> <tr> <td>D3</td> <td>M1</td> <td>1</td> <td>1.29 MHz</td> <td>0.23 dB</td> <td></td> <td></td> </tr> </tbody> </table>		Type	Ref	Trc	X-value	Y-value	Function	Function Result	M1	1		2.479355 GHz	-19.24 dBm			M2	1		2.4801625 GHz	1.16 dBm			D3	M1	1	1.29 MHz	0.23 dB		
Type	Ref	Trc	X-value	Y-value	Function	Function Result																								
M1	1		2.479355 GHz	-19.24 dBm																										
M2	1		2.4801625 GHz	1.16 dBm																										
D3	M1	1	1.29 MHz	0.23 dB																										

5.5. Carrier Frequencies Separation

LIMIT

FCC CFR Title 47 Part 15 Subpart C Section 15.247 (a)(1):

Frequency hopping systems shall have hopping channel carrier frequencies separated by a minimum of 25 kHz or the 20 dB bandwidth of the hopping channel, whichever is greater. Alternatively, Frequency hopping systems operating in the 2400-2483.5 MHz band may have hopping channel carrier frequencies that are separated by 25 kHz or two-thirds of the 20 dB bandwidth of the hopping channel, whichever is greater, provided the systems operate with an output power no greater than 125 mW.

TEST CONFIGURATION

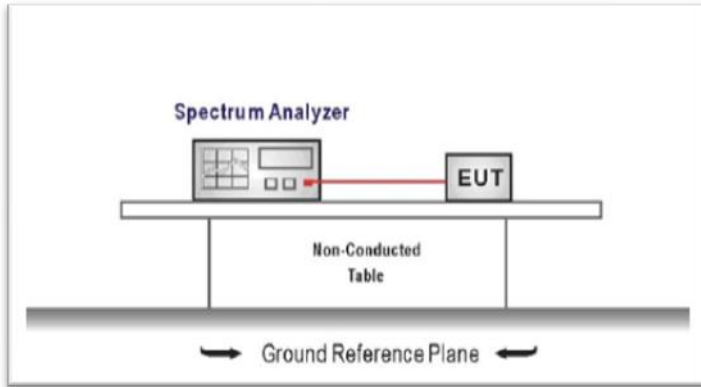

TEST PROCEDURE

1. The transmitter output was connected to the spectrum analyzer through an attenuator, the path loss was compensated to the results for each measurement.
2. Set to the maximum power setting and enable the EUT transmit continuously
3. Use the following spectrum analyzer settings:
 Span = wide enough to capture the peaks of two adjacent channels
 RBW ≥ 1% of the span, VBW ≥ RBW
 Sweep = auto, Detector function = peak, Trace = max hold
4. Measure and record the results in the test report.

TEST MODE:

Please refer to the clause 3.3

TEST RESULTS

Passed Not Applicable

Modulation type	Channel	Carrier Frequencies Separation (MHz)	Limit (MHz) *	Result
GFSK	39	1.00	≥0.932	Pass
π/4DQPSK	39	1.00	≥0.861	Pass
8DPSK	39	1.00	≥0.854	Pass

Note:

*: GFSK limit = The maximum 20 dB Bandwidth for GFSK modulation on the section 5.4.

π/4DQPSK limit = 2/3 * The maximum 20 dB Bandwidth for π/4DQPSK modulation on the section 5.4.

8DPSK limit = 2/3 * The maximum 20 dB Bandwidth for 8DPSK modulation on the section 5.4

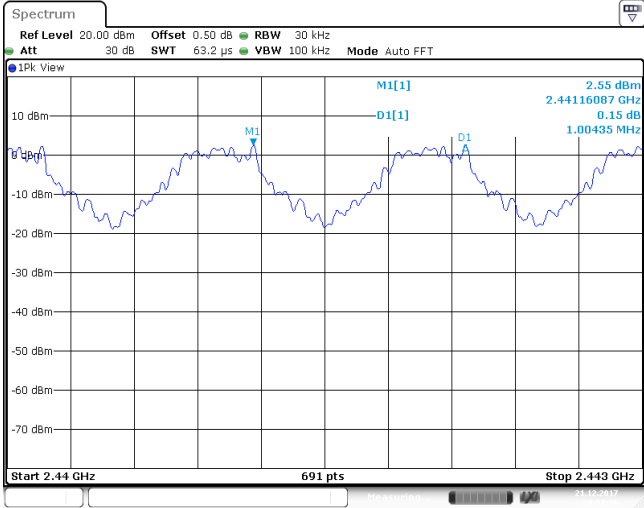
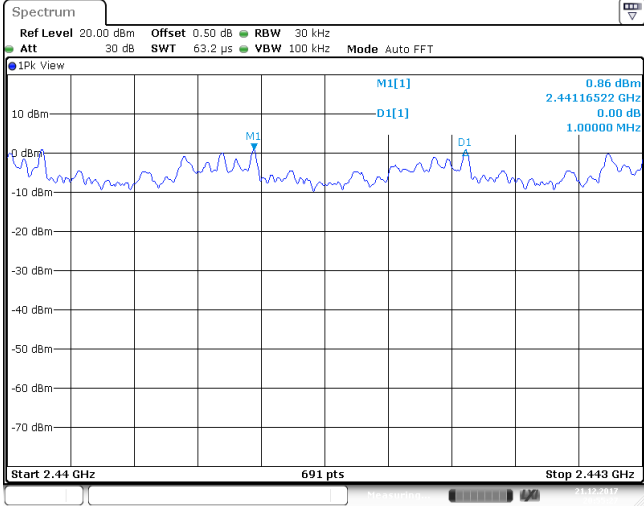
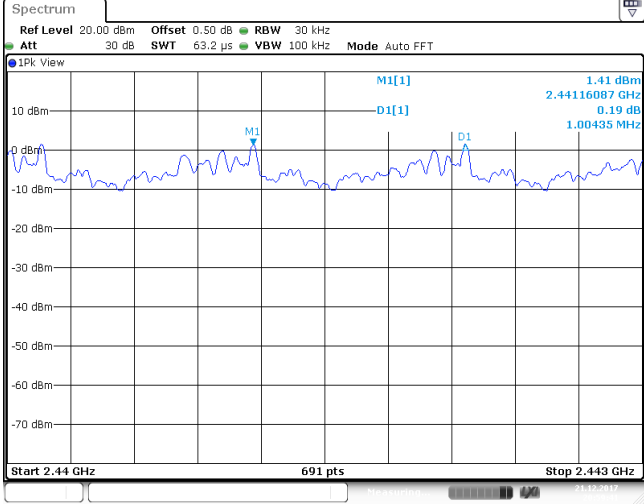
<p>GFSK</p>	
<p>$\pi/4$DQPSK</p>	
<p>8DPSK</p>	

5.6. Hopping Channel Number

LIMIT

FCC CFR Title 47 Part 15 Subpart C Section 15.247 (a)(1):Frequency hopping systems in the 2400–2483.5 MHz band shall use at least **15** channels.

TEST CONFIGURATION

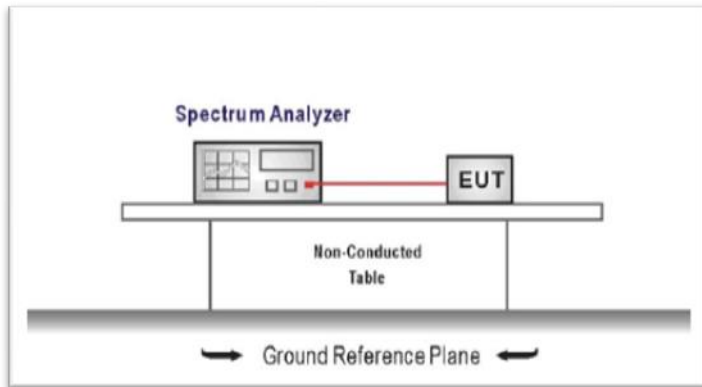

TEST PROCEDURE

1. The transmitter output was connected to the spectrum analyzer through an attenuator, the path loss was compensated to the results for each measurement.
2. Set to the maximum power setting and enable the EUT transmit continuously
3. Use the following spectrum analyzer settings:
 Span = the frequency band of operation
 RBW \geq 1% of the span, VBW \geq RBW
 Sweep = auto, Detector function = peak, Trace = max hold
4. Measure and record the results in the test report.

TEST MODE:

Please refer to the clause 3.3

TEST RESULTS

Passed Not Applicable

Modulation type	Channel number	Limit	Result
GFSK	79	≥ 15.00	Pass
$\pi/4$ DQPSK	79		
8DPSK	79		

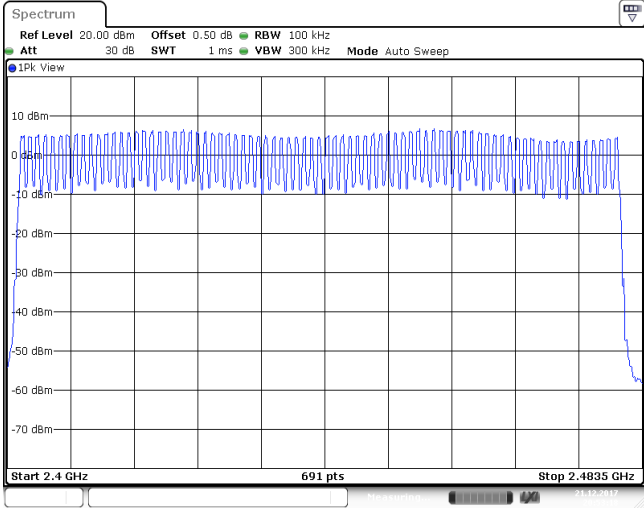
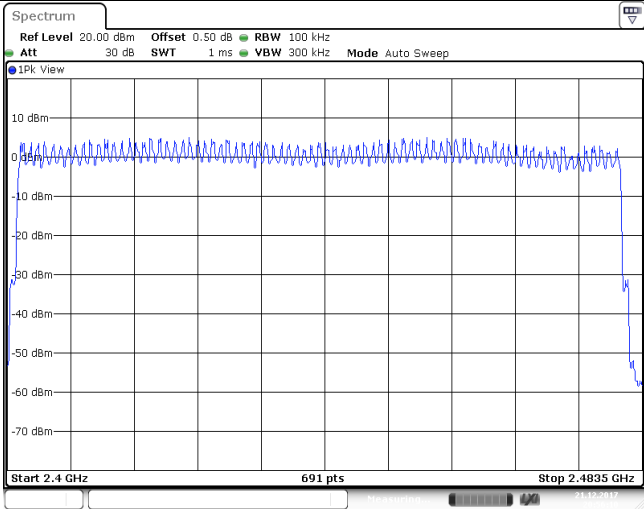
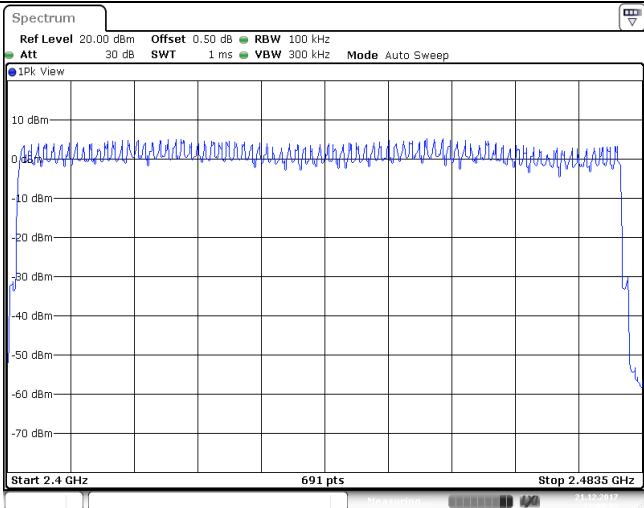
<p>GFSK</p>	
<p>$\pi/4$DQPSK</p>	
<p>8DPSK</p>	

5.7. Dwell Time

LIMIT

FCC CFR Title 47 Part 15 Subpart C Section 15.247 (a)(1):The average time of occupancy on any channel shall not be greater than 0.4 seconds within a pe-riod of 0.4 seconds multiplied by the number of hopping channels employed.

TEST CONFIGURATION

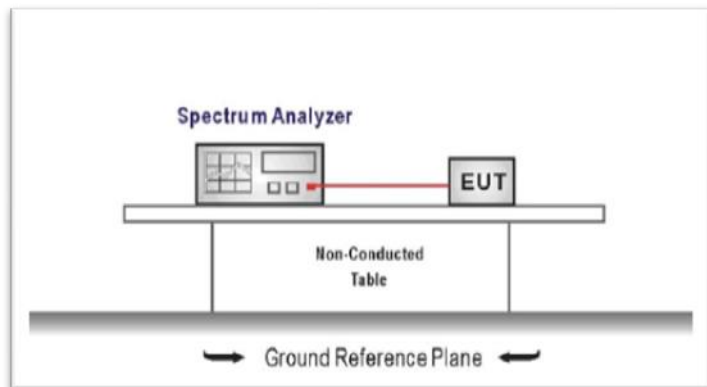

TEST PROCEDURE

1. The transmitter output was connected to the spectrum analyzer through an attenuator, the path loss was compensated to the results for each measurement.
2. Set to the maximum power setting and enable the EUT transmit continuously
3. Use the following spectrum analyzer settings:
 Span = zero span, centered on a hopping channel, RBW= 1 MHz, VBW ≥ RBW
 Sweep = as necessary to capture the entire dwell time per hopping channel,
 Detector function = peak, Trace = max hold
4. Measure and record the results in the test report.

TEST MODE:

Please refer to the clause 3.3

TEST RESULTS

Passed Not Applicable

Modulation type	Channel	Burst Width [ms/hop/ch]	Total Hops[hop*ch]	Dwell time (Second)	Limit (Second)	Result
GFSK	DH1	0.37	316.00	0.12	≤ 0.40	Pass
	DH3	1.63	162.00	0.26		
	DH5	2.87	108.00	0.31		
π/4DQPSK	2DH1	0.38	315.00	0.12	≤ 0.40	Pass
	2DH3	1.63	160.00	0.26		
	2DH5	2.88	107.00	0.31		
8DPSK	3DH1	0.38	314.00	0.12	≤ 0.40	Pass
	3DH3	1.63	158.00	0.26		
	3DH5	2.88	110.00	0.32		

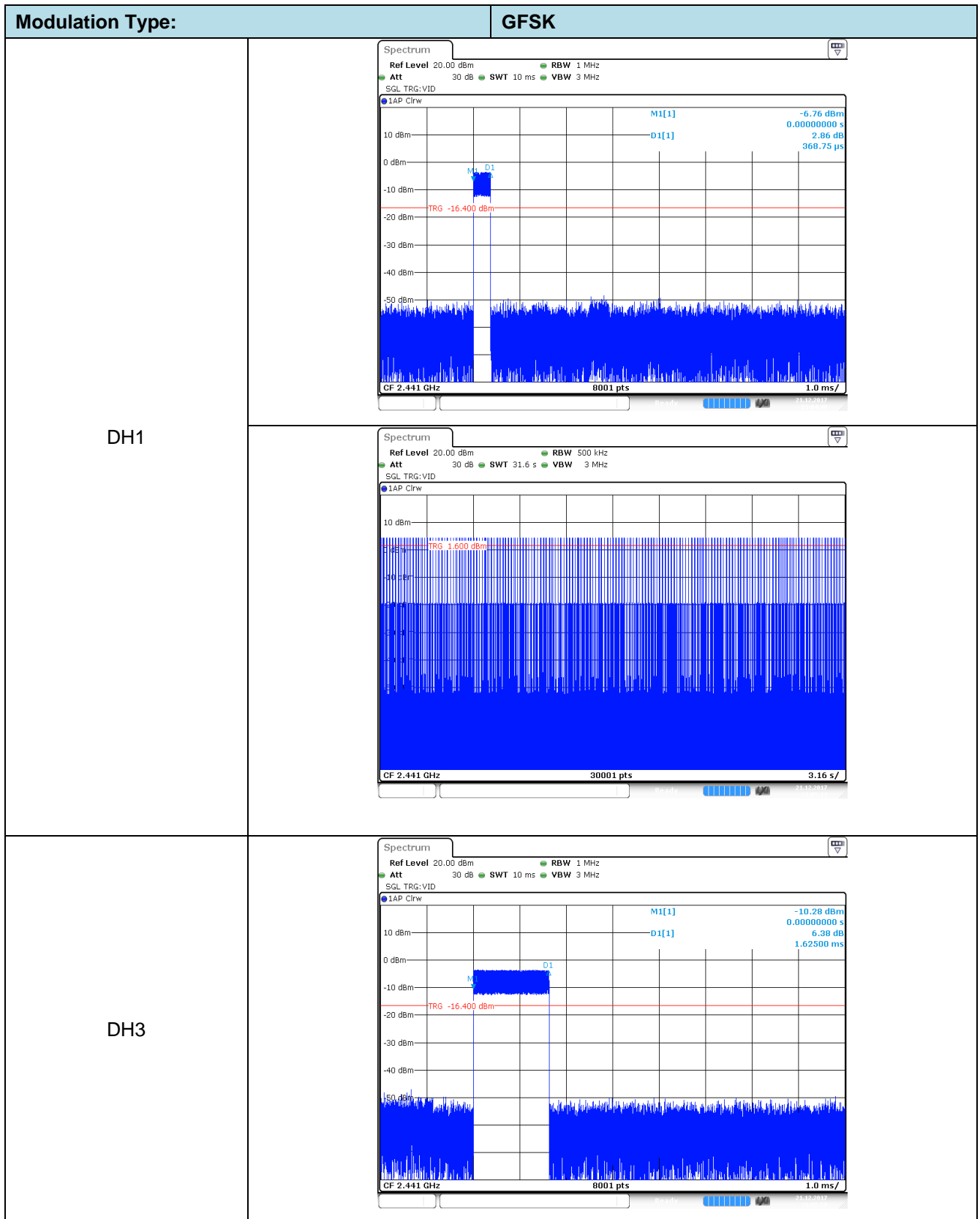

DH5

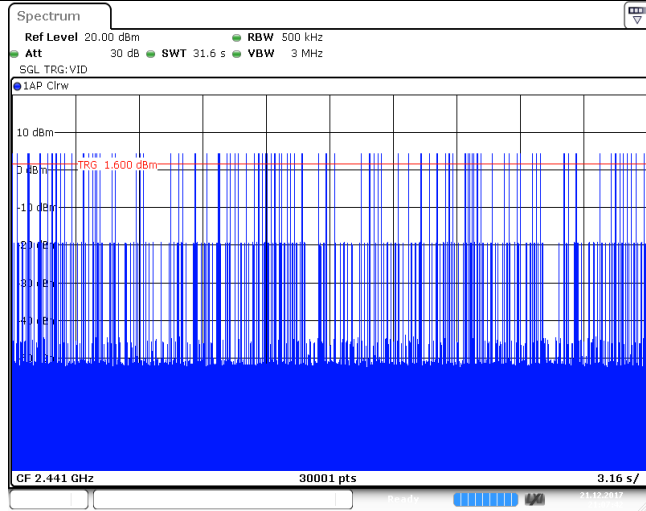
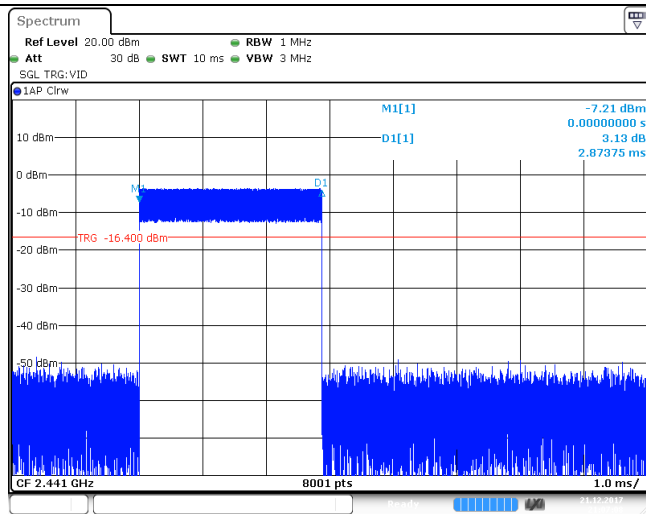
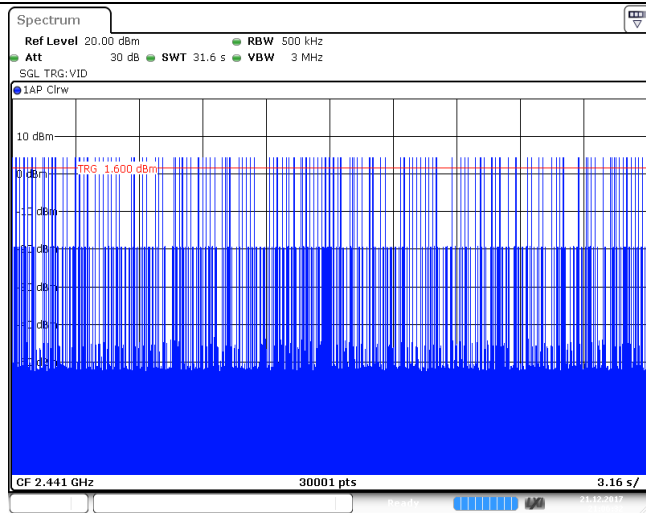

Modulation Type: $\pi/4$ DQPSK	
2DH1	
2DH3	

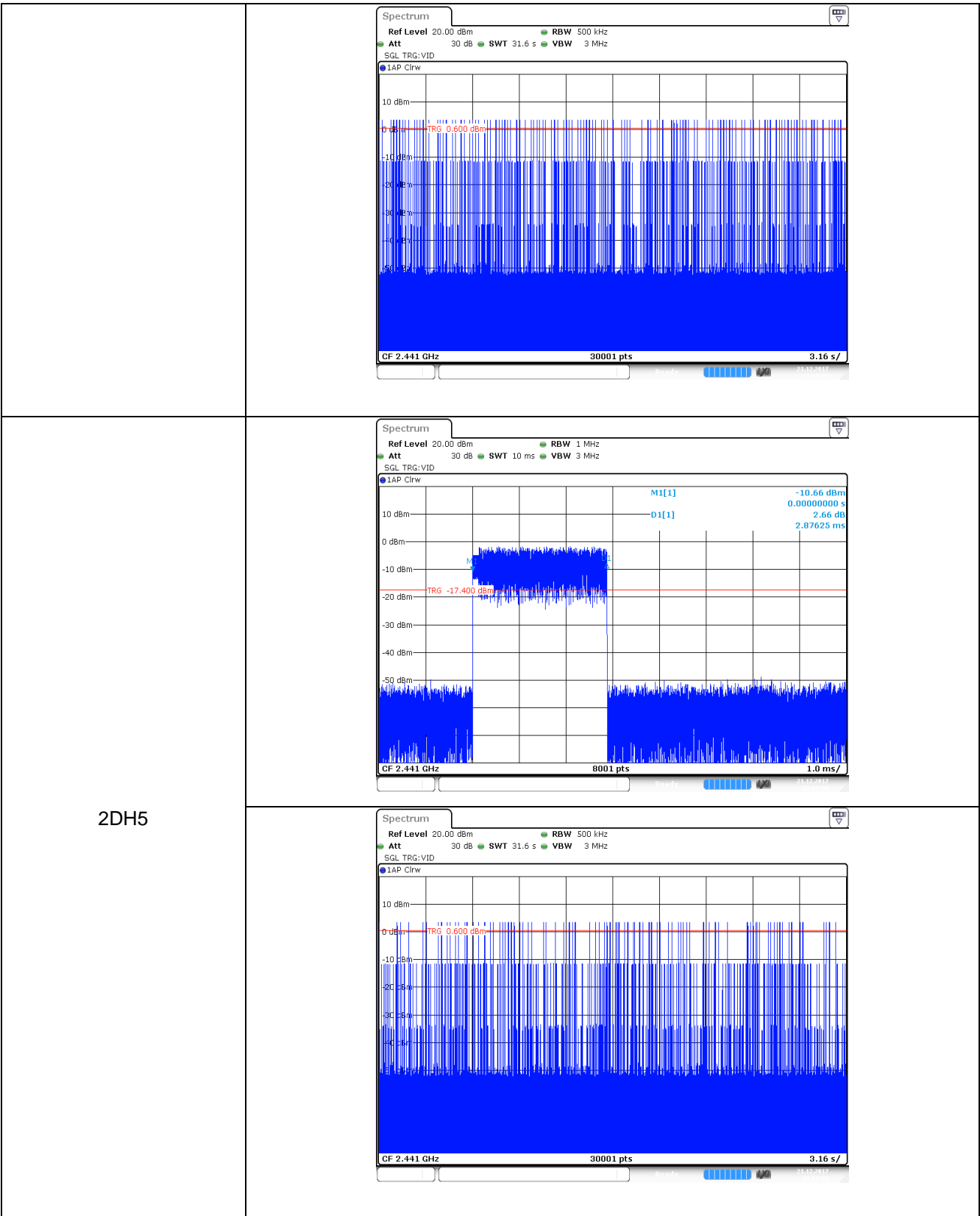

Modulation Type: 8DPSK

3DH1

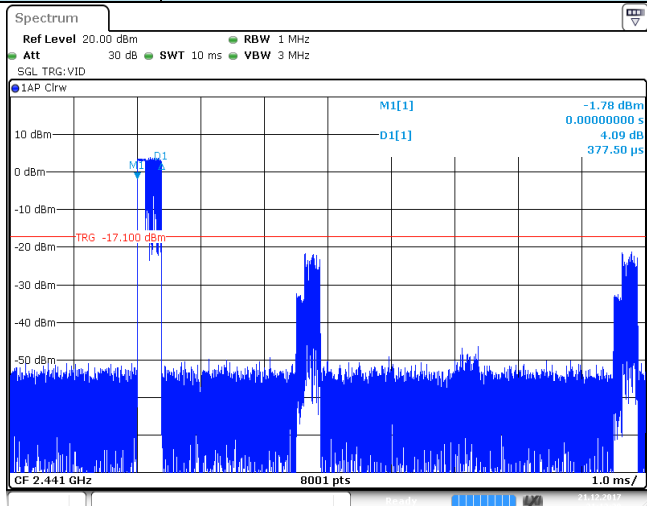

3DH2

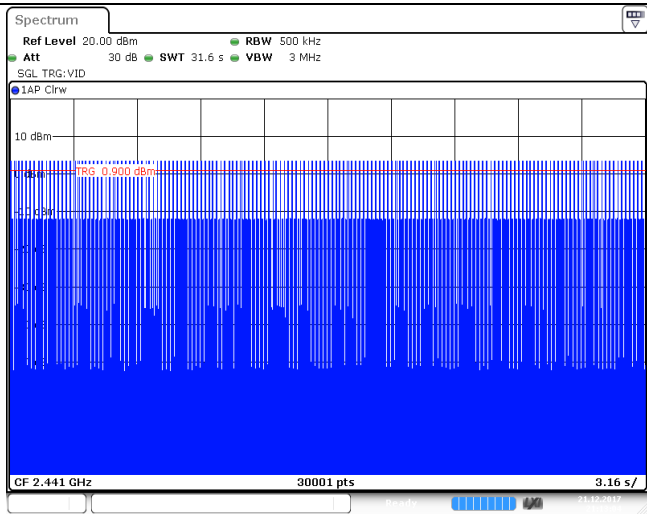

3DH3

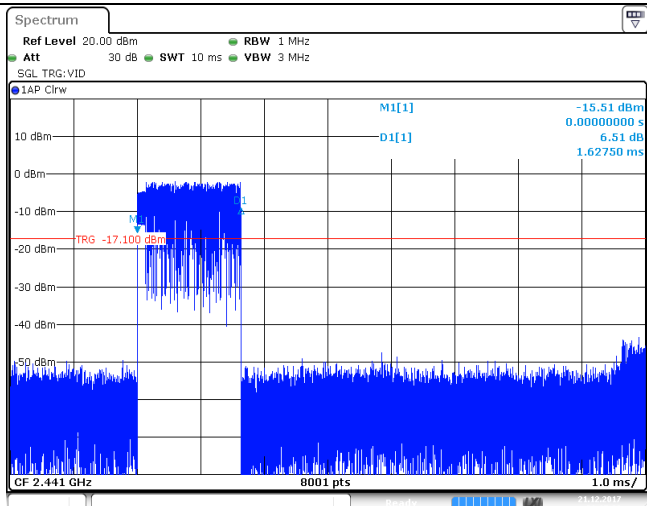

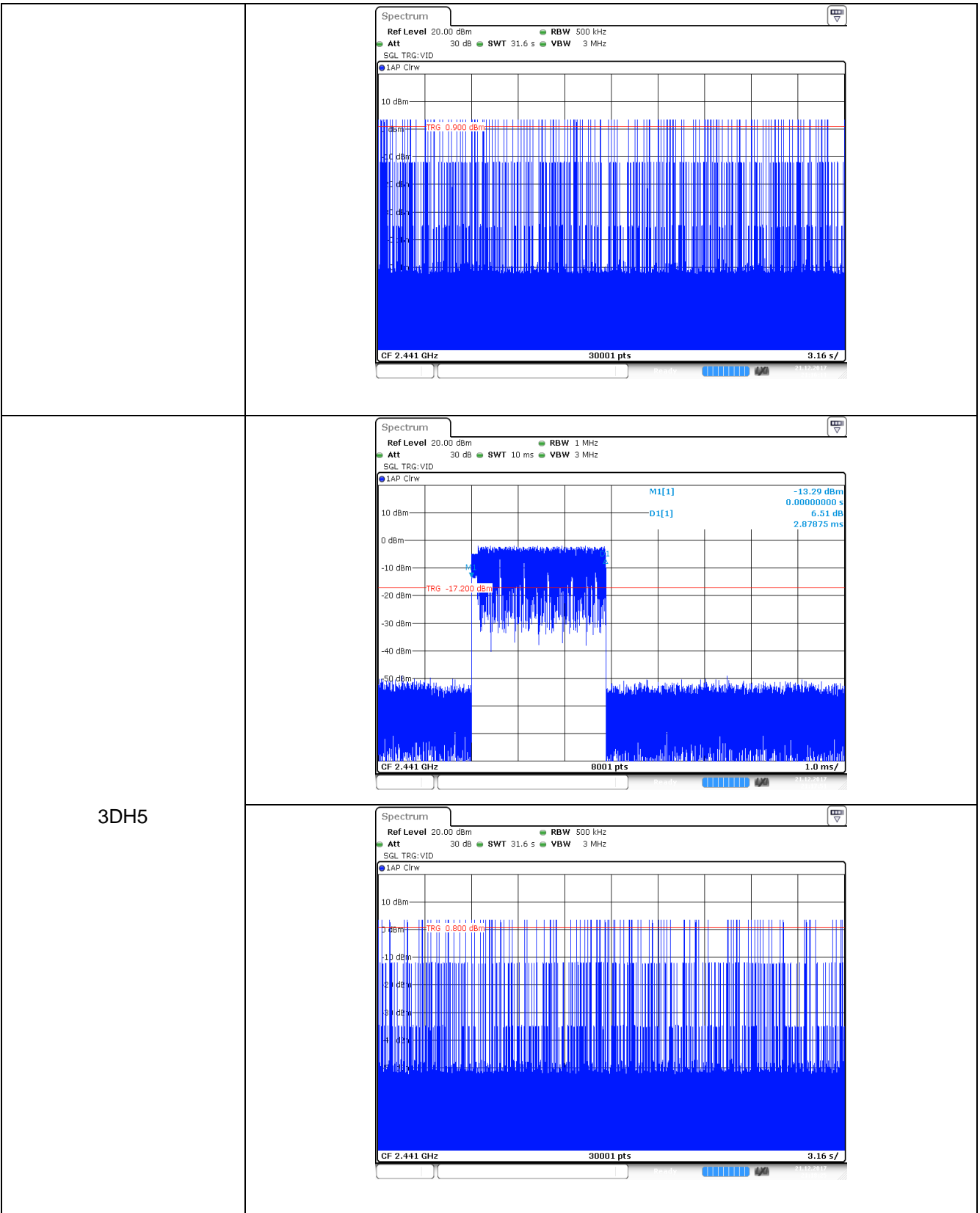

5.8. Pseudorandom Frequency Hopping Sequence

LIMIT

FCC CFR Title 47 Part 15 Subpart C Section 15.247 (a)(1):Frequency hopping systems shall have hopping channel carrier frequencies separated by a minimum of 25 kHz or the 20 dB bandwidth of the hopping channel, whichever is greater. Alternatively, frequency hopping systems operating in the 2400–2483.5 MHz band may have hopping channel carrier frequencies that are separated by 25 kHz or two-thirds of the 20 dB bandwidth of the hopping channel, whichever is greater, provided the systems operate with an output power no greater than 125 mW. The system shall hop to channel frequencies that are selected at the system hopping rate from a pseudo randomly ordered list of hopping frequencies. Each frequency must be used equally on the average by each transmitter. The system receivers shall have input bandwidths that match the hopping channel bandwidths of their corresponding transmitters and shall shift frequencies in synchronization with the transmitted signals.

TEST RESULTS

The pseudorandom frequency hopping sequence may be generated in a nine-stage shift register whose 5th and 9th stage outputs are added in a modulo-two addition stage. And the result is fed back to the input of the first stage. The sequence begins with the first one of 9 consecutive ones, for example: the shift register is initialized with nine ones.

- Number of shift register stages: 9
- Length of pseudo-random sequence: $2^9 - 1 = 511$ bits
- Longest sequence of zeros: 8 (non-inverted signal)

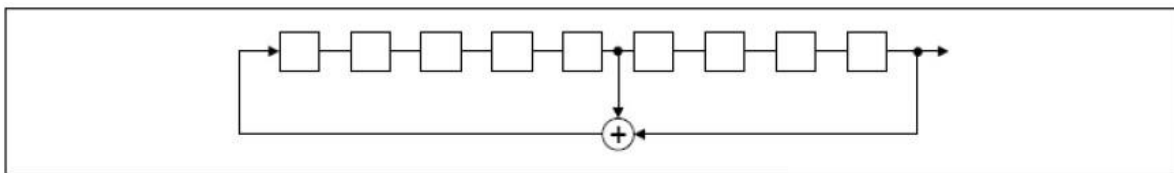

Linear Feedback Shift Register for Generation of the PRBS sequence

An example of pseudorandom frequency hopping sequence as follows:

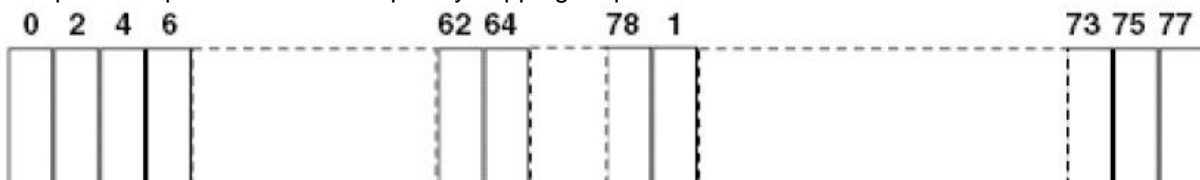

Each frequency used equally one the average by each transmitter. The system receiver have input bandwidths that match the hopping channel bandwidths of their corresponding transmitter and shift frequencies in synchronization with the transmitted signals.

5.9. Restricted band (radiated)

LIMIT

FCC CFR Title 47 Part 15 Subpart C Section 15.247 (d):

In any 100 kHz bandwidth outside the frequency band in which the spread spectrum or digitally modulated intentional radiator is operating, Radiated Emissions which fall in the restricted bands, as defined in §15.205(a), must also comply with the Radiated Emissions limits specified in §15.209(a) (see §15.205(c)).

TEST CONFIGURATION

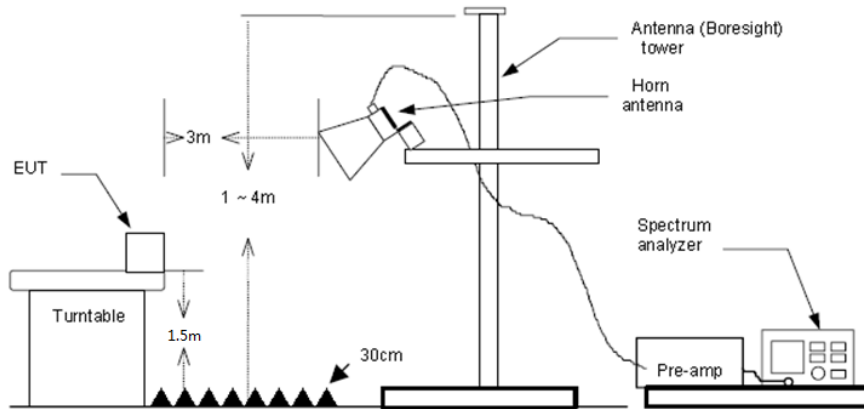

TEST PROCEDURE

1. The EUT was setup and tested according to ANSI C63.10:2013 for compliance to FCC 47CFR 15.247 requirements.
2. The EUT is placed on a turn table which is 1.5 meter above ground. The turn table is rotated 360 degrees to determine the position of the maximum emission level.
3. The EUT was positioned such that the distance from antenna to the EUT was 3 meters.
4. The antenna is scanned from 1 meter to 4 meters to find out the maximum emission level. This is repeated for both horizontal and vertical polarization of the antenna. In order to find the maximum emission, all of the interface cables were manipulated according to ANSI C63.10:2013 on radiated measurement.
5. The receiver set as follow:
 RBW=1 MHz, VBW=3 MHz Peak detector for Peak value
 RBW=1 MHz, VBW=10 Hz Peak detector for Average value.

TEST MODE:

Please refer to the clause 3.3

TEST RESULTS

Passed Not Applicable

Note:

- 1) Final level= Read level + Antenna Factor+ Cable Loss- Preamp Factor
- 2) Have pre-scan all modulation mode, found the GFSK modulation which it was worst case, so only the worst case's data on the test report.
- 3) The peak level is lower than average limit(54 dBuV/m), this data is the too weak instrument of signal is unable to test.

CH00									
Frequency (MHz)	Read Level (dBuV)	Antenna Factor (dB/m)	Cable Loss (dB)	Preamp Factor (dB)	Level (dBuV/m)	Limit Line (dBuV/m)	Over Limit (dB)	Polarization	Test value
2310.00	32.28	28.05	6.62	37.65	29.30	74.00	-44.70	Horizontal	Peak
2328.99	37.58	27.95	6.65	37.70	34.48	74.00	-39.52	Horizontal	Peak
2390.03	32.24	27.65	6.75	37.87	28.77	74.00	-45.23	Horizontal	Peak
2310.00	31.89	28.05	6.62	37.65	28.91	74.00	-45.09	Vertical	Peak
2329.47	36.47	27.95	6.65	37.70	33.37	74.00	-40.63	Vertical	Peak
2390.03	33.14	27.65	6.75	37.87	29.67	74.00	-44.33	Vertical	Peak
2310.00	20.72	28.05	6.62	37.65	17.74	54.00	-36.26	Horizontal	Average
2390.03	20.25	27.65	6.75	37.87	16.78	54.00	-37.22	Horizontal	Average
2310.00	20.50	28.05	6.62	37.65	17.52	54.00	-36.48	Vertical	Average
2390.03	20.68	27.65	6.75	37.87	17.21	54.00	-36.79	Vertical	Average

CH78									
Frequency (MHz)	Read Level (dBuV)	Antenna Factor (dB/m)	Cable Loss (dB)	Preamp Factor (dB)	Level (dBuV/m)	Limit Line (dBuV/m)	Over Limit (dB)	Polarization	Test value
2483.50	54.63	27.26	6.83	37.87	50.85	74.00	-23.15	Horizontal	Peak
2500.00	32.59	27.20	6.84	37.87	28.76	74.00	-45.24	Horizontal	Peak
2483.50	54.75	27.26	6.83	37.87	50.97	74.00	-23.03	Vertical	Peak
2500.00	35.40	27.20	6.84	37.87	31.57	74.00	-42.43	Vertical	Peak
2483.50	23.75	27.26	6.83	37.87	19.97	54.00	-34.03	Horizontal	Average
2500.00	20.46	27.20	6.84	37.87	16.63	54.00	-37.37	Horizontal	Average
2483.50	23.34	27.26	6.83	37.87	19.56	54.00	-34.44	Vertical	Average
2500.00	19.86	27.20	6.84	37.87	16.03	54.00	-37.97	Vertical	Average

5.10. Band edge and Spurious Emissions (conducted)

LIMIT

FCC CFR Title 47 Part 15 Subpart C Section 15.247 (d): In any 100 kHz bandwidth outside the frequency band in which the spread spectrum intentional radiator is operating, the radio frequency power that is produced by the intentional radiator shall be at least 20 dB below that in the 100 kHz bandwidth within the band that contains the highest level of the desired power, based on either an RF conducted or a radiated measurement.

TEST CONFIGURATION

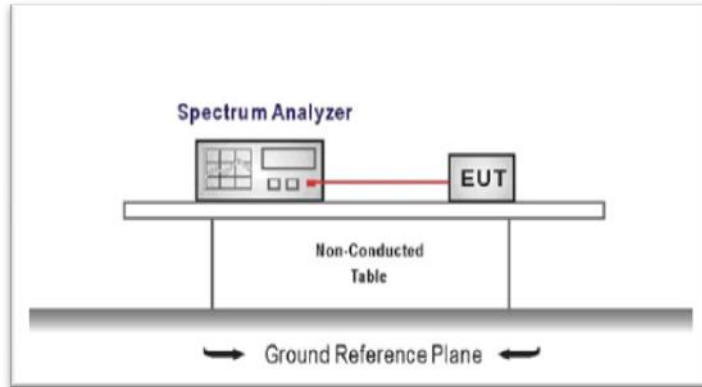

TEST PROCEDURE

1. The transmitter output was connected to the spectrum analyzer through an attenuator, the path loss was compensated to the results for each measurement.
2. Set to the maximum power setting and enable the EUT transmit continuously
3. Use the following spectrum analyzer settings:
RBW = 100 kHz, VBW \geq RBW, scan up through 10th harmonic.
Sweep = auto, Detector function = peak, Trace = max hold
4. Measure and record the results in the test report.

TEST MODE:

Please refer to the clause 3.3

TEST RESULTS

Passed Not Applicable

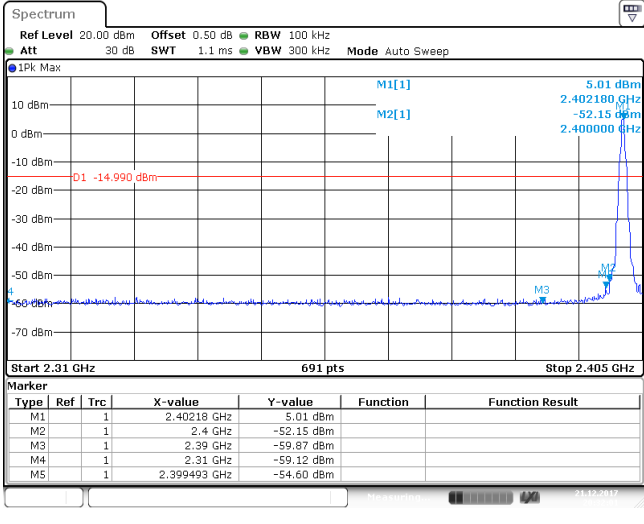
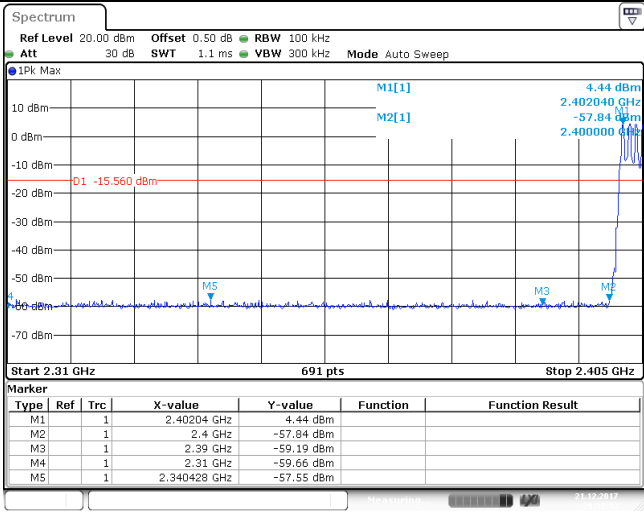
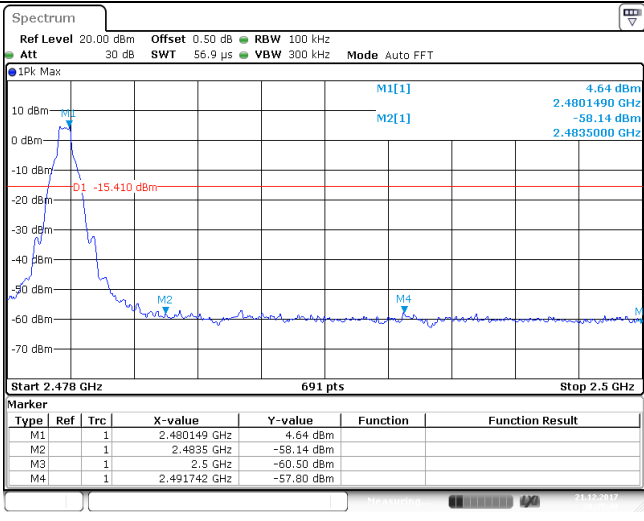
Test Item:	Band edge	Modulation type:	GFSK
<p>CH00 No hopping mode</p>			
<p>CH00 Hopping mode</p>			
<p>CH78 No hopping mode</p>			

CH78
Hopping mode

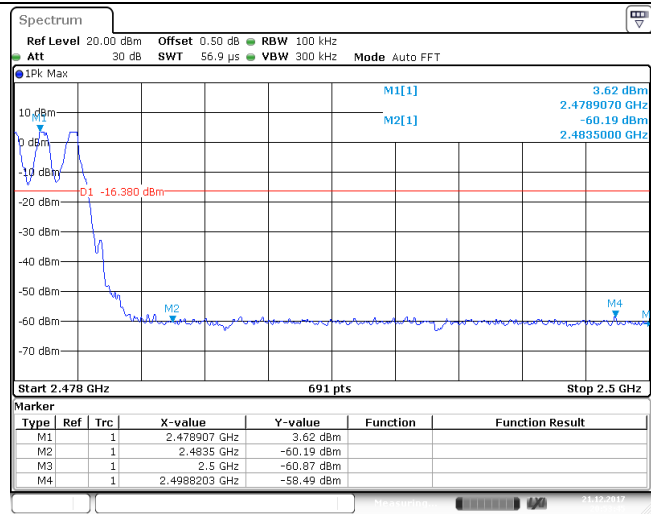

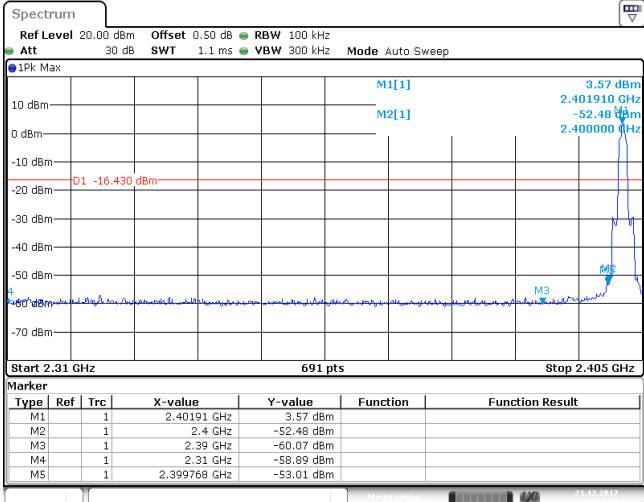
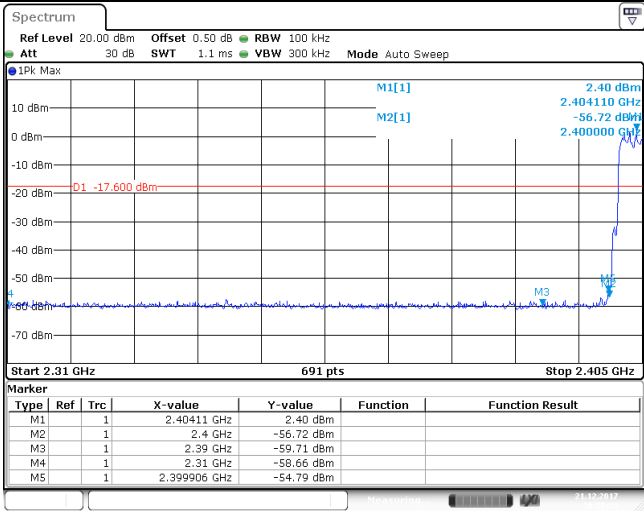
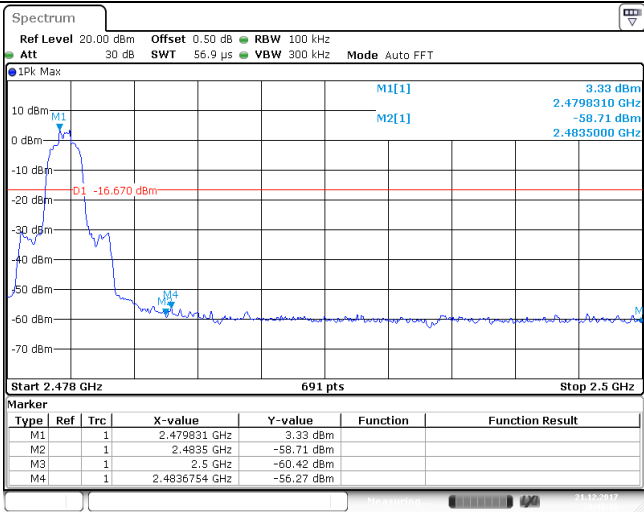
Test Item:	Band edge	Modulation type:	$\pi/4$ DQPSK																																										
<p>CH00 No hopping mode</p>	 <p>Spectrum</p> <p>Ref Level 20.00 dBm Offset 0.50 dB RBW 100 kHz Att 30 dB SWT 1.1 ms VBW 300 kHz Mode Auto Sweep</p> <p>1Pk Max</p> <p>M1[1] 3.57 dBm 2.40191 GHz M2[1] -52.48 dBm 2.400000 GHz</p> <p>D1 -16.430 dBm</p> <p>Start 2.31 GHz 691 pts Stop 2.405 GHz</p> <table border="1"> <thead> <tr> <th>Type</th> <th>Ref</th> <th>Trc</th> <th>X-value</th> <th>Y-value</th> <th>Function</th> <th>Function Result</th> </tr> </thead> <tbody> <tr> <td>M1</td> <td>1</td> <td></td> <td>2.40191 GHz</td> <td>3.57 dBm</td> <td></td> <td></td> </tr> <tr> <td>M2</td> <td>1</td> <td></td> <td>2.4 GHz</td> <td>-52.48 dBm</td> <td></td> <td></td> </tr> <tr> <td>M3</td> <td>1</td> <td></td> <td>2.39 GHz</td> <td>-60.07 dBm</td> <td></td> <td></td> </tr> <tr> <td>M4</td> <td>1</td> <td></td> <td>2.31 GHz</td> <td>-58.89 dBm</td> <td></td> <td></td> </tr> <tr> <td>M5</td> <td>1</td> <td></td> <td>2.399768 GHz</td> <td>-53.01 dBm</td> <td></td> <td></td> </tr> </tbody> </table>			Type	Ref	Trc	X-value	Y-value	Function	Function Result	M1	1		2.40191 GHz	3.57 dBm			M2	1		2.4 GHz	-52.48 dBm			M3	1		2.39 GHz	-60.07 dBm			M4	1		2.31 GHz	-58.89 dBm			M5	1		2.399768 GHz	-53.01 dBm		
Type	Ref	Trc	X-value	Y-value	Function	Function Result																																							
M1	1		2.40191 GHz	3.57 dBm																																									
M2	1		2.4 GHz	-52.48 dBm																																									
M3	1		2.39 GHz	-60.07 dBm																																									
M4	1		2.31 GHz	-58.89 dBm																																									
M5	1		2.399768 GHz	-53.01 dBm																																									
<p>CH00 Hopping mode</p>	 <p>Spectrum</p> <p>Ref Level 20.00 dBm Offset 0.50 dB RBW 100 kHz Att 30 dB SWT 1.1 ms VBW 300 kHz Mode Auto Sweep</p> <p>1Pk Max</p> <p>M1[1] 2.40 dBm 2.40411 GHz M2[1] -56.72 dBm 2.400000 GHz</p> <p>D1 -17.600 dBm</p> <p>Start 2.31 GHz 691 pts Stop 2.405 GHz</p> <table border="1"> <thead> <tr> <th>Type</th> <th>Ref</th> <th>Trc</th> <th>X-value</th> <th>Y-value</th> <th>Function</th> <th>Function Result</th> </tr> </thead> <tbody> <tr> <td>M1</td> <td>1</td> <td></td> <td>2.40411 GHz</td> <td>2.40 dBm</td> <td></td> <td></td> </tr> <tr> <td>M2</td> <td>1</td> <td></td> <td>2.4 GHz</td> <td>-56.72 dBm</td> <td></td> <td></td> </tr> <tr> <td>M3</td> <td>1</td> <td></td> <td>2.39 GHz</td> <td>-59.71 dBm</td> <td></td> <td></td> </tr> <tr> <td>M4</td> <td>1</td> <td></td> <td>2.31 GHz</td> <td>-58.66 dBm</td> <td></td> <td></td> </tr> <tr> <td>M5</td> <td>1</td> <td></td> <td>2.399906 GHz</td> <td>-54.79 dBm</td> <td></td> <td></td> </tr> </tbody> </table>			Type	Ref	Trc	X-value	Y-value	Function	Function Result	M1	1		2.40411 GHz	2.40 dBm			M2	1		2.4 GHz	-56.72 dBm			M3	1		2.39 GHz	-59.71 dBm			M4	1		2.31 GHz	-58.66 dBm			M5	1		2.399906 GHz	-54.79 dBm		
Type	Ref	Trc	X-value	Y-value	Function	Function Result																																							
M1	1		2.40411 GHz	2.40 dBm																																									
M2	1		2.4 GHz	-56.72 dBm																																									
M3	1		2.39 GHz	-59.71 dBm																																									
M4	1		2.31 GHz	-58.66 dBm																																									
M5	1		2.399906 GHz	-54.79 dBm																																									
<p>CH78 No hopping mode</p>	 <p>Spectrum</p> <p>Ref Level 20.00 dBm Offset 0.50 dB RBW 100 kHz Att 30 dB SWT 56.9 μs VBW 300 kHz Mode Auto FFT</p> <p>1Pk Max</p> <p>M1[1] 3.33 dBm 2.479831 GHz M2[1] -58.71 dBm 2.4835000 GHz</p> <p>D1 -16.670 dBm</p> <p>Start 2.478 GHz 691 pts Stop 2.5 GHz</p> <table border="1"> <thead> <tr> <th>Type</th> <th>Ref</th> <th>Trc</th> <th>X-value</th> <th>Y-value</th> <th>Function</th> <th>Function Result</th> </tr> </thead> <tbody> <tr> <td>M1</td> <td>1</td> <td></td> <td>2.479831 GHz</td> <td>3.33 dBm</td> <td></td> <td></td> </tr> <tr> <td>M2</td> <td>1</td> <td></td> <td>2.4835 GHz</td> <td>-58.71 dBm</td> <td></td> <td></td> </tr> <tr> <td>M3</td> <td>1</td> <td></td> <td>2.5 GHz</td> <td>-60.42 dBm</td> <td></td> <td></td> </tr> <tr> <td>M4</td> <td>1</td> <td></td> <td>2.4836754 GHz</td> <td>-56.27 dBm</td> <td></td> <td></td> </tr> </tbody> </table>			Type	Ref	Trc	X-value	Y-value	Function	Function Result	M1	1		2.479831 GHz	3.33 dBm			M2	1		2.4835 GHz	-58.71 dBm			M3	1		2.5 GHz	-60.42 dBm			M4	1		2.4836754 GHz	-56.27 dBm									
Type	Ref	Trc	X-value	Y-value	Function	Function Result																																							
M1	1		2.479831 GHz	3.33 dBm																																									
M2	1		2.4835 GHz	-58.71 dBm																																									
M3	1		2.5 GHz	-60.42 dBm																																									
M4	1		2.4836754 GHz	-56.27 dBm																																									

CH78
Hopping mode

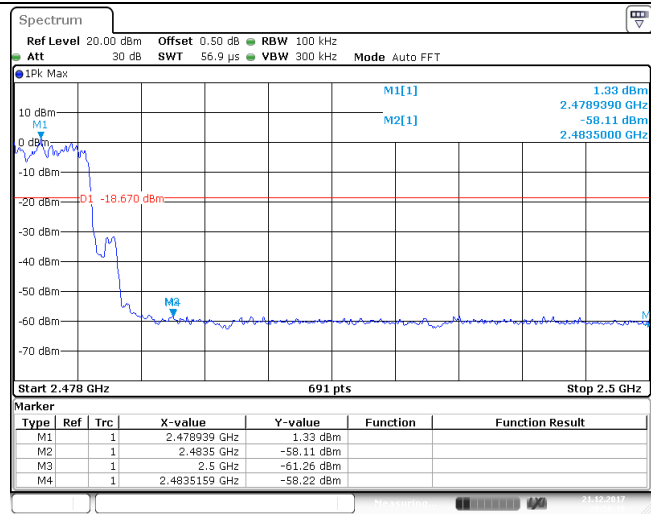

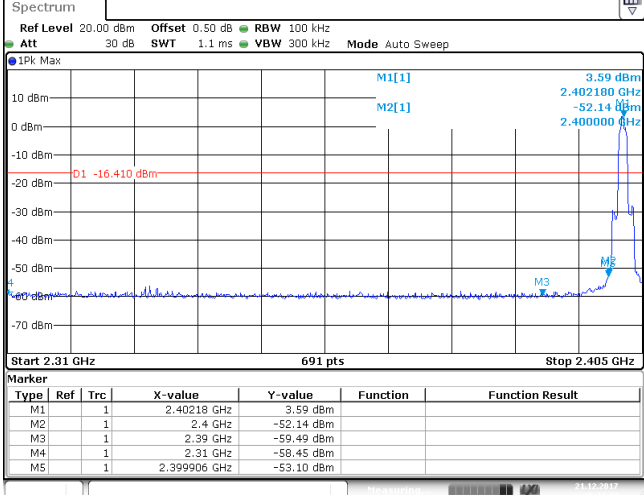
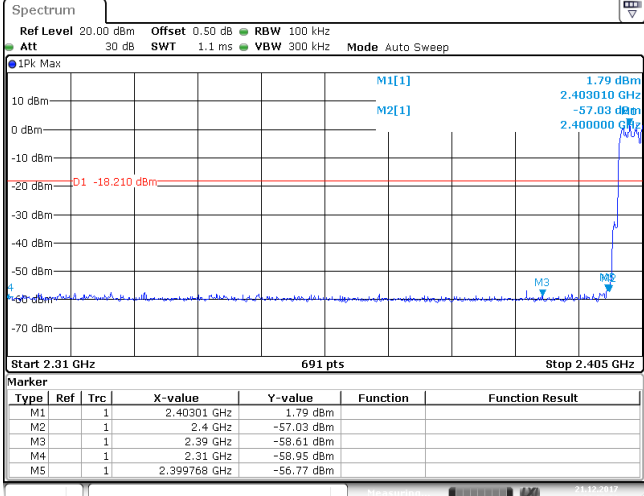
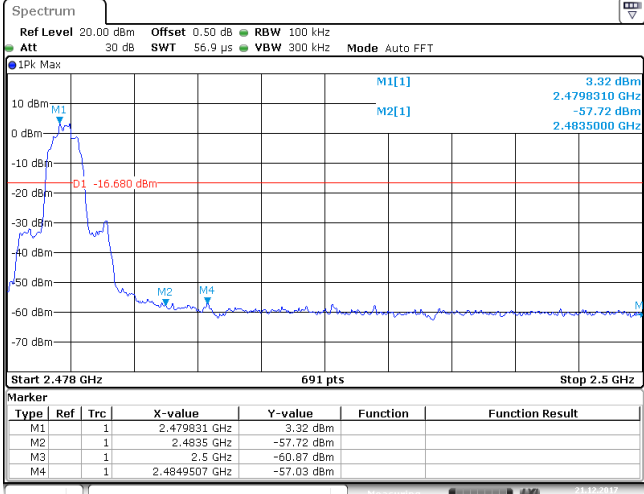
Test Item:	Band edge	Modulation type:	8DPSK																																										
<p>CH00 No hopping mode</p>	 <p>Spectrum</p> <p>Ref Level 20.00 dBm Offset 0.50 dB RBW 100 kHz Att 30 dB SWT 1.1 ms VBW 300 kHz Mode Auto Sweep</p> <p>1Pk Max</p> <p>M1[1] 3.59 dBm 2.402180 GHz M2[1] -52.14 dBm 2.400000 GHz</p> <p>D1 -16.410 dBm</p> <p>Start 2.31 GHz 691 pts Stop 2.405 GHz</p> <table border="1"> <thead> <tr> <th>Type</th> <th>Ref</th> <th>Trc</th> <th>X-value</th> <th>Y-value</th> <th>Function</th> <th>Function Result</th> </tr> </thead> <tbody> <tr> <td>M1</td> <td>1</td> <td></td> <td>2.40218 GHz</td> <td>3.59 dBm</td> <td></td> <td></td> </tr> <tr> <td>M2</td> <td>1</td> <td></td> <td>2.4 GHz</td> <td>-52.14 dBm</td> <td></td> <td></td> </tr> <tr> <td>M3</td> <td>1</td> <td></td> <td>2.39 GHz</td> <td>-59.49 dBm</td> <td></td> <td></td> </tr> <tr> <td>M4</td> <td>1</td> <td></td> <td>2.31 GHz</td> <td>-58.45 dBm</td> <td></td> <td></td> </tr> <tr> <td>M5</td> <td>1</td> <td></td> <td>2.399906 GHz</td> <td>-53.10 dBm</td> <td></td> <td></td> </tr> </tbody> </table>			Type	Ref	Trc	X-value	Y-value	Function	Function Result	M1	1		2.40218 GHz	3.59 dBm			M2	1		2.4 GHz	-52.14 dBm			M3	1		2.39 GHz	-59.49 dBm			M4	1		2.31 GHz	-58.45 dBm			M5	1		2.399906 GHz	-53.10 dBm		
Type	Ref	Trc	X-value	Y-value	Function	Function Result																																							
M1	1		2.40218 GHz	3.59 dBm																																									
M2	1		2.4 GHz	-52.14 dBm																																									
M3	1		2.39 GHz	-59.49 dBm																																									
M4	1		2.31 GHz	-58.45 dBm																																									
M5	1		2.399906 GHz	-53.10 dBm																																									
<p>CH00 Hopping mode</p>	 <p>Spectrum</p> <p>Ref Level 20.00 dBm Offset 0.50 dB RBW 100 kHz Att 30 dB SWT 1.1 ms VBW 300 kHz Mode Auto Sweep</p> <p>1Pk Max</p> <p>M1[1] 1.79 dBm 2.403010 GHz M2[1] -57.03 dBm 2.400000 GHz</p> <p>D1 -18.210 dBm</p> <p>Start 2.31 GHz 691 pts Stop 2.405 GHz</p> <table border="1"> <thead> <tr> <th>Type</th> <th>Ref</th> <th>Trc</th> <th>X-value</th> <th>Y-value</th> <th>Function</th> <th>Function Result</th> </tr> </thead> <tbody> <tr> <td>M1</td> <td>1</td> <td></td> <td>2.40301 GHz</td> <td>1.79 dBm</td> <td></td> <td></td> </tr> <tr> <td>M2</td> <td>1</td> <td></td> <td>2.4 GHz</td> <td>-57.03 dBm</td> <td></td> <td></td> </tr> <tr> <td>M3</td> <td>1</td> <td></td> <td>2.39 GHz</td> <td>-58.61 dBm</td> <td></td> <td></td> </tr> <tr> <td>M4</td> <td>1</td> <td></td> <td>2.31 GHz</td> <td>-58.95 dBm</td> <td></td> <td></td> </tr> <tr> <td>M5</td> <td>1</td> <td></td> <td>2.399768 GHz</td> <td>-56.77 dBm</td> <td></td> <td></td> </tr> </tbody> </table>			Type	Ref	Trc	X-value	Y-value	Function	Function Result	M1	1		2.40301 GHz	1.79 dBm			M2	1		2.4 GHz	-57.03 dBm			M3	1		2.39 GHz	-58.61 dBm			M4	1		2.31 GHz	-58.95 dBm			M5	1		2.399768 GHz	-56.77 dBm		
Type	Ref	Trc	X-value	Y-value	Function	Function Result																																							
M1	1		2.40301 GHz	1.79 dBm																																									
M2	1		2.4 GHz	-57.03 dBm																																									
M3	1		2.39 GHz	-58.61 dBm																																									
M4	1		2.31 GHz	-58.95 dBm																																									
M5	1		2.399768 GHz	-56.77 dBm																																									
<p>CH78 No hopping mode</p>	 <p>Spectrum</p> <p>Ref Level 20.00 dBm Offset 0.50 dB RBW 100 kHz Att 30 dB SWT 56.9 μs VBW 300 kHz Mode Auto FFT</p> <p>1Pk Max</p> <p>M1[1] 3.32 dBm 2.4798310 GHz M2[1] -57.72 dBm 2.4835000 GHz</p> <p>D1 -16.680 dBm</p> <p>Start 2.478 GHz 691 pts Stop 2.5 GHz</p> <table border="1"> <thead> <tr> <th>Type</th> <th>Ref</th> <th>Trc</th> <th>X-value</th> <th>Y-value</th> <th>Function</th> <th>Function Result</th> </tr> </thead> <tbody> <tr> <td>M1</td> <td>1</td> <td></td> <td>2.479831 GHz</td> <td>3.32 dBm</td> <td></td> <td></td> </tr> <tr> <td>M2</td> <td>1</td> <td></td> <td>2.4835 GHz</td> <td>-57.72 dBm</td> <td></td> <td></td> </tr> <tr> <td>M3</td> <td>1</td> <td></td> <td>2.5 GHz</td> <td>-60.87 dBm</td> <td></td> <td></td> </tr> <tr> <td>M4</td> <td>1</td> <td></td> <td>2.4849507 GHz</td> <td>-57.03 dBm</td> <td></td> <td></td> </tr> </tbody> </table>			Type	Ref	Trc	X-value	Y-value	Function	Function Result	M1	1		2.479831 GHz	3.32 dBm			M2	1		2.4835 GHz	-57.72 dBm			M3	1		2.5 GHz	-60.87 dBm			M4	1		2.4849507 GHz	-57.03 dBm									
Type	Ref	Trc	X-value	Y-value	Function	Function Result																																							
M1	1		2.479831 GHz	3.32 dBm																																									
M2	1		2.4835 GHz	-57.72 dBm																																									
M3	1		2.5 GHz	-60.87 dBm																																									
M4	1		2.4849507 GHz	-57.03 dBm																																									

CH78
Hoppig mode

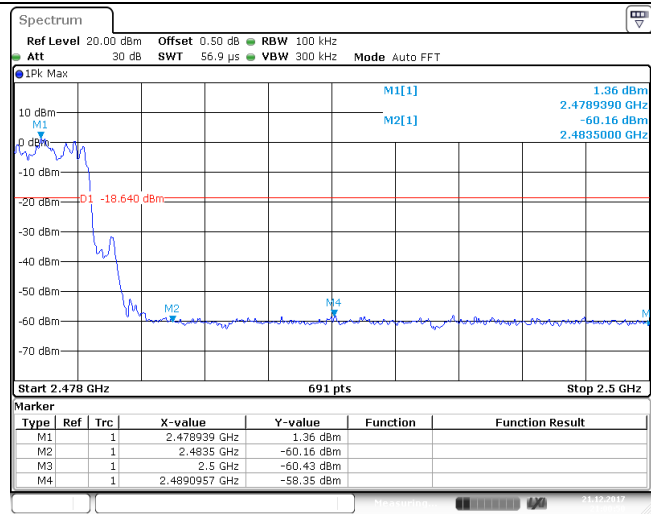

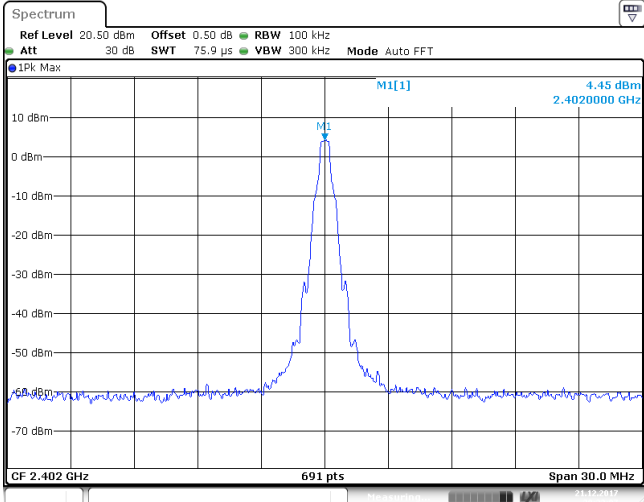
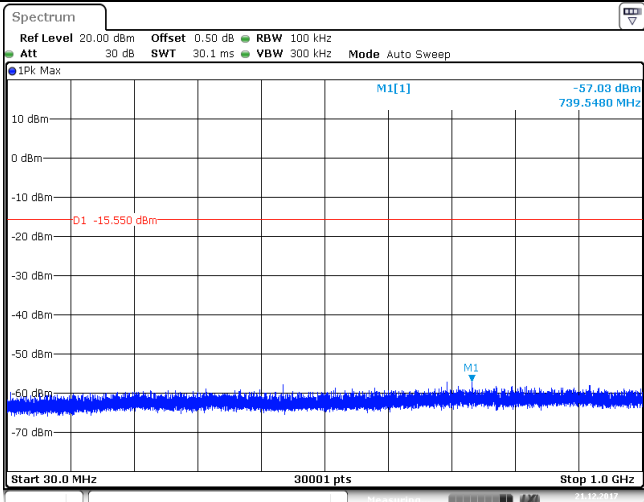
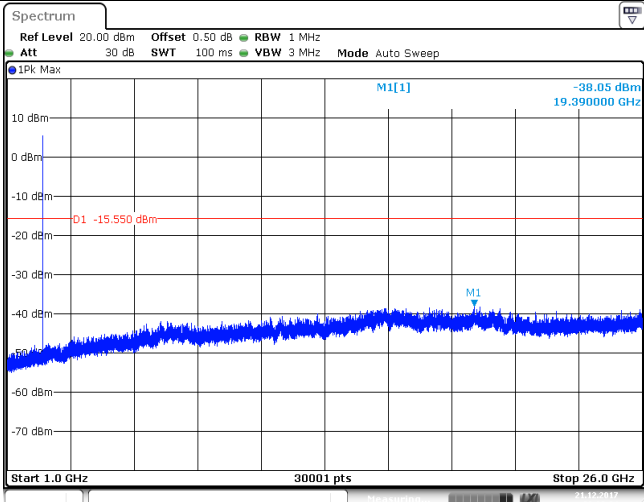
Test Item:	SE	Modulation type:	GFSK
reference level CH00			 <p>Spectrum plot showing a peak at 2.402000 GHz with a level of 4.45 dBm. The plot includes parameters: Ref Level 20.50 dBm, Att 30 dB, Offset 0.50 dB, RBW 100 kHz, Mode Auto FFT, and Span 30.0 MHz.</p>
CH00			 <p>Spectrum plot showing a noise floor at -57.03 dBm and a reference line at -15.550 dBm. The plot includes parameters: Ref Level 20.00 dBm, Att 30 dB, Offset 0.50 dB, RBW 100 kHz, Mode Auto Sweep, and Stop 1.0 GHz.</p>
			 <p>Spectrum plot showing a noise floor at -38.05 dBm and a reference line at -15.550 dBm. The plot includes parameters: Ref Level 20.00 dBm, Att 30 dB, Offset 0.50 dB, RBW 1 MHz, Mode Auto Sweep, and Stop 26.0 GHz.</p>

reference level CH39

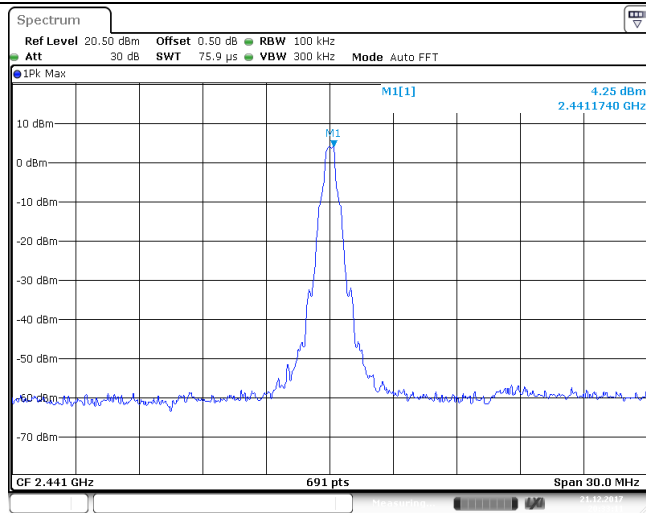

CH39

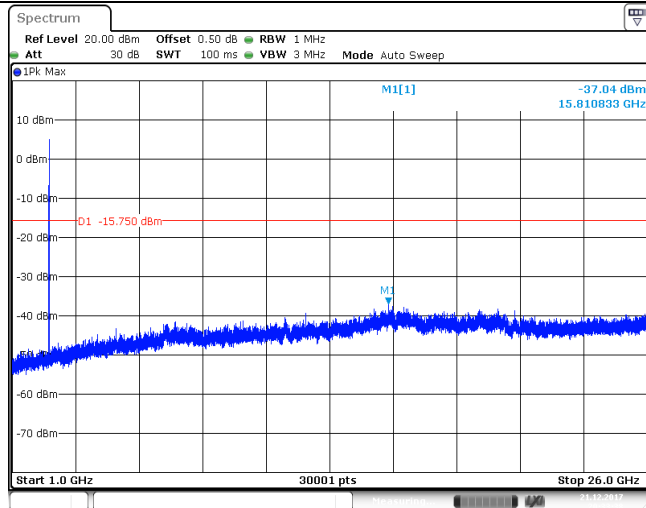
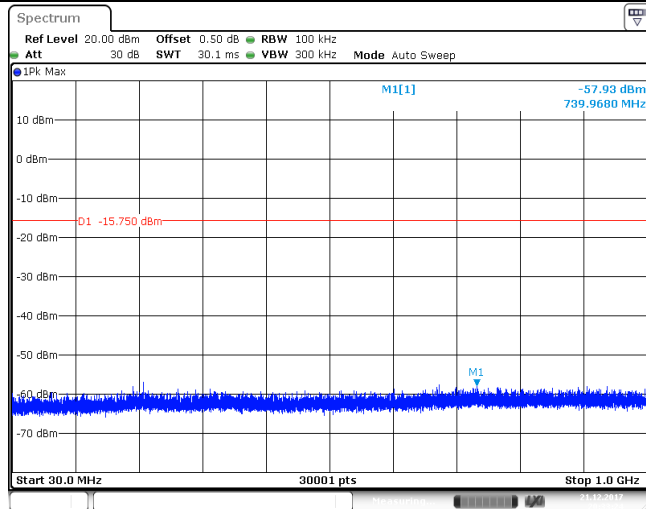

reference level CH78

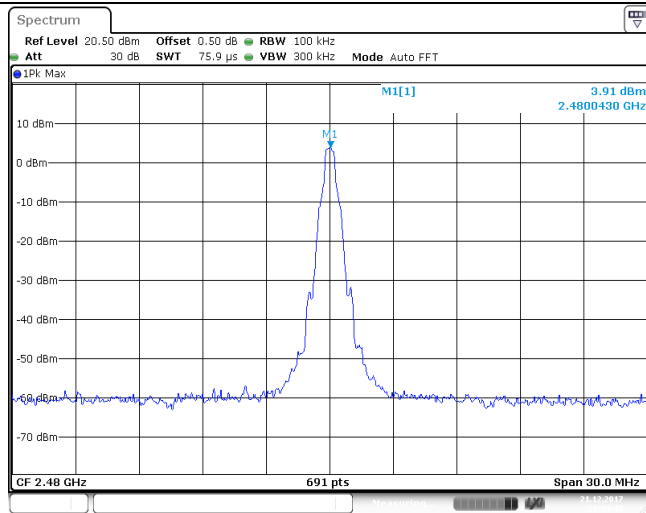

CH78

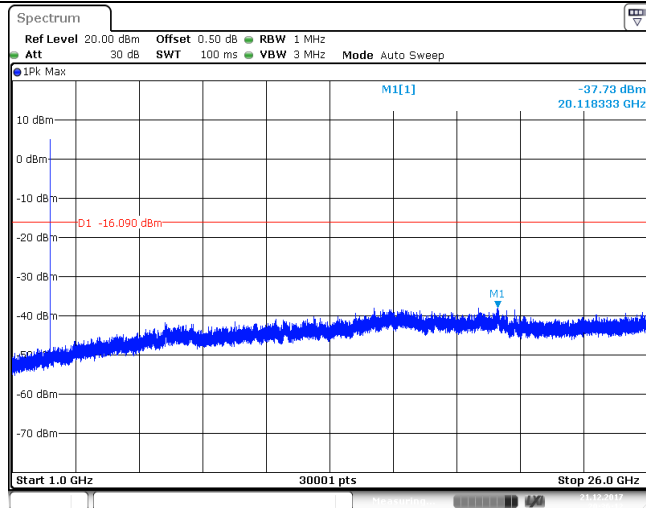
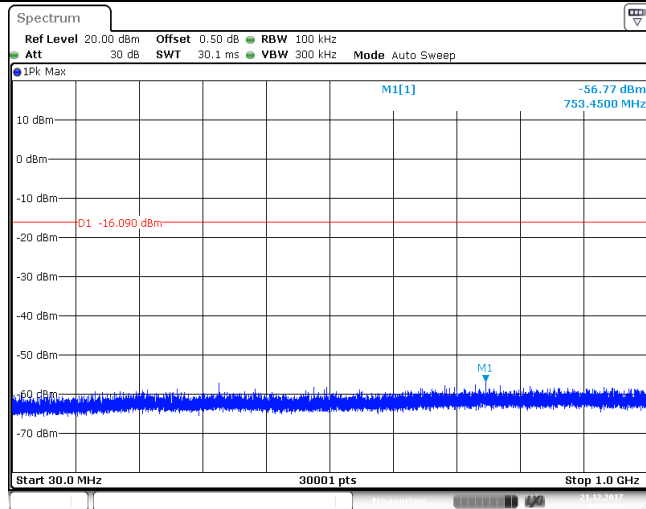

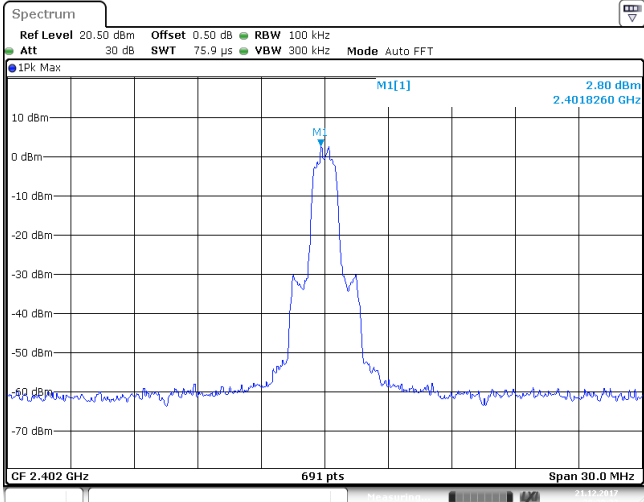
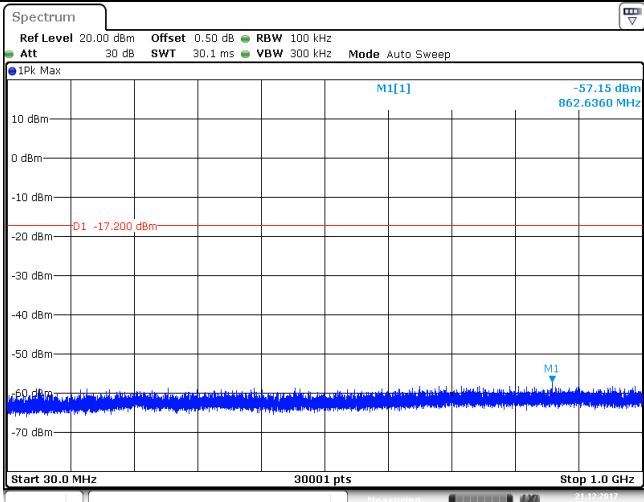
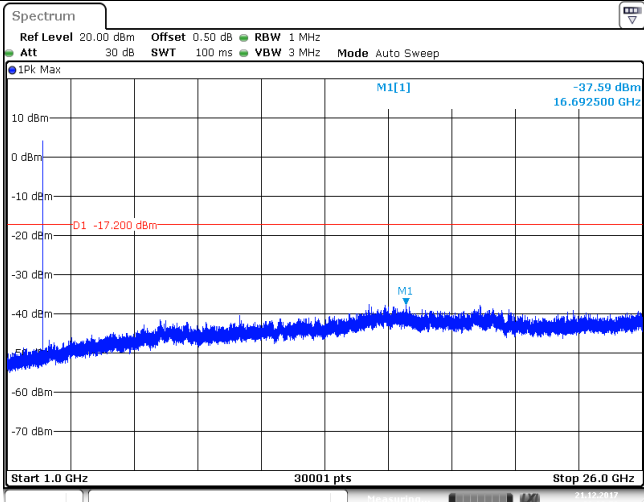
Test Item:	SE	Modulation type:	$\pi/4$ DQPSK
reference level CH00			
CH00			
			

reference level CH39

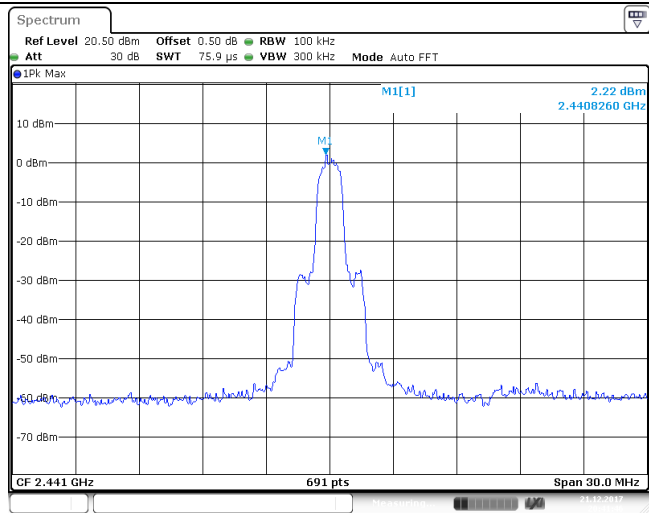

CH39

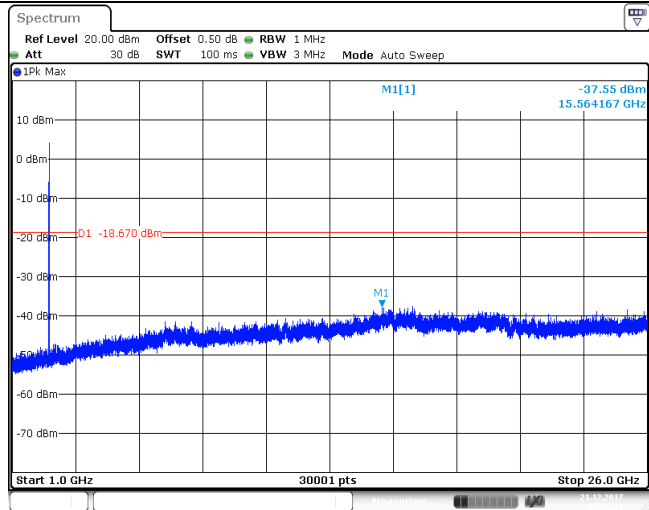
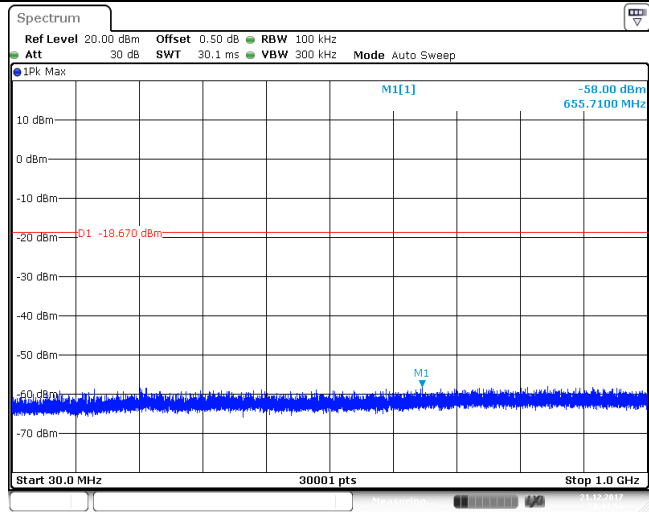

reference level CH78

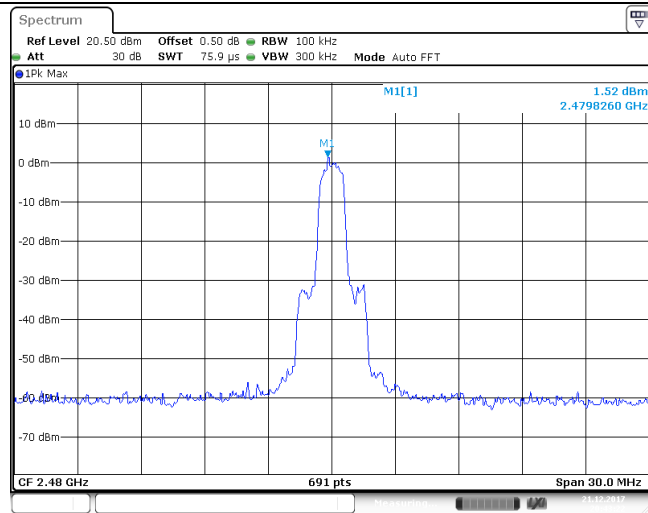

CH78

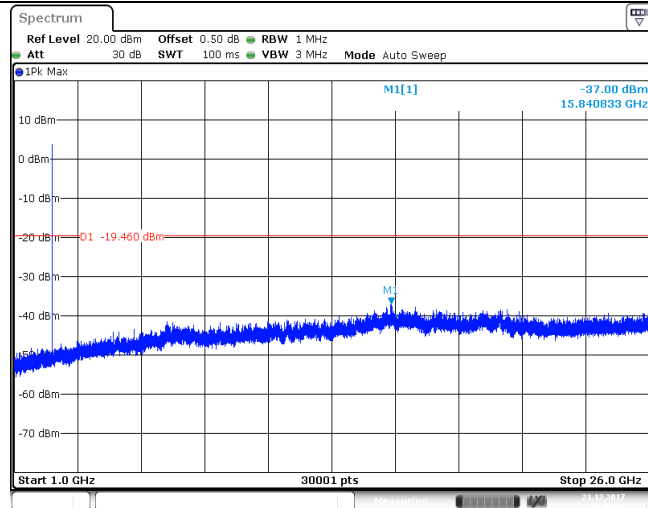
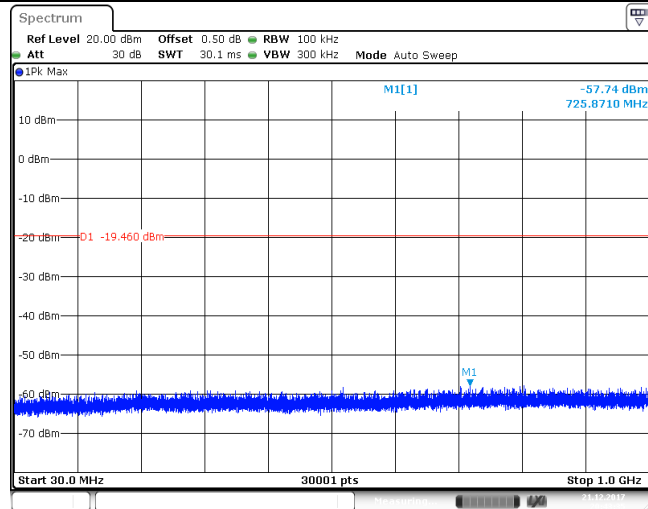

Test Item:	SE	Modulation type:	8DPSK
reference level CH00			
CH00			

reference level CH39

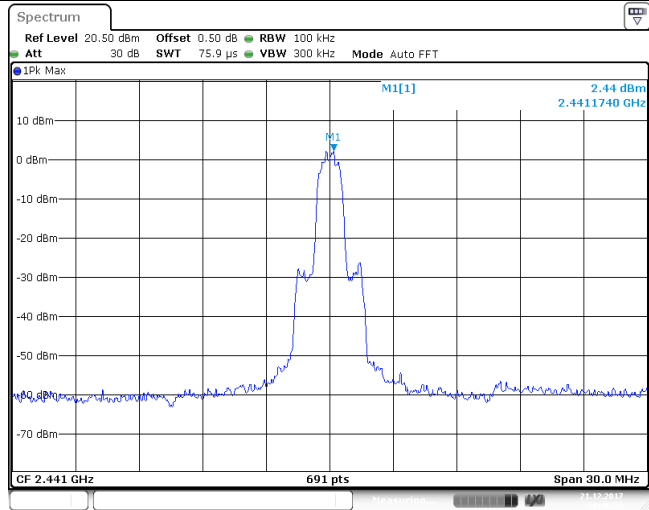

CH39

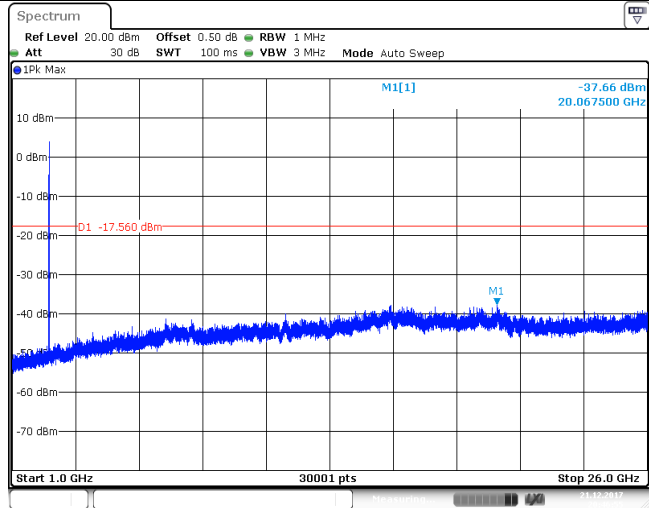
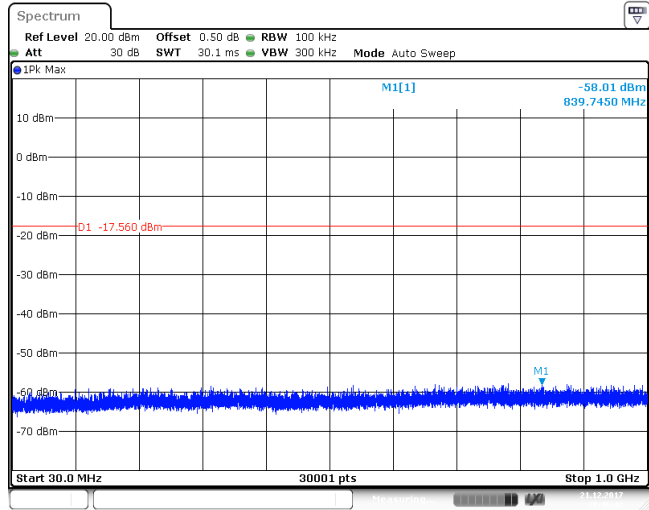

reference level CH78

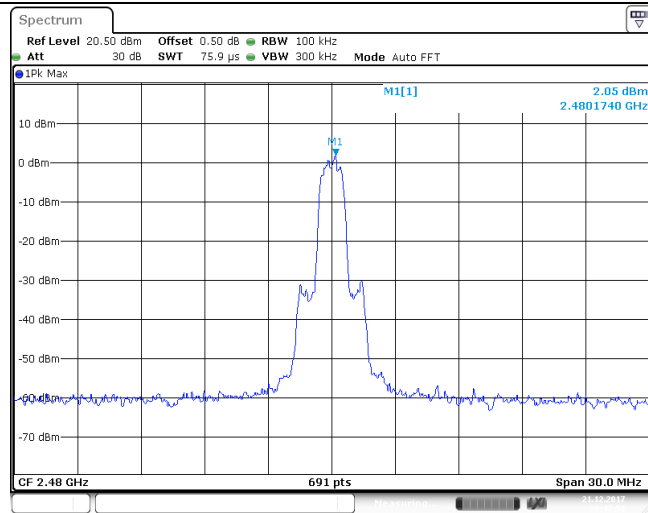

CH78

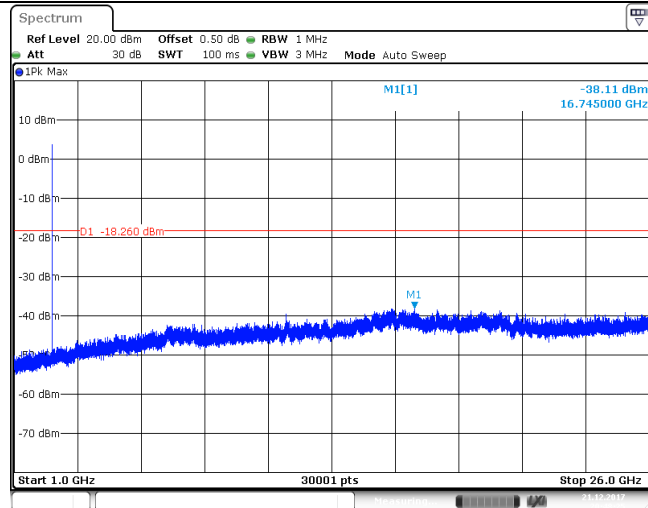
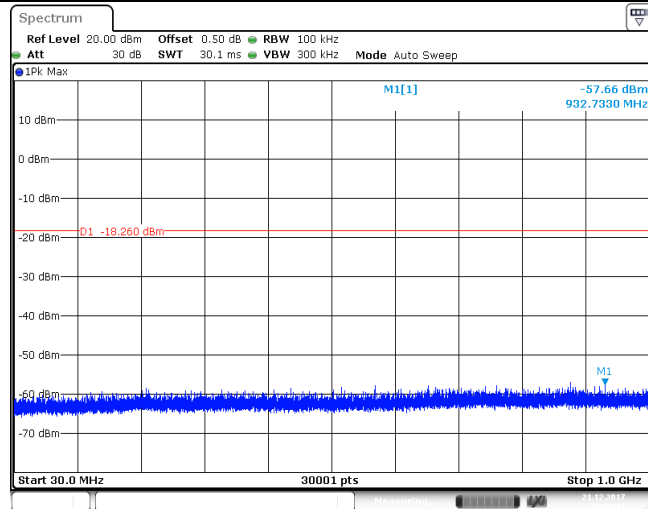

5.11. Spurious Emissions (radiated)

LIMIT

FCC CFR Title 47 Part 15 Subpart C Section 15.209

Frequency	Limit (dBuV/m @3m)	Value
30 MHz ~ 88 MHz	40.00	Quasi-peak
88 MHz ~ 216 MHz	43.50	Quasi-peak
216 MHz ~ 960 MHz	46.00	Quasi-peak
960 MHz ~ 1 GHz	54.00	Quasi-peak
Above 1 GHz	54.00	Average
	74.00	Peak

TEST CONFIGURATION

- Below 30 MHz

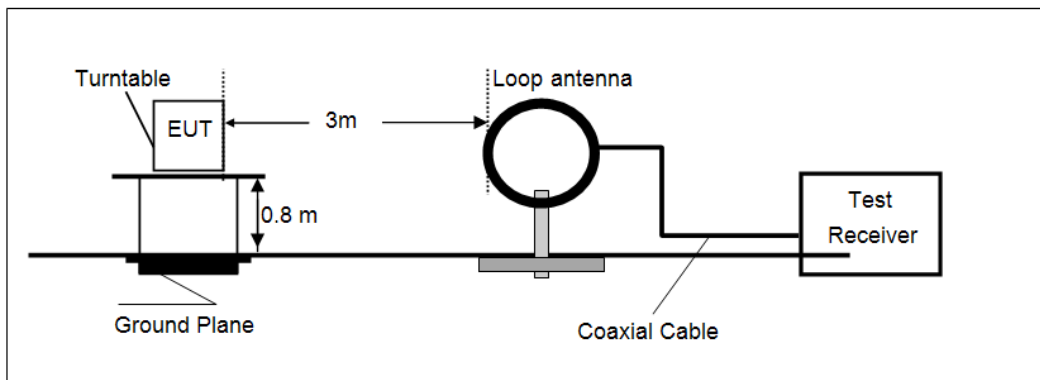

- 30 MHz ~1000 MHz

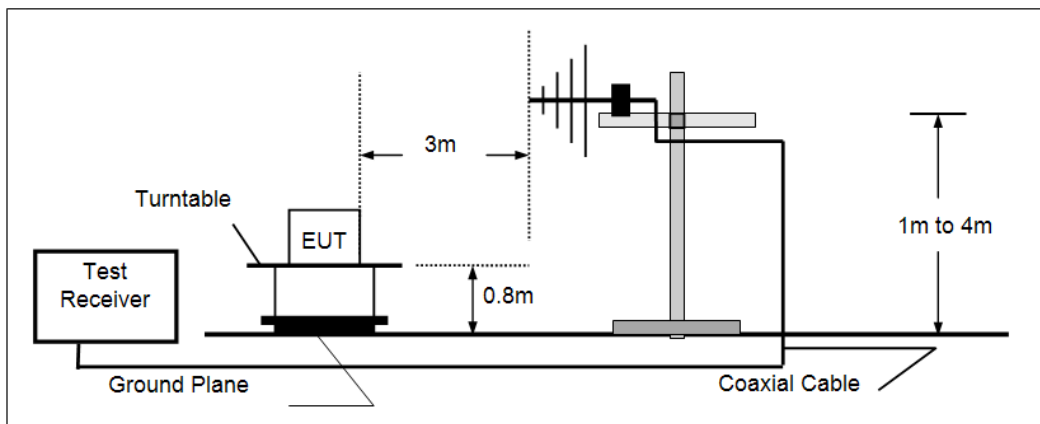

- Above 1 GHz

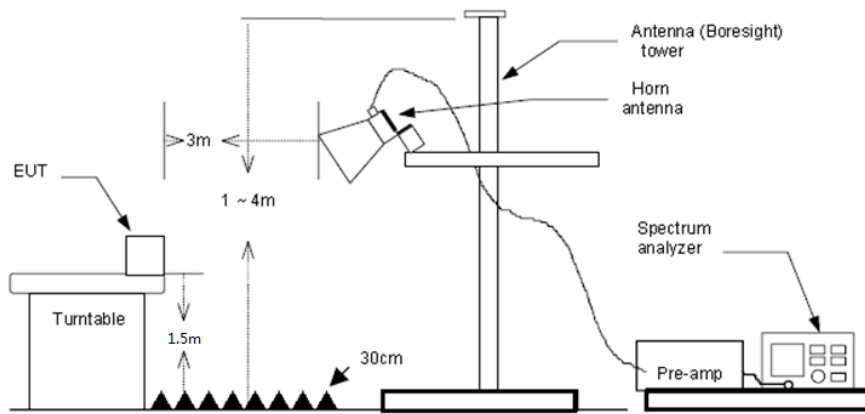

TEST PROCEDURE

1. The EUT was tested according to ANSI C63.10:2013.
2. The EUT is placed on a turn table with 0.8 meter above ground for below 1GHz, 1.5 meter above ground for above 1GHz.
3. The EUT was set 3 meters from the receiving antenna, which was mounted on the top of a variable height antenna tower.
4. For each suspected emission, the EUT was arranged to its worst case and then tune the Antenna tower (from 1 m to 4 m) and turntable (from 0 degree to 360 degrees) to find the maximum reading. A pre-amp and a high pass filter are used for the test in order to get better signal level to comply with the guidelines.
5. Set to the maximum power setting and enable the EUT transmit continuously.
6. Use the following spectrum analyzer settings
 - (1) Span shall wide enough to fully capture the emission being measured;
 - (2) Below 1 GHz:
 - RBW=120 kHz, VBW=300 kHz, Sweep=auto, Detector function=peak, Trace=max hold;
 - If the emission level of the EUT measured by the peak detector is 3 dB lower than the applicable limit, the peak emission level will be reported. Otherwise, the emission measurement will be repeated using the quasi-peak detector and reported.
 - (3) From 1 GHz to 10th harmonic:
 - RBW=1 MHz, VBW=3 MHz Peak detector for Peak value
 - RBW=1 MHz, VBW=10 Hz Peak detector for Average value.

TEST MODE:

Please refer to the clause 3.3

TEST RESULTS

Passed Not Applicable

Note:

- 1) Final Level = Receiver Read level + Antenna Factor + Cable Loss – Preamplifier Factor
- 2) The emission levels of other frequencies are very lower than the limit and not show in test report.
- 3) Below 1 GHz, Have pre-scan all modulation mode, found the GFSK modulation High channel which it was worst case, so only the worst case's data on the test report.
- 4) Above 1 GHz, Have pre-scan all modulation mode, found the GFSK modulation which it was worst case, so only the worst case's data on the test report
- 5) The peak level is lower than average limit(54 dBuV/m), this data is the too weak instrument of signal is unable to test.

➤ 9 kHz ~ 30 MHz

The low frequency, which started from 9 kHz to 30 MHz, was pre-scanned and the result which was 20 dB lower than the limit line per 15.31(o) was not reported.

➤ 30 MHz ~ 1 GHz

Polarization: Vertical

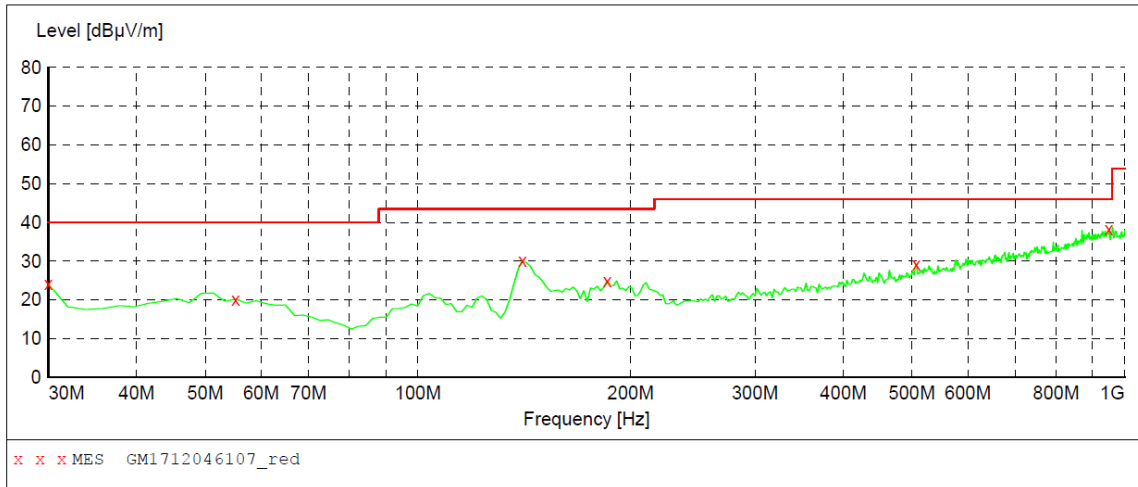

Frequency MHz	Level dBuV/m	Transd dB	Limit dBuV/m	Margin dB	Det.	Height cm	Azimuth deg	Polarization
30.000000	24.10	-13.3	40.0	15.9	QP	100.0	208.00	VERTICAL
55.220000	20.20	-9.2	40.0	19.8	QP	100.0	195.00	VERTICAL
140.580000	30.20	-13.8	43.5	13.3	QP	100.0	236.00	VERTICAL
185.200000	25.00	-11.7	43.5	18.5	QP	100.0	114.00	VERTICAL
507.240000	29.20	-1.6	46.0	16.8	QP	100.0	305.00	VERTICAL
949.560000	38.20	7.2	46.0	7.8	QP	100.0	143.00	VERTICAL

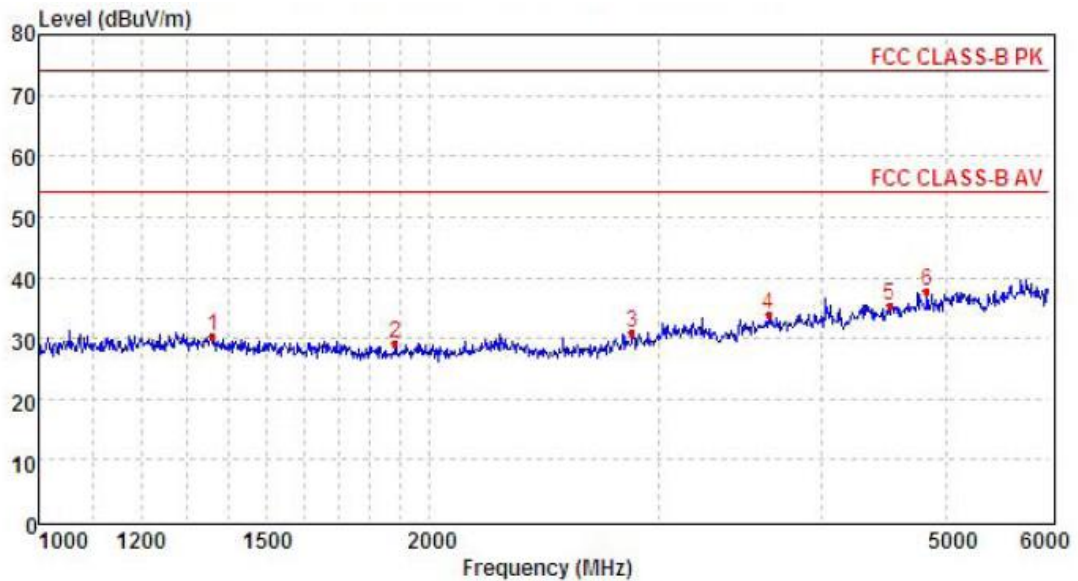

Mark	Frequency MHz	Reading dbuv/m	Antenna db	Cable db	Preamp db	Level dbuv/m	Limit dbuv/m	Over limit	Remark
1	1360.95	36.0	26.0	4.9	36.5	30.4	74.0	-43.6	Peak
2	1882.29	35.0	25.3	6.1	37.2	29.2	74.0	-44.8	Peak
3	2862.69	33.3	28.4	7.4	38.3	30.8	74.0	-43.2	Peak
4	3646.07	34.7	29.3	8.3	38.3	34.0	74.0	-40.0	Peak
5	4520.68	32.9	30.7	9.3	37.4	35.5	74.0	-38.5	Peak
6	4830.53	33.6	31.5	9.6	36.9	37.8	74.0	-36.2	Peak

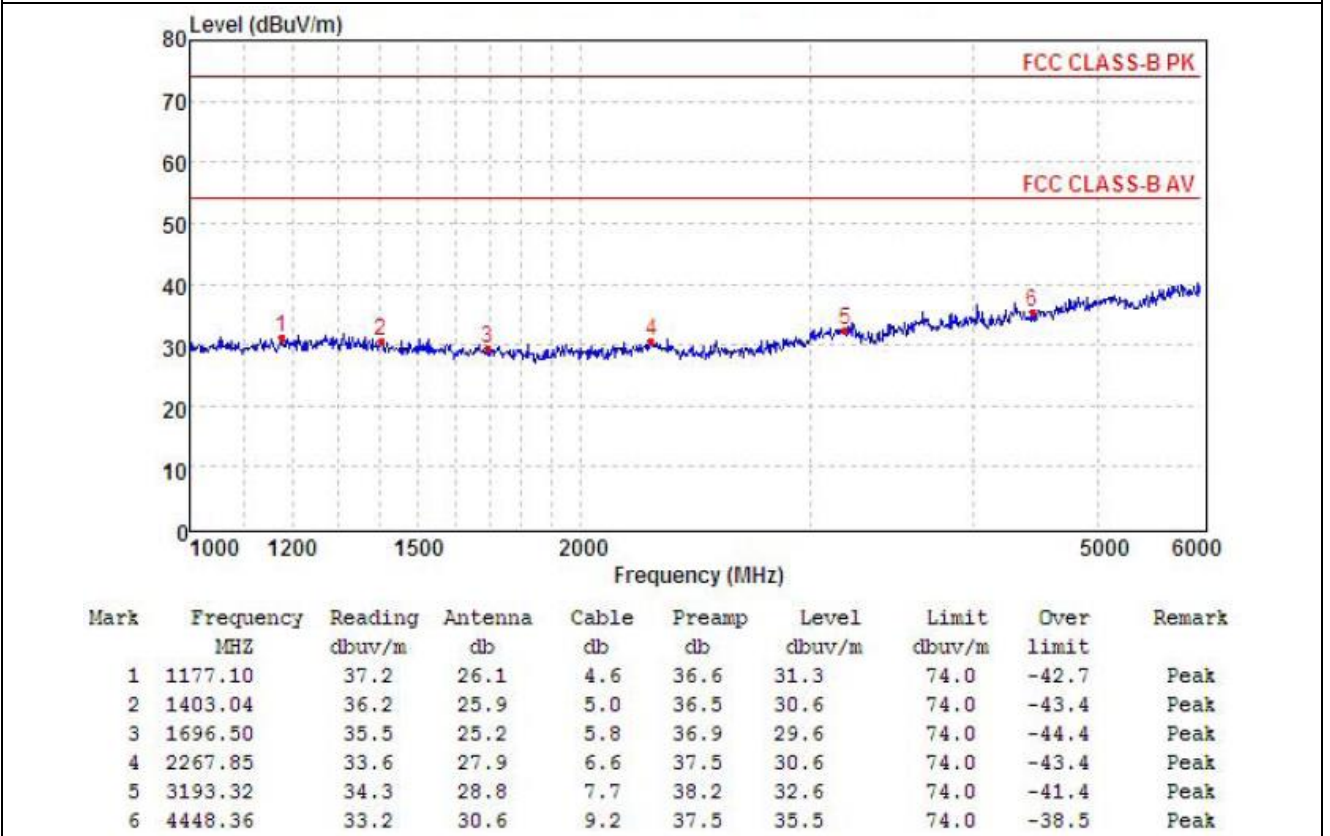
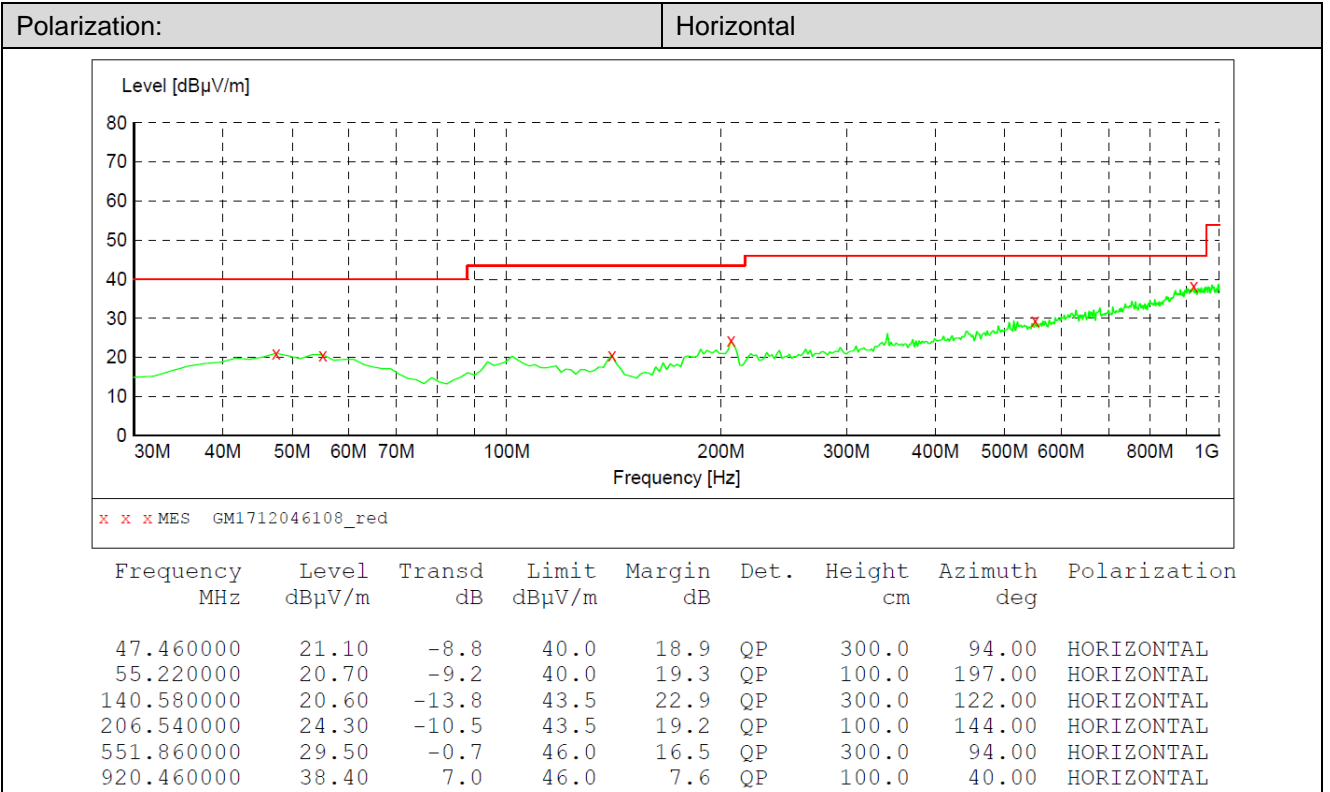

➤ 1 GHz ~ 25 GHz

CH00									
Frequency (MHz)	Read Level (dBuV)	Antenna Factor (dB/m)	Cable Loss (dB)	Preamp Factor (dB)	Level (dBuV/m)	Limit Line (dBuV/m)	Over Limit (dB)	Polarization	Test value
1659.57	45.22	25.08	5.69	36.85	39.14	74.00	-34.86	Vertical	Peak
2995.54	40.22	28.60	7.48	38.23	38.07	74.00	-35.93	Vertical	Peak
4809.50	48.62	31.58	9.55	36.93	52.82	74.00	-21.18	Vertical	Peak
8002.06	31.22	37.10	12.30	34.53	46.09	74.00	-27.91	Vertical	Peak
1663.80	41.48	25.09	5.69	36.85	35.41	74.00	-38.59	Horizontal	Peak
2995.54	44.79	28.60	7.48	38.23	42.64	74.00	-31.36	Horizontal	Peak
4809.50	43.81	31.58	9.55	36.93	48.01	74.00	-25.99	Horizontal	Peak
8002.06	32.76	37.10	12.30	34.53	47.63	74.00	-26.37	Horizontal	Peak

CH39									
Frequency (MHz)	Read Level (dBuV)	Antenna Factor (dB/m)	Cable Loss (dB)	Preamp Factor (dB)	Level (dBuV/m)	Limit Line (dBuV/m)	Over Limit (dB)	Polarization	Test value
1663.80	46.04	25.09	5.69	36.85	39.97	74.00	-34.03	Vertical	Peak
2995.54	45.33	28.60	7.48	38.23	43.18	74.00	-30.82	Vertical	Peak
4883.52	51.84	31.43	9.59	36.73	56.13	74.00	-17.87	Vertical	Peak
4883.52	36.48	31.43	9.59	36.73	40.77	54.00	-13.23	Vertical	Average
7319.96	32.94	36.30	11.99	34.92	46.31	74.00	-27.69	Vertical	Peak
1659.57	43.53	25.08	5.69	36.85	37.45	74.00	-36.55	Horizontal	Peak
2995.54	36.38	28.60	7.48	38.23	34.23	74.00	-39.77	Horizontal	Peak
4883.52	38.74	31.43	9.59	36.73	43.03	74.00	-30.97	Horizontal	Peak
8022.46	32.53	37.08	12.35	34.53	47.43	74.00	-26.57	Horizontal	Peak

CH78									
Frequency (MHz)	Read Level (dBuV)	Antenna Factor (dB/m)	Cable Loss (dB)	Preamp Factor (dB)	Level (dBuV/m)	Limit Line (dBuV/m)	Over Limit (dB)	Polarization	Test value
1659.57	45.81	25.08	5.69	36.85	39.73	74.00	-34.27	Vertical	Peak
2995.54	48.59	28.60	7.48	38.23	46.44	74.00	-27.56	Vertical	Peak
4958.68	53.79	31.46	9.64	36.52	58.37	74.00	-15.63	Vertical	Peak
4958.68	36.96	31.46	9.64	36.52	41.54	54.00	-12.46	Vertical	Average
7451.57	30.53	36.20	12.24	34.86	44.11	74.00	-29.89	Vertical	Peak
1663.80	43.17	25.09	5.69	36.85	37.10	74.00	-36.90	Horizontal	Peak
2995.54	45.75	28.60	7.48	38.23	43.60	74.00	-30.40	Horizontal	Peak
4958.68	52.48	31.46	9.64	36.52	57.06	74.00	-16.94	Horizontal	Peak
4958.68	37.31	31.46	9.64	36.52	41.89	54.00	-12.11	Horizontal	Average
7451.57	38.68	36.20	12.24	34.86	52.26	74.00	-21.74	Horizontal	Peak

Remark:

1. Final Level = Receiver Read level + Antenna Factor + Cable Loss – Preamplifier Factor
2. The peak level is lower than average limit(54 dBuV/m), this data is the too weak instrument of signal is unable to test.
3. The emission levels of other frequencies are very lower than the limit and not show in test report.

6. TEST SETUP PHOTOS OF THE EUT

Radiated Emissions



7. EXTERANAL AND INTERNAL PHOTOS OF THE EUT

Reference to the test report No.: TRE1711018601.

-----End of Report-----