

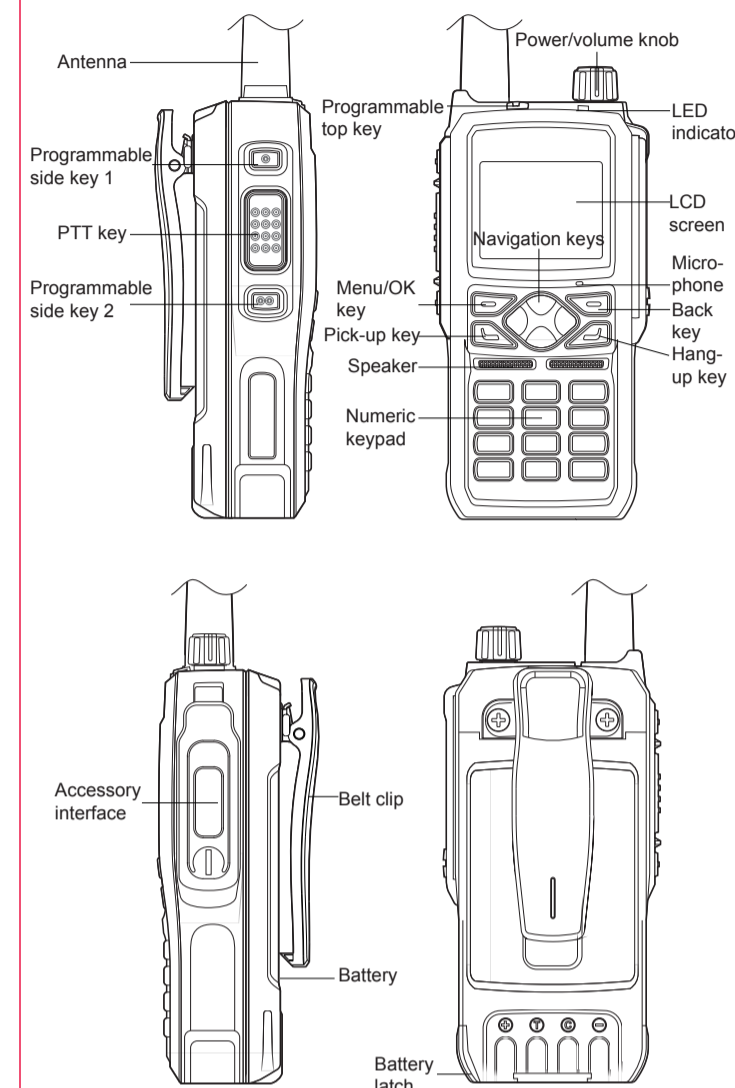

## PoC Trunked Two-way Radio GP700 Quick Guide

Please read carefully the Safety information before using the product.

### Appearance



### Charging the Battery

- Take the following steps to charge the battery.
1. Plug the power adapter into an AC power socket of the required specifications.
  2. Connect the power adapter to the charger, and green power indicator light will be on.
  3. Put a battery solely or attached to the device into the charger.
  4. Ensure the battery contacts well with the charging terminals. Red charging indicator light is on.
  5. After charging for about 6 hours, the charging indicator will turn green. The battery is fully charged.
  6. After the indicator light turns green, wait 1 to 2 hours before taking out the battery, so as to achieve the best battery performance.
  7. Disconnect the power adapter from the socket.

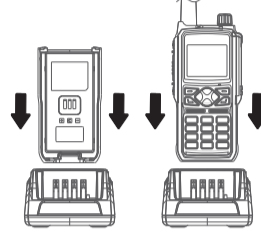

### Installing the Battery

1. Press the upper part of the belt clip gently so that it goes up. (Figure 1)
2. Align the battery with the battery holder at the back of the device, and insert the battery. (Figure 2)
3. Push the battery in the direction indicated until the latch is in position. (Figure 3)
4. Press the lower part of the battery until it is latched. (Figure 4)

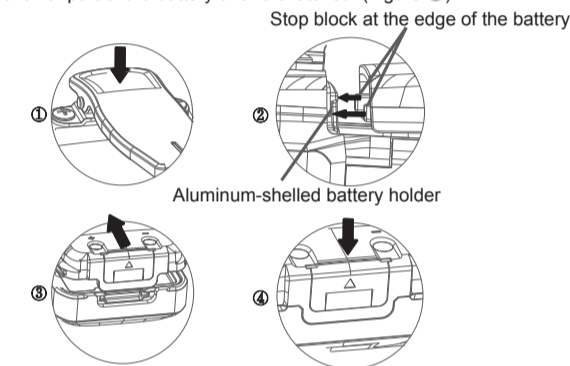

### Installing/Uninstalling the Battery

To install the antenna, plug the threaded end into the antenna interface, and rotate the antenna clockwise until it is tight.  
To uninstall the antenna, rotate it counterclockwise.

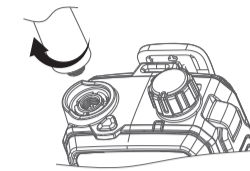

### Installing/Uninstalling Belt Clip

To install the belt clip, align the two screw holes on the belt clip with the two at the back of the device, and fasten the screws.  
To uninstall the belt clip, loosen the screws, and then take off the belt clip.

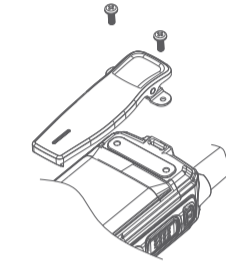

### Installing an Accessory

To use an audio accessory or the programming cable, screw down the screw on the earphone cover, take down the accessory cover, plug the accessory or cable into the interface, and screw up the screw.

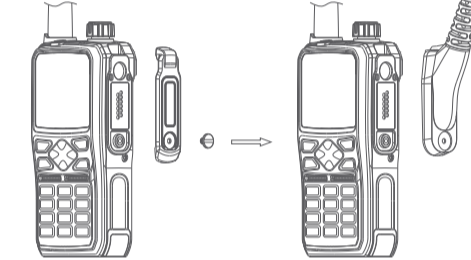

### Installing a SIM Card

- Note: Please use a standard Nano-SIM card.
1. Unscrew the screw on the TF card cover using the supplied screwdriver, open the cover, and take out the instructions card.
  2. Insert a SIM card into the slot of the card holder (Figure 1), and close the card holder cover. (Figure 2)
  3. Lock the card holder cover by sliding it in the indicated direction. (Figure 3)
  4. Close the TF card cover and screw up the screw (Figure 4)

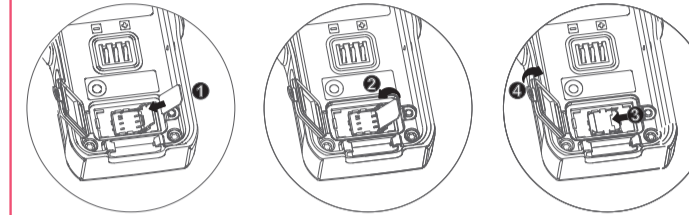

### LED Indicator

Indicator state	Device State
Red light on	A. No SIM card is installed, or it is installed improperly. There is a voice prompt "No SIM card". B. Fail to unlock the PIN code of the SIM card.
Green light on	A. During a call (i.e. individual/group/all call). B. A voice record is being downloaded/played.
Yellow light on	A. The device is in individual-call standby state. B. The device is in call setup state. C. The device is unregistered or expired, so that it is not deployed on the server.
Red light flashing fast	Network registration fails because the SIM card is inactivated or a bill is unpaid. Device registration fails because of poor wireless network connection.
Green light flashing slow	The device is registered to a network successfully and enters standby state.
Idle	The device is idle or powered off.



Kirisun Communication Co., Ltd.

Version: V1.0



167W06000213

### Icons

Icon	Description
	Received signal strength indication
	2G/3G/4G network
	Wi-Fi received signal strength indication
	Searching GPS satellite signals
	GPS signals acquired and locked up
	In group call
	In individual call
	In all call
	Under dispatching
	Remaining battery capacity
	Short message
	Bluetooth on
	Bluetooth device paired
	In emergency alarm
	Alarm message

### Basic Operation

#### 1.Powering On/Off

To power on/off the device, hold down the Power/Volume knob and release after 2 seconds.  
The screen and green LED indicator light will be on, and the message "initializing" will be displayed.  
Note: If no SIM card is installed or the card is unregistered or invalid, you will hear the voice prompt "No SIM card"

#### 2.Adjusting the Volume

After power-on, rotate the Power/Volume knob clockwise to increase the volume or counterclockwise to decrease it.

#### 3.Initiating a Call

Hold down the PTT key to initiate a call on the selected channel.

#### 4.Receiving a Call

When a call is received, green indicator light will be on.

#### 5.Network Type

To choose a network type, in the standby interface, press the Menu/OK key to enter the menu, select Setting – Network Type.

#### 6.Low-Power Alert

To choose a network type, in the standby interface, press the Menu/OK key to enter the menu, select Setting – Network Type.

#### 7.Positioning

To enable/disable positioning, in the standby interface press the Menu/OK key to enter the menu, and select Setting – GPS.  
The built-in GPS module locates the device and reports position information to the network management system. The real-time location and movement track of the device can be displayed on a GIS map on the network management system or dispatcher software.

#### 8.Wi-Fi

To enable/disable Wi-Fi, in the standby interface press the Menu/OK key to enter the menu, and select Setting – Wi-Fi.  
After enabling Wi-Fi, you can search and connect to a nearby Wi-Fi network in real time and set a password.

#### 9.Bluetooth

To enable/disable Bluetooth, in the standby interface press the Menu/OK key, and select Setting – Bluetooth.  
After enabling Bluetooth, you can scan for and pair with a BT earphone that is in pairing mode.

#### 10.Short Message

To send the message, in the standby interface press the Menu/OK key, select Message – Short Message, write a message, select a contact, and send the message.  
To view the short messages received/sent, press the Menu/Ok key, and select Inbox/Outbox.

#### 11.Advanced Functions

Via dispatcher software, you can revive, stun or kill the device, play back voice, or perform background monitoring on another device.

#### 12. Others

**[\*]** key: Press it to turn off the screen and enter Power Saver mode; hold it down for seconds to lock/unlock the keypad.  
Programmable side key 1: By default, press it to announce the selected channel; hold it down for seconds to announce remaining battery capacity.  
Programmable side key 2: By default, press it to announce the user name; hold it down for seconds to enter individual-call mode.

### Troubleshooting

No.	Problem	Solution
1	Power-on failed	1. The battery is out. Charge or replace the battery. 2. The volume knob is faulty, or there is another problem. Get the device repaired at an authorized service station.
2	Low voice during a call	1. Speak too far from the microphone. Please keep a distance of 3 ~ 10cm. 2. Inappropriate volume setting. Increase the volume by rotating the volume knob clockwise.
3	PTT service unavailable	1. The SIM card is expired. Refill or replace it. 2. Incorrect group setting. Choose a correct group and try again. 3. The device is expired. Renew it.

### Attachments

No.	Name
1	Main unit
2	Battery
3	Antenna
4	Power adapter
5	User manual
6	Safety information
7	Strap
8	Desktop charger

This document is only for reference, and actual product prevails.  
Kirisun reserves the right to the final interpretation of this document.

## CE Warning

1. Risk of explosion if battery is replaced by an incorrect type. Dispose of used batteries according to the instructions.
2. The product shall only be connected to a USB interface of version USB2.0 or higher.
3. Adapter shall be installed near the equipment and shall be easily accessible.
4. The operating temperature of the device can't exceed 40 °C and shouldn't be lower than -20 °C.
5. The plug considered as disconnect device of adapter.
6. The device complies with RF specifications when the device used at 5mm from the body without belt-clips, 0mm from the body with the belt-clips, 25mm from the face.
7. The band 5150-5350MHz indoor use only.

Hereby, Kirisun Communication Co.,Ltd. declares that this product is in compliance with essential requirements and other relevant provisions of Directive 2014/53/EU. This product is allowed to be used in all EU member states.

## FCC Warning

### 15.19 Labeling requirements.

This device complies with part 15 of the FCC Rules. Operation is subject to the following two conditions: (1) This device may not cause harmful interference, and (2) this device must accept any interference received, including interference that may cause undesired operation.

### 15.21 Information to user.

Any Changes or modifications not expressly approved by the party responsible for compliance could void the user's authority to operate the equipment.

### 15.105 Information to the user.

Note: This equipment has been tested and found to comply with the limits for a Class B digital device, pursuant to part 15 of the FCC Rules. These limits are designed to provide reasonable protection against harmful interference in a residential installation. This equipment generates uses and can radiate radio frequency energy and, if not installed and used in accordance with the instructions, may cause harmful interference to radio communications. However, there is no guarantee that interference will not occur in a particular installation. If this equipment does cause harmful interference to radio or television reception, which can be determined by turning the equipment off and on, the user is encouraged to try to correct the interference by one or more of the following measures:

- Reorient or relocate the receiving antenna.
- Increase the separation between the equipment and receiver.
- Connect the equipment into an outlet on a circuit different from that to which the receiver is connected.
- Consult the dealer or an experienced radio/TV technician for help.

### Absorption Rate (SAR) information:

This device meets the government's requirements for exposure to radio waves. The guidelines are based on standards that were developed by independent scientific organizations through periodic and thorough evaluation of scientific studies. The standards include a substantial safety margin designed to assure the safety of all persons regardless of age or health.

FCC RF Exposure Information and Statement The SAR limit of USA (FCC) is 1.6 W/kg averaged over one gram of tissue. This device was tested for typical body-worn operations with the back of the device kept 10mm from the body without belt-clips, 0mm from the body with the belt-clips, 25mm from the face. To maintain compliance with FCC RF exposure requirements, use accessories that maintain a appropriate separation distance between the user's body and the back of the device. The use of belt clips, holsters and similar accessories should not contain metallic components in its assembly. The use of accessories that do not satisfy these requirements may not comply with FCC RF exposure requirements, and should be avoided. Use only the supplied or an approved antenna.

## IC Warning

This device complies with Industry Canada's licence-exempt RSSs. Operation is subject to the following two conditions:

- (1) This device may not cause interference;
- (2) This device must accept any interference, including interference that may cause undesired operation of the device.

Le présent appareil est conforme aux CNR d'Industrie Canada applicables aux appareils radio exempts de licence. L'exploitation est autorisée aux deux conditions suivantes:

- (1) l'appareil ne doit pas produire de brouillage, et (2) l'utilisateur de l'appareil doit accepter tout brouillage radioélectrique subi, même si le brouillage est susceptible d'en compromettre le fonctionnement.

The information listed above provides the user with information needed to make him or her aware of a RF exposure, and what to do to assure that this radio operates within the FCC exposure limits of this radio.

The device complies with RF specifications when the device used at 10mm from the body without belt-clips, 0mm from the body with the belt-clips, 25mm from the face. Third-party belt-clips, holsters, and similar accessories used by this device should not contain any metallic components. Body-worn accessories that do not meet these requirements may not comply with RF exposure requirements and should be avoided. Use only the supplied or an approved antenna.