



FCC RADIO TEST REPORT

FCC ID: Q58W001

Product : Epoc WIFI

Trade Name : Eeyelog

Model Name : W001

Serial Model : W002, W003, W005, W006

Report No. : NTEK-2012NT0827714F

Prepared for

Shenzhen Eeyelog Technology Co.,Ltd.

Floor3 South, Building No.2, Liantang Industrial Area, Fenghuanggang,
Xixiang Street, Qianjin Road, Bao'an District, Shenzhen, China

Prepared by

NTEK Testing Technology Co., Ltd.

1/F, Building E, Fenda Science Park, Sanwei Community, Xixiang Street
Bao'an District, Shenzhen P.R. China

Tel.: +86-0755-61156588 Fax.: +86-0755-61156599

Website: www.ntek.org.cn

TEST RESULT CERTIFICATION

Applicant's name : Shenzhen Eeyelog Technology Co.,Ltd.
Address : Floor3 South, Building No.2, Liantang Industrial Area,
Fenghuanggang, Xixiang Street, Qianjin Road, Bao'an District,
Shenzhen, China
Manufacture's Name..... : Shenzhen Eeyelog Technology Co.,Ltd.
Address : Floor3 South, Building No.2, Liantang Industrial Area,
Fenghuanggang, Xixiang Street, Qianjin Road, Bao'an District,
Shenzhen, China

Product description

Product name : Epoc WIFI
Model and/or type reference : W001
Serial Model : W002, W003, W005, W006

Standards : FCC Part15.247

Test procedure ANSI C63.4-2003

This device described above has been tested by NTEK, and the test results show that the equipment under test (EUT) is in compliance with the FCC requirements. And it is applicable only to the tested sample identified in the report.

This report shall not be reproduced except in full, without the written approval of NTEK, this document may be altered or revised by NTEK, personal only, and shall be noted in the revision of the document.

Date of Test :

Date (s) of performance of tests : 28 Aug. 2012 ~10 Sep. 2012

Date of Issue..... : 11 Sep. 2012

Test Result..... : **Pass**

Testing Engineer : Apple Huang

(Apple Huang)

Technical Manager : Tom Zhang

(Tom Zhang)

Authorized Signatory : Bovey Yang

(Bovey Yang)

Table of Contents

	Page
1 . SUMMARY OF TEST RESULTS	5
1.1 TEST FACILITY	6
1.2 MEASUREMENT UNCERTAINTY	6
2 . GENERAL INFORMATION	7
2.1 GENERAL DESCRIPTION OF EUT	7
2.2 DESCRIPTION OF TEST MODES	9
2.3 BLOCK DIGRAM SHOWING THE CONFIGURATION OF SYSTEM TESTED	10
2.4 DESCRIPTION OF SUPPORT UNITS(CONDUCTED MODE)	11
2.5 EQUIPMENTS LIST FOR ALL TEST ITEMS	12
3 . EMC EMISSION TEST	13
3.1 CONDUCTED EMISSION MEASUREMENT	13
3.1.1 POWER LINE CONDUCTED EMISSION LIMITS	13
3.1.2 TEST PROCEDURE	14
3.1.3 DEVIATION FROM TEST STANDARD	14
3.1.4 TEST SETUP	14
3.1.5 EUT OPERATING CONDITIONS	14
3.1.6 TEST RESULTS	15
3.2 RADIATED EMISSION MEASUREMENT	19
3.2.1 RADIATED EMISSION LIMITS	19
3.2.2 TEST PROCEDURE	20
3.2.3 DEVIATION FROM TEST STANDARD	20
3.2.4 TEST SETUP	21
3.2.5 EUT OPERATING CONDITIONS	22
3.2.6 TEST RESULTS (BETWEEN 9KHZ – 30 MHZ)	23
3.2.7 TEST RESULTS (BETWEEN 30MHZ – 1GHZ)	24
3.2.8 TEST RESULTS (ABOVE 1000 MHZ)	26
4 . POWER SPECTRAL DENSITY TEST	56
4.1 APPLIED PROCEDURES / LIMIT	56
4.1.1 TEST PROCEDURE	56
4.1.2 DEVIATION FROM STANDARD	56
4.1.3 TEST SETUP	56
4.1.4 EUT OPERATION CONDITIONS	56
4.1.5 TEST RESULTS	57
5 . BANDWIDTH TEST	63
5.1 APPLIED PROCEDURES / LIMIT	63
5.1.1 TEST PROCEDURE	63

Table of Contents

	Page
5.1.2 DEVIATION FROM STANDARD	63
5.1.3 TEST SETUP	63
5.1.4 EUT OPERATION CONDITIONS	63
5.1.5 TEST RESULTS	64
6 . PEAK OUTPUT POWER TEST	70
6.1 APPLIED PROCEDURES / LIMIT	70
6.1.1 TEST PROCEDURE	70
6.1.2 DEVIATION FROM STANDARD	70
6.1.3 TEST SETUP	70
6.1.4 EUT OPERATION CONDITIONS	70
6.1.5 TEST RESULTS	71
7 . ANTENNA REQUIREMENT	72
7.1 STANDARD REQUIREMENT	72
7.2 EUT ANTENNA	72
8 . EUT TEST PHOTO	73
APPENDIX-PHOTOGRAPHS OF EUT CONSTRUCTIONAL DETAILS	

1. SUMMARY OF TEST RESULTS

Test procedures according to the technical standards:

FCC Part15 (15.247) , Subpart C			
Standard Section	Test Item	Judgment	Remark
15.207	Conducted Emission	PASS	
15.247 (a)(2)	6dB Bandwidth	PASS	
15.247 (b)	Peak Output Power	PASS	
15.247 (c)	Radiated Spurious Emission	PASS	
15.247 (d)	Power Spectral Density	PASS	
15.205	Band Edge Emission	PASS	
15.203	Antenna Requirement	PASS	

1.1 TEST FACILITY

NTEK Testing Technology Co., Ltd

Add. : 1/F, Building E, Fenda Science Park, Sanwei Community, Xixiang Street, Bao'an District, Shenzhen P.R. China.

FCC Registration No.:238937; IC Registration No.:9270A-1

CNAS Registration No.:L5516

1.2 MEASUREMENT UNCERTAINTY

The reported uncertainty of measurement $y \pm U$, where expanded uncertainty U is based on a standard uncertainty multiplied by a coverage factor of $k=2$, providing a level of confidence of approximately 95 %.

No.	Item	Uncertainty
1	Conducted Emission Test	$\pm 1.38\text{dB}$
2	RF power,conducted	$\pm 0.16\text{dB}$
3	Spurious emissions,conducted	$\pm 0.21\text{dB}$
4	All emissions,radiated(<1G)	$\pm 4.68\text{dB}$
5	All emissions,radiated(>1G)	$\pm 4.89\text{dB}$
6	Temperature	$\pm 0.5^\circ\text{C}$
7	Humidity	$\pm 2\%$

2. GENERAL INFORMATION

2.1 GENERAL DESCRIPTION OF EUT

Equipment	Epec WIFI	
Trade Name	Eeyelog	
Model Name	W001	
Serial Model	W002, W003, W005, W006	
Model Difference	All the model are the same circuit and RF module, except the appearance and colour.	
Product Description	The EUT is a Epec WIFI	
	Operation Frequency:	2412~2462 MHz
	Modulation Type:	CCK/OFDM/DBPSK/DAPSK
	Bit Rate of Transmitter	802.11b:11/5.5/2/1 Mbps 802.11g:54/48/36/24/18/12/9/6 Mbps 802.11n:150/144.44/130/117/115.56/104/86.67/78/52/6.5 Mbps
	Number Of Channel	11 CH, Please see Note 2.
	Antenna Designation:	Please see Note 3.
	Output Power(Conducted):	802.11b: 11.92 dBm (Max.) 802.11g: 10.86 dBm (Max.) 802.11n: 10.84 dBm (Max.)
	Antenna Gain (dBi)	1.0dbi
	Based on the application, features, or specification exhibited in User's Manual, the EUT is considered as an ITE/Computing Device. More details of EUT technical specification, please refer to the User's Manual.	
	Channel List	Please refer to the Note 2.
Power	DC 5V(USB) from PC	
Battery	Rated Voltage: 3.7V Charge Limit: 4.2V	
Connecting I/O Port(s)	Please refer to the User's Manual	

Note

:

1. For a more detailed features description, please refer to the manufacturer's specifications or the User's Manual.

2.

Channel List for 802.11b/g/n(20MHz)							
Channel	Frequency (MHz)	Channel	Frequency (MHz)	Channel	Frequency (MHz)	Channel	Frequency (MHz)
01	2412	04	2427	07	2442	10	2457
02	2417	05	2432	08	2447	11	2462
03	2422	06	2437	09	2452		

3.

Table for Filed Antenna

Ant	Brand	Model Name	Antenna Type	Connector	Gain (dBi)	NOTE
A	N/A	N/A	FPCB antenna	N/A	1.0	N/A

2.2 DESCRIPTION OF TEST MODES

To investigate the maximum EMI emission characteristics generates from EUT, the test system was pre-scanning tested base on the consideration of following EUT operation mode or test configuration mode which possible have effect on EMI emission level. Each of these EUT operation mode(s) or test configuration mode(s) mentioned above was evaluated respectively.

Pretest Mode	Description
Mode 1	802.11b CH1/ CH6/ CH11
Mode 2	802.11g CH1/ CH6/ CH11
Mode 3	802.11n CH1/ CH6/ CH11
Mode 4	Charge Mode

For Conducted Emission	
Final Test Mode	Description
Mode 4	Charge Mode

For Radiated Emission	
Final Test Mode	Description
Mode 1	802.11b CH1/ CH6/ CH11
Mode 2	802.11g CH1/ CH6/ CH11
Mode 3	802.11n CH1/ CH6/ CH11

Note:

- (1) The measurements are performed at the highest, middle, lowest available channels.
- (2) The measurements are performed at all Bit Rate of Transmitter, the worst data was reported

2.3 BLOCK DIGRAM SHOWING THE CONFIGURATION OF SYSTEM TESTED

Conducted Emission Test 1

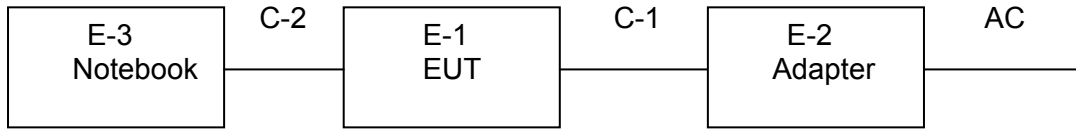

Conducted Emission Test 2

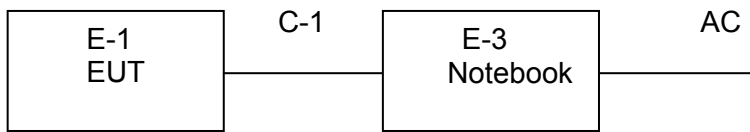

Radiated Spurious Emission Test

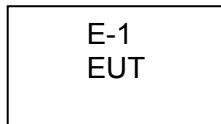

2.4 DESCRIPTION OF SUPPORT UNITS(CONDUCTED MODE)

The EUT has been tested as an independent unit together with other necessary accessories or support units. The following support units or accessories were used to form a representative test configuration during the tests.

Item	Equipment	Mfr/Brand	Model/Type No.	Series No.	Note
E-1	Epoc WIFI	N/S	W001	N/A	EUT
E-2	Adapter	N/A	YL-5V/2A-S1	N/A	
E-3	Notebook	IBM	2366	N/A	

Item	Shielded Type	Ferrite Core	Length	Note
C-1	NO	NO	0.8M	
C-2	NO	NO	0.8M	

Note:

- (1) The support equipment was authorized by Declaration of Confirmation.
- (2) For detachable type I/O cable should be specified the length in cm in 『Length』 column.

2.5 EQUIPMENTS LIST FOR ALL TEST ITEMS

Radiation Test equipment

Item	Kind of Equipment	Manufacturer	Type No.	Serial No.	Calibrated until
1	Spectrum Analyzer	Agilent	E4407B	160400005	Jul. 06. 2013
2	Test Receiver	R&S	ESPI	101318	Jul. 06. 2013
3	Bilog Antenna	TESEQ	CBL6111D	31216	Jul. 06. 2013
4	50Ω Coaxial Switch	Anritsu	MP59B	6200264416	Jul. 06. 2013
5	Spectrum Analyzer	ADVANTEST	R3132	150900201	Jul. 06. 2013
6	Horn Antenna	EM	EM-AH-10180	2011071402	Jul. 06. 2013
7	Horn Ant	Schwarzbeck	BBHA 9170	9170-181	Jul. 06. 2013
8	Amplifier	EM	EM-30180	060538	Jul. 06. 2013
9	Loop Antenna	ARA	PLA-1030/B	1029	Jul. 06. 2013
10	Power Meter	R&S	NRVS	100696	Jul. 06. 2013

Conduction Test equipment

Item	Kind of Equipment	Manufacturer	Type No.	Serial No.	Calibrated until
1	Test Receiver	R&S	ESCI	101160	Jul. 06. 2013
2	LISN	R&S	ENV216	101313	Jul. 06. 2013
3	LISN	EMCO	3816/2	00042990	Jul. 06. 2013
4	50Ω Coaxial Switch	Anritsu	MP59B	6200264417	Jul. 06. 2013
5	Passive Voltage Probe	R&S	ESH2-Z3	100196	Jul. 06. 2013
6	Absorbing clamp	R&S	MOS-21	100423	Jul. 06. 2013

3. EMC EMISSION TEST

3.1 CONDUCTED EMISSION MEASUREMENT

3.1.1 POWER LINE CONDUCTED EMISSION Limits (Frequency Range 150KHz-30MHz)

FREQUENCY (MHz)	Class A (dBuV)		Class B (dBuV)		Standard
	Quasi-peak	Average	Quasi-peak	Average	
0.15 -0.5	79.00	66.00	66 - 56 *	56 - 46 *	CISPR
0.50 -5.0	73.00	60.00	56.00	46.00	CISPR
5.0 -30.0	73.00	60.00	60.00	50.00	CISPR

0.15 -0.5	79.00	66.00	66 - 56 *	56 - 46 *	FCC
0.50 -5.0	73.00	60.00	56.00	46.00	FCC
5.0 -30.0	73.00	60.00	60.00	50.00	FCC

Note:

- (1) The tighter limit applies at the band edges.
- (2) The limit of " * " marked band means the limitation decreases linearly with the logarithm of the frequency in the range.

The following table is the setting of the receiver

Receiver Parameters	Setting
Attenuation	10 dB
Start Frequency	0.15 MHz
Stop Frequency	30 MHz
IF Bandwidth	9 kHz

3.1.2 TEST PROCEDURE

- a. The EUT was placed 0.4 meters from the horizontal ground plane with EUT being connected to the power mains through a line impedance stabilization network (LISN). All other support equipments powered from additional LISN(s). The LISN provide 50 Ohm/ 50uH of coupling impedance for the measuring instrument.
- b. Interconnecting cables that hang closer than 40 cm to the ground plane shall be folded back and forth in the center forming a bundle 30 to 40 cm long.
- c. I/O cables that are not connected to a peripheral shall be bundled in the center. The end of the cable may be terminated, if required, using the correct terminating impedance. The overall length shall not exceed 1 m.
- d. LISN at least 80 cm from nearest part of EUT chassis.
- e. For the actual test configuration, please refer to the related Item –EUT Test Photos.

3.1.3 DEVIATION FROM TEST STANDARD

No deviation

3.1.4 TEST SETUP

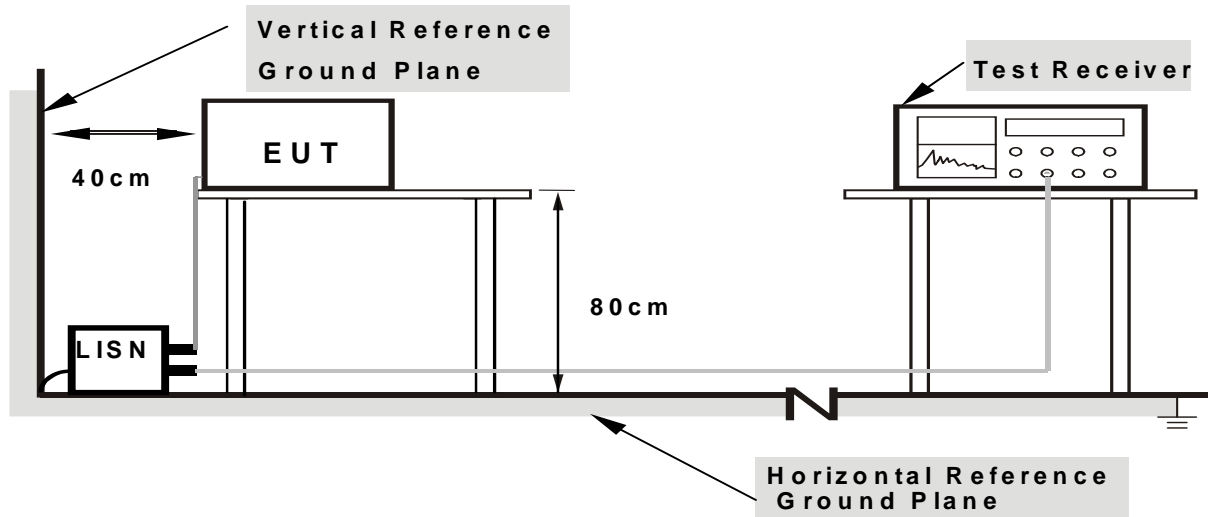

- Note:**
- 1. Support units were connected to second LISN.
 - 2. Both of LISNs (AMN) are 80 cm from EUT and at least 80 from other units and other metal planes

3.1.5 EUT OPERATING CONDITIONS

The EUT was configured for testing in a typical fashion (as a customer would normally use it). The EUT has been programmed to continuously transmit during test. This operating condition was tested and used to collect the included data.

3.1.6 TEST RESULTS

EUT :	Epoc WIFI	Model Name. :	W001
Temperature :	26 °C	Relative Humidity :	54%
Pressure :	1010hPa	Phase :	L
Test Voltage :	DC 5V from Adapter AC 120V/60Hz	Test Mode :	Mode 4

Frequency (MHz)	Meter Reading (dBμV)	Factor (dB)	Emission Level (dBμV)	Limits (dBμV)	Margin (dB)	Detector Type
0.3659	34.37	10.42	44.79	58.59	-13.8	QP
0.378	25.93	10.42	36.35	48.32	-11.97	AVG
4.6698	10.86	10.64	21.5	46	-24.5	AVG
4.7099	22.79	10.64	33.43	56	-22.57	QP
18.9298	6.61	10.73	17.34	50	-32.66	AVG
20.574	19.13	10.74	29.87	60	-30.13	QP

Remark:

1. All readings are Quasi-Peak and Average values.
2. Factor = Insertion Loss + Cable Loss.

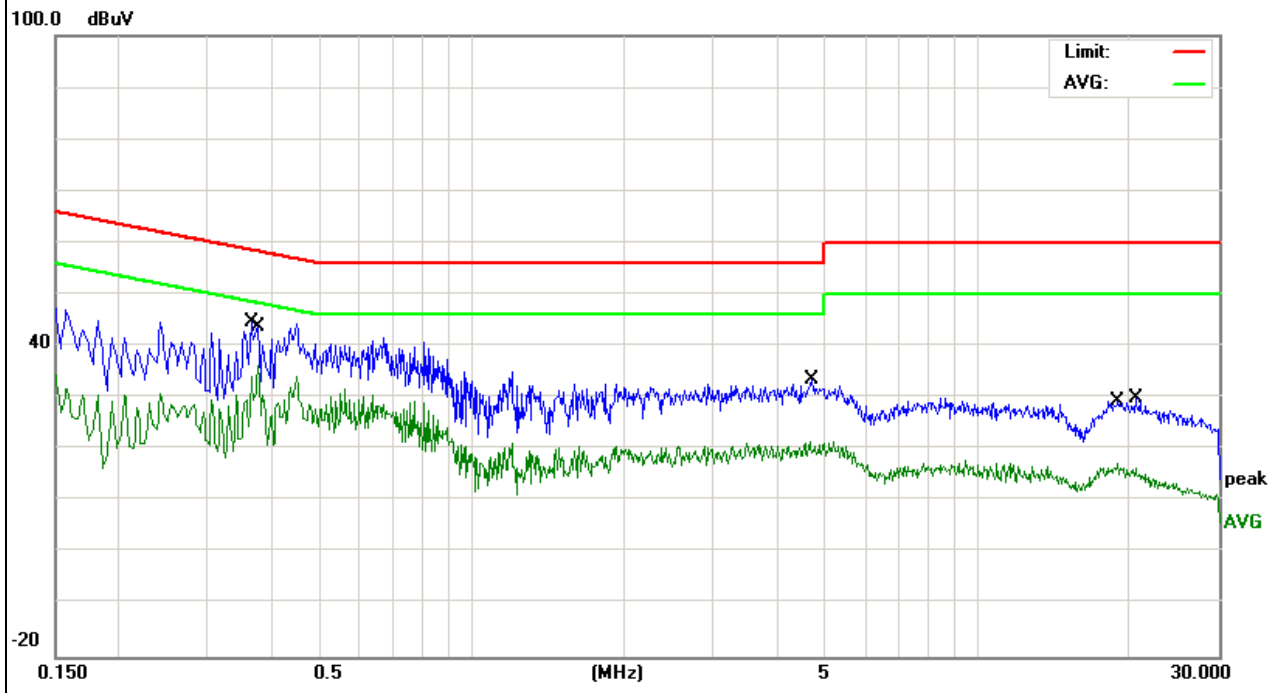

EUT :	Epoc WIFI	Model Name. :	W001
Temperature :	26 °C	Relative Humidity :	54%
Pressure :	1010hPa	Phase :	N
Test Voltage :	DC 5V from Adapter AC 120V/60Hz	Test Mode :	Mode 4

Frequency (MHz)	Meter Reading (dBμV)	Factor (dB)	Emission Level (dBμV)	Limits (dBμV)	Margin (dB)	Detector Type
0.4139	32.04	10.41	42.45	57.57	-15.12	QP
0.4139	19.09	10.41	29.5	47.57	-18.07	AVG
4.3738	6.04	10.64	16.68	46	-29.32	AVG
5.1258	18.44	10.64	29.08	60	-30.92	QP
19.1938	2.87	10.73	13.6	50	-36.4	AVG
19.5579	16.86	10.74	27.6	60	-32.4	QP

Remark:
 1. All readings are Quasi-Peak and Average values.
 2. Factor = Insertion Loss + Cable Loss.

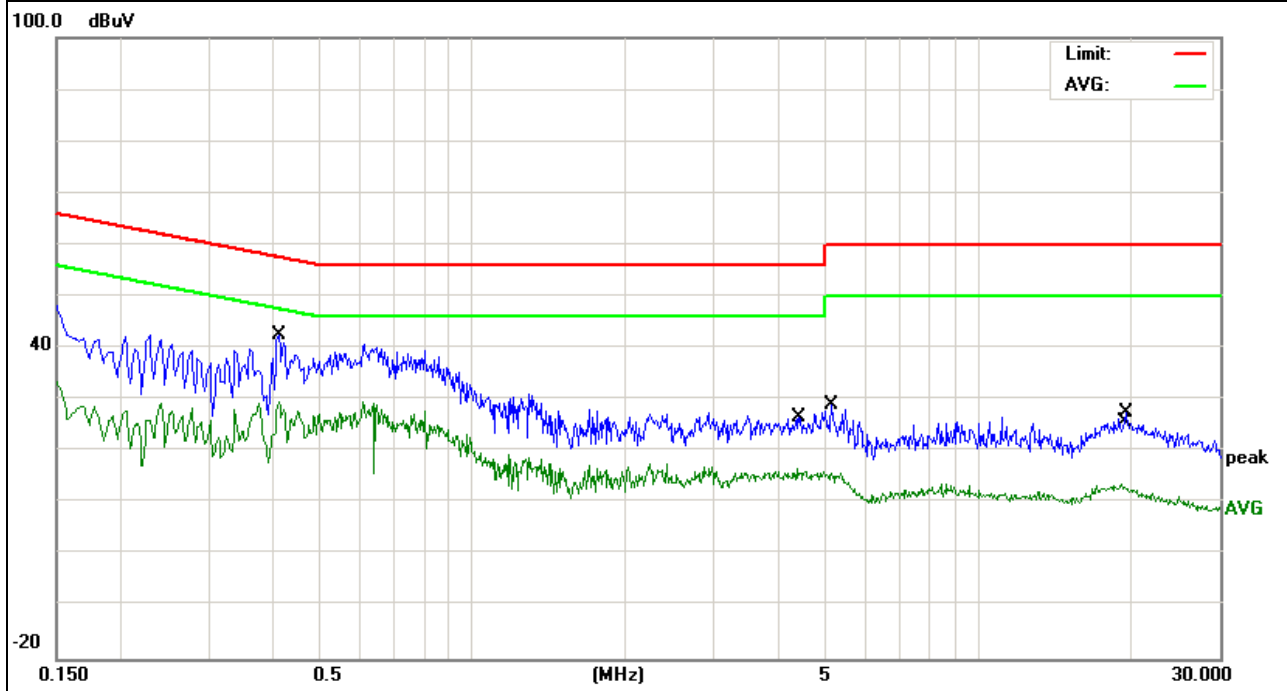

EUT :	Epoc WIFI	Model Name. :	W001
Temperature :	26 °C	Relative Humidity :	54%
Pressure :	1010hPa	Phase :	L
Test Voltage :	(DC 5V from PC) AC 120V/60Hz	Test Mode :	Mode 4

Frequency (MHz)	Meter Reading (dBμV)	Factor (dB)	Emission Level (dBμV)	Limits (dBμV)	Margin (dB)	Detector Type
0.1539	47.6	11.03	58.63	65.78	-7.15	QP
0.1539	36.78	11.03	47.81	55.78	-7.97	AVG
0.206	37.05	10.43	47.48	63.36	-15.88	QP
0.21	31.36	10.43	41.79	53.2	-11.41	AVG
18.846	18.47	10.76	29.23	50	-20.77	AVG
19.03	34.19	10.76	44.95	60	-15.05	QP

Remark:

1. All readings are Quasi-Peak and Average values.
2. Factor = Insertion Loss + Cable Loss.

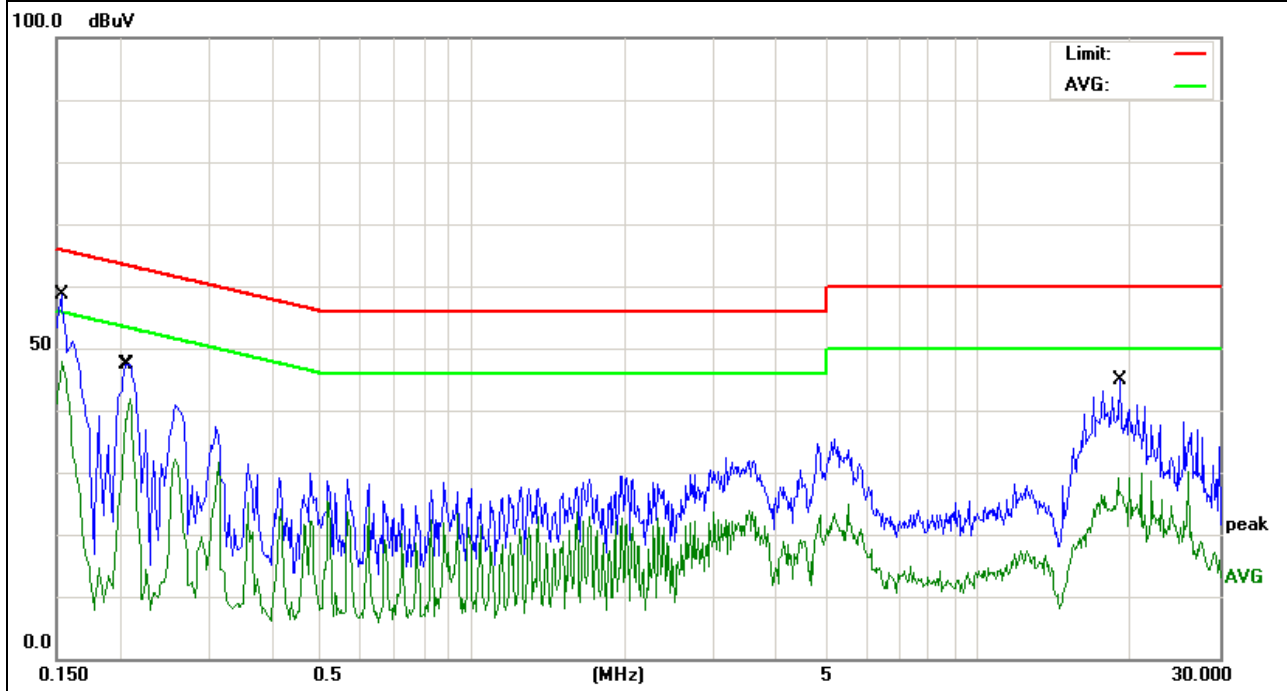

EUT :	Epoc WIFI	Model Name. :	W001
Temperature :	26 °C	Relative Humidity :	54%
Pressure :	1010hPa	Phase :	N
Test Voltage :	(DC 5V from PC) AC 120V/60Hz	Test Mode :	Mode 4

Frequency (MHz)	Meter Reading (dBμV)	Factor (dB)	Emission Level (dBμV)	Limits (dBμV)	Margin (dB)	Detector Type
0.1539	36.55	11.17	47.72	55.78	-8.06	AVG
0.162	46.7	10.45	57.15	65.36	-8.21	QP
17.5459	35.36	10.72	46.08	60	-13.92	QP
18.85	18.81	10.73	29.54	50	-20.46	AVG

Remark:

1. All readings are Quasi-Peak and Average values.
2. Factor = Insertion Loss + Cable Loss.

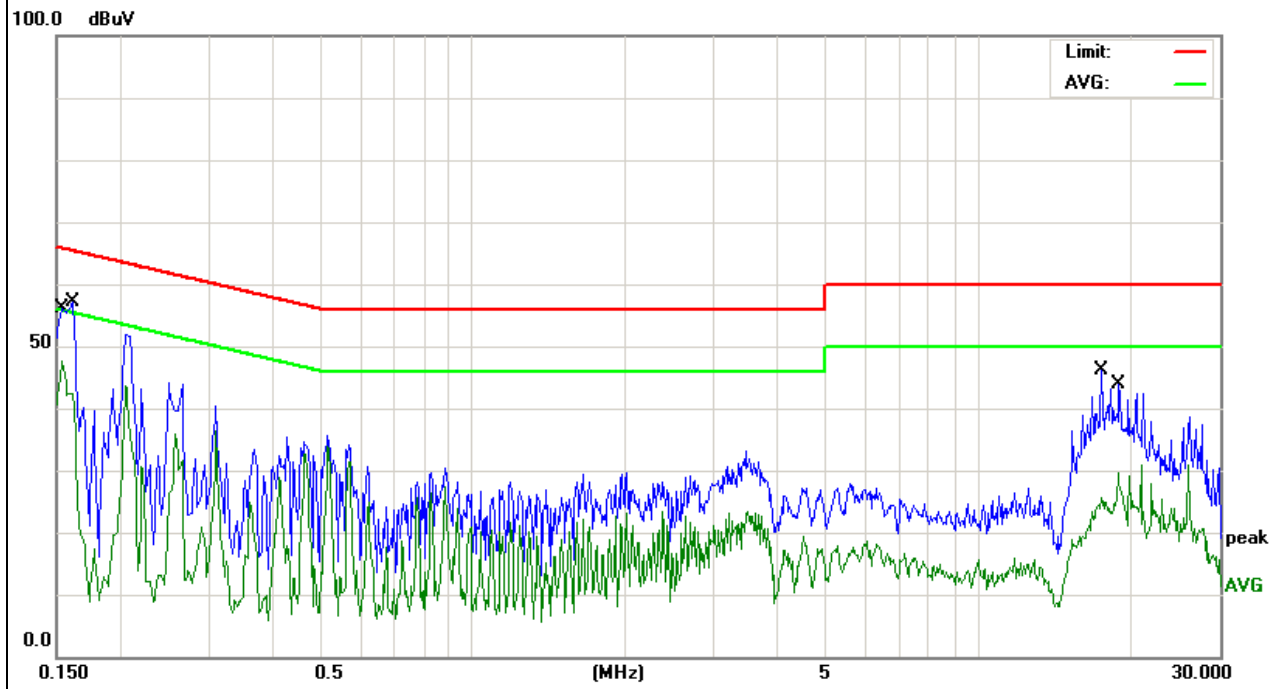

3.2 RADIATED EMISSION MEASUREMENT

3.2.1 RADIATED EMISSION LIMITS (Frequency Range 9kHz-1000MHz)

20dBc in any 100 kHz bandwidth outside the operating frequency band. In case the emission fall within the restricted band specified on 15.205(a), then the 15.209(a) limit in the table below has to be followed.

Frequencies (MHz)	Field Strength (micorvolts/meter)	Measurement Distance (meters)
0.009~0.490	2400/F(KHz)	300
0.490~1.705	24000/F(KHz)	30
1.705~30.0	30	30
30~88	100	3
88~216	150	3
216~960	200	3
Above 960	500	3

LIMITS OF RADIATED EMISSION MEASUREMENT (Above 1000MHz)

FREQUENCY (MHz)	Class A (dBuV/m) (at 3M)		Class B (dBuV/m) (at 3M)	
	PEAK	AVERAGE	PEAK	AVERAGE
Above 1000	80	60	74	54

Notes:

- (1) The limit for radiated test was performed according to FCC PART 15C.
- (2) The tighter limit applies at the band edges.
- (3) Emission level (dBuV/m)=20log Emission level (uV/m).

Spectrum Parameter	Setting
Attenuation	Auto
Start Frequency	1000 MHz
Stop Frequency	10th carrier harmonic
RB / VB (emission in restricted band)	1 MHz / 1 MHz for Peak, 1 MHz / 10Hz for Average

Receiver Parameter	Setting
Attenuation	Auto
Start ~ Stop Frequency	9kHz~150kHz / RB 200Hz for QP
Start ~ Stop Frequency	150kHz~30MHz / RB 9kHz for QP
Start ~ Stop Frequency	30MHz~1000MHz / RB 120kHz for QP

3.2.2 TEST PROCEDURE

- a. The measuring distance of at 3 m shall be used for measurements at frequency up to 1GHz. For frequencies above 1GHz, any suitable measuring distance may be used.
- b. The EUT was placed on the top of a rotating table 0.8 meters above the ground at a 3 meter open area test site. The table was rotated 360 degrees to determine the position of the highest radiation.
- c. The height of the equipment or of the substitution antenna shall be 0.8 m; the height of the test antenna shall vary between 1 m to 4 m. Both horizontal and vertical polarizations of the antenna are set to make the measurement.
- d. The initial step in collecting conducted emission data is a spectrum analyzer peak detector mode pre-scanning the measurement frequency range. Significant peaks are then marked and then Quasi Peak detector mode re-measured.
- e. If the Peak Mode measured value compliance with and lower than Quasi Peak Mode Limit, the EUT shall be deemed to meet QP Limits and then no additional QP Mode measurement performed.
- f. For the actual test configuration, please refer to the related Item –EUT Test Photos.

Note:

Both horizontal and vertical antenna polarities were tested and performed pretest to three orthogonal axis. The worst case emissions were reported

3.2.3 DEVIATION FROM TEST STANDARD

No deviation

3.2.4 TEST SETUP

(A) Radiated Emission Test-Up Frequency Below 30MHz

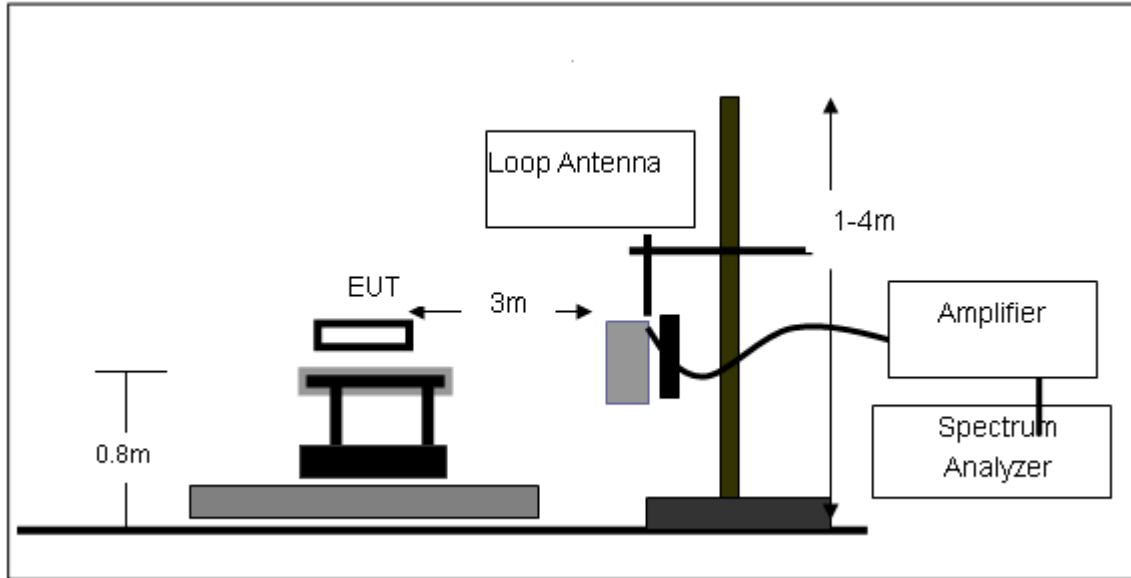

(B) Radiated Emission Test-Up Frequency 30MHz~1GHz

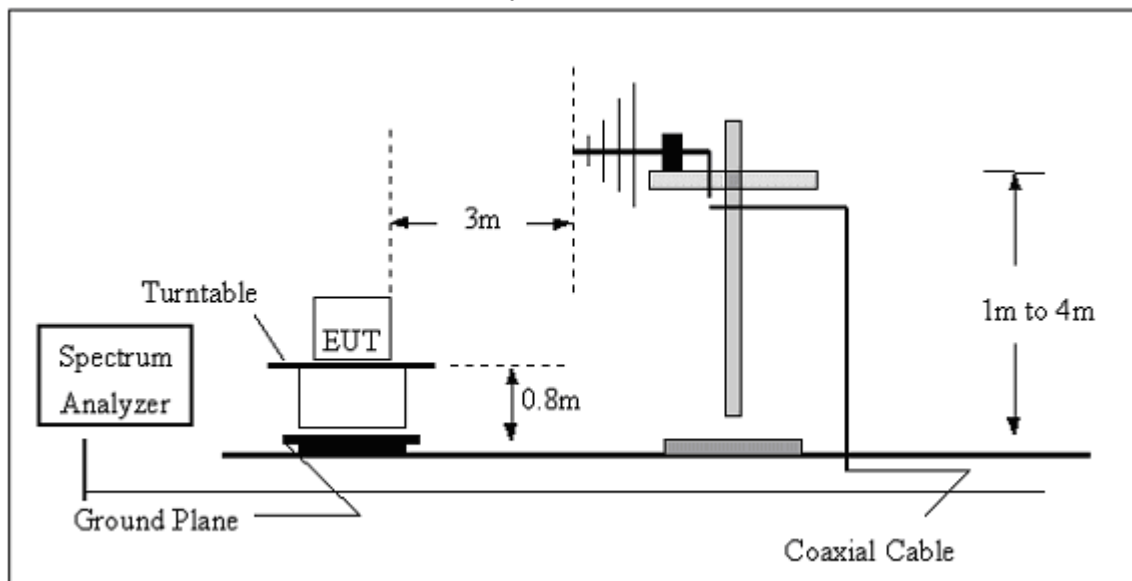

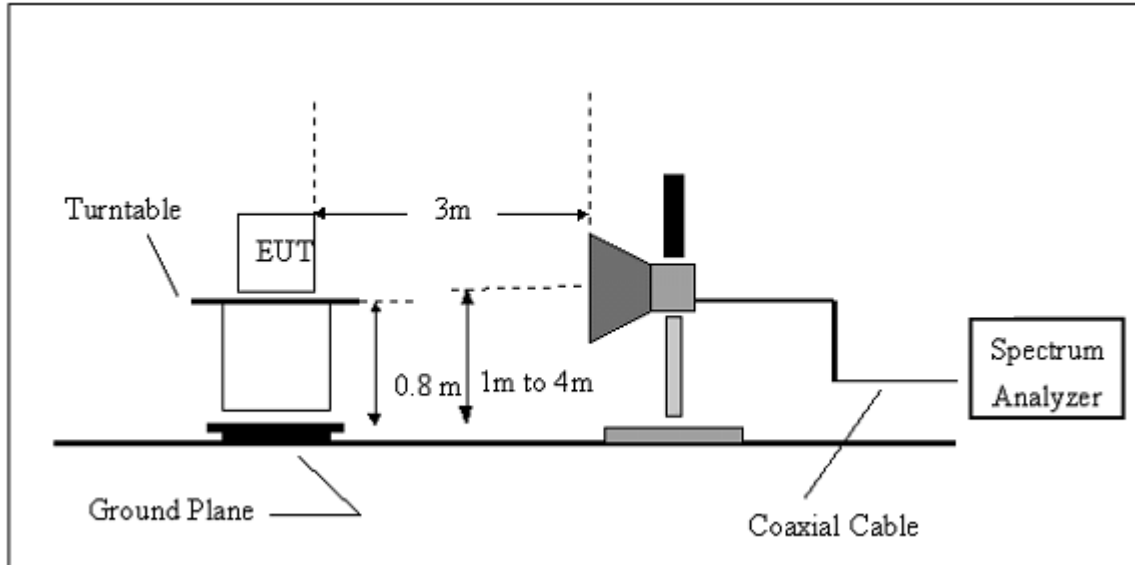
(C) Radiated Emission Test-Up Frequency Above 1GHz**3.2.5 EUT OPERATING CONDITIONS**

The EUT tested system was configured as the statements of 2.4 Unless otherwise a special operating condition is specified in the follows during the testing.

3.2.6 TEST RESULTS (BETWEEN 9KHZ – 30 MHZ)

EUT:	Epoc WIFI	Model Name. :	W001
Temperature:	20 °C	Relative Humidity:	48%
Pressure:	1010 hPa	Test Voltage :	DC 3.7V
Test Mode :	TX	Polarization :	--

Freq. (MHz)	Reading (dBuV/m)	Limit (dBuV/m)	Margin (dB)	State P/F
--	--	--	--	PASS
--	--	--	--	PASS

NOTE:

The amplitude of spurious emissions which are attenuated by more than 20dB below the permissible value has no need to be reported.

Distance extrapolation factor = $20 \log (\text{specific distance}/\text{test distance})(\text{dB})$;

Limit line = specific limits(dBuv) + distance extrapolation factor.

3.2.7 TEST RESULTS (BETWEEN 30MHZ – 1GHZ)

EUT :	Epoc WIFI	Model Name :	W001
Temperature :	20 °C	Relative Humidity :	48%
Pressure :	1010 hPa	Test Voltage :	DC 3.7V
Test Mode :	TX	Polarization :	Horizontal

Frequency (MHz)	Meter Reading (dBμV)	Factor (dB)	Emission Level (dBμV/m)	Limits (dBμV/m)	Margin (dB)	Detector Type
43.6584	21.58	11.35	32.93	40	-7.07	QP
74.3953	28.48	6.65	35.13	40	-4.87	QP
116.132	25.39	11.71	37.1	43.5	-6.4	QP
205.675	27.09	8.95	36.04	43.5	-7.46	QP
245.09	25.34	12.31	37.65	46	-8.35	QP
406.088	17.56	17.48	35.04	46	-10.96	QP

Remark:
Factor = Antenna Factor + Cable Loss – Pre-amplifier.

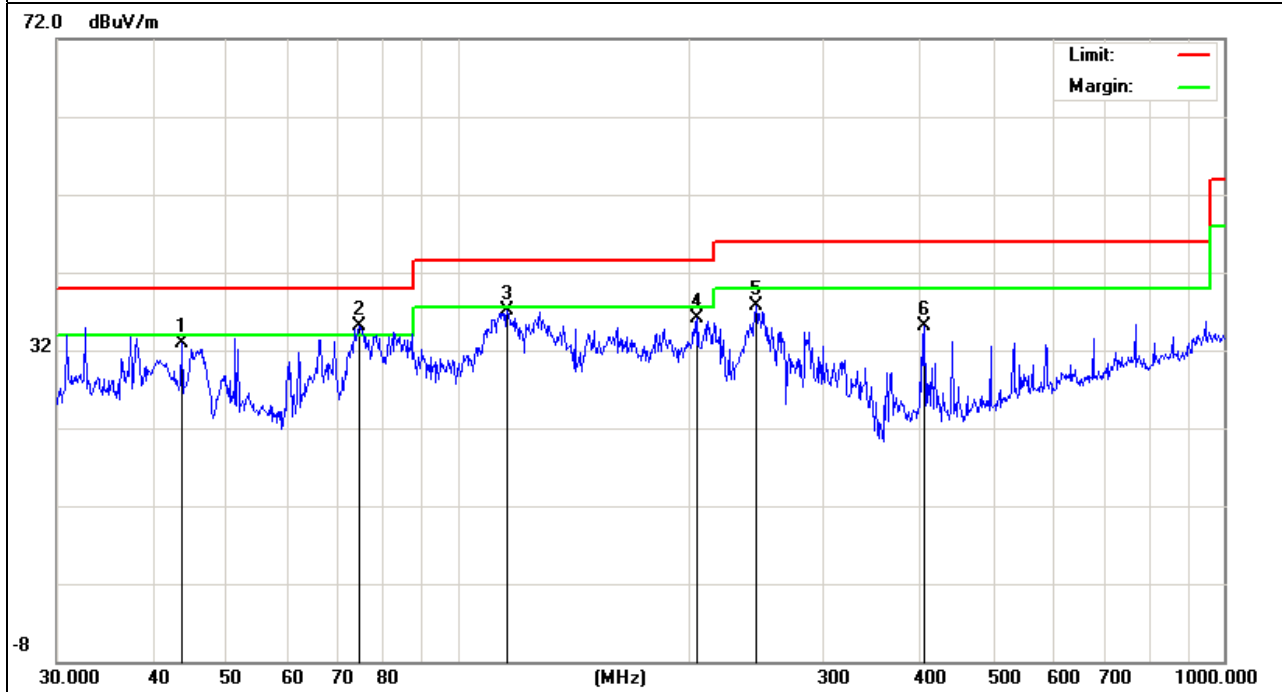

EUT :	Epoc WIFI	Model Name :	W001
Temperature :	20 °C	Relative Humidity :	48%
Pressure :	1010 hPa	Test Voltage :	DC 3.7V
Test Mode :	TX	Polarization :	Vertical

Frequency (MHz)	Meter Reading (dBμV)	Factor (dB)	Emission Level (dBμV/m)	Limits (dBμV/m)	Margin (dB)	Detector Type
75.1822	29.44	6.78	36.22	40	-3.78	QP
118.6013	23.96	11.75	35.71	43.5	-7.79	QP
159.225	25.52	10.76	36.28	43.5	-7.22	QP
211.5264	27.99	9.36	37.35	43.5	-6.15	QP
246.8148	24.98	12.57	37.55	46	-8.45	QP
408.946	23.15	17.61	40.76	46	-5.24	QP

Remark:
Factor = Antenna Factor + Cable Loss – Pre-amplifier.

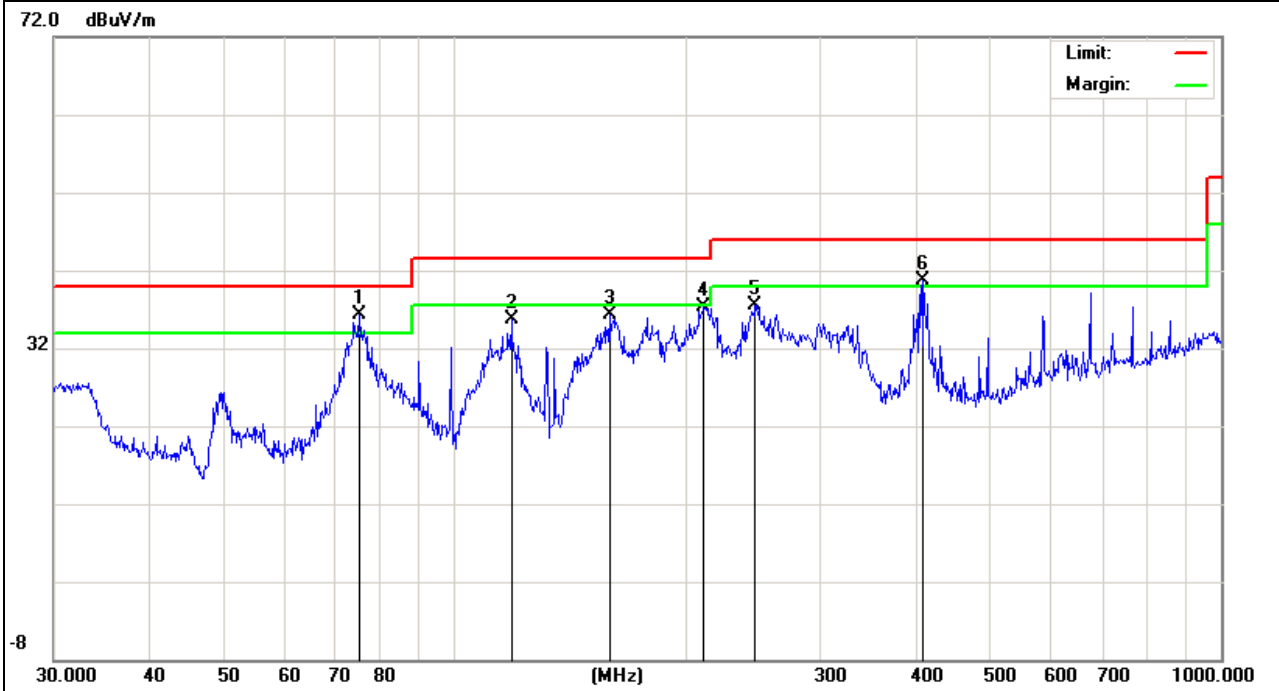

3.2.8 TEST RESULTS (ABOVE 1000 MHZ)

EUT :	Epoc WIFI	Model Name :	W001
Temperature :	20 °C	Relative Humidity :	48%
Pressure :	1010 hPa	Test Voltage :	DC 3.7V
Test Mode :	CH1 (802.11b Mode)	Polarization :	Horizontal

Frequency (MHz)	Meter Reading (dBμV)	Factor (dB)	Emission Level (dBμV/m)	Limits (dBμV/m)	Margin (dB)	Detector Type
4824.188	51.38	10.44	61.82	74	-12.18	peak
4824.188	33.91	10.44	44.35	54	-9.65	AVG
7236.253	43.1	12.39	55.49	74	-18.51	peak
7236.253	29.14	12.39	41.53	54	-12.47	AVG

Remark:
 Factor = Antenna Factor + Cable Loss – Pre-amplifier.

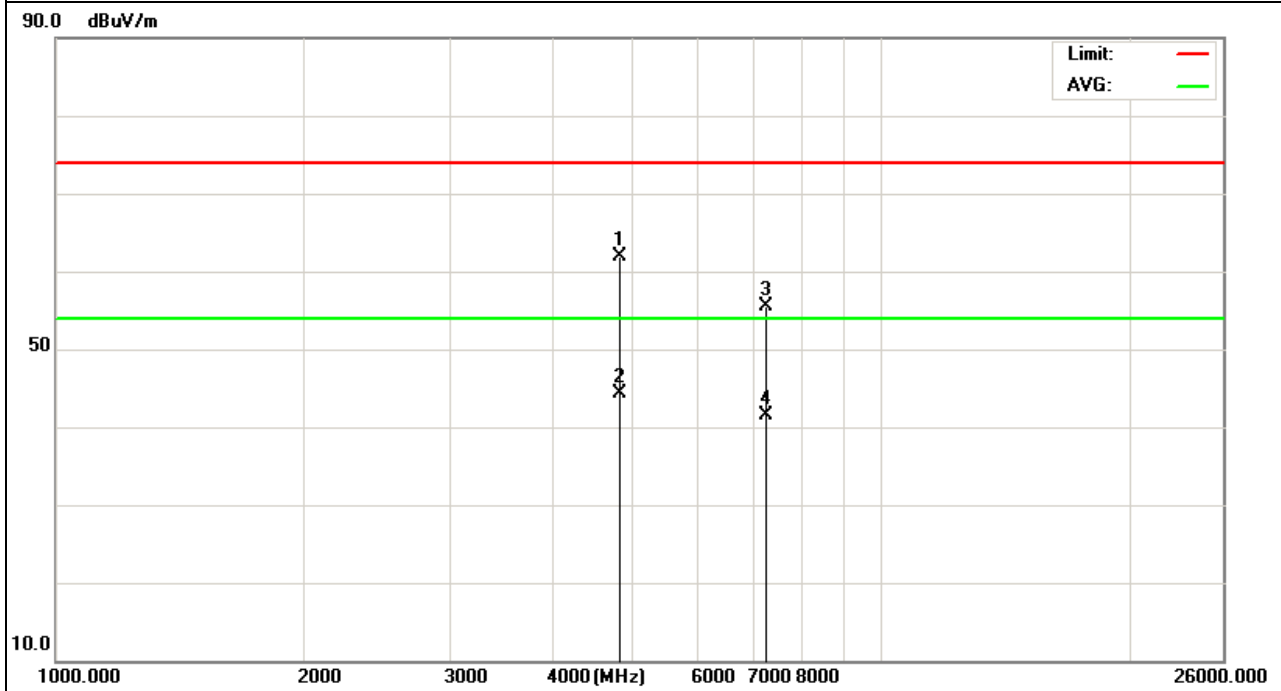

EUT :	Epoc WIFI	Model Name :	W001
Temperature :	20 °C	Relative Humidity :	48%
Pressure :	1010 hPa	Test Voltage :	DC 3.7V
Test Mode :	CH1 (802.11b Mode)	Polarization :	Vertical

Frequency (MHz)	Meter Reading (dBμV)	Factor (dB)	Emission Level (dBμV/m)	Limits (dBμV/m)	Margin (dB)	Detector Type
4874.237	50.94	10.4	61.34	74	-12.66	peak
4874.237	32.11	10.4	42.51	54	-11.49	AVG
7311.345	41.47	12.75	54.22	74	-19.78	peak
7311.345	28.13	12.75	40.88	54	-13.12	AVG

Remark:
Factor = Antenna Factor + Cable Loss – Pre-amplifier.

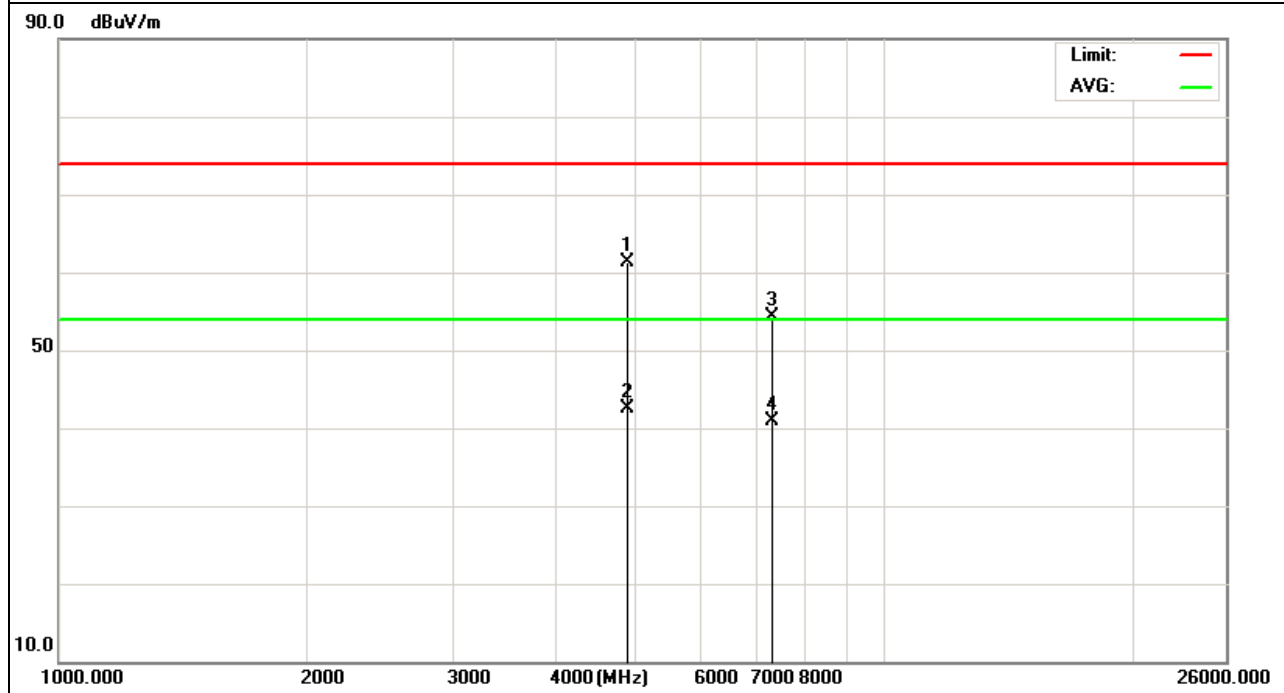

EUT :	Epoc WIFI	Model Name :	W001
Temperature :	20 °C	Relative Humidity :	48%
Pressure :	1010 hPa	Test Voltage :	DC 3.7V
Test Mode :	CH6 (802.11b Mode)	Polarization :	Horizontal

Frequency (MHz)	Meter Reading (dBμV)	Factor (dB)	Emission Level (dBμV/m)	Limits (dBμV/m)	Margin (dB)	Detector Type
4874.624	50.91	10.4	61.31	74	-12.69	peak
4874.624	33.34	10.4	43.74	54	-10.26	AVG
7311.255	42.53	12.75	55.28	74	-18.72	peak
7311.255	29.87	12.75	42.62	54	-11.38	AVG

Remark:
Factor = Antenna Factor + Cable Loss – Pre-amplifier.

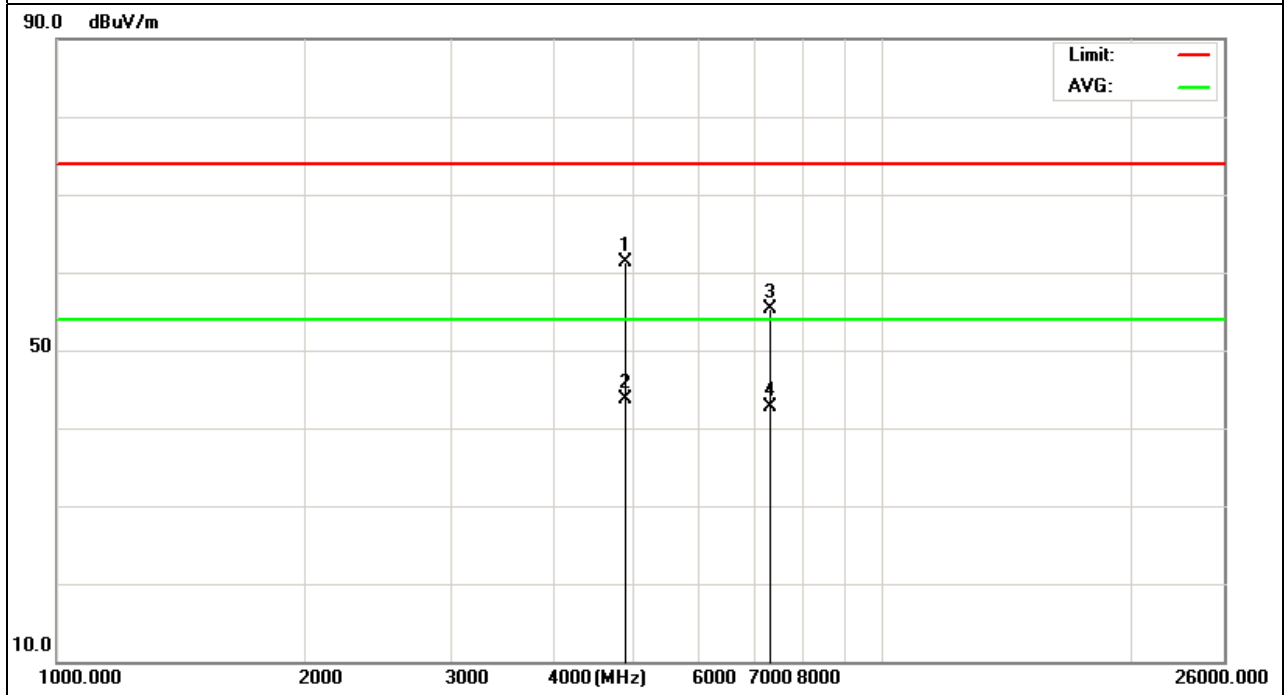

EUT :	Epoc WIFI	Model Name :	W001
Temperature :	20 °C	Relative Humidity :	48%
Pressure :	1010 hPa	Test Voltage :	DC 3.7V
Test Mode :	CH6 (802.11b Mode)	Polarization :	Vertical

Frequency (MHz)	Meter Reading (dBμV)	Factor (dB)	Emission Level (dBμV/m)	Limits (dBμV/m)	Margin (dB)	Detector Type
4924.148	51.13	10.39	61.52	74	-12.48	peak
4934.148	32.21	10.44	42.65	54	-11.35	AVG
7386.262	43.11	12.68	55.79	74	-18.21	peak
7386.262	27.55	12.68	40.23	54	-13.77	AVG

Remark:

Factor = Antenna Factor + Cable Loss – Pre-amplifier.

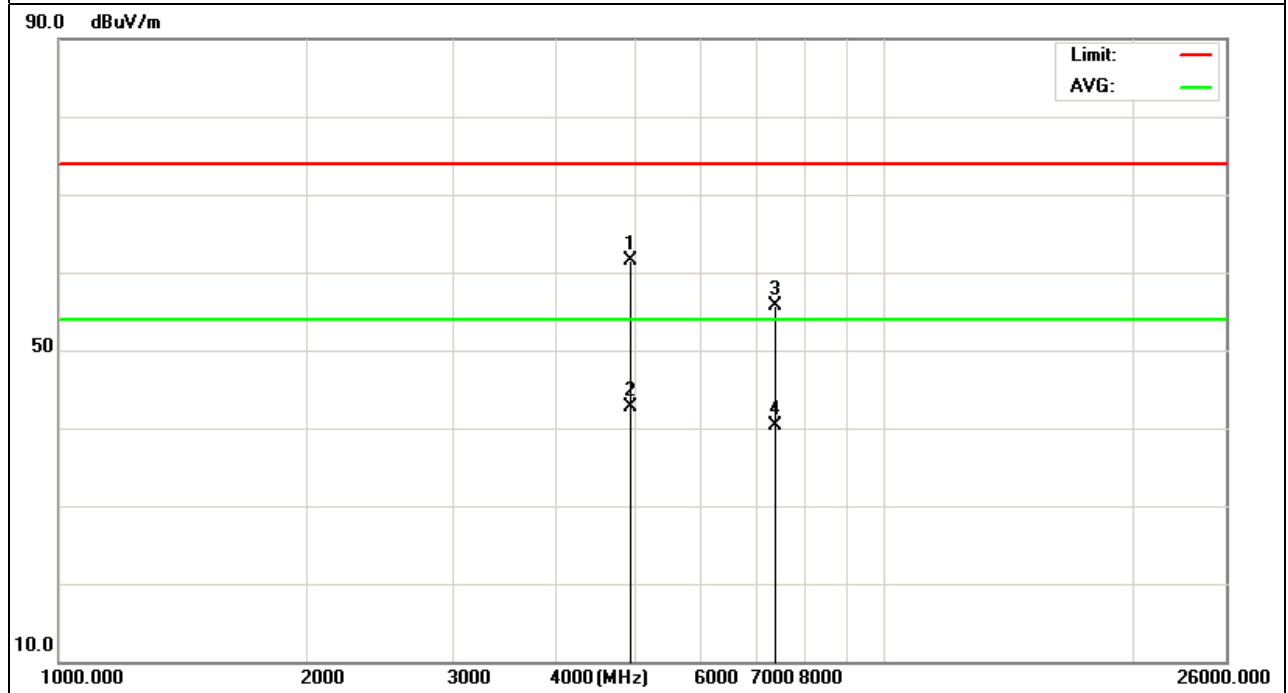

EUT :	Epoc WIFI	Model Name :	W001
Temperature :	20 °C	Relative Humidity :	48%
Pressure :	1010 hPa	Test Voltage :	DC 3.7V
Test Mode :	CH11 (802.11b Mode)	Polarization :	Horizontal

Frequency (MHz)	Meter Reading (dBµV)	Factor (dB)	Emission Level (dBµV/m)	Limits (dBµV/m)	Margin (dB)	Detector Type
4924.525	50.79	10.39	61.18	74	-12.82	peak
4924.525	33.21	10.39	43.6	54	-10.4	AVG
7386.379	43.08	12.69	55.77	74	-18.23	peak
7386.379	28.98	12.69	41.67	54	-12.33	AVG

Remark:

- Factor = Antenna Factor + Cable Loss – Pre-amplifier.
- No emission detected above 18GHz

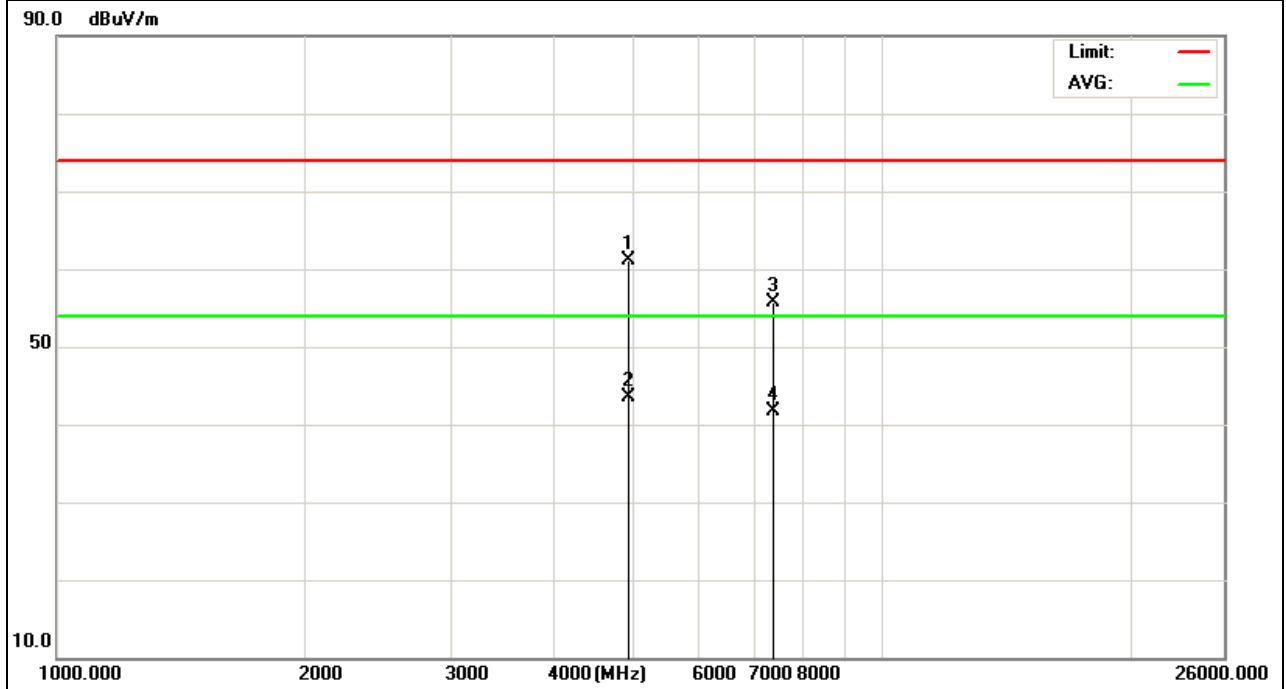

EUT :	Epoc WIFI	Model Name :	W001
Temperature :	20 °C	Relative Humidity :	48%
Pressure :	1010 hPa	Test Voltage :	DC 3.7V
Test Mode :	CH11 (802.11b Mode)	Polarization :	Vertical

Frequency (MHz)	Meter Reading (dBμV)	Factor (dB)	Emission Level (dBμV/m)	Limits (dBμV/m)	Margin (dB)	Detector Type
4924.275	52.16	10.39	62.55	74	-11.45	peak
4924.275	32.29	10.39	42.68	54	-11.32	AVG
7386.331	43.06	12.68	55.74	74	-18.26	peak
7386.331	28.2	12.68	40.88	54	-13.12	AVG

Remark:
Factor = Antenna Factor + Cable Loss – Pre-amplifier.

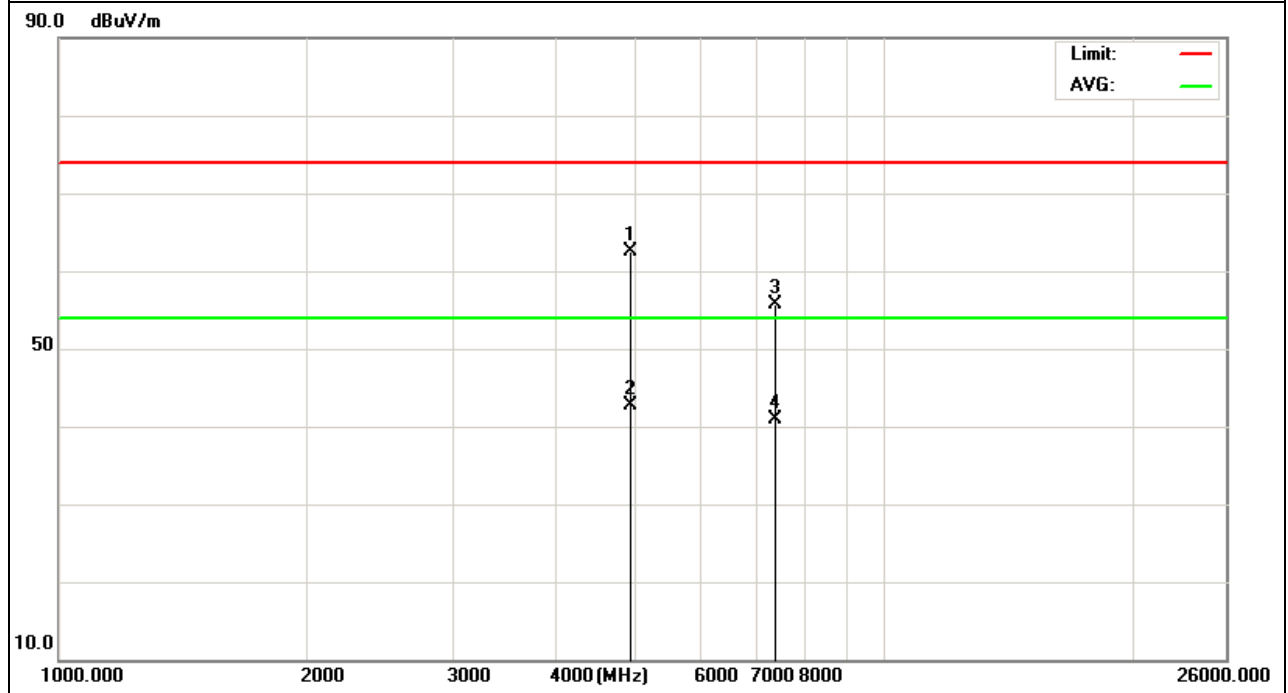

EUT :	Epoc WIFI	Model Name :	W001
Temperature :	20 °C	Relative Humidity :	48%
Pressure :	1010 hPa	Test Voltage :	DC 3.7V
Test Mode :	CH1 (802.11g Mode)	Polarization :	Horizontal

Frequency (MHz)	Meter Reading (dBμV)	Factor (dB)	Emission Level (dBμV/m)	Limits (dBμV/m)	Margin (dB)	Detector Type
4824.374	46.98	10.44	57.42	74	-16.58	peak
4824.374	30.89	10.44	41.33	54	-12.67	AVG
7236.462	40.82	12.39	53.21	74	-20.79	peak
7236.462	27.82	12.39	40.21	54	-13.79	AVG

Remark:
Factor = Antenna Factor + Cable Loss – Pre-amplifier.

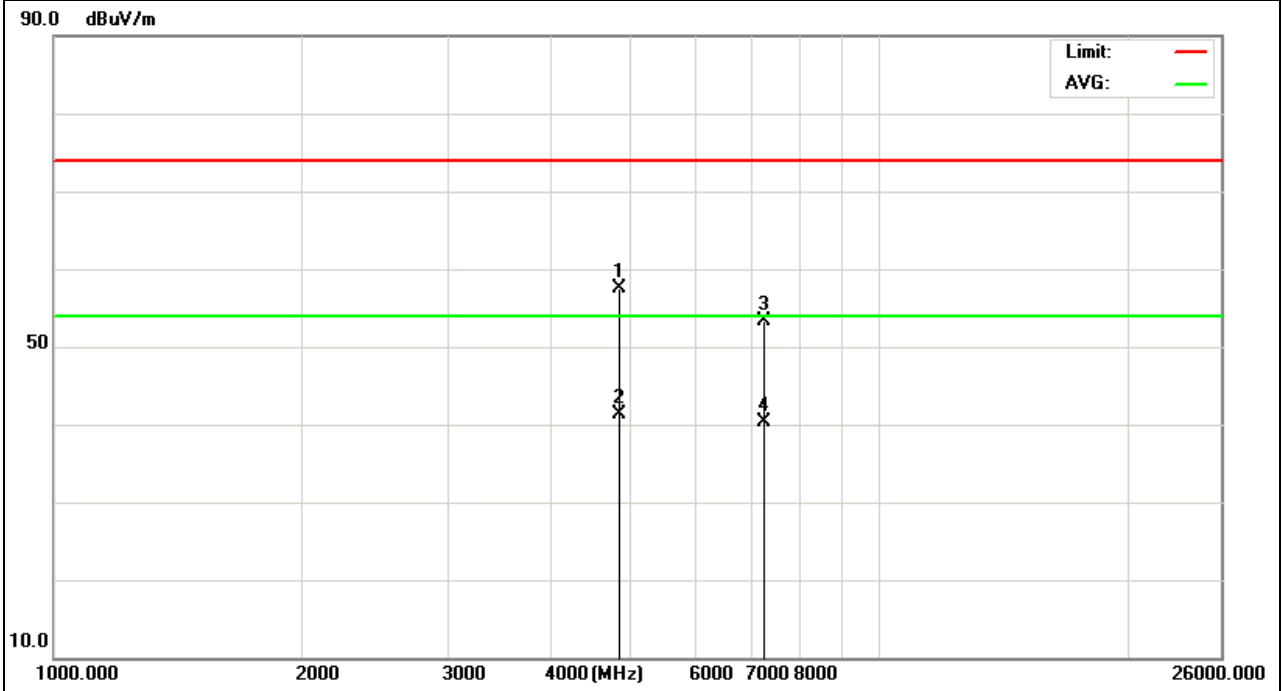

EUT :	Epoc WIFI	Model Name :	W001
Temperature :	20 °C	Relative Humidity :	48%
Pressure :	1010 hPa	Test Voltage :	DC 3.7V
Test Mode :	CH1 (802.11g Mode)	Polarization :	Vertical

Frequency (MHz)	Meter Reading (dBμV)	Factor (dB)	Emission Level (dBμV/m)	Limits (dBμV/m)	Margin (dB)	Detector Type
4824.14	47	10.44	57.44	74	-16.56	peak
4824.14	31.39	10.44	41.83	54	-12.17	AVG
7236.139	41.59	12.39	53.98	74	-20.02	peak
7236.139	28.38	12.39	40.77	54	-13.23	AVG

Remark:
Factor = Antenna Factor + Cable Loss – Pre-amplifier.

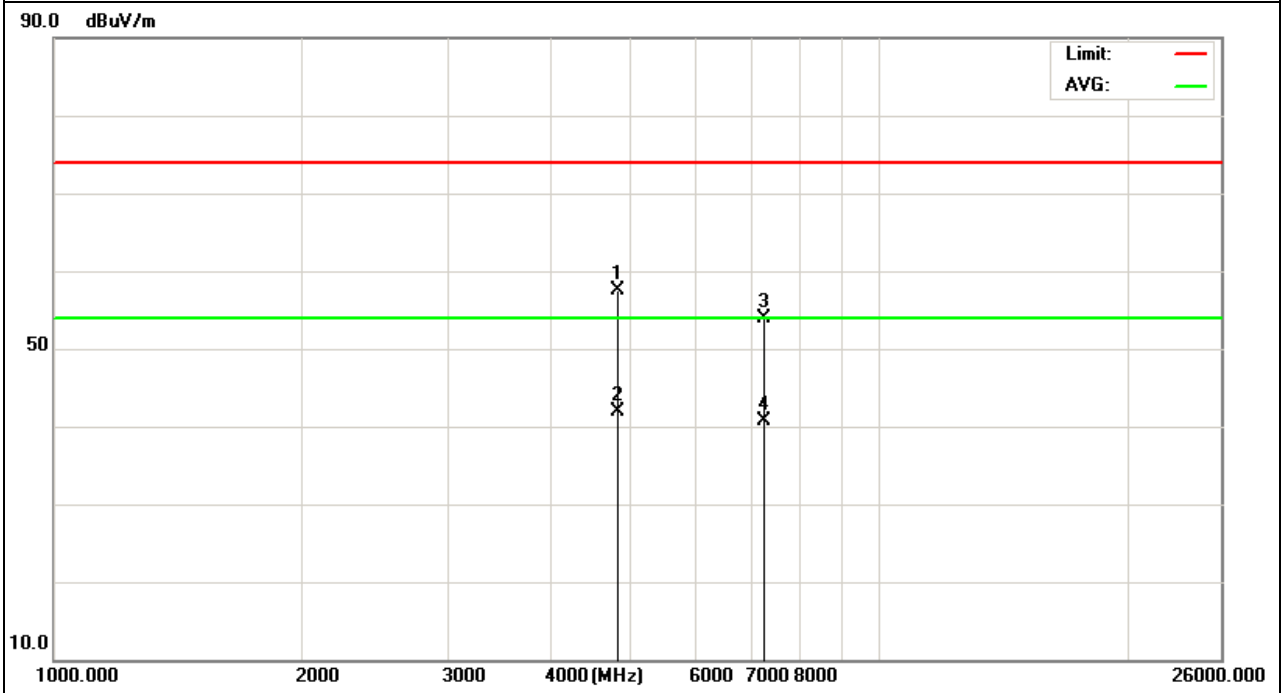

EUT :	Epoc WIFI	Model Name :	W001
Temperature :	20 °C	Relative Humidity :	48%
Pressure :	1010 hPa	Test Voltage :	DC 3.7V
Test Mode :	CH6 (802.11g Mode)	Polarization :	Horizontal

Frequency (MHz)	Meter Reading (dBμV)	Factor (dB)	Emission Level (dBμV/m)	Limits (dBμV/m)	Margin (dB)	Detector Type
4874.374	50.02	10.4	60.42	74	-13.58	peak
4874.374	32.59	10.4	42.99	54	-11.01	AVG
7311.244	41.93	12.75	54.68	74	-19.32	peak
7311.244	29.18	12.75	41.93	54	-12.07	AVG

Remark:
Factor = Antenna Factor + Cable Loss – Pre-amplifier.

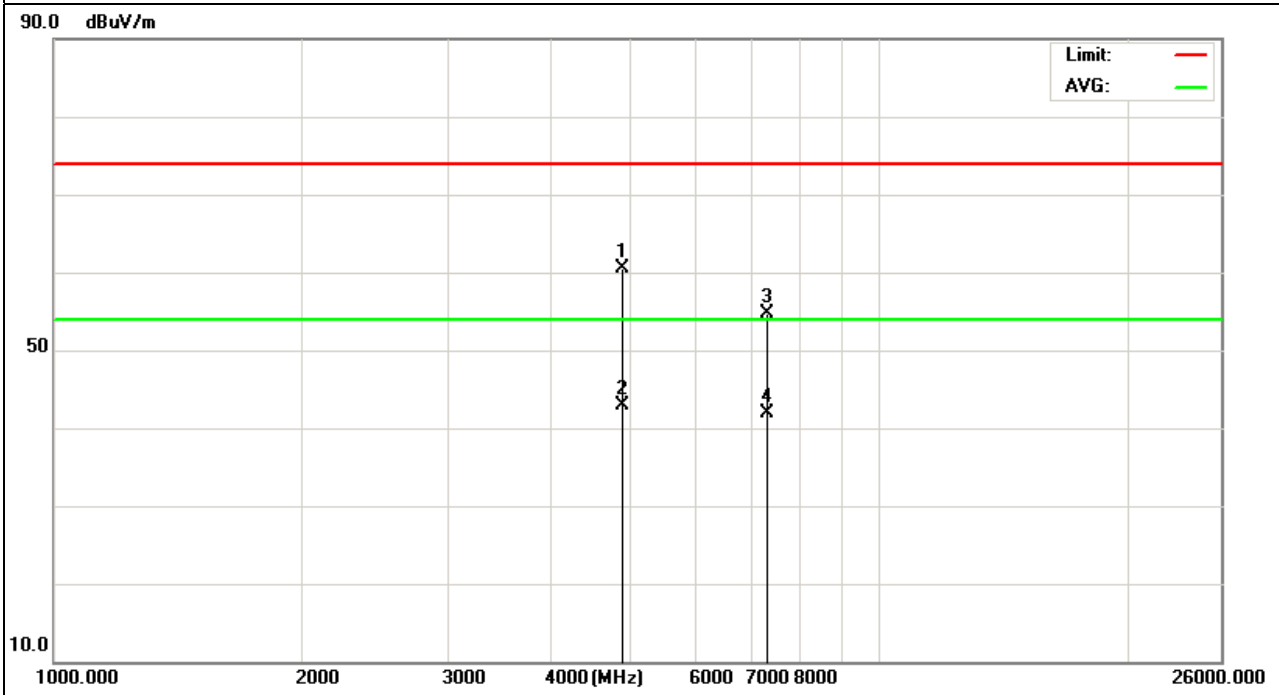

EUT :	Epoc WIFI	Model Name :	W001
Temperature :	20 °C	Relative Humidity :	48%
Pressure :	1010 hPa	Test Voltage :	DC 3.7V
Test Mode :	CH6 (802.11g Mode)	Polarization :	Vertical

Frequency (MHz)	Meter Reading (dBμV)	Factor (dB)	Emission Level (dBμV/m)	Limits (dBμV/m)	Margin (dB)	Detector Type
4874.158	50.41	10.4	60.81	74	-13.19	peak
4874.158	32.49	10.4	42.89	54	-11.11	AVG
7311.352	42.73	12.75	55.48	74	-18.52	peak
7311.352	28.48	12.75	41.23	54	-12.77	AVG

Remark:
Factor = Antenna Factor + Cable Loss – Pre-amplifier.

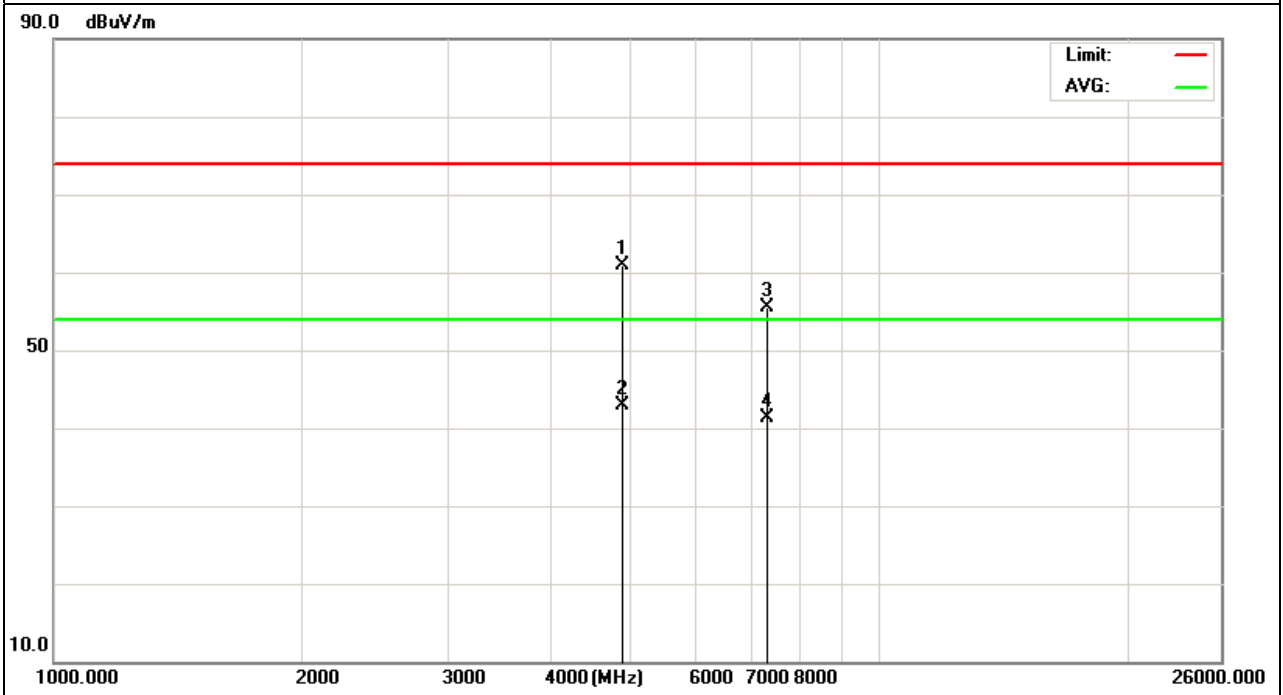

EUT :	Epoc WIFI	Model Name :	W001
Temperature :	20 °C	Relative Humidity :	48%
Pressure :	1010 hPa	Test Voltage :	DC 3.7V
Test Mode :	CH11 (802.11g Mode)	Polarization :	Horizontal

Frequency (MHz)	Meter Reading (dBµV)	Factor (dB)	Emission Level (dBµV/m)	Limits (dBµV/m)	Margin (dB)	Detector Type
4924.07	48.33	10.39	58.72	74	-15.28	peak
4924.07	32.83	10.39	43.22	54	-10.78	AVG
7386.221	43.11	12.68	55.79	74	-18.21	peak
7386.221	29.91	12.68	42.59	54	-11.41	AVG

Remark:
Factor = Antenna Factor + Cable Loss – Pre-amplifier.

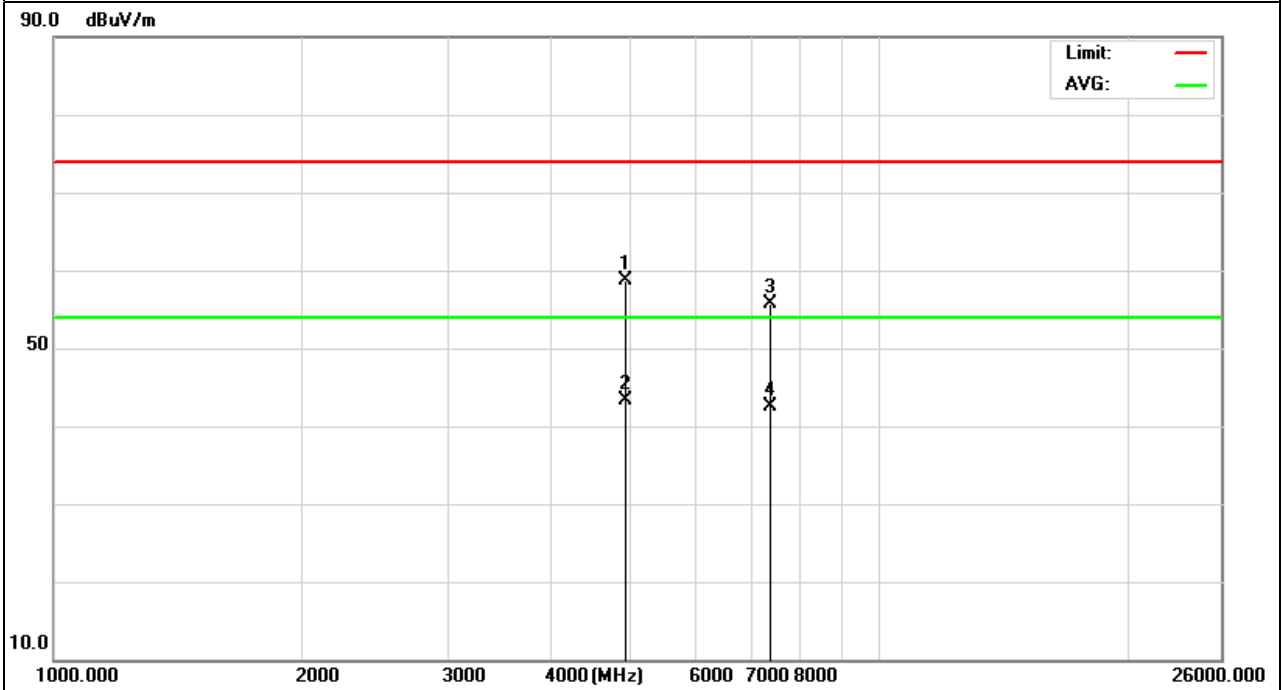

EUT :	Epoc WIFI	Model Name :	W001
Temperature :	20 °C	Relative Humidity :	48%
Pressure :	1010 hPa	Test Voltage :	DC 3.7V
Test Mode :	CH11(802.11g Mode)	Polarization :	Vertical

Frequency (MHz)	Meter Reading (dBµV)	Factor (dB)	Emission Level (dBµV/m)	Limits (dBµV/m)	Margin (dB)	Detector Type
4924.369	50.09	10.39	60.48	74	-13.52	peak
4924.369	33.24	10.39	43.63	54	-10.37	AVG
7386.118	43.11	12.68	55.79	74	-18.21	peak
7386.118	31.15	12.68	43.83	54	-10.17	AVG

Remark:
Factor = Antenna Factor + Cable Loss – Pre-amplifier.

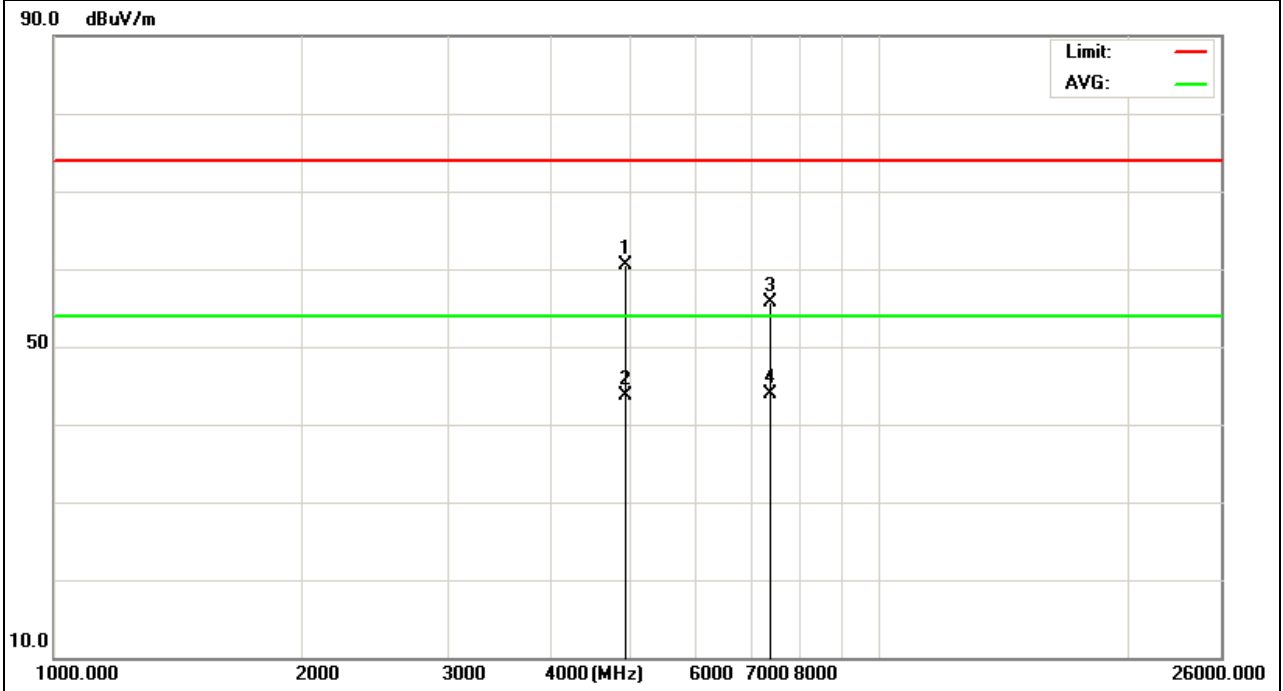

EUT :	Epoc WIFI	Model Name :	W001
Temperature :	20 °C	Relative Humidity :	48%
Pressure :	1010 hPa	Test Voltage :	DC 3.7V
Test Mode :	CH1 (802.11n Mode)	Polarization :	Horizontal

Frequency (MHz)	Meter Reading (dBμV)	Factor (dB)	Emission Level (dBμV/m)	Limits (dBμV/m)	Margin (dB)	Detector Type
4824.189	50	10.44	60.44	74	-13.56	peak
4824.189	33.31	10.44	43.75	54	-10.25	AVG
7236.362	42.53	12.39	54.92	74	-19.08	peak
7236.362	30.76	12.39	43.15	54	-10.85	AVG

Remark:
Factor = Antenna Factor + Cable Loss – Pre-amplifier.

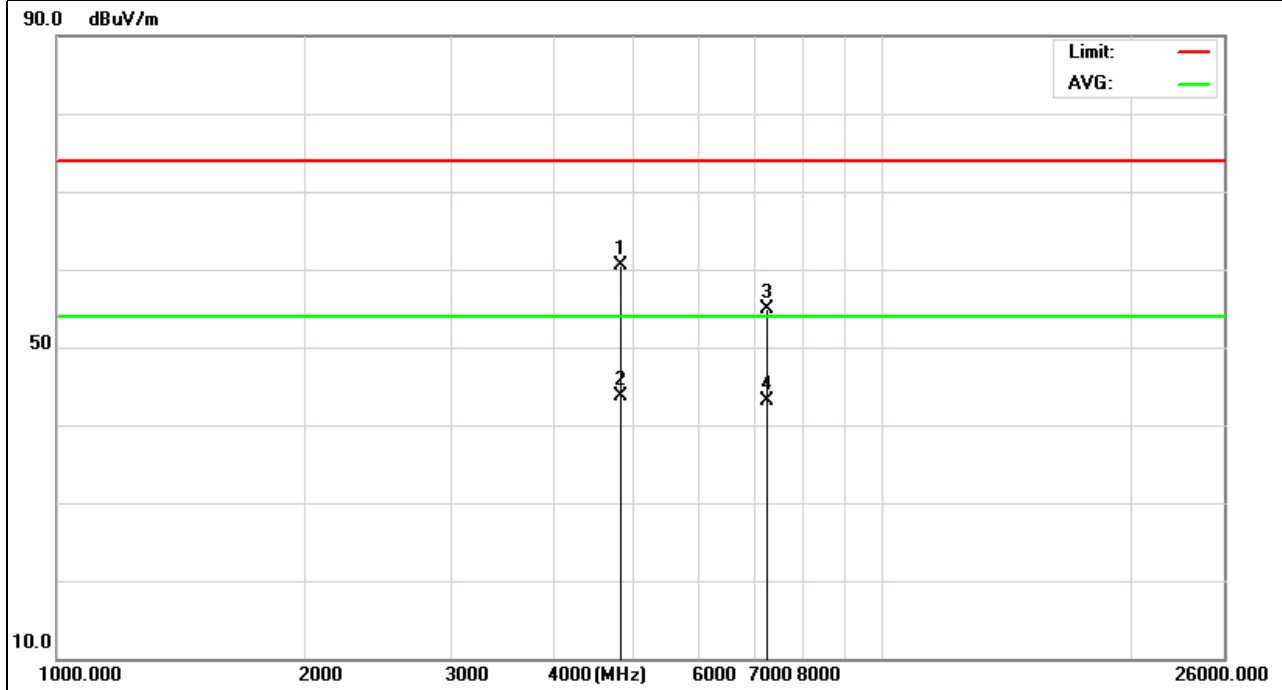

EUT :	Epoc WIFI	Model Name :	W001
Temperature :	20 °C	Relative Humidity :	48%
Pressure :	1010 hPa	Test Voltage :	DC 3.7V
Test Mode :	CH1 (802.11n Mode)	Polarization :	Vertical

Frequency (MHz)	Meter Reading (dBμV)	Factor (dB)	Emission Level (dBμV/m)	Limits (dBμV/m)	Margin (dB)	Detector Type
4824.089	48.04	10.44	58.48	74	-15.52	peak
4824.089	32.23	10.44	42.67	54	-11.33	AVG
7236.117	42.57	12.39	54.96	74	-19.04	peak
7236.117	30.19	12.39	42.58	54	-11.42	AVG

Remark:
Factor = Antenna Factor + Cable Loss – Pre-amplifier.

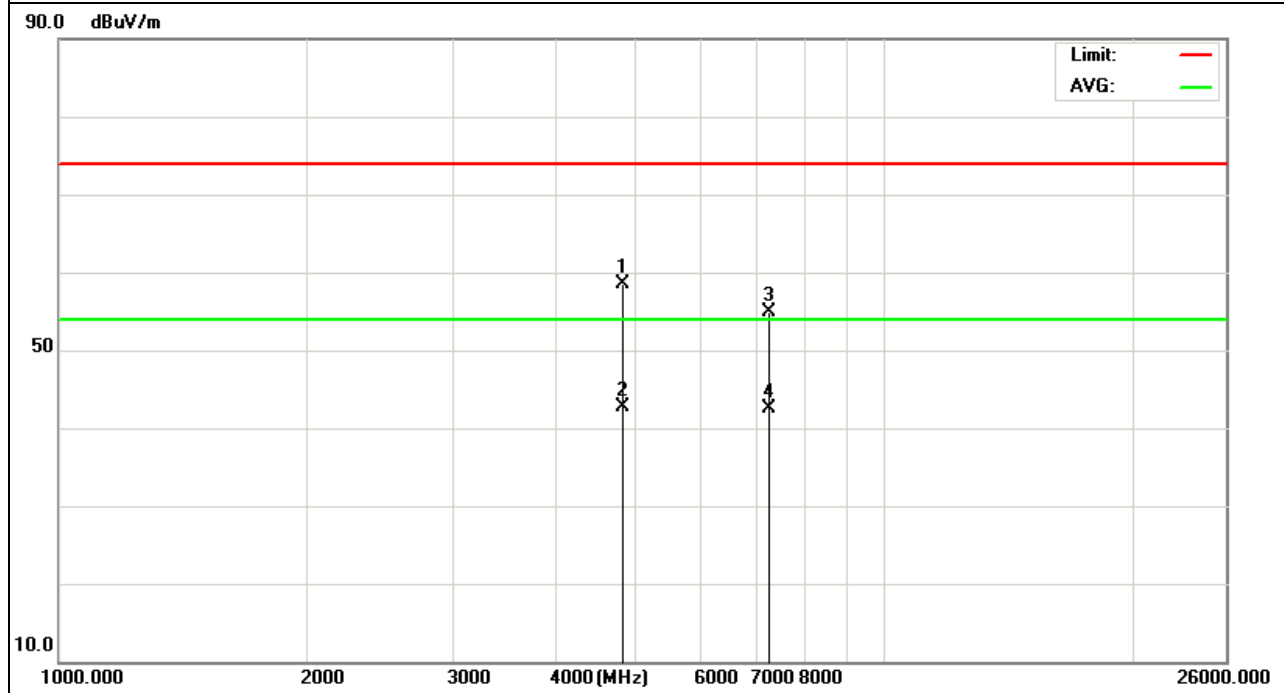

EUT :	Epoc WIFI	Model Name :	W001
Temperature :	20 °C	Relative Humidity :	48%
Pressure :	1010 hPa	Test Voltage :	DC 3.7V
Test Mode :	CH6 (802.11n Mode)	Polarization :	Horizontal

Frequency (MHz)	Meter Reading (dBμV)	Factor (dB)	Emission Level (dBμV/m)	Limits (dBμV/m)	Margin (dB)	Detector Type
4874.128	49.51	10.4	59.91	74	-14.09	peak
4874.128	31.26	10.4	41.66	54	-12.34	AVG
7311.263	42.68	12.75	55.43	74	-18.57	peak
7311.263	28.93	12.75	41.68	54	-12.32	AVG

Remark:
Factor = Antenna Factor + Cable Loss – Pre-amplifier.

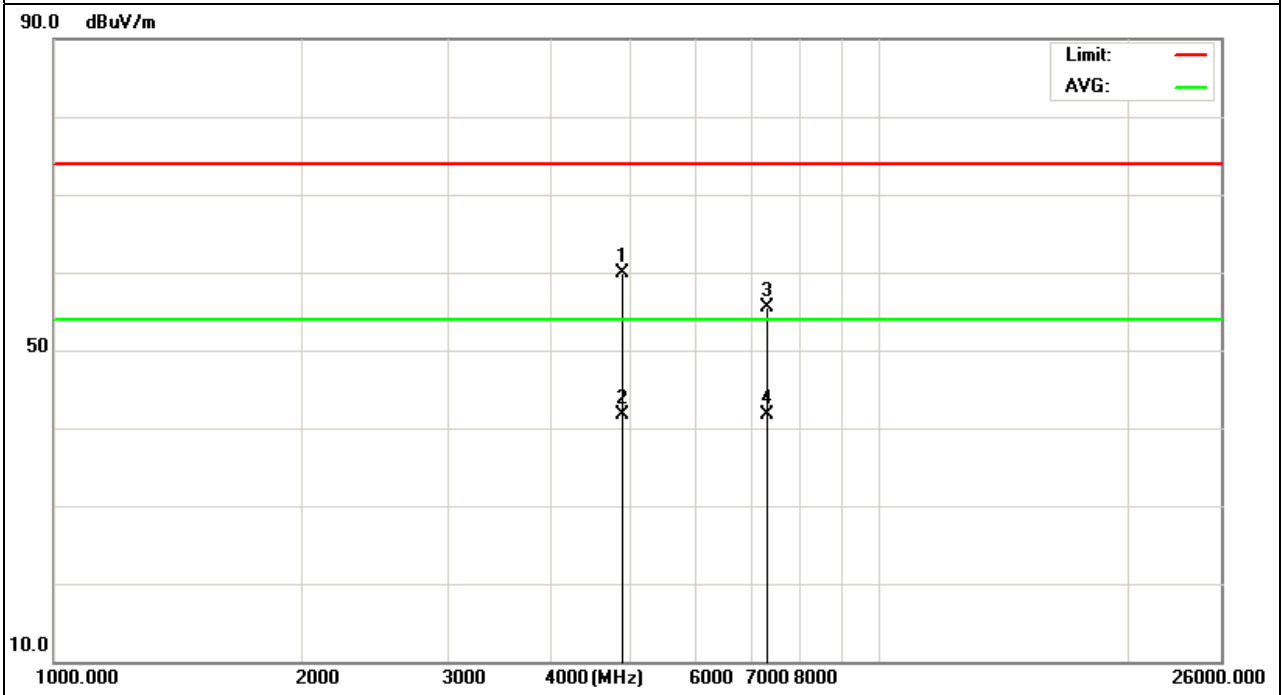

EUT :	Epoc WIFI	Model Name :	W001
Temperature :	20 °C	Relative Humidity :	48%
Pressure :	1010 hPa	Test Voltage :	DC 3.7V
Test Mode :	CH6 (802.11n Mode)	Polarization :	Vertical

Frequency (MHz)	Meter Reading (dBμV)	Factor (dB)	Emission Level (dBμV/m)	Limits (dBμV/m)	Margin (dB)	Detector Type
4874.183	49.05	10.4	59.45	74	-14.55	peak
4874.183	31.48	10.4	41.88	54	-12.12	AVG
7311.265	43.01	12.75	55.76	74	-18.24	peak
7311.265	27.67	12.75	40.42	54	-13.58	AVG

Remark:

Factor = Antenna Factor + Cable Loss – Pre-amplifier.

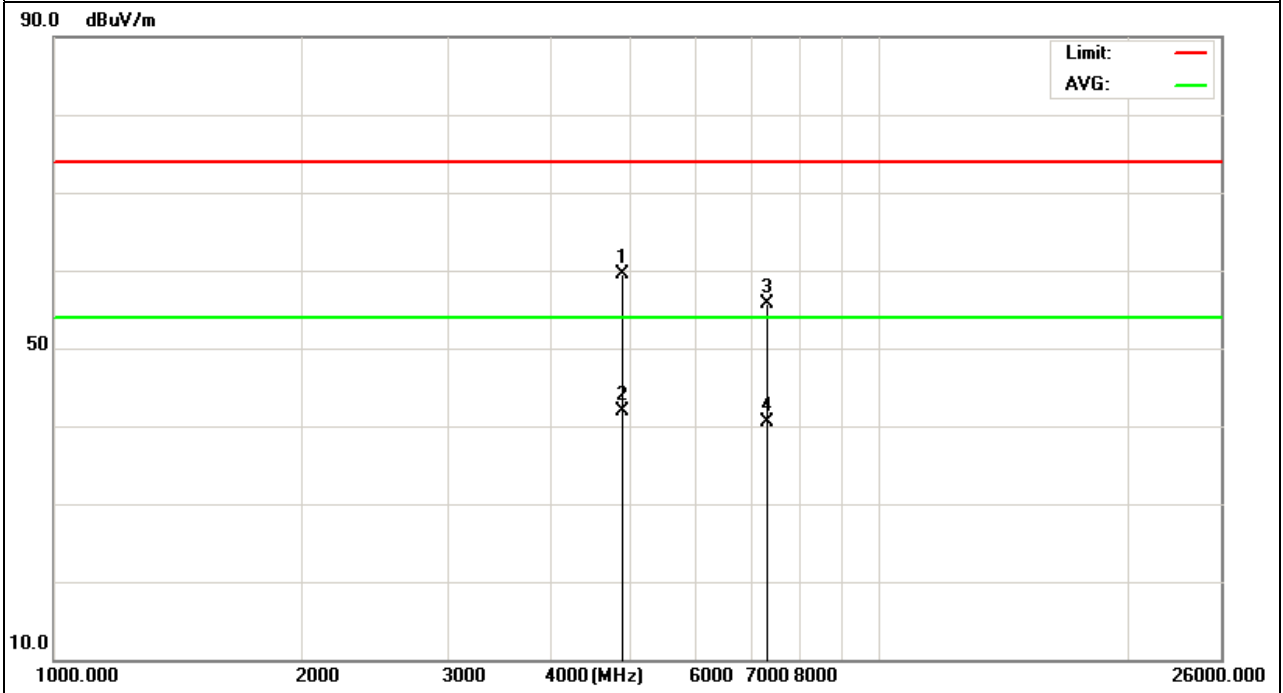

EUT :	Epoc WIFI	Model Name :	W001
Temperature :	20 °C	Relative Humidity :	48%
Pressure :	1010 hPa	Test Voltage :	DC 3.7V
Test Mode :	CH11 (802.11n Mode)	Polarization :	Horizontal

Frequency (MHz)	Meter Reading (dBµV)	Factor (dB)	Emission Level (dBµV/m)	Limits (dBµV/m)	Margin (dB)	Detector Type
4924.239	49.86	10.39	60.25	74	-13.75	peak
4924.239	31.98	10.39	42.37	54	-11.63	AVG
7386.474	42.98	12.68	55.66	74	-18.34	peak
7386.474	28.67	12.68	41.35	54	-12.65	AVG

Remark:

- 3. Factor = Antenna Factor + Cable Loss – Pre-amplifier.
- 4. No emission detected above 18GHz

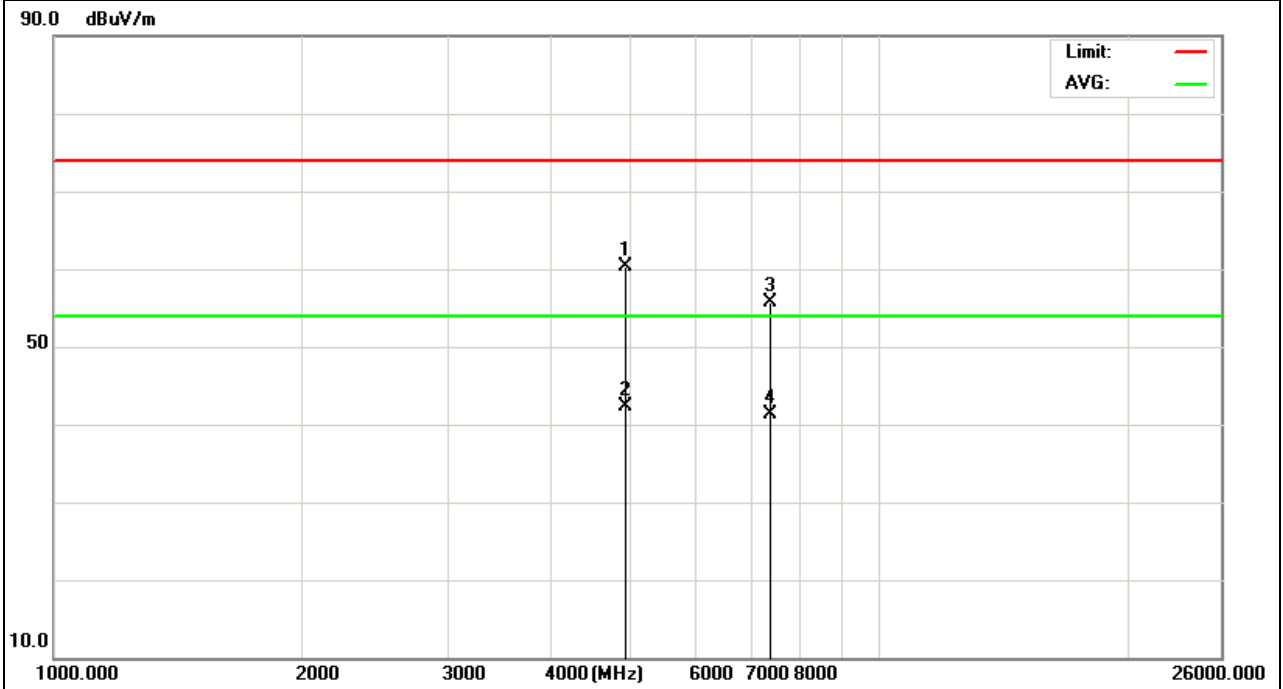

EUT :	Epoc WIFI	Model Name :	W001
Temperature :	20 °C	Relative Humidity :	48%
Pressure :	1010 hPa	Test Voltage :	DC 3.7V
Test Mode :	CH11 (802.11n Mode)	Polarization :	Vertical

Frequency (MHz)	Meter Reading (dBμV)	Factor (dB)	Emission Level (dBμV/m)	Limits (dBμV/m)	Margin (dB)	Detector Type
4924.382	48.97	10.39	59.36	74	-14.64	peak
4924.382	32.48	10.39	42.87	54	-11.13	AVG
7386.266	43.75	12.68	56.43	74	-17.57	peak
7386.266	27.74	12.68	40.42	54	-13.58	AVG

Remark:
Factor = Antenna Factor + Cable Loss – Pre-amplifier.

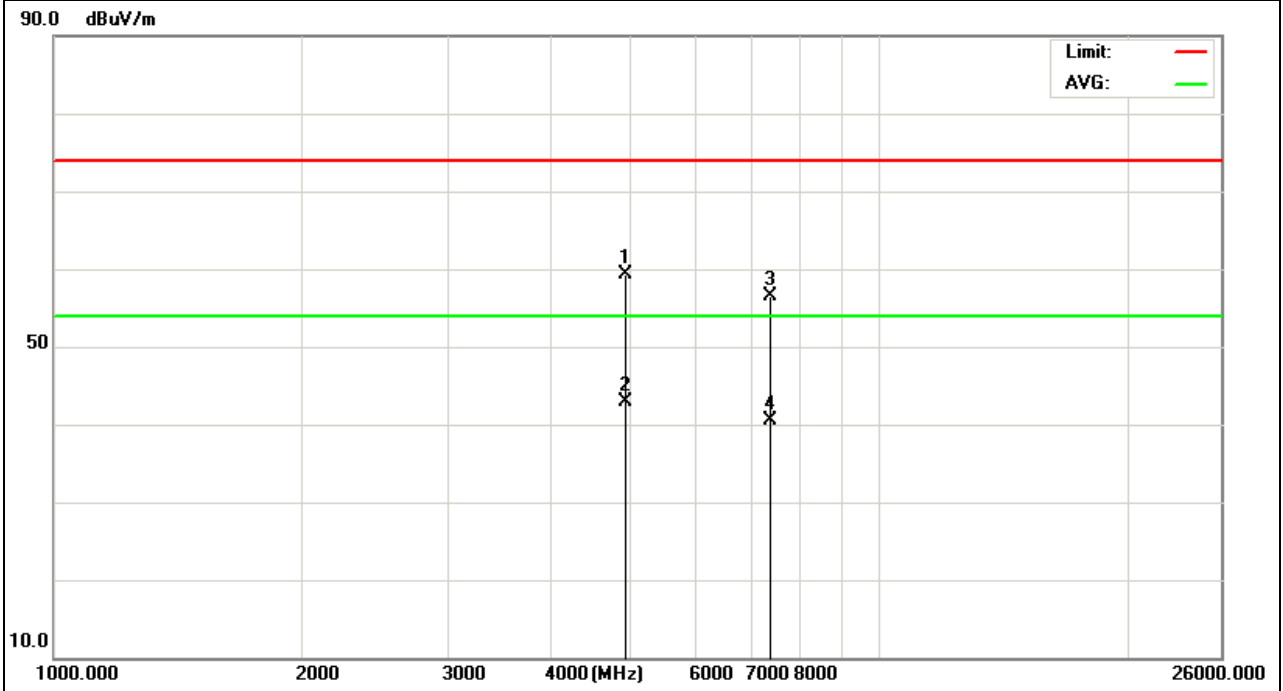

Band Edge Emission:

EUT :	Epoc WIFI	Model Name :	W001
Temperature :	20 °C	Relative Humidity :	48%
Pressure :	1010 hPa	Test Voltage :	DC 3.7V
Test Mode :	CH1(802.11b Mode)	Polarization :	Horizontal

Frequency (MHz)	Meter Reading (dBμV)	Factor (dB)	Emission Level (dBμV/m)	Limits (dBμV/m)	Margin (dB)	Detector Type
2400	82.39	-12.99	69.4	74	-4.6	peak

Remark:
Factor = Antenna Factor + Cable Loss – Pre-amplifier.

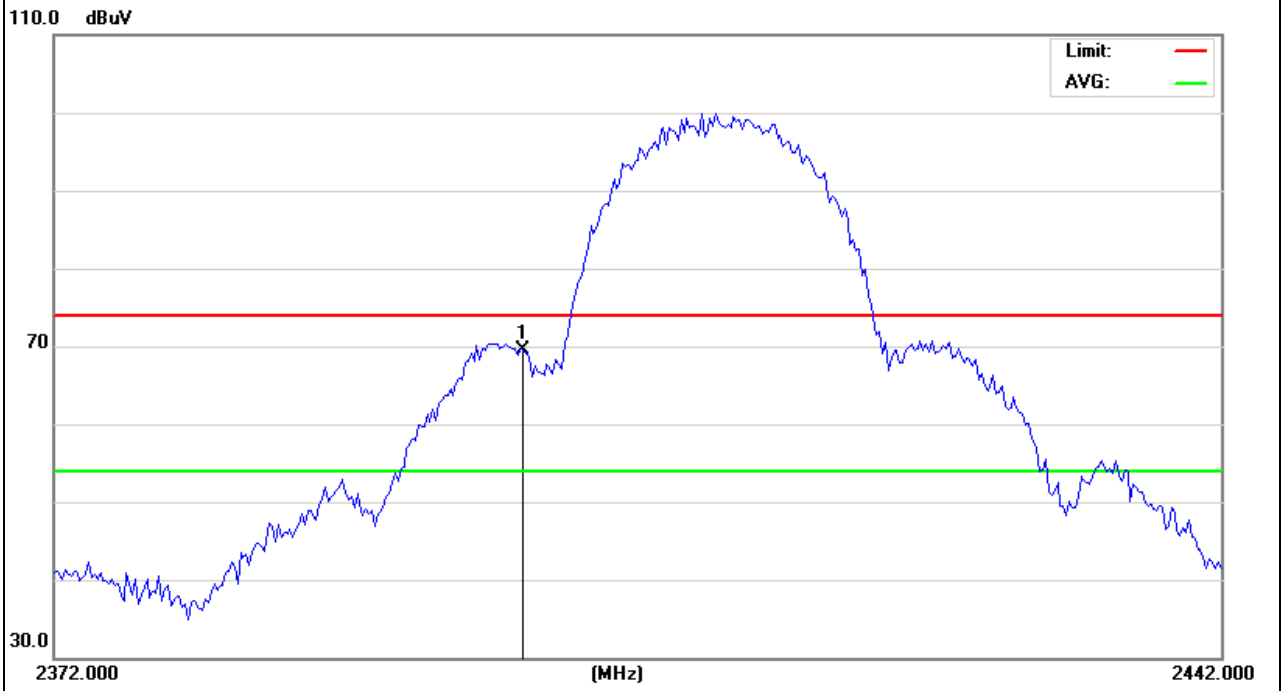

EUT :	Epoc WIFI	Model Name :	W001
Temperature :	20 °C	Relative Humidity :	48%
Pressure :	1010 hPa	Test Voltage :	DC 3.7V
Test Mode :	CH1(802.11b Mode)	Polarization :	Vertical

Frequency (MHz)	Meter Reading (dBµV)	Factor (dB)	Emission Level (dBµV/m)	Limits (dBµV/m)	Margin (dB)	Detector Type
2396.3	83.42	-13.02	70.4	74	-3.6	peak
2396.3	60.21	-13.02	47.19	54	-6.81	AVG
2400	78.99	-12.99	66	74	-8	peak

Remark:
 Factor = Antenna Factor + Cable Loss – Pre-amplifier.

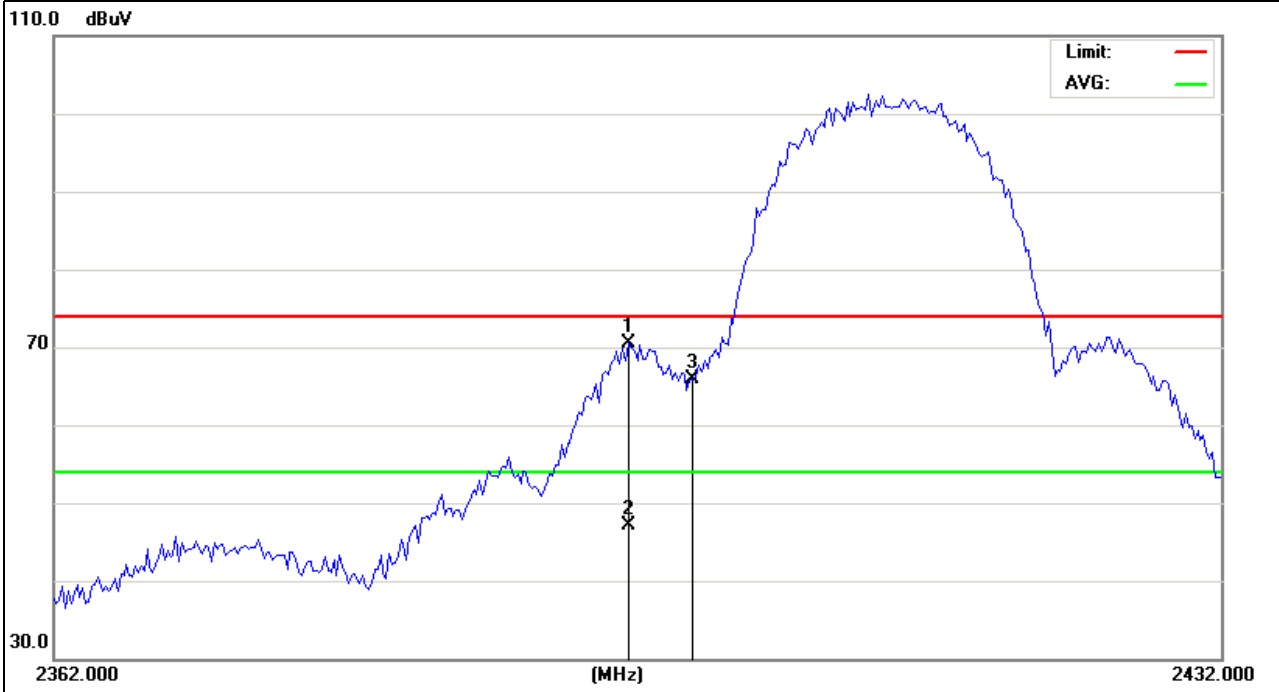

EUT :	Epoc WIFI	Model Name :	W001
Temperature :	20 °C	Relative Humidity :	48%
Pressure :	1010 hPa	Test Voltage :	DC 3.7V
Test Mode :	CH11(802.11b Mode)	Polarization :	Horizontal

Frequency (MHz)	Meter Reading (dBμV)	Factor (dB)	Emission Level (dBμV/m)	Limits (dBμV/m)	Margin (dB)	Detector Type
2483.5	69.72	-12.78	56.94	74	-17.06	peak

Remark:
Factor = Antenna Factor + Cable Loss – Pre-amplifier.

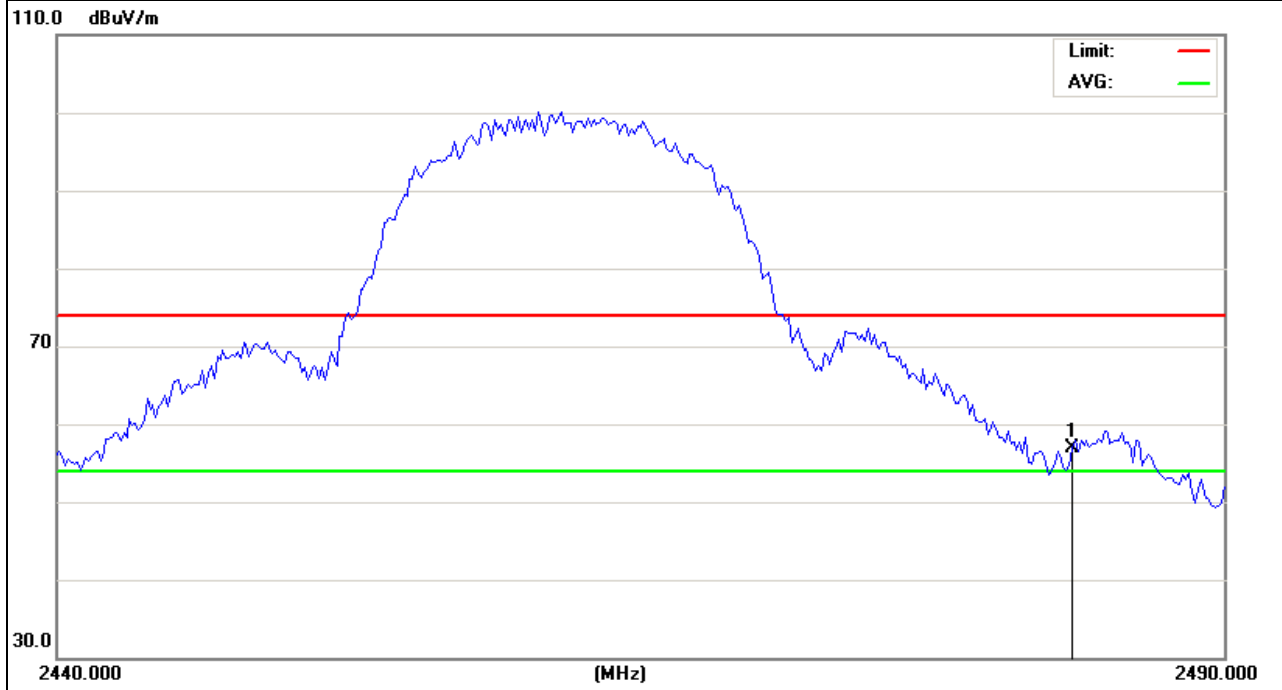

EUT :	Epoc WIFI	Model Name :	W001
Temperature :	20 °C	Relative Humidity :	48%
Pressure :	1010 hPa	Test Voltage :	DC 3.7V
Test Mode :	CH11(802.11b Mode)	Polarization :	Vertical

Frequency (MHz)	Meter Reading (dBμV)	Factor (dB)	Emission Level (dBμV/m)	Limits (dBμV/m)	Margin (dB)	Detector Type
2483.5	62.11	-12.78	49.33	74	-24.67	peak

Remark:
Factor = Antenna Factor + Cable Loss – Pre-amplifier.

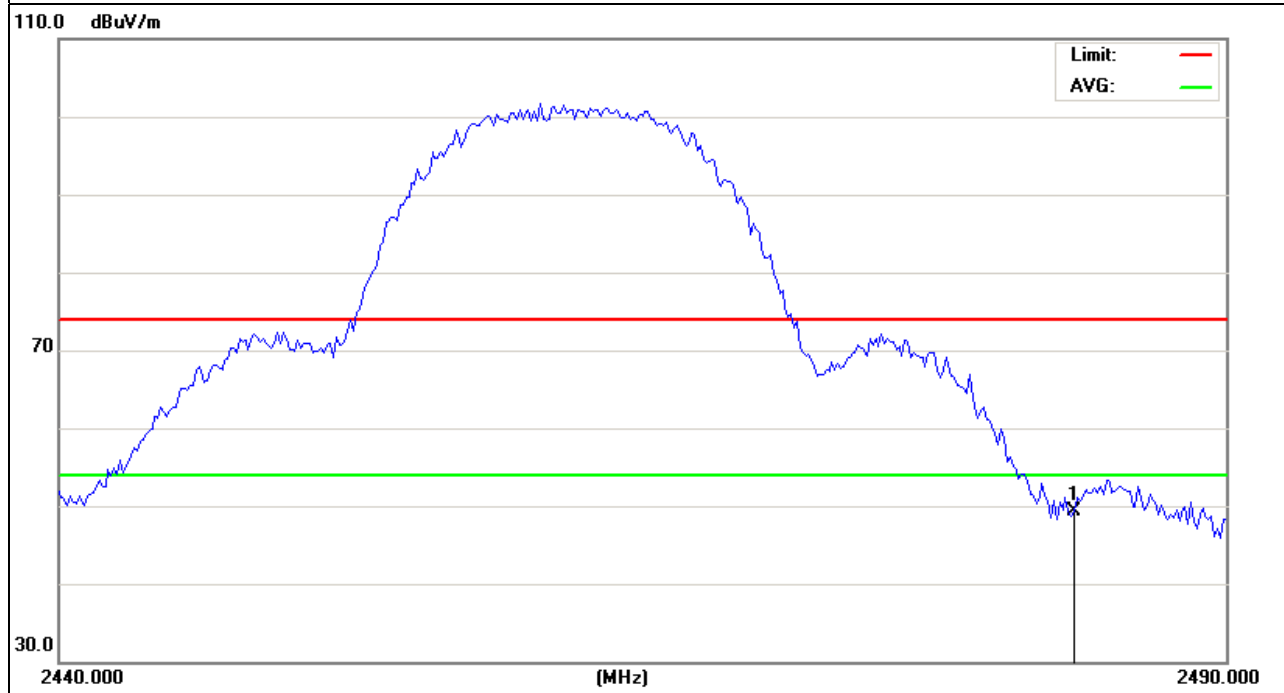

EUT :	Epoc WIFI	Model Name :	W001
Temperature :	20 °C	Relative Humidity :	48%
Pressure :	1010 hPa	Test Voltage :	DC 3.7V
Test Mode :	CH1(802.11g Mode)	Polarization :	Horizontal

Frequency (MHz)	Meter Reading (dBμV)	Factor (dB)	Emission Level (dBμV/m)	Limits (dBμV/m)	Margin (dB)	Detector Type
2400	80.39	-12.99	67.4	74	-6.6	peak

Remark:
Factor = Antenna Factor + Cable Loss – Pre-amplifier.

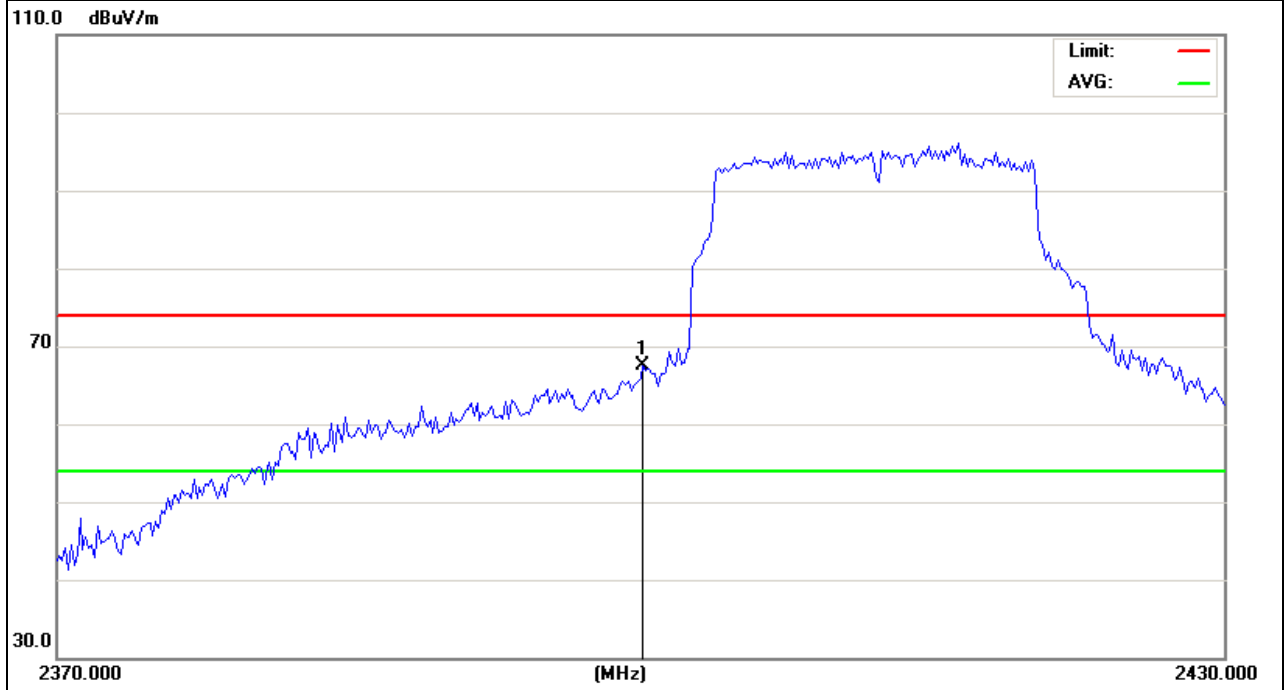

EUT :	Epoc WIFI	Model Name :	W001
Temperature :	20 °C	Relative Humidity :	48%
Pressure :	1010 hPa	Test Voltage :	DC 3.7V
Test Mode :	CH1(802.11gMode)	Polarization :	Vertical

Frequency (MHz)	Meter Reading (dBμV)	Factor (dB)	Emission Level (dBμV/m)	Limits (dBμV/m)	Margin (dB)	Detector Type
2400	80.49	-12.99	67.5	74	-6.5	peak
2400	58.29	-12.99	45.3	54	-8.7	AVG

Remark:
Factor = Antenna Factor + Cable Loss – Pre-amplifier.

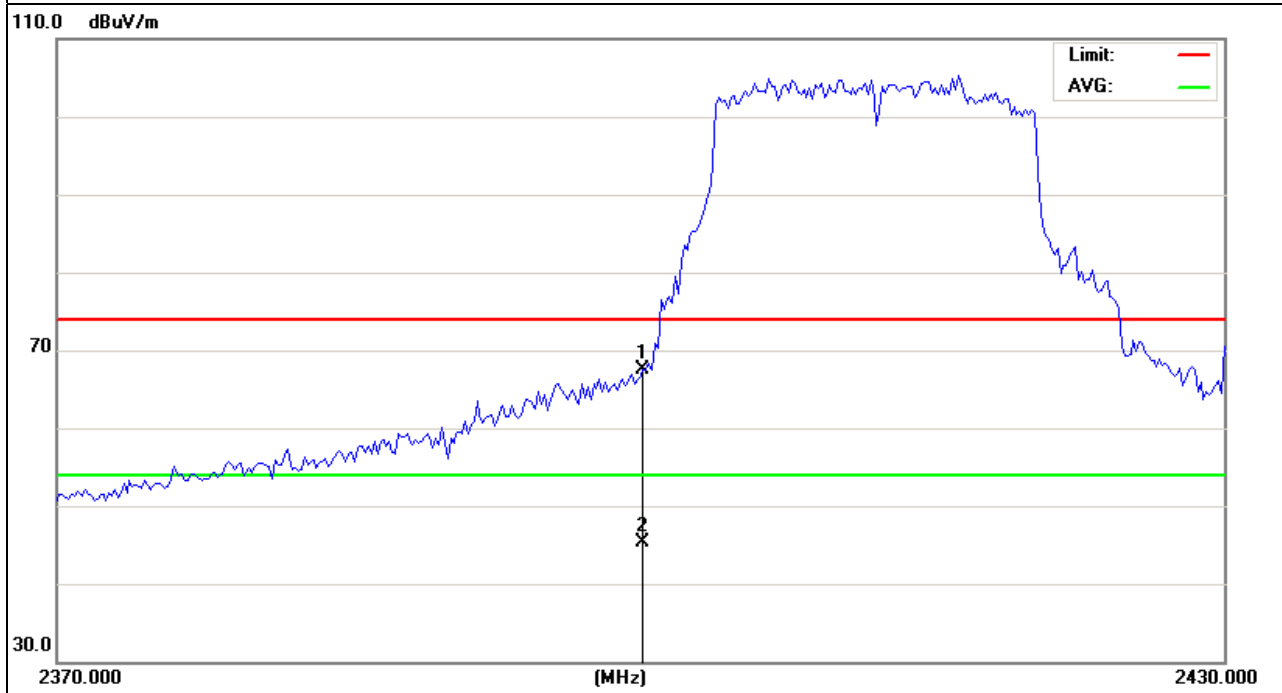

EUT :	Epoc WIFI	Model Name :	W001
Temperature :	20 °C	Relative Humidity :	48%
Pressure :	1010 hPa	Test Voltage :	DC 3.7V
Test Mode :	CH11(802.11g Mode)	Polarization :	Horizontal

Frequency (MHz)	Meter Reading (dBµV)	Factor (dB)	Emission Level (dBµV/m)	Limits (dBµV/m)	Margin (dB)	Detector Type
2483.5	79.28	-12.78	66.5	74	-7.5	peak
2483.5	59.71	-12.78	46.93	54	-7.07	AVG

Remark:
 Factor = Antenna Factor + Cable Loss – Pre-amplifier.

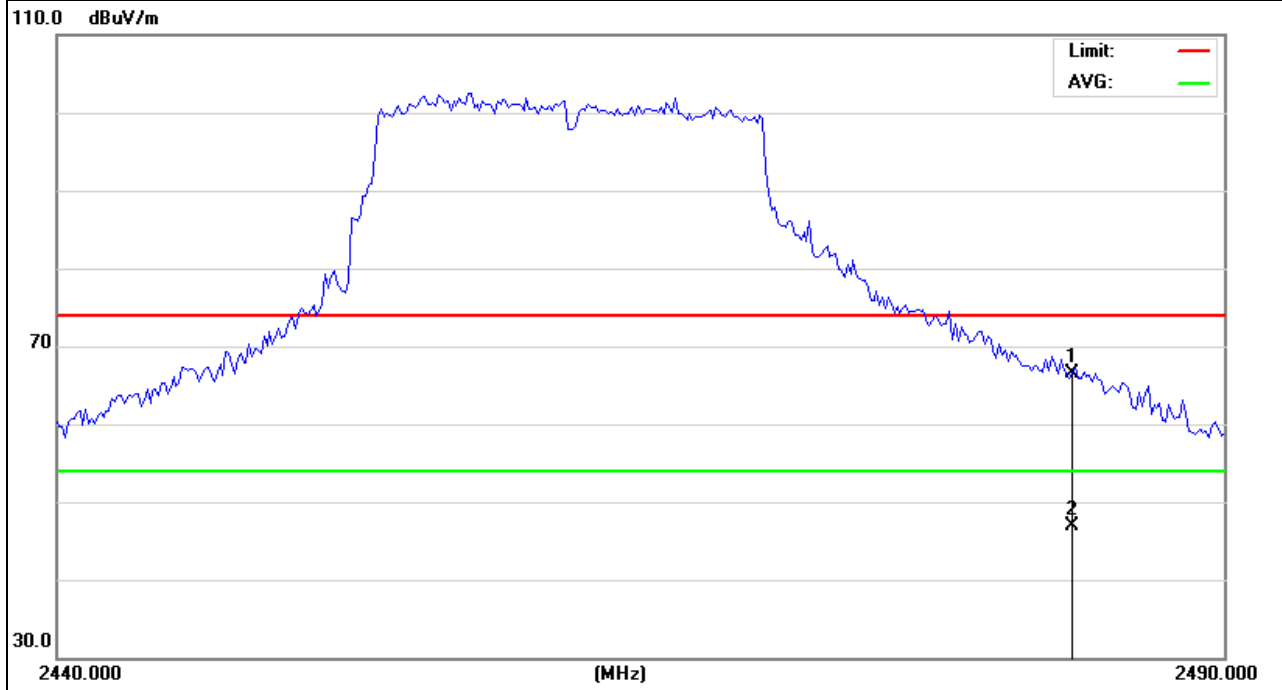

EUT :	Epoc WIFI	Model Name :	W001
Temperature :	20 °C	Relative Humidity :	48%
Pressure :	1010 hPa	Test Voltage :	DC 3.7V
Test Mode :	CH11(802.11g Mode)	Polarization :	Vertical

Frequency (MHz)	Meter Reading (dBµV)	Factor (dB)	Emission Level (dBµV/m)	Limits (dBµV/m)	Margin (dB)	Detector Type
2483.5	63.98	-12.78	51.2	74	-22.8	peak

Remark:
Factor = Antenna Factor + Cable Loss – Pre-amplifier.

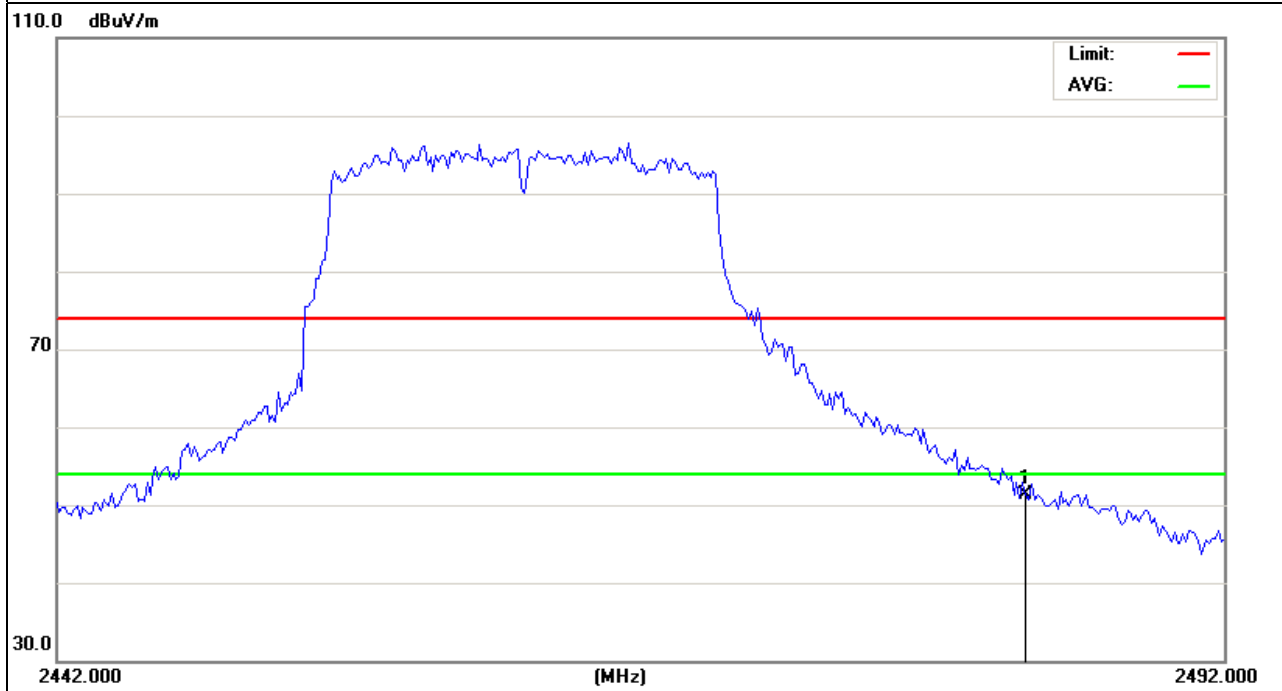

EUT :	Epoc WIFI	Model Name :	W001
Temperature :	20 °C	Relative Humidity :	48%
Pressure :	1010 hPa	Test Voltage :	DC 3.7V
Test Mode :	CH1(802.11n Mode)	Polarization :	Horizontal

Frequency (MHz)	Meter Reading (dBμV)	Factor (dB)	Emission Level (dBμV/m)	Limits (dBμV/m)	Margin (dB)	Detector Type
2400	81.09	-12.99	68.1	74	-5.9	peak
2400	58.64	-12.99	45.65	54	-8.35	AVG

Remark:
Factor = Antenna Factor + Cable Loss – Pre-amplifier.

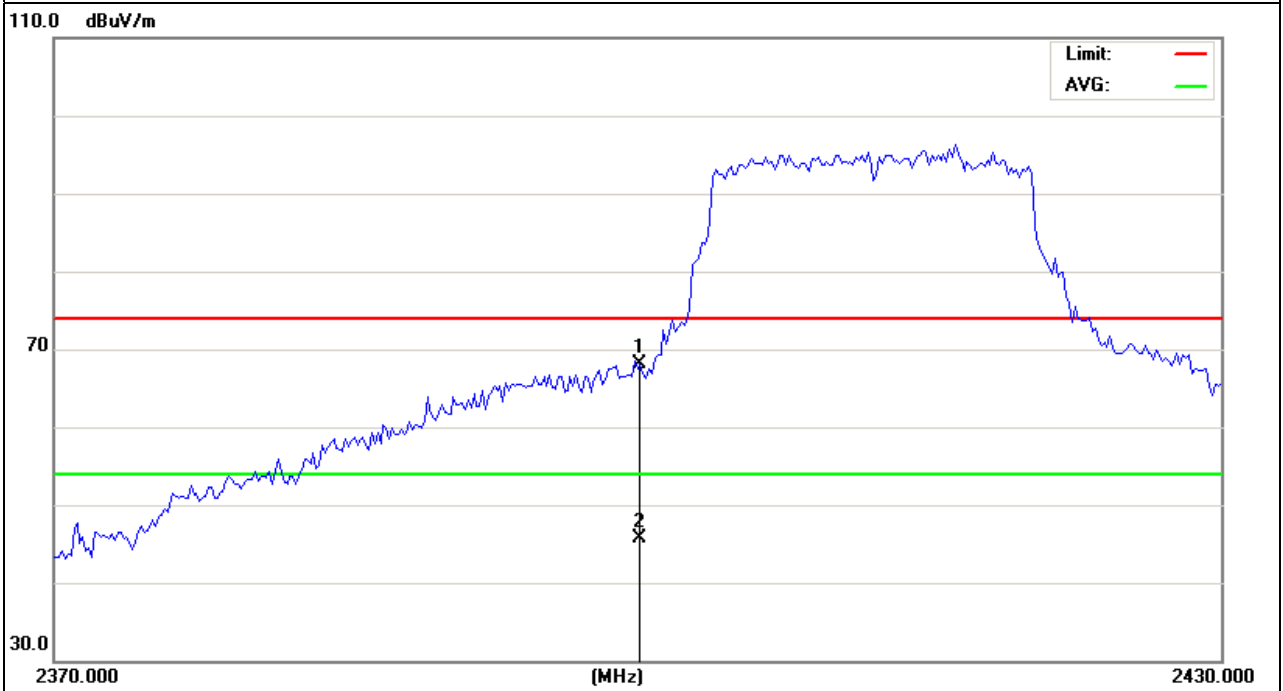

EUT :	Epoc WIFI	Model Name :	W001
Temperature :	20 °C	Relative Humidity :	48%
Pressure :	1010 hPa	Test Voltage :	DC 3.7V
Test Mode :	CH1(802.11n Mode)	Polarization :	Vertical

Frequency (MHz)	Meter Reading (dBμV)	Factor (dB)	Emission Level (dBμV/m)	Limits (dBμV/m)	Margin (dB)	Detector Type
2400	81.59	-12.99	68.6	74	-5.4	peak
2400	58.73	-12.99	45.74	54	-8.26	AVG

Remark:
Factor = Antenna Factor + Cable Loss – Pre-amplifier.

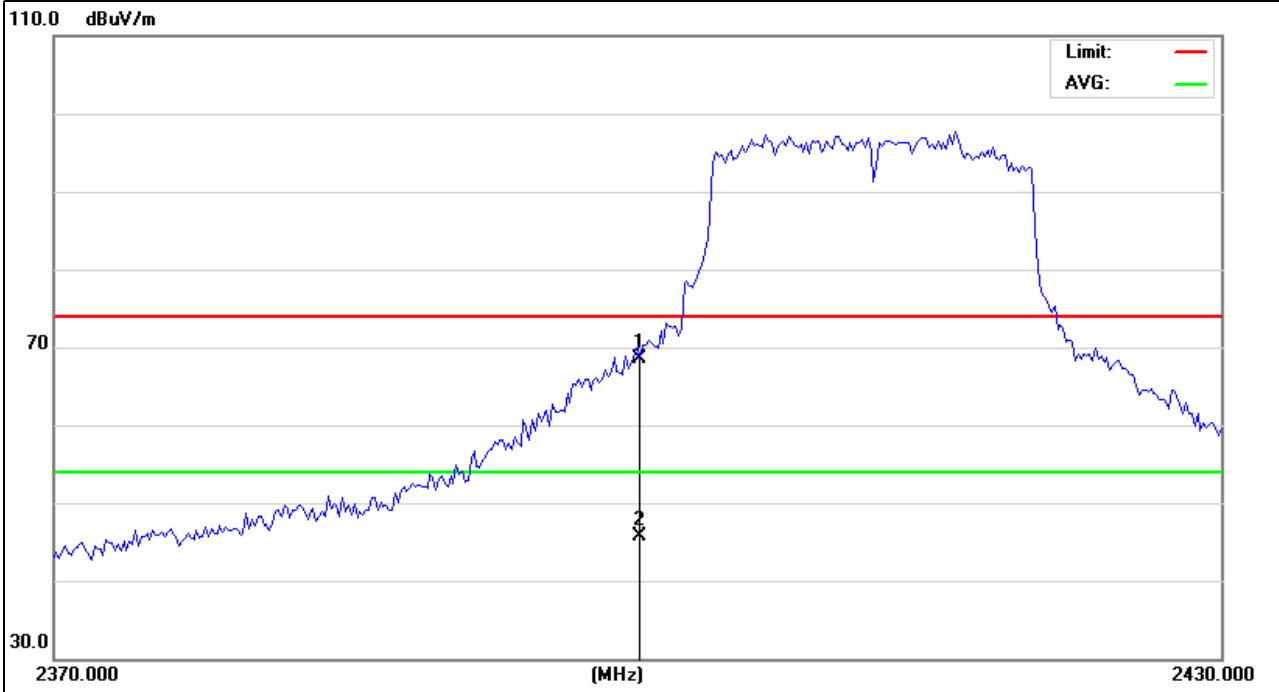

EUT :	Epoc WIFI	Model Name :	W001
Temperature :	20 °C	Relative Humidity :	48%
Pressure :	1010 hPa	Test Voltage :	DC 3.7V
Test Mode :	CH11(802.11n Mode)	Polarization :	Horizontal

Frequency (MHz)	Meter Reading (dBµV)	Factor (dB)	Emission Level (dBµV/m)	Limits (dBµV/m)	Margin (dB)	Detector Type
2483.5	78.08	-12.78	65.3	74	-8.7	peak
2483.5	57.88	-12.78	45.1	54	-8.9	AVG

Remark:
 Factor = Antenna Factor + Cable Loss – Pre-amplifier.

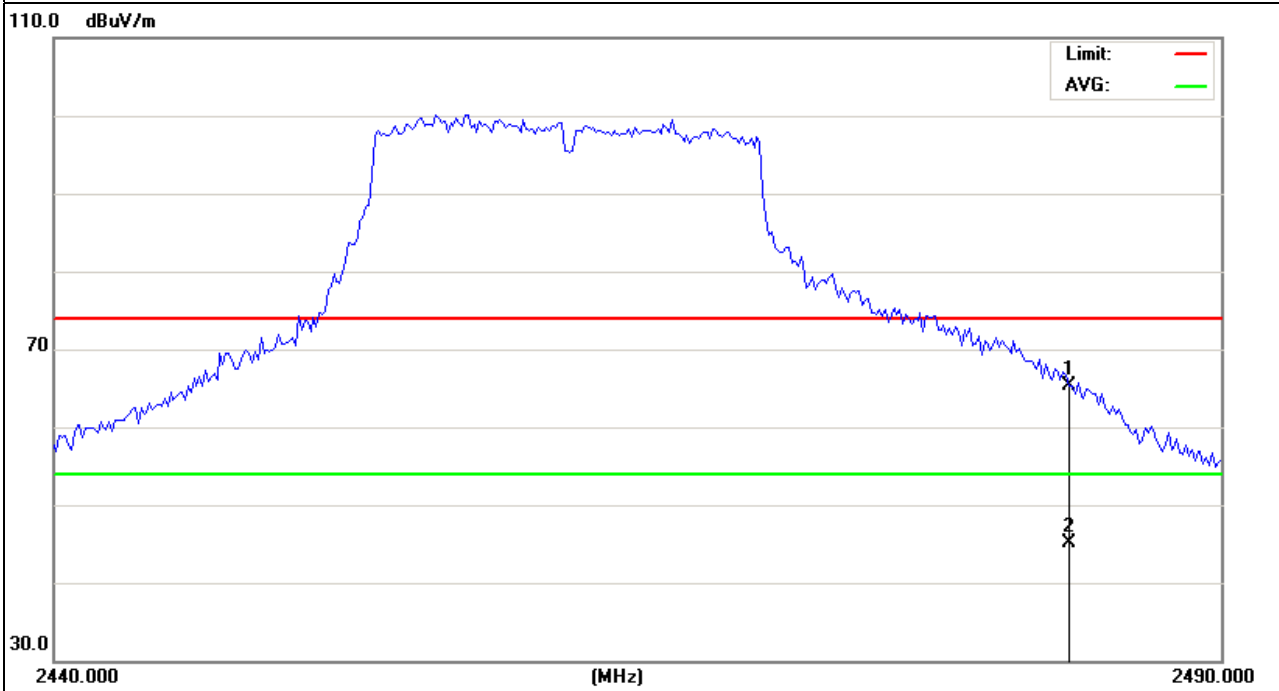

EUT :	Epoc WIFI	Model Name :	W001
Temperature :	20 °C	Relative Humidity :	48%
Pressure :	1010 hPa	Test Voltage :	DC 3.7V
Test Mode :	CH11(802.11n Mode)	Polarization :	Vertical

Frequency (MHz)	Meter Reading (dBµV)	Factor (dB)	Emission Level (dBµV/m)	Limits (dBµV/m)	Margin (dB)	Detector Type
2483.5	78.29	-12.78	65.51	74	-8.49	peak
2483.5	57.69	-12.78	44.91	54	-9.09	AVG

Remark:
 Factor = Antenna Factor + Cable Loss – Pre-amplifier.

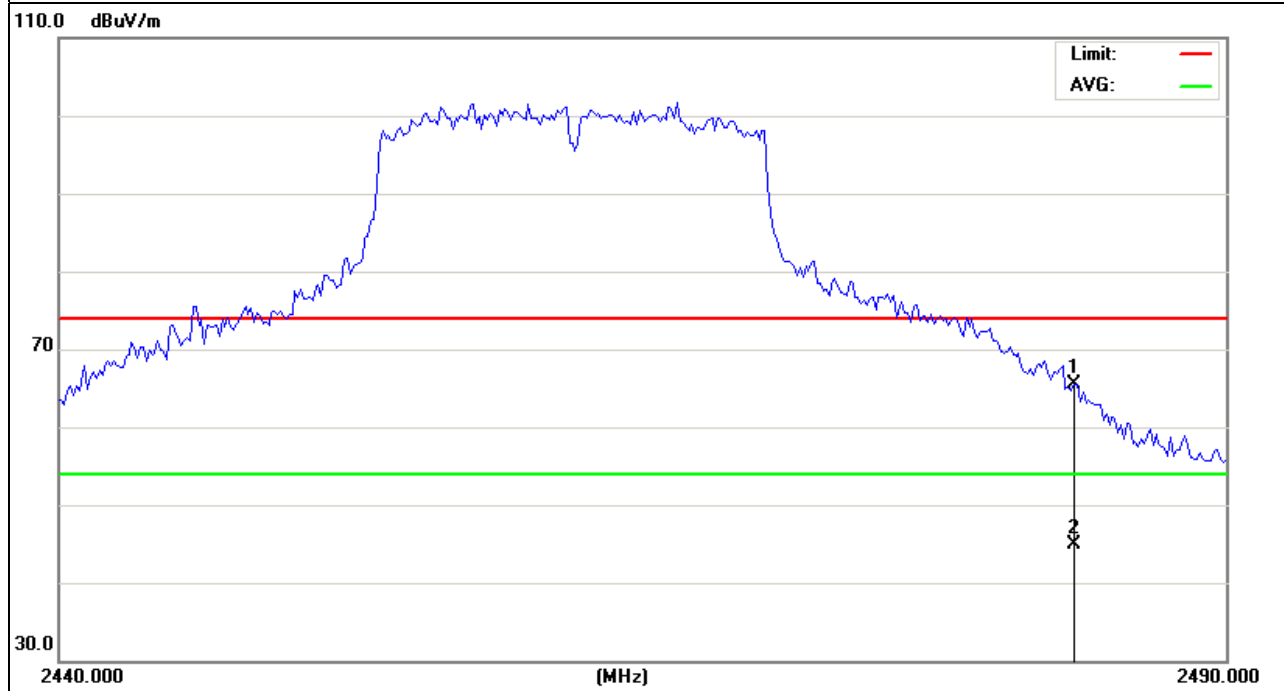

4. POWER SPECTRAL DENSITY TEST

4.1 APPLIED PROCEDURES / LIMIT

FCC Part15 (15.247) , Subpart C				
Section	Test Item	Limit	Frequency Range (MHz)	Result
15.247	Power Spectral Density	8 dBm (in any 3KHz)	2400-2483.5	PASS

4.1.1 TEST PROCEDURE

1. The testing follows Measurement Procedure PKPSD of FCC KDB Publication No. 558074 D01 DTS Meas. Guidance v01.
2. The RF output of EUT was connected to the spectrum analyzer by a low loss cable. The path loss was compensated to the results for each measurement.
3. Record the measurement data derived from spectrum analyzer.
4. Make the measurement with the spectrum analyzer's resolution bandwidth (RBW) = 100 KHz. Video bandwidth (VBW) >= 300 KHz In order to make an accurate measurement, set the span to 5-30% greater than Emission Bandwidth (EBW)
5. Detector = peak, Sweep time = auto couple, Trace mode = max hold, Allow trace to fully stabilize. Use the peak marker function to determine the maximum power level in any 100 kHz band segment within the fundamental EBW.
6. Scale the observed power level to an equivalent value in 3 kHz by adjusting (reducing) the measured power by a bandwidth correction factor (BWCF) where $BWCF = 10\log(3\text{ kHz}/100\text{ kHz}) = -15.2\text{ dB}$.

4.1.2 DEVIATION FROM STANDARD

No deviation.

4.1.3 TEST SETUP



4.1.4 EUT OPERATION CONDITIONS

The EUT tested system was configured as the statements of 2.1 Unless otherwise a special operating condition is specified in the follows during the testing.

4.1.5 TEST RESULTS

EUT :	Epoc WIFI	Model Name :	W001
Temperature :	25 °C	Relative Humidity :	60%
Pressure :	1015 hPa	Test Voltage :	DC 3.7V
Test Mode :	TX b Mode /CH01, CH06, CH11		

Frequency	Power Density (dBm)	PSD/3KHz (dBm)	Limit (dBm)	Result
2412 MHz	7.56	-9.61	8	PASS
2437 MHz	8.06	-7.14	8	PASS
2462 MHz	7.43	-7.77	8	PASS

Note:

BWCF = $10\log(3\text{ kHz}/100\text{ kHz}) = -15.2\text{ dB}$.

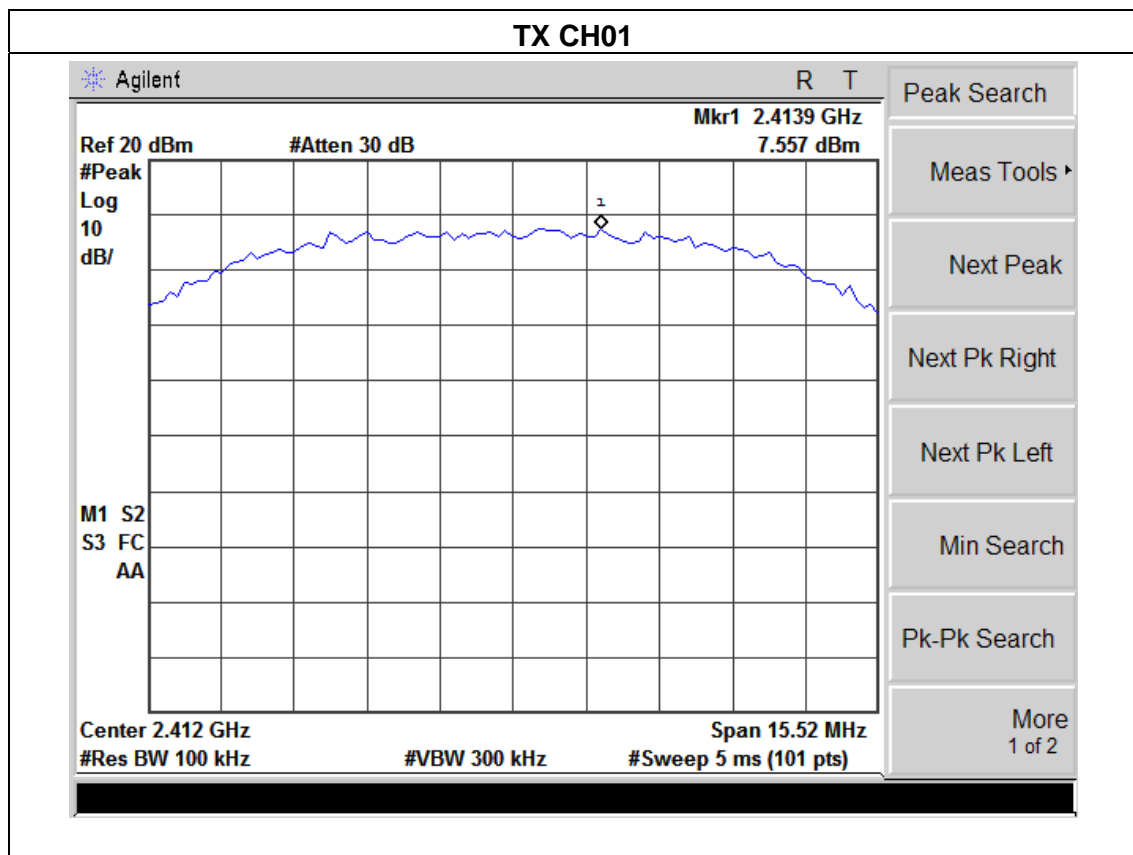

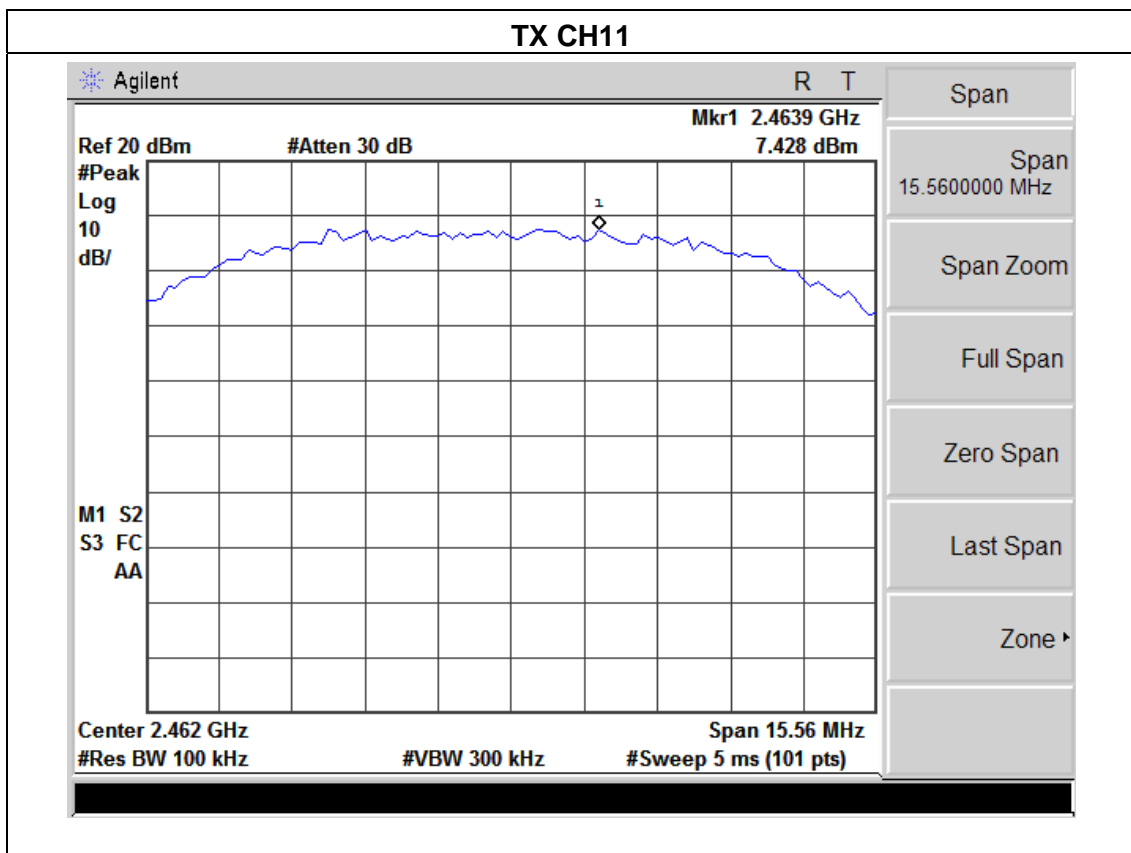
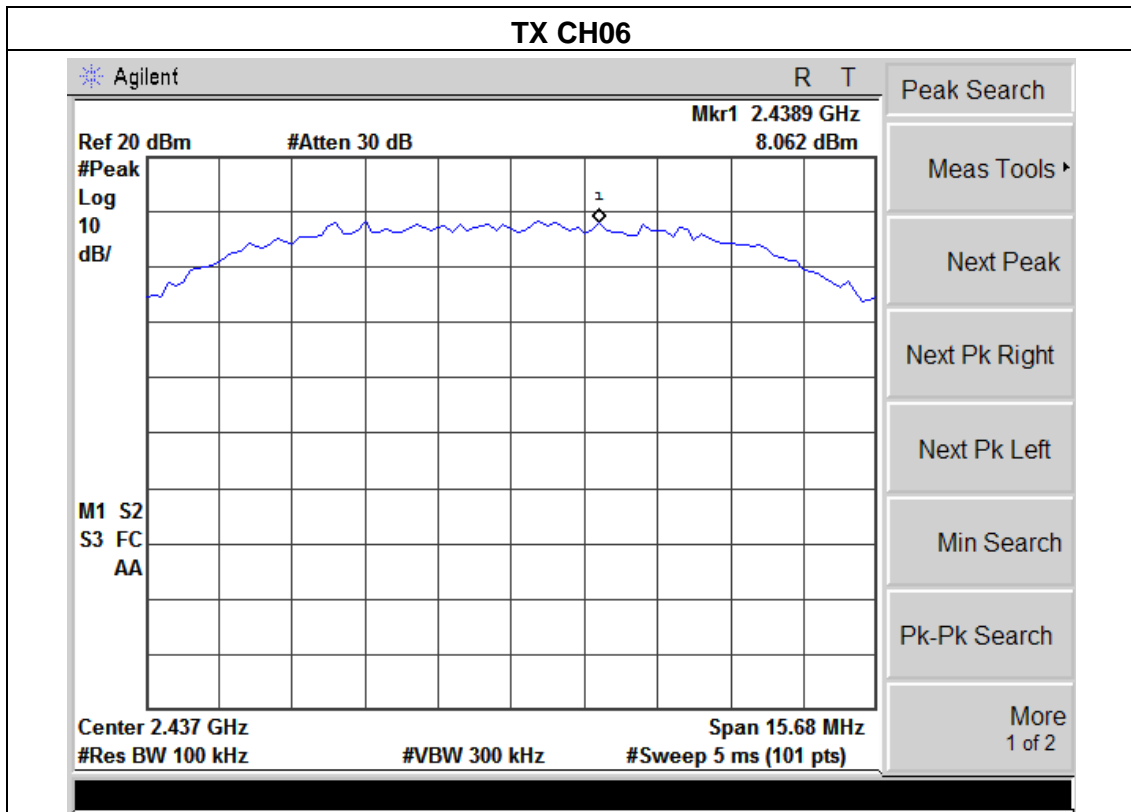

EUT :	Epoc WIFI	Model Name :	W001
Temperature :	25 °C	Relative Humidity :	60%
Pressure :	1015 hPa	Test Voltage :	DC 3.7V
Test Mode :	TX g Mode /CH01, CH06, CH11		

Frequency	Power Density (dBm)	PSD/3KHz (dBm)	Limit (dBm)	Result
2412 MHz	5.16	-10.04	8	PASS
2437 MHz	4.41	-10.79	8	PASS
2462 MHz	3.84	-11.36	8	PASS

Note:

BWCF = $10\log(3\text{ kHz}/100\text{ kHz} = -15.2\text{ dB})$.

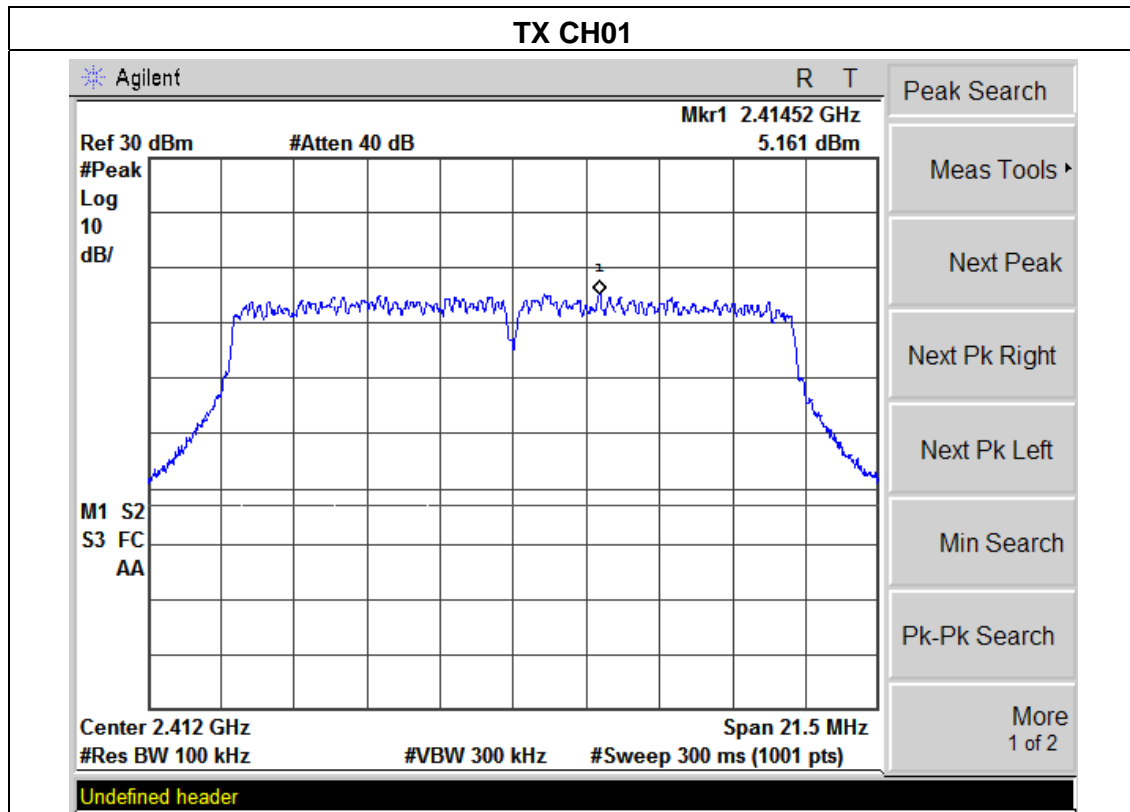

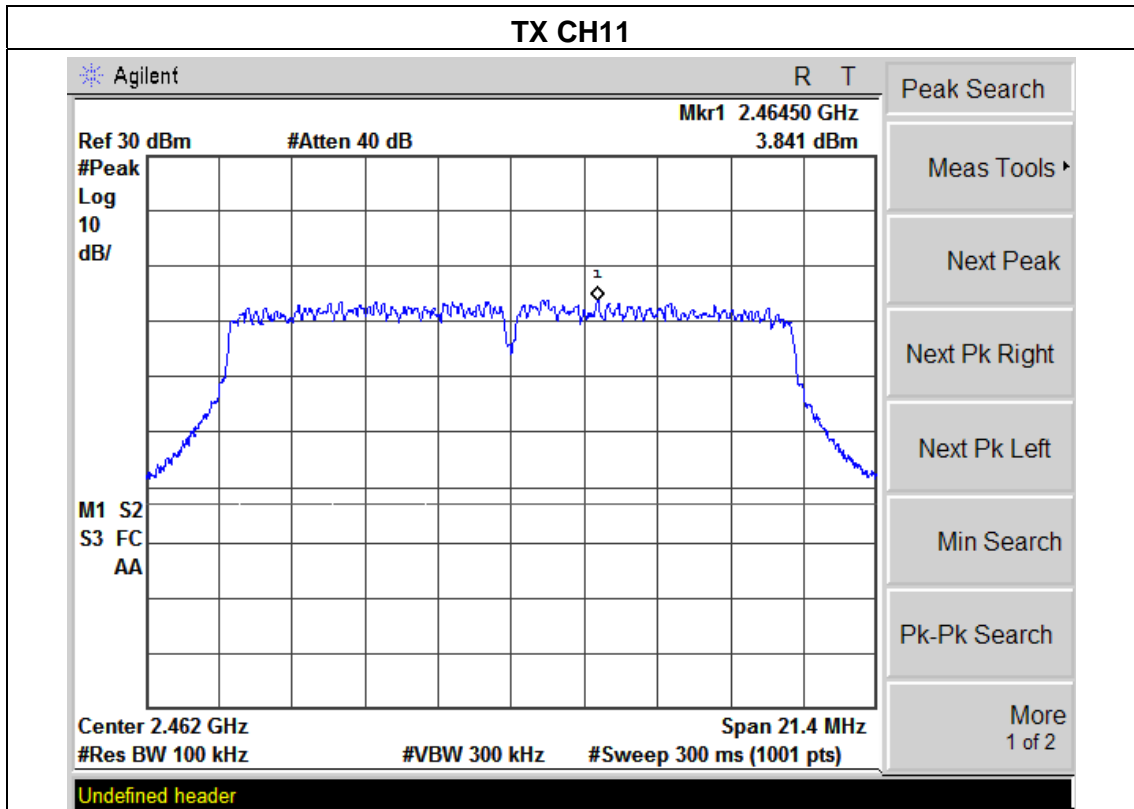
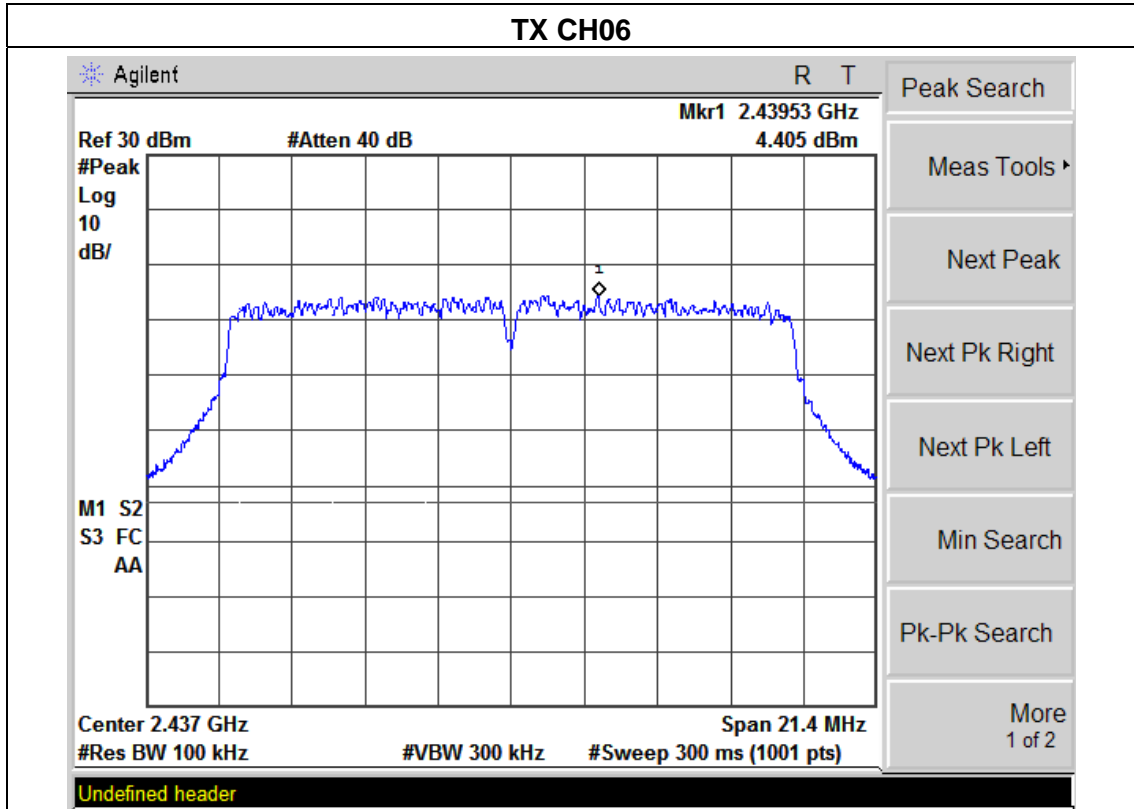

EUT :	Epoc WIFI	Model Name :	W001
Temperature :	25 °C	Relative Humidity :	60%
Pressure :	1015 hPa	Test Voltage :	DC 3.7V
Test Mode :	TX n Mode /CH01, CH06, CH11		

Frequency	Power Density A (dBm)	PSD/ 3KHz (dBm)	Limit (dBm)	Result
2412 MHz	4.93	-10.27	8	PASS
2437 MHz	4.53	-10.67	8	PASS
2462 MHz	4.64	-10.56	8	PASS

Note:

BWCF = $10\log(3\text{ kHz}/100\text{ kHz}) = -15.2\text{ dB}$.

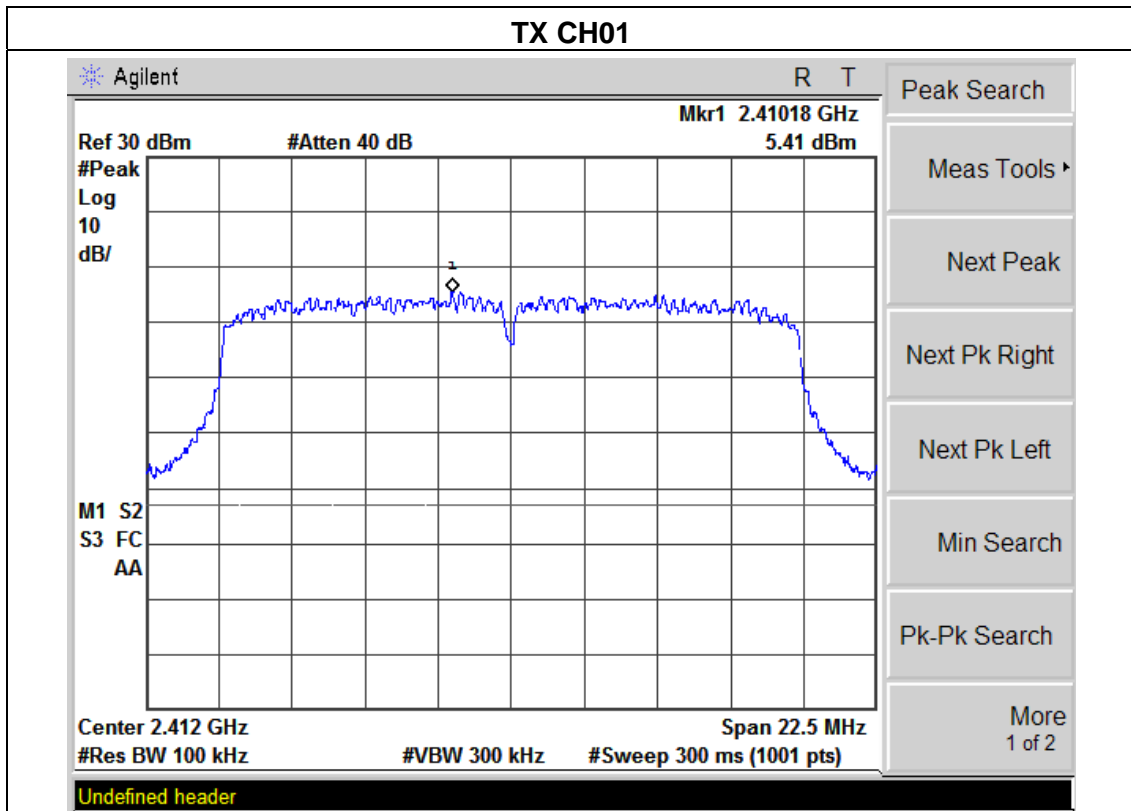

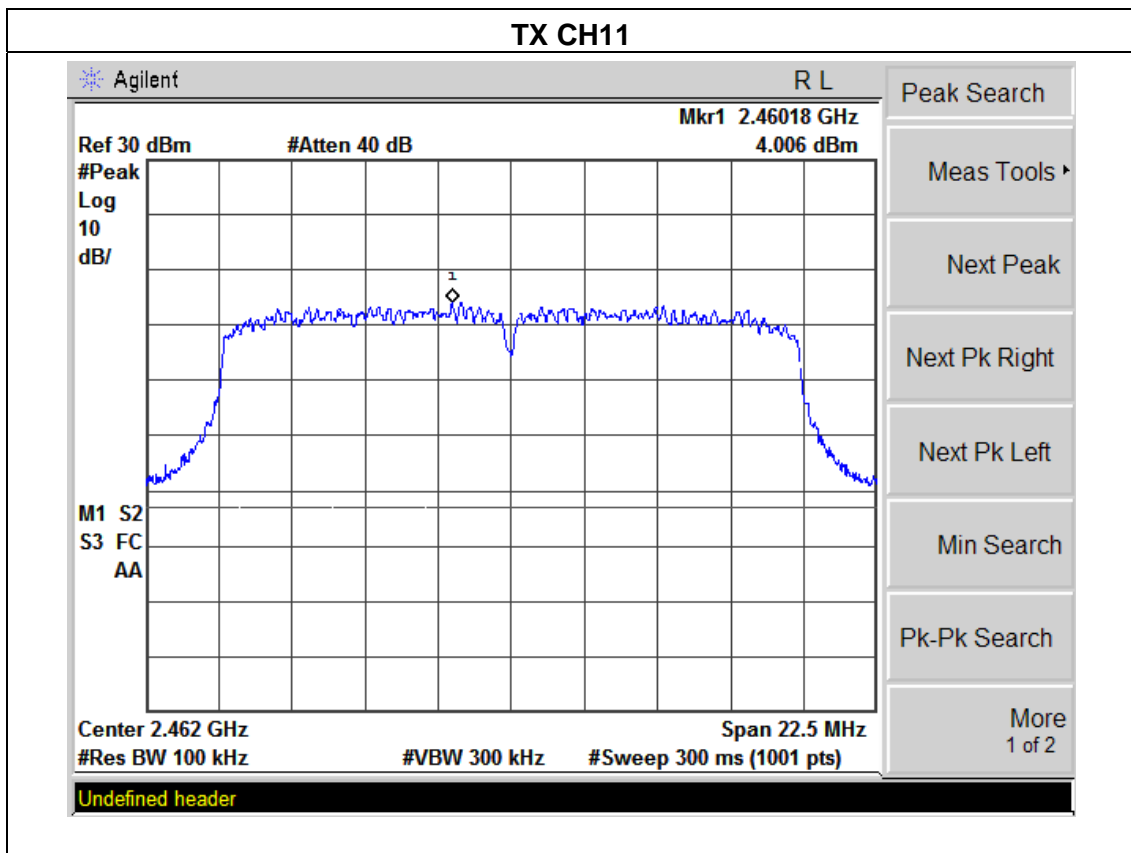
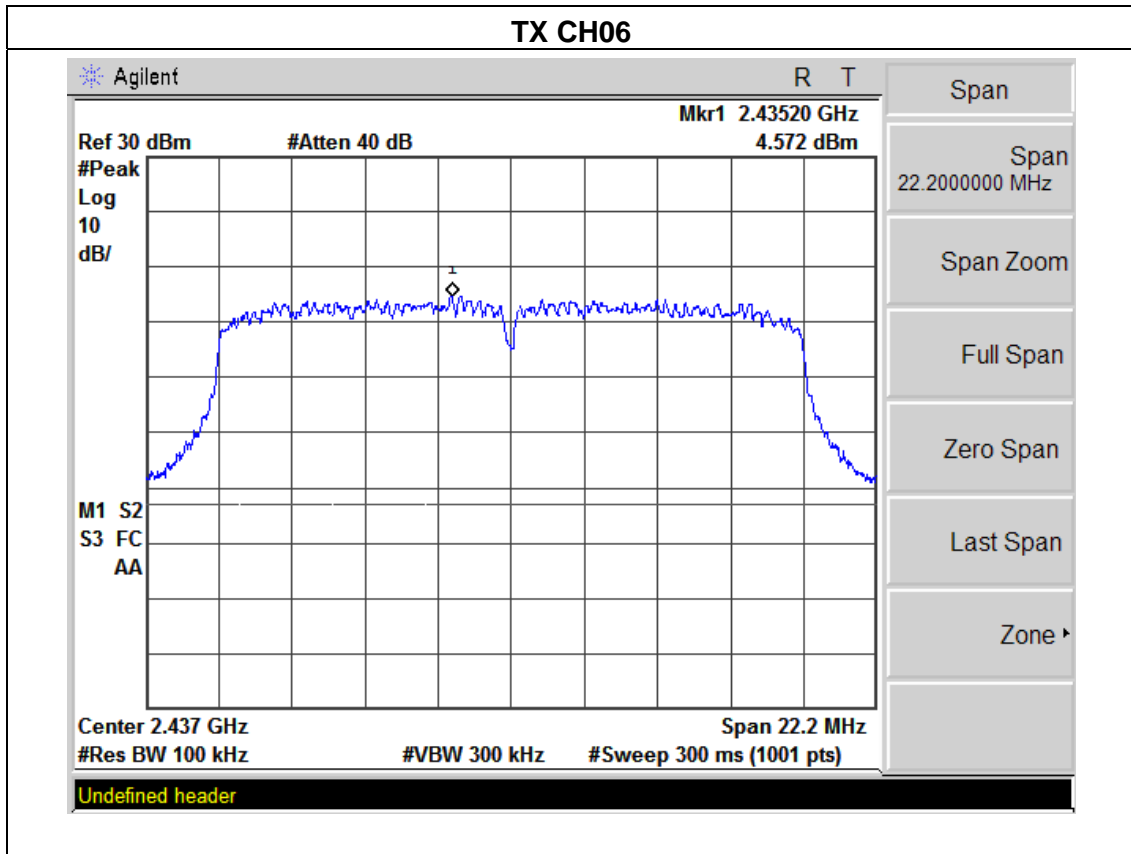

5. BANDWIDTH TEST

5.1 APPLIED PROCEDURES / LIMIT

FCC Part15 (15.247) , Subpart C				
Section	Test Item	Limit	Frequency Range (MHz)	Result
15.247(a)(2)	Bandwidth	$\geq 500\text{KHz}$ (6dB bandwidth)	2400-2483.5	PASS

5.1.1 TEST PROCEDURE

- a.
1. The testing follows FCC KDB Publication No. 558074 D01 DTS Meas. Guidance v01.
 2. The RF output of EUT was connected to the spectrum analyzer by a low loss cable. The path loss was compensated to the results for each measurement.
 3. Make the measurement with the spectrum analyzer's resolution bandwidth (RBW) = 1-5% of the emission bandwidth (EBW). Set the Video bandwidth (VBW) $\geq 3 * \text{RBW}$. In order to make an accurate measurement. The 6 dB bandwidth must be greater than 500 KHz.
 4. The marker-delta reading at this point is the 6 dB bandwidth of the emission.

5.1.2 DEVIATION FROM STANDARD

No deviation.

5.1.3 TEST SETUP



5.1.4 EUT OPERATION CONDITIONS

The EUT tested system was configured as the statements of 2.4 Unless otherwise a special operating condition is specified in the follows during the testing.

5.1.5 TEST RESULTS

EUT :	Epoc WIFI	Model Name :	W001
Temperature :	25 °C	Relative Humidity :	60%
Pressure :	1012 hPa	Test Voltage :	DC 3.7V
Test Mode :	TX b Mode /CH01, CH06, CH11		

Frequency	6dB Bandwidth (MHz)	99% Occupied BW (MHz)	Channel Separation (MHz)	Result
2412 MHz	11.94	14.72	>=500KHz	PASS
2437 MHz	12.06	15.26	>=500KHz	PASS
2462 MHz	11.92	16.22	>=500KHz	PASS

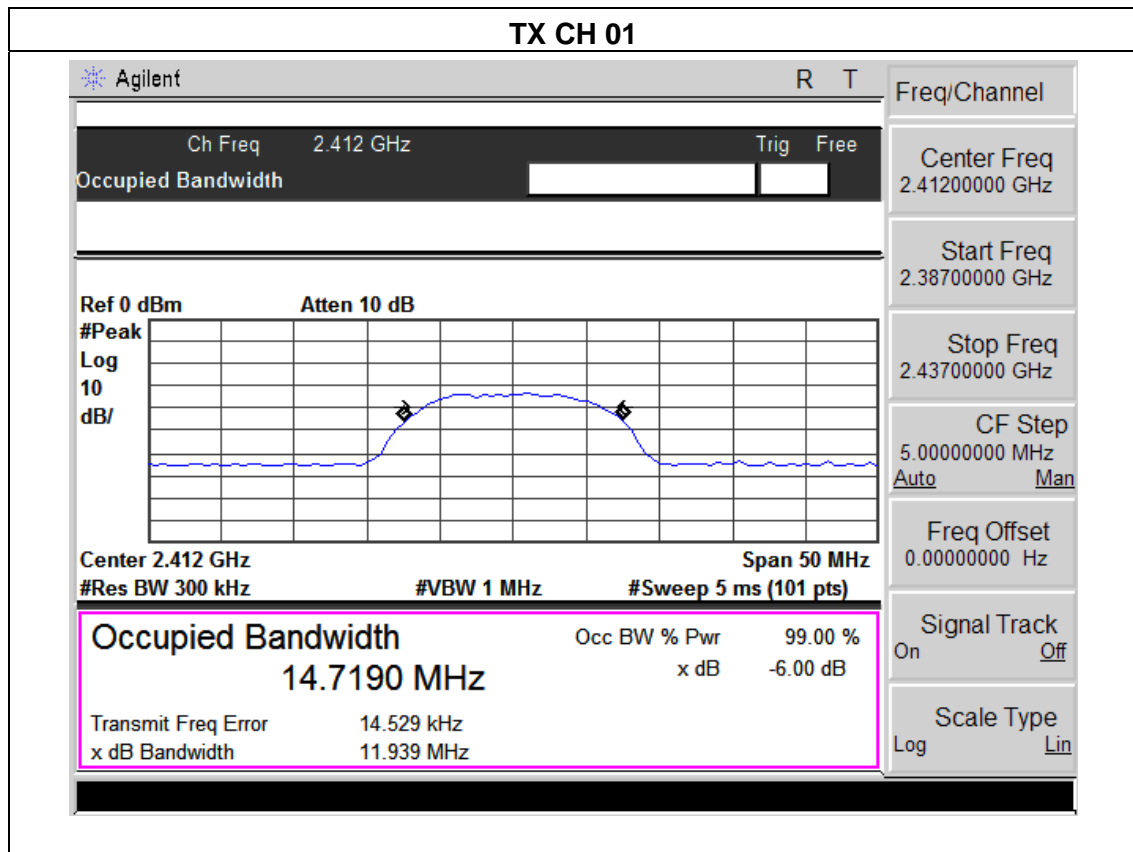

TX CH 06

Agilent
R T

Ch Freq 2.437 GHz
Trig Free

Occupied Bandwidth

Ref 0 dBm
Atten 10 dB

#Peak									
Log									
10									
dB/									

Center 2.437 GHz Span 50 MHz

#Res BW 300 kHz #VBW 1 MHz #Sweep 5 ms (101 pts)

Occupied Bandwidth Occ BW % Pwr 99.00 %

15.2622 MHz x dB -6.00 dB

Transmit Freq Error -69.962 kHz

x dB Bandwidth 12.061 MHz

Freq/Channel
 Center Freq 2.43700000 GHz
 Start Freq 2.41200000 GHz
 Stop Freq 2.46200000 GHz
 CF Step 5.00000000 MHz
 Auto Man
 Freq Offset 0.00000000 Hz
 Signal Track On Off
 Scale Type Log Lin

TX CH 11

Agilent
R T

Ch Freq 2.462 GHz
Trig Free

Occupied Bandwidth

Ref 0 dBm
Atten 10 dB

#Peak									
Log									
10									
dB/									

Center 2.462 GHz Span 50 MHz

#Res BW 300 kHz #VBW 1 MHz #Sweep 5 ms (101 pts)

Occupied Bandwidth Occ BW % Pwr 99.00 %

16.2160 MHz x dB -6.00 dB

Transmit Freq Error -19.387 kHz

x dB Bandwidth 11.972 MHz

Sweep
 Sweep Time 5.000 ms
 Auto Man
 Sweep Single Cont
 Auto Sweep Coupling SR SA
 Gate [Off]
 Points 101
 Segmented

EUT :	Epoc WIFI	Model Name :	W001
Temperature :	25 °C	Relative Humidity :	60%
Pressure :	1012 hPa	Test Voltage :	DC 3.7V
Test Mode :	TX g Mode /CH01, CH06, CH11		

Frequency	6dB Bandwidth (MHz)	99% Occupied BW (MHz)	Channel Separation (MHz)	Result
2412 MHz	16.51	16.57	>=500KHz	PASS
2437 MHz	16.46	16.54	>=500KHz	PASS
2462 MHz	16.45	16.54	>=500KHz	PASS

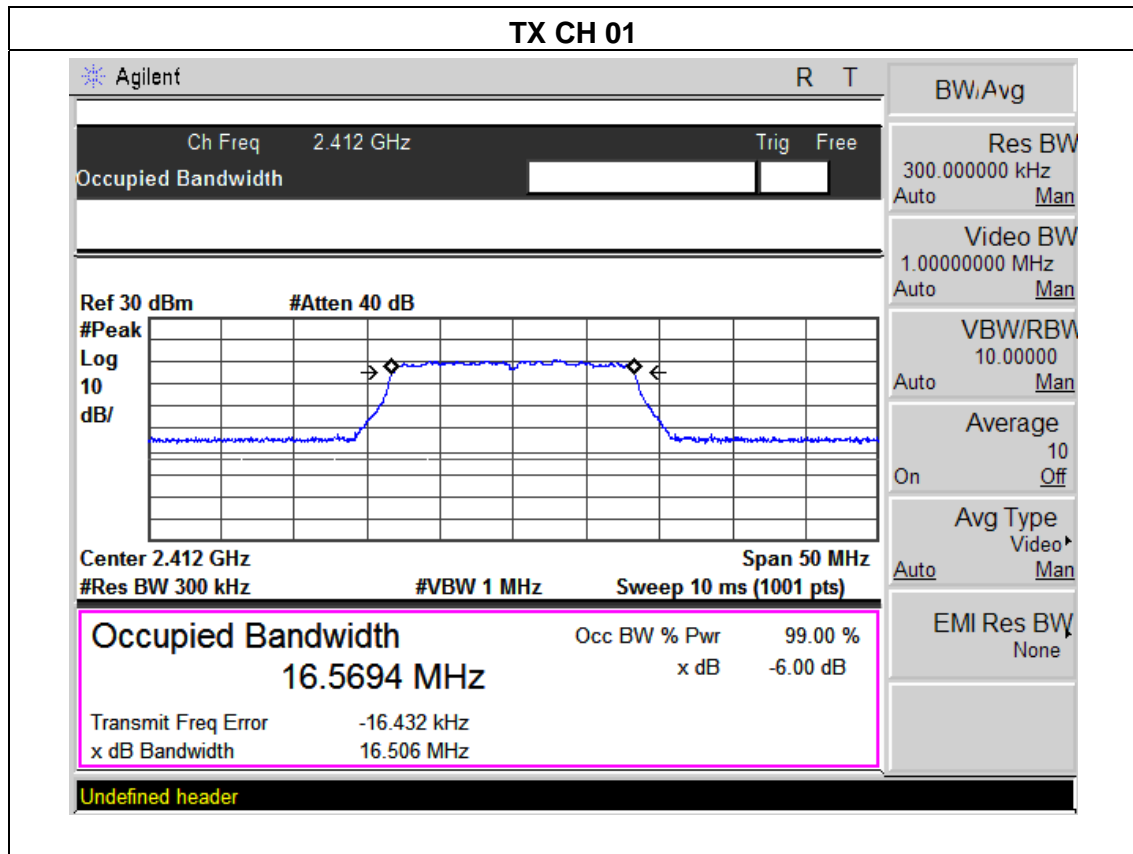

TX CH 06

Agilent		R	T
Ch Freq 2.437 GHz		Trig	Free
Occupied Bandwidth			
Center 2.437 GHz		Span 50 MHz	
#Res BW 300 kHz		#VBW 1 MHz	Sweep 10 ms (1001 pts)
Occupied Bandwidth		Occ BW % Pwr	99.00 %
16.5390 MHz		x dB	-6.00 dB
Transmit Freq Error		-6.461 kHz	
x dB Bandwidth		16.464 MHz	
Undefined header			
Freq/Channel		Center Freq 2.43700000 GHz	
		Start Freq 2.41200000 GHz	
		Stop Freq 2.46200000 GHz	
		CF Step 36.2000000 MHz	
		Auto <u>Man</u>	
		Freq Offset 0.00000000 Hz	
Signal Track		On <u>Off</u>	
Scale Type		Log <u>Lin</u>	

TX CH 11

Agilent		R	T
Ch Freq 2.462 GHz		Trig	Free
Occupied Bandwidth			
Center 2.462 GHz		Span 50 MHz	
#Res BW 300 kHz		#VBW 1 MHz	Sweep 10 ms (1001 pts)
Occupied Bandwidth		Occ BW % Pwr	99.00 %
16.5393 MHz		x dB	-6.00 dB
Transmit Freq Error		-5.931 kHz	
x dB Bandwidth		16.448 MHz	
Undefined header			
Freq/Channel		Center Freq 2.46200000 GHz	
		Start Freq 2.43700000 GHz	
		Stop Freq 2.48700000 GHz	
		CF Step 36.2000000 MHz	
		Auto <u>Man</u>	
		Freq Offset 0.00000000 Hz	
Signal Track		On <u>Off</u>	
Scale Type		Log <u>Lin</u>	

EUT :	Epoc WIFI	Model Name :	W001
Temperature :	25 °C	Relative Humidity :	60%
Pressure :	1012 hPa	Test Voltage :	DC 3.7V
Test Mode :	TX n Mode(20M) /CH01, CH06, CH11		

Frequency	6dB Bandwidth (MHz)	99% Occupied BW (MHz)	Channel Separation (MHz)	Result
2412 MHz	17.29	17.49	>=500KHz	PASS
2437 MHz	17.04	17.49	>=500KHz	PASS
2462 MHz	17.30	17.51	>=500KHz	PASS

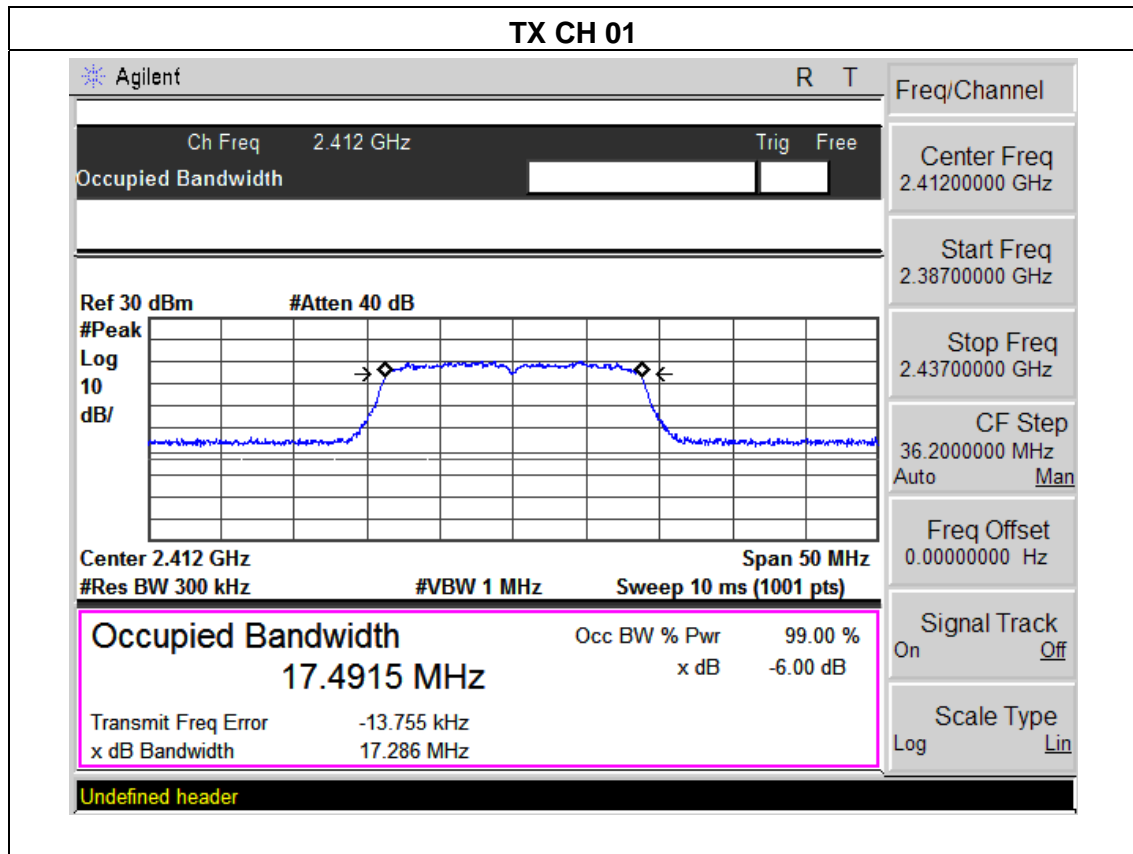

TX CH 06

Agilent R T

Ch Freq 2.437 GHz Trig Free

Occupied Bandwidth [] []

Ref 30 dBm #Atten 40 dB

Center 2.437 GHz Span 50 MHz

#Res BW 300 kHz #VBW 1 MHz Sweep 10 ms (1001 pts)

Occupied Bandwidth	Occ BW % Pwr	99.00 %
17.4896 MHz	x dB	-6.00 dB
Transmit Freq Error	-15.813 kHz	
x dB Bandwidth	17.035 MHz	

Undefined header

Freq/Channel

Center Freq
2.43700000 GHz

Start Freq
2.41200000 GHz

Stop Freq
2.46200000 GHz

CF Step
36.20000000 MHz
Auto Man

Freq Offset
0.00000000 Hz

Signal Track
On Off

Scale Type
Log Lin

TX CH 11

Agilent R T

Ch Freq 2.462 GHz Trig Free

Occupied Bandwidth [] []

Ref 30 dBm #Atten 40 dB

Center 2.462 GHz Span 50 MHz

#Res BW 300 kHz #VBW 1 MHz Sweep 10 ms (1001 pts)

Occupied Bandwidth	Occ BW % Pwr	99.00 %
17.5142 MHz	x dB	-6.00 dB
Transmit Freq Error	-6.897 kHz	
x dB Bandwidth	17.301 MHz	

Undefined header

BW/Avg

Res BW
300.000000 kHz
Auto Man

Video BW
1.00000000 MHz
Auto Man

VBW/RBW
10.00000
Auto Man

Average
10
On Off

Avg Type
Video Man

EMI Res BW
None

6. PEAK OUTPUT POWER TEST

6.1 APPLIED PROCEDURES / LIMIT

FCC Part15 (15.247) , Subpart C				
Section	Test Item	Limit	Frequency Range (MHz)	Result
15.247(b)(3)	Peak Output Power	1 watt or 30dBm	2400-2483.5	PASS

6.1.1 TEST PROCEDURE

- a. The EUT was directly connected to the Power meter

6.1.2 DEVIATION FROM STANDARD

No deviation.

6.1.3 TEST SETUP



6.1.4 EUT OPERATION CONDITIONS

The EUT tested system was configured as the statements of 2.4 Unless otherwise a special operating condition is specified in the follows during the testing.

6.1.5 TEST RESULTS

EUT :	Epoc WIFI	Model Name :	W001
Temperature :	25 °C	Relative Humidity :	60%
Pressure :	1012 hPa	Test Voltage :	DC 3.7V
Test Mode :	TX b/g/n(20M) Mode /CH01, CH06, CH11		

TX 802.11b Mode				
Test Channel	Frequency	Peak output power. Antenna port	Antenna Gain	LIMIT
	(MHz)	(dBm)	dBi	dBm
CH01	2412	11.92	1.0	30
CH06	2437	11.74	1.0	30
CH11	2462	11.52	1.0	30
TX 802.11g Mode				
CH01	2412	10.86	1.0	30
CH06	2437	10.79	1.0	30
CH11	2462	10.25	1.0	30
TX 802.11n Mode				
CH01	2412	10.77	1.0	30
CH06	2437	10.84	1.0	30
CH11	2462	10.37	1.0	30

7. ANTENNA REQUIREMENT

7.1 STANDARD REQUIREMENT

15.203 requirement: For intentional device, according to 15.203: an intentional radiator shall be designed to ensure that no antenna other than that furnished by the responsible party shall be used with the device.

7.2 EUT ANTENNA

The EUT antenna is FPCB antenna. It comply with the standard requirement.

8. EUT TEST PHOTO

Radiated Measurement Photos



Conducted Measurement Photos

