

---

# User's Manual

v1.2

---

## Table of Contents

### **CHAPTER 1**

#### **GETTING STARTED**

- Getting Started
- Inventory
- Safety and Maintenance
- Checklists
- Features
- Where to Look For Information
- Quick Start
- Loading Windows
- Adjusting the Volume
- Adjusting the Brightness
- Turning off Your Computer
- Making a Startup Disk
- Tips for New Owners

### **CHAPTER 2**

#### **GETTING STARTED**

- Hardware and Software
- Front View
- Left View
- Right View
- Bottom View
- LED Status Indicators
- Power Indicators
- Function Keys
- Numeric Keypad
- Touchpad
- The Optical Drive
- Connecting the Printer

---

**The PC Card Slot**  
**The Graphics System**  
**Communication Components**  
**Built-in Wireless Local Area Network**

**CHAPTER 3**  
**MAKING CONNECTIONS**

**Making Connections**  
**Left Side Connectors**  
**Right Side Connectors**  
**Front Side Connectors**

**CHAPTER 4**  
**POWER MANAGEMENT**

**Power Management**  
**Power Saving Modes**  
**Power Saving Tips**  
**When to Replace the Battery**  
**Heat Considerations**

**CHAPTER 5**  
**USING THE BIOS SETUP UTILITY**

**Using the BIOS Setup Utility**  
**Navigating and Entering Information in BIOS**  
**The Main Menu**  
**Advanced Menu**  
**Boot menu**  
**Security menu**  
**Exit menu**  
**Change User Password**  
**Change Supervisor Password**  
**CMOS Optimal Defaults**

---

Exiting and Saving

**APPENDIX A**  
**FREQUENTLY ASKED QUESTIONS**  
Frequently Asked Questions

**APPENDIX B**  
**STATEMENTS**

Statements

European Notice

UL CAUTION

Canadian Department of Communications

Battery Disposal

CAUTION FOR ADAPTER

BATTERY CAUTION

CLASS 1 LASER PRODUCT

---

---

**Chapter 1**  
**Introduction**

---

## **Getting Started**

Congratulations on your purchase of a Notebook computer! Your new notebook features the most innovative advances in portable computing technology. It combines state-of-the-art ergonomics with sophisticated architecture to provide you with a personal computer that is compact, powerful, and easy to use. Designed for a wide range of general, business, and personal productivity applications, this notebook is an ideal choice for use in the office, at home, and on the road.

For maximum expandability without compromising portability, the notebook accommodates a number of modules, including a combo DVD+CD-RW optical drive, two USB ports, one PCMCIA and one 4-in-1 card slot. The high capacity hard disk drive provides you with plenty of storage space for multimedia files and applications.

This Manual contains all the information you need to set up and use your new notebook. It describes all the features of the notebook in an easy-to-read yet thorough manner.

---

## Inventory

This computer system is designed for years of productive and pleasurable computing. Use this section to keep details of your purchase. This information will be required should you need to make repairs to your notebook during the warranty period. Update this section when you add new options.

**DATE OF PURCHASE:** \_\_\_\_\_  
**PLACE OF PURCHASE:** \_\_\_\_\_  
**STORE NAME:** \_\_\_\_\_  
**STORE ADDRESS:** \_\_\_\_\_  
**TELEPHONE:** \_\_\_\_\_  
**E-MAIL ADDRESS/WWW:** \_\_\_\_\_  
**CONTACT PERSON:** \_\_\_\_\_  
**MODEL NUMBER:** \_\_\_\_\_  
**SERIAL NUMBER:** \_\_\_\_\_

The serial number is on the label (with a bar code) on the bottom side of the computer.

---

## Safety and Maintenance

You can use your computer under a wide range of environmental conditions. However, to ensure long use and continued high performance, consider the following factors when setting up your computer:

- Follow all warnings and instructions noted in this documentation and in the Windows Help program.
  - The first time you use your computer, we recommend that you carefully read the Making Connections section of this manual and initialize the battery to ensure optimum battery performance.
  - Unplug the computer from the power outlet before cleaning. Use a damp cloth for cleaning. Do not use aerosols, solvents, or strong detergents.
  - Do not use the computer near open water or other liquids. Never spill liquid onto the computer.
  - Do not place the computer in an unstable location where it might slip or be knocked over. Serious damage could result from a fall.
  - Slots and openings in the system cabinet are for ventilation purposes. Do not block or cover these openings or the system could overheat. Do not use or store the computer near a source of heat or dust.
  - On the base or rear panel of this notebook, there is a label with information on the power requirements of this system. These requirements must be followed. If you are unsure of your local power supply, consult your dealer or local Power Company.
  - Do not step on or place anything on the power cord.
  - If you use the computer with an extension cord, ensure that the total ampere ratings of all the devices sharing the extension do not exceed the rating of the extension cord or the rating of the wall outlet.
  - Never push foreign objects into the computer through any of the slots or openings. Dangerous voltages are present, which could cause electric shock or fire, or damage sensitive components.
-



- For best results, use a power strip with a built-in surge protector. Do not use inferior extension cords as this may result in damage to your computer.
- Set the computer on a flat, stable surface. To prevent damage to the computer's hard disk drive, avoid using the computer where it will be exposed to strong vibration.

## Checklists

After opening the package, carefully inspect the contents. If any of the items are missing or appear damaged, contact your dealer. The shipping carton should contain the following:

### STANDARD

- Notebook computer
- Internal battery
- AC adapter with power cord



**Caution:** When purchasing any of the accessories listed above, purchase only those accessories that are approved for use with your computer. The above accessories are proprietary items. Your system vendor can obtain these approved accessories. If you use items that are not approved for use with this computer, you may cause your computer to malfunction, or to emit or receive electro-magnetic radiation in excess of local regulations. For non-proprietary accessories such as PC cards or printers, ensure that the accessory functions properly in your computer before making the purchase. Your system vendor may be able to recommend reliable brands and models.

---

## Features

### **High Capacity Hard Disk Drive**

The computer has a high capacity hard disk drive, to store your favorite programs and large multimedia files.

### **Built-in Modem/LAN Capability**

A built-in 56k modem and 10/100 Mbps Ethernet port allows you to access the Internet or a local area network (LAN).

### **AveraBrite™ LCD Display**

Your computer has an easy-to-view WXGA LCD panel with AveraBrite™

### **Built-in Stereo Speakers**

The stereo speakers output sound from your multimedia applications.

### **Windows Media® Player Quick Launch**

One button lets you play movies, or music by quickly launching Windows Media® Player.

---

## Where to Look For Information

### About Your Computer

This User's Manual describes the key elements of your computer. New users can find a simple step-by-step orientation in the Quick Start section of this chapter.

### About Windows

**Windows Online Help**, found on the Start menu, offers extensive Windows assistance. **Tour Windows XP** offers an online orientation for new Windows users. Find it in: *Start/Programs/Accessories*

---

## Quick Start

### Turning on the Computer for the First Time

1. Connect the power cord to the AC adapter.
2. Connect the AC adapter to the DC power port on the rear of your computer.
3. Connect the AC adapter power cord to an AC outlet.
4. Open the LCD panel to a comfortable viewing angle.
5. Press the power button to turn on the power.

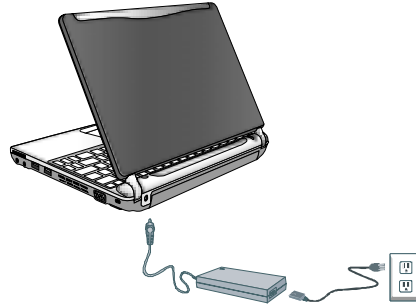

---

**Note:** The battery is not fully charged. Allow your battery to fully charge before using it (i.e., before disconnecting AC power). Calibrating the battery before use is also highly recommended. Refer to Chapter 5, *Power Management*, for further information.

---

## Adjusting the Volume

You can adjust the volume with hot key combination as below:

- Fn + F8 decreases the volume
  - Fn + F9 increases the volume
  - Fn + F10 Mute the volume
-

Alternatively, you can adjust the volume with the Windows volume control applet located on the taskbar.

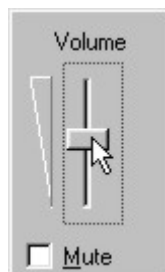

## Adjusting the Brightness

Use the following hot key combinations to adjust the LCD panel brightness:

- Fn + F6 decreases the brightness
- Fn + F7 increases the brightness

## Turning off Your Computer

Turning off the computer properly is important in maintaining your computer.

1. On the Start menu, click **Shut Down**.

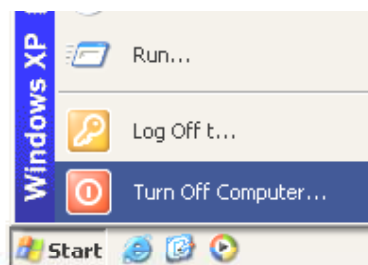

2. Click the red button in the Shut Down Windows screen, and then click **OK**.

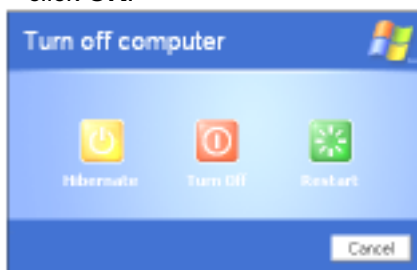

If you are going to be away from the computer for a short period, there are ways of conserving power without shutting down the system. See Chapter 5, *Power Saving Modes*, for details.

---



**Warning:** Shutting off the computer improperly may result in data loss.

---

## Tips for New Owners

### **Take responsibility for backup**

Back up files often. Users who need to manage large amounts of data may wish to use backup devices such as a USB drive. If you use your notebook as a networked workstation with system backup, talk to the system administrator about backup procedures for your notebook.

### **Don't leave passwords anywhere on your notebook or carrying case**

### **Be careful when placing your notebook on an airport security conveyor belt**

In most airports, security conveyor belts are safe for computers. If you are not sure, ask the security staff. You should keep a close eye on your computer. When you are in a hurry, make sure that you walk away with the correct notebook computer!

### **Tape your business card to the notebook and accessories**

In the workplace, notebooks and accessories may often look exactly alike, leading to equipment mix-ups. Prevent such mix-ups by placing your name on your equipment.

### **Never take the notebook anywhere without a carrying case**

A broken screen or case can be costly to repair. Prevent accidents by carrying the computer in a suitable carrying case.

### **Consider using a lock**

For added security, consider purchasing a Kensington lock to put into the Kensington lock hole on the right side of your computer (see Chapter 2, *Left View*). Use the Kensington lock to secure the computer to a desk or table.

---



**Note:** Using a computer for extended periods of time with a poor workstation setup and incorrect work habits can cause health problems.

---

---

# **Chapter 2**

## **Getting Started**

---





## Hardware and Software

This chapter introduces the different components and controls of your notebook computer, including the hardware components, the software, and the audio and video systems.

### *Getting Started*

Before you begin using your computer, read this chapter to familiarize yourself with the main components installed in the system.



## Front View

- |                      |  |
|----------------------|--|
| 1. LCD panel         | 6. Touchpad                                  |
| 2. Speakers          | 7. Touchpad buttons                          |
| 3. Power button      | 8. Wireless LAN switch                       |
| 4. Keyboard          | 9. Windows Media® Player Quick Launch Button |
| 5. Status indicators |  |

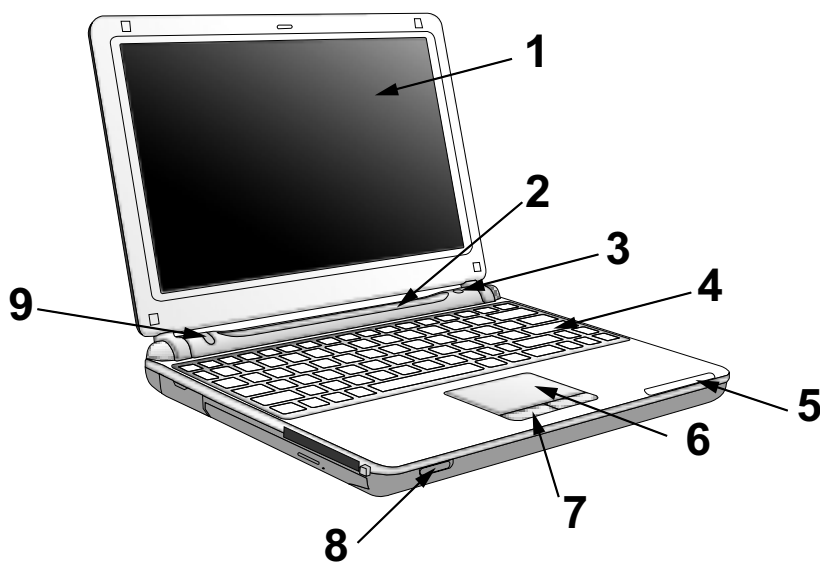

## Left View

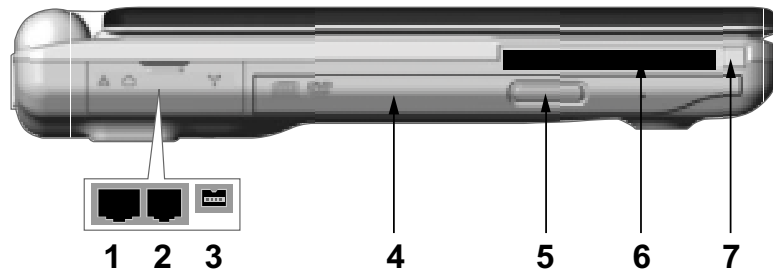

1. LAN RJ-45 jack
2. Fax/modem RJ-11 Jack
3. IEEE 1394 port
4. Optical drive Bezel
5. Optical drive button
6. PCMCIA card slot
7. PCMCIA card eject button

## Right View

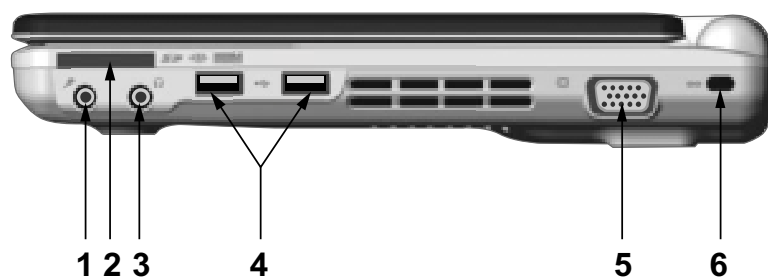

1. Microphone jack
2. MS/MMC/SD/MS Pro card slot
3. Ear phone jack
4. USB ports
5. VGA external video display port
6. Kensington lock hole



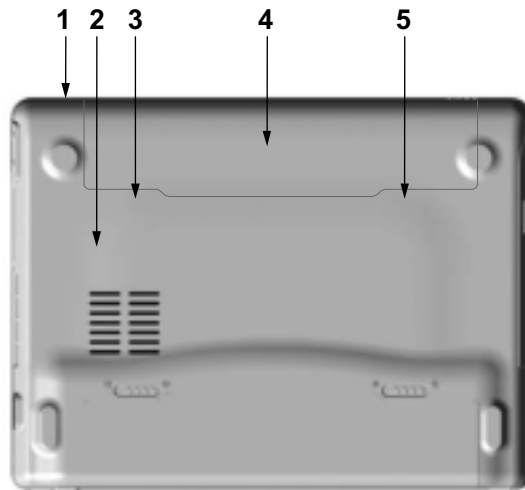

## Bottom View

1. DC-IN jack
2. Ventilation slot
3. Battery release latch
4. Battery
5. Battery lock





## LED Status Indicators

The status indicators in the lower right corner of the keyboard light up when a particular function of the computer is active. Each indicator is marked with a symbol.

	<b>CD ROM Drive</b>	The computer is reading information from the DVD-ROM or the Combo drive.
	<b>Number-Lock</b>	The keyboard is in Num-Lock mode.
	<b>Caps-Lock</b>	The keyboard is in Caps-Lock mode.

## Power Indicators

The power indicators show which power source the system is using. The power indicators remain active and viewable even when the LCD panel is closed.

Icon	Light	Description
	Blue	Power is on and the AC adapter is in use
	Flash blue	Power is in suspend mode
	Blue	Wireless LAN is in use
	Green	Power is on and the battery is in use
	Flashing Green	Battery is charging
	Red	Low battery

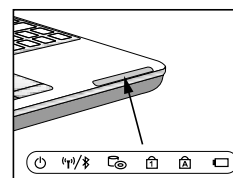

## Function Keys

Hold the <Fn> key while pressing the numbered function key.

Function key	Description
<b>Fn + F3</b>	Toggles display on/off
<b>Fn + F4</b>	Suspend to RAM/HDD
<b>Fn + F5</b>	Toggles between LCD/CRT displays
<b>Fn + F6</b>	Decreases LCD brightness
<b>Fn + F7</b>	Increases LCD brightness
<b>Fn + F8</b>	Decreases Volume
<b>Fn + F9</b>	Increases Volume
<b>Fn + F10</b>	Mute Volume

## Numeric Keypad

The embedded numeric keypad consists of ten keys that make number intensive input more convenient. Press <NumLock> to enable or disable the numeric keypad.



## Touchpad

The touchpad is a pressure sensitive pointing device that provides all the features of a two-button mouse. Its primary function is to move the cursor around the screen.

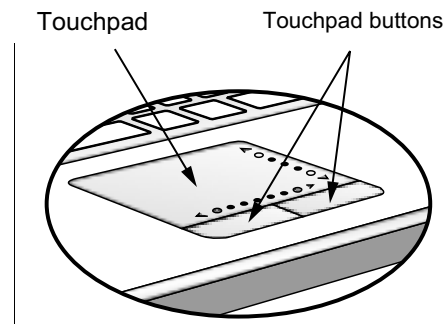

The instructions listed below describe how to use the touchpad.

1. First, place your fingers on the keyboard in the normal typing position. The touchpad is easily accessible by moving either your left or right thumb off the space bar and on to the touchpad.
2. Gently move your thumb across the pressure-sensitive touchpad in the direction you want the cursor to move. The pad detects the change in pressure and moves the cursor in the corresponding direction.
3. The touchpad offers another method of making selections in a software program. It is called *double-tapping*. This function corresponds to double-clicking with a mouse. Once the cursor has been moved to the object you want to select, *lightly* double-tap the pressure sensitive touchpad. This double-tapping on the touchpad will select the desired item and prompt the software to perform the related operation.
4. The buttons located directly below the touchpad are the same in function as those on a two-buttoned mouse. Clicking these buttons makes selections, drags objects, or performs a variety of other functions depending on the software. To select an object, first move the pointer over the object you want to select, and then press the left button one time. The functions of these buttons are software specific.



5. *Double-clicking* is a common technique for selecting objects or launching programs from icons. Once you have moved the pointer over the object you wish to select, rapidly press the left button two times. This action is commonly referred to as “double-clicking” an object.

### ***Dragging***

There are two ways to drag:

- Move the pointer to the desired location then press down the left button. While still holding down the left button, move the pointer to the desired location. Release the button.
- Move the pointer to the desired location. Tap the touchpad twice quickly as if you were double-clicking, however do not remove your finger after the second tap. Move the cursor to the desired location. Lift your finger to finish dragging.

Adjust the touchpad settings by selecting Settings/Control Panel/Printers and Other Hardware/Mouse/Buttons. These settings allow you to change the orientation of the touchpad from right-handed to left-handed, and fine tune the pointer movement and timing of clicks.

### ***Touchpad Precautions***

The Touchpad is a pressure-sensitive device. If not properly cared for, it can be easily damaged. Please take note of the following precautions.

- Make sure the touchpad does not come into contact with dirt, liquids or grease.
- Do not touch the touchpad if your fingers are dirty.
- Do not rest heavy objects on the touchpad or the touchpad buttons.

### ***Scrolling Buttons***

If you are scrolling through a document, you may find that using the scrolling line is more restful to your hand than holding down a mouse button. The scrolling line is located on the touchpad.



## The Optical Drive

Your computer comes with a pre-installed Optical drive. The optical drive can read both DVDs and CDs. Your notebook identifies the drive with the letter following the hard drive letter. If your hard drive is C, then the optical drive will be D.

### Inserting a Disc

1. Press the button on the front of the drive to open the disc tray and pull the tray open.
2. Place the disc on the tray, label side up.
3. Place the disc on the central spindle and press gently until the disc clicks into place.
4. Slide the tray back until it clicks shut.

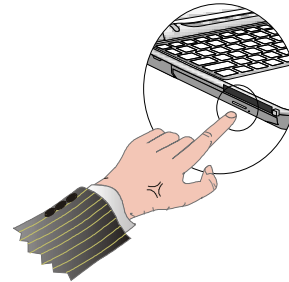

### Removing a Disk

1. Make sure the computer is not accessing the optical drive.
2. Press the eject button and pull the tray all the way out.
3. Pick up the disc by the edges and remove the disc from the tray. Push the tray into the computer until it closes fully.



**Warning:** When the computer is reading from the optical drive, the indicator light for the DVD-ROM will flash on. Do not attempt to remove the disc while the indicator light is active.

---

### Precautions for Handling DVD/CDs

Keep these precautions in mind when handling DVD/CDs.

- Always hold the disc by the edges; avoid touching the surface of the disc.
  - Use a clean, dry, cloth to remove dust, smudges, or fingerprints. Wipe from the center outward.
- 



## Chapter 2 — Getting Started

---

- Do not write on the surface of the disc.
- Extremes in temperature may damage discs. Store discs in a cool dry place.
- Do not use benzene, thinners, or cleaners with detergent. Only use optical cleaning kits.
- Do not bend or drop the discs.
- Do not place objects on top of discs.



**Warning:** Do not insert any foreign objects into the disc tray. Do not force the tray to open or close manually. When not in use, keep the tray closed to prevent dust or dirt from entering the drive unit. If you experience difficulty when removing a CD disc, stretch a paper clip (or use a pin or a thin metal rod) and insert it into the emergency eject hole located on the bezel:

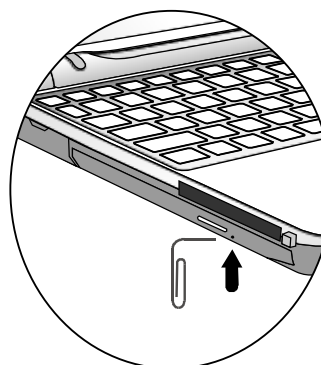

The CD disc tray should eject immediately. This procedure can also be used to remove a CD from the drive when the notebook is powered off.

---

## The PC Card Slot

The PC card slot can be used as an interface between your computer and a variety of communications devices, such as network adapters, fax/modems or provide additional data storage capacity. Your computer's PC card slot supports PCMCIA Type II and 32-bit CardBus.

### *Installing a Card*

1. The top side of a PC card is usually identified with a label. Insert the card into the slot with the label side up and the edge with pinhole contacts going in first.
2. Insert the card into the slot. You will feel some resistance as the card slides into the back of the slot.
3. PC cards require drivers, or a program that allows the operating system to use a specific device. Many drivers are included with Windows, but if not, you will be prompted to install the driver included with your card.
4. The computer will beep twice to indicate successful installation. A single beep means that there was a problem recognizing the card.

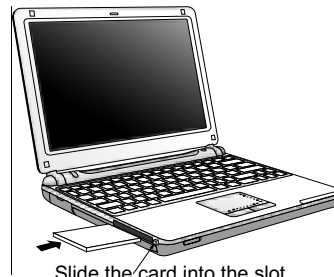

**Note:** Please read the instructions included with individual PC cards. Some cards may be inserted with the power on, while others require that the computer be turned off.

---

### *Removing a Card*

1. Press the eject button on the card slot to release the eject button.
  2. Press the eject button to release the card.
- 



## The Graphics System

Your computer has a high-performance graphics system, which can easily handle the demands of today's multimedia computing.

### **Screen Controls**

#### **Brightness**

Function keys can increase or decrease the brightness of the monitor.

- <Fn> + <F6> decreases the LCD panel brightness
- <Fn> + <F7> increases the LCD panel brightness

#### **Resolution**

1. Click My Computer/Control Panel/Appearance and Themes/Display. Click the Settings tab. The dialog box indicates the monitor resolution.
2. Use the slide bar to adjust the resolution. Normally, you should use the resolution the LCD or monitor was designed for.



**Note:** Using a lower resolution than the screen was designed for will reduce the area of the display. Using the computer in DOS mode may produce the same effect, because it uses a 640 by 480 resolution by default.

---

#### **High Resolution with an external monitor**

Higher resolution modes may be used, as long as the monitor supports them.

#### ***Connecting to an External Monitor***

The notebook has a VGA monitor port to connect your computer to an external monitor.

#### **Using the VGA monitor port**

1. Locate the 15-pin VGA monitor port on the right side of your notebook and connect the video signal cable from the external monitor (or the VGA adapter) to the monitor port.
  2. Connect the power cable from the external monitor to a power outlet and turn on the monitor.
- 



3. On your notebook, click the right touchpad button on the Windows desktop to open the desktop menu. Click **Properties** to open the Display Properties window.
4. In the Display Properties window, click **Advanced** in the Settings tab. Click the **Intel Extreme Graphics** tab.
5. You are now able to select the appropriate options to change the display to an external monitor.
6. Adjustments to screen resolution and color depth can also be made in this dialog box.

### Dual Displays

With Windows system, you may use an external monitor simultaneously with your notebook's LCD. You may also use the external monitor only and disable the LCD or only use the LCD.

1. Open the Control Panel.
2. Double-click **Display**. The Display Properties window opens.
3. Click the **Settings** tab.
4. Click the **Advanced** button.
5. Choose Intel® Extreme Graphics 2 for mobile
6. Click Graphic Properties



These options are described below.

<p><b>Single</b></p>	<p>You can choose which device to apply as the Primary display. In Single mode, the video display hot key combination is available—you can cycle the video output by pressing the Fn + F5 keys.</p>
----------------------	---



<b>Mirror</b>	In Mirror mode, the video display hot key combination is available—you can cycle the video output by pressing the Fn + F5 keys. If the external CRT is connected, the display on the LCD and the CRT is the same.
---------------	---

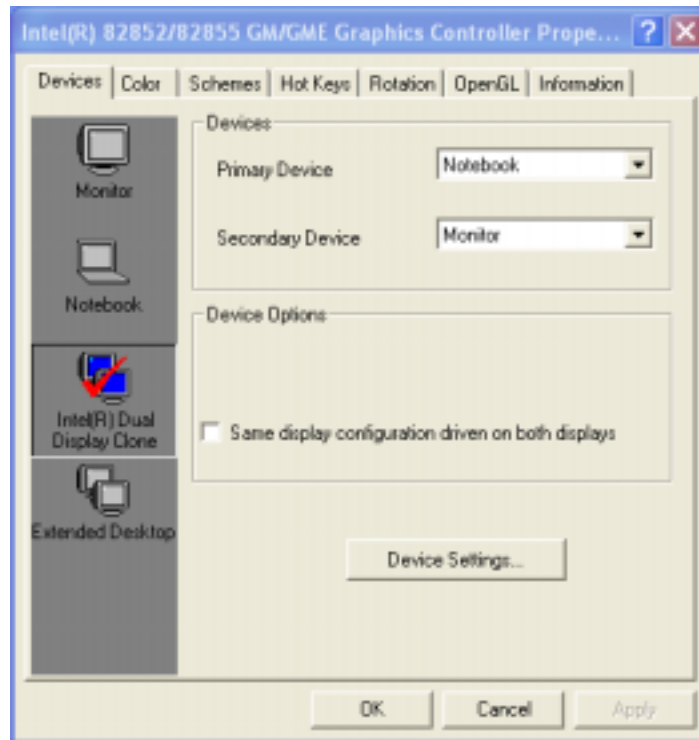

---

 **Tip:** To ensure trouble-free video output, the first time you use an external monitor, change the output in the Display Properties dialog box. After successfully switching modes, you may use the video function keys.

---





**Note:** Light or dark dots may appear on the LCD due to technical limitations of LCD manufacturing. This will not effect normal operation of the LCD.

---

## Communication Components

This system provides powerful communication functions, including a built-in Fax/Modem and PCMCIA card slot.

### Fax/Modem

A phone jack on the left side of the computer allows you to connect to the Internet to send and receive data. When used with fax software, it can be used as a fax. When using this function, first plug the phone cord into the jack.

#### **Attention:**

When using the data communications function, please do not plug the phone cord into the ISDN or PBX jack to avoid an electrical surge that will cause the MDC module to burn.

## Information about the Wireless LAN button

### Built-in Wireless Local Area Network

The built-in Wireless Local Area Network (WLAN) interface card can provide a quick access without using cables for the connection to the network equipments. The interface card adopts the IEEE 802.11 protocol and uses the 2.4 GHz ISM electric wave frequency band as the transmission interface to set up the communications between the host computer and other computers.

The processing of communications through the WLAN interface card is the same as that through an Ethernet interface card. The “Configuration Tool” is a Window application program.

---







**DGT Warning**

**Article 14**

Without permission, any company, firm or user shall not alter the frequency, increase the power, or change the characteristics and functions of the original design of the certified lower power frequency electric machinery.

**Article 17**

The application of low power frequency electric machineries shall not affect the navigation safety nor interfere a legal communication, if an interference is found, the service will be suspended until improvement is made and the interference no longer exists.

The foregoing legal communication refers to the wireless telecommunication operated according to the telecommunications laws and regulations. The low power frequency electric machinery should be able to tolerate the interference of the electric wave radiation electric machineries and equipments for legal communications or industrial and scientific applications.

---

---

**Chapter 3**

**Making  
Connections**

---



## Making Connections

Your computer is equipped with a full array of ports and connectors, including standard input/output (I/O) ports for quickly and easily adding peripheral devices such as printers, keyboards, and mice. Refer to documentation included with individual devices for details on connecting these devices to your computer. Along with the standard ports found on most computers, your computer also includes IEEE 1394 ports, modem and LAN ports, offering advanced communications technology.

### Left Side Connectors

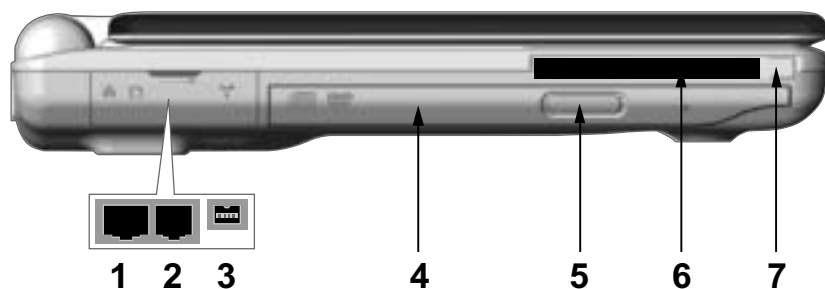

#### **1. LAN RJ-45 Jack**

With the built-in Ethernet LAN combo, you can make LAN connections. Connection speed is up to 100 Mbps.

#### **2. Fax/modem RJ-11 Jack**

The fax/modem can transmit data using the 56 Kbps V.90 protocol, and send and receive faxes at 14.4 Kbps. In some countries, local regulations may not permit the use of the fax/modem designed in this system. In this case, you may use an add-on modem.

---



**Warning:** Plug your modem into an analog telephone jack only. Most homes use analog lines. Do not use digital lines, such as the PBX and ISDN systems found in many offices. Digital lines may damage your modem.

---

### ***3. FireWire / IEEE 1394 / 1394a Port***

This is a high-speed serial data port. You may connect any FireWire compatible device to this port.

### ***4. Optical Drive***

Your computer comes with a built-in Combo DVD+CD-RW Drive. You may view DVDs and write to a CD-R or CD-RW disc.

### ***5. Disk Eject Button***

Press the eject button to eject the disk tray. The manual eject keyhole is located next to it and allows you to manually eject a jammed disc.

### ***6. PC Card Slot (Type II PCMCIA)***

This slot is where a Type II PC Card is inserted.

### ***7. PC Card Eject Button***

Press the eject button to release the PC Card.

## **Right Side Connectors**

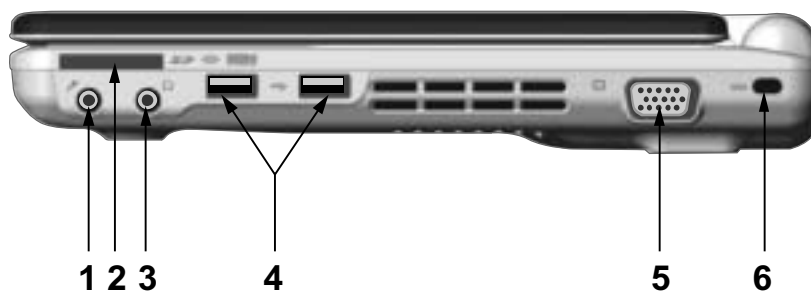

***1. Microphone-in Jack***

Connect a microphone to this jack to record.

***2. MS Pro/MS/MMC/SD 4-in-1 card reader slot***

The 4-in-1 card reader slot is specially used for the device with a MS Pro/MS/MMC/SD interface card. Insert the card into the 4-in-1 card reader slot securely for device access.

***3. Audio-out Jack***

Connect a stereo headset or external speakers to this jack to listen to multimedia.

***4. USB 2.0 (Universal Serial Bus) Ports***

The Universal Serial Bus (USB) is the latest standard for attaching monitors, input devices, scanners, and other devices to a PC. USB devices can be chained together on a single cable.

***5. VGA Out (External Video) Port***

The 15-pin VGA port can be used to connect your computer to an external monitor. (See the Graphics System in chapter 2 for more information).

***6. Kensington Lock***

Your computer includes a Kensington lock slot for use with a Kensington lock. You can secure your notebook with the Kensington lock to prevent theft. See the documentation that comes with your Kensington lock for more information.

---

## Front Side Connectors



### ***1. Wireless LAN On/Off Switch***

Use the switch to disable or enable the Wireless LAN function.

---

---

**Chapter 4**

**Power  
Management**

---

## Power Management

### *Battery Calibration*

The first time you use a battery, you should calibrate it. The calibration process empties and charges the battery one time. This allows the Windows battery gauge to accurately monitor battery status. To calibrate a battery, follow these steps:

1. Plug in the AC adapter.
2. Restart the computer and when the startup screen appears, press **F2** key to enter the BIOS Setup Utility.
3. In the BIOS Setup Utility, select Advance settings. , choose Battery learning, then press enter.

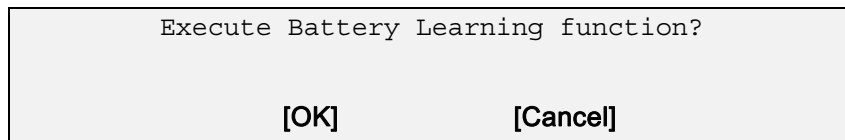

4. Press <OK> at the above Battery Auto Calibration dialog to begin the battery calibration..

Battery Calibration takes from 4 to 8 hours, depending on how much power the battery already contains.



**Note:** For optimum performance, we recommend calibrating the battery every three months. Each time you charge and discharge a battery, it loses a tiny part of its storage capacity, so that over time, it will store less than its potential charge. Similarly, if you do not use the battery for a few days, it will slowly self-discharge, and when it is recharged, it will hold less than 100% of the potential charge.

---

---



## Monitoring Battery Power

There are two ways to monitor how much power the battery has left.

1. Click start/Control Panel/Performance and Maintenance/Power Options; then click Power Meter.
2. Moving the cursor to the battery icon on the taskbar is the simplest way to check on battery power status.



If you do not see the battery icon, enable it in Start /Control Panel/Performance and Maintenance/Power Options. Choose the Advanced tab and click “Always show icon on the taskbar.”

### *Low Battery Alarms*

How your computer responds to a low battery condition is set under Start/Control Panel/Performance and Maintenance/Power Options/Alarms. Two different power alarms can be enabled or disabled: the Low Battery Alarm, and the Critical Battery Alarm. Use the sidebar to set the power level at which the alarms are activated. Click on the Alarm Action button to choose whether the alarm sounds, displays a message, or both.



**Warning:** When battery power is low, the Notebook will display a warning on the screen. Take immediate action, such as saving files or connecting to the AC adapter, or data may be lost.

---

When the computer alerts you that the battery is low, immediately do one of the following:

---

- Connect the AC power adapter
- Save your work, turn off the computer and replace the discharged battery with a charged battery (See *Changing the Battery* below).

Do not restart the computer until you have connected to an AC adapter, or replaced the discharged battery with a charged battery.

### ***Battery Charging***

When you use the AC adapter to connect your Notebook to a power outlet, the internal battery will automatically begin to recharge. While the battery is charging, the Battery Charge icon on the Indicator panel will be active. When the battery is fully charged, the Battery Charge icon will turn off.

If your computer is turned off or standby mode, a fully discharged battery will take about 3 hours to recharge.

---

---

## **Power Saving Modes**

Adjust the default power management settings in the Power Options/Advanced dialog box. The Power Options Properties dialog box allows you to set different actions to take when the computer is left idle for a certain amount of time.

### ***Suspend Mode***

There are several possible settings for suspend mode, which can be selected in the Power Options dialog box: You may have the notebook standby, suspend, or you can power off the computer altogether.

### ***Initiating Suspend Mode***

There are four ways to initiate suspend mode. The settings can be adjusted in the Power Options dialog box:

- The computer will automatically enter suspend mode when not used for a set period of time.
  - Selecting the Stand by button in the Shut Down Windows dialog box.
  - Closing the screen cover (assuming no external monitor has been connected).
-

- Pressing the power button (if enabled in power settings).
- Pressing the suspend function key <Fn> + <F4>.

### ***Power Button Settings***

The function of the power button can be set to Shutdown or Standby in the Power Options Properties dialog box. However, holding the power button down for more than four seconds will force a power off while operating under any situation, resulting in the loss of any unsaved information.

### **Power Saving Tips**

- Avoid operating the fax/modem, or audio and video applications when using battery power. Operating a fax modem, video, or audio equipment increases the computer's power requirements.
  - Decreasing monitor brightness can also save power. Decrease brightness by pushing <Fn> + <F6>. Increase it by pushing <Fn> + <F7>.
-

## When to Replace the Battery

Over time, the battery's capacity gradually decreases. We recommend that you replace your battery when you notice that it begins to store significantly less charge.

### Changing the Battery

Change the main battery pack as follows:

1. Turn off the computer.
2. Close the screen cover and turn the computer over.
3. Unlock the side battery latch (2) by sliding it to the right.
4. Slide the side battery latch (1) to the left. Continue to hold it until the battery is removed.
5. Make sure the replacement battery is properly oriented. Insert the battery into the battery compartment and lock the latch (2) by sliding it to the left.

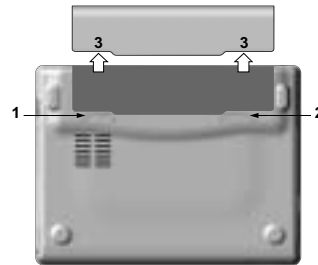

## Heat Considerations

The computer's processor has been specially designed to consume little power, and generates very little heat. However, working in a hot environment, or working for long periods may raise the temperature. Your computer takes the following steps to lower the temperature:

1. The cooling fan will automatically turn on. You may feel air coming from the vent.
  2. If the temperature continues to rise, processor activity will be reduced. You may notice a slight loss of performance when this happens.
-

---

**Chapter 5**

**Using the BIOS  
Setup Utility**

---



## Using the BIOS Setup Utility

Your notebook has a BIOS setup utility which allows you to configure important system settings, including settings for various optional functions of the computer. This chapter explains how to use the BIOS setup utility.

### *BIOS Setup Menu*

The BIOS setup Utility allows you to configure your computer's basic settings. When you turn your computer on, the system reads this information to initialize the hardware so that it can operate correctly. Use the BIOS setup utility to change your computer's start-up configuration. For example, you can change the security and power management routines of your system.

### *Starting the BIOS Setup Utility*

You can only enter the BIOS setup utility as the computer is booting, that is between the time you turn on the computer and before the Windows interface appears. If your computer is already on, shut down your computer completely (power off) and restart it and then press the **F2** key to enter the setup utility.



*Navigating and Entering Information in BIOS*

Use the following keys to move between fields and to enter information:

← →	Select Tab
↑↓	Push the up and down arrow keys to move among selections, then press <b>Enter</b> to make a selection.
+ -	Change Option
<b>Tab</b>	Select Field
<b>F1</b>	General Help
<b>F10</b>	Save and Exit
<b>ESC</b>	Press <b>Esc</b> to exit any section. If you wish to exit the BIOS utility <i>without</i> saving changes, go to the main menu, then press <b>Esc</b> .

Users are allowed to enter new values to replace the default settings in certain fields, and the rest fields are specified by system default parameters and cannot be modified by users. Reverse the attribute of the main options and press the Enter key to enter into the submenu. Press the Esc key to return to the previous configuration page.



*The Main Menu*

BIOS SETUP UTILITY				
Main	Advanced	Boot	Security	Exit
<b>System Overview</b>		Use [ENTER] , [TAB] Or [SHIFT-TAB] to select a field.		
<b>AMIBIOS</b> Version : R0.XX Build Date: 01/01/04		Use [+] or [-] to Configure system Time		
<b>Processor</b> Type :Intel® Pentium® M processor 1100MHz Speed :1100MHz				
<b>System Memory</b> Size : 504MB		?? Select Screen ?? Select Item +- Change Option Tab Select Field F1 General Help F10 Save and Exit ESC Exit		
<b>System Time</b> [19:14:50] <b>System Date</b> [Thu 01/01/2004]				
V02.53 ©Copyright 1985-2002, American Megatrends , Inc.				

*Figure 6-1*





*Advanced Menu*

BIOS SETUP UTILITY				
Main	<b>Advanced</b>	Boot	Security	Exit
Advanced Setting		Select the amount of system memory used by the internal graphics device..		
Legacy USB Support	[Enable]			
Battery Learning	[Enter]			
Start FAN Learning	[Enter]			
Battery Alarm Function	[Disabled]			
		?? Select Screen ?? Select Item +- Change Option F1 General Help F10 Save and Exit ESC Exit		
V02.53 ©Copyright 1985-2002, American Megatrends , Inc.				

Figure 6-2

*Boot menu*

BIOS SETUP UTILITY				
Main	Advanced	Boot	Security	Exit
1st Boot Device	[CD-ROM]			
2 <sup>nd</sup> Boot Device	[HDD]			
3rd Boot Device	[Network]			
			Specifies the boot sequence from the available devices.	
			A device enclosed in Parenthesis has been disabled in the corresponding type menu.	
			?? Select Screen	
			?? Select Item	
			+ - Change Option	
			F1 General Help	
			F10 Save and Exit	
			ESC Exit	
V02.53 ©Copyright 1985-2002, American Megatrends , Inc.				

*Figure 6-3*



*Security menu*

BIOS SETUP UTILITY				
Main	Advanced	Boot	<b>Security</b>	Exit
<b>Security Settings</b>		Install or Change the password.		
Supervisor Password : Not Installed User Password : Not Installed				
<b>Change Supervisor Password</b> Change User Password		?? Select Screen ?? Select Item Enter Change F1 General Help F10 Save and Exit ESC Exit		
V02.53 ©Copyright 1985-2002, American Megatrends , Inc.				

*Figure 6-4*

*Exit menu*

BIOS SETUP UTILITY				
Main	Advanced	Boot	Security	<b>Exit</b>
<b>Exit Options</b>		Exit system setup after saving the changes.		
<b>Save Changes and Exit</b>		F10 key can be used for this operation.		
Discard changes and Exit				
Discard Changes				
Load Optimal Defaults		?? Select Screen		
		?? Select Item		
		Enter Go To Sub Screen		
		F1 General Help		
		F10 Save and Exit		
		ESC Exit		
V02.53 ©Copyright 1985-2002, American Megatrends, Inc.				

*Figure 6-5*



***Change User Password***

With a User password, you can enter the Setup Utility and change or remove the User password, but you cannot enter the Setup Utility and change or remove the Supervisor password, nor enable diskette access if it has been disabled.

***Change Supervisor Password***

A supervisor password must be set before a lower-level user password can be set. After selecting **Change Supervisor Password**, press **Enter**. You will be prompted for the new password, and then again to verify it. Type in 6 or fewer keystrokes. If you make an error, press **Esc** to start over.

***Resetting the CMOS to Default Settings***

The Exit tab provides the system parameters for you to reset the CMOS to default settings. After you enter this page, select the Load Optimal Defaults:

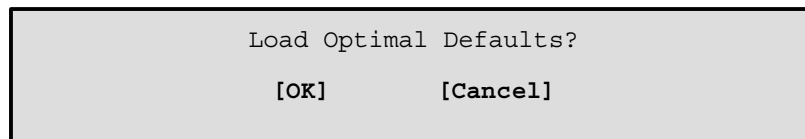

Select [OK] to reset the CMOS to default settings.

***Exiting and Saving***

Save Settings and Exit	Select this option to save changes to the field values, and restart the computer using the new values. (Pressing F10 from any of the menu screens also allows you to save settings and exit.)
Exit Without Saving	Select this option to discard any changes you have made to the field values, and restart the computer using the old values.



---

**Appendix A**  
**Frequently**  
**Asked**  
**Questions**

---

## Frequently Asked Questions

**Q: My screen times out too quickly. I have to constantly hit a key or move the mouse in order to bring it back. How can I adjust the screen time-out?**

A: This is part of Windows Power Management. Access Power Management by clicking on **Start / Settings / Control Panel / Performance and Maintenance / Power Options / Power Schemes**. Adjust the display time-out by selecting a time next to the Turn off monitor option. You may also select different time-out values for adapter and battery power states.

**Q: I've heard that cleaning up and rearranging files on the hard drive will improve the startup speed of my programs. How do I do this?**

A: Hard disk maintenance can improve the startup speed of programs. This maintenance includes deleting unnecessary files, and defragmenting, which rearranges data into more efficient groupings. Windows includes utilities for performing these maintenance tasks. Run Disk Cleanup to remove unnecessary files, and Disk Defragmenter to defragment the hard drive. For more information, go to Start/All Programs/Accessories/System Tools

**Q: What kind of external microphone can I use with my notebook computer?**

A: You will need to use a self-amplifying microphone.

**Q: Because of a software problem, I was unable to shut down power normally. I pressed the power button to force a power off, but it didn't work. How can I force a power off?**

A: Make sure you press the power button for at least 4 seconds. Normally, this will force a power off.

**Q: Why can't I charge the battery of my portable computer after it was out of use for some time?**

---

A: After portable computers have not been used for a long time (more than one month), the batteries will go into the low voltage protection mode due to data back-ups and natural electrical discharge. At that point, restoring normal voltage will require slow charging over a period of several hours. Calibration can be performed after the battery has returned to a normal condition.

**Q: My computer alerts “CMOS Battery Low”, what can I do?**

A: If you keep your computer in no power situation (unplug the computer from the power outlet and remove battery at the same) over 45 days, your data in CMOS will be lost.

Please reconfigure your CMOS by following steps:

1. Press **F2** to enter the BIOS setup utility.
2. Select “**Load Optional Defaults?**”. When you see the following prompt, choose <OK> and then press <Enter>.

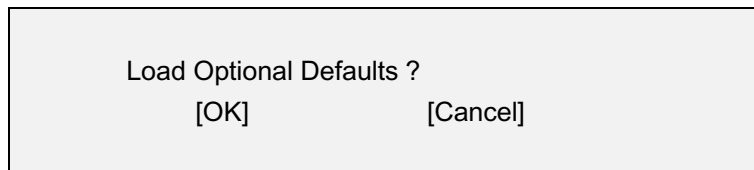

3. Select “**Save Changes and Exit?**”. When you see the following prompt, choose <OK> and then press <Enter> to restart your computer.

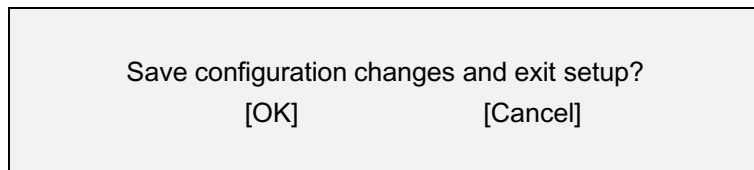



---

**Appendix B**  
**Statements**

---

## Statements

### ***Federal Communications Commission Statement***

This equipment has been tested and found to comply with the limits for a Class B digital device, pursuant to Part 15 of the FCC Rules. These limits are designed to provide reasonable protection against harmful interference in a residential installation. This equipment generates, uses, and can radiate radio frequency energy and, if not installed and used in accordance with the instructions, may cause harmful interference to radio communications. However, there is no guarantee that interference will not occur in a particular installation. If this equipment does cause harmful interference to radio or television reception, which can be determined by turning the equipment off and on, the user is encouraged to try to correct the interference by one or more of the following measures:

1. Reorient or relocate the receiving antenna.
2. Increase the separation between the equipment and the receiver.
3. Connect the equipment into an outlet on a circuit different from that to which the receiver is connected.
4. Consult the dealer or an experienced radio/TV technician for help.

Shielded interconnect cables and shielded AC power cable must be employed with this equipment to insure compliance with the pertinent RF emission limits governing this device. Changes or modifications not expressly approved by the system's manufacturer could void the user's authority to operate the equipment.

This Transmitter must not be co-located or operating in conjunction with any other antenna or transmitter.

### ***Declaration of Conformity***

This device complies with part 15 of the FCC rules. Operation is subject to the following conditions:

- This device may not cause harmful interference
- This device must accept any interference received, including interference that may cause undesired operation.

***About The Modem***

This equipment complies with Part 68 of FCC rules. On the bottom of this equipment is a label that contains, among other information, the FCC registration number and ringer equivalence number (REN) for this equipment. If requested, this information must be provided to the telephone company.

The modem jack of this equipment complies with Sub-part F of Part 68 of FCC rules.

The REN is used to determine the quantity of devices that may be connected to the telephone line. Excessive RENs on the telephone line may result in the devices not ringing in response to an incoming call. In most, but not all areas, the sum of the RENs should not exceed five (5.0). To be certain of the number of devices that may be connected to the line, as determined by the total RENs contact the telephone company to determine the maximum REN for the calling areas.

If the terminal equipment causes harm to the telephone network, the telephone company will notify you in advance that temporary discontinuance of service may be required. However, if advance notice isn't practical, the telephone company will notify the customer as soon as possible. Also, you will be advised of your right to file a complaint with the FCC if you believe it necessary.

The telephone company may mark changes in its facilities, equipment, operations, or procedures that could affect the operation of the equipment. If this happens, the telephone company will provide advance notice in order for you to make the necessary modifications in order to maintain uninterrupted service.

If trouble is experienced with this equipment, please contact the manufacturer for repair and (or) warranty information. If the trouble is causing harm to the telephone network, the telephone company may request you remove the equipment from the network until the problem is resolved.

The equipment cannot be used on public coin service provided by the telephone company. Connection to Party Line Service is subject to state tariffs. (Contact the state public utility commission, public service commission or corporation commission for information.)

---

## **Appendix B — Statements**

---

The Telephone Consumer Protection Act of 1991 marks it unlawful for any person to use a computer or other electronic device, including fax machines, to send any message unless such message clearly contains in a margin at the top or bottom of each transmitted page or on the first page of the transmission, the date and time it is sent and an identification of the business or other entity, or other individual sending the message and the telephone number of the sending machine or such business, other entity, or individual. (The telephone number provided may not be a 900 number or any other number for which charges exceed local or long-distance transmission charges.) To program this information, refer to the manual of the communication software.

### **European Notice**

Products with the CE Marking comply with both the EMC Directive (89/336/EEC) and the Low Voltage Directive (73/23/EEC) issued by the Commission of the European Community.

Compliance with these directives implies conformity to the following European Norms:

- **EN 55022** ( CISPR 22 ) Radio Frequency Interference
- **EN 55024** ( EN61000-4-2, EN61000-4-3, EN61000-4-4, EN61000-4-5, EN61000-4-6, EN61000-4-8, EN61000-4-11, EN61000-3-2, EN61000-3-3 ) Generic Immunity Standard
- **EN 60950** ( IEC950 ) Product Safety

### ***R&TTE (CE) MANUAL REGULATORY REQUIREMENT (WLAN - IEEE 802.11b/g)***

#### **802.11b/g Restrictions:**

- European standards dictate maximum radiated transmit power of 100mW EIRP and frequency range 2.400-2.4835GHz.
- In France, the equipment must be restricted to the 2.4465-2.4835GHz frequency range and must be restricted to indoor use."

### **CE Declaration of Conformity**

---

Is herewith confirmed to comply with the requirements set out in the Council Directive on the Approximation of the Laws of the Member States relating to Electromagnetic Compatibility (89/336/EEC), Low-voltage Directive (73/23/EEC) and the Amendment Directive (93/68/EEC), the procedures given in European Council Directive 99/5/EC and 89/336/EEC.

The equipment was passed. The test was performed according to the following European standards.

- EN 300 328 V.1.4.1 (2003-04)
- EN 301 489-1 V.1.4.1 (2002-04) / EN 301 489-17 V.1.2.1 (2002-04)
- EN 50371:2002
- EN 60950:2000

## **UL CAUTION**

To reduce the risk of fire, use only No. 26 AWG or larger telecommunication line cord.

### ***IMPORTANT SAFETY INSTRUCTIONS***

When using your telephone equipment, basic safety precautions should always be followed to reduce the risk of fire, electric shock and injury to persons, including the following:

Do not use this product near water, for example, near a bathtub, wash bowl, kitchen sink or laundry tub, in a wet basement or near a swimming pool. Avoid using a telephone (other than a cordless type) during an electrical storm. There may be a remote risk of electric shock from lightning. Do not use the telephone to report a gas leak in the vicinity of the leak. Use only the power cord and batteries indicated in this manual. Do not dispose of batteries in a fire. They may explode. Check with local codes for possible special disposal instructions.

## **Canadian Department of Communications**

This class B digital apparatus meets all requirements of the Canadian Interference-causing Equipment Regulations.

---

## Appendix B — Statements

---

### *About the Modem*

The Industry Canada label identifies certified equipment. This certification means that the equipment meets certain telecommunications network protective, operational and safety requirements. The department does not guarantee the equipment will operate to the user's satisfaction.

Before installing this equipment, users should ensure that it is permissible to be connected to the facilities of the local telecommunications company. The equipment must also be installed using an acceptable method of connection. In some cases, the company's inside wiring associated with a single line individual service may be extended by means of a certified connector assembly (telephone extension cord). The customer should be aware that compliance with the above conditions may not prevent degradation of service in some situations.

Repairs to certified equipment should be made by an authorized Canadian maintenance facility designated by the supplier. Any repairs or alterations made by the user to this equipment, or equipment malfunctions, may give the telecommunications company cause to request the user to disconnect the equipment.

Users should ensure for their own protection that the electrical ground connections of the power utility, telephone lines and internal metallic water pipe system, if present, are connected together. This precaution may be particularly important in rural areas.

**CAUTION** Users should not attempt to make such connections themselves, but should contact the appropriate electric inspection authority, or electrician, as appropriate.

"The Load Number (LN) assigned to each terminal device denotes the percentage of the total load to be connected to a telephone loop which is used by the device. To prevent overloading, the termination on a loop may consist of any combination of device subject only to the requirement that the total of the Load Numbers of all the devices does not exceed 100."

---

## **Battery Disposal**

THIS PRODUCT CONTAINS A LITHIUM-ION OR NICKEL-METAL HYDRIDE BATTERY. IT MUST BE DISPOSED OF PROPERLY. CONTACT LOCAL ENVIRONMENTAL AGENCIES FOR INFORMATION ON RECYCLING AND DISPOSAL PLANS IN YOUR AREA.

## **CAUTION FOR ADAPTER**

**THIS NOTEBOOK COMPUTER IS FOR USE AN AVERATEC APPROVED AC ADAPTER ONLY.**

## **BATTERY CAUTION**

DANGER OF EXPLOSION IF BATTERY IS INCORRECTLY REPLACED. REPLACE ONLY WITH THE SAME OR EQUIVALENT TYPE RECOMMENDED BY THE MANUFACTURER. DISPOSE OF USED BATTERIES ACCORDING TO THE MANUFACTURER'S INSTRUCTIONS.

## **CLASS 1 LASER PRODUCT**

### **LASERSCHUTZKLASSE 1 PRODUKT TO EN60825**

**CAUTION:** THIS APPLIANCE CONTAINS A LASER SYSTEM AND IS CLASSIFIED AS A "CLASS 1 LASER PRODUCT." TO USE THIS MODEL PROPERLY, READ THE INSTRUCTION MANUAL CAREFULLY AND KEEP THIS MANUAL FOR FUTURE REFERENCE. IN CASE OF ANY TROUBLE WITH THIS MODEL, PLEASE CONTACT YOUR NEAREST "AUTHORIZED SERVICE STATION." TO PREVENT DIRECT EXPOSURE TO THE LASER BEAM, DO NOT TRY TO OPEN THIS ENCLOSURE.

---

## **1-YEAR LIMITED WARRANTY**

### **Applicable to new AVERATEC Notebooks**

The limited warranty set forth in this warranty card is provided by AVERATEC, Inc. with respect to the AVERATEC brand notebook computer. (Herein referred to as "Portable Computer") This warranty is valid for Averatec Portable Computers purchased and used in the United States and Canada. The Portable Computer purchased is the only AVERATEC brand computer to which this warranty card and the limited warranty stated herein apply.

When purchased in new condition, your Portable Computer is warranted against defects for one (1) year from the date of purchase, with the exception of the notebook battery. A six (6) month limited warranty is provided for the notebook battery. The warranty period cannot be extended or altered for time the product is returned for warranty repair.

A defective Portable Computer or a defective part returned to AVERATEC, proven defective through testing upon receipt, will be repaired or exchanged for comparable parts or a comparable Portable Computer and configured to the original specifications.

KEEP A COPY OF YOUR ORIGINAL STORE RECEIPT. Warranty service will only be provided upon proof of purchase.

This limited warranty shall only apply if the Portable Computer is used in conjunction with compatible peripheral equipment and compatible software. This limited warranty covers all defects encountered in normal use of the Portable Computer, and does not apply in the following cases:

- (1) Loss of or damage to, or inability to use, the Portable Computer in whole or in part due to abuse, mishandling, improper packaging by the consumer, alteration, accident, electrical current fluctuations, software bugs or viruses, failure to follow operating, maintenance or environmental instructions prescribed in AVERATEC'S user's manual, or service performed by other than AVERATEC.
- (2) Defects resulting from software, interfacing, parts or supplies not supplied by AVERATEC which cause damage to the Portable Computer or cause abnormally frequent service calls or service problems.
- (3) The Portable Computer has had its serial number or dating altered or removed.

**NO IMPLIED WARRANTY, INCLUDING ANY IMPLIED WARRANTY OF MERCHANTABILITY OR FITNESS FOR A PARTICULAR PURPOSE, APPLIES TO THE PORTABLE COMPUTER AFTER THE APPLICABLE PERIOD OF THE EXPRESS LIMITED WARRANTY STATED ABOVE. NO OTHER EXPRESS WARRANTY OR GUARANTY, EXCEPT AS MENTIONED ABOVE, GIVEN BY ANY PERSON OR ENTITY WITH RESPECT TO THE PORTABLE COMPUTER SHALL BIND AVERATEC. AVERATEC SHALL NOT BE LIABLE FOR LOSS OF REVENUES OR PROFITS, EXPENSES FOR SUBSTITUTE EQUIPMENT OR SERVICE, STORAGE CHARGES, LOSS OR MISUSE OF, OR INABILITY TO USE THE PORTABLE COMPUTER, REGARDLESS OF THE LEGAL THEORY ON WHICH THE CLAIM IS BASED, INCLUDING IF AVERATEC HAS BEEN ADVISED OF THE POSSIBILITY OF SUCH DAMAGES. AVERATEC IS NEITHER RESPONSIBLE NOR LIABLE IN ANY WAY FOR ANY PERSONAL DATA ON THE PERSONAL COMPUTER, OR FOR LOSS THEREOF, AND WILL NOT ASSIST IN BACKUP OR DATA RECOVERY. IN NO EVENT SHALL DATA RECOVERY OF ANY KIND AGAINST AVERATEC BE GREATER IN AMOUNT THAN THE PURCHASE PRICE OF THE PORTABLE COMPUTER SOLD BY AVERATEC AND CAUSING THE ALLEGED DAMAGE. WITHOUT LIMITING THE FOREGOING, CONSUMER ASSUMES ALL RISKS AND LIABILITY FOR LOSS, DAMAGE, OR INJURY TO ONESELF OR THEIR PROPERTY, OR TO OTHERS AND THEIR PROPERTY ARISING OUT OF THE USE OR MISUSE OF, OR INABILITY TO USE, THE PORTABLE COMPUTER. THIS LIMITED WARRANTY SHALL NOT EXTEND TO ANYONE OTHER THAN THE ORIGINAL PURCHASER OF THE PORTABLE COMPUTER, OR THE PERSON FOR WHOM IT WAS PURCHASED AS A GIFT, AND STATES EXCLUSIVE REMEDY.**

**This limited warranty gives you specific legal rights, and you may also have other rights, which vary, from state to state.**

**Additional Information Available at:**

**PHONE: (877) 462-3462**

**WEB: [www.averatec.com](http://www.averatec.com)**



## **SIX MONTH LIMITED WARRANTY Applicable to new AVERATEC Batteries**

The limited warranty set forth on this warranty card is provided by AVERATEC, Inc. with respect to the AVERATEC brand Battery that you have purchased, when purchased and used with a AVERATEC brand notebook computer. The Battery that you have purchased is the only AVERATEC brand product to which this warranty card and the limited warranty stated herein apply.

Your Battery, when purchased in a new condition, is warranted against defects for six (6) months from the date of purchase. The warranty period will not be extended or altered for any time for any time during which it is in for warranty repair.

A defective Battery returned to AVERATEC and proven to be defective upon inspection will be repaired or exchanged for a comparable part.

KEEP A COPY OF YOUR ORIGINAL STORE RECEIPT. Warranty service will only be provided upon proof of purchase provided to AVERATEC.

This limited warranty shall only apply if the Battery is used in conjunction with compatible peripheral equipment and compatible software. This limited warranty covers all defects encountered in normal use of the Accessory, and does not apply in the following cases:

- (1) Loss of or damage to, or inability to use, the Battery in whole or in part due to abuse, mishandling, improper packaging by you, alteration, accident, electrical current fluctuations, software bugs or viruses, failure to follow operating, maintenance or environmental instructions prescribed in AVERATEC'S user's manual, or service performed by other than AVERATEC.
- (2) Defects resulting from software, interfacing, parts or supplies not supplied by AVERATEC which cause damage to the Battery or cause abnormally frequent service calls or service problems.
- (3) If the Battery has had its serial number or dating altered or removed.

**NO IMPLIED WARRANTY, INCLUDING ANY IMPLIED WARRANTY OF MERCHANTABILITY OR FITNESS FOR A PARTICULAR PURPOSE, APPLIES TO THE BATTERY AFTER THE APPLICABLE PERIOD OF THE EXPRESS LIMITED WARRANTY STATED ABOVE, AND NO OTHER EXPRESS WARRANTY OR GUARANTY, EXCEPT AS MENTIONED ABOVE, GIVEN BY ANY PERSON OR ENTITY WITH RESPECT TO THE BATTERY SHALL BIND AVERATEC. AVERATEC SHALL NOT BE LIABLE FOR LOSS OF REVENUES OR PROFITS, EXPENSES FOR SUBSTITUTE EQUIPMENT OR SERVICE, STORAGE CHARGES, LOSS OR MISUSE OF, OR INABILITY TO USE, THE BATTERY, REGARDLESS OF THE LEGAL THEORY ON WHICH THE CLAIM IS BASED, AND EVEN IF AVERATEC HAS BEEN ADVISED OF THE POSSIBILITY OF SUCH DAMAGES. IN NO EVENT SHALL RECOVERY OF ANY KIND AGAINST AVERATEC BE GREATER IN AMOUNT THAN THE PURCHASE PRICE OF THE BATTERY SOLD BY AVERATEC AND CAUSING THE ALLEGED DAMAGE. WITHOUT LIMITING THE FOREGOING, YOU ASSUME ALL RISK AND LIABILITY FOR LOSS, DAMAGE, OR INJURY TO YOU AND YOUR PROPERTY AND TO OTHERS AND THEIR PROPERTY ARISING OUT OF USE OR MISUSE OF, OR INABILITY TO USE, THE BATTERY NOT CAUSED DIRECTLY BY THE NEGLIGENCE OF AVERATEC. THIS LIMITED WARRANTY SHALL NOT EXTEND TO ANYONE OTHER THAN THE ORIGINAL PURCHASER OF THE BATTERY, OR THE PERSON FOR WHOM IT WAS PURCHASED AS A GIFT, AND STATES YOUR EXCLUSIVE REMEDY.**

This limited warranty gives you specific legal rights, and you may also have other rights, which vary, from state to state.

**Additional Information Available at:  
PHONE: (877) 462-3462  
WEB: [www.averatec.com](http://www.averatec.com)**

## **1-YEAR LIMITED WARRANTY**

### **Applicable to new AVERATEC Accessories**

The limited warranty set forth on this warranty card is provided by AVERATEC, Inc. with respect to the AVERATEC brand Accessory that you have purchased, when purchased and used with a AVERATEC brand notebook computer. The accessory that you have purchased is the only AVERATEC brand product to which this warranty card and the limited warranty stated herein apply.

Your Accessory, when purchased in a new condition, is warranted against defects for one (1) year from the date of purchase. The warranty period will not be extended or altered for any time for any time during which it is in for warranty repair.

A defective Accessory returned to AVERATEC and proven to be defective upon inspection will be repaired or exchanged for comparable part.

KEEP A COPY OF YOUR ORIGINAL STORE RECEIPT. Warranty service will only be provided upon proof of purchase provided to AVERATEC.

This limited warranty shall only apply if the Accessory is used in conjunction with compatible peripheral equipment and compatible software. This limited warranty covers all defects encountered in normal use of the Accessory, and does not apply in the following cases:

- (1) Loss of or damage to, or inability to use, the Accessory in whole or in part due to abuse, mishandling, improper packaging by you, alteration, accident, electrical current fluctuations, software bugs or viruses, failure to follow operating, maintenance or environmental instructions prescribed in AVERATEC'S user's manual, or service performed by other than AVERATEC.
- (2) Defects resulting from software, interfacing, parts or supplies not supplied by AVERATEC which cause damage to the Accessory or cause abnormally frequent service calls or service problems.
- (3) If the Accessory has had its serial number or dating altered or removed.

**NO IMPLIED WARRANTY, INCLUDING ANY IMPLIED WARRANTY OF MERCHANTABILITY OR FITNESS FOR A PARTICULAR PURPOSE, APPLIES TO THE ACCESSORY AFTER THE APPLICABLE PERIOD OF THE EXPRESS LIMITED WARRANTY STATED ABOVE, AND NO OTHER EXPRESS WARRANTY OR GUARANTY, EXCEPT AS MENTIONED ABOVE, GIVEN BY ANY PERSON OR ENTITY WITH RESPECT TO THE ACCESSORY SHALL BIND AVERATEC. AVERATEC SHALL NOT BE LIABLE FOR LOSS OF REVENUES OR PROFITS, EXPENSES FOR SUBSTITUTE EQUIPMENT OR SERVICE, STORAGE CHARGES, LOSS OR MISUSE OF, OR INABILITY TO USE, THE ACCESSORY, REGARDLESS OF THE LEGAL THEORY ON WHICH THE CLAIM IS BASED, AND EVEN IF AVERATEC HAS BEEN ADVISED OF THE POSSIBILITY OF SUCH DAMAGES. IN NO EVENT SHALL RECOVERY OF ANY KIND AGAINST AVERATEC BE GREATER IN AMOUNT THAN THE PURCHASE PRICE OF THE ACCESSORY SOLD BY AVERATEC AND CAUSING THE ALLEGED DAMAGE. WITHOUT LIMITING THE FOREGOING, YOU ASSUME ALL RISK AND LIABILITY FOR LOSS, DAMAGE, OR INJURY TO YOU AND YOUR PROPERTY AND TO OTHERS AND THEIR PROPERTY ARISING OUT OF USE OR MISUSE OF, OR INABILITY TO USE, THE ACCESSORY NOT CAUSED DIRECTLY BY THE NEGLIGENCE OF AVERATEC. THIS LIMITED WARRANTY SHALL NOT EXTEND TO ANYONE OTHER THAN THE ORIGINAL PURCHASER OF THE ACCESSORY, OR THE PERSON FOR WHOM IT WAS PURCHASED AS A GIFT, AND STATES YOUR EXCLUSIVE REMEDY.**

This limited warranty gives you specific legal rights, and you may also have other rights, which vary, from state to state.

**Additional Information Available at:**

**PHONE:** (877) 462-3462

**WEB:** [www.averatec.com](http://www.averatec.com)