



**Well Green Technology Co., Ltd**

**No. 20, Alley51 ,Lane 118,ShuangLian Sec.2,Mintzu Rd.,  
PingJen City, TaoYuan Hsien, Taiwan, R.O.C  
TEL: (03)420-6428 FAX: (03) 420-6418**

# **TWINHEAD E12B For EPR Antenna Test Report**

<b>RD Manager</b>	<b>Supervisor</b>	<b>RD engineer</b>	<b>Sales engineer</b>
<b>David</b>	<b>Johnson</b>	<b>Tim</b>	<b>Jerry</b>



Antenna Testing Conditions:

1. Testing set up:

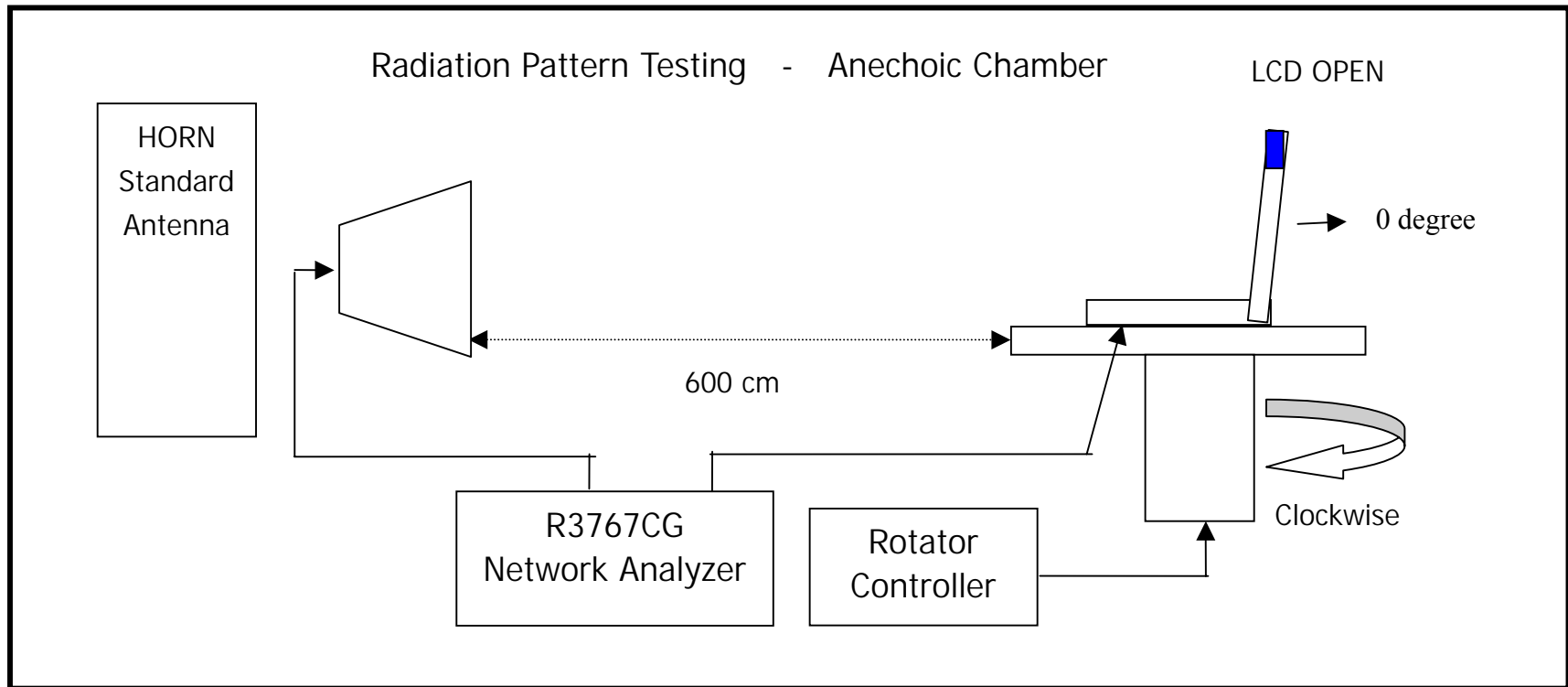



2. Mechanical dimensions

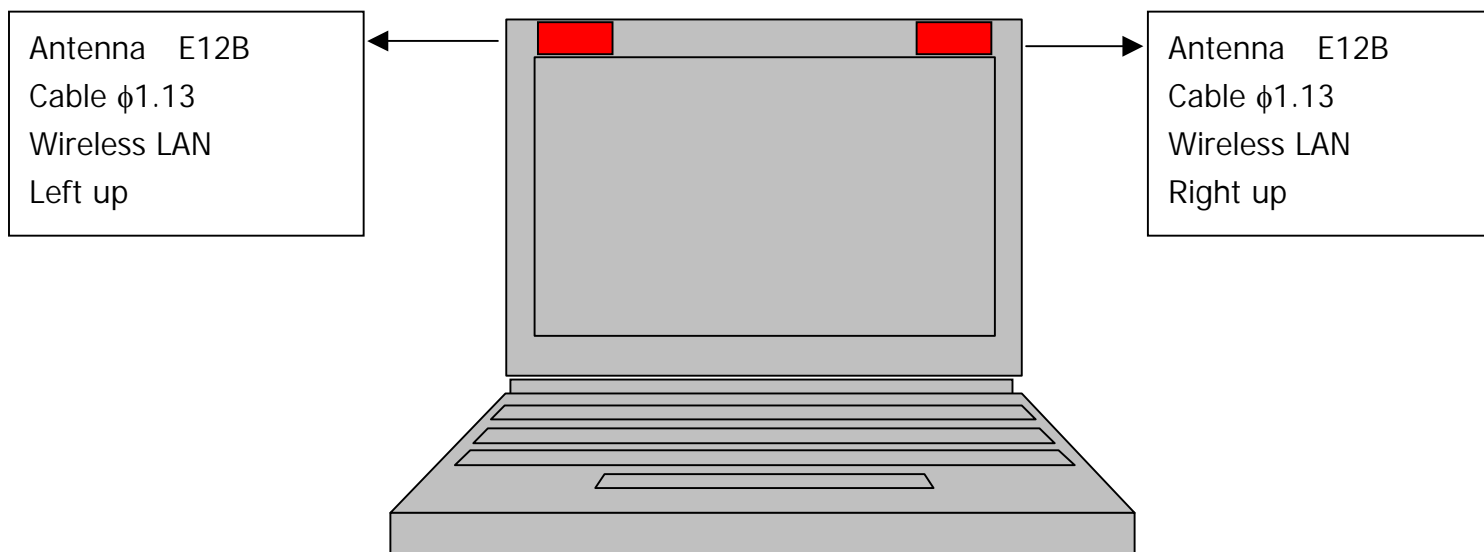



Test results-Left

Antenna	Application	Cable dia. Φ mm
<b>E12B</b>	<b>Wireless</b>	<b>1.13</b>

1.VSWR

Antenna	Center freg. @MHz	BW @MHz	VSWR		
			2.4GHz	2.45GHz	2.5GHz
E12B	2450		1.31	1.51	1.19





## 2. Return Loss

Antenna	Center freg. @MHz	BW @MHz	Return Loss		
			2.4GHz	2.45GHz	2.5GHz
E12B	2450		-17.30	-13.91	-20.80

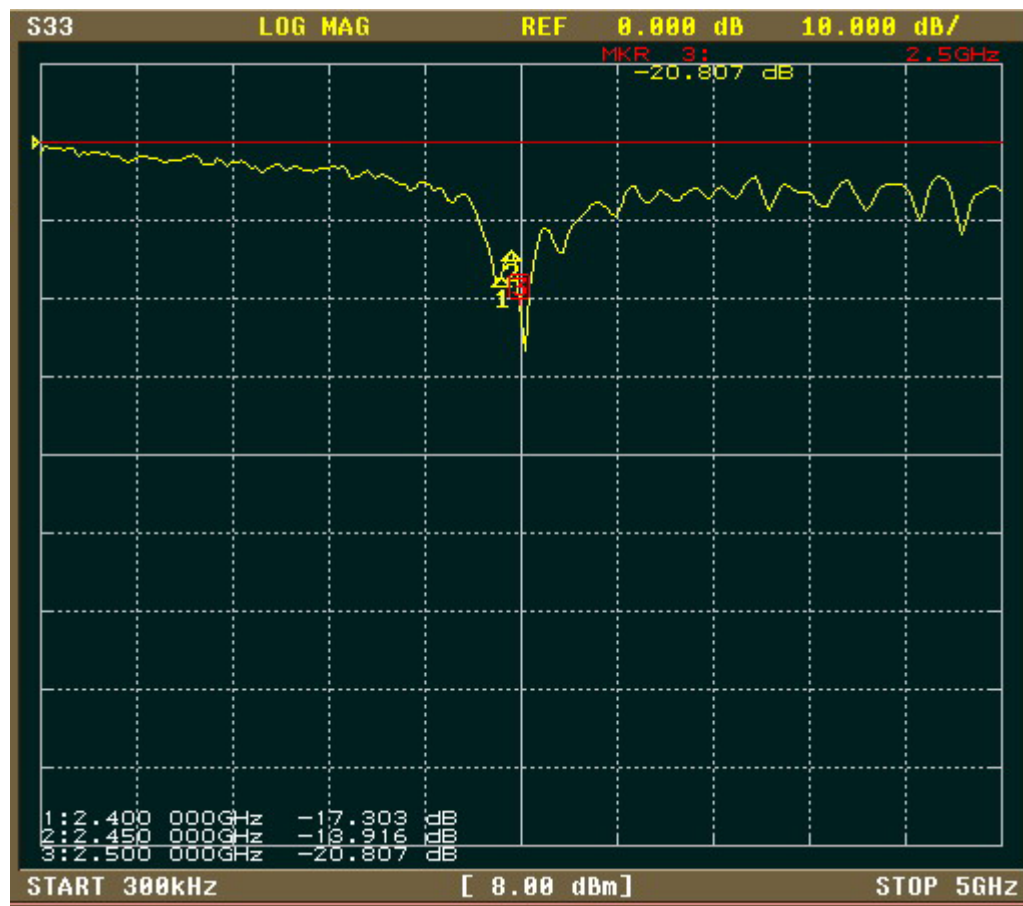



Well Green Technology Co., Ltd

No. 20, Alley51 ,Lane 118,ShuangLian Sec.2,Mintzu Rd.,  
PingJen City, TaoYuan Hsien, Taiwan, R.O.C  
TEL: (03)420-6428 FAX: (03) 420-6418

### 3. Smith Chart

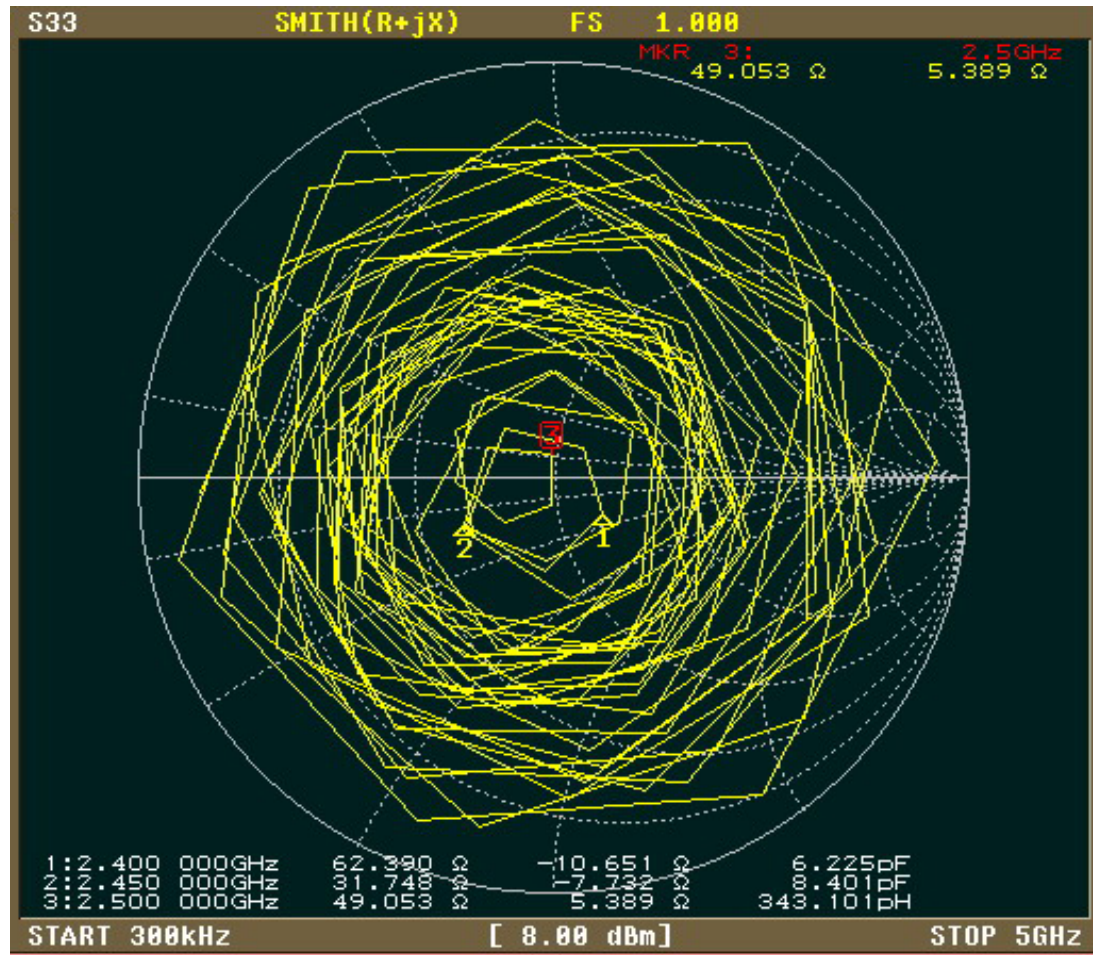



4. Radiation Pattern of XY Plane(Azimuth)-2.45GHz

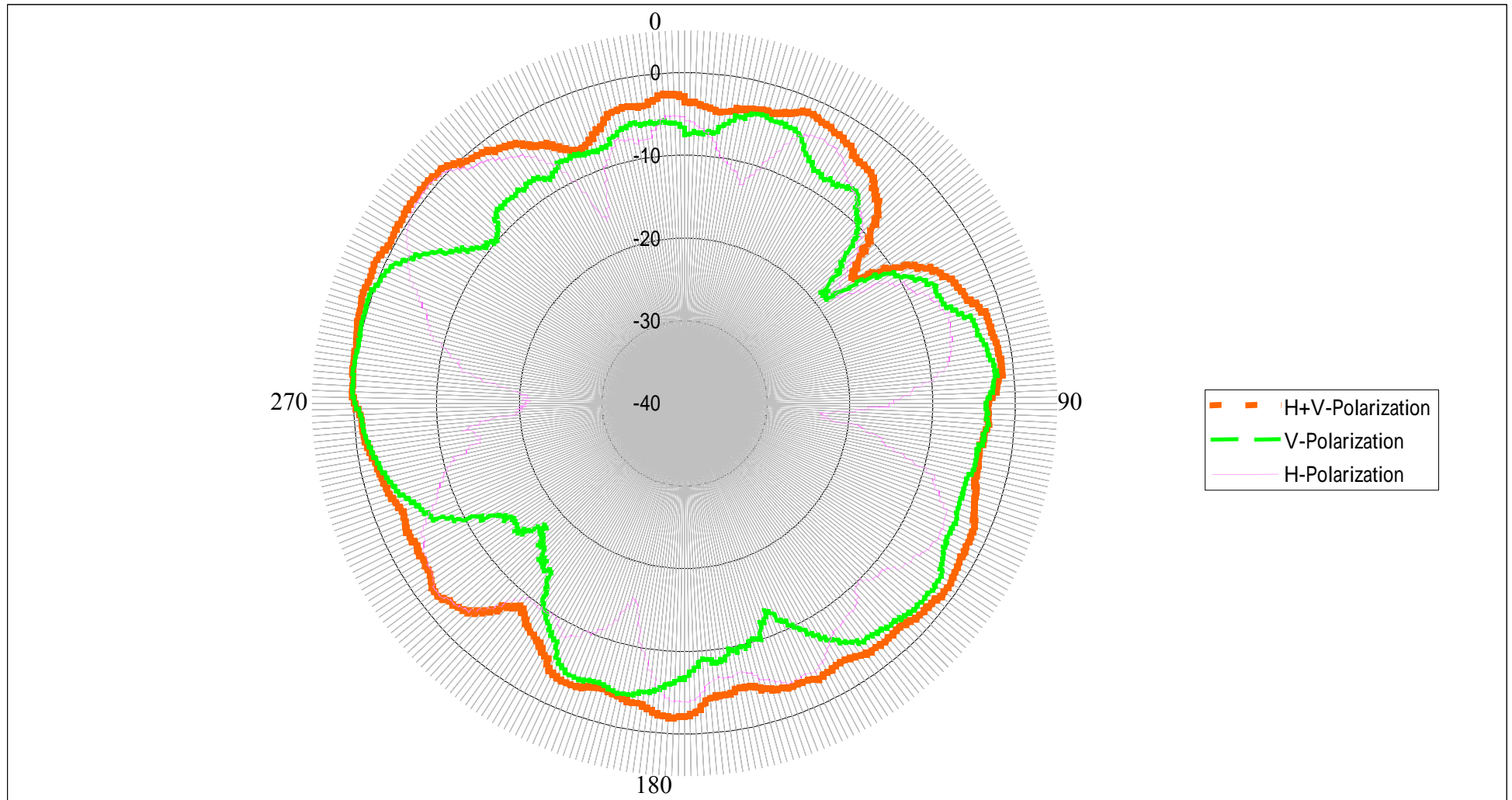



**Well Green Technology Co., Ltd**

**No. 20, Alley51 ,Lane 118,ShuangLian Sec.2,Mintzu Rd.,  
PingJen City, TaoYuan Hsien, Taiwan, R.O.C  
TEL: (03)420-6428 FAX: (03) 420-6418**

### 5. Peak Gain and Average Gain

Antenna	Gain of XY Plane(Azimuth)		
	Polariztion	2.45GHz-L	
E12B	V	Peak	0.33
		Average	-4.89
	H	Peak	0.66
		Average	-6.22
	H+V	Peak	1.12
		Average	-2.49





### Test results-Right

Antenna	Application	Cable dia. Φ mm
<b>E12B</b>	<b>Wireless</b>	<b>1.13</b>

### 1. VSWR

Antenna	Center freg. @MHz	BW @MHz	VSWR		
			2.4GHz	2.45GHz	2.5GHz
E12B	2450		1.22	1.39	1.16

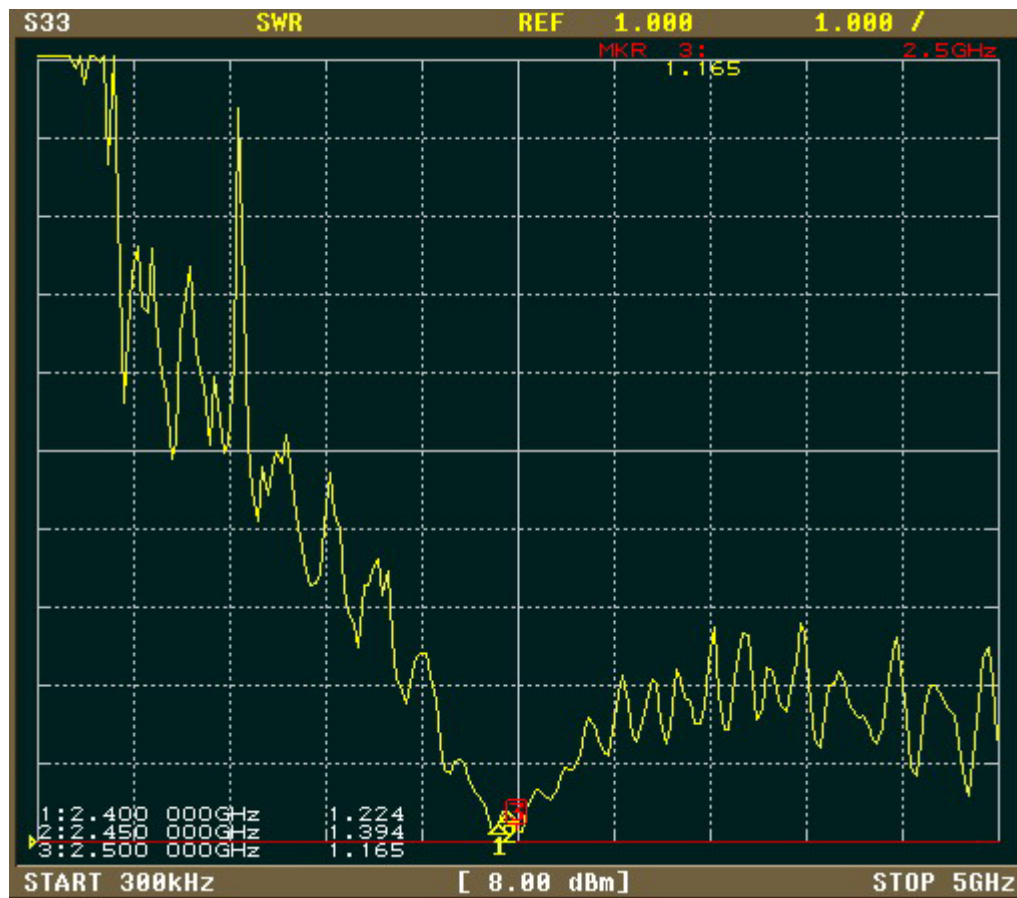



2. Return Loss

Antenna	Center freg. @MHz	BW @MHz	Return Loss		
			2.4GHz	2.45GHz	2.5GHz
E12B	2450		-20.02	-15.63	-22.57

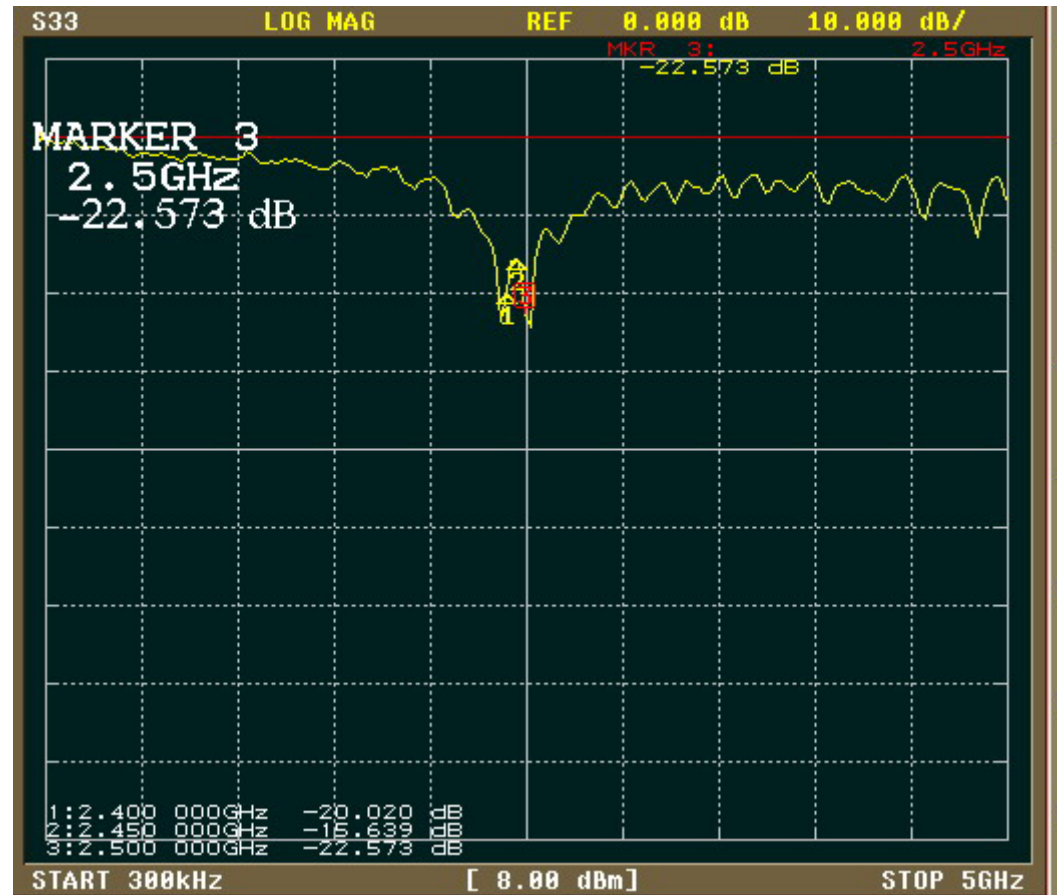



Well Green Technology Co., Ltd

No. 20, Alley51 ,Lane 118,ShuangLian Sec.2,Mintzu Rd.,  
PingJen City, TaoYuan Hsien, Taiwan, R.O.C  
TEL: (03)420-6428 FAX: (03) 420-6418

### 3. Smith Chart

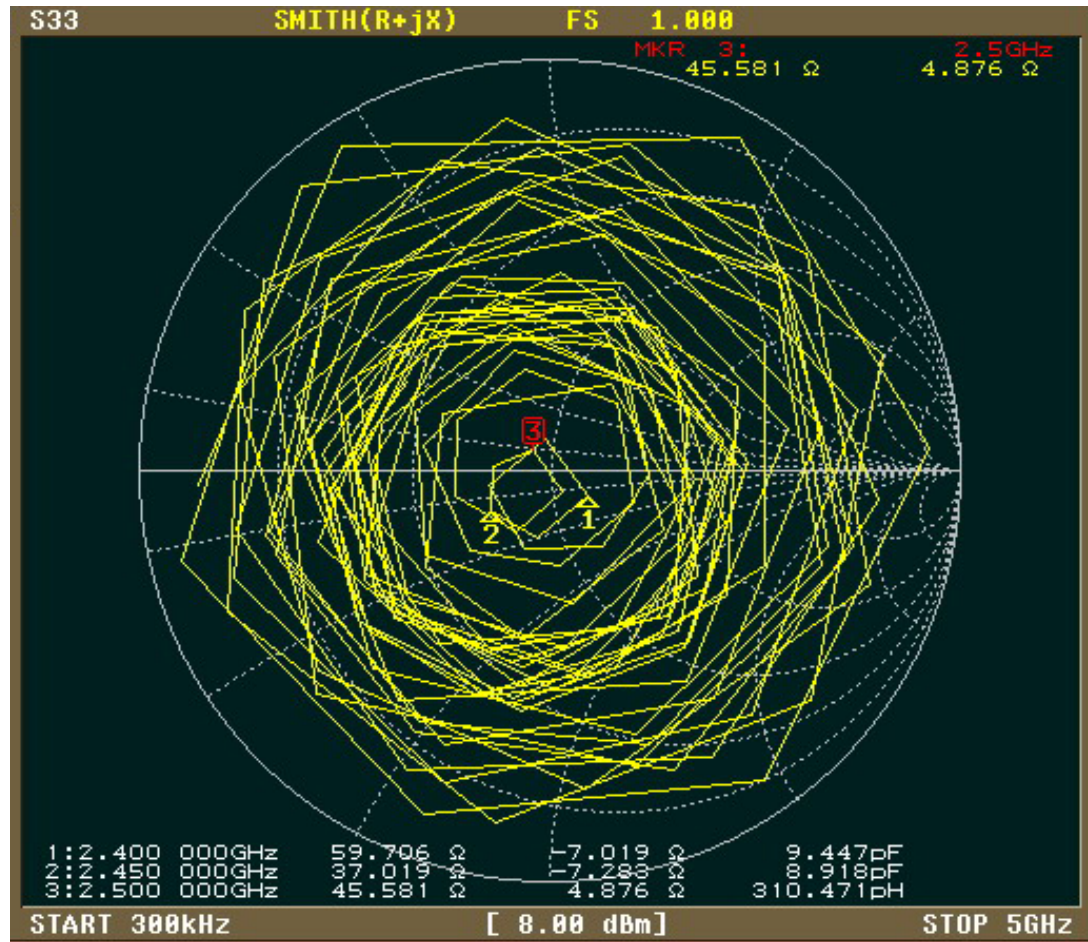



Well Green Technology Co., Ltd

No. 20, Alley51 ,Lane 118,ShuangLian Sec.2,Mintzu Rd.,  
PingJen City, TaoYuan Hsien, Taiwan, R.O.C  
TEL: (03)420-6428 FAX: (03) 420-6418

#### 4. Radiation Pattern of XY Plane (Azimuth)-2.45GHz

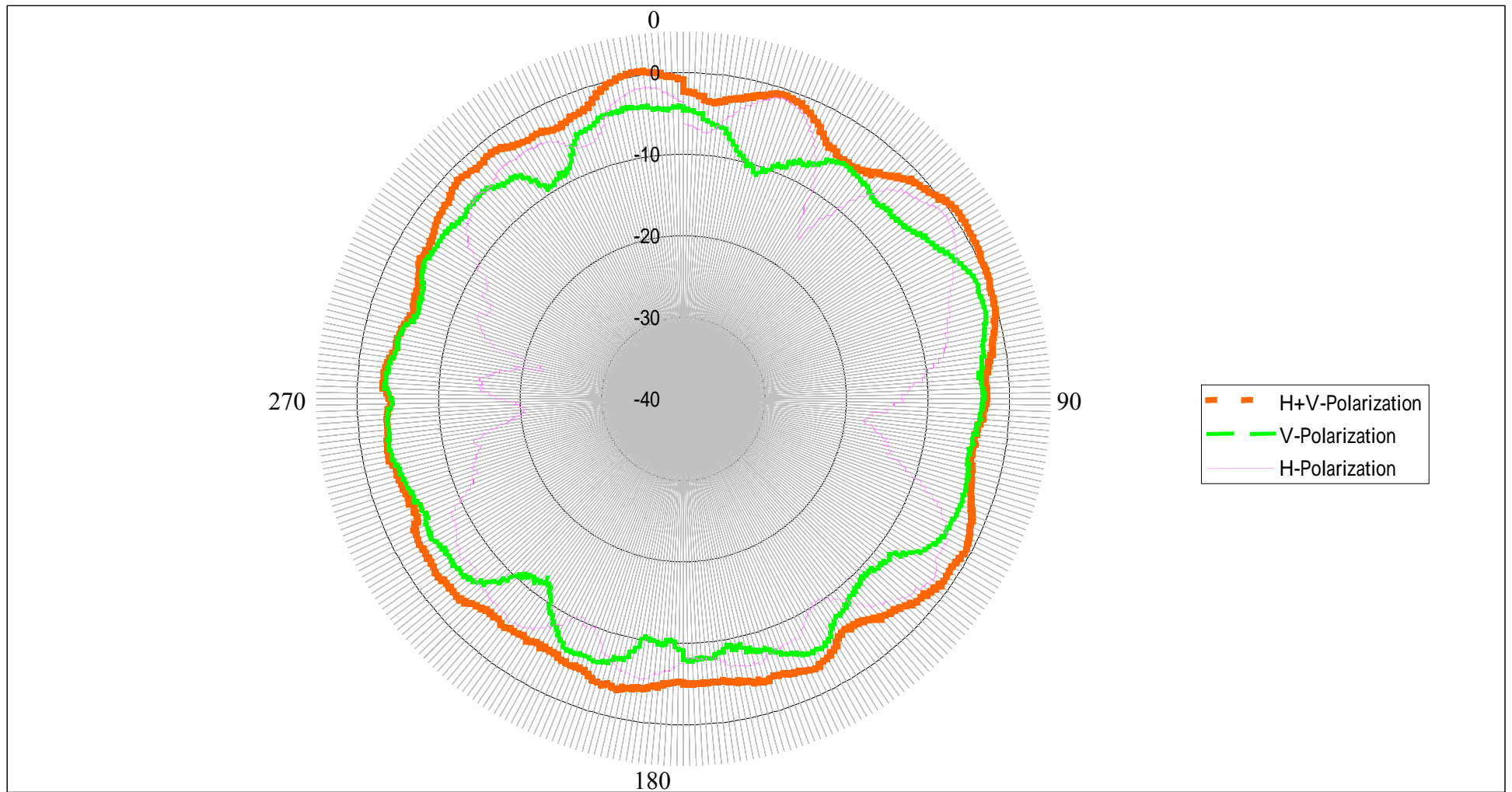



5. Peak Gain and Average Gain

Antenna	Gain of XY Plane (Azimuth)		
	Polariztion	2.45GHz-R	
E12B	V	Peak	-1.28
		Average	-5.26
	H	Peak	-0.75
		Average	-6.00
	H+V	Peak	0.79
		Average	-2.60