



**Nemko Test Report:** 5L0114RUS3

**Applicant:** Motion Computing Corporation  
8601 RR 2222 Bldg. 2  
Austin, TX 78730

**Equipment Under Test:  
(E.U.T.)** LS800 TS01 w/ Atheros card

**In Accordance With:** **FCC Part 15, Subpart C, 15.247**  
Digital Transmission System Transmitter

**Tested By:** Nemko Dallas Inc.  
802 N. Kealy  
Lewisville, Texas 75057-3136

**Authorized By:**   
Tom Tidwell, Frontline Group Manager

**Date:** 25 June, 2005

## Table of Contents

Section 1.	Summary of Test Results .....	3
Section 2.	Equipment Under Test (E.U.T.) .....	5
Section 3.	Powerline Conducted Emissions .....	7
Section 4.	Occupied Bandwidth .....	10
Section 5.	Maximum Peak Output Power .....	20
Section 6.	Radiated Emissions .....	21
Section 7.	Peak Power Spectral Density .....	24
Section 8	Spurious Emissions at Antenna Terminals .....	34
Section 9	Test Equipment.....	48
ANNEX A - TEST DETAILS .....		49
ANNEX B - TEST DIAGRAMS.....		60

EQUIPMENT: LS800 TS01 w/ Atheros card TEST REPORT NO.: 5L0114RUS3

**Section 1. Summary of Test Results**

Manufacturer: Motion Computing

Model No.: TS01 w/ Atheros card

Name: LS800

Serial No.: Proto 11

General: **All measurements are traceable to national standards.**

These tests were conducted on a sample of the equipment for the purpose of demonstrating compliance with Part 15, Subpart C, Paragraph 15.247 for Direct Sequence Spread Spectrum devices. Radiated tests were conducted in accordance with ANSI C63.4-2003. Radiated emissions are made on an open area test site. A description of the test facility is on file with the FCC.

- New Submission
- Production Unit
- Class II Permissive Change
- Pre-Production Unit

THIS TEST REPORT RELATES ONLY TO THE ITEM(S) TESTED.

THE FOLLOWING DEVIATIONS FROM, ADDITIONS TO, OR EXCLUSIONS FROM THE TEST SPECIFICATIONS HAVE BEEN MADE.

See " Summary of Test Data".



**NVLAP LAB CODE: 100426-0**

Nemko Dallas Inc. authorizes the above named company to reproduce this report provided it is reproduced in its entirety and for use by the company's employees only.

Any use which a third party makes of this report, or any reliance on or decisions to be made based on it, are the responsibility of such third parties. Nemko Dallas Inc. accepts no responsibility for damages, if any, suffered by any third party as a result of decisions made or actions based on this report. This report applies only to the items tested.

*EQUIPMENT:* LS800 TS01 w/ Atheros card

TEST REPORT NO.: 5L0114RUS3

---

**Summary Of Test Data**

<b>NAME OF TEST</b>	<b>PARA. NO.</b>	<b>RESULT</b>
Powerline Conducted Emissions	15.207(a)	Complies
Minimum 6 dB Bandwidth	15.247(a)(2)	Complies
Maximum Peak Power Output	15.247(b)(1)	Complies
Spurious Emissions (Antenna Conducted)	15.247(c)	Complies
Spurious Emissions (Restricted Bands)	15.247(c)	Complies
Peak Power Spectral Density	15.247(d)	Complies

**Footnotes:**



**Description of EUT**

Tablet PC with Atheros Gemtek 802.11 a/b/g radio.

**System Diagram**

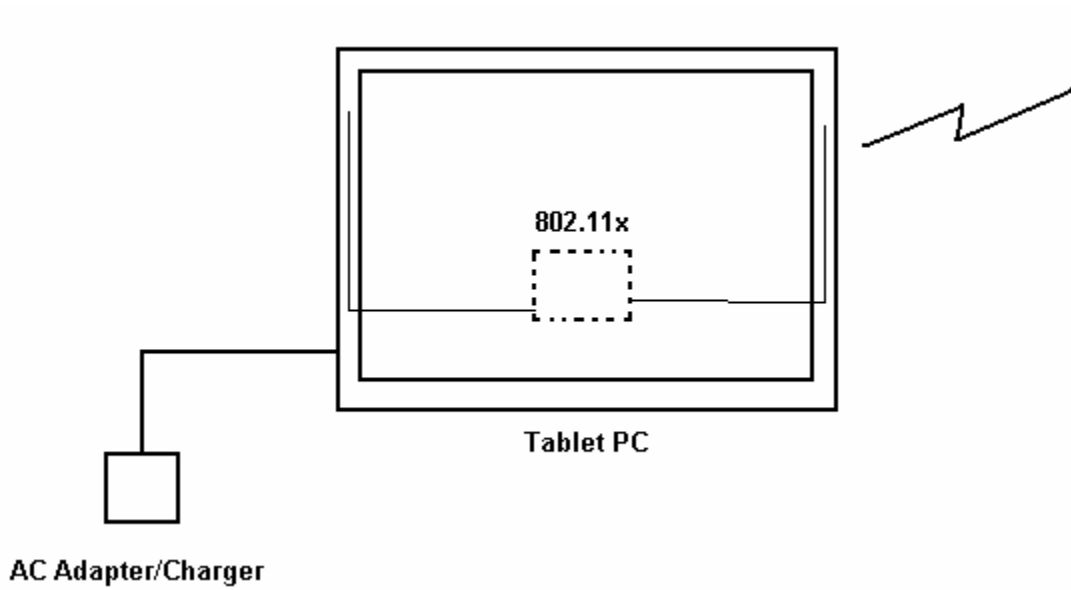

EQUIPMENT: LS800 TS01 w/ Atheros card TEST REPORT NO.: 5L0114RUS3

**Section 3. Powerline Conducted Emissions**

NAME OF TEST: Powerline Conducted Emissions	PARA. NO.: 15.207(a)
TESTED BY: Brian Boyea	DATE: 4/26/05

**Test Results:** Complies.

**Measurement Data:** See attached plots.

**Measurement Uncertainty:** +/- 1.7 dB

The worst case PEAK emission was 51 dBµV at 150 kHz on the neutral line. This is 5 dB below the AVERAGE spec limit of 56 dBµV.

Asset Number	Description	Manufacturer	Model Number	Serial Number	Last Cal	Cal Due
969	lisc	Schwarzbeck	8120	8120281	09/17/04	09/17/05
1547	CABLE .6m	KTL	RG223	N/A	06/09/04	06/09/05
1115	CABLE, 4.5m	KTL	RG223	N/A	03/08/05	03/08/06
718	HP Spectrum Analyzer	HP	8591EM	3639A00980	04/06/05	04/06/06
966	Receiver	R&S	ESH2	880370/029	09/20/04	09/20/05
1193	LIMITER	FISCHER	FCC-450B-1.25N	956	CBU	CBU
1555	Filter high pass 5KHz	Solar Electronics	7930-5.0	933125	04/20/04	04/20/05

CBU: Calibrate Before Use

### Test Data – Powerline Conducted Emissions

Neutral

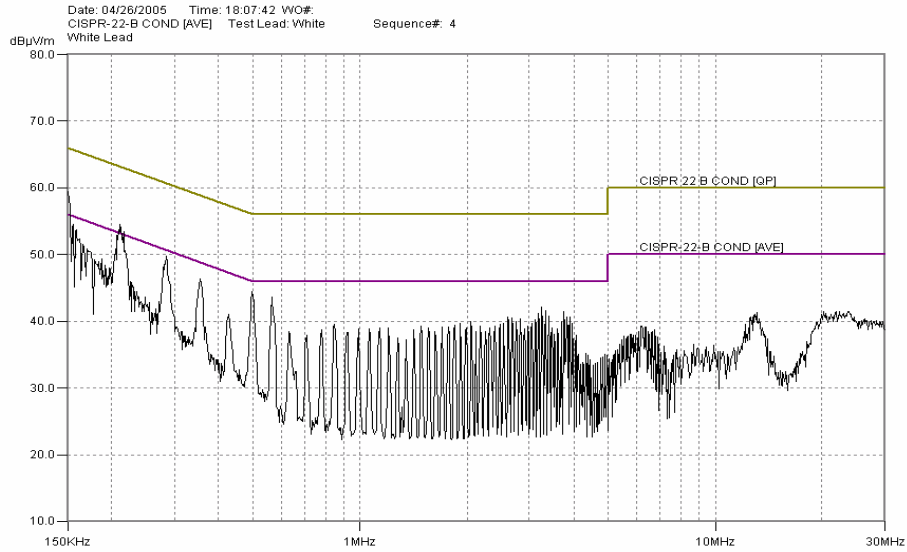

Hot

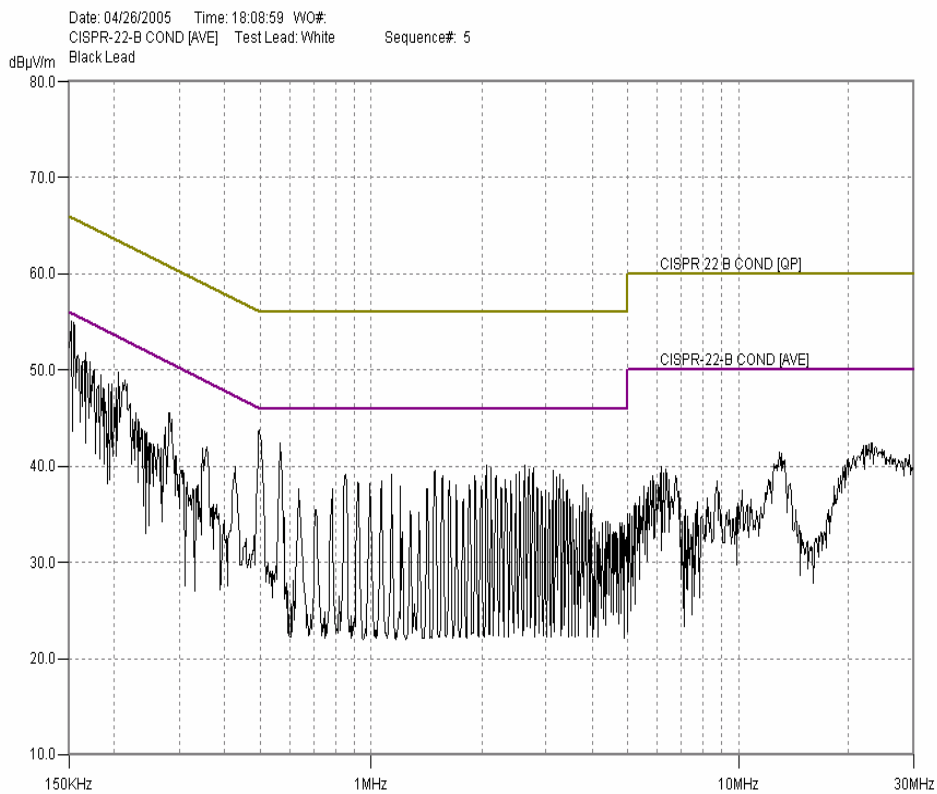



**Photos – Powerline Conducted Emissions**

Front



Side



EQUIPMENT: LS800 TS01 w/ Atheros card TEST REPORT NO.: 5L0114RUS3

**Section 4. Occupied Bandwidth**

NAME OF TEST: Occupied Bandwidth	PARA. NO.: 15.247(a)(2)
TESTED BY: David Light	DATE: 4/26/05

**Test Results:** Complies.

**Measurement Data:** See 6 dB BW plot

Measured 6 dB bandwidth: 16.5 MHz 802.11 a/g  
 9.5 MHz 802.11b  
 Channel Separation: 5 MHz

Asset Number	Description	Manufacturer	Model Number	Serial Number	Last Cal	Cal Due
1484	Cable	Storm	PR90-010-072	N/A	08/26/04	08/26/05
1485	Cable	Storm	PR90-010-216	N/A	08/02/04	08/02/05
1482	Band Pass Filter	K & L	11SH10-4000/T12000-0/0	2	CBU	N/A
1036	Spectrum analyzer	R&S	FSEK30	830844/006	03/22/04	03/23/06
1304	Horn antenna	Electro Metrics	RGA-60	6151	09/22/03	09/22/05







EQUIPMENT: LS800 TS01 w/ Atheros card

TEST REPORT NO.: 5L0114RUS3

**Test Data – Occupied Bandwidth**

<u>Data Plot</u>		<u>Occupied Bandwidth</u>		Complete <u>X</u>
Page 1 of 3		Date: <u>5/10/2005</u>	Preliminary: _____	
Job No.: <u>5L0114</u>	Specification: <u>15.247</u>	Temperature(°C): <u>20</u>		
Tested By: <u>David Light</u>	Relative Humidity(%): <u>30</u>			
E.U.T.: <u>Tablet PC w/802.11 abg</u>	Configuration: <u>Upright in stand - Tx in b mode - 11 Mbps - Set at default power level using Atheros</u>			
Sample Number: <u>1</u>				
Location: <u>AC 3</u>	RBW: <u>100 kHz</u>			
Detector Type: <u>Peak</u>	VBW: <u>100 kHz</u>			
<b><u>Test Equipment Used</u></b>				
Antenna: _____	Directional Coupler: _____			
Pre-Amp: _____	Cable #1: <u>1973</u>			
Filter: _____	Cable #2: _____			
Receiver: <u>1659</u>	Cable #3: _____			
Attenuator #1: <u>1472</u>	Cable #4: _____			
Attenuator #2: _____	Mixer: _____			
Additional equipment used: _____				
Measurement Uncertainty: <u>+/-1.7 dB</u>				

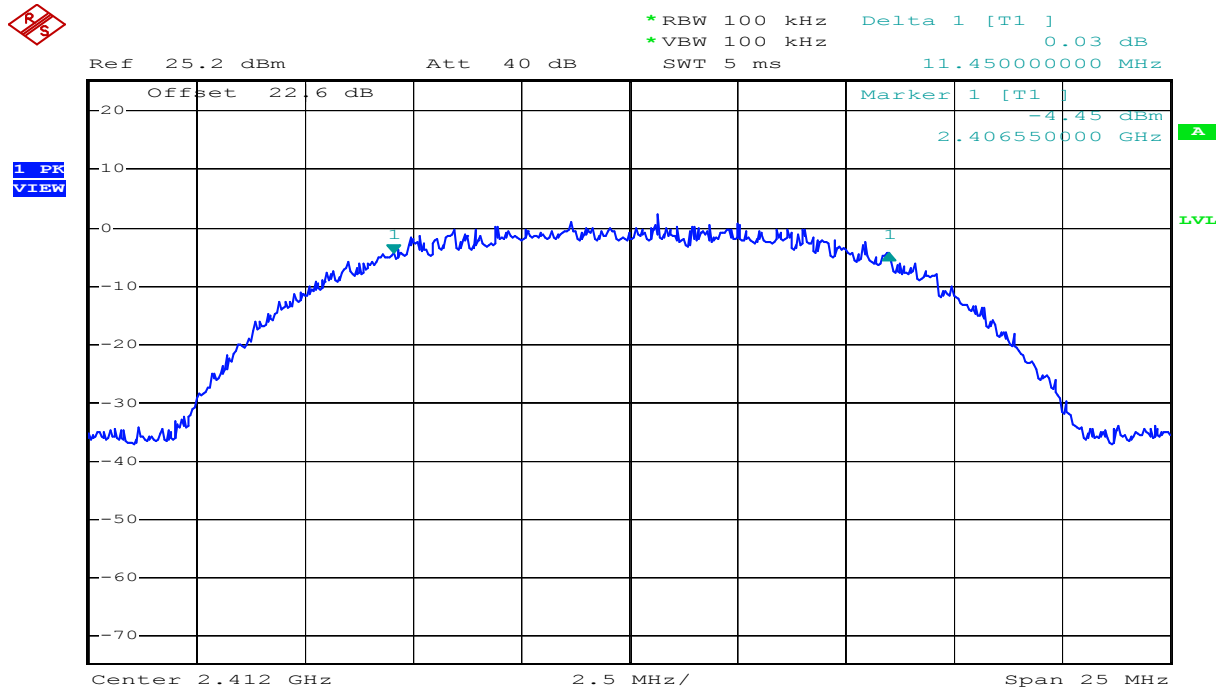

Date: 10.MAY.2005 17:07:59

Notes: Lowest Channel

---



---



---

Test Data – Occupied Bandwidth

<b>Data Plot</b>	<b>Occupied Bandwidth</b>
Page 2 of 3	
Job No.: 5L0114	Date: 5/10/2005
Specification: 15.2	Temperature(°C): 20
Tested By: David Light	Relative Humidity(%) 30
E.U.T.: Tablet PC w/802.11 abg	
Configuration: Upright in stand - Tx in b mode - 11 Mbps - Set at default power level using Atheros	

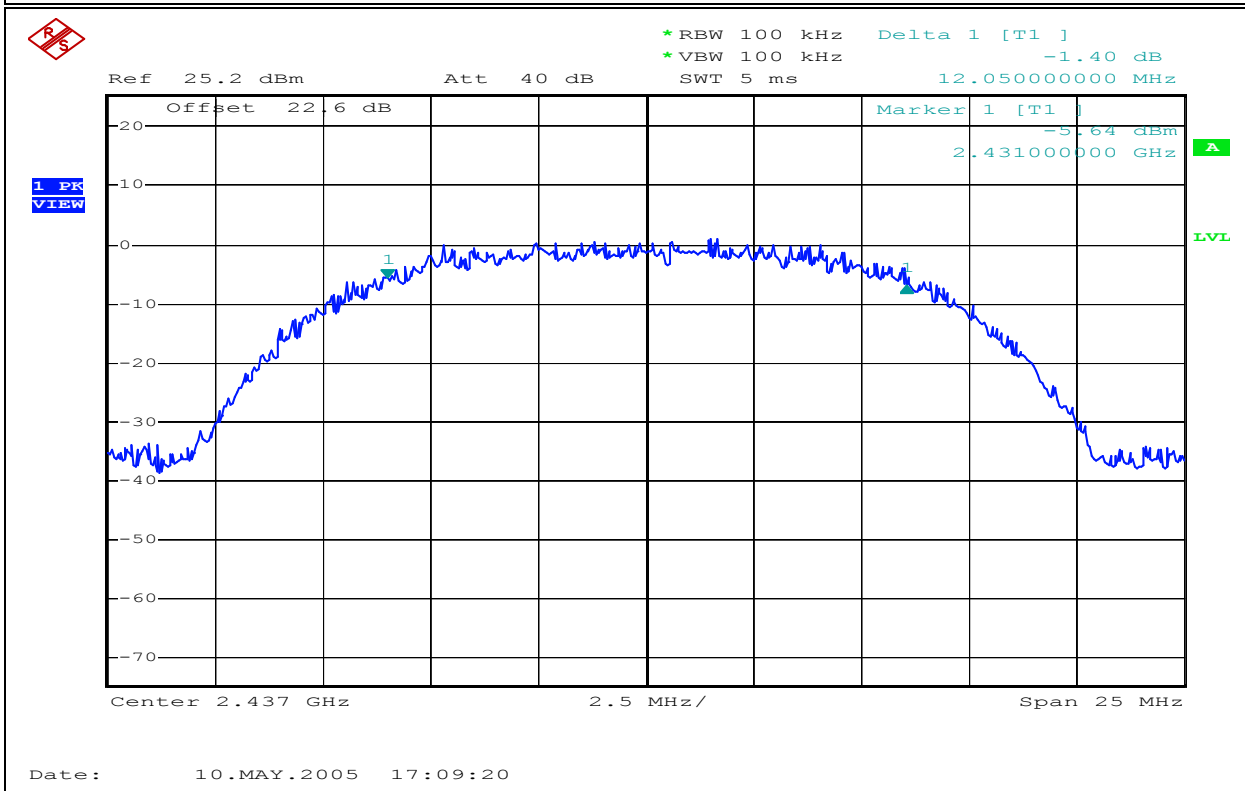

Notes: <u>Mid Channel</u>

Test Data – Occupied Bandwidth

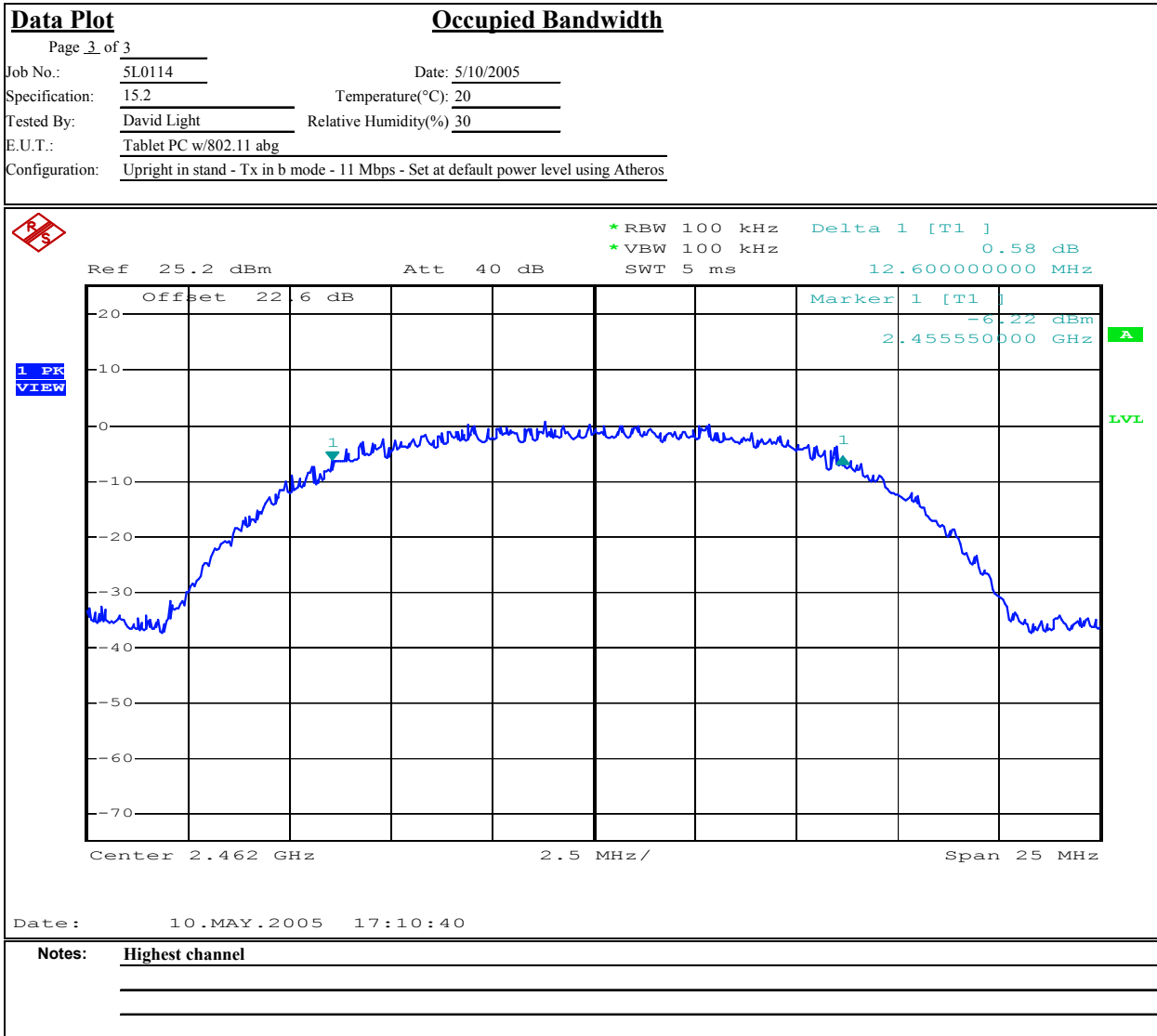



EQUIPMENT: LS800 TS01 w/ Atheros card

TEST REPORT NO.: 5L0114RUS3

**Test Data – Occupied Bandwidth**

<u>Data Plot</u>		<u>Occupied Bandwidth</u>		Complete <u>X</u>
Page 1 of 3				Preliminary: _____
Job No.: 5L0114		Date: 5/10/2005		
Specification: 15.247		Temperature(°C): 20		
Tested By: David Light		Relative Humidity(%): 30		
E.U.T.: Tablet PC w/802.11 abg				
Configuration: Upright in stand - Tx in g mode - 54 Mbps - Set at default power level using Atheros test tility				
Sample Number: 1				
Location: AC 3		RBW: 100 kHz		
Detector Type: Peak		VBW: 100 kHz		
<b><u>Test Equipment Used</u></b>				
Antenna: _____		Directional Coupler: _____		
Pre-Amp: _____		Cable #1: 1973		
Filter: _____		Cable #2: _____		
Receiver: 1659		Cable #3: _____		
Attenuator #1: 1472		Cable #4: _____		
Attenuator #2: _____		Mixer: _____		
Additional equipment used: _____				
Measurement Uncertainty: +/-1.7 dB				

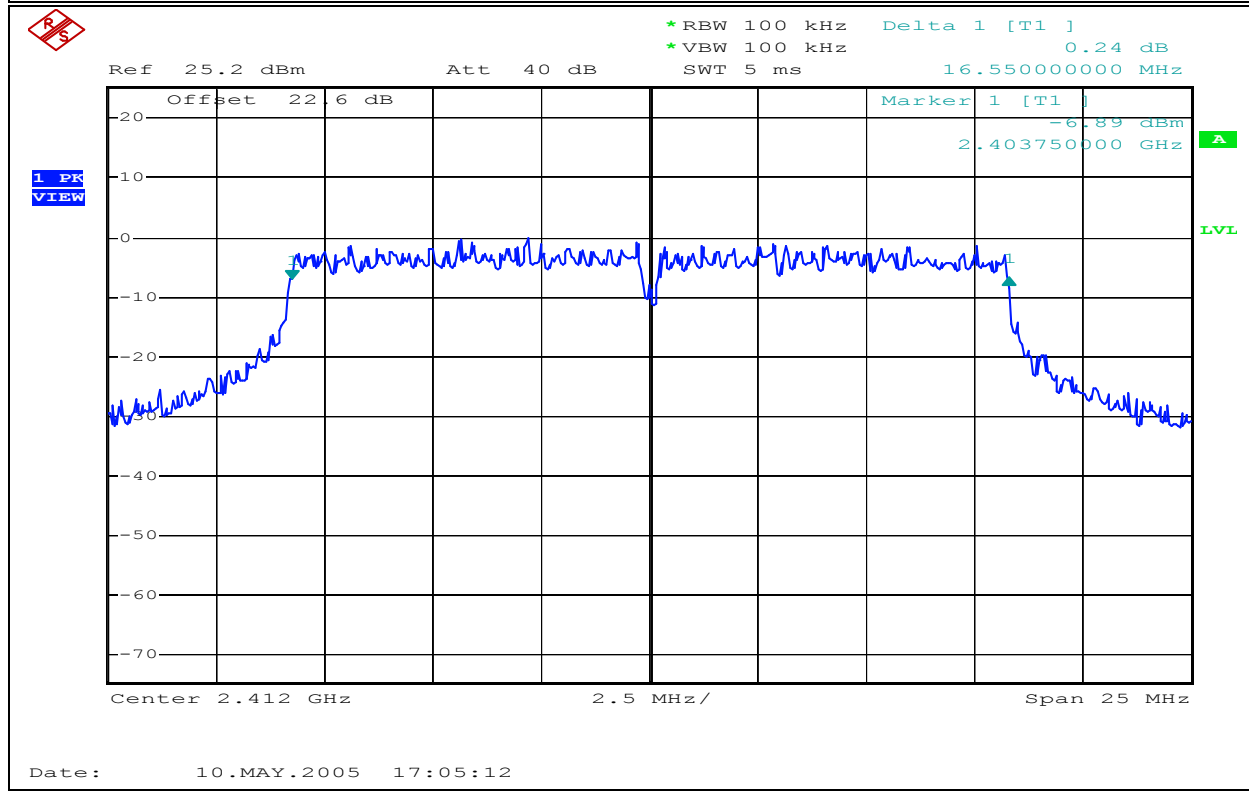

**Notes:** Lowest Channel

\_\_\_\_\_

\_\_\_\_\_

EQUIPMENT: LS800 TS01 w/ Atheros card

TEST REPORT NO.: 5L0114RUS3

Test Data – Occupied Bandwidth

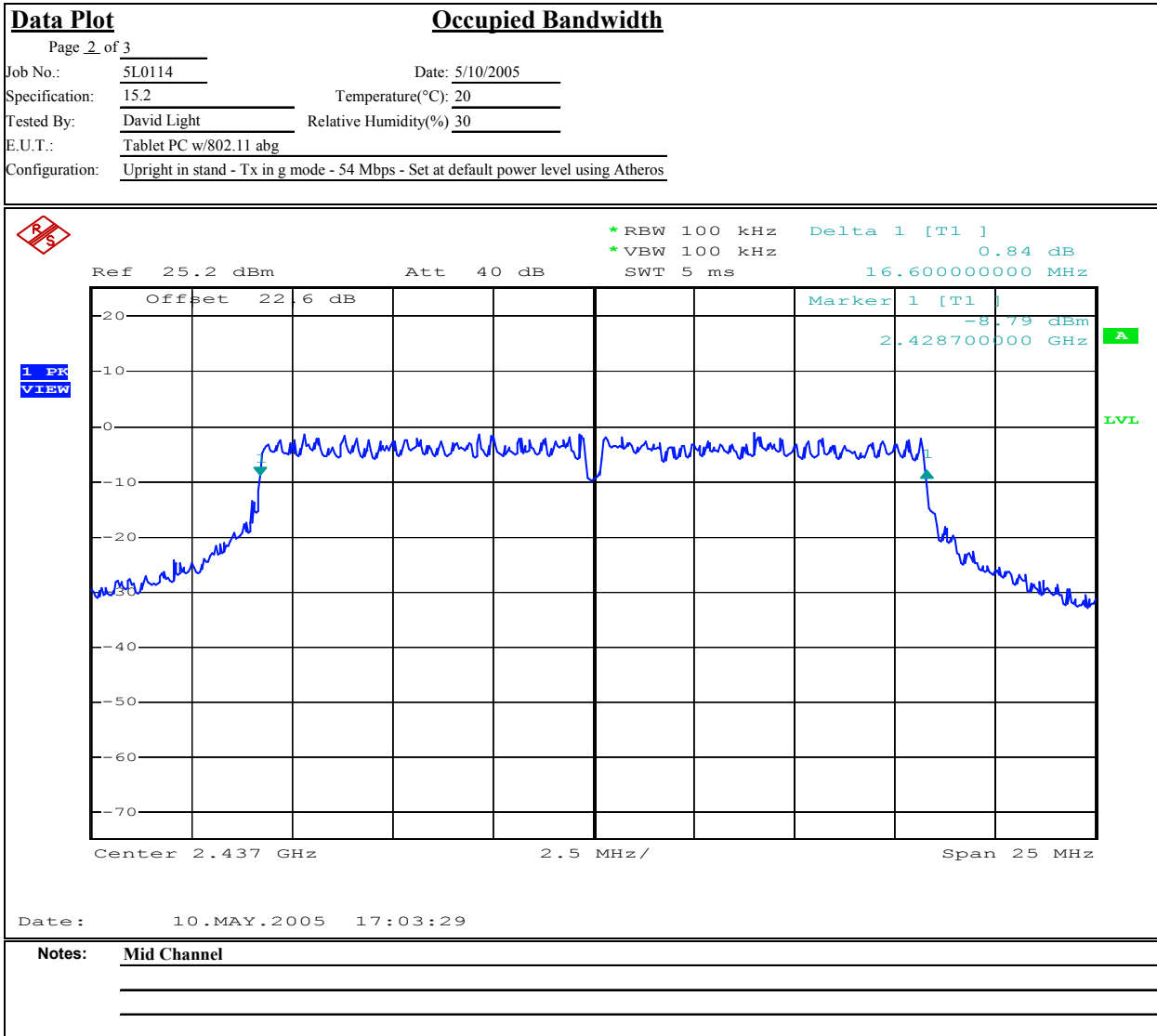



EQUIPMENT: LS800 TS01 w/ Atheros card TEST REPORT NO.: 5L0114RUS3

**Section 5. Maximum Peak Output Power**

NAME OF TEST: Maximum Peak Output Power	PARA. NO.: 15.247(b)(1)
TESTED BY: David Light	DATE: 4/26/05

**Test Results:** Complies.

**Measurement Data:**

Mode	Frequency (MHz)	Peak Power (dBm)	Peak Power (mW)
802.11b	2412	18.3	68
802.11b	2437	18.8	76
802.11b	2462	18.5	71
802.11g	2412	18.1	65
802.11g	2437	18.6	72
802.11g	2462	18.5	71
802.11a	5745	16.6	46
802.11a	5785	16.5	45
802.11a	5825	15.8	38

The measurement was repeated at +/- 15% of nominal supply voltage with no variation noted in rf power output.

EQUIPMENT: LS800 TS01 w/ Atheros card

TEST REPORT NO.: 5L0114RUS3

**Section 6. Radiated Emissions**

NAME OF TEST: Radiated Emissions	PARA. NO.: 15.247 (c)
TESTED BY: David Light	DATE: 6/12/05

**Test Results:** Complies.

**Measurement Data:** See attached table.

Asset Number	Description	Manufacturer	Model Number	Serial Number	Last Cal	Cal Due
1484	Cable	Storm	PR90-010-072	N/A	08/26/04	08/26/05
1485	Cable	Storm	PR90-010-216	N/A	08/02/04	08/02/05
1016	Pre-Amp	HP	8449A	2749A00159	11/12/04	11/12/05
1482	Band Pass Filter	K & L	11SH10-4000/T12000-0/0	2	CBU	N/A
1036	Spectrum analyzer	R&S	FSEK30	830844/006	03/22/04	03/23/06
1304	Horn antenna	Electro Metrics	RGA-60	6151	09/22/03	09/22/05
760	Antenna biconical	Electro Metrics	MFC-25	477	06/22/04	06/22/05
759	Antenna, LP	A.H. SYSTEMS	SAS-200/510	556	07/23/04	07/23/05
791	PREAMP, 25dB	ICC	LNA25	398	11/12/04	11/12/05
991	Horn antenna	EMCO	3160-10	9704-1049	CNR	N/A
992	Horn antenna	EMCO	3160-09	9705-1079	CNR	N/A

**Radiated Emissions**

<u>Radiated Emissions</u>	
Page <u>1</u> of <u>3</u>	
Job No.: <u>5L0114</u>	Date: <u>6/12/2005</u>
Specification: <u>15.247/15.205</u>	Temperature(°C): <u>20</u>
Tested By: <u>David Light</u>	Relative Humidity(%) <u>30</u>
E.U.T.: <u>Tablet PC with 802.11 abg card</u>	
Configuration: <u>Upright in stand - 802.11b mode - 11 Mbps - Set at 19 using test utility</u>	
Sample Number: <u>1</u>	
Location: <u>AC 3</u>	RBW: <u>1 MHz</u>
Detector Type: <u>Peak</u>	Peak VBW: <u>1 MHz</u>
	Average VBW: <u>10 MHz</u>
<u>Test Equipment Used</u>	
Antenna: <u>1304</u>	Directional Coupler: <u>#N/A</u>
Pre-Amp: <u>1016</u>	Cable #1: <u>1484</u>
Filter: <u>1482</u>	Cable #2: <u>1485</u>
Receiver: <u>1036</u>	Cable #3: <u>#N/A</u>
Attenuator #1: <u>#N/A</u>	Cable #4: <u>#N/A</u>
Attenuator #2: <u>#N/A</u>	Mixer: <u>#N/A</u>
Measurement Uncertainty: +/- 3.6 dB	

Frequency (GHz)	Meter Reading (dBuV)	Antenna Factor (dB)	Cable Loss (dB)	Pre-Amp Gain (dB)	Corrected Reading (dBuV/m)	Peak Limit (dBuV/m)	Average Limit (dBuV/m)	Detector / Polarity
<b>Tx @ 2462 MHz</b>								
2.4385	43.7	28.2	3.1	22.8	52.2	74		P/V g Mode
2.4385	33.0	28.2	3.1	22.8	41.5		54	A/V g Mode
2.4385	43.7	28.2	3.1	22.8	52.2	74		P/H g Mode
2.4385	33.0	28.2	3.1	22.8	41.5		54	A/H g Mode
					0.0			
2.4385	43.7	28.2	3.1	22.8	52.2	74		P/V b Mode
2.4385	33.0	28.2	3.1	22.8	41.5		54	A/V b Mode
2.4385	43.7	28.2	3.1	22.8	52.2	74		P/H b Mode
2.4385	33.0	28.2	3.1	22.8	41.5		54	A/H b Mode

The spectrum was searched from 30 MHz to 25 GHz in 802.11b/g modes and to 40 GHz for 802.11a mode.

No emissions were detected. Data shown to verify upper band edge compliance to restricted band limits in 2400 MHz band

All emissions are reported.

**Radiated Photographs**



*EQUIPMENT:* LS800 TS01 w/ Atheros card      *TEST REPORT NO.:* 5L0114RUS3

---

**Section 7.      Peak Power Spectral Density**

NAME OF TEST: Peak Power Spectral Density	PARA. NO.: 15.247(d)
TESTED BY: David Light	DATE: 5/11/05

**Test Results:**                      Complies.

**Measurement Data:**    See attached data..

Note: The measurements for the “a” mode were done radiated. At the time of test, there were no means to make conducted measurements.



EQUIPMENT: LS800 TS01 w/ Atheros card

TEST REPORT NO.: 5L0114RUS3

**Peak Power Spectral Density**

<b>Data Plot</b>		<b>Peak Power Spectral Density</b>		Complete <u>  X  </u>
Page <u>  1  </u> of <u>  3  </u>	Job No.: <u>  5L0114  </u>	Date:	<u>  4/26/2005  </u>	Preliminary: <u>          </u>
Specification: <u>  15.247  </u>	Temperature(°C): <u>  20  </u>	Tested By: <u>  David Light  </u>	Relative Humidity(%): <u>  30  </u>	
E.U.T.: <u>  Tablet PC w/802.11 abg  </u>	Configuration: <u>  Upright in stand - Tx in a mode - 54 Mbps - Set at default power level using Atheros test utility  </u>			
Sample Number: <u>  1  </u>				
Location: <u>  AC 3  </u>	RBW: <u>  3 kHz  </u>			
Detector Type: <u>  Peak  </u>	VBW: <u>  3 kHz  </u>			
<b>Test Equipment Used</b>				
Antenna: <u>  1304  </u>	Directional Coupler: <u>          </u>			
Pre-Amp: <u>          </u>	Cable #1: <u>  1484  </u>			
Filter: <u>          </u>	Cable #2: <u>  1485  </u>			
Receiver: <u>  1464  </u>	Cable #3: <u>          </u>			
Attenuator #1: <u>          </u>	Cable #4: <u>          </u>			
Attenuator #2: <u>          </u>	Mixer: <u>          </u>			
Additional equipment used: <u>                                  </u>				
Measurement Uncertainty: <u>  +/-1.7 dB  </u>				
<p>ATTEN 10dB RL 0dBm                      10dB/</p> <p style="text-align: center;">D</p> <p style="text-align: center;">SWEEP TIME 2.0 ksec</p> <p style="text-align: center;">CENTER 5.745000GHz                      SPAN 6.000MHz *RBW 3.0kHz                      VBW 3.0kHz                      *SWP 2.0ksec</p>				
Notes:	<u>  Lowest Channel  </u>			
	<u>  Display line = +8 dBm EIRP  </u>			
	<u>                                  </u>			

EQUIPMENT: LS800 TS01 w/ Atheros card

TEST REPORT NO.: 5L0114RUS3

### Peak Power Spectral Density

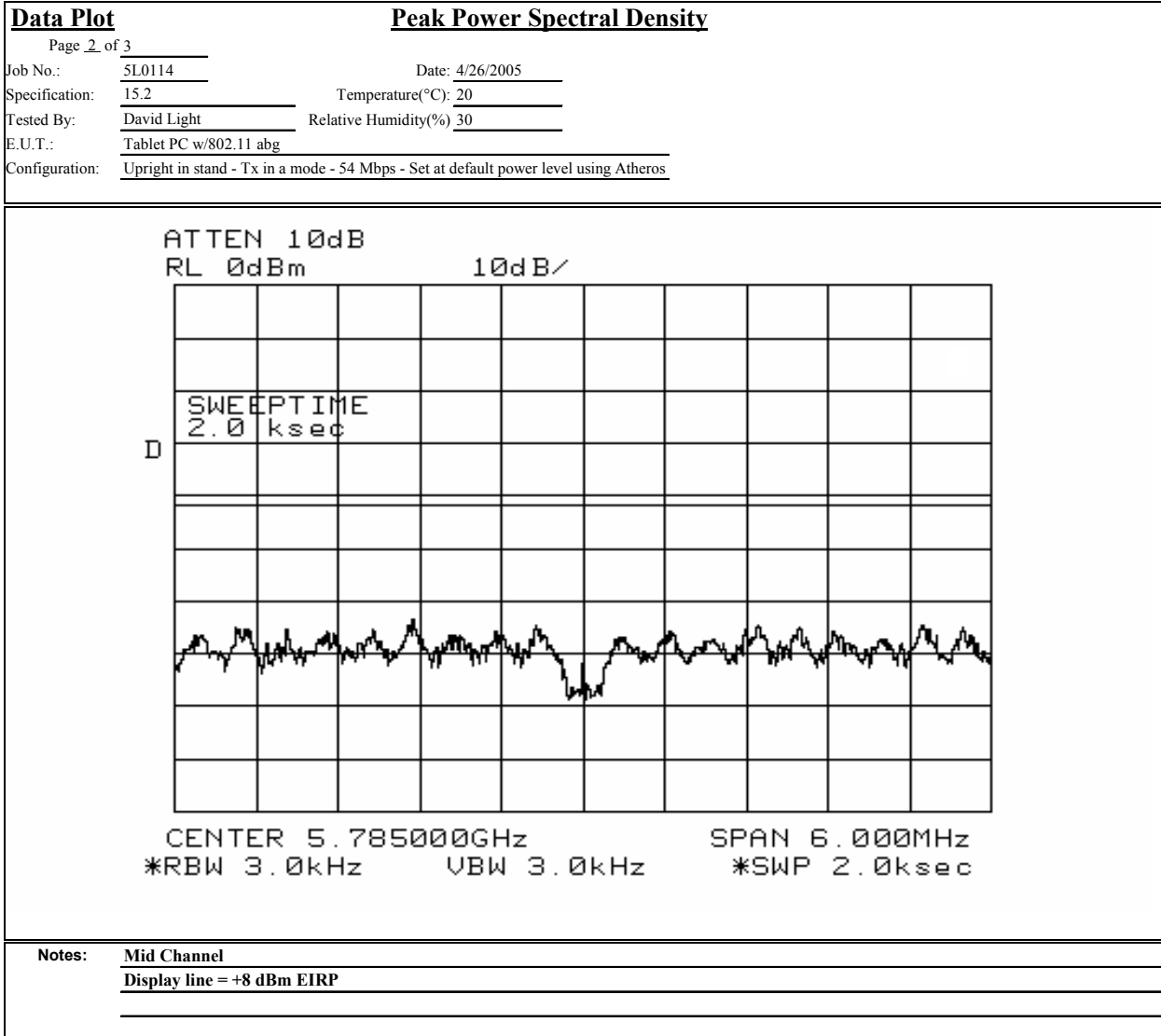

EQUIPMENT: LS800 TS01 w/ Atheros card

TEST REPORT NO.: 5L0114RUS3

**Peak Power Spectral Density**

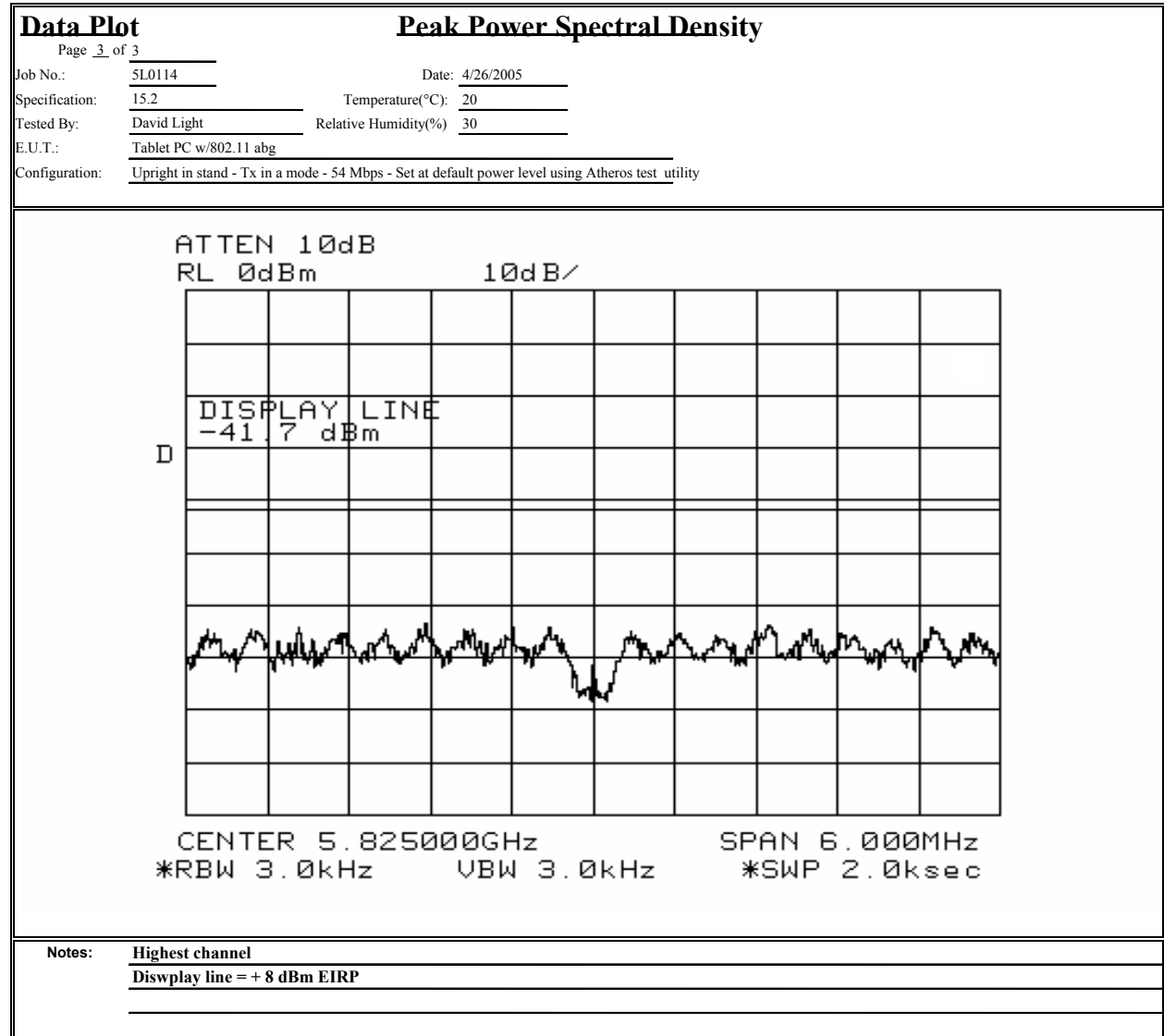

EQUIPMENT: LS800 TS01 w/ Atheros card

TEST REPORT NO.: 5L0114RUS3

**Peak Power Spectral Density**

Data Plot		Peak Power Spectral Density	
Page 1 of 3			Complete X
Job No.:	5L0114	Date:	5/10/2005
Specification:	15.247	Temperature(°C):	20
Tested By:	David Light	Relative Humidity(%)	30
E.U.T.:	Tablet PC w/802.11 abg		
Configuration:	TX		
Sample Number:	3		
Location:	AC 3	RBW:	3 kHz
Detector Type:	Peak	VBW:	3 kHz
<b>Test Equipment Used</b>			
Antenna:		Directional Coupler:	
Pre-Amp:		Cable #1:	1973
Filter:		Cable #2:	
Receiver:	1659	Cable #3:	
Attenuator #1:	1472	Cable #4:	
Attenuator #2:		Mixer:	
Additional equipment used:			
Measurement Uncertainty:	+/-1.7 dB		
Date:	10.MAY.2005 13:49:25		
Notes:	Lowest Channel		

**Peak Power Spectral Density**

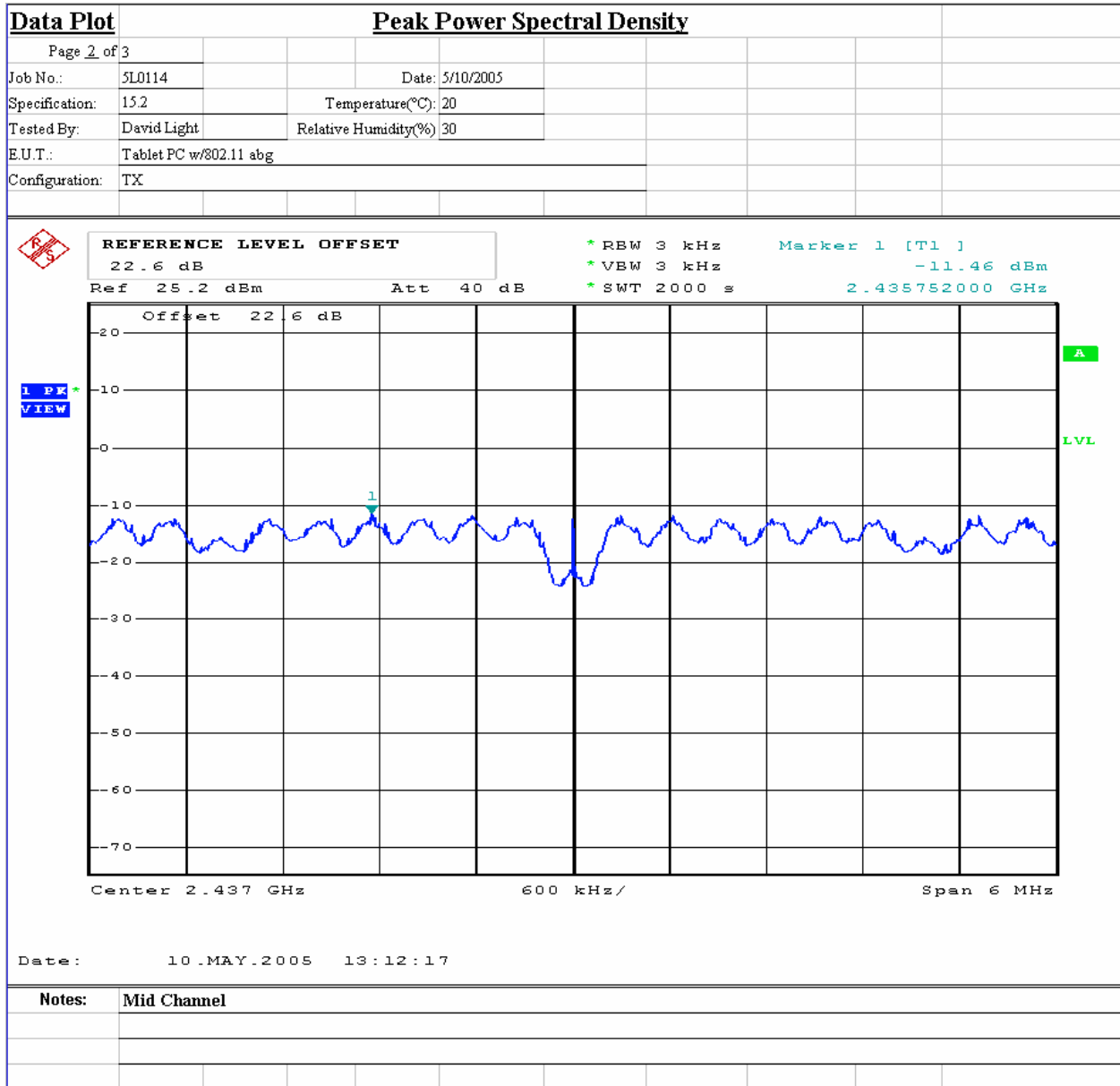

EQUIPMENT: LS800 TS01 w/ Atheros card

TEST REPORT NO.: 5L0114RUS3

**Peak Power Spectral Density**

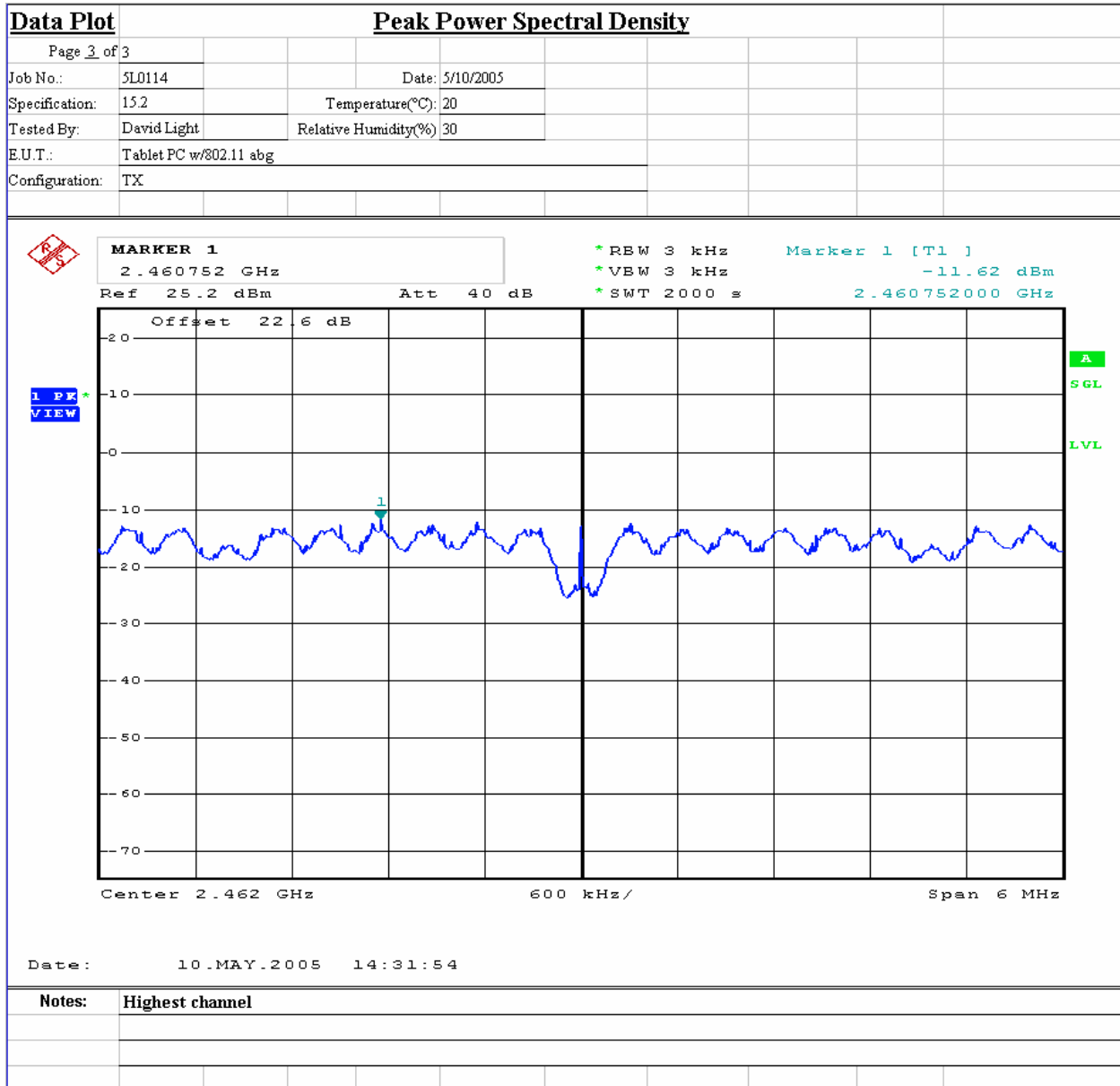

EQUIPMENT: LS800 TS01 w/ Atheros card

TEST REPORT NO.: 5L0114RUS3

**Peak Power Spectral Density**

Data Plot		Peak Power Spectral Density	
Page 1 of 3			Complete <input checked="" type="checkbox"/>
Job No.: 5L0114		Date: 5/10/2005	Preliminary:
Specification: 15.247		Temperature(°C): 20	
Tested By: David Light		Relative Humidity(%): 30	
E.U.T.: Tablet PC w/802.11 abg			
Configuration: tx			
Sample Number: 3			
Location: AC 3		RBW: 3 kHz	
Detector Type: Peak		VBW: 3 kHz	
<b>Test Equipment Used</b>			
Antenna:		Directional Coupler:	
Pre-Amp:		Cable #1: 1973	
Filter:		Cable #2:	
Receiver: 1659		Cable #3:	
Attenuator #1:		Cable #4:	
Attenuator #2: 1472		Mixer:	
Additional equipment used:			
Measurement Uncertainty: +/-1.7 dB			
<div style="display: flex; justify-content: space-between;"> <div> <p><b>MARKER 1</b></p> <p>2.412624 GHz</p> <p>Ref 25.2 dBm Att 40 dB</p> </div> <div> <p>* RBW 3 kHz</p> <p>* VBW 3 kHz</p> <p>* SWT 2000 s</p> </div> <div> <p>Marker 1 [T1]</p> <p>-12.05 dBm</p> <p>2.412624000 GHz</p> </div> </div> <p>Offset 22.6 dB</p> <p>Center 2.412 GHz 600 kHz/ Span 6 MHz</p>			
Date:	10.MAY.2005 16:25:18		
Notes:	Lowest Channel		

EQUIPMENT: LS800 TS01 w/ Atheros card

TEST REPORT NO.: 5L0114RUS3

Peak Power Spectral Density

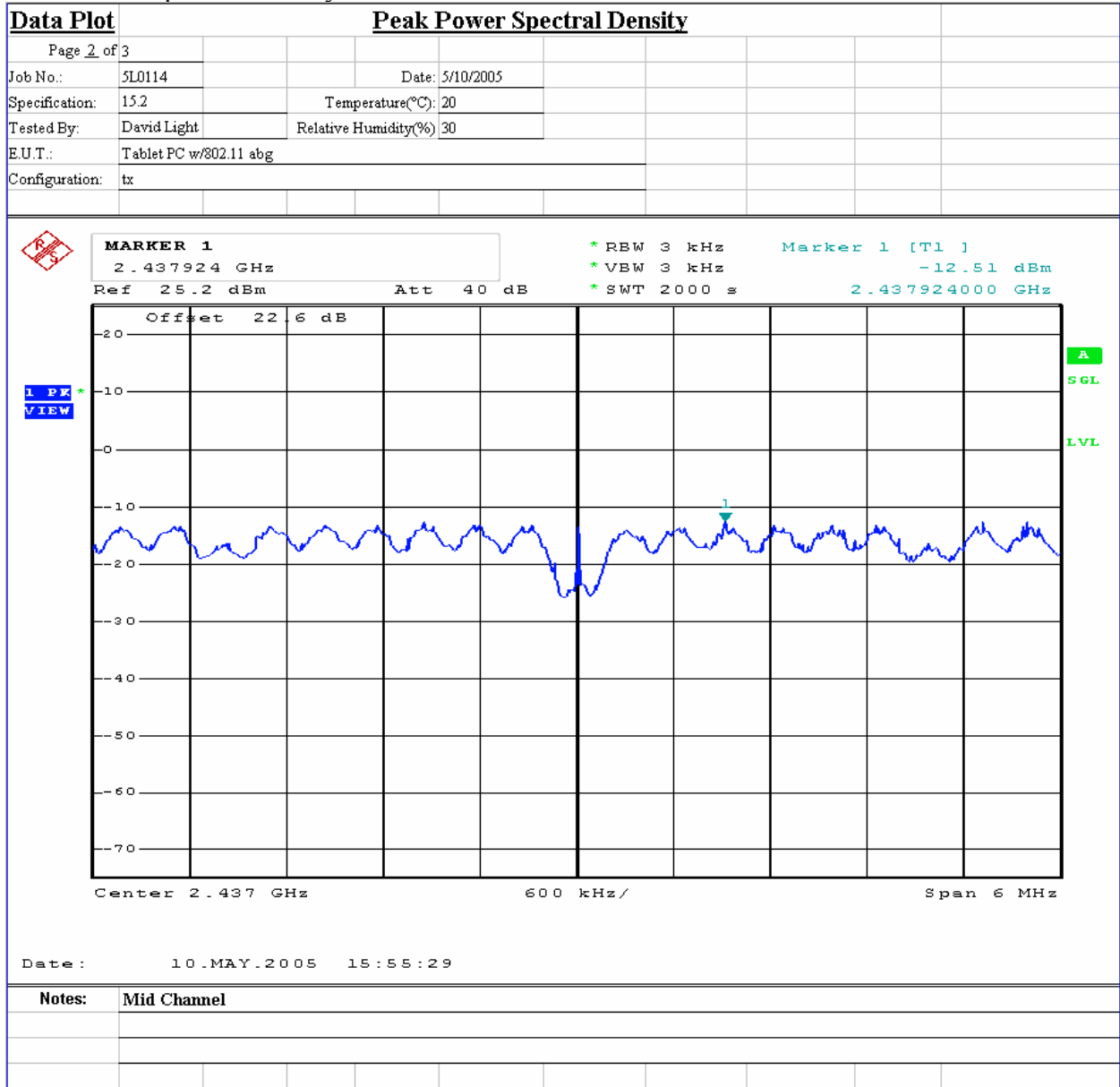



EQUIPMENT: LS800 TS01 w/ Atheros card

TEST REPORT NO.: 5L0114RUS3

**Peak Power Spectral Density**

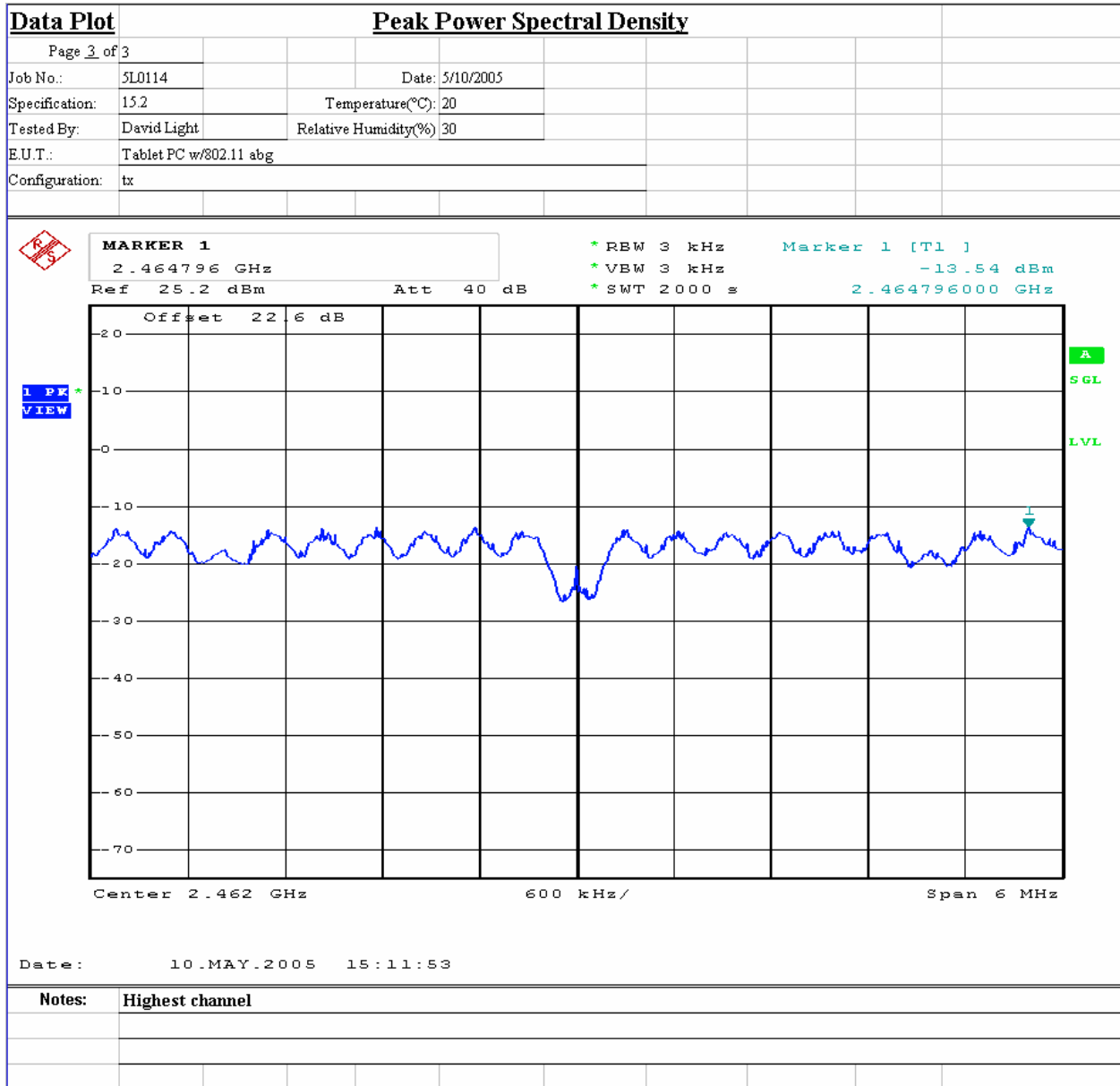

EQUIPMENT: LS800 TS01 w/ Atheros card TEST REPORT NO.: 5L0114RUS3

**Section 8 Spurious Emissions at Antenna Terminals**

NAME OF TEST: Spurious Emissions at Antenna Terminals	PARA. NO.: 15.247(d)
TESTED BY: David Light	DATE: 5/11/05

**Test Results:** Complies.

**Measurement Data:** See attached data..

Asset Number	Description	Manufacturer	Model Number	Serial Number	Last Cal	Cal Due
1036	Spectrum analyzer	R & S	FSEK30	830844/006	03/22/04	03/23/06
1472	20db Attenuator	Omni Spectra	20600-20db	NONE	CBU	N/A
1973	CABLE, 1m	KTL	0	N/A	08/02/04	08/02/05



EQUIPMENT: LS800 TS01 w/ Atheros card

TEST REPORT NO.: 5L0114RUS3

**Test Data – Spurious Emissions at Antenna Terminals**

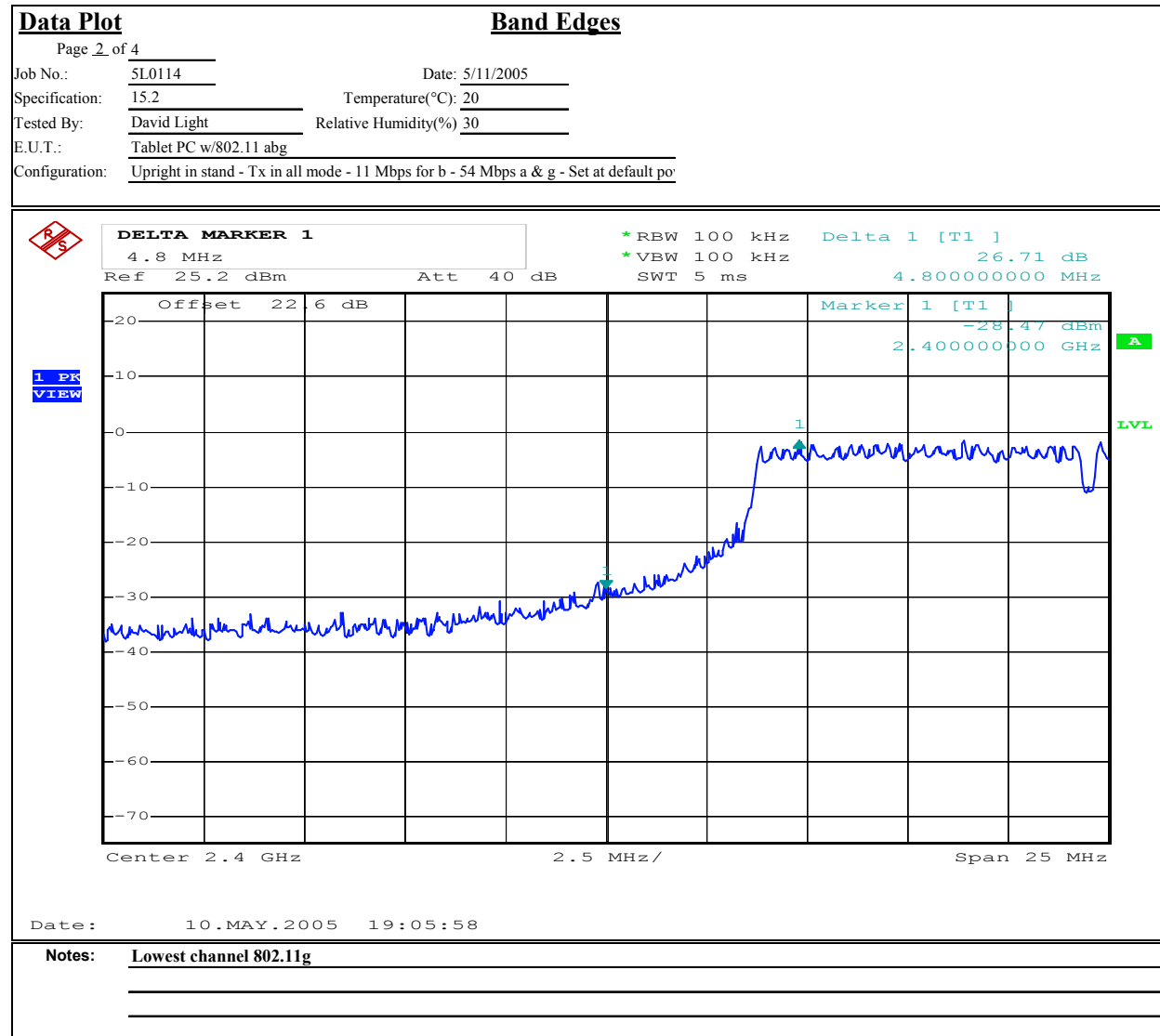

EQUIPMENT: LS800 TS01 w/ Atheros card

TEST REPORT NO.: 5L0114RUS3

**Test Data – Spurious Emissions at Antenna Terminals**

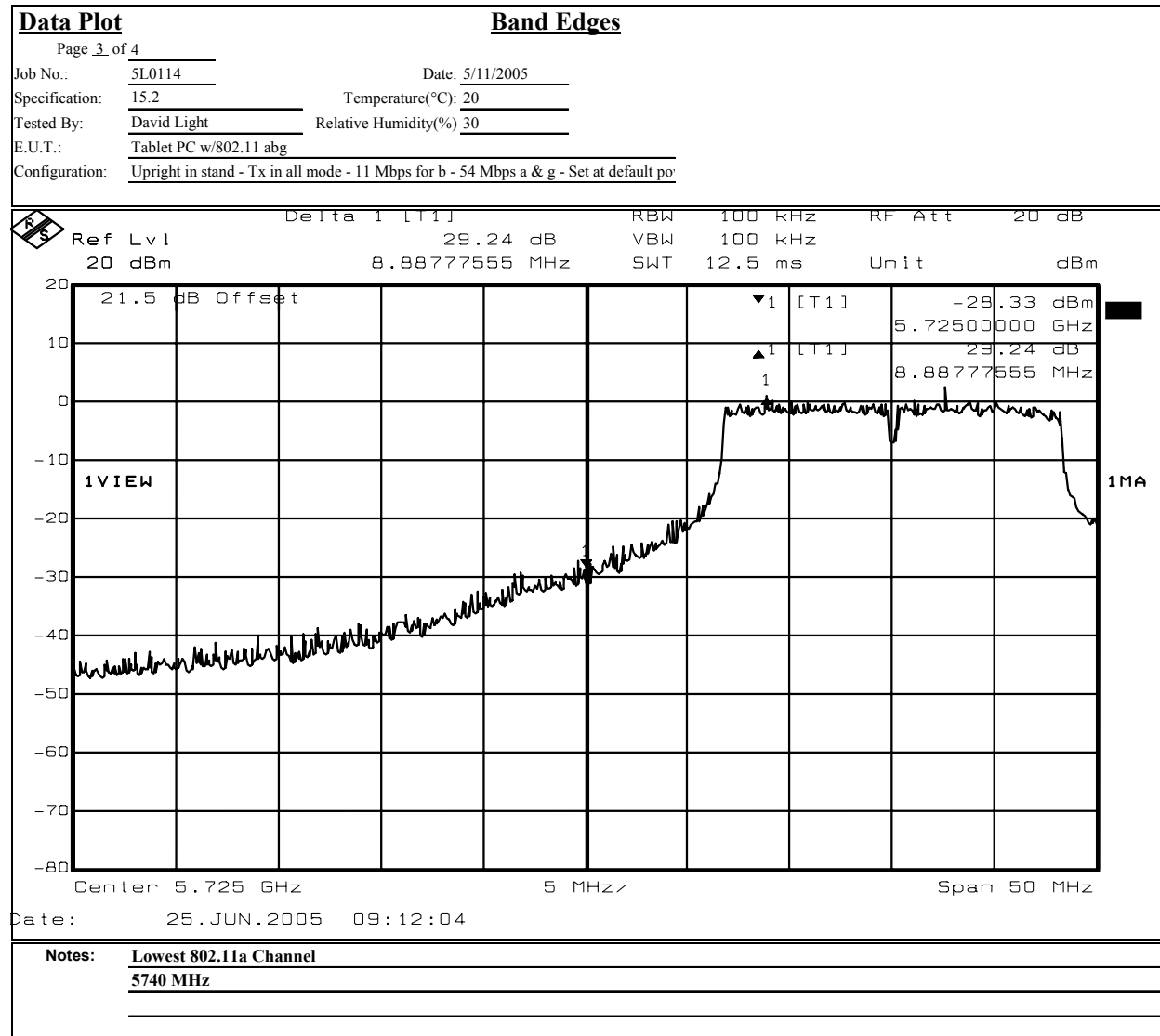

EQUIPMENT: LS800 TS01 w/ Atheros card

TEST REPORT NO.: 5L0114RUS3

Test Data – Spurious Emissions at Antenna Terminals

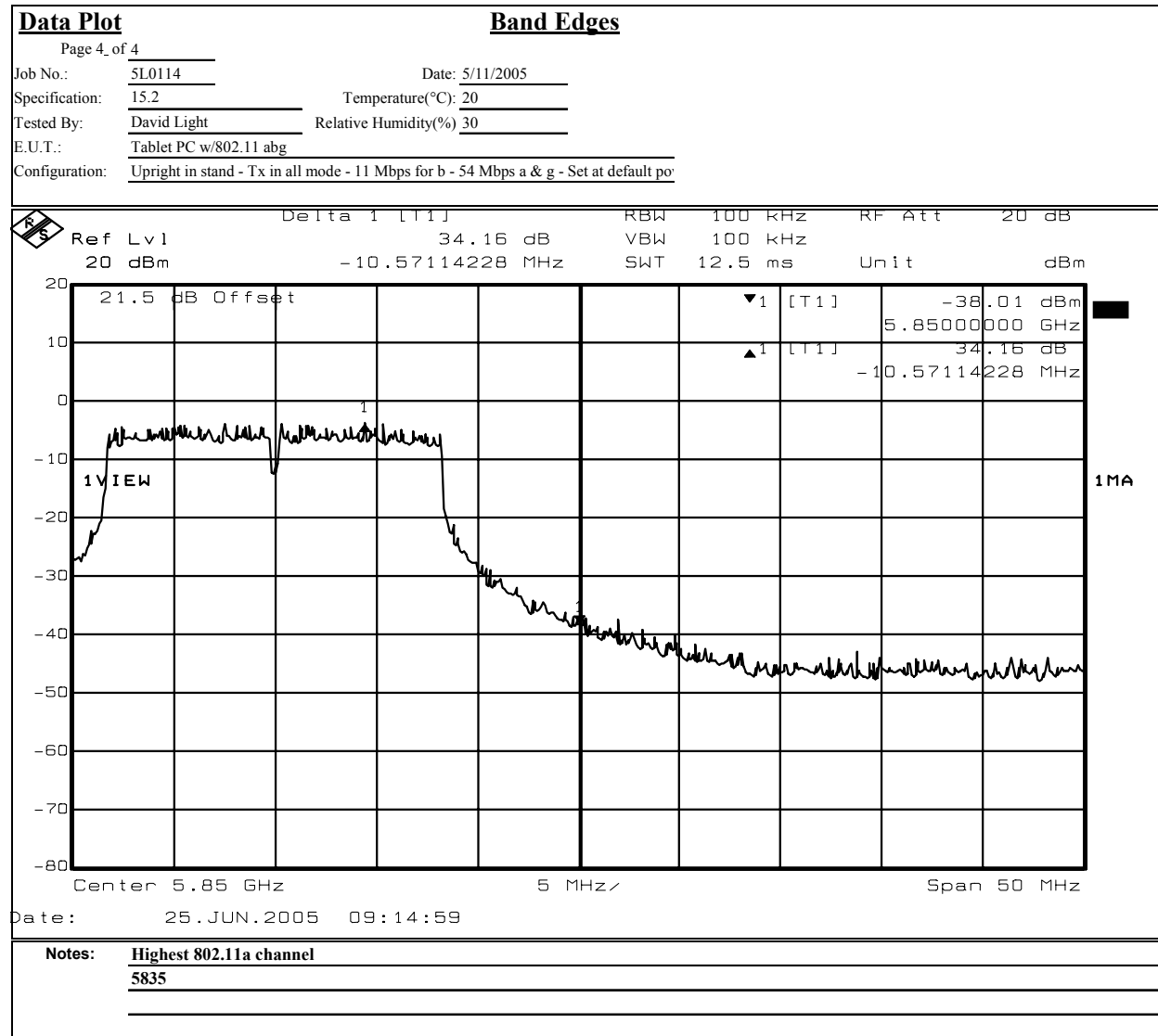

EQUIPMENT: LS800 TS01 w/ Atheros card

TEST REPORT NO.: 5L0114RUS3

Test Data – Spurious Emissions at Antenna Terminals

Data Plot		Spurious Emissions at Antenna Terminals	
Page 1 of 2		Complete	X
Job No.:	5L0114	Date:	5/13/2005
Specification:	15.407(a)	Temperature(°C):	20
Tested By:	David Light	Relative Humidity(%)	50
E.U.T.:	Tablet PC w/802.11 a/b/g radio		
Configuration:	Tx		
Sample Number:	1		
Location:	Lab 1	RBW:	100 kHz
Detector Type:	Peak	VBW:	100 kHz
<b>Test Equipment Used</b>			
Antenna:		Directional Coupler:	
Pre-Amp:		Cable #1:	1081
Filter:		Cable #2:	
Receiver:	1036	Cable #3:	
Attenuator #1:	1472	Cable #4:	
Attenuator #2:		Mixer:	
Additional equipment used:			
Measurement Uncertainty:	+/-1.7 dB		
<p>Marker 1 [T1] RBW 100 kHz RF Att 20 dB                      Ref Lvl 20 dBm 4.23 dBm VBW 100 kHz                      2.38188377 GHz SWT 6.4 s Unit dBm</p> <p>24.3 dB Offset                      15.8 dBm                      4.23 dBm                      2.38188377 GHz                      1MA</p> <p>Start 30 MHz 2.497 GHz/ Stop 25 GHz</p>			
Notes:	Tx 2412 - 11 Mbps - 802.11b		

EQUIPMENT: LS800 TS01 w/ Atheros card

TEST REPORT NO.: 5L0114RUS3

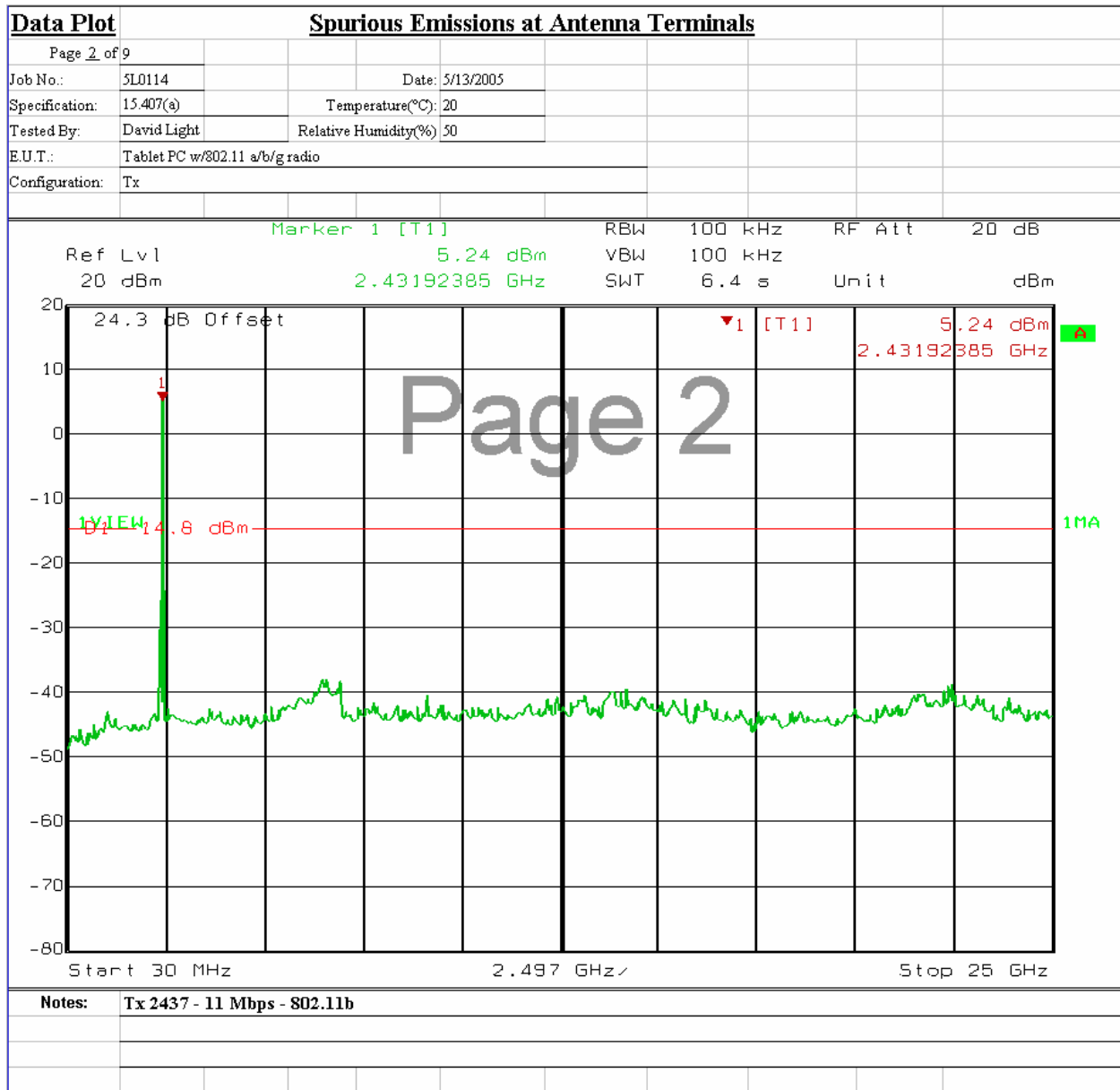



Test Data – Spurious Emissions at Antenna Terminals

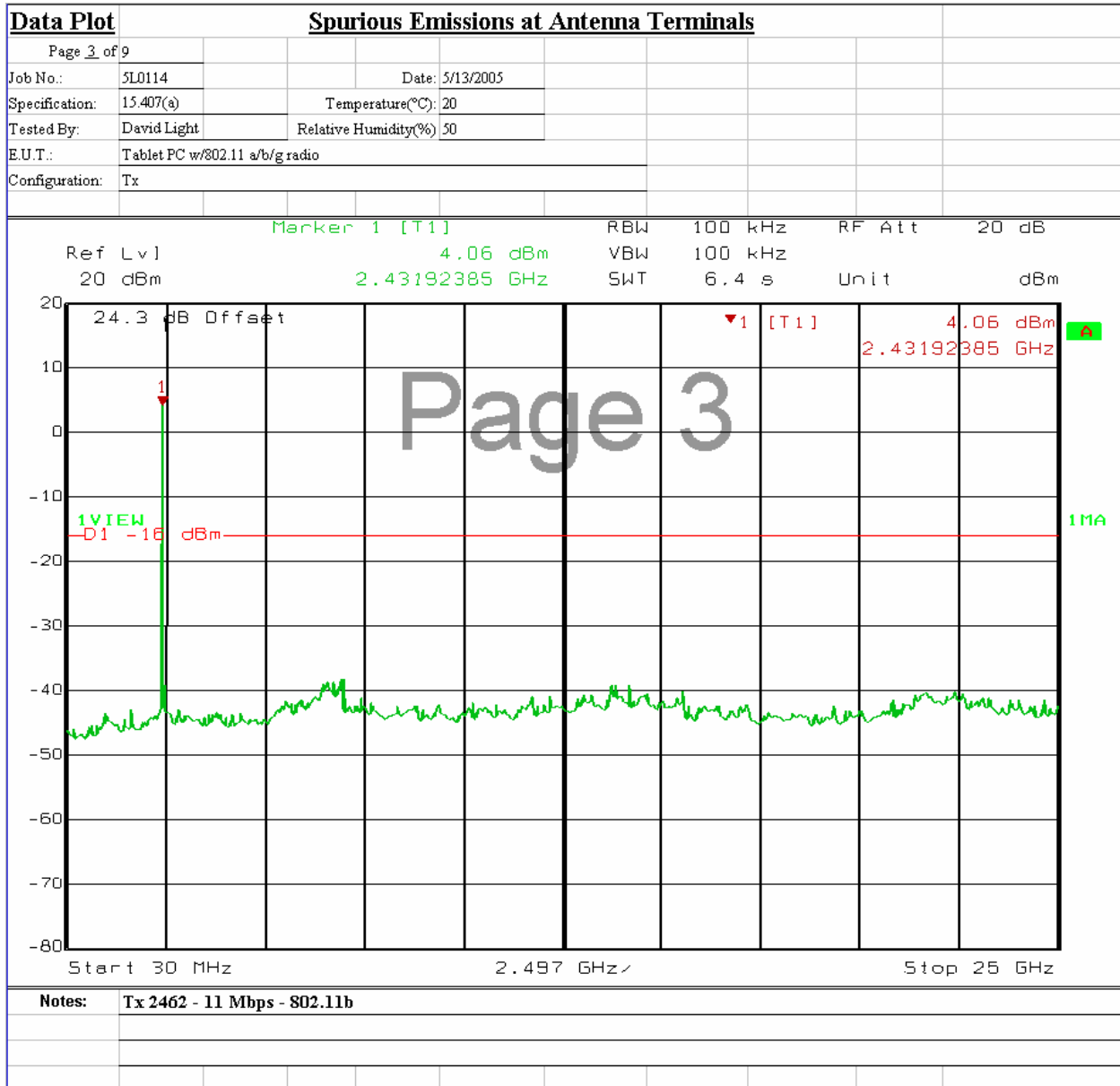

Test Data – Spurious Emissions at Antenna Terminals



EQUIPMENT: LS800 TS01 w/ Atheros card

TEST REPORT NO.: 5L0114RUS3

Test Data – Spurious Emissions at Antenna Terminals



EQUIPMENT: LS800 TS01 w/ Atheros card

TEST REPORT NO.: 5L0114RUS3

Test Data – Spurious Emissions at Antenna Terminals





Test Data – Spurious Emissions at Antenna Terminals



Test Data – Spurious Emissions at Antenna Terminals



### Section 9 Test Equipment

Nemko ID	Description	Manufacturer Model Number	Serial Number	Calibration Date	Calibration Due
969	lisn	Schwarzbeck 8120	8120281	09/17/04	09/17/05
1547	CABLE .6m	KTL RG223	N/A	06/09/04	06/09/05
1115	CABLE, 4.5m	KTL RG223	N/A	04/27/05	04/27/06
718	HP SPECTRUM ANALYZER	HEWLETT PACKARD 8591EM	3639A00980	04/06/05	04/06/06
966	Receiver	Rohde & Schwartz ESH2	880370/029	09/20/04	09/20/05
1193	LIMITER	FISCHER FCC-450B-1.25N	956	02/24/05	02/24/06
1555	Filter high pass 5KHz	Solar Electronics 7930-5.0	933125	04/20/05	04/20/06
1484	Cable 2.0-18.0 Ghz	Storm PR90-010-072	N/A	08/26/04	08/26/05
1464	Spectrum analyzer	Hewlett Packard 8563E	3551A04428	01/14/05	01/15/07
1485	Cable 2.0-18.0 Ghz	Storm PR90-010-216	N/A	08/02/04	08/02/05
1304	HORN ANTENNA	ELECTRO METRICS RGA-60	6151	09/22/03	09/22/05
1029	PEAK POWER METER	HP 8900D	3303U0012	12/23/04	12/23/05
1030	PEAK POWER SENSOR	HP 84811A	2539A03573	12/23/04	12/23/05
1016	Pre-Amp	HEWLETT PACKARD 8449A	2749A00159	11/12/04	11/12/05
759	ANTENNA, LOG PERIODIC	A.H. SYSTEMS SAS-200/510	556	07/23/04	07/23/05
790	Unidapt/30	RF Industries NONE	NONE	CNR	N/A
791	PREAMP, 25dB	ICC LNA25	398	11/12/04	11/12/05
1482	Band Pass Filter	K & L 11SH10-4000/T12000-0/0	2	Cal B4 Use	N/A
1036	SPECTRUM ANALYZER	ROHDE & SCHWARZ FSEK30	830844/006	03/22/04	03/23/06
1472	20db Attenuator DC 18 Ghz	Omni Spectra 20600-20db	NONE	CBU	N/A
1973	CABLE, 1m	KTL 0	N/A	08/02/04	08/02/05



**ANNEX A - TEST DETAILS**

EQUIPMENT: LS800 TS01 w/ Atheros card TEST REPORT NO.: 5L0114RUS3

NAME OF TEST: Powerline Conducted Emissions	PARA. NO.: 15.207(a)
---	----------------------

**Minimum Standard:** §15.207 Conducted limits.

(a) Except as shown in paragraphs (b) and (c) of this section, for an intentional radiator that is designed to be connected to the public utility (AC) power line, the radio frequency voltage that is conducted back onto the AC power line on any frequency or frequencies, within the band 150 kHz to 30 MHz, shall not exceed the limits in the following table, as measured using a 50 mH/50 ohms line impedance stabilization network (LISN). Compliance with the provisions of this paragraph shall be based on the measurement of the radio frequency voltage between each power line and ground at the power terminal. The lower limit applies at the boundary between the frequency ranges.

Frequency of Conducted Emission (MHz)	Limit (dBmV)	
	Quasi-peak	Average
0.15-0.5	66 to 56*	56 to 46*
0.5-5	56	46
5-30	60	50

\* Decreases with the logarithm of the frequency.

(b) The limit shown in paragraph (a) of this section shall not apply to carrier current systems operating as intentional radiators on frequencies below 30 MHz. In lieu thereof, these carrier current systems shall be subject to the following standards:

(1) For carrier current systems containing their fundamental emission within the frequency band 535-1705 kHz and intended to be received using a standard AM broadcast receiver: no limit on conducted emissions.

(2) For all other carrier current systems: 1000 mV within the frequency band 535-1705 kHz, as measured using a 50 mH/50 ohms LISN.

(3) Carrier current systems operating below 30 MHz are also subject to the radiated emission limits as provided in §15.205 and §§15.209, 15.221, 15.223, 15.225 or 15.227, as appropriate.

(c) Measurements to demonstrate compliance with the conducted limits are not required for devices which only employ battery power for operation and which do not operate from the AC power lines or contain provisions for operation while connected to the AC power lines. Devices that include, or make provision for, the use of battery chargers which permit operating while charging, AC adaptors or battery eliminators or that connect to the AC power lines indirectly, obtaining their power through another device which is connected to the AC power lines, shall be tested to demonstrate compliance with the conducted limits.

*EQUIPMENT:* LS800 TS01 w/ Atheros card      TEST REPORT NO.: 5L0114RUS3

---

NAME OF TEST: Occupied Bandwidth	PARA. NO.: 15.247(a)(2)
----------------------------------	-------------------------

**Minimum Standard:**      The minimum 6 dB bandwidth shall be at least 500 kHz

EQUIPMENT: LS800 TS01 w/ Atheros card TEST REPORT NO.: 5L0114RUS3

NAME OF TEST: Maximum Peak Output Power	PARA. NO.: 15.247(b)(1)
---	-------------------------

**Minimum Standard:** The maximum peak output power shall not exceed 1 watt.

If transmitting antennas of directional gain greater than 6 dBi are used, the power shall be reduced by the amount in dB that the directional gain of the antenna exceeds 6 dBi.

Systems operating in the 2400-2483.5 MHz band that are used exclusively for fixed, point to point operation may employ transmitting antennas with directional gain greater than 6 dBi provided the maximum peak output power is reduced by 1 dB for every 3 dB that the directional gain of the antenna exceed 6 dBi.

Systems operating in the 5725 – 5850 MHz band that are used exclusively for fixed, point-to-point operation may employ transmitting antennas with directional gain greater than 6 dBi without any corresponding reduction in transmitter peak output power.

**Direct Measurement Method For Detachable Antennas:**

If the antenna is detachable, a peak power meter is used to measure the power output with the transmitter operating into a 50 ohm load. The dBi gain of the antenna(s) employed shall be reported.

**Substitution Antenna Method for Integral Antennas:**

The peak field strength of the carrier is measured in a worst-case configuration with a RBW > 5 times the occupied bandwidth of the transmitted waveform. For cases where the RBW of the test instrument is not sufficient, the power is measured using a peak power meter instead of the spectrum analyzer.

The RBW of the spectrum analyzer shall be set to a value greater than the measured 6 dB occupied bandwidth of the E.U.T.

Number of channels tested:

Tuning range	Number of channels tested	Channel location in band
1 MHz or less	1	middle
1 to 10 MHz	2	top and bottom
more than 10 MHz	3	top, middle, bottom

*EQUIPMENT:* LS800 TS01 w/ Atheros card      *TEST REPORT NO.:* 5L0114RUS3

---

NAME OF TEST: Channel Separation	PARA. NO.: 15.247(a)(1)
----------------------------------	-------------------------

**Minimum Standard:**                      Frequency hopping systems shall have hopping channel carrier frequencies separated by a minimum of 25 kHz or the 20 dB bandwidth of the hopping channel, whichever is greater.

NAME OF TEST: Pseudorandom Hopping Algorithm	PARA. NO.: 15.247(a)(1)
--	-------------------------

**Minimum Standard:**                      The system shall hop to channel frequencies that are selected from a pseudo-randomly ordered list of hopping frequencies. Each frequency must be used equally on average by each transmitter. The system receivers shall have input bandwidths that match the hopping channel bandwidths of their transmitters and shall shift frequencies in synchronization with the transmitted signals.

EQUIPMENT: LS800 TS01 w/ Atheros card TEST REPORT NO.: 5L0114RUS3

NAME OF TEST: Time of Occupancy	PARA. NO.: 15.247(a)(1)(ii)
---------------------------------	-----------------------------

**Minimum Standard:**

Frequency Band (MHz)	20 dB Bandwidth	No. of Hopping Channels	Average Time of Occupancy
902 - 928	<250 kHz	50	=<0.4 sec. in 20 sec.
902 – 928	=>250 kHz	25	=<0.4 sec. in 10 sec.
2400 – 2483.5	-----	75	=<0.4 sec. in 30 sec.
5725 – 5850	-----	75	=<0.4 sec. in 30 sec.

**Method Of Measurement:**

The spectrum analyzer is set as follows:

- RBW: 1 MHz
- VBW: = RBW
- Span: 0 Hz
- LOG dB/div.: 10 dB
- Sweep: Sufficient to see one hop time sequence.
- Trigger: Video

The occupancy time of one hop is measured as above. The average time of occupancy is calculated over the appropriate period of time from above table (10, 20, or 30 seconds).

Avg. time of occupancy = (period from table/duration of one hop)/no. of channels multiplied by the duration of one hop.

For instance:

If a 2.4 GHz system has a measured hop duration time of 1 msec. and uses 75 channels, then the average time of occupancy would be:

$$(30 \text{ sec.} / .001 \text{ sec.}) / 75 \text{ chan.} = 400 \times 1 \text{ msec.} = 400 \text{ msec. or } 0.4 \text{ sec. in } 30 \text{ sec.}$$

*EQUIPMENT:* LS800 TS01 w/ Atheros card      *TEST REPORT NO.:* 5L0114RUS3

NAME OF TEST: Occupied Bandwidth	PARA. NO.: 15.247(a)(2)
----------------------------------	-------------------------

**Minimum Standard:**

Frequency Band (MHz)	Maximum 20 dB Bandwidth
902 - 928	500 kHz
2400 – 2483.5	1 MHz
5725 – 5850	1 MHz

**Method Of Measurement:**

The spectrum analyzer is set as follows:

RBW: At least 1% of span/div.

VBW: >RBW

Span: Sufficient to display 20 dB bandwidth

LOG dB/div.: 10 dB

Sweep: Auto

**Number of channels tested:**

Tuning range	Number of channels tested	Channel location in band
1 MHz or less	1	middle
1 to 10 MHz	2	top and bottom
more than 10 MHz	3	top, middle, bottom

*EQUIPMENT:* LS800 TS01 w/ Atheros card      TEST REPORT NO.: 5L0114RUS3

---

NAME OF TEST: RF Exposure	PARA. NO.: 15.247(b)(4)
---------------------------	-------------------------

**Minimum Standard:**      Systems operating under the provisions of this section shall be operated in a manner that ensures the public is not exposed to radio frequency energy levels in excess of the Commission's guidelines stipulated in 1.1307(b)(1) of CFR 47.



EQUIPMENT: LS800 TS01 w/ Atheros card TEST REPORT NO.: 5L0114RUS3

NAME OF TEST: Spurious Emissions(conducted)	PARA. NO.: 15.247(c)
---	----------------------

**Minimum Standard:** In any 100kHz bandwidth outside the frequency band in which the transmitter is operating, emissions shall be at least 20 dB below the fundamental emission or shall not exceed the following field strength limits. Emissions falling in the restricted bands of 15.205 shall not exceed the following field strength limits:

Frequency (MHz)	Field Strength (µV/m @ 3m)	Field Strength (dB @ 3m)
30 - 88	100	40.0
88 - 216	150	43.5
216 - 960	200	46.0
Above 960	500	54.0

**THE SPECTRUM IS SEARCHED TO THE 10th HARMONIC OF THE HIGHEST FREQUENCY GENERATED IN THE EUT.**

**Method Of Measurement:**

30 MHz - 10th harmonic plot

RBW: 100 kHz

VBW: 300 kHz

Sweep: Auto

Display line: -20 dBc

Lower Band Edge

RBW: At least 1% of span/div.

VBW: >RBW

Span: As necessary to display any spurious at band edge.

Sweep: Auto

Center Frequency: 902 MHz, 2400 MHz, or 5725 MHz

Marker: Peak of fundamental emission

Marker Δ: Peak of highest spurious level below center frequency.

Upper Band Edge

RBW: At least 1% of span/div.

VBW: >RBW

Span: As necessary to display any spurious at band edge.

Sweep: Auto

Center Frequency: 928 MHz, 2483.5 MHz, or 5850 MHz

Marker: Peak of fundamental emission

Marker Δ: Peak of highest spurious level above center frequency.

Number of channels tested:

Tuning range	Number of channels tested	Channel location in band
1 MHz or less	1	middle
1 to 10 MHz	2	top and bottom
more than 10 MHz	3	top, middle, bottom

EQUIPMENT: LS800 TS01 w/ Atheros card TEST REPORT NO.: 5L0114RUS3

NAME OF TEST: Radiated Spurious Emissions PARA. NO.: 15.247(c)

**Minimum Standard:** In any 100kHz bandwidth outside the frequency band in which the transmitter is operating, emissions shall be at least 20 dB below the fundamental emission or shall not exceed the following field strength limits:

**Emissions falling in the restricted bands of 15.205 shall not exceed the following field strength limits:**

Frequency (MHz)	Field Strength (µV/m @ 3m)	Field Strength (dB @ 3m)
30 - 88	100	40.0
88 - 216	150	43.5
216 - 960	200	46.0
Above 960	500	54.0

**THE SPECTRUM WAS SEARCHED TO THE 10th HARMONIC**

**15.205 Restricted Bands**

MHz	MHz	MHz	GHz
0.09-0.11	16.42-16.423	399.9-410	4.5-5.25
0.495-0.505	16.69475-16.69525	608-614	5.35-5.46
2.1735-2.1905	16.80425-16.80475	960-1240	7.25-7.75
4.125-4.128	25.5-25.67	1300-1427	8.025-8.5
4.17725-4.17775	37.5-38.25	1435-1626.5	9.0-9.2
4.20725-4.20775	73-74.6	1645.5-1646.5	9.3-9.5
6.125-6.218	74.8-75.2	1660-1710	10.6-12.7
6.26775-6.26825	108-121.94	1718.8-1722.2	13.25-13.4
6.31175-6.31225	123-138	2200-2300	14.47-14.5
8.291-8.294	149.9-150.05	2310-2390	15.35-16.2
8.362-8.366	156.52475-156.52525	2483.5-2500	17.7-21.4
8.37625-8.38675	156.7-156.9	2655-2900	22.01-23.12
8.41425-8.41475	162.0125-167.17	3260-3267	23.6-24.0
12.29-12.293	167.72-173.2	3332-3339	31.2-31.8
12.51975-12.52025	240-285	3345.8-3358	36.43-36.5
12.57675-12.57725	322-335.4	3600-4400	Above 38.6
13.36-13.41	1718		

Number of channels tested:

Tuning range	Number of channels tested	Channel location in band
1 MHz or less	1	middle
1 to 10 MHz	2	top and bottom
more than 10 MHz	3	top, middle, bottom

EQUIPMENT: LS800 TS01 w/ Atheros card TEST REPORT NO.: 5L0114RUS3

NAME OF TEST: Transmitter Power Density	PARA. NO.: 15.247(d)
---	----------------------

**Minimum Standard:** The transmitted power density averaged over any 1 second interval shall not be greater than +8 dBm in any 3 kHz bandwidth.

**Method Of Measurement:** The spectrum analyzer is set as follows:

- RBW: 3 kHz
- VBW: >3 kHz
- Span: => measured 6 dB bandwidth
- Sweep: Span(kHz)/3 (i.e. for a span of 1.5 MHz the sweep rate is 1500/3 = 500 sec.
- LOG dB/div.: 2 dB

**Note:** For devices with spectrum line spacing =< 3 kHz, the RBW of the analyzer is reduced until the spectral lines are resolved. The measurement data is normalized to 3 kHz by summing the power of all the individual spectral lines within a 3 kHz band in linear power units.

**For Devices With Integral Antenna:**

For devices with non-detachable antennas, the received field strength is peaked and the spectrum analyzer is set as above. The peak emission level is then measured and converted to a field strength by adding the appropriate antenna factor and cable loss. This field strength is then converted to an equivalent isotropic radiated power using the same method as described for Peak Power output.

Number of channels tested:

Tuning Range	Number Of Channels Tested	Channel Location In Band
1 MHz or Less	1	Middle
1 to 10 MHz	2	Top And Bottom
More Than 10 MHz	3	Top, Middle, Bottom

**ANNEX B - TEST DIAGRAMS**

**Test Site For Radiated Emissions**

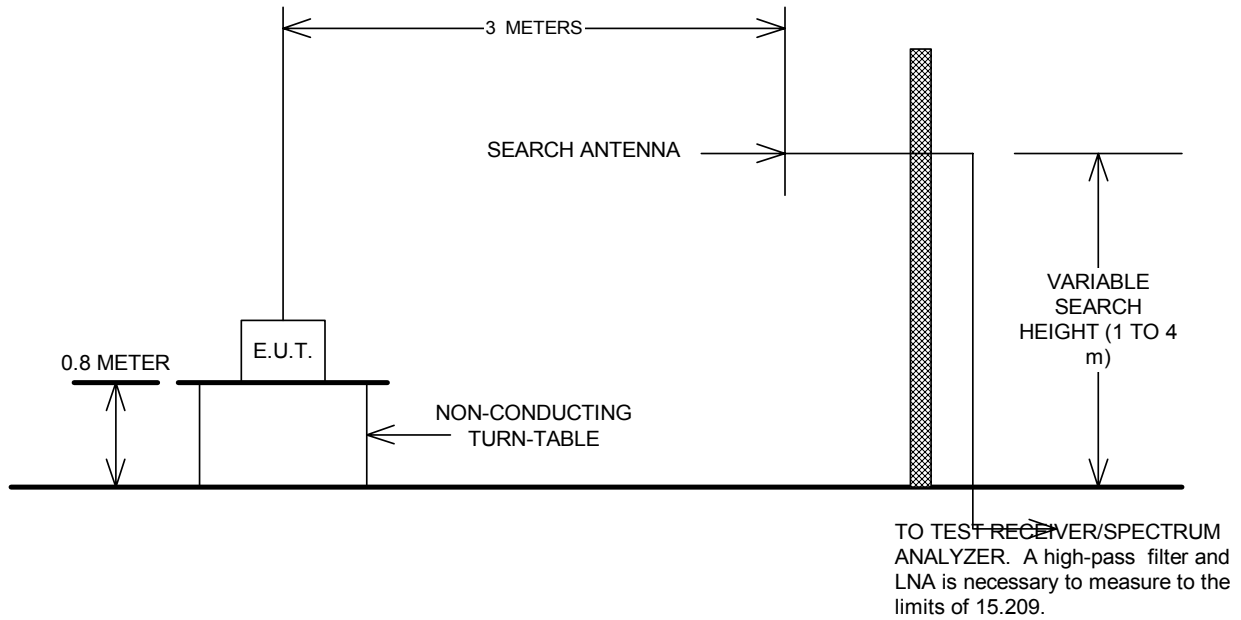

**Conducted Emissions**

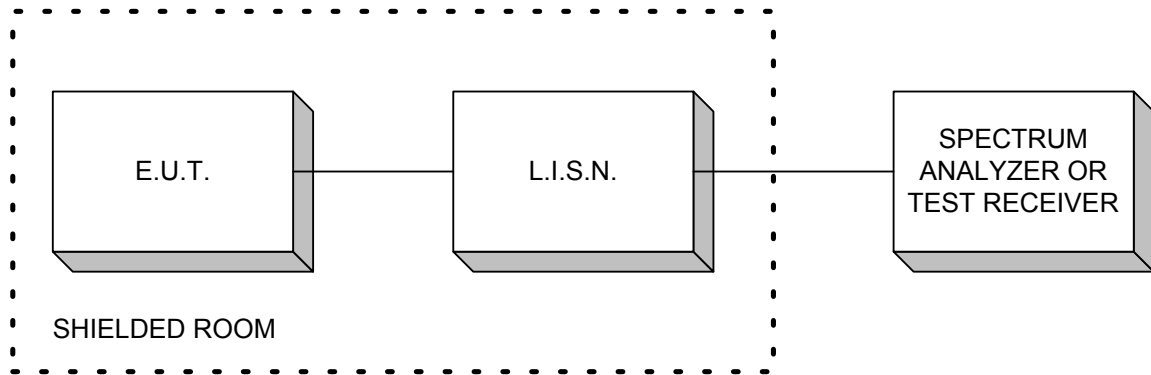

**Peak Power At Antenna Terminals**

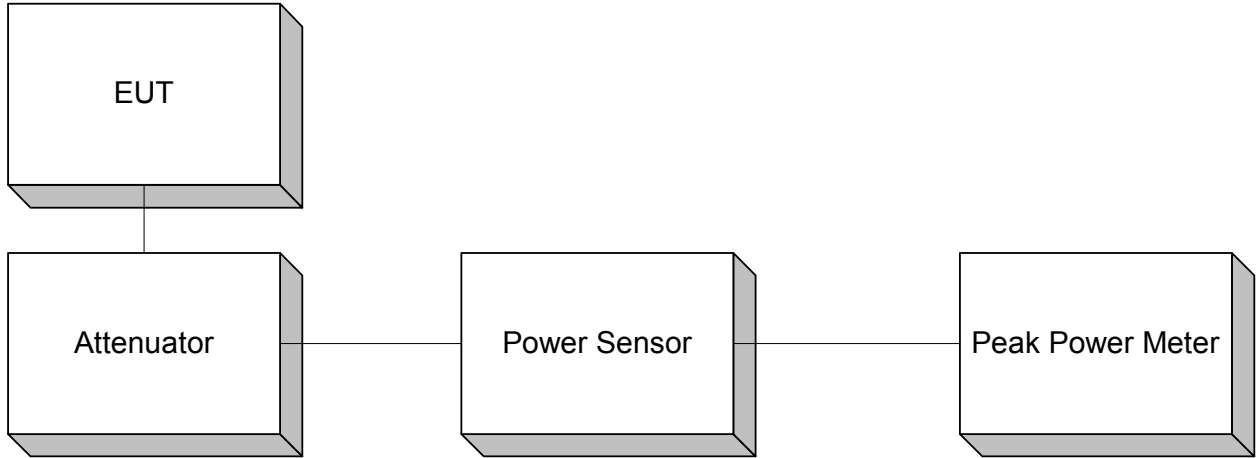

**Minimum 6 dB Bandwidth  
Peak Power Spectral Density  
Spurious Emissions (conducted)**

