



**FCC CFR47 PART 15 SUBPART E
CLASS II PERMISSIVE CHANGE
TEST REPORT
FOR**

MiniPCI Express 802.11a/b/g Transceiver

MODEL NUMBER: AR5BXB6

FCC ID: PPD-AR5BXB6-M

REPORT NUMBER: 06U10337-1, Revision B

ISSUE DATE: OCTOBER 12, 2006

Prepared for
**ATHEROS COMMUNICATIONS, INC.
5480 GREAT AMERICA PARKWAY
SANTA CLARA, CA 95054, USA**

Prepared by
**COMPLIANCE CERTIFICATION SERVICES
561F MONTEREY ROAD
MORGAN HILL, CA 95037, USA
TEL: (408) 463-0885
FAX: (408) 463-0888**

NVLAP[®]
LAB CODE:200065-0

Revision History

<u>Rev.</u>	<u>Issue Date</u>	<u>Revisions</u>	<u>Revised By</u>
--	7/20/06	Initial Issue	MH
B	10/12/2006	Performed DFS tests with new AP software revision	MH

TABLE OF CONTENTS

1. ATTESTATION OF TEST RESULTS	4
2. TEST METHODOLOGY	5
3. FACILITIES AND ACCREDITATION	5
4. CALIBRATION AND UNCERTAINTY	5
4.1. MEASURING INSTRUMENT CALIBRATION	5
4.2. MEASUREMENT UNCERTAINTY	5
5. EQUIPMENT UNDER TEST	6
5.1. DESCRIPTION OF EUT	6
5.2. MAXIMUM OUTPUT POWER	6
5.3. DESCRIPTION OF AVAILABLE ANTENNAS	6
5.4. SOFTWARE AND FIRMWARE	6
5.5. WORST-CASE CONFIGURATION AND MODE	6
5.6. DESCRIPTION OF TEST SETUP	7
6. TEST AND MEASUREMENT EQUIPMENT	9
7. LIMITS AND RESULTS	10
7.1. CHANNEL TESTS FOR THE 5470 TO 5725 MHz BAND	10
7.1.1. EMISSION BANDWIDTH	10
7.1.2. MAXIMUM POWER	17
7.1.3. AVERAGE POWER	25
7.1.4. PEAK POWER SPECTRAL DENSITY	26
7.1.5. PEAK EXCURSION	33
7.1.6. CONDUCTED SPURIOUS EMISSIONS	40
7.1.7. MAXIMUM PERMISSIBLE EXPOSURE	47
7.2. RADIATED EMISSIONS	50
7.2.1. TRANSMITTER RADIATED SPURIOUS EMISSIONS	50
7.2.2. TRANSMITTER ABOVE 1 GHz FOR 5470 TO 5725 MHz BAND	53
7.3. DYNAMIC FREQUENCY SELECTION	71
7.3.1. LIMITS	71
7.3.2. DESCRIPTION OF EUT	74
7.3.3. TEST AND MEASUREMENT SYSTEM	75
7.3.4. SETUP OF EUT AND SUPPORT EQUIPMENT	79
7.3.5. PLOTS OF NOISE, RADAR WAVEFORMS, AND WLAN SIGNALS	81
7.3.6. TEST CHANNEL AND METHOD	84
7.3.7. CHANNEL MOVE TIME AND CHANNEL CLOSING TRANSMISSION TIME	84
8. SETUP PHOTOS	87

1. ATTESTATION OF TEST RESULTS

COMPANY NAME: ATHEROS COMMUNICATIONS, INC.
5480 Great America Parkway
Santa Clara, CA 95054, USA

EUT DESCRIPTION: 802.11a/b/g/ PCIExpress Minicard

MODEL TESTED: AR5BXB6

SERIAL NUMBER: 0014A45548E8

DATE TESTED: JUNE 27 – OCTOBER 11, 2006

APPLICABLE STANDARDS	
STANDARD	TEST RESULTS
FCC PART 15 SUBPART E	NO NON-COMPLIANCE NOTED

Compliance Certification Services, Inc. tested the above equipment in accordance with the requirements set forth in the above standards. The test results show that the equipment tested is capable of demonstrating compliance with the requirements as documented in this report.

Note: The results documented in this report apply only to the tested sample, under the conditions and modes of operation as described herein. This document may not be altered or revised in any way unless done so by Compliance Certification Services and all revisions are duly noted in the revisions section. Any alteration of this document not carried out by Compliance Certification Services will constitute fraud and shall nullify the document. No part of this report may be used to claim product certification, approval, or endorsement by NVLAP, NIST, or any government agency.

Approved & Released For CCS By:

Tested By:



MIKE HECKROTTE
ENGINEERING MANAGER
COMPLIANCE CERTIFICATION SERVICES

CAN CHUNG
EMC ENGINEER
COMPLIANCE CERTIFICATION SERVICES

2. TEST METHODOLOGY

The tests documented in this report were performed in accordance with ANSI C63.4-2003, FCC CFR 47 Part 2, FCC CFR 47 Part 15 and FCC 06-96 APPENDIX "COMPLIANCE MEASUREMENT PROCEDURES FOR UNLICENSED-NATIONAL INFORMATION INFRASTRUCTURE DEVICES OPERATING IN THE 5250-5350 MHz AND 5470-5725 MHz BANDS INCORPORATING DYNAMIC FREQUENCY SELECTION".

3. FACILITIES AND ACCREDITATION

The test sites and measurement facilities used to collect data are located at 561F Monterey Road, Morgan Hill, California, USA. The sites are constructed in conformance with the requirements of ANSI C63.4, ANSI C63.7 and CISPR Publication 22. All receiving equipment conforms to CISPR Publication 16-1, "Radio Interference Measuring Apparatus and Measurement Methods."

CCS is accredited by NVLAP, Laboratory Code 200065-0. The full scope of accreditation can be viewed at <http://www.ccsemc.com>.

4. CALIBRATION AND UNCERTAINTY

4.1. MEASURING INSTRUMENT CALIBRATION

The measuring equipment utilized to perform the tests documented in this report has been calibrated in accordance with the manufacturer's recommendations, and is traceable to recognized national standards.

4.2. MEASUREMENT UNCERTAINTY

Where relevant, the following measurement uncertainty levels have been estimated for tests performed on the apparatus:

PARAMETER	UNCERTAINTY
Radiated Emission, 30 to 200 MHz	+/- 3.3 dB
Radiated Emission, 200 to 1000 MHz	+4.5 / -2.9 dB
Radiated Emission, 1000 to 2000 MHz	+4.5 / -2.9 dB
Power Line Conducted Emission	+/- 2.9 dB

Uncertainty figures are valid to a confidence level of 95%.

5. EQUIPMENT UNDER TEST

5.1. DESCRIPTION OF EUT

The AR5BXB6 is a transceiver card designed for 802.11a/b/g applications using a MiniPCI Express interface.

5.2. MAXIMUM OUTPUT POWER

The transmitter has a maximum peak conducted output power as follows:

5470 to 5725 MHz Authorized Band

Frequency Band (MHz)	Mode	Output Power (dBm)	Output Power (mW)
5500 - 5700	802.11a	17.80	60.26
5540 - 5660	802.11a Turbo	17.70	58.88

5.3. DESCRIPTION OF AVAILABLE ANTENNAS

The EUT utilizes two PIFA antennas for Tx/Rx diversity. The maximum antenna gain is 5.3 dBi.

5.4. SOFTWARE AND FIRMWARE

The EUT driver software installed in the host support equipment during testing was AR5002, ANWI Diagnostic Kernel Drive.

The test utility software used during testing was Art_V5_3_b11_xb6x.

5.5. WORST-CASE CONFIGURATION AND MODE

The worst-case data rate is determined to be 6 Mb/s, based on previous experience with Atheros WLAN product design architectures.

5.6. DESCRIPTION OF TEST SETUP

SUPPORT EQUIPMENT

PERIPHERAL SUPPORT EQUIPMENT LIST				
Description	Manufacturer	Model	Serial Number	FCC ID
Laptop	IBM	Thinkpad T42	ZZ-27167	DoC
AC Adapter	IBM	92P1016	11S92P1016ZAC65C7 1HZ	DoC

I/O CABLES

I/O CABLE LIST						
Cable No.	Port	# of Identical Ports	Connector Type	Cable Type	Cable Length	Remarks
1	AC	1	US 115V	Un-shielded	2m	NA
2	DC	1	DC	Un-shielded	2m	NA

TEST SETUP

The EUT is installed in a host laptop computer via a MiniPCI Express extender board during the tests. Test software exercised the radio card.

SETUP DIAGRAM FOR TESTS

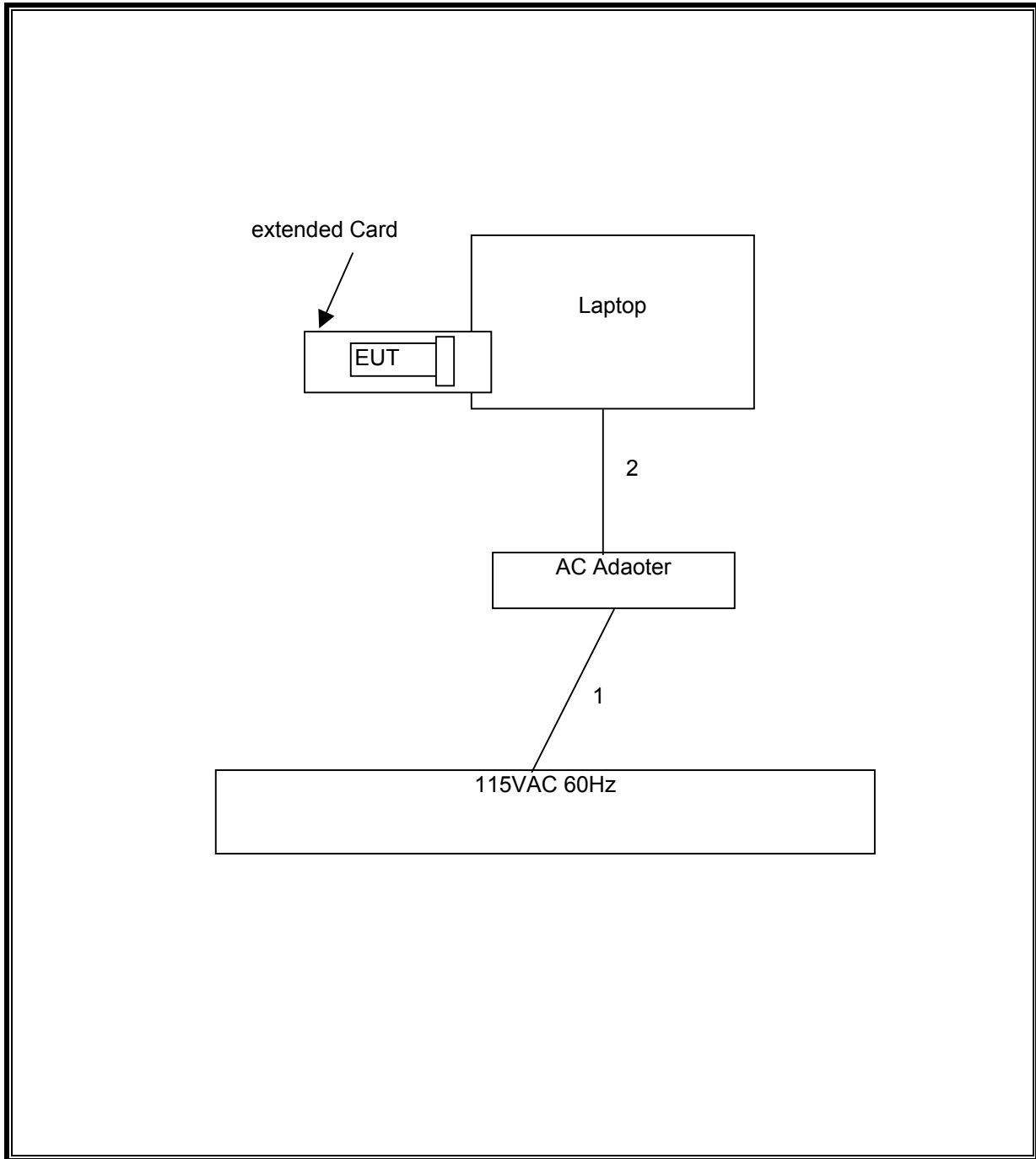

6. TEST AND MEASUREMENT EQUIPMENT

The following test and measurement equipment was utilized for the tests documented in this report:

TEST EQUIPMENT LIST				
Description	Manufacturer	Model	Serial Number	Cal Due
Antenna, Horn 1 ~ 18 GHz	EMCO	3115	6717	4/22/2007
Antenna, Horn, 18 ~ 26 GHz	ARA	MWH-1826/B	1013	9/12/2006
Preamplifier, 1 ~ 26.5 GHz	Agilent / HP	8449B	3008A00369	8/17/2006
Antenna, Horn 26 ~ 40 GHz	ARA	MWH-2640/B	1029	4/13/2007
Preamplifier, 26 ~ 40 GHz	Miteq	NSP4000-SP2	924343	8/18/2006
Spectrum Analyzer 3 Hz ~ 44 GHz	Agilent / HP	E4446A	MY45300064	12/19/2006
Peak / Average Power Sensor	Agilent / HP	E9327A	US40440755	12/2/2007
Peak Power Meter	Agilent / HP	E4416A	GB41291160	12/2/2007
Spectrum Analyzer 3 Hz ~ 44 GHz	Agilent / HP	E4446A	US42070220	7/29/2006
Vector Signal Generator 250kHz-20GHz	Agilent / HP	E8267C	US43320336	11/2/2007

7. LIMITS AND RESULTS

7.1. CHANNEL TESTS FOR THE 5470 TO 5725 MHz BAND

7.1.1. EMISSION BANDWIDTH

LIMIT

§15.403 (i) Emission bandwidth. For purposes of this subpart the emission bandwidth shall be determined by measuring the width of the signal between two points, one below the carrier center frequency and one above the carrier center frequency, that are 26 dB down relative to the maximum level of the modulated carrier. Determination of the emissions bandwidth is based on the use of measurement instrumentation employing a peak detector function with an instrument resolutions bandwidth approximately equal to 1.0 percent of the emission bandwidth of the device under measurement.

TEST PROCEDURE

The transmitter output is connected to a spectrum analyzer. The RBW is set to 1% to 3% of the 26 dB bandwidth. The VBW is set to 3 times the RBW. The sweep time is coupled.

RESULTS

No non-compliance noted:

802.11a Mode

Channel	Frequency (MHz)	B (MHz)	10 Log B (dB)
Low	5500	20.93	13.21
Mid	5600	22.63	13.55
High	5700	28.48	14.55

802.11a Turbo Mode

Channel	Frequency (MHz)	B (MHz)	10 Log B (dB)
Low	5540	37.44	15.73
Middle	5620	42.00	16.23
High	5660	46.92	16.71

26 dB EMISSION BANDWIDTH (802.11a MODE)

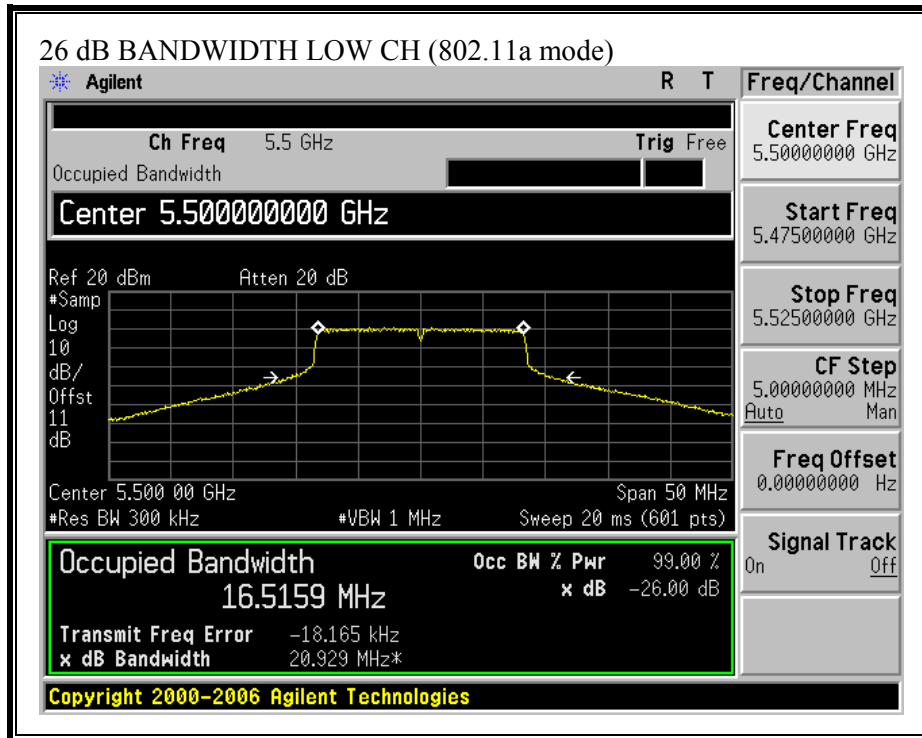

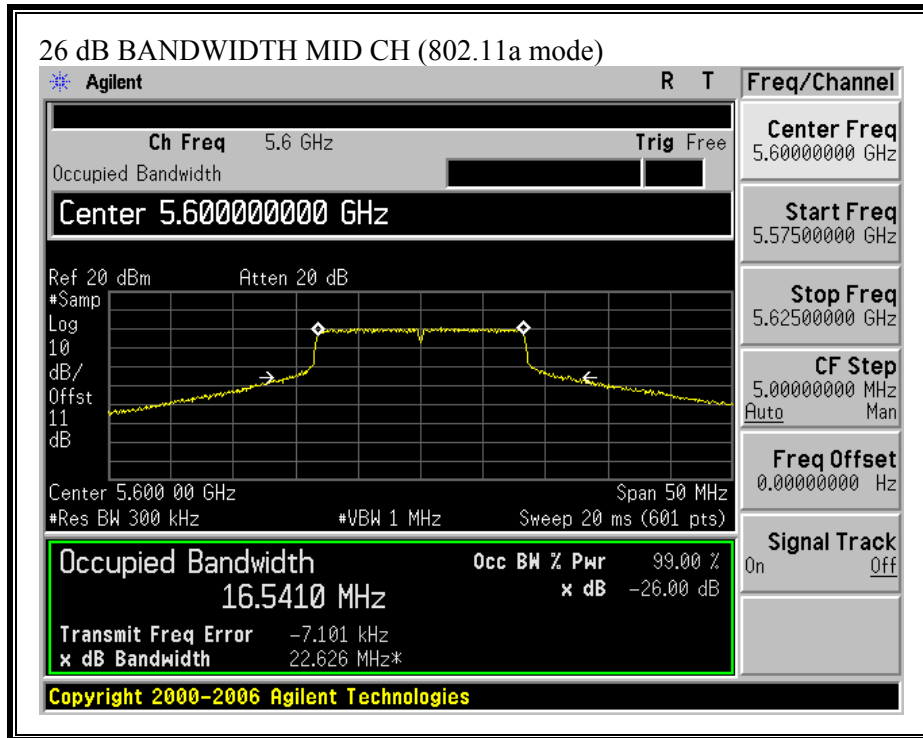

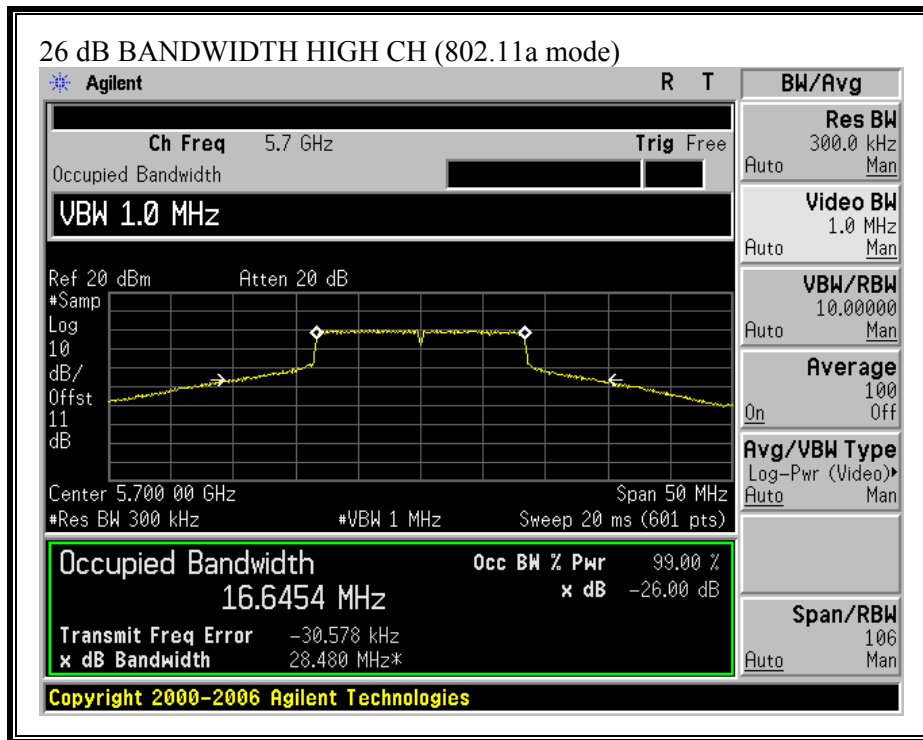

26 dB EMISSION BANDWIDTH (802.11a TURBO MODE)

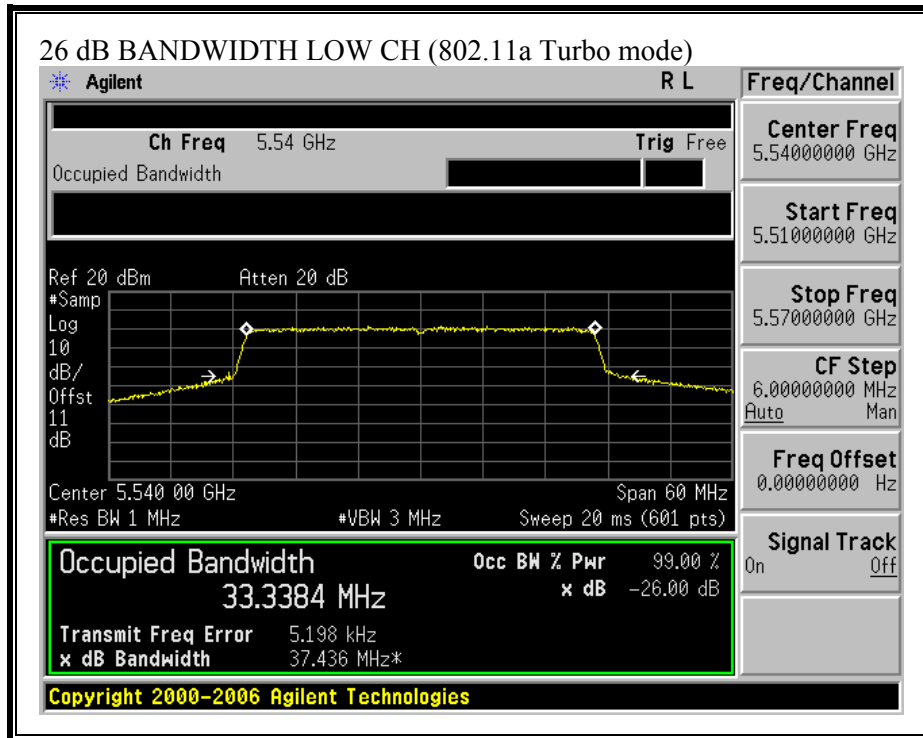

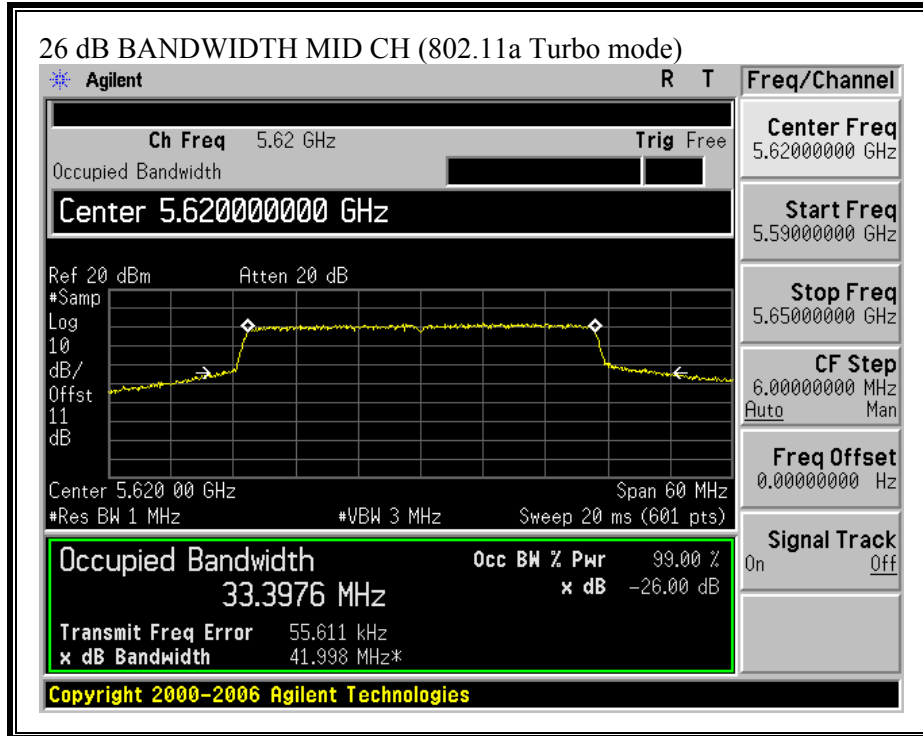

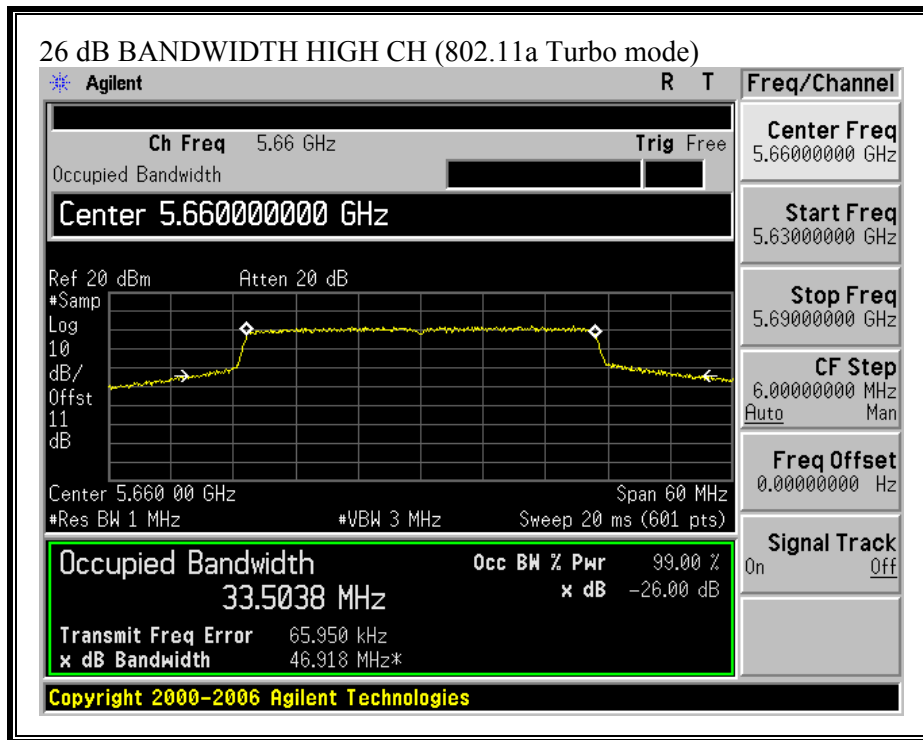

7.1.2. MAXIMUM POWER

LIMIT

§15.407 (a) (2) For the 5.47–5.725 GHz band, the peak transmit power over the frequency band of operation shall not exceed the lesser of 250 mW or $11 \text{ dBm} + 10 \log B$, where B is the 26-dB emission bandwidth in MHz. If transmitting antennas of directional gain greater than 6 dBi are used, both the peak transmit power and the peak power spectral density shall be reduced by the amount in dB that the directional gain of the antenna exceeds 6 dBi.

TEST PROCEDURE

The test is performed in accordance with FCC Public Notice: APPENDIX A Guidelines for Assessing Unlicensed National Information Infrastructure (U-NII) Devices – Part 15, Subpart E, August 2002.

The transmitter output operates continuously therefore Method # 1 is used.

NORMAL MODE LIMITS AND RESULTS

No non-compliance noted:

Limit

Channel	Frequency (MHz)	Fixed Limit (dBm)	B (MHz)	11 + 10 Log B Limit (dBm)	Antenna Gain (dBi)	Limit (dBm)
Low	5500	24	20.93	24.21	5.30	24.00
Mid	5600	24	22.63	24.55	5.30	24.00
High	5700	24	28.48	25.55	5.30	24.00

Results

Channel	Frequency (MHz)	Power (dBm)	Limit (dBm)	Margin (dB)
Low	5500	17.74	24.00	-6.26
Mid	5600	17.80	24.00	-6.20
High	5700	17.77	24.00	-6.23

TURBO MODE LIMITS AND RESULTS

No non-compliance noted:

Limit

Channel	Frequency (MHz)	Fixed Limit (dBm)	B (MHz)	11 + 10 Log B Limit (dBm)	Antenna Gain (dBi)	Limit (dBm)
Low	5540	24	37.44	26.73	5.30	24.00
Mid	5620	24	42.00	27.23	5.30	24.00
High	5660	24	46.92	27.71	5.30	24.00

Results

Channel	Frequency (MHz)	Power (dBm)	Limit (dBm)	Margin (dB)
Low	5540	17.65	24.00	-6.35
Mid	5620	17.70	24.00	-6.30
High	5660	17.62	24.00	-6.38

PEAK POWER (802.11a MODE)

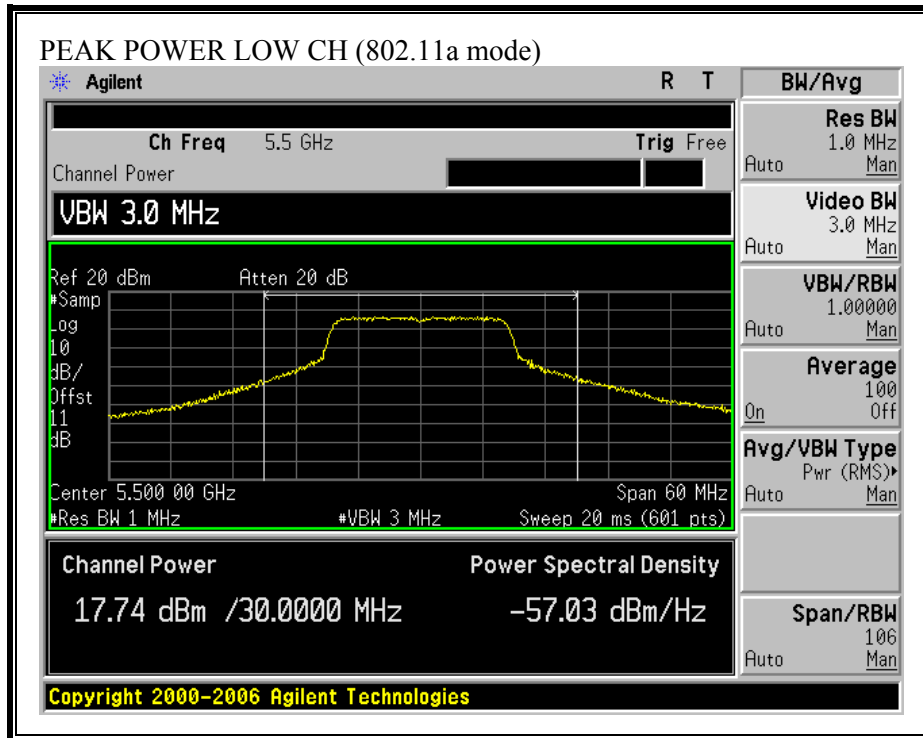

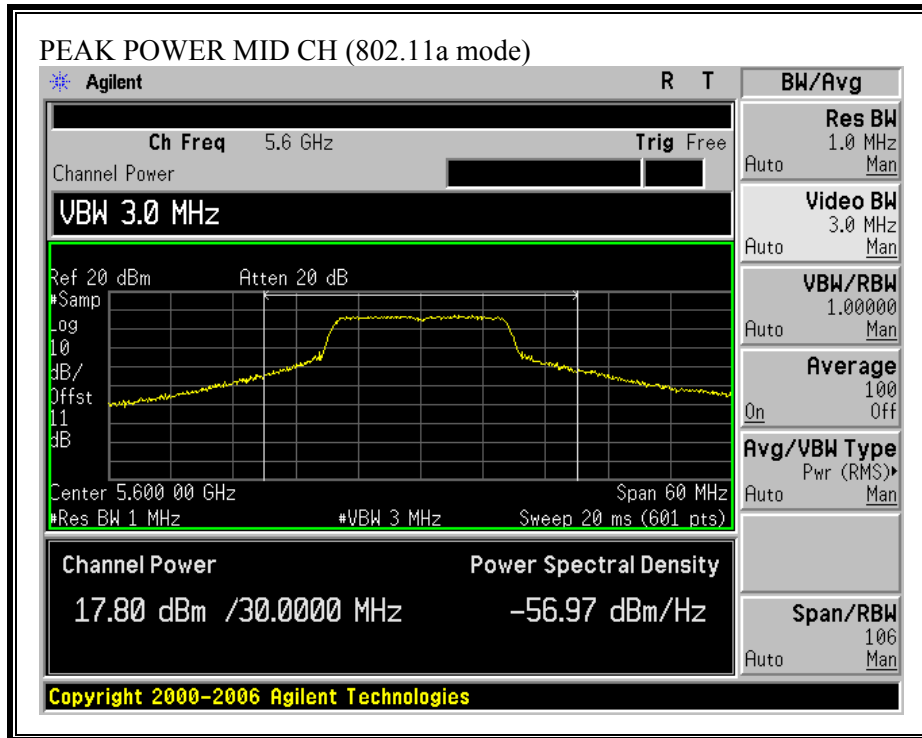

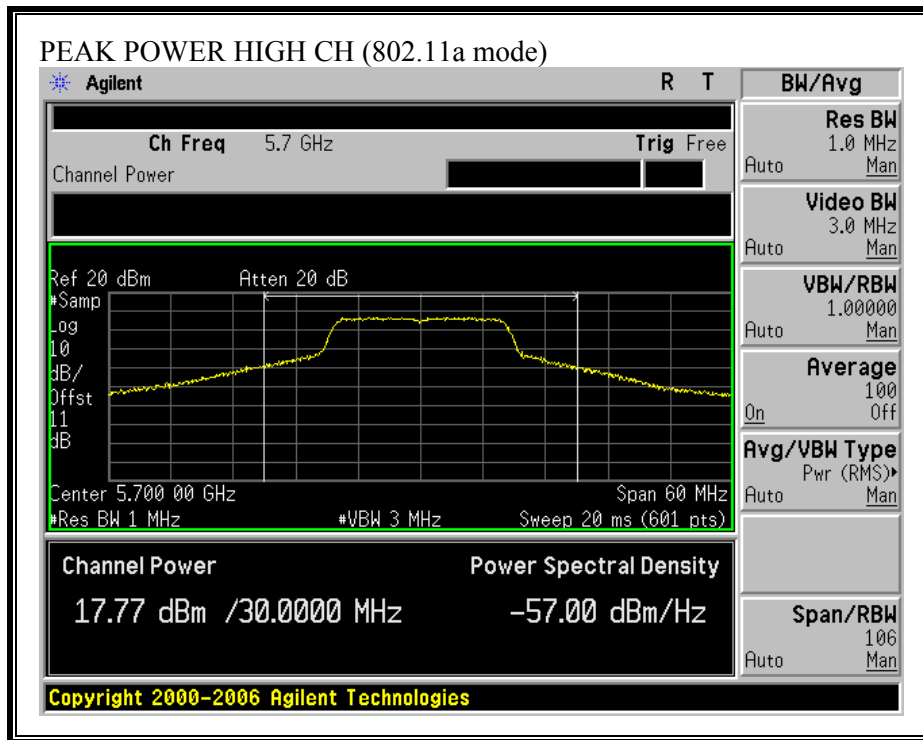

PEAK POWER (802.11a TURBO MODE)

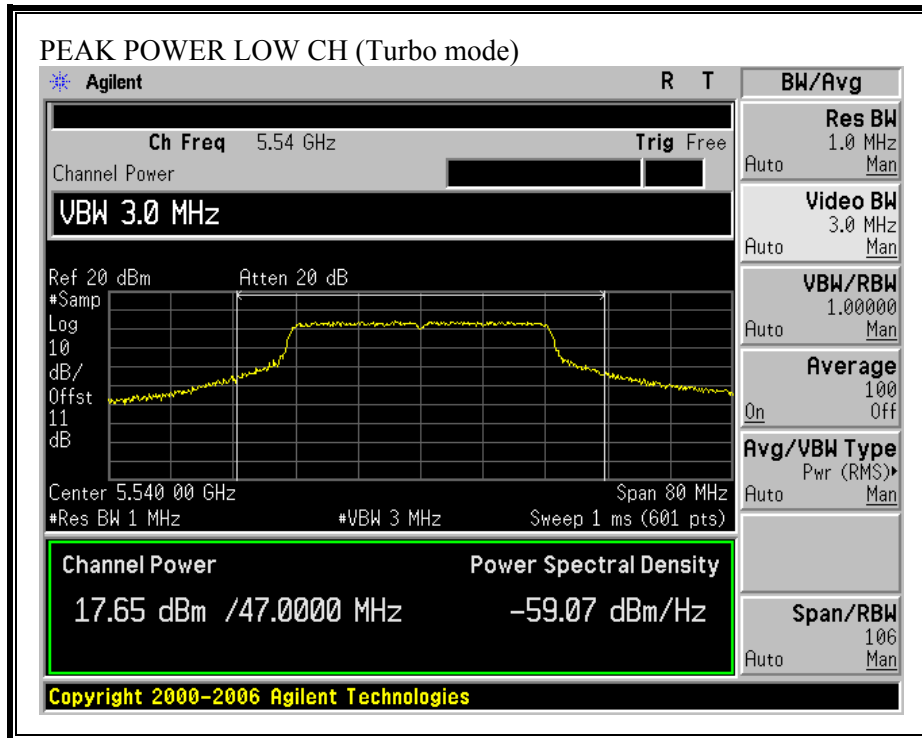

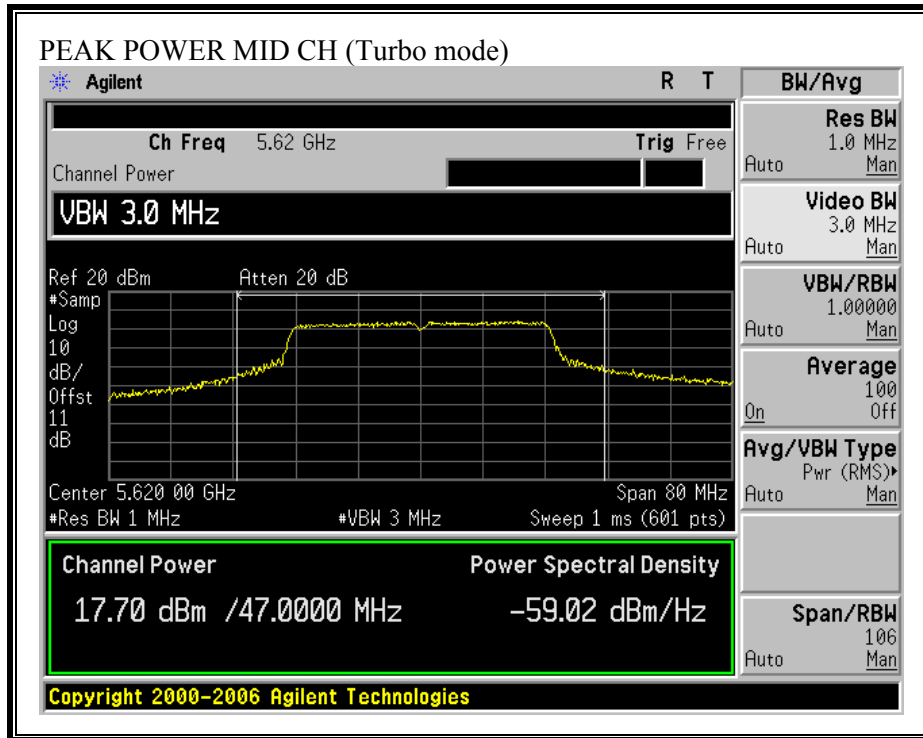

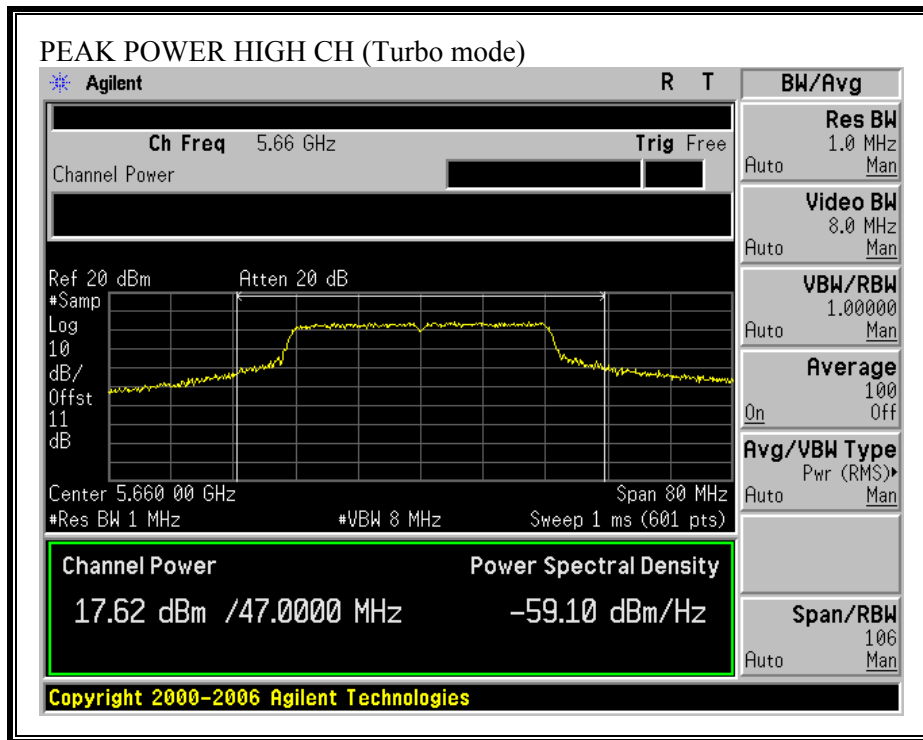

7.1.3. AVERAGE POWER

AVERAGE POWER LIMIT

None; for reporting purposes only.

TEST PROCEDURE

The transmitter output is connected to a power meter.

RESULTS

No non-compliance noted:

The cable assembly insertion loss of 11 dB (including 10 dB pad and 1 dB cable) was entered as an offset in the power meter to allow for direct reading of power.

802.11a Mode

Channel	Frequency (MHz)	Average Power (dBm)
Low	5500	17.72
Mid	5600	17.80
High	5700	17.62

802.11a Turbo Mode

Channel	Frequency (MHz)	Average Power (dBm)
Low	5540	17.64
Middle	5620	17.67
High	5660	17.60

7.1.4. PEAK POWER SPECTRAL DENSITY

LIMIT

§15.407 (a) (2) For the 5.47–5.725 GHz band, the peak power spectral density shall not exceed 11 dBm in any 1-MHz band. If transmitting antennas of directional gain greater than 6 dBi are used, both the peak transmit power and the peak power spectral density shall be reduced by the amount in dB that the directional gain of the antenna exceeds 6 dBi.

The maximum antenna gain = 5.3 dBi, therefore there is no reduction due to antenna gain.

TEST PROCEDURE

The test is performed in accordance with FCC Public Notice: APPENDIX A Guidelines for Assessing Unlicensed National Information Infrastructure (U-NII) Devices – Part 15, Subpart E, August 2002. PPSD method #2 was used.

RESULTS

No non-compliance noted:

802.11a Mode

Channel	Frequency (MHz)	PPSD (dBm)	Limit (dBm)	Margin (dB)
Low	5500	6.42	11.00	-4.58
Mid	5600	7.09	11.00	-3.91
High	5700	7.09	11.00	-3.91

802.11a Turbo Mode

Channel	Frequency (MHz)	PPSD (dBm)	Limit (dBm)	Margin (dB)
Low	5540	3.81	11.00	-7.19
Middle	5620	4.26	11.00	-6.74
High	5660	4.31	11.00	-6.69

PEAK POWER SPECTRAL DENSITY (802.11a MODE)

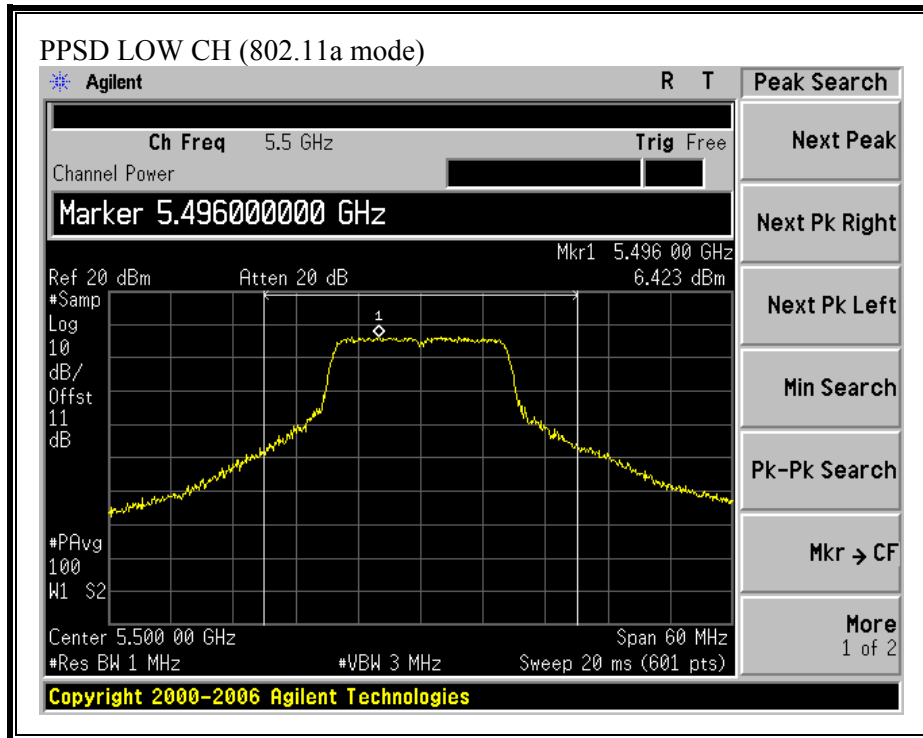

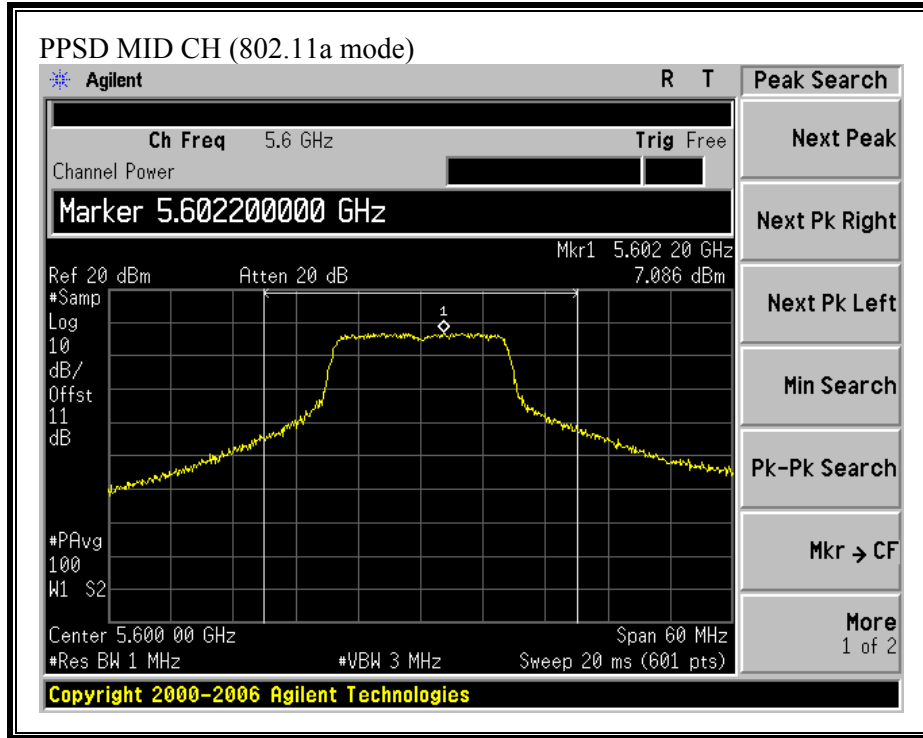

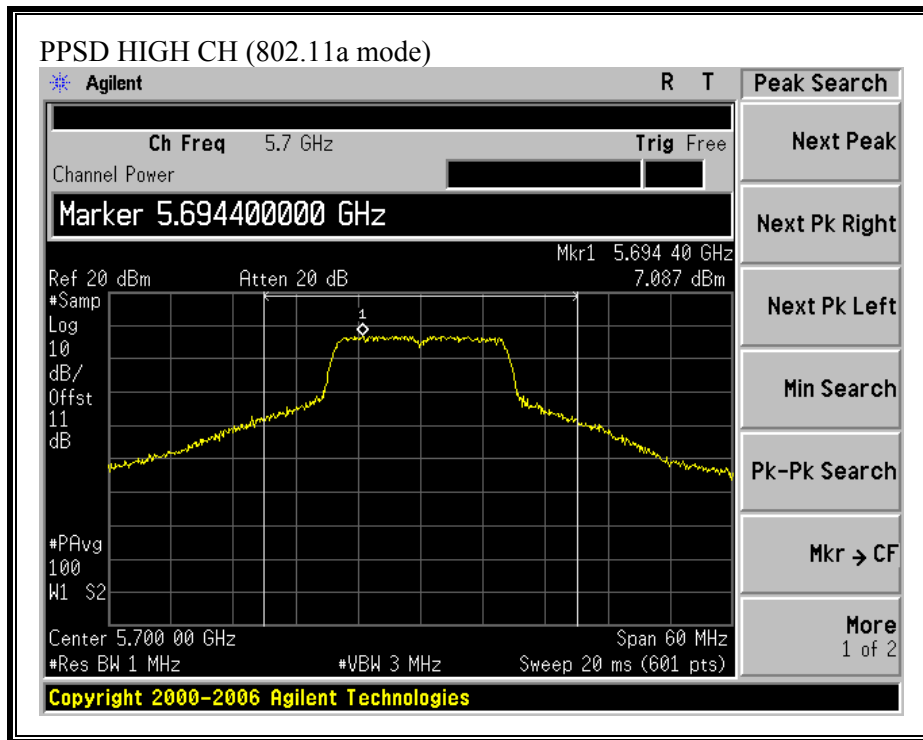

PEAK POWER SPECTRAL DENSITY (802.11a TURBO MODE)

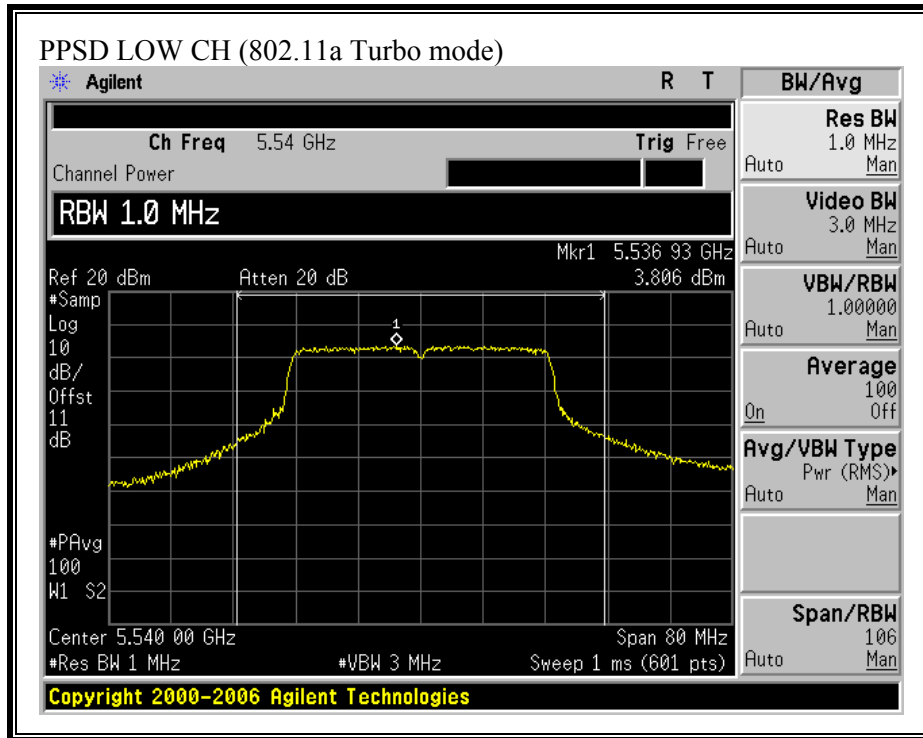

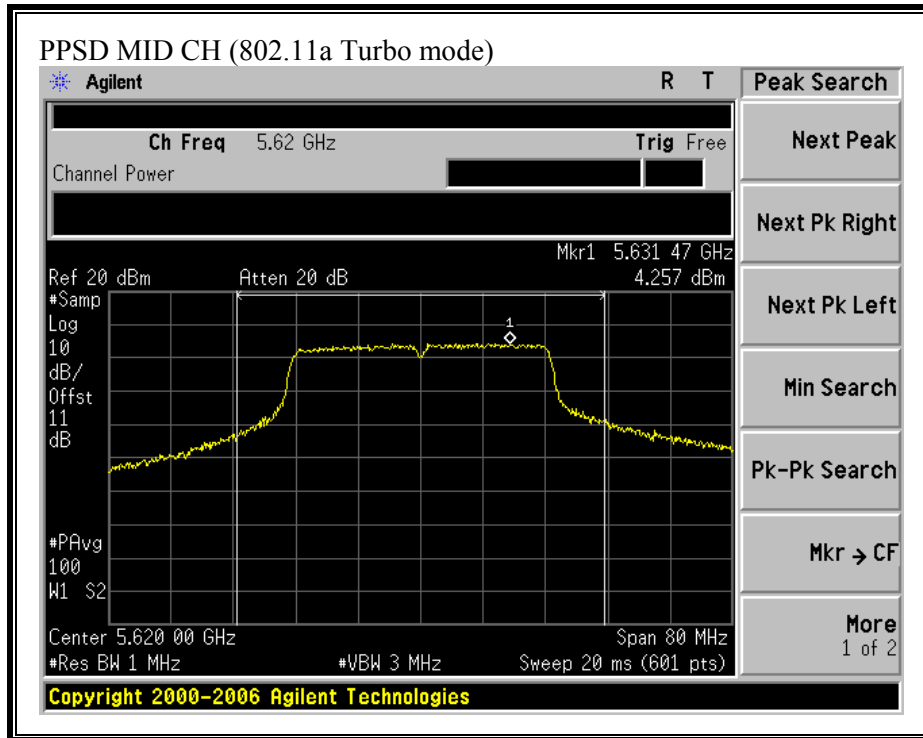

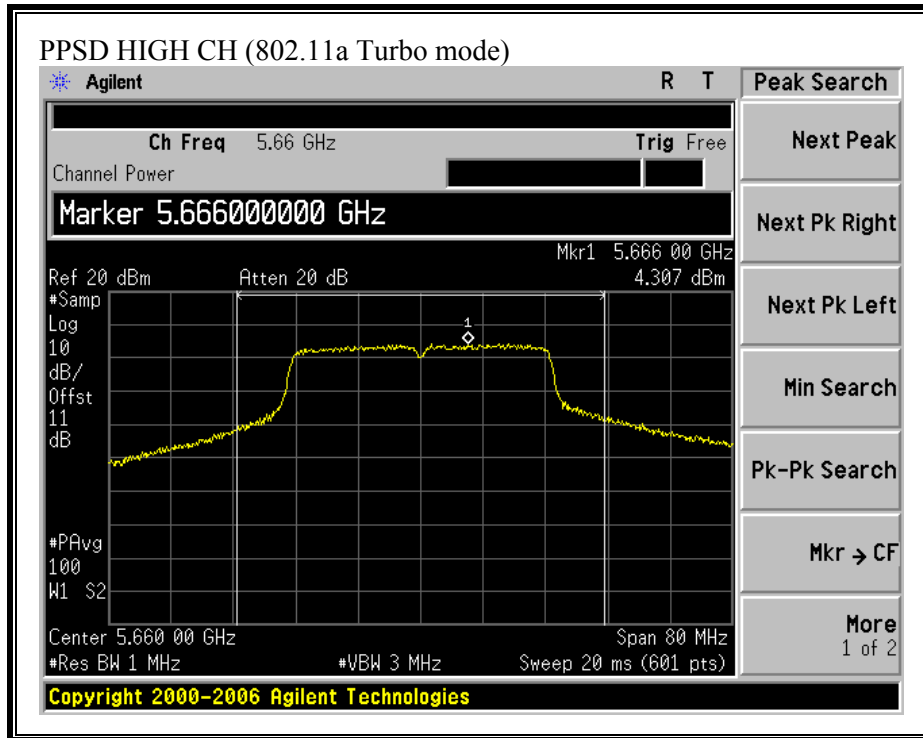

7.1.5. PEAK EXCURSION

LIMIT

§15.407 (a) (6) The ratio of the peak excursion of the modulation envelope (measured using a peak hold function) to the peak transmit power (measured as specified above) shall not exceed 13 dB across any 1 MHz bandwidth or the emission bandwidth whichever is less.

TEST PROCEDURE

The test is performed in accordance with FCC Public Notice: APPENDIX A Guidelines for Assessing Unlicensed National Information Infrastructure (U-NII) Devices – Part 15, Subpart E, August 2002.

Since Method # 1 was used for peak power measurements, Method # 1 settings are used for the second Peak Excursion trace.

RESULTS

No non-compliance noted:

802.11a Mode

Channel	Frequency (MHz)	Peak Excursion (dB)	Limit (dB)	Margin (dB)
Low	5500	9.61	13	-3.39
Mid	5600	8.15	13	-4.85
High	5700	9.04	13	-3.96

802.11a Turbo Mode

Channel	Frequency (MHz)	Peak Excursion (dB)	Limit (dB)	Margin (dB)
Low	5540	9.34	13	-3.66
Middle	5620	8.01	13	-4.99
High	5660	9.33	13	-3.67

PEAK EXCURSION (802.11a MODE)

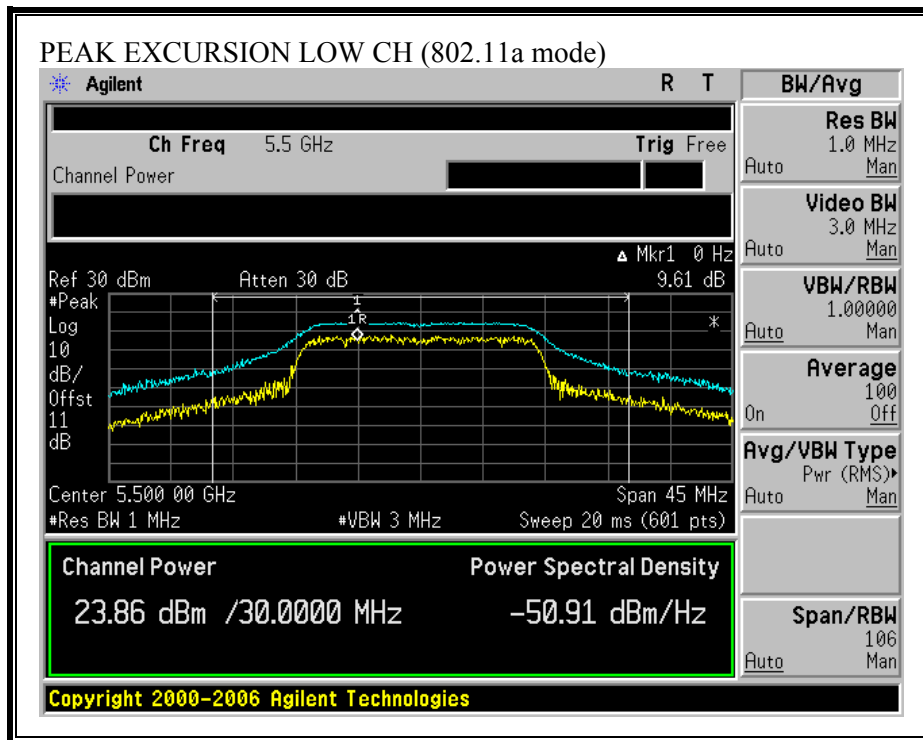

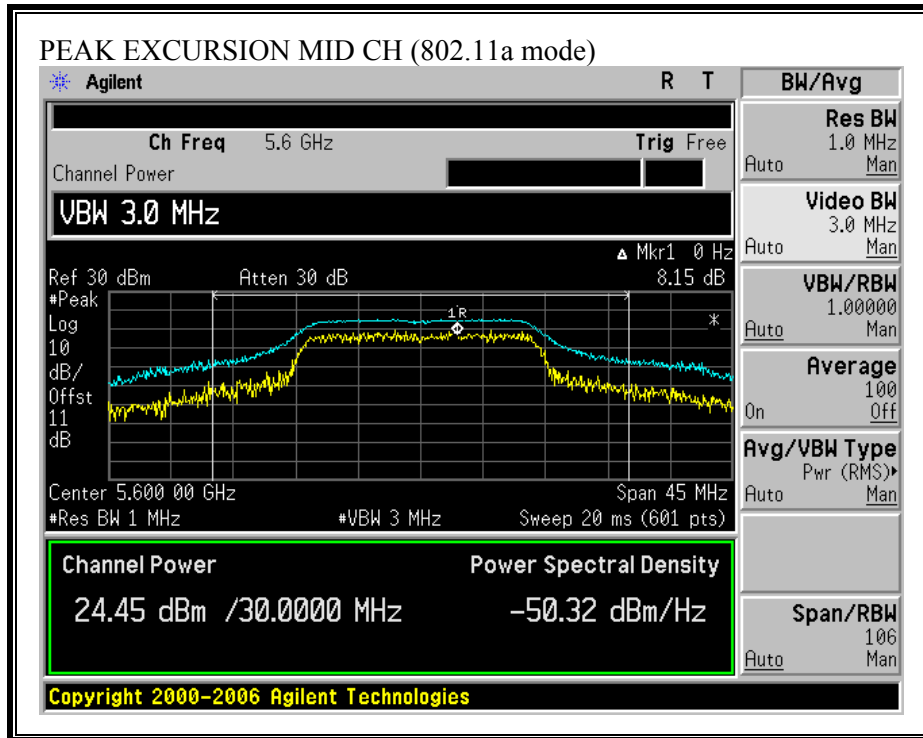

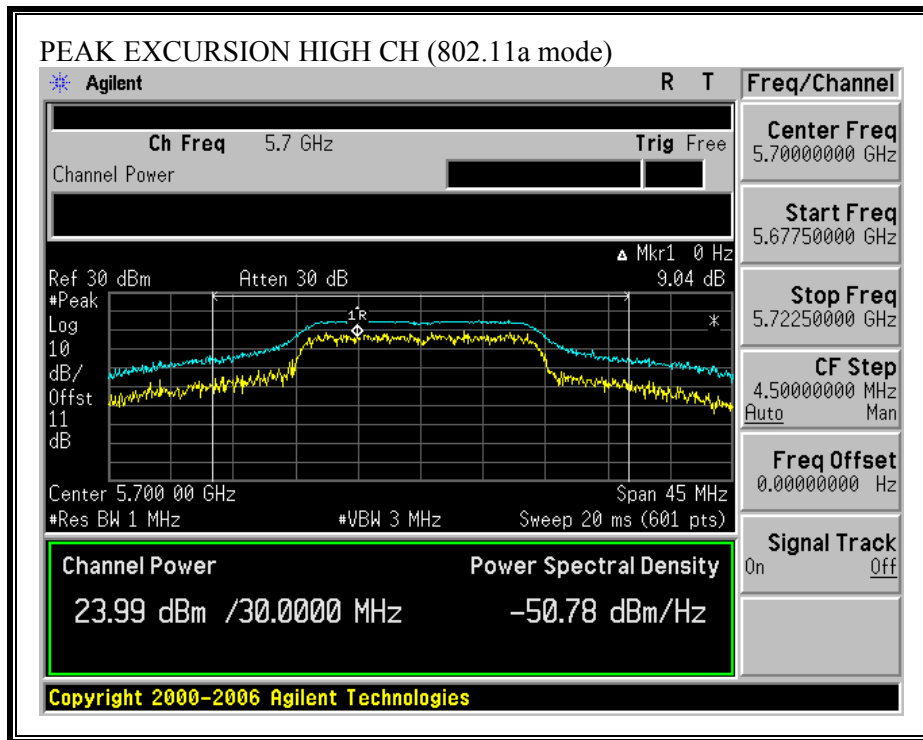

PEAK EXCURSION (802.11a TURBO MODE)

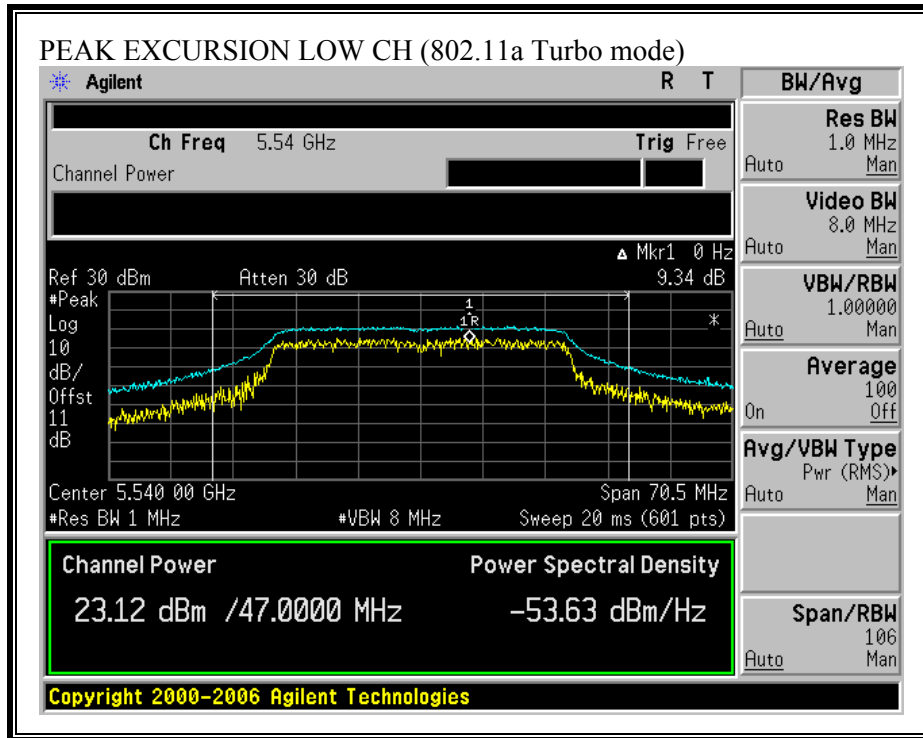

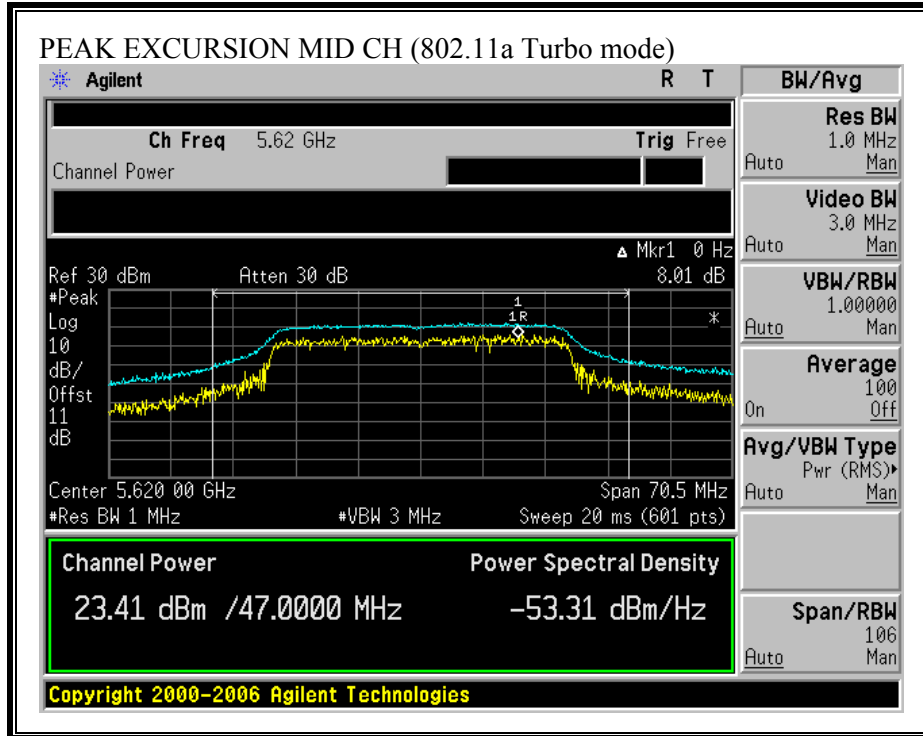

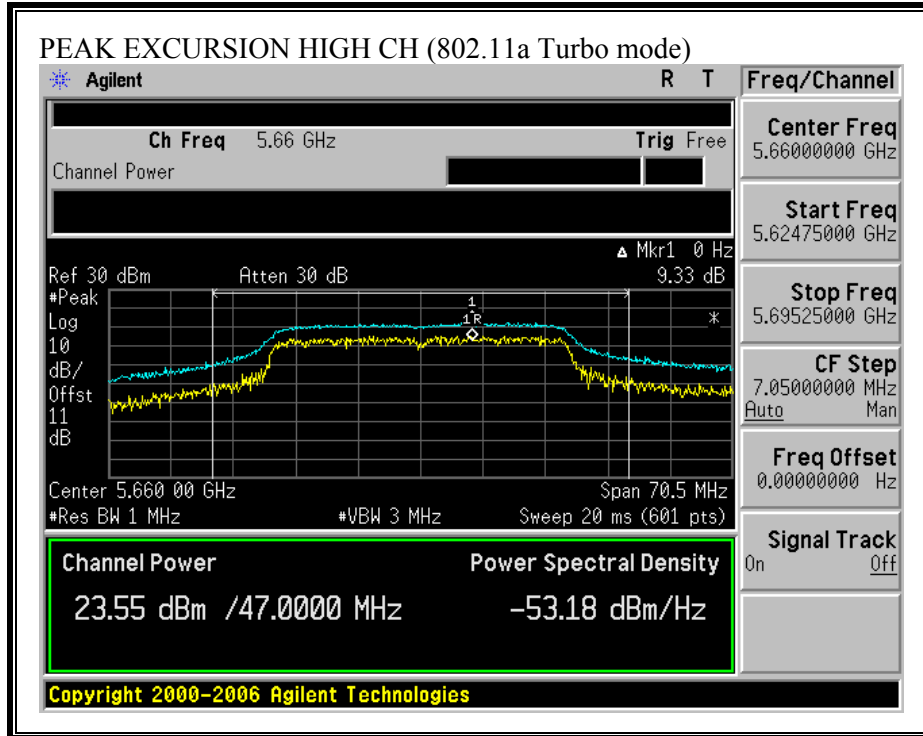

7.1.6. CONDUCTED SPURIOUS EMISSIONS

LIMITS

§15.407 (b) (3) For transmitters operating in the 5.47–5.725 GHz band: all emissions outside of the 5.47–5.725 GHz band shall not exceed an EIRP of -27 dBm / MHz.

TEST PROCEDURE

Conducted RF measurements of the transmitter output are made to confirm that the EUT antenna port conducted emissions meet the specified limit and to identify any spurious signals that require further investigation or measurements on the radiated emissions site.

The transmitter output is connected to the spectrum analyzer. The resolution bandwidth is set to 1 MHz. The video bandwidth is set to 1 MHz. Peak detection measurements are compared to the average EIRP limit, adjusted for the maximum antenna gain. If necessary, additional average detection measurements are made.

Measurements are made over the 30 MHz to 40 GHz range with the transmitter set to the lowest, middle, and highest channels.

RESULTS

No non-compliance noted:

SPURIOUS EMISSIONS (802.11a MODE)

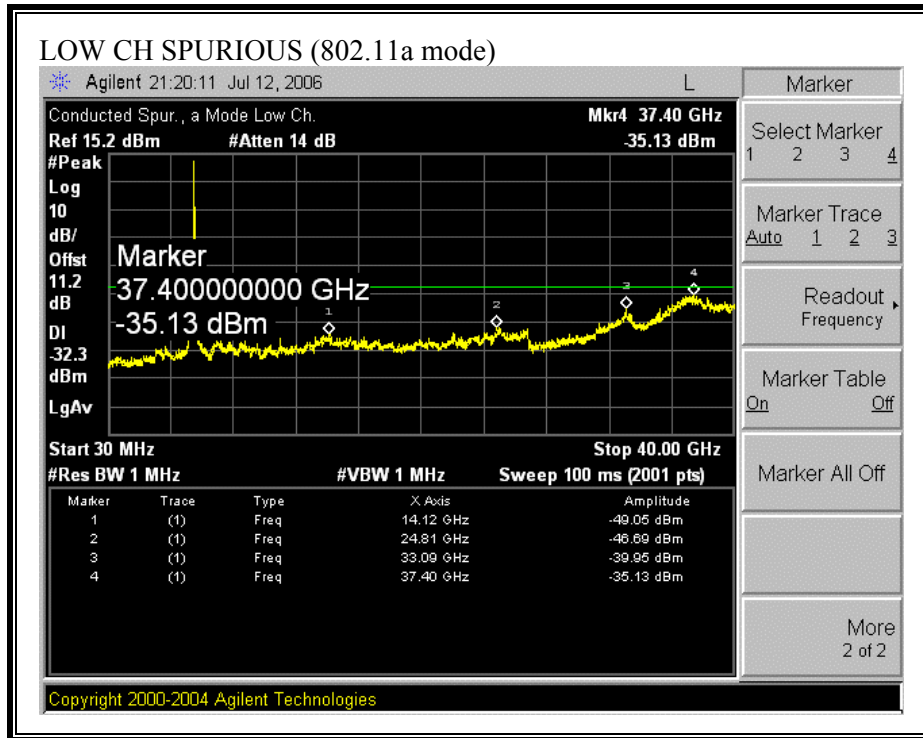

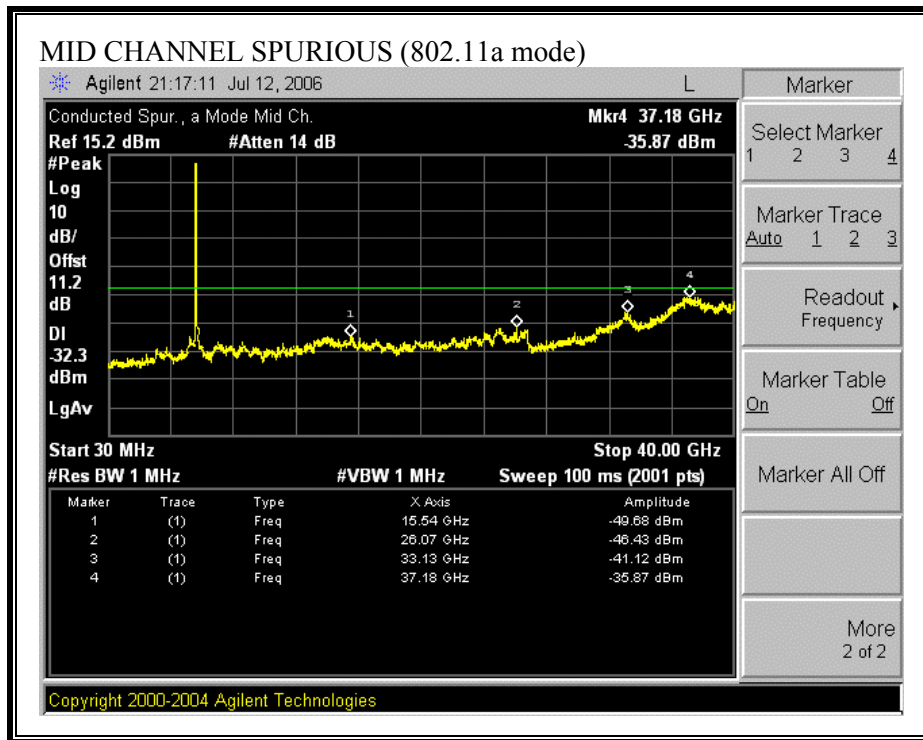

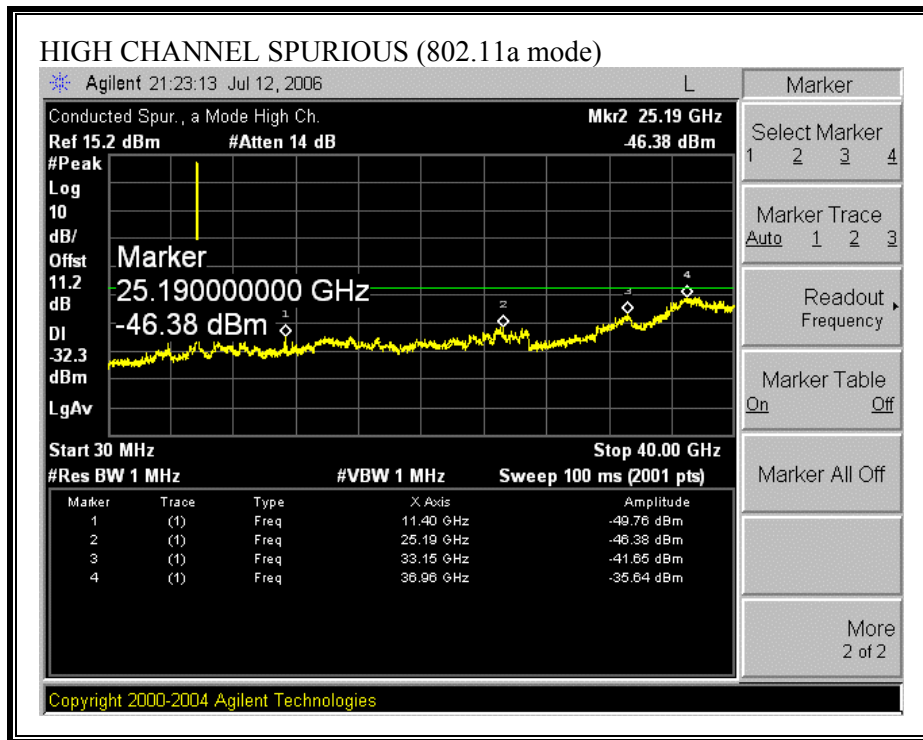

SPURIOUS EMISSIONS (802.11a TURBO MODE)

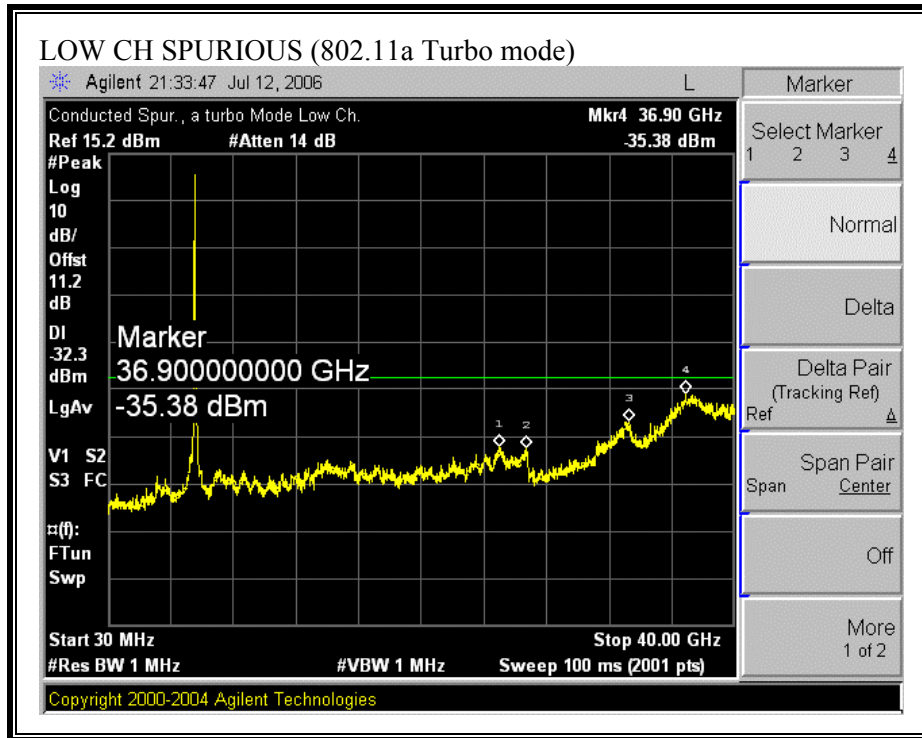

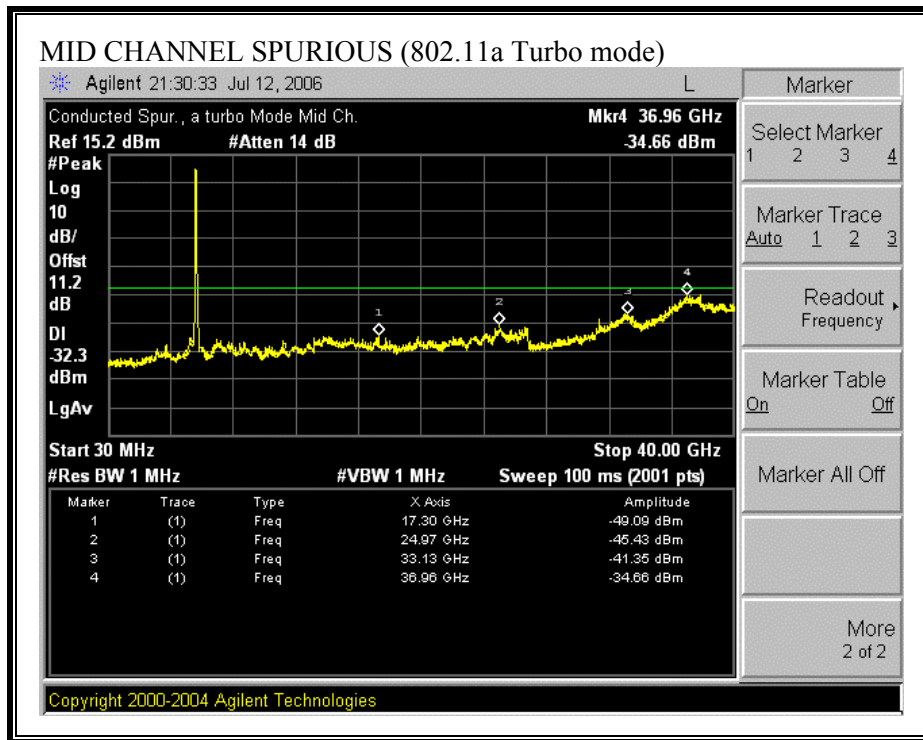

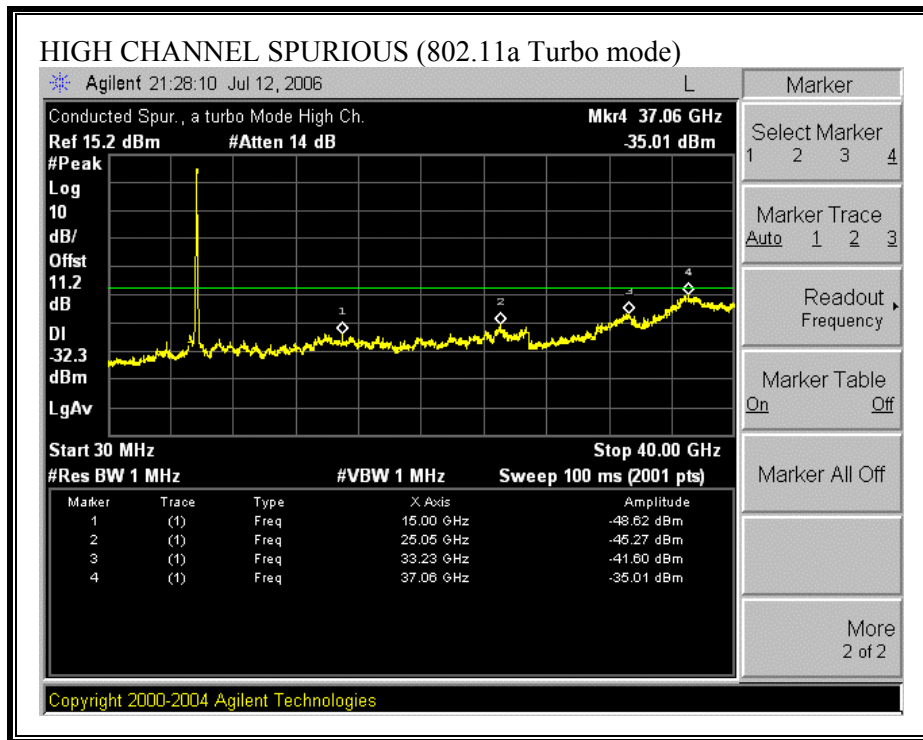

7.1.7. MAXIMUM PERMISSIBLE EXPOSURE

LIMITS

§1.1310 The criteria listed in Table 1 shall be used to evaluate the environmental impact of human exposure to radio-frequency (RF) radiation as specified in §1.1307(b), except in the case of portable devices which shall be evaluated according to the provisions of §2.1093 of this chapter.

TABLE 1—LIMITS FOR MAXIMUM PERMISSIBLE EXPOSURE (MPE)

Frequency range (MHz)	Electric field strength (V/m)	Magnetic field strength (A/m)	Power density (mW/cm ²)	Averaging time (minutes)
(A) Limits for Occupational/Controlled Exposures				
0.3–3.0	614	1.63	*(100)	6
3.0–30	1842/f	4.89/f	*(900/f ²)	6
30–300	61.4	0.163	1.0	6
300–1500	f/300	6
1500–100,000	5	6
(B) Limits for General Population/Uncontrolled Exposure				
0.3–1.34	614	1.63	*(100)	30
1.34–30	824/f	2.19/f	*(180/f ²)	30

TABLE 1—LIMITS FOR MAXIMUM PERMISSIBLE EXPOSURE (MPE)—Continued

Frequency range (MHz)	Electric field strength (V/m)	Magnetic field strength (A/m)	Power density (mW/cm ²)	Averaging time (minutes)
30–300	27.5	0.073	0.2	30
300–1500	f/1500	30
1500–100,000	1.0	30

f = frequency in MHz

* = Plane-wave equivalent power density

NOTE 1 TO TABLE 1: Occupational/controlled limits apply in situations in which persons are exposed as a consequence of their employment provided those persons are fully aware of the potential for exposure and can exercise control over their exposure. Limits for occupational/controlled exposure also apply in situations when an individual is transient through a location where occupational/controlled limits apply provided he or she is made aware of the potential for exposure.

NOTE 2 TO TABLE 1: General population/uncontrolled exposures apply in situations in which the general public may be exposed, or in which persons that are exposed as a consequence of their employment may not be fully aware of the potential for exposure or can not exercise control over their exposure.

CALCULATIONS

Given

$$E = \sqrt{(30 * P * G) / d}$$

and

$$S = E^2 / 3770$$

where

E = Field Strength in Volts/meter

P = Power in Watts

G = Numeric antenna gain

d = Distance in meters

S = Power Density in milliwatts/square centimeter

Combining equations and rearranging the terms to express the distance as a function of the remaining variables yields:

$$d = \sqrt{((30 * P * G) / (3770 * S))}$$

Changing to units of Power to mW and Distance to cm, using:

$$P \text{ (mW)} = P \text{ (W)} / 1000 \text{ and}$$

$$d \text{ (cm)} = 100 * d \text{ (m)}$$

yields

$$d = 100 * \sqrt{((30 * (P / 1000) * G) / (3770 * S))}$$

$$d = 0.282 * \sqrt{(P * G / S)}$$

where

d = distance in cm

P = Power in mW

G = Numeric antenna gain

S = Power Density in mW/cm²

Substituting the logarithmic form of power and gain using:

$$P \text{ (mW)} = 10^{(P \text{ (dBm)} / 10)} \text{ and}$$

$$G \text{ (numeric)} = 10^{(G \text{ (dBi)} / 10)}$$

yields

$$d = 0.282 * 10^{((P + G) / 20)} / \sqrt{S}$$

where

d = MPE distance in cm

P = Power in dBm

G = Antenna Gain in dBi

S = Power Density Limit in mW/cm²

Rearranging terms to calculate the power density at a specific distance yields

$$S = 0.0795 * 10^{((P + G) / 10)} / (d^2)$$

LIMITS

From §1.1310 Table 1 (B), the maximum value of $S = 1.0 \text{ mW/cm}^2$

RESULTS

No non-compliance noted:

Mode	MPE Distance (cm)	Output Power (dBm)	Antenna Gain (dBi)	Power Density (mW/cm²)
802.11a	20.0	17.80	5.30	0.04
802.11a Turbo	20.0	17.70	5.30	0.04

NOTE: For mobile or fixed location transmitters, the minimum separation distance is 20 cm, even if calculations indicate that the MPE distance would be less.

7.2. RADIATED EMISSIONS

7.2.1. TRANSMITTER RADIATED SPURIOUS EMISSIONS

LIMITS

§15.205 (a) Except as shown in paragraph (d) of this section, only spurious emissions are permitted in any of the frequency bands listed below:

MHz	MHz	MHz	GHz
0.090 - 0.110	16.42 - 16.423	399.9 - 410	4.5 - 5.15
¹ 0.495 - 0.505	16.69475 - 16.69525	608 - 614	5.35 - 5.46
2.1735 - 2.1905	16.80425 - 16.80475	960 - 1240	7.25 - 7.75
4.125 - 4.128	25.5 - 25.67	1300 - 1427	8.025 - 8.5
4.17725 - 4.17775	37.5 - 38.25	1435 - 1626.5	9.0 - 9.2
4.20725 - 4.20775	73 - 74.6	1645.5 - 1646.5	9.3 - 9.5
6.215 - 6.218	74.8 - 75.2	1660 - 1710	10.6 - 12.7
6.26775 - 6.26825	108 - 121.94	1718.8 - 1722.2	13.25 - 13.4
6.31175 - 6.31225	123 - 138	2200 - 2300	14.47 - 14.5
8.291 - 8.294	149.9 - 150.05	2310 - 2390	15.35 - 16.2
8.362 - 8.366	156.52475 - 156.52525	2483.5 - 2500	17.7 - 21.4
8.37625 - 8.38675	156.7 - 156.9	2655 - 2900	22.01 - 23.12
8.41425 - 8.41475	162.0125 - 167.17	3260 - 3267	23.6 - 24.0
12.29 - 12.293	167.72 - 173.2	3332 - 3339	31.2 - 31.8
12.51975 - 12.52025	240 - 285	3345.8 - 3358	36.43 - 36.5
12.57675 - 12.57725	322 - 335.4	3600 - 4400	(²)
13.36 - 13.41			

¹ Until February 1, 1999, this restricted band shall be 0.490-0.510 MHz.

² Above 38.6

§15.205 (b) Except as provided in paragraphs (d) and (e), the field strength of emissions appearing within these frequency bands shall not exceed the limits shown in Section 15.209. At frequencies equal to or less than 1000 MHz, compliance with the limits in Section 15.209 shall be demonstrated using measurement instrumentation employing a CISPR quasi-peak detector. Above 1000 MHz, compliance with the emission limits in Section 15.209 shall be demonstrated based on the average value of the measured emissions. The provisions in Section 15.35 apply to these measurements.

§15.209 (a) Except as provided elsewhere in this Subpart, the emissions from an intentional radiator shall not exceed the field strength levels specified in the following table:

Frequency (MHz)	Field Strength (microvolts/meter)	Measurement Distance (meters)
30 - 88	100 **	3
88 - 216	150 **	3
216 - 960	200 **	3
Above 960	500	3

** Except as provided in paragraph (g), fundamental emissions from intentional radiators operating under this Section shall not be located in the frequency bands 54-72 MHz, 76-88 MHz, 174-216 MHz or 470-806 MHz. However, operation within these frequency bands is permitted under other sections of this Part, e.g., Sections 15.231 and 15.241.

§15.209 (b) In the emission table above, the tighter limit applies at the band edges.

TEST PROCEDURE

The EUT is placed on a non-conducting table 80 cm above the ground plane. The antenna to EUT distance is 3 meters. The EUT is configured in accordance with ANSI C63.4. The EUT is set to transmit in a continuous mode.

For measurements below 1 GHz the resolution bandwidth is set to 100 kHz for peak detection measurements or 120 kHz for quasi-peak detection measurements. Peak detection is used unless otherwise noted as quasi-peak.

For measurements above 1 GHz the resolution bandwidth is set to 1 MHz, then the video bandwidth is set to 1 MHz for peak measurements and 10 Hz for average measurements.

The spectrum from 30 MHz to 40 GHz is investigated with the transmitter set to the lowest, middle, and highest channels in each band.

The frequency range of interest is monitored at a fixed antenna height and EUT azimuth. The EUT is rotated through 360 degrees to maximize emissions received. The antenna is scanned from 1 to 4 meters above the ground plane to further maximize the emission. Measurements are made with the antenna polarized in both the vertical and the horizontal positions.

REPORTING NOTES

The nearby restricted band stops 10 MHz below the authorized band. A single plot is taken to show both restricted band emission levels and out-of-band radiated spurious emission levels at and near the lower authorized bandedge. The out-of-band spurious limits of -7 dBm Peak EIRP and -27 dBm Average EIRP are converted to the equivalent 3 meter field strengths of 88.2 dBuV/m Peak and 68.2 dBuV/m Average, respectively, for reporting purposes.

The out-of- band radiated spurious emission levels at and near the upper authorized bandedge are reported as EIRP values.

7.2.2. TRANSMITTER ABOVE 1 GHZ FOR 5470 TO 5725 MHz BAND

RESTRICTED BANDEDGE (802.11a MODE, LOW CHANNEL, HORIZONTAL)

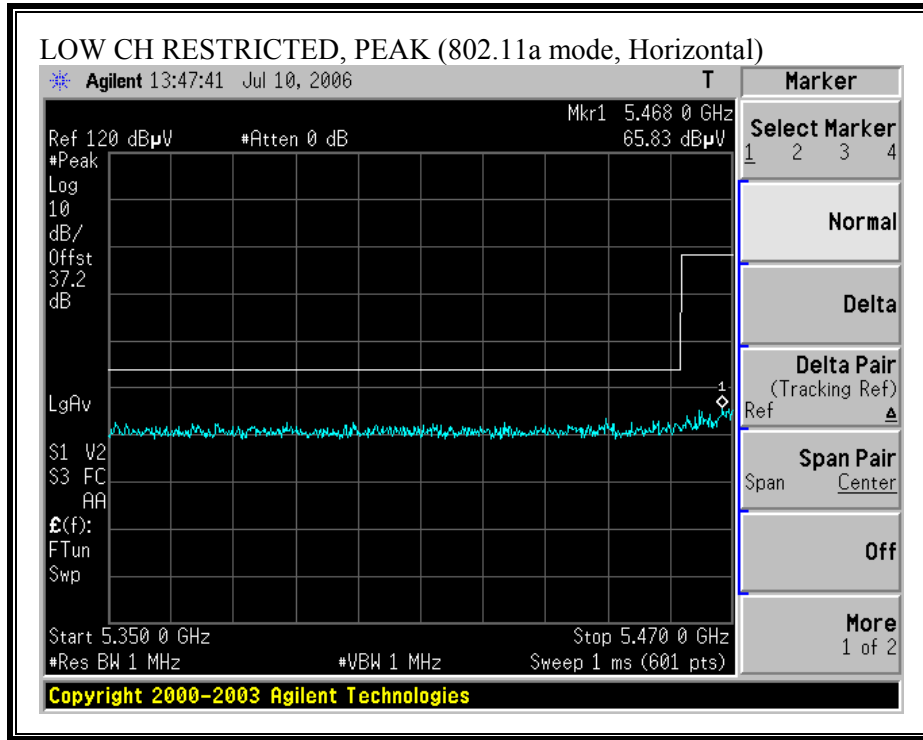

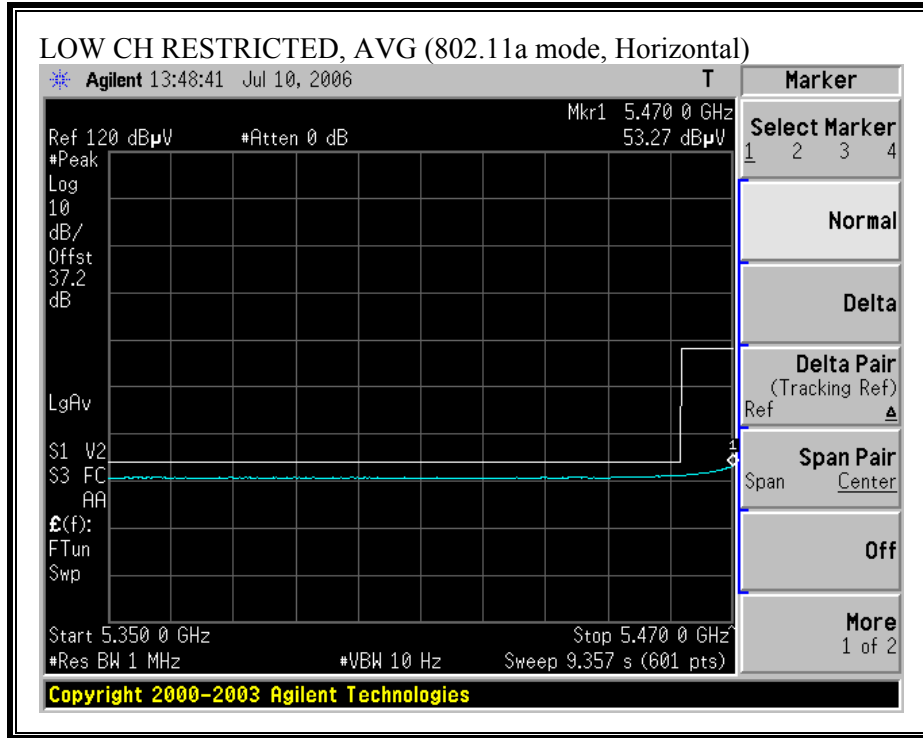

RESTRICTED BANDEDGE (802.11a MODE, LOW CHANNEL, VERTICAL)

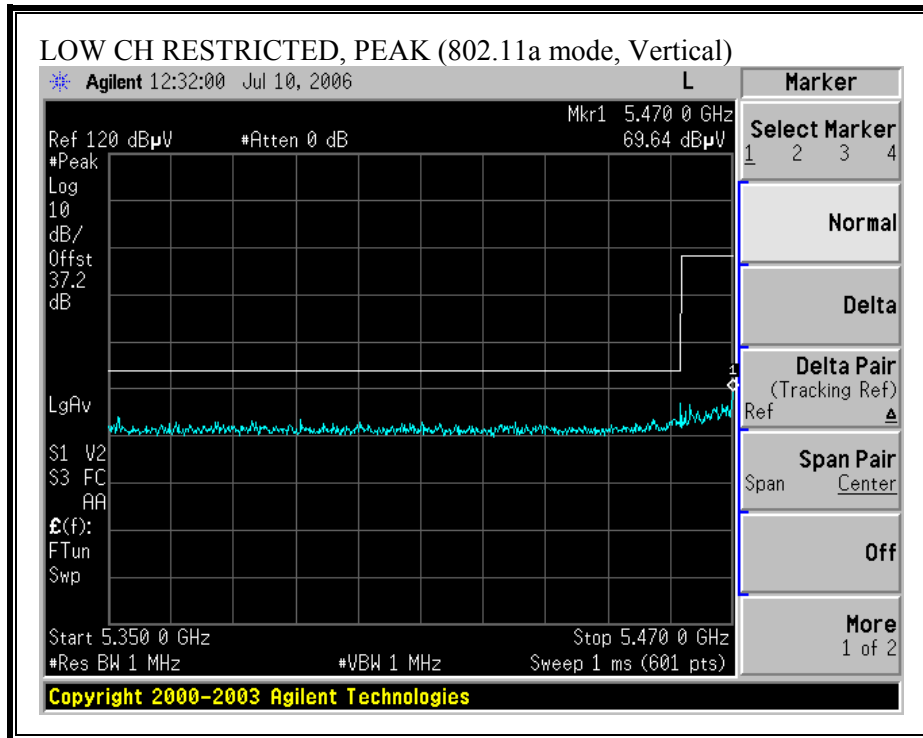

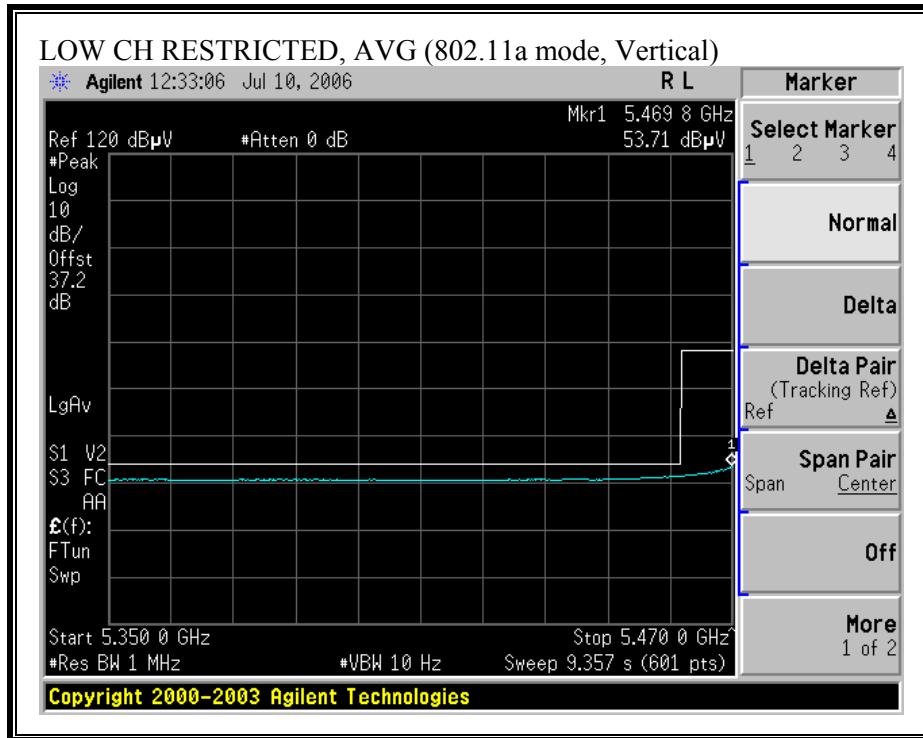

BANDEDGE (802.11a MODE, HIGH CHANNEL, HORIZONTAL)

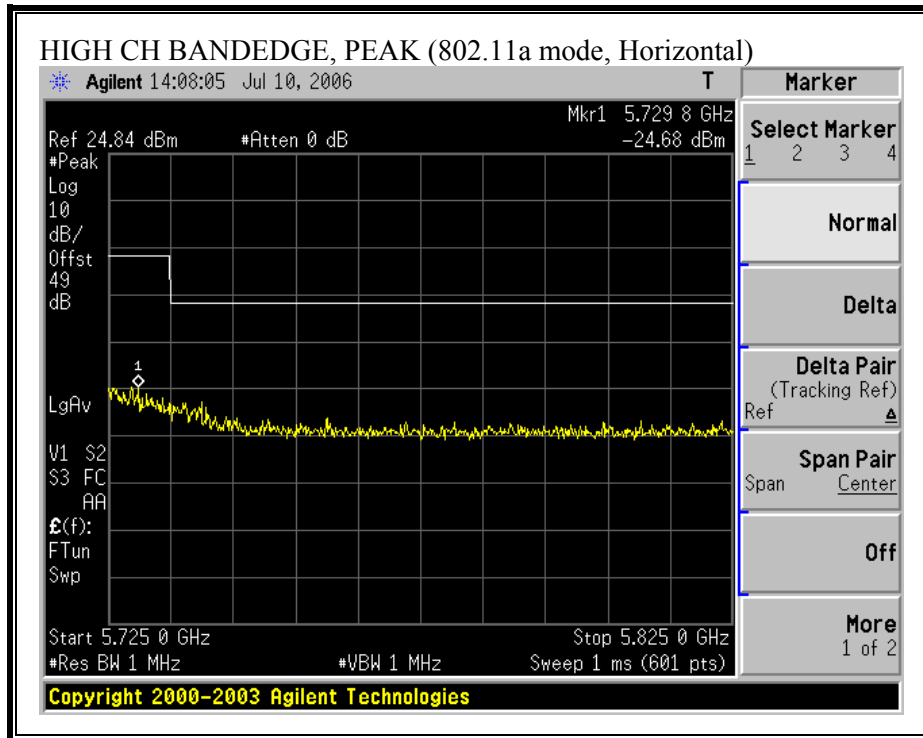

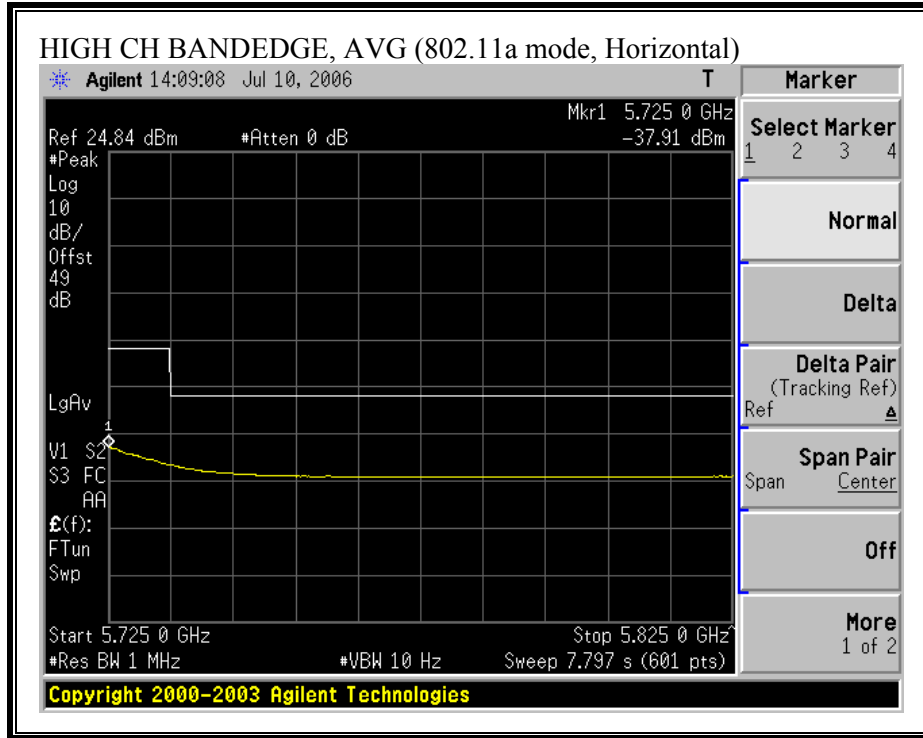

BANDEDGE (802.11a MODE, HIGH CHANNEL, VERTICAL)

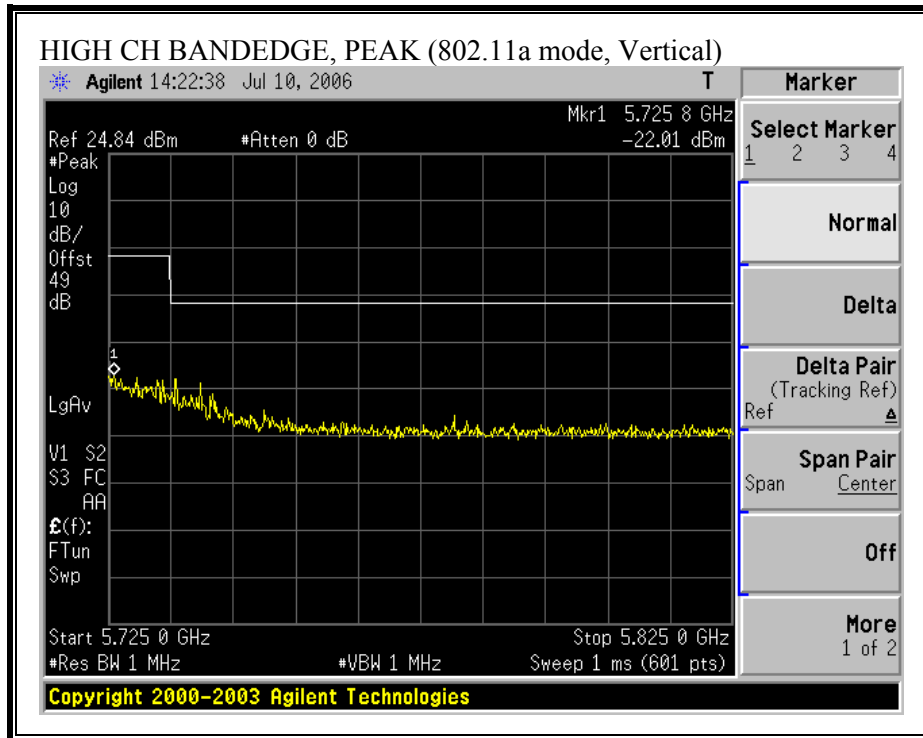

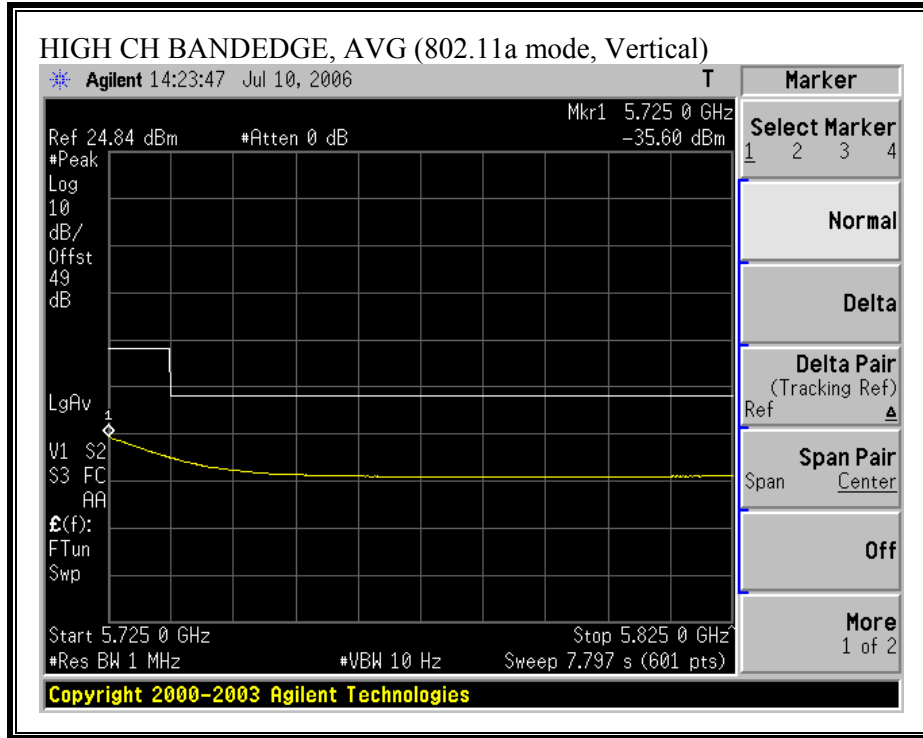

HARMONICS AND SPURIOUS EMISSIONS (802.11a MODE)

High Frequency Measurement
 Compliance Certification Services, Morgan Hill Open Field Site

Company: Atheros Communication
 Project #: 06U10337
 Date: 07/18/06
 Test Engineer: Can Ming Chung
 Configuration: Tx with Ant (A_mode)
 Mode: TX

Test Equipment:

Horn 1-18GHz	Pre-amplifier 1-26GHz	Pre-amplifier 26-40GHz	Horn > 18GHz	Limit
T73; S/N: 6717 @3m	T144 Miteq 3008A00931			FCC 15.209

Hi Frequency Cables

2 foot cable	3 foot cable	12 foot cable	HPF	Reject Filter	Peak Measurements RBW=VBW=1MHz Average Measurements RBW=1MHz; VBW=10Hz
	Can 187215004	Can 187209002	HPF_7.6GHz		

f GHz	Dist (m)	Read Pk dBuV	Read Avg dBuV	AF dB/m	CL dB	Amp dB	D Corr dB	Fldr dB	Peak dBuV/m	Avg dBuV/m	Pk Lim dBuV/m	Avg Lim dBuV/m	Pk Mar dB	Avg Mar dB	Notes (V/H)
Low Ch															
10.990	3.0	52.5	40.6	37.2	5.2	-36.3	0.0	0.7	59.4	47.5	74	54	-14.6	-6.5	Y
16.050	3.0	49.3	36.8	37.2	6.4	-34.4	0.0	0.7	59.2	46.7	74	54	-14.8	-7.3	Y
11.008	3.0	46.1	34.7	37.3	5.2	-36.3	0.0	0.7	53.0	41.6	74	54	-21.0	-12.4	H
16.500	3.0	45.5	32.2	38.9	6.5	-34.1	0.0	0.7	57.6	44.3	74	54	-16.4	-9.7	H
Mid Ch															
11.201	3.0	50.8	37.9	37.3	5.3	-36.1	0.0	0.7	58.1	45.2	74	54	-15.9	-8.8	Y
16.806	3.0	46.5	33.5	40.1	6.6	-33.8	0.0	0.7	60.1	47.1	74	54	-13.9	-6.9	Y
11.207	3.0	47.6	35.4	37.3	5.3	-36.1	0.0	0.7	54.8	42.6	74	54	-19.2	-11.4	H
16.804	3.0	46.6	34.8	40.1	6.6	-33.8	0.0	0.7	60.1	48.3	74	54	-13.9	-5.7	H
High Ch															
11.399	3.0	50.1	38.9	37.4	5.3	-35.9	0.0	0.7	57.7	46.4	74	54	-16.3	-7.6	Y
17.098	3.0	47.0	34.8	41.2	6.7	-33.7	0.0	0.7	61.8	49.6	74	54	-12.2	-4.4	Y
11.400	3.0	50.6	38.6	37.4	5.3	-35.9	0.0	0.7	58.1	46.1	74	54	-15.9	-7.9	H
17.100	3.0	45.4	34.0	41.2	6.7	-33.7	0.0	0.7	60.2	48.9	74	54	-13.8	-5.1	H

No Signal Found above Noise Floor
 Rev. 5.1.6

f	Measurement Frequency	Amp	Preamp Gain	Avg Lim	Average Field Strength Limit
Dist	Distance to Antenna	D Corr	Distance Correct to 3 meters	Pk Lim	Peak Field Strength Limit
Read	Analyzer Reading	Avg	Average Field Strength @ 3 m	Avg Mar	Margin vs. Average Limit
AF	Antenna Factor	Peak	Calculated Peak Field Strength	Pk Mar	Margin vs. Peak Limit
CL	Cable Loss	HPF	High Pass Filter		

RESTRICTED BANDEDGE (802.11a TURBO MODE, LOW CHANNEL, HORIZONTAL)

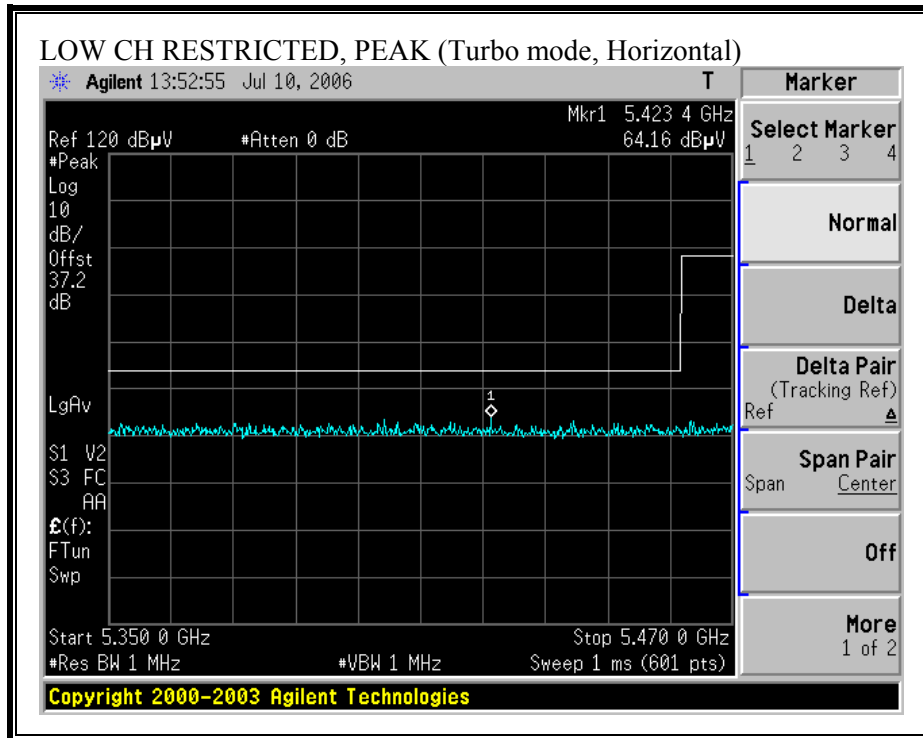

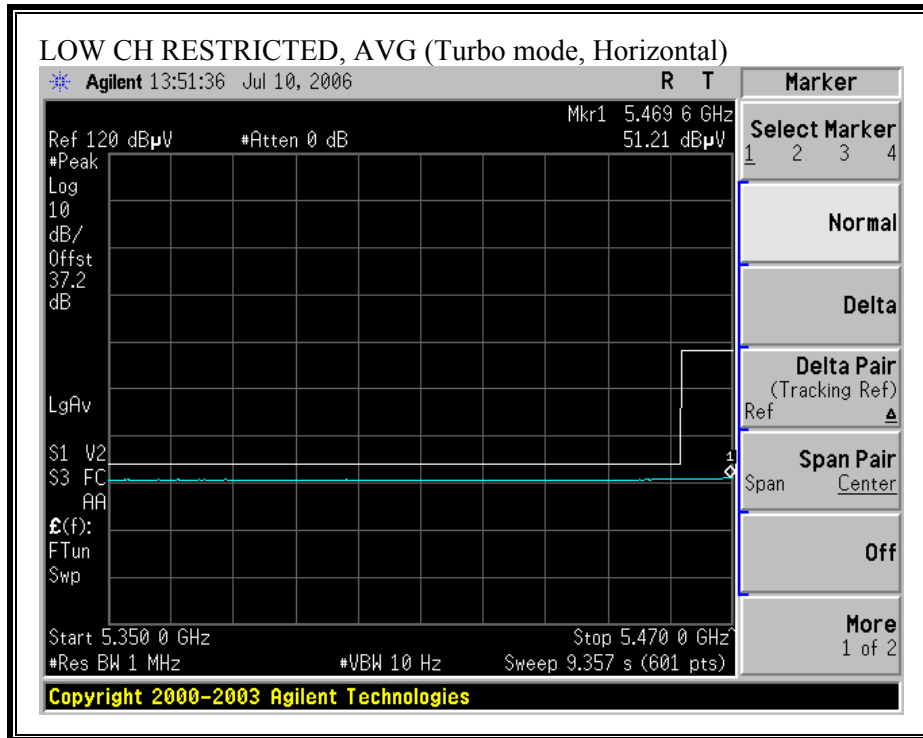

RESTRICTED BANDEDGE (802.11a TURBO MODE, LOW CHANNEL, VERTICAL)

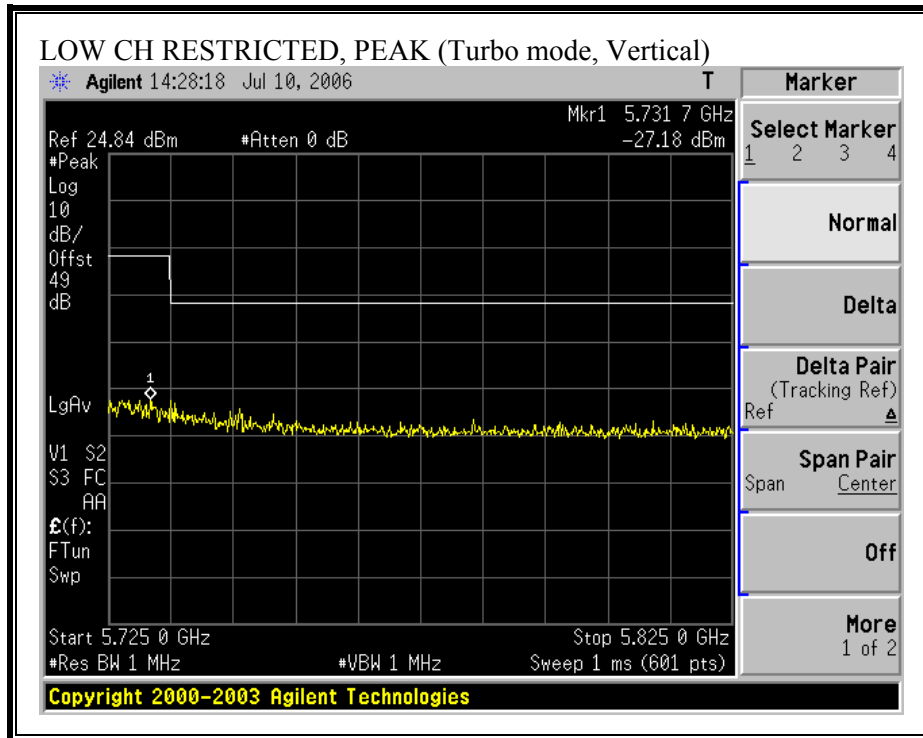

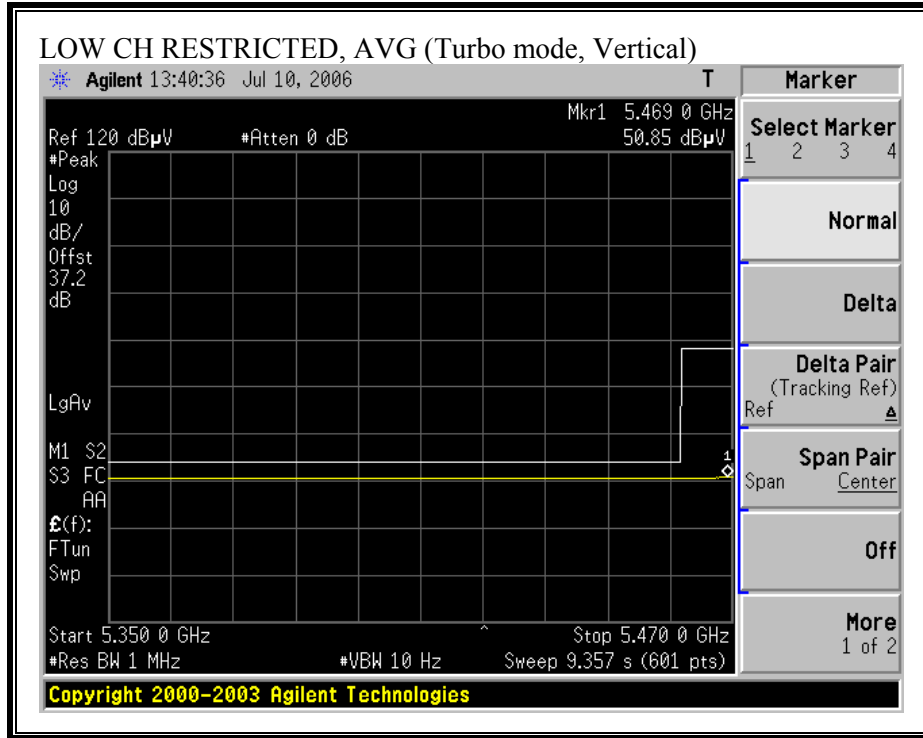

BANDEDGE (802.11a TURBO MODE, HIGH CHANNEL, HORIZONTAL)

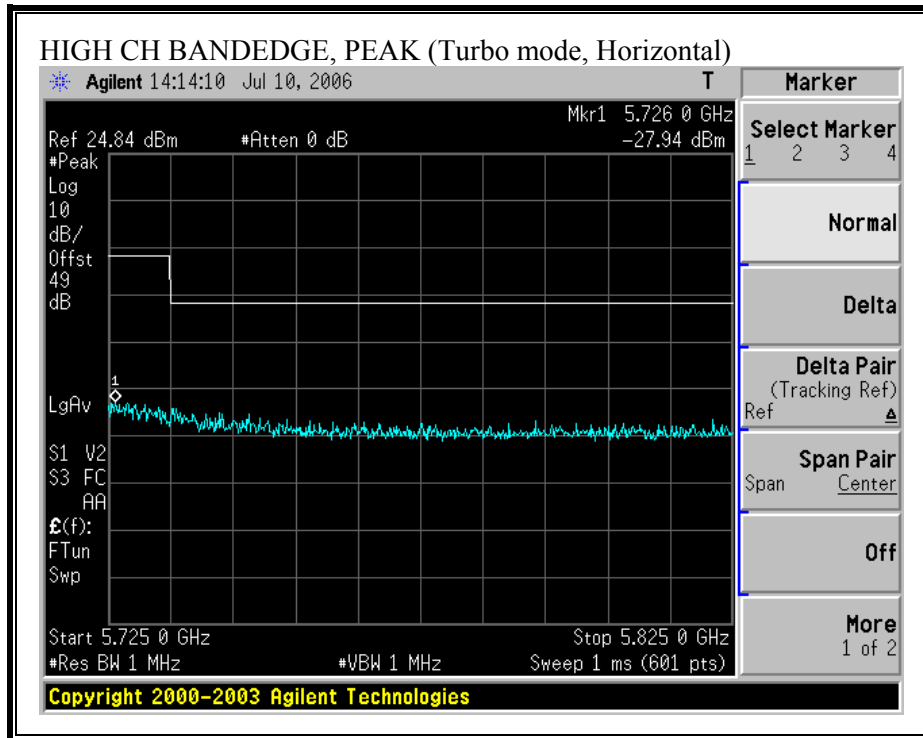

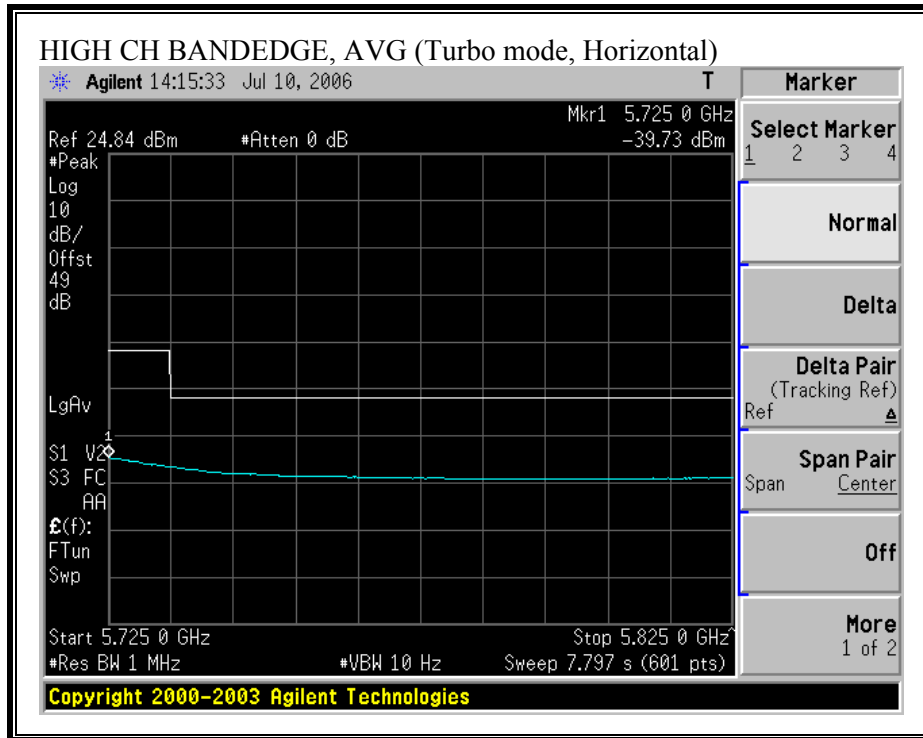

BANDEDGE (802.11a TURBO MODE, HIGH CHANNEL, VERTICAL)

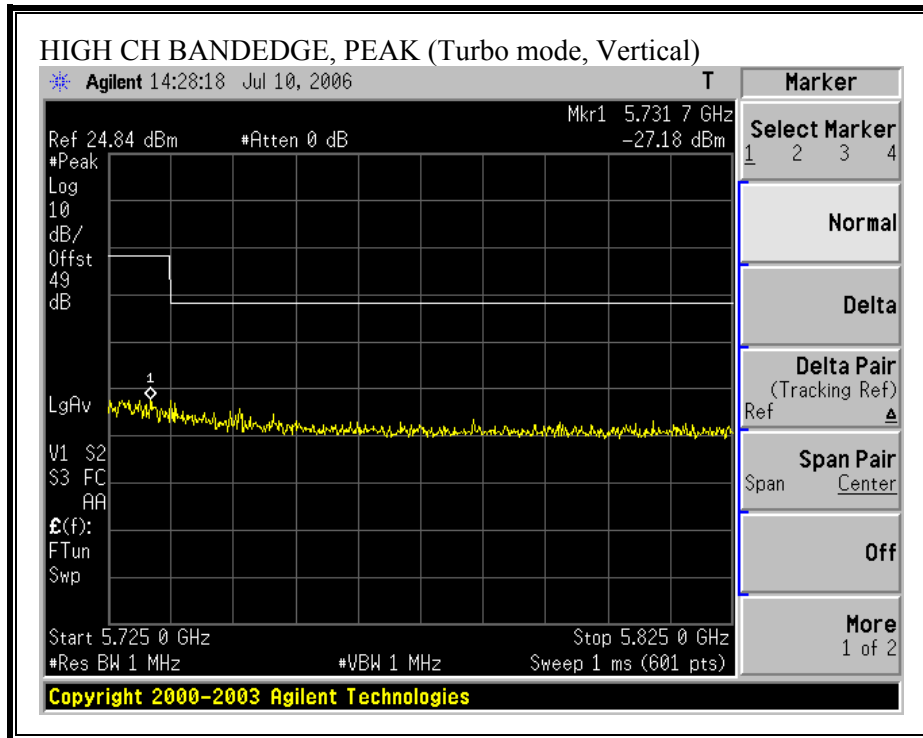

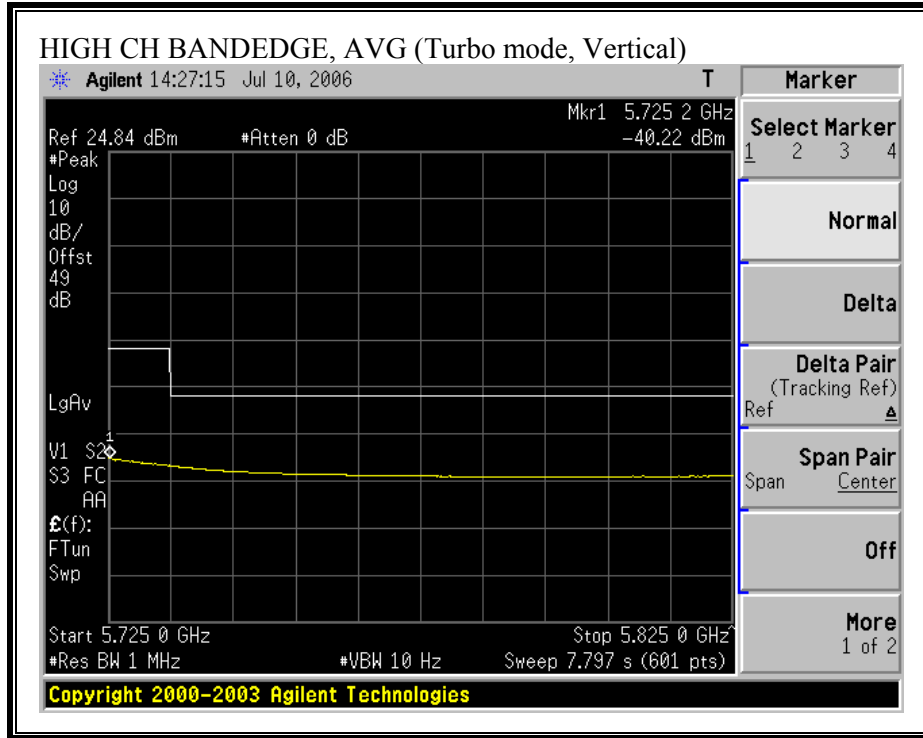

HARMONICS AND SPURIOUS EMISSIONS (802.11a TURBO MODE)

High Frequency Measurement
 Compliance Certification Services, Morgan Hill Open Field Site

Company: Atheros Communication
 Project #: 06U10337
 Date: 07/18/06
 Test Engineer: Can Ming Chung
 Configuration: Tx with Ant (A Mode)
 Mode: TX (Turbo)

Test Equipment:

Horn 1-18GHz	Pre-amplifier 1-26GHz	Pre-amplifier 26-40GHz	Horn > 18GHz	Limit
T73; S/N: 6717 @3m	T144 Miteq 3008A00931			FCC 15.209

Hi Frequency Cables

2 foot cable	3 foot cable	12 foot cable	HPF	Reject Filter	Peak Measurements RBW=VBW=1MHz Average Measurements RBW=1MHz ; VBW=10Hz
	Can 187215004	Can 187209002	HPF_7.6GHz		

f GHz	Dist (m)	Read Pk dBuV	Read Avg. dBuV	AF dB/m	CL dB	Amp dB	D Corr dB	Filtr dB	Peak dBuV/m	Avg dBuV/m	Pk Lim dBuV/m	Avg Lim dBuV/m	Pk Mar dB	Avg Mar dB	Notes (V/H)
Low Ch															
11.080	3.0	48.9	39.7	37.3	5.3	-36.2	0.0	0.7	56.0	46.8	74	54	-18.0	-7.2	V
16.617	3.0	47.3	34.8	39.4	6.6	-34.0	0.0	0.7	59.9	47.4	74	54	-14.1	-6.6	V
11.079	3.0	46.0	33.1	37.3	5.3	-36.2	0.0	0.7	53.1	40.2	74	54	-20.9	-13.8	H
16.609	3.0	45.2	33.0	39.3	6.6	-34.0	0.0	0.7	57.8	45.6	74	54	-16.2	-8.4	H
Mid CH															
11.239	3.0	51.7	39.8	37.4	5.3	-36.1	0.0	0.7	59.0	47.1	74	54	-15.0	-6.9	V
16.854	3.0	46.1	33.2	40.3	6.6	-33.8	0.0	0.7	59.9	46.9	74	54	-14.1	-7.1	V
11.238	3.0	49.6	37.9	37.4	5.3	-36.1	0.0	0.7	56.9	45.2	74	54	-17.1	-8.8	H
16.860	3.0	46.0	33.6	40.3	6.6	-33.8	0.0	0.7	59.8	47.4	74	54	-14.2	-6.6	H
High Ch															
11.321	3.0	53.5	40.9	37.4	5.3	-36.0	0.0	0.7	60.9	48.3	74	54	-13.1	-5.7	V
16.971	3.0	47.2	35.4	40.7	6.7	-33.7	0.0	0.7	61.5	49.8	74	54	-12.5	-4.2	V
11.320	3.0	51.9	39.9	37.4	5.3	-36.0	0.0	0.7	59.3	47.3	74	54	-14.7	-6.7	H
16.970	3.0	45.6	33.3	40.7	6.6	-33.7	0.0	0.7	59.9	47.6	74	54	-14.1	-6.4	H

No Signal Found above Noise Floor
 Rev. 5.1.6

f	Measurement Frequency	Amp	Preamp Gain	Avg Lim	Average Field Strength Limit
Dist	Distance to Antenna	D Corr	Distance Correct to 3 meters	Pk Lim	Peak Field Strength Limit
Read	Analyzer Reading	Avg	Average Field Strength @ 3 m	Avg Mar	Margin vs. Average Limit
AF	Antenna Factor	Peak	Calculated Peak Field Strength	Pk Mar	Margin vs. Peak Limit
CL	Cable Loss	HPF	High Pass Filter		

7.3. DYNAMIC FREQUENCY SELECTION

7.3.1. LIMITS

§15.407 (h) and FCC 06-96 APPENDIX “COMPLIANCE MEASUREMENT PROCEDURES FOR UNLICENSED-NATIONAL INFORMATION INFRASTRUCTURE DEVICES OPERATING IN THE 5250-5350 MHz AND 5470-5725 MHz BANDS INCORPORATING DYNAMIC FREQUENCY SELECTION”.

Table 1: Applicability of DFS requirements prior to use of a channel

Requirement	Operational Mode		
	Master	Client (without radar detection)	Client (with radar detection)
<i>Non-Occupancy Period</i>	Yes	Not required	Yes
<i>DFS Detection Threshold</i>	Yes	Not required	Yes
<i>Channel Availability Check Time</i>	Yes	Not required	Not required
<i>Uniform Spreading</i>	Yes	Not required	Not required

Table 2: Applicability of DFS requirements during normal operation

Requirement	Operational Mode		
	Master	Client (without DFS)	Client (with DFS)
<i>DFS Detection Threshold</i>	Yes	Not required	Yes
<i>Channel Closing Transmission Time</i>	Yes	Yes	Yes
<i>Channel Move Time</i>	Yes	Yes	Yes

Table 3: Interference Threshold values, Master or Client incorporating In-Service Monitoring

Maximum Transmit Power	Value (see note)
≥ 200 milliwatt	-64 dBm
< 200 milliwatt	-62 dBm
Note 1: This is the level at the input of the receiver assuming a 0 dBi receive antenna Note 2: Throughout these test procedures an additional 1 dB has been added to the amplitude of the test transmission waveforms to account for variations in measurement equipment. This will ensure that the test signal is at or above the detection threshold level to trigger a DFS response.	

Table 4: DFS Response requirement values

Parameter	Value
<i>Non-occupancy period</i>	30 minutes
<i>Channel Availability Check Time</i>	60 seconds
<i>Channel Move Time</i>	10 seconds
<i>Channel Closing Transmission Time</i>	200 milliseconds + approx. 60 milliseconds over remaining 10 second period
The instant that the <i>Channel Move Time</i> and the <i>Channel Closing Transmission Time</i> begins is as follows: <ul style="list-style-type: none"> • For the Short pulse radar Test Signals this instant is the end of the <i>Burst</i>. • For the Frequency Hopping radar Test Signal, this instant is the end of the last radar burst generated. • For the Long Pulse radar Test Signal this instant is the end of the 12 second period defining the radar transmission. The Channel Closing Transmission Time is comprised of 200 milliseconds starting at the beginning of the Channel Move Time plus any additional intermittent control signals required to facilitate channel changes (an aggregate of approximately 60 milliseconds) during the remainder of the 10 second period. The aggregate duration of control signals will not count quiet periods in between transmissions.	

Table 5 – Short Pulse Radar Test Waveforms

Radar Type	Pulse Width (Microseconds)	PRI (Microseconds)	Pulses	Minimum Percentage of Successful Detection	Minimum Trials
1	1	1428	18	60%	30
2	1-5	150-230	23-29	60%	30
3	6-10	200-500	16-18	60%	30
4	11-20	200-500	12-16	60%	30
Aggregate (Radar Types 1-4)				80%	120

Table 6 – Long Pulse Radar Test Signal

Radar Waveform	Bursts	Pulses per Burst	Pulse Width (µsec)	Chirp Width (MHz)	PRI (µsec)	Minimum Percentage of Successful Detection	Minimum Trials
5	8-20	1-3	50-100	5-20	1000-2000	80%	30

Table 7 – Frequency Hopping Radar Test Signal

Radar Waveform	Pulse Width (µsec)	PRI (µsec)	Burst Length (ms)	Pulses per Hop	Hopping Rate (kHz)	Minimum Percentage of Successful Detection	Minimum Trials
6	1	333	300	9	.333	70%	30

7.3.2. DESCRIPTION OF EUT

OVERVIEW OF EUT WITH RESPECT TO §15.407 (h) REQUIREMENTS

The EUT operates over the 5250-5350 MHz and 5470-5725 MHz ranges.

The EUT is a Client Device that does not have radar detection capability.

The EUT uses a single transmitter and two antennas for diversity. The highest power level within these bands is 21.7 dBm EIRP in the 5250-5350 MHz band and 23.1 dBm EIRP in the 5470-5725 MHz band.

The highest gain antenna assembly utilized with the EUT has a maximum gain of 5.6 dBi in the 5250-5350 MHz band and 5.3 dBi in the 5470-5725 MHz band. The lowest gain antenna assembly utilized with the EUT has a maximum gain of -0.48 dBi in the 5250-5350 MHz band and -0.44 dBi in the 5470-5725 MHz band.

Both of the 50-ohm antenna ports are connected to the test system via a power combiner/divider to perform conducted tests.

WLAN traffic is generated by streaming the video file TestFile.mp2 "6 ½ Magic Hours" from the Master to the Slave in full motion video mode using the media player with the V2.61 Codec package.

TPC is not required since the maximum EIRP is less than 500 mW (27 dBm).

The EUT utilizes an 802.11a IP based architecture. Two nominal channel bandwidths, 20 MHz and 40 MHz, are implemented.

OVERVIEW OF MASTER DEVICE WITH RESPECT TO §15.407 (h) REQUIREMENTS

The Master Device is an Atheros Access Point, FCC ID: PPD-AR5BAP-00032. The DFS software installed in the Master Device is revision 5.1.0.42.

The rated output power of the Master unit is > 23dBm (EIRP). Therefore the required interference threshold level is -64 dBm. After correction for antenna gain and procedural adjustments, the required conducted threshold at the antenna port is $-64 + 4 + 1 = -59$ dBm.

The calibrated conducted DFS Detection Threshold level is set to -64 dBm. The tested level is lower than the required level hence it provides margin to the limit.

7.3.3. TEST AND MEASUREMENT SYSTEM

SYSTEM OVERVIEW

The measurement system is based on a conducted test method.

The short pulse and long pulse signal generating system utilizes the NTIA software and the same manufacturer / model Vector Signal Generator as the NTIA. The hopping signal generating system utilizes the simulated hopping method.

The software selects waveform parameters from within the bounds of the signal type on a random basis using uniform distribution. The short pulse types 2, 3 and 4, and the long pulse type 5 parameters are randomized at run-time. The hopping type 6 pulse parameters are fixed while the hopping sequence is based on the August 2005 NTIA Hopping Frequency List, with the initial starting point randomized at run-time.

The signal monitoring equipment consists of a spectrum analyzer with the capacity to display 8192 bins on the horizontal axis. A time-domain resolution of 2 msec / bin is achievable with a 16 second sweep time, meeting the 10 second short pulse reporting criteria. The aggregate ON time is calculated by multiplying the number of bins above a threshold during a particular observation period by the dwell time per bin, with the analyzer set to peak detection and max hold. A time-domain resolution of 3 msec / bin is achievable with a 24 second sweep time, meeting the 22 second long pulse reporting criteria and allowing a minimum of 10 seconds after the end of the long pulse waveform.

FREQUENCY HOPPING SIGNAL GENERATION

The hopping burst generator is a High Speed Digital I/O card plugged into the control computer. This card utilizes an independent hardware clock reference therefore the output pulse timing is unaffected by host computer operating system latency times.

The software selects the hopping sequence as a 100-length segment of the August 2005 NTIA hopping frequency list. This list contains 274 unique pseudorandom sequences. Each such sequence contains 475 frequencies ordered on a random without replacement basis. Each successive trial uses a contiguous 100-length segment from within each successive 475-length sequence in the list. The initial starting point within the list is randomized at run-time such that the first 100-length segment is entirely contained within the first 475-length sequence. The starting point of each successive trial is incremented by 475.

Each frequency in the 100-length segment is compared to the boundaries of the EUT Detection Bandwidth and the software creates a hopping burst pattern in accordance with Section 7.4.1.3 Method #2 Simulated Frequency Hopping Radar Waveform Generating Subsystem of FCC 06-96 APPENDIX. The frequency of the signal generator is incremented in 1 MHz steps from F_L to F_H for each successive trial. This incremental sequence is repeated as required to generate a minimum of 30 total trials and to maintain a uniform frequency distribution over the entire Detection Bandwidth.

CONDUCTED METHOD SYSTEM BLOCK DIAGRAM

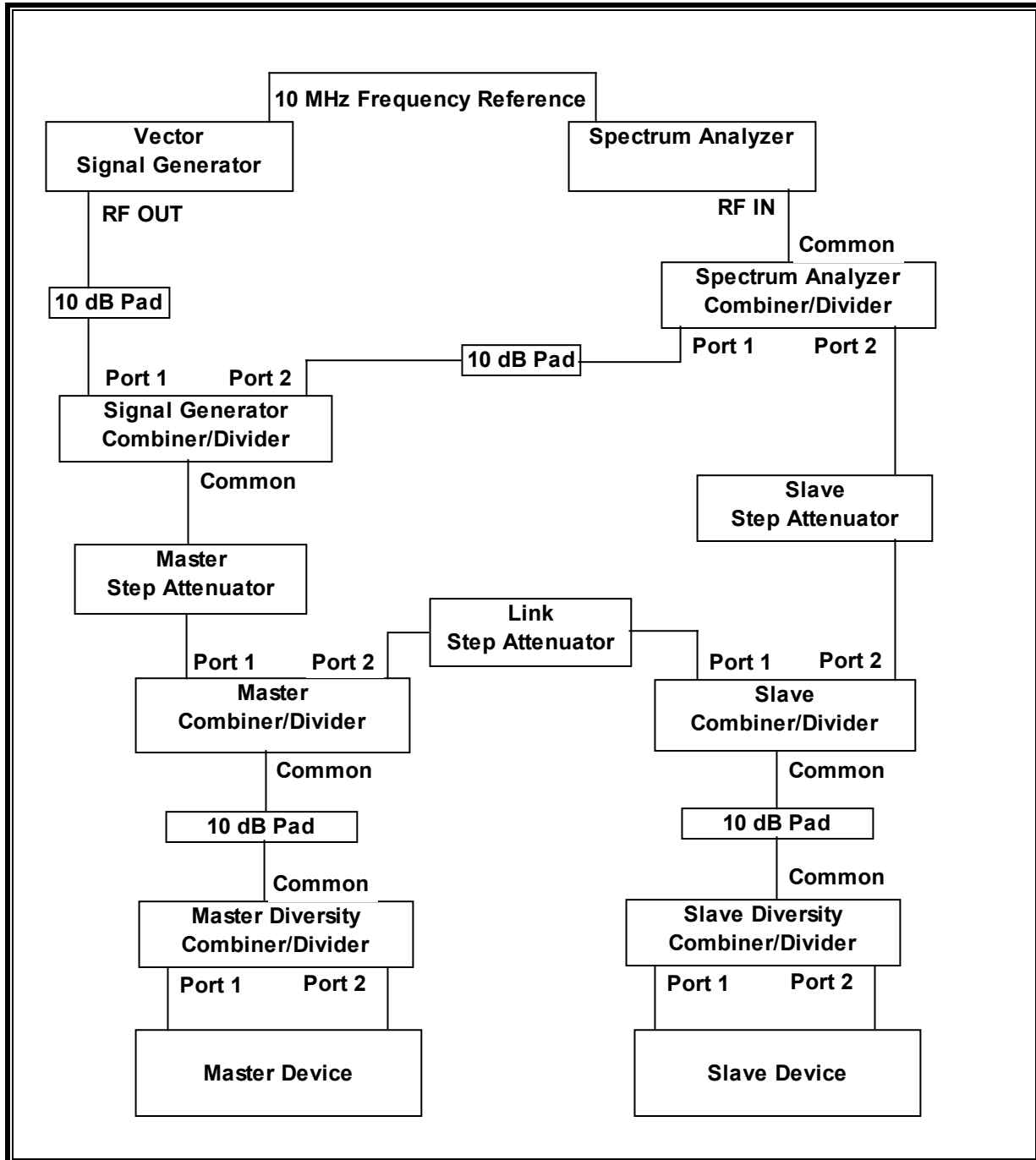

MEASUREMENT SYSTEM FREQUENCY REFERENCE

Lock the signal generator and the spectrum analyzer to the same reference source as follows: Connect the 10 MHz OUT (SWITCHED) on the spectrum analyzer to the 10 MHz IN on the signal generator and set the spectrum analyzer 10 MHz Out to On.

SYSTEM CALIBRATION

Adjust the Master Step Attenuator to 30 dB, the Link Step Attenuator to 70 dB, and the Slave Step Attenuator to 70 dB.

If required, disconnect the spectrum analyzer, Master Device, and Slave Device from the test system. Terminate the Common port of the Spectrum Analyzer Combiner/Divider, Port 2 of the Master Diversity Combiner/Divider, and Ports 1 and 2 of the Slave Diversity Combiner/Divider. Leave, or connect, the appropriate cable to Port 1 of the Master Diversity Combiner/Divider and connect the free end (Master Device end) of this cable to the spectrum analyzer.

Adjust the signal generator and spectrum analyzer to the center frequency of the channel to be measured. Set the signal generator to CW mode. Set the RBW of the spectrum analyzer to 10 kHz and the span to 100 kHz. Adjust the amplitude of the signal generator to yield a measured level of -64 dBm on the spectrum analyzer.

Without changing any of the instrument settings, reconnect the spectrum analyzer to the Common port of the Spectrum Analyzer Combiner/Divider, then remove the cable from Port 1 of the Master Diversity Combiner/Divider and replace this cable with a termination. Measure the amplitude and calculate the difference from -64 dBm. Adjust the Reference Level Offset of the spectrum analyzer to this difference. Confirm that the signal is displayed at -64 dBm. Readjust the RBW and VBW to 3 MHz, set the span to 10 MHz, and confirm that the signal is still displayed at -64 dBm.

This Reference Level Offset setting is used for all tests for which the Master Step Attenuator is set to 30 dB. The spectrum analyzer displays the level of the signal generator as received at the antenna ports of the Master Device. The interference detection threshold may be varied from the calibrated value of -64 dBm and the spectrum analyzer will still indicate the level as received by the Master Device.

The Link Step Attenuator and Slave Step Attenuator settings may be changed without affecting the System Calibration. The System Calibration process must be repeated for different settings of the Master Step Attenuator to determine the Reference Level Offset associated with each Master Step Attenuator setting.

INTERFERENCE DETECTION THRESHOLD ADJUSTMENT

Set the signal generator to produce the specified radar waveform, trigger a burst manually and measure the amplitude on the spectrum analyzer. Readjust the amplitude of the signal generator as required so that the peak level of the waveform is at a displayed level equal to the required or desired interference detection threshold.

ADJUSTMENT OF DISPLAYED TRAFFIC LEVEL

Establish a link between the Master and Slave, adjusting the Link Step Attenuator as needed to provide an adequate RSS level at the Master and Slave devices. Stream the video test file to generate WLAN traffic. Adjust the Slave Step Attenuator so that the WLAN traffic level from the Slave, as displayed on the spectrum analyzer, is at lower amplitude than the radar detection threshold.

Confirm that the displayed traffic is from the Slave Device by changing the setting of the Slave Step Attenuator and verifying that the displayed traffic level changes accordingly. Confirm that the displayed traffic does not include Master Device traffic by changing the setting of the Master Step Attenuator and the Link Step Attenuator and verifying that the displayed traffic level does not change. Reset all Step Attenuators to their previous settings.

If the above conditions cannot be met, use a different setting of the Master Step Attenuator, performing a new System Calibration and Interference Detection Threshold Adjustment as required for the new Master Step Attenuator setting.

7.3.4. SETUP OF EUT AND SUPPORT EQUIPMENT

SUPPORT EQUIPMENT

PERIPHERAL SUPPORT EQUIPMENT LIST				
Description	Manufacturer	Model	Serial Number	FCC ID
AC Adapter	CUI	DSA-0151A	4403	DoC
Access Point	Atheros	AP 30	AP 30-50-D7323	PPD-AR5BAP-00032
Laptop	IBM	Thinkpad T42	ZZ-27004	DoC
AC Adapter	IBM	08K8204	85910TF	DoC
Laptop	IBM	Thinkpad T42p	ZZ-27259	DoC
AC Adapter	IBM	02K6746	28106J	DoC

I/O CABLES

I/O CABLE LIST					
Cable No.	Port	# of Identical Ports	Connector Type	Cable Type	Cable Length
1	AC	1	US 115V	Direct Plug	0m
2	DC	1	DC	Un-shielded	2m
3	AC	1	US 115V	Un-shielded	1m
4	DC	1	DC	Un-shielded	2m
5	Ethernet	1	RJ45	Un-shielded	2m
6	Serial	1	USB to DIN	Shielded	2.5m
7	AC	1	US 115V	Un-shielded	2m
8	DC	1	DC	Un-shielded	2m

TEST SETUP

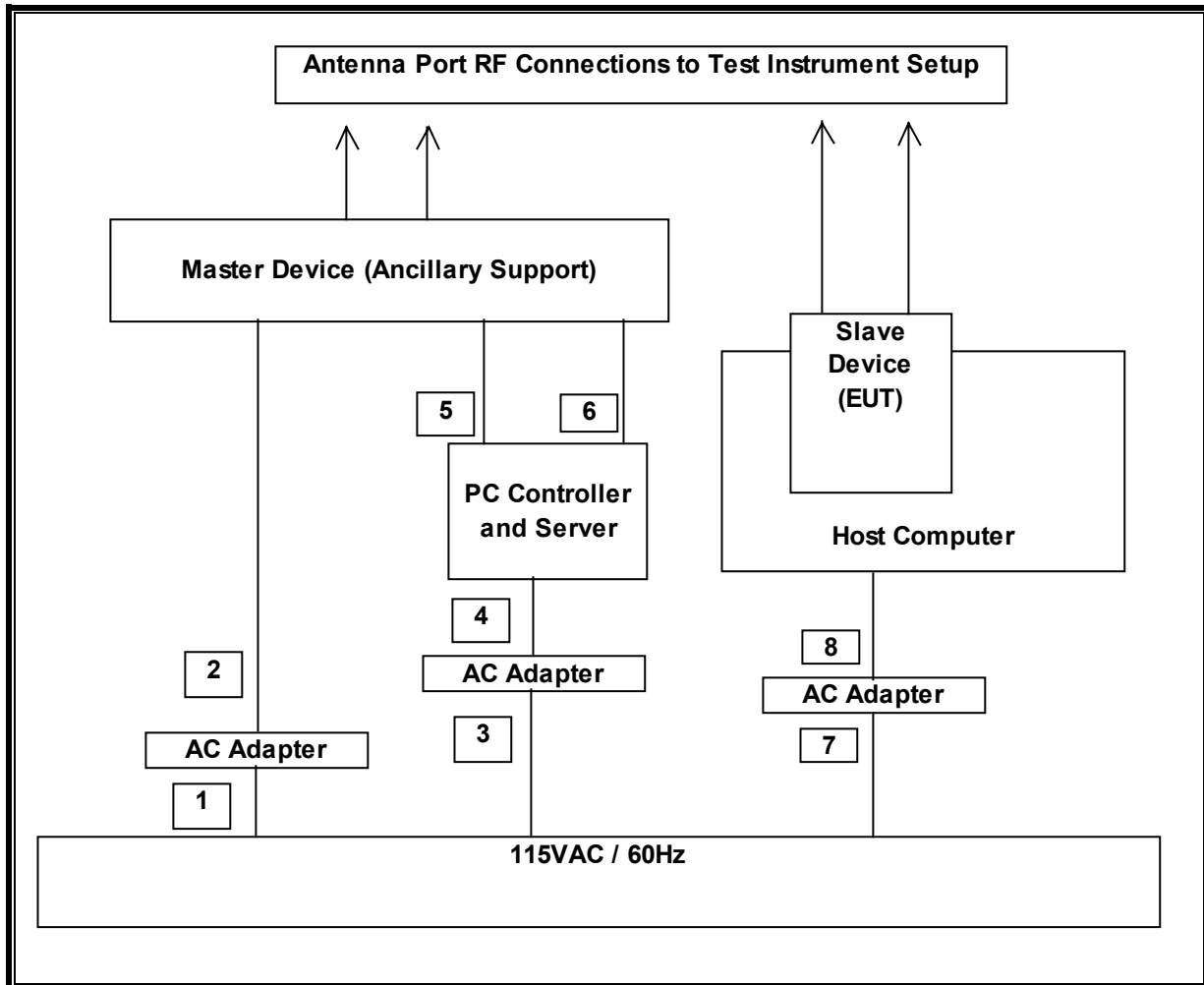

7.3.5. PLOTS OF NOISE, RADAR WAVEFORMS, AND WLAN SIGNALS

PLOT OF SYSTEM NOISE FLOOR

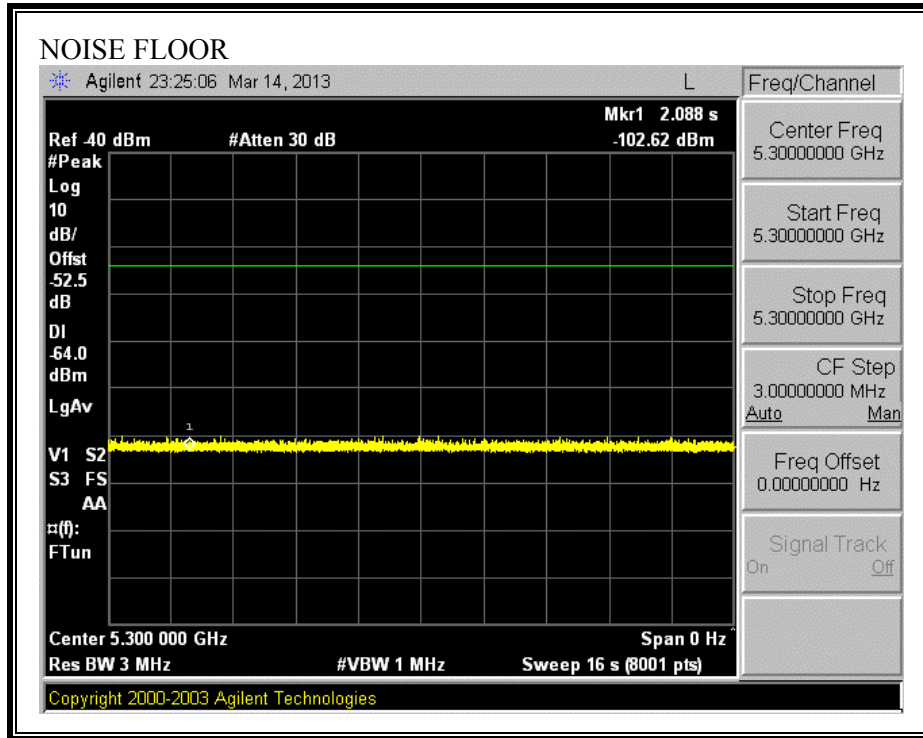

PLOTS OF RADAR WAVEFORM

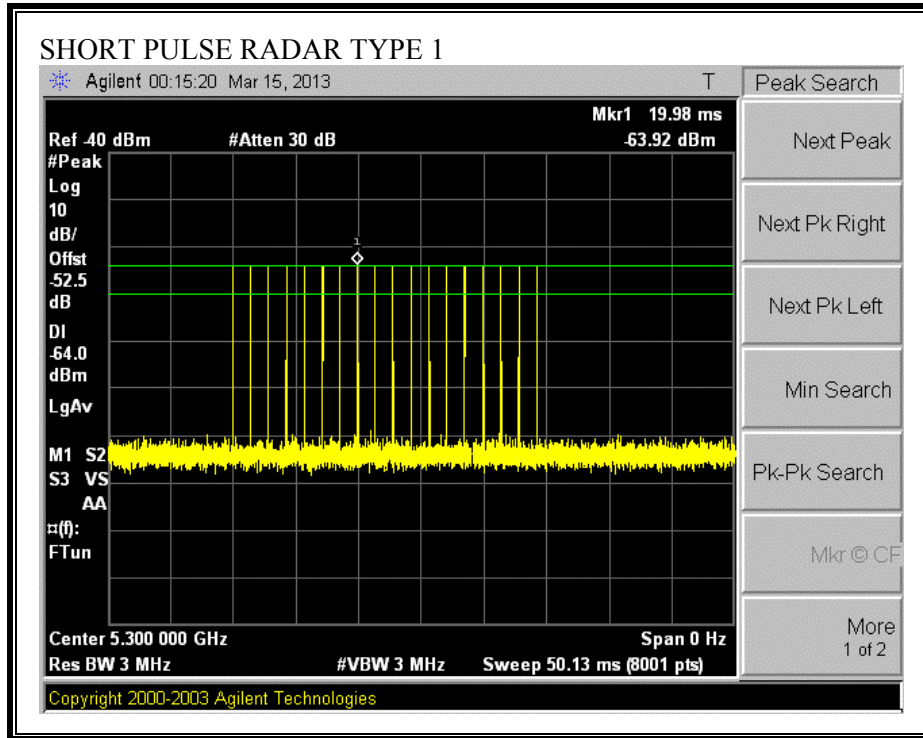

PLOT OF WLAN TRAFFIC FROM SLAVE

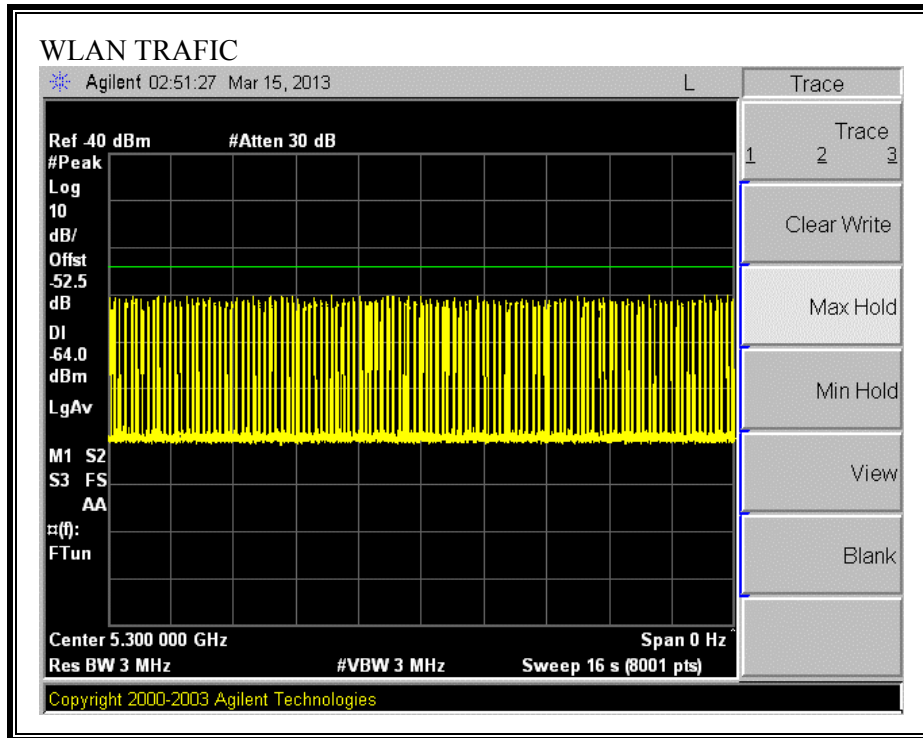

7.3.6. TEST CHANNEL AND METHOD

All tests were performed at a channel center frequency of 5300 MHz utilizing a conducted test method.

7.3.7. CHANNEL MOVE TIME AND CHANNEL CLOSING TRANSMISSION TIME

GENERAL REPORTING NOTES

The reference marker is set at the end of last radar pulse.

The delta marker is set at the end of the last WLAN transmission following the radar pulse. This delta is the channel move time.

The aggregate channel closing transmission time is calculated as follows:

Aggregate Transmission Time =
(Number of analyzer bins showing transmission) * (dwell time per bin)

The observation period over which the aggregate time is calculated
Begins no later than (Reference Marker + 200 msec)
and
Ends no earlier than (Reference Marker + 10 sec).

TYPE 1 CHANNEL MOVE TIME RESULTS

No non-compliance noted:

Channel Move Time (s)	Limit (s)
0.074	10

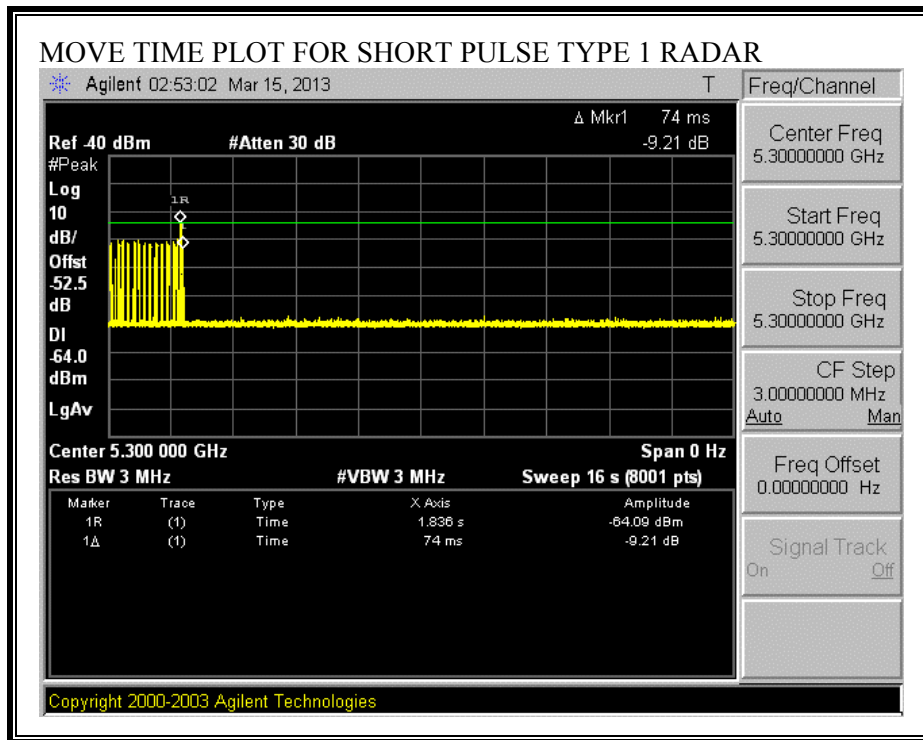

TYPE 1 CHANNEL CLOSING TRANSMISSION TIME RESULTS

No non-compliance noted:

Aggregate Transmission Time (ms)	Limit (ms)	Margin (ms)
0.00	60	60.00

Only intermittent transmissions are observed during the aggregate monitoring period.

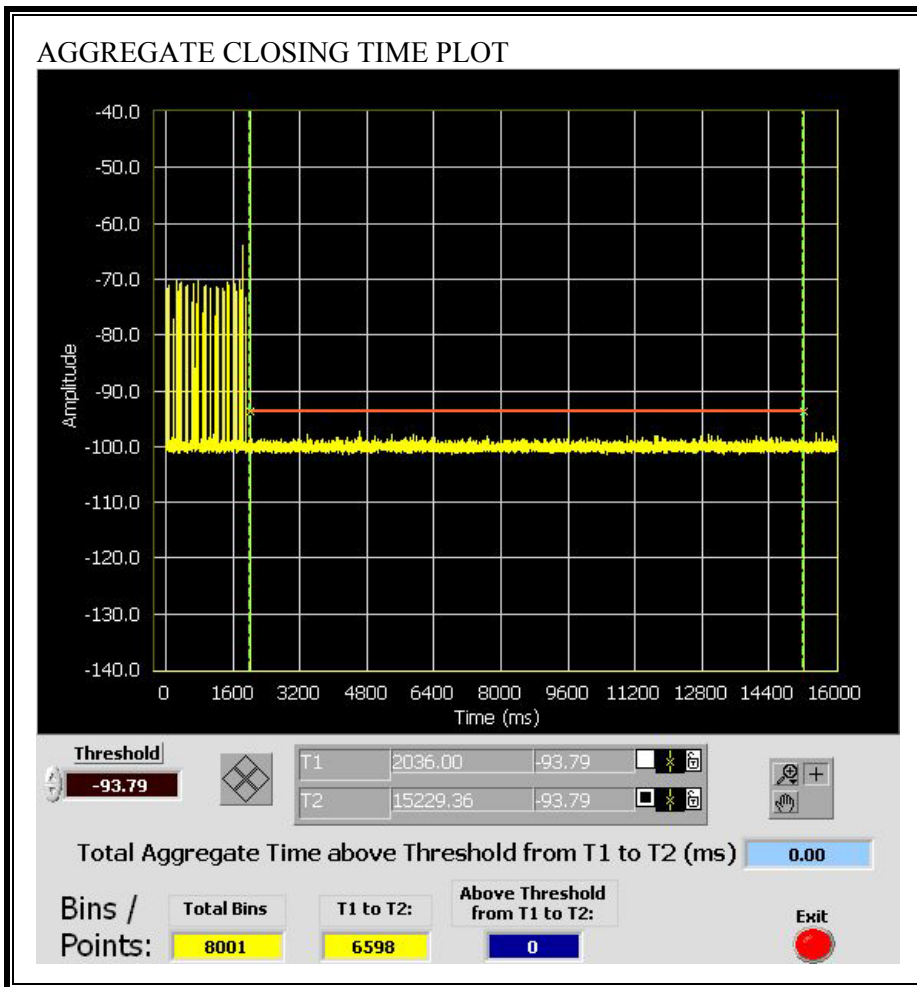

8. SETUP PHOTOS

ANTENNA PORT CONDUCTED RF MEASUREMENT SETUP

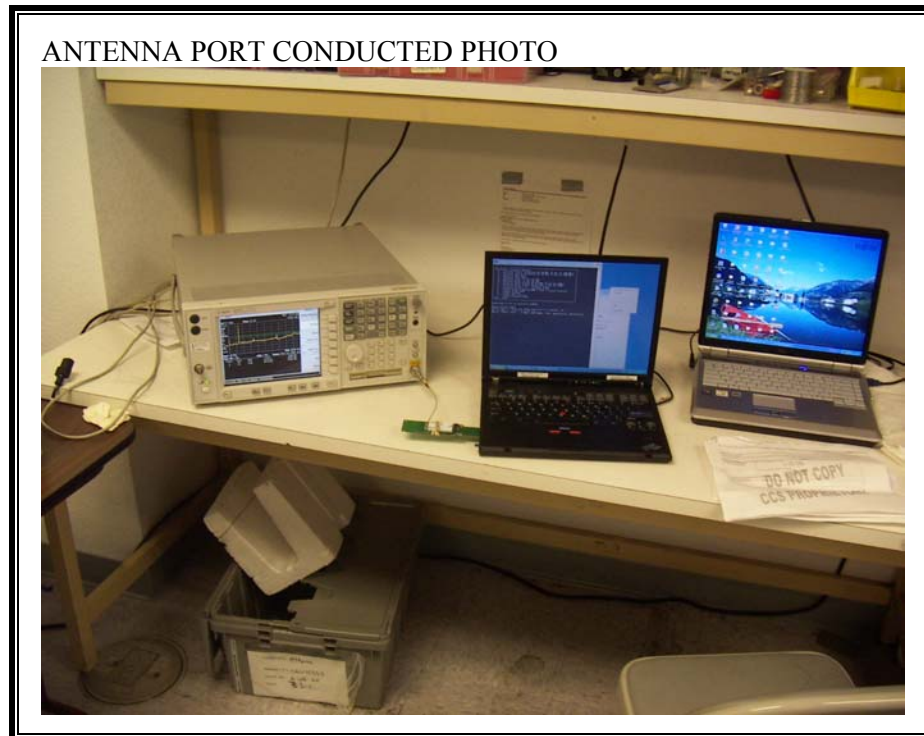

RADIATED RF MEASUREMENT SETUP



DYNAMIC FREQUENCY SELECTION MEASUREMENT SETUP

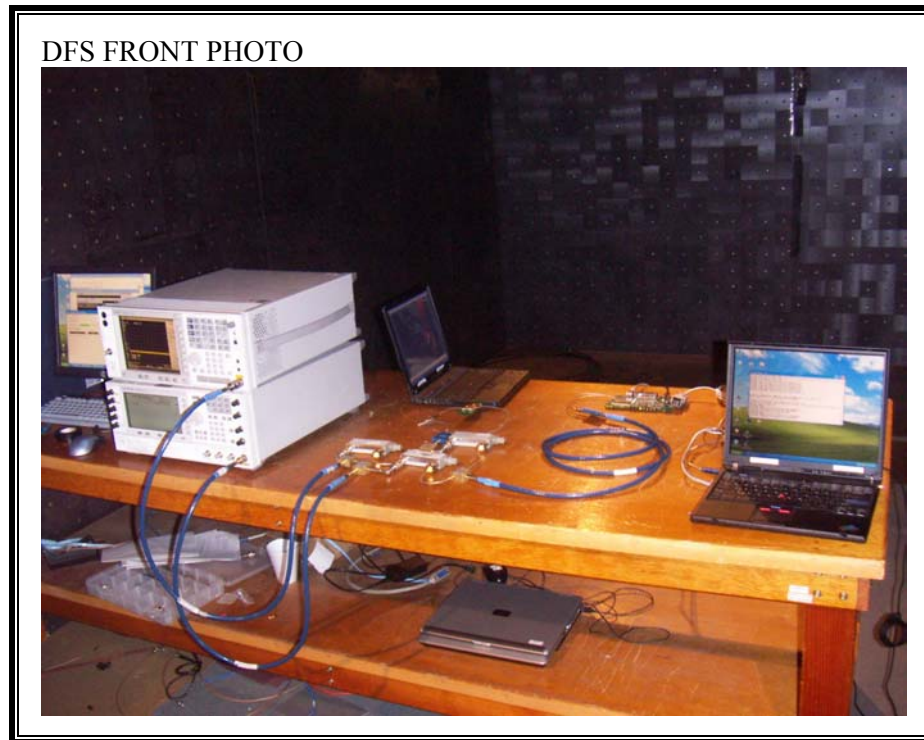

DFS BACK PHOTO



END OF REPORT