

FCC&IC Radio Test Report

FCC ID: Q3N-1564A

IC: 5121A-1564A

This report concerns (check one): Original Grant Class II Change

Project No. : 1411078
Equipment : BT Barcode Scanner
Model Name : 1564A
Applicant : CIPHERLAB CO., LTD.
Address : 12F, 333, Dunhua S. Rd., Sec. 2, Taipei, Taiwan

Date of Receipt : Nov. 12, 2014
Date of Test : Nov. 12, 2014~Nov. 28, 2014
Issued Date : Dec. 01, 2014
Tested by : BTL Inc.

Testing Engineer : Rush Kao
(Rush Kao)

Technical Manager : Jeff Yang
(Jeff Yang)

Authorized Signatory : Andy Chiu
(Andy Chiu)

B T L I N C .

B1, No.37, Lane 365, Yang Guang St.,
Nei-Hu District, Taipei City 114, Taiwan.
TEL:+886-2-2657-3299 FAX: +886-2- 2657-3331

Declaration

BTL represents to the client that testing is done in accordance with standard procedures as applicable and that test instruments used has been calibrated with the standards traceable to National Measurement Laboratory (**NML**) of **CHINA**, or National Institute of Standards and Technology (**NIST**) of **U.S.A.**

BTL's reports apply only to the specific samples tested under conditions. It is manufacture's responsibility to ensure that additional production units of this model are manufactured with the identical electrical and mechanical components. **BTL** shall have no liability for any declarations, inferences or generalizations drawn by the client or others from **BTL** issued reports.

BTL's reports must not be used by the client to claim product endorsement by the authorities or any agency of the Government.

This report is the confidential property of the client. As a mutual protection to the clients, the public and **BTL-self**, extracts from the test report shall not be reproduced except in full with **BTL's** authorized written approval.

BTL's laboratory quality assurance procedures are in compliance with the **ISO Guide 17025** requirements, and accredited by the conformity assessment authorities listed in this test report.

Limitation

For the use of the authority's logo is limited unless the Test Standard(s)/Scope(s)/Item(s) mentioned in this test report is (are) included in the conformity assessment authorities acceptance respective.

Table of Contents	Page
1 . CERTIFICATION	7
2 . SUMMARY OF TEST RESULTS	8
2.1 TEST FACILITY	9
2.2 MEASUREMENT UNCERTAINTY	9
3 . GENERAL INFORMATION	10
3.1 GENERAL DESCRIPTION OF EUT	10
3.2 DESCRIPTION OF TEST MODES	12
3.3 TABLE OF PARAMETERS OF TEXT SOFTWARE SETTING	12
3.4 BLOCK DIAGRAM SHOWING THE CONFIGURATION OF SYSTEM TESTED	13
3.5 DESCRIPTION OF SUPPORT UNITS	14
4 . EMC EMISSION TEST	15
4.1 CONDUCTED EMISSION MEASUREMENT	15
4.1.1 POWER LINE CONDUCTED EMISSION LIMITS	15
4.1.2 TEST PROCEDURE	15
4.1.3 DEVIATION FROM TEST STANDARD	15
4.1.4 TEST SETUP	16
4.1.5 EUT OPERATING CONDITIONS	16
4.1.6 EUT TEST CONDITIONS	16
4.1.7 TEST RESULTS	16
4.2 RADIATED EMISSION MEASUREMENT	17
4.2.1 RADIATED EMISSION LIMITS	17
4.2.2 TEST PROCEDURE	18
4.2.3 DEVIATION FROM TEST STANDARD	18
4.2.4 TEST SETUP	19
4.2.5 EUT OPERATING CONDITIONS	20
4.2.6 EUT TEST CONDITIONS	20
4.2.7 TEST RESULTS (9KHZ TO 30MHZ)	20
4.2.8 TEST RESULTS (BETWEEN 30MHZ TO 1000 MHZ)	21
4.2.9 TEST RESULTS (ABOVE 1000 MHZ)	21
5 . NUMBER OF HOPPING CHANNEL	22
5.1 APPLIED PROCEDURES	22
5.1.1 TEST PROCEDURE	22
5.1.2 DEVIATION FROM STANDARD	22
5.1.3 TEST SETUP	22
5.1.4 EUT OPERATION CONDITIONS	22
5.1.5 EUT TEST CONDITIONS	22
5.1.6 TEST RESULTS	22

Table of Contents	Page
6 . AVERAGE TIME OF OCCUPANCY	23
6.1 APPLIED PROCEDURES / LIMIT	23
6.1.1 TEST PROCEDURE	23
6.1.2 DEVIATION FROM STANDARD	23
6.1.3 TEST SETUP	23
6.1.4 EUT OPERATION CONDITIONS	24
6.1.5 EUT TEST CONDITIONS	24
6.1.6 TEST RESULTS	24
7 . HOPPING CHANNEL SEPARATION MEASUREMENT	25
7.1 APPLIED PROCEDURES / LIMIT	25
7.1.1 TEST PROCEDURE	25
7.1.2 DEVIATION FROM STANDARD	25
7.1.3 TEST SETUP	25
7.1.4 EUT TEST CONDITIONS	25
7.1.5 TEST RESULTS	25
8 . BANDWIDTH TEST	26
8.1 APPLIED PROCEDURES	26
8.1.1 TEST PROCEDURE	26
8.1.2 DEVIATION FROM STANDARD	26
8.1.3 TEST SETUP	26
8.1.4 EUT OPERATION CONDITIONS	26
8.1.5 EUT TEST CONDITIONS	26
8.1.6 TEST RESULTS	26
9 . PEAK OUTPUT POWER TEST	27
9.1 APPLIED PROCEDURES / LIMIT	27
9.1.1 TEST PROCEDURE	27
9.1.2 DEVIATION FROM STANDARD	27
9.1.3 TEST SETUP	27
9.1.4 EUT OPERATION CONDITIONS	27
9.1.5 EUT TEST CONDITIONS	27
9.1.6 TEST RESULTS	27
10 . ANTENNA CONDUCTED SPURIOUS EMISSION	28
10.1 APPLIED PROCEDURES / LIMIT	28
10.1.1 TEST PROCEDURE	28
10.1.2 DEVIATION FROM STANDARD	28
10.1.3 TEST SETUP	28
10.1.4 EUT OPERATION CONDITIONS	28
10.1.5 EUT TEST CONDITIONS	28
10.1.6 TEST RESULTS	28
11 . MEASUREMENT INSTRUMENTS LIST	29

Table of Contents	Page
12 . EUT TEST PHOTO	31
ATTACHMENT A - CONDUCTED EMISSION	34
ATTACHMENT B - RADIATED EMISSION (9KHZ-30MHZ)	35
ATTACHMENT C - RADIATED EMISSION (30MHZ TO 1000MHZ)	37
ATTACHMENT D - RADIATED EMISSION (ABOVE 1000MHZ)	40
ATTACHMENT E - NUMBER OF HOPPING CHANNEL	65
ATTACHMENT F - AVERAGE TIME OF OCCUPANCY	67
ATTACHMENT G - HOPPING CHANNEL SEPARATION MEASUREMENT	80
ATTACHMENT H - BANDWIDTH	85
ATTACHMENT I - PEAK OUTPUT POWER	90
ATTACHMENT J - ANTENNA CONDUCTED SPURIOUS EMISSION	95

REPORT ISSUED HISTORY

Issued No.	Description	Issued Date
BTL-FICP-1-1411078	Original Issue.	Dec. 01, 2014

1. CERTIFICATION

Equipment : BT Barcode Scanner
Brand Name : CIPHERLAB
Model Name : 1564A
Applicant : CIPHERLAB CO., LTD.
Manufacturer : CIPHERLAB CO., LTD.
Address : 12F, 333, Dunhua S. Rd., Sec. 2, Taipei, Taiwan
Factory : CIPHERLAB CO., LTD.
Address : 12F, 333, Dunhua S. Rd., Sec. 2, Taipei, Taiwan
Date of Test : Nov. 12, 2014~Nov. 28, 2014
Test Sample : ENGINEERING SAMPLE
Standard(s) : FCC Part15, Subpart C : 2013 (15.247) / ANSI C63.4 : 2009 /
FCC Public Notice DA 00-705, March 30, 2000.
Canada RSS-210: 2010
RSS-GEN Issue 4, Nov 2014

The above equipment has been tested and found compliance with the requirement of the relative standards by BTL Inc.

The test data, data evaluation, and equipment configuration contained in our test report (Ref No. BTL-FICP-1-1411078) were obtained utilizing the test procedures, test instruments, test sites that has been accredited by the Authority of TAF according to the ISO-17025 quality assessment standard and technical standard(s).

2. SUMMARY OF TEST RESULTS

Test procedures according to the technical standard(s):

Applied Standard(s): 47 CFR Part 15, Subpart C: 2013; Canada RSS-210:2010; RSS-GEN Issue 4, Nov 2014				
Standard(s) Section		Test Item	Judgment	Remark
FCC	IC			
15.207	RSS-GEN Issue 4, Nov 2014 7.2.4	Conducted Emission	N/A	
15.247(d)	RSS-210, Issue 8, Annex 8, A8.5	Antenna conducted Spurious Emission	PASS	
15.247 (a)(1)	RSS-210, Issue 8, Annex 8, A8.1(b)	Hopping Channel Separation	PASS	
15.247 (b)(1)	RSS-210, Issue 8, Annex 8, A8.1(b)	Peak Output Power	PASS	
15.247(d) 15.209	RSS-210, Issue 8, Annex 8, Section 8.5	Radiated Spurious Emission	PASS	
15.247 (a)(1)(iii)	RSS-210, Issue 8, Annex 8, A8.1(d)	Number of Hopping Frequency	PASS	
15.247 (a)(1)(iii)	RSS-210, Issue 8, Annex 8, A8.1(d)	Dwell Time	PASS	
15.205	RSS-GEN Issue 4, Nov 2014 7.2.2	Restricted Bands	PASS	
15.203	-	Antenna Requirement	PASS	

Note:

- (1) "N/A" denotes test is not applicable in this test report
- (2) According to FCC Public Notice DA 00-705, March 30, 2000.

2.1 TEST FACILITY

Radiated emission Test (Below 1 GHz):

CB08: (FCC RN: 614388; FCC DN: TW1054; IC Assigned Code: 4428C-1)
1F., No. 61, Ln. 77, Sing-ai Rd., Neihu Dist., Taipei City 114, Taiwan (R.O.C.)

Radiated emission Test (Above 1 GHz):

CB08: (VCCI RN: G-91; FCC RN: 614388; FCC DN: TW1054; IC Assigned Code: 4428C-1)
1F., No. 61, Ln. 77, Sing-ai Rd., Neihu Dist., Taipei City 114, Taiwan (R.O.C.)

2.2 MEASUREMENT UNCERTAINTY

The measurement uncertainty is not specified by FCC rules and Canada Industry for reference only.

The reported uncertainty of measurement $y \pm U$, where expanded uncertainty U is based on a standard uncertainty multiplied by a coverage factor of $k=2$, providing a level of confidence of approximately **95%**.

The measurement instrumentation uncertainty considerations contained in CISPR 16-4-2.

A. Radiated emission test:

Test Site	Item	Measurement Frequency Range	Uncertainty	NOTE	
CB08	Radiated emission at 3m	Horizontal Polarization	30 - 200MHz	3.35 dB	
			200 - 1000MHz	3.11 dB	
			1 - 18GHz	3.97 dB	
			18 - 40GHz	4.01 dB	
		Vertical Polarization	30 - 200MHz	3.22 dB	
			200 - 1000MHz	3.24 dB	
			1 - 18GHz	4.05 dB	
			18 - 40GHz	4.04 dB	

Our calculated Measurement Instrumentation Uncertainty is shown in the tables above. These are our U_{lab} values in CISPR 16-4-2 terminology.

Since Table 1 of CISPR 16-4-2 has values of measurement instrumentation uncertainty, called U_{CISPR} , as follows:

Conducted Disturbance (mains port) – 150 kHz – 30 MHz : 3.6 dB

Radiated Disturbance (electric field strength on an open area test site or alternative test site) – 30 MHz – 1000 MHz : 5.2 dB

It can be seen that our U_{lab} values are smaller than U_{CISPR} .

3. GENERAL INFORMATION

3.1 GENERAL DESCRIPTION OF EUT

Equipment	BT Barcode Scanner	
Brand Name	CIPHERLAB	
Model Name	1564A	
Model Difference	N/A	
Output Power (Max.)	Operation Frequency	2402~2480 MHz
	Modulation Technology	GFSK(1Mbps) $\pi/4$ -DQPSK(2Mbps)
	Bit Rate of Transmitter	8-DPSK(3Mbps)
	Output Power Max.	7.61 dBm (0.0058W) (1Mbps) 6.63 dBm (0.0046W) (3Mbps)
Power Source	Supplied from Li-ion battery Pack. Model BA-001800	
Power Rating	DC 3.7V 800mAh, 2.96Wh	

Note:

1. For a more detailed features description, please refer to the manufacturer's specifications or the User's Manual.

2.

Channel List					
Channel	Frequency (MHz)	Channel	Frequency (MHz)	Channel	Frequency (MHz)
00	2402	27	2429	54	2456
01	2403	28	2430	55	2457
02	2404	29	2431	56	2458
03	2405	30	2432	57	2459
04	2406	31	2433	58	2460
05	2407	32	2434	59	2461
06	2408	33	2435	60	2462
07	2409	34	2436	61	2463
08	2410	35	2437	62	2464
09	2411	36	2438	63	2465
10	2412	37	2439	64	2466
11	2413	38	2440	65	2467
12	2414	39	2441	66	2468
13	2415	40	2442	67	2469
14	2416	41	2443	68	2470
15	2417	42	2444	69	2471
16	2418	43	2445	70	2472
17	2419	44	2446	71	2473
18	2420	45	2447	72	2474
19	2421	46	2448	73	2475
20	2422	47	2449	74	2476
21	2423	48	2450	75	2477
22	2424	49	2451	76	2478
23	2425	50	2452	77	2479
24	2426	51	2453	78	2480
25	2427	52	2454		
26	2428	53	2455		

3 Table for Filed Antenna

Ant	Brand	Model Name	Antenna Type	Connector	Gain (dBi)	Note
1	Cipherlab	1564 BT Antenna	PIFA	N/A	-0.074	-

3.2 DESCRIPTION OF TEST MODES

To investigate the maximum EMI emission characteristics generated from EUT, the test system was pre-scanning tested based on the consideration of following EUT operation mode or test configuration mode which possibly have effect on EMI emission level. Each of these EUT operation mode(s) or test configuration mode(s) mentioned above was evaluated respectively.

Pretest Mode	Description
Mode 1	TX Mode Note (1)
Mode 2	Bluetooth

The EUT system operated these modes were found to be the worst case during the pre-scanning test as following:

For Conducted Emission	
Final Test Mode	Description
Mode 2	Bluetooth

For Radiated Emission	
Final Test Mode	Description
Mode 1	TX Mode Note (1)

Note:

- (1) The measurements are performed at the high, middle, low available channels.
- (2) The measurements for Hopping Channel Separation, Bandwidth and Peak Output Power were tested during 1Mbps, 2Mbps and 3Mbps, the worst case are 1Mbps and 3Mbps, only worst case was documented.

3.3 TABLE OF PARAMETERS OF TEST SOFTWARE SETTING

During testing, channel & power controlling software provided by the customer was used to control the operating channel as well as the output power level. The RF output power selection is for the setting of RF output power expected by the customer and is going to be fixed on the firmware of the final end product power parameters of FHSS

1Mbps

Test Software Version	HARDWARE CONTROL		
Frequency (MHz)	2402	2441	2480
Parameters	N/A	N/A	N/A

3Mbps

Test Software Version	HARDWARE CONTROL		
Frequency (MHz)	2402	2441	2480
Parameters	N/A	N/A	N/A

3.4 BLOCK DIAGRAM SHOWING THE CONFIGURATION OF SYSTEM TESTED

Radiated TX Mode:

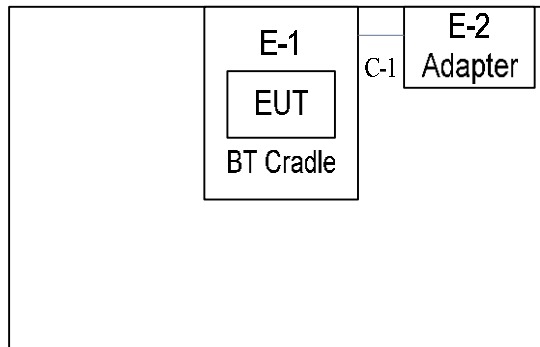

3.5 DESCRIPTION OF SUPPORT UNITS

The EUT has been tested as an independent unit together with other necessary accessories or support units. The following support units or accessories were used to form a representative test configuration during the tests.

Item	Equipment	Mfr/Brand	Model/Type No.	FCC ID/IC	Series No.	Note
E-1	BT Cradle	CIPHERLAB	3656	Q3N-3656	N/A	
E-2	Adapter	Balance electronic Co.,LTD	GPSS-0500200	N/A	N/A	

Item	Shielded Type	Ferrite Core	Length	Note
C-1	NO	YES	1.5m	

4. EMC EMISSION TEST

4.1 CONDUCTED EMISSION MEASUREMENT

4.1.1 POWER LINE CONDUCTED EMISSION Limits (Frequency Range 150KHz-30MHz)

Frequency of Emission (MHz)	Conducted Limit (dB μ V)	
	Quasi-peak	Average
0.15 -0.5	66 to 56*	56 to 46*
0.50 -5.0	56	46
5.0 -30.0	60	50

Note:

- (1) The limit of " * " decreases with the logarithm of the frequency
- (2) The test result calculated as following:
 Measurement Value = Reading Level + Correct Factor
 Correct Factor = Antenna Factor + Cable Loss - Amplifier Gain(if use)
 Margin Level = Measurement Value - Limit Value

The following table is the setting of the receiver

Receiver Parameters	Setting
Attenuation	10 dB
Start Frequency	0.15 MHz
Stop Frequency	30 MHz
IF Bandwidth	9 KHz

4.1.2 TEST PROCEDURE

- a. The EUT was placed 0.8 meters from the horizontal ground plane with EUT being connected to the power mains through a line impedance stabilization network (LISN). All other support equipments powered from additional LISN(s). The LISN provide 50 Ohm/ 50uH of coupling impedance for the measuring instrument.
- b. Interconnecting cables that hang closer than 40 cm to the ground plane shall be folded back and forth in the center forming a bundle 30 to 40 cm long.
- c. I/O cables that are not connected to a peripheral shall be bundled in the center. The end of the cable may be terminated, if required, using the correct terminating impedance. The overall length shall not exceed 1 m.
- d. LISN at least 80 cm from nearest part of EUT chassis.
- e. For the actual test configuration, please refer to the related Item –EUT Test Photos.

4.1.3 DEVIATION FROM TEST STANDARD

No deviation

4.1.4 TEST SETUP

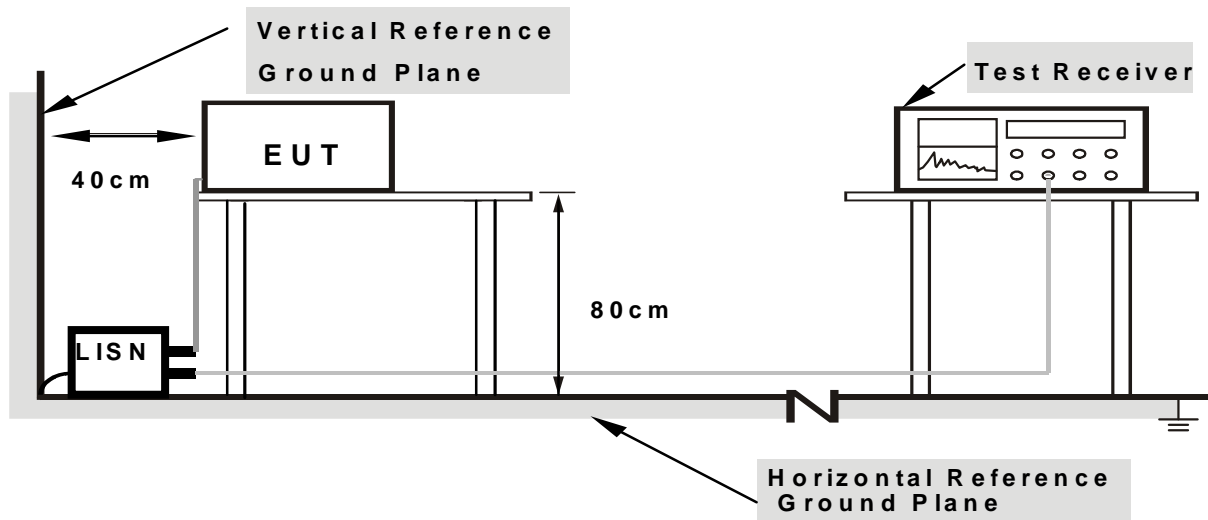

Note: 1.Support units were connected to second LISN.

2.Both of LISNs (AMN) are 80 cm from EUT and at least 80 from other units and other metal planes

4.1.5 EUT OPERATING CONDITIONS

The EUT was configured for testing in a typical function (as a customer would normally use it), EUT was programmed to be in continuously transmitting/receiving data or hopping on mode.

4.1.6 EUT TEST CONDITIONS

Temperature: N/A°C

Relative Humidity: N/A %

Test Voltage: N/A

4.1.7 TEST RESULTS

Please refer to the Attachment A.

Remark:

- (1) All readings are QP Mode value unless otherwise stated AVG in column of Note. If the QP Mode Measured value compliance with the QP Limits and lower than AVG Limits, the EUT shall be deemed to meet both QP & AVG Limits and then only QP Mode was measured, but AVG Mode didn't perform in this case, a "*" marked in AVG Mode column of Interference Voltage Measured.
- (2) Measuring frequency range from 150KHz to 30MHz.

4.2 RADIATED EMISSION MEASUREMENT

4.2.1 RADIATED EMISSION LIMITS (Frequency Range 9KHz -1000MHz)

20dB in any 100 KHz bandwidth outside the operating frequency band. In case the emission fall within the restricted band specified on 15.205(a) & RSS-210 section 2.2& Annex 8 (A8.5), then the 15.209(a) & RSS-Gen limit in the table below has to be followed.

Frequency (MHz)	Field Strength (microvolts/meter)	Measurement Distance (meters)
0.009~0.490	2400/F(KHz)	300
0.490~1.705	24000/F(KHz)	30
1.705~30.0	30	30
30~88	100	3
88~216	150	3
216~960	200	3
960~1000	500	3

LIMITS OF RADIATED EMISSION MEASUREMENT (Above 1000MHz)

Frequency (MHz)	dB(uV/m) (at 3 meters)	
	Peak	Average
Above 1000	74	54

Notes:

- (1) The limit for radiated test was performed according to FCC PART 15C.
- (2) The tighter limit applies at the band edges.
- (3) Emission level (dBuV/m) =20log Emission level (uV/m).

Spectrum Parameter	Setting
Attenuation	Auto
Start Frequency	1000 MHz
Stop Frequency	10th carrier harmonic
RBW / VBW (emission in restricted band)	1 MHz / 1 MHz for Peak, 1 MHz / 10Hz for Average

Spectrum Receiver Parameter	Setting
Attenuation	Auto
Start ~ Stop Frequency	9KHz ~90KHz for PK/AVG detector
Start ~ Stop Frequency	90KHz ~110KHz for QP detector
Start ~ Stop Frequency	110KHz ~490KHz for PK/AVG detector
Start ~ Stop Frequency	490KHz ~30MHz for QP detector
Start ~ Stop Frequency	30MHz~1000MHz for QP detector

4.2.2 TEST PROCEDURE

- a. The EUT was placed on the top of a rotating table 0.8 meters above the ground at a 3 meter semi-anechoic chamber. The table was rotated 360 degrees to determine the position of the highest radiation.(below 1GHz)
- b. The EUT was placed on the top of a rotating table 0.8 meters above the ground at a 3 meter semi-anechoic chamber. The table was rotated 360 degrees to determine the position of the highest radiation.(above 1GHz)
- c. The height of the equipment or of the substitution antenna shall be 0.8 m; the height of the test antenna shall vary between 1 m to 4 m. Both horizontal and vertical polarizations of the antenna are set to make the measurement.
- d. The initial step in collecting conducted emission data is a spectrum analyzer peak detector mode pre-scanning the measurement frequency range. Significant peaks are then marked and then Quasi Peak detector mode re-measured.
- e. If the Peak Mode measured value compliance with and lower than Quasi Peak Mode Limit, the EUT shall be deemed to meet QP Limits and then no additional QP Mode measurement performed.
- f. For the actual test configuration, please refer to the related Item –EUT Test Photos.

4.2.3 DEVIATION FROM TEST STANDARD

No deviation

4.2.4 TEST SETUP

(A) Radiated Emission Test Set-Up Frequency Below 1 GHz

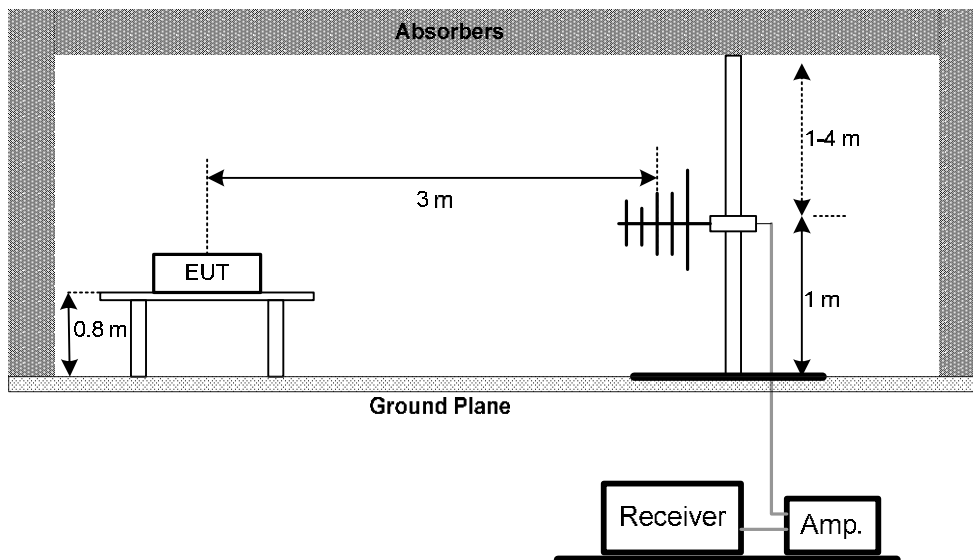

(B) Radiated Emission Test Set-Up Frequency Above 1 GHz

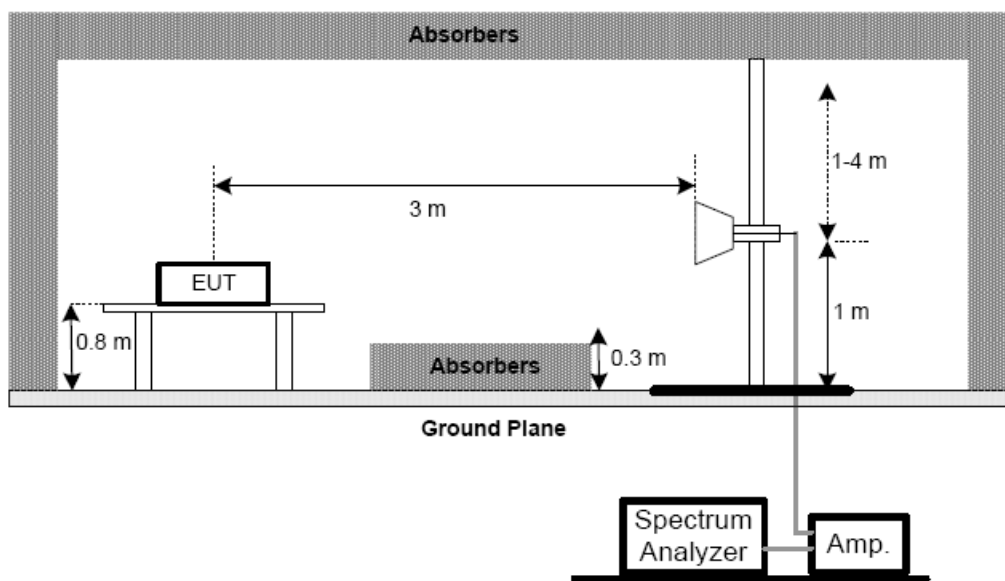

(C) For radiated emissions below 30MHz

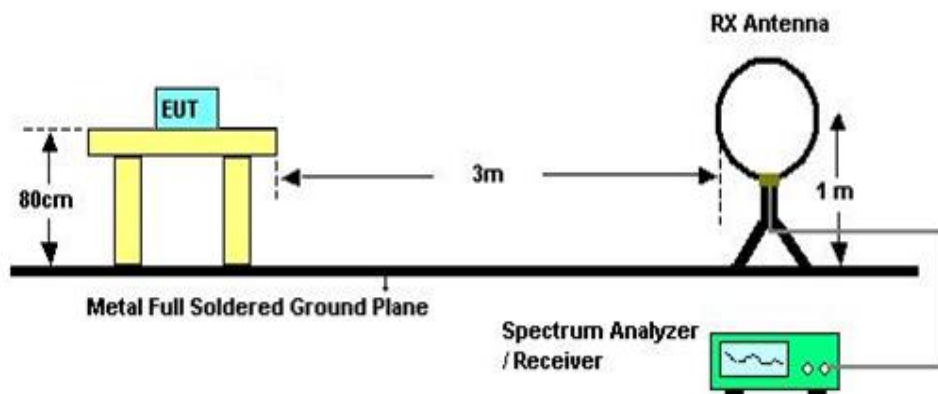

4.2.5 EUT OPERATING CONDITIONS

The EUT tested system was configured as the statements of 4.1.5 Unless otherwise a special operating condition is specified in the follows during the testing

4.2.6 EUT TEST CONDITIONS

Temperature: 21°C
 Relative Humidity: 62%
 Test Voltage: DC 3.7V

4.2.7 TEST RESULTS (9KHZ TO 30MHZ)

Please refer to the Attachment B

Remark:

- (1) The amplitude of spurious emissions which are attenuated by more than 20 dB below the permissible value has no need to be reported.
- (2) Distance extrapolation factor = $40 \log(\text{specific distance} / \text{test distance})$ (dB).
- (3) Limit line = specific limits (dBuV) + distance extrapolation factor.

4.2.8 TEST RESULTS (BETWEEN 30MHZ TO 1000 MHZ)

Please refer to the Attachment C.

Remark:

- (1) Reading in which marked as QP or Peak means measurements by using are Quasi-Peak Mode or Peak Mode with Detector BW=120KHz ; SPA setting in RBW=120KHz, VBW =120KHz, Swp. Time = 0.3 sec./MHz.
- (2) All readings are Peak unless otherwise stated QP in column of 『Note 』 . Peak denotes that the Peak reading compliance with the QP Limits and then QP Mode measurement didn't perform.
- (3) Measuring frequency range from 30MHz to 1000MHz.
- (4) If the peak scan value lower limit more than 20dB, then this signal data does not show in table.

4.2.9 TEST RESULTS (ABOVE 1000 MHZ)

Please refer to the Attachment D.

Remark:

- (1) All readings are Peak unless otherwise stated QP in column of 『Note 』 . Peak denotes that the Peak reading compliance with the QP Limits and then QP Mode measurement didn't perform.
- (2) Radiated emissions measured in frequency range above 1000MHz were made with an instrument using Peak detector mode and AV detector mode of the emission
- (3) A preamp and high pass filter were used for this test in order to provide sufficient measurement sensitivity.
- (4) EUT Orthogonal Axis:
"X" - denotes Laid on Table ; "Y" - denotes Vertical Stand ; "Z" - denotes Side Stand
- (5) During the measurements above 1 GHz it is taken care of that the EUT is always within the 3 dB cone of radiation BW of the used antenna
- (6) No limit: This is fundamental signal, the judgment is not applicable.
For fundamental signal judgment was referred to Peak output test.

5. NUMBER OF HOPPING CHANNEL

5.1 APPLIED PROCEDURES

FCC Part15 (15.247) , Subpart C/ RSS-GEN and RSS-210			
Section	Test Item	Frequency Range (MHz)	Result
15.247(a)(1)(iii) RSS-210, Issue 8, Annex 8, A8.1(d)	Number of Hopping Channel	2400-2483.5	PASS

Spectrum Parameters	Setting
Attenuation	Auto
Span Frequency	> Operating Frequency Range
RBW	100 KHz
VBW	100 KHz
Detector	Peak
Trace	Max Hold
Sweep Time	Auto

5.1.1 TEST PROCEDURE

- a. The EUT was directly connected to the spectrum analyzer and antenna output port as show in the block diagram below,
- b. Spectrum Setting: RBW=100KHz, VBW=100KHz, Sweep time = Auto.

5.1.2 DEVIATION FROM STANDARD

No deviation.

5.1.3 TEST SETUP



5.1.4 EUT OPERATION CONDITIONS

The EUT tested system was configured as the statements of 4.1.5 Unless otherwise a special operating condition is specified in the follows during the testing.

5.1.5 EUT TEST CONDITIONS

Temperature: 25°C
 Relative Humidity: 55%
 Test Voltage: DC 3.7V

5.1.6 TEST RESULTS

Please refer to the Attachment E

6. AVERAGE TIME OF OCCUPANCY

6.1 APPLIED PROCEDURES / LIMIT

FCC Part15 (15.247) , Subpart C/ RSS-GEN and RSS-210				
Section	Test Item	Limit	Frequency Range (MHz)	Result
15.247(a)(1)(iii) RSS-210, Issue 8, Annex 8, A8.1(d)	Average Time of Occupancy	0.4sec	2400-2483.5	PASS

6.1.1 TEST PROCEDURE

- a. The transmitter output (antenna port) was connected to the spectrum analyzer
- b. Set RBW of spectrum analyzer to 1MHz and VBW to 1MHz.
- c. Use a video trigger with the trigger level set to enable triggering only on full pulses.
- d. Sweep Time is more than once pulse time.
- e. Set the center frequency on any frequency would be measure and set the frequency span to zero span.
- f. Measure the maximum time duration of one single pulse.
- g. Set the EUT for DH5, DH3 and DH1 packet transmitting.
- h. Measure the maximum time duration of one single pulse.
- i. DH5 Packet permit maximum $1600 / 79 / 6 = 3.37$ hops per second in each channel (5 time slots TX, 1 time slot RX). So, the dwell time is the time duration of the pulse times $3.37 \times 31.6 = 106.6$ within 31.6 seconds.
- j. DH3 Packet permit maximum $1600 / 79 / 4 = 5.06$ hops per second in each channel (3 time slots TX, 1 time slot RX). So, the dwell time is the time duration of the pulse times $5.06 \times 31.6 = 160$ within 31.6 seconds.
- k. DH1 Packet permit maximum $1600 / 79 / 2 = 10.12$ hops per second in each channel (1 time slot TX, 1 time slot RX). So, the dwell time is the time duration of the pulse times $10.12 \times 31.6 = 320$ within 31.6 seconds.

6.1.2 DEVIATION FROM STANDARD

No deviation.

6.1.3 TEST SETUP

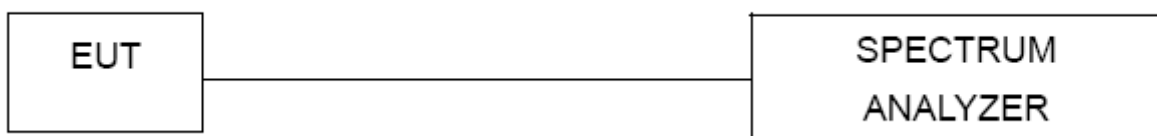

6.1.4 EUT OPERATION CONDITIONS

The EUT tested system was configured as the statements of 4.1.5 Unless otherwise a special operating condition is specified in the follows during the testing.

6.1.5 EUT TEST CONDITIONS

Temperature: 25°C

Relative Humidity: 55%

Test Voltage: DC 3.7V

6.1.6 TEST RESULTS

Please refer to the Attachment F

7. HOPPING CHANNEL SEPARATION MEASUREMENT

7.1 APPLIED PROCEDURES / LIMIT

Frequency hopping systems operating in the 2400-2483.5 MHz band may have hopping channel carrier frequencies that are separated by 25 KHz or two-thirds of the 20 dB bandwidth of the hopping channel, whichever is greater.

Spectrum Parameter	Setting
Attenuation	Auto
Span Frequency	> Measurement Bandwidth or Channel Separation
RBW	30 KHz
VBW	100 KHz
Detector	Peak
Trace	Max Hold
Sweep Time	Auto

7.1.1 TEST PROCEDURE

- a. The EUT must have its hopping function enabled
- b. Span = wide enough to capture the peaks of two adjacent channels
 Resolution (or IF) Bandwidth (RBW) \geq 1% of the span
 Video (or Average) Bandwidth (VBW) \geq RBW
 Sweep = Auto
 Detector function = Peak
 Trace = Max Hold

7.1.2 DEVIATION FROM STANDARD

No deviation.

7.1.3 TEST SETUP

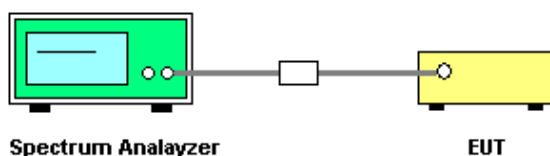

7.1.4 EUT TEST CONDITIONS

Temperature: 25°C
 Relative Humidity: 55%
 Test Voltage: DC 3.7V

7.1.5 TEST RESULTS

Please refer to the Attachment G

8. BANDWIDTH TEST

8.1 APPLIED PROCEDURES

FCC Part15 (15.247) , Subpart C/ RSS-GEN and RSS-210		
Section	Test Item	Frequency Range (MHz)
15.247(a)(2) RSS-GEN section 4.6.1 RSS-210, Issue 8, Annex 8, A8.1(b)	Bandwidth	2400-2483.5

Spectrum Parameter	Setting
Attenuation	Auto
Span Frequency	> Measurement Bandwidth or Channel Separation
RBW	30 KHz (20dB Bandwidth) / 30 KHz (Channel Separation)
VBW	100 KHz (20dB Bandwidth) / 100 KHz (Channel Separation)
Detector	Peak
Trace	Max Hold
Sweep Time	Auto

8.1.1 TEST PROCEDURE

- a. The EUT was directly connected to the spectrum analyzer and antenna output port as show in the block diagram below,
- b. Spectrum Setting: RBW= 30KHz, VBW=100KHz, Sweep Time = Auto.

8.1.2 DEVIATION FROM STANDARD

No deviation.

8.1.3 TEST SETUP

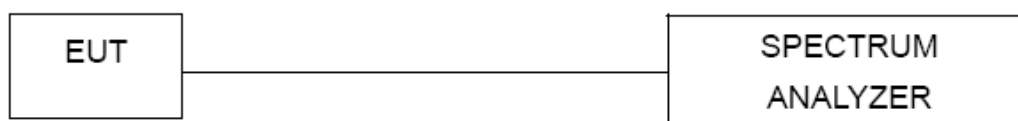

8.1.4 EUT OPERATION CONDITIONS

The EUT tested system was configured as the statements of 4.1.5 Unless otherwise a special operating condition is specified in the follows during the testing.

8.1.5 EUT TEST CONDITIONS

Temperature: 25°C
Relative Humidity: 55%
Test Voltage: DC 3.7V

8.1.6 TEST RESULTS

Please refer to the Attachment H

9. PEAK OUTPUT POWER TEST

9.1 APPLIED PROCEDURES / LIMIT

FCC Part15 (15.247) , Subpart C/ RSS-GEN and RSS-210				
Section	Test Item	Limit	Frequency Range (MHz)	Result
15.247(b)(1) RSS-GEN section 4.8 RSS-210, Issue 8, Annex 8, A8.1(b)	Peak Output Power	1 Watt or 30dBm	2400-2483.5	PASS

9.1.1 TEST PROCEDURE

- The EUT was directly connected to the spectrum analyzer and antenna output port as show in the block diagram below,
- Spectrum Setting: RBW= 1MHz/3MHz, VBW= 1MHz/3MHz, Sweep time = Auto.

9.1.2 DEVIATION FROM STANDARD

No deviation.

9.1.3 TEST SETUP



9.1.4 EUT OPERATION CONDITIONS

The EUT tested system was configured as the statements of 4.1.5 Unless otherwise a special operating condition is specified in the follows during the testing.

9.1.5 EUT TEST CONDITIONS

Temperature: 25°C
Relative Humidity: 55%
Test Voltage: DC 3.7V

9.1.6 TEST RESULTS

Please refer to the Attachment I

10. ANTENNA CONDUCTED SPURIOUS EMISSION

10.1 APPLIED PROCEDURES / LIMIT

In any 100 kHz bandwidth outside the frequency band in which the spread spectrum or digitally modulated intentional radiator is operating, the radio frequency power that is produced by the intentional radiator shall be at least 20 dB below that in the 100 kHz bandwidth within the band that contains the highest level of the desired power, based on either an RF conducted measurement, provided the transmitter demonstrates compliance with the peak conducted power limits.

10.1.1 TEST PROCEDURE

- a. The EUT was directly connected to the spectrum analyzer and antenna output port as show in the block diagram below,
- b. Spectrum Setting: RBW= 100KHz, VBW=100KHz, Sweep time = Auto.

10.1.2 DEVIATION FROM STANDARD

No deviation.

10.1.3 TEST SETUP



10.1.4 EUT OPERATION CONDITIONS

The EUT tested system was configured as the statements of 4.1.5 Unless otherwise a special operating condition is specified in the follows during the testing.

10.1.5 EUT TEST CONDITIONS

Temperature: 25°C
Relative Humidity: 55%
Test Voltage: DC 3.7V

10.1.6 TEST RESULTS

Please refer to the Attachment J

11. MEASUREMENT INSTRUMENTS LIST

Radiated Emission Measurement					
Item	Kind of Equipment	Manufacturer	Type No.	Serial No.	Calibrated until
1	Spectrum Analyzer	R&S	FSP-40	100129	Oct. 13, 2015
2	Horn Antenna	Schwarzbeck	BBHA 9120	D-325	Jun. 14, 2015
3	Microwave Pre_amplifier	Agilent	8449B	3008A01714	Apr. 15, 2015
4	Microflex Cable	Harbour industries	27478LL142	1m	May. 12, 2015
5	Microflex Cable	EMC	S104-SMA	8m	May. 14, 2015
6	Microflex Cable	Harbour industries	27478LL142	3m	May. 12, 2015
7	Test Cable	LMR	LMR-400	12m	May. 13, 2015
8	Test Cable	LMR	LMR-400	3m	May. 13, 2015
9	Pre-Amplifier	Anritsu	MH648A	M92649	Jun. 17, 2015
10	Log-Bicon Antenna	Schwarzbeck	VULB9168-35 2	9168-352	July. 10, 2015

Number of Hopping Channel					
Item	Kind of Equipment	Manufacturer	Type No.	Serial No.	Calibrated until
1	Spectrum Analyzer	R&S	FSP-40	100129	Oct. 13, 2015

Average Time of Occupancy					
Item	Kind of Equipment	Manufacturer	Type No.	Serial No.	Calibrated until
1	Spectrum Analyzer	R&S	FSP-40	100129	Oct. 13, 2015

Hopping Channel Separation Measurement					
Item	Kind of Equipment	Manufacturer	Type No.	Serial No.	Calibrated until
1	Spectrum Analyzer	R&S	FSP-40	100129	Oct. 13, 2015

Bandwidth					
Item	Kind of Equipment	Manufacturer	Type No.	Serial No.	Calibrated until
1	Spectrum Analyzer	R&S	FSP-40	100129	Oct. 13, 2015

Peak Output Power

Item	Kind of Equipment	Manufacturer	Type No.	Serial No.	Calibrated until
1	Spectrum Analyzer	R&S	FSP-40	100129	Oct. 13, 2015

Antenna Conducted Spurious Emission

Item	Kind of Equipment	Manufacturer	Type No.	Serial No.	Calibrated until
1	Spectrum Analyzer	R&S	FSP-40	100129	Oct. 13, 2015

Remark: "N/A" denotes no model name, serial no. or calibration specified.
All calibration period of equipment list is one year.

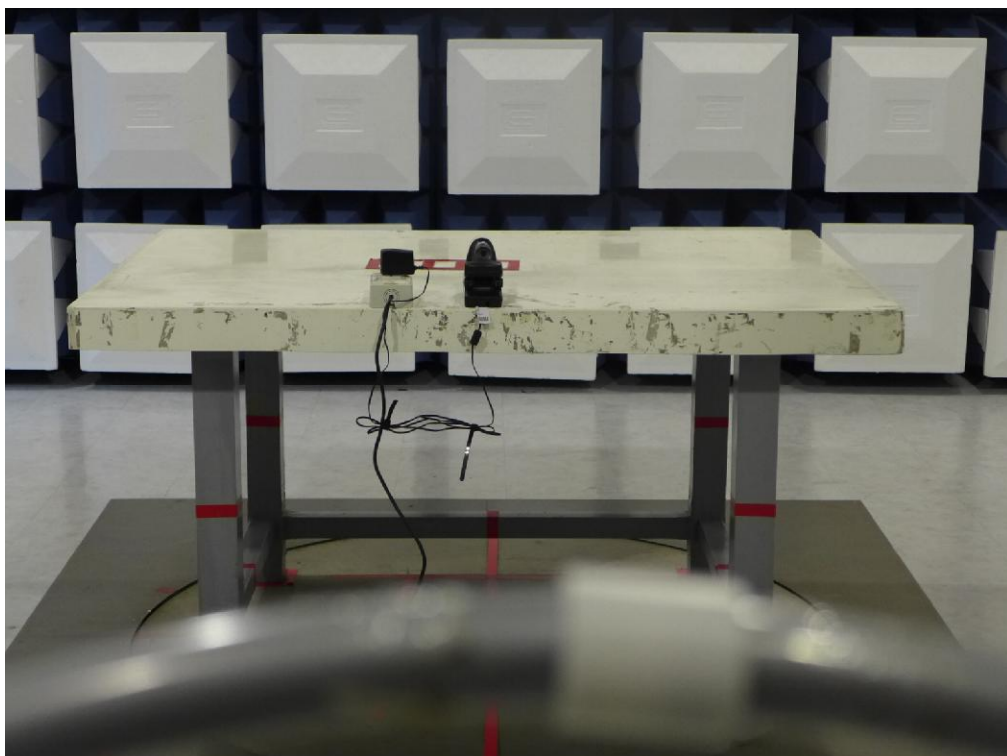
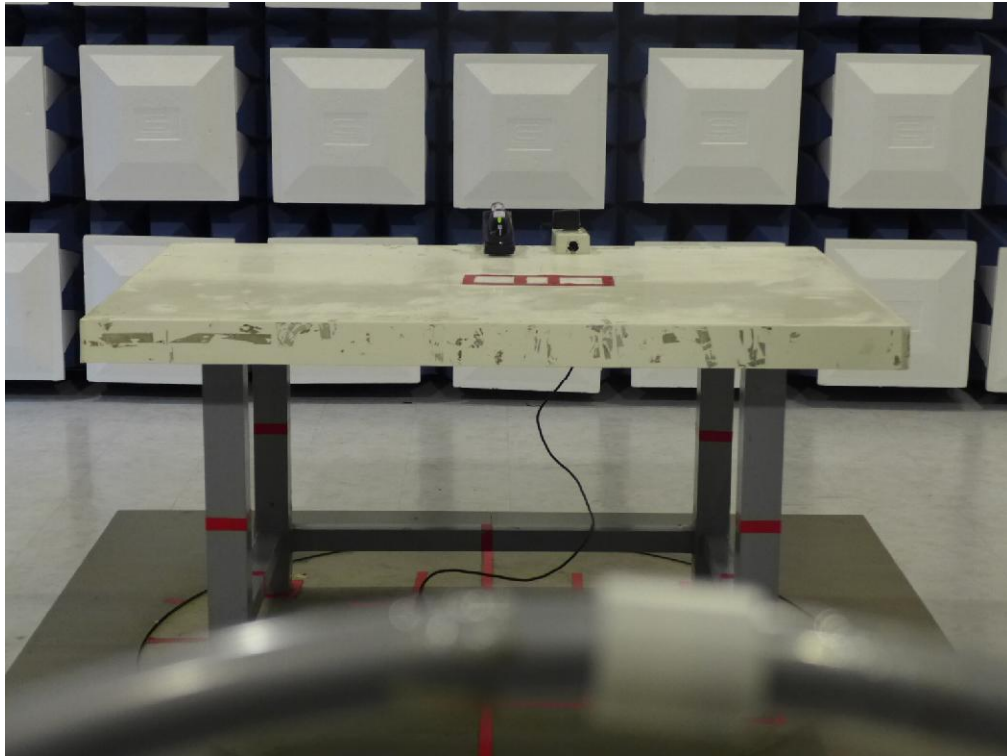
12. EUT TEST PHOTO**Radiated Measurement Photos****9K-30MHz**

Radiated Measurement Photos

30MHz-1G

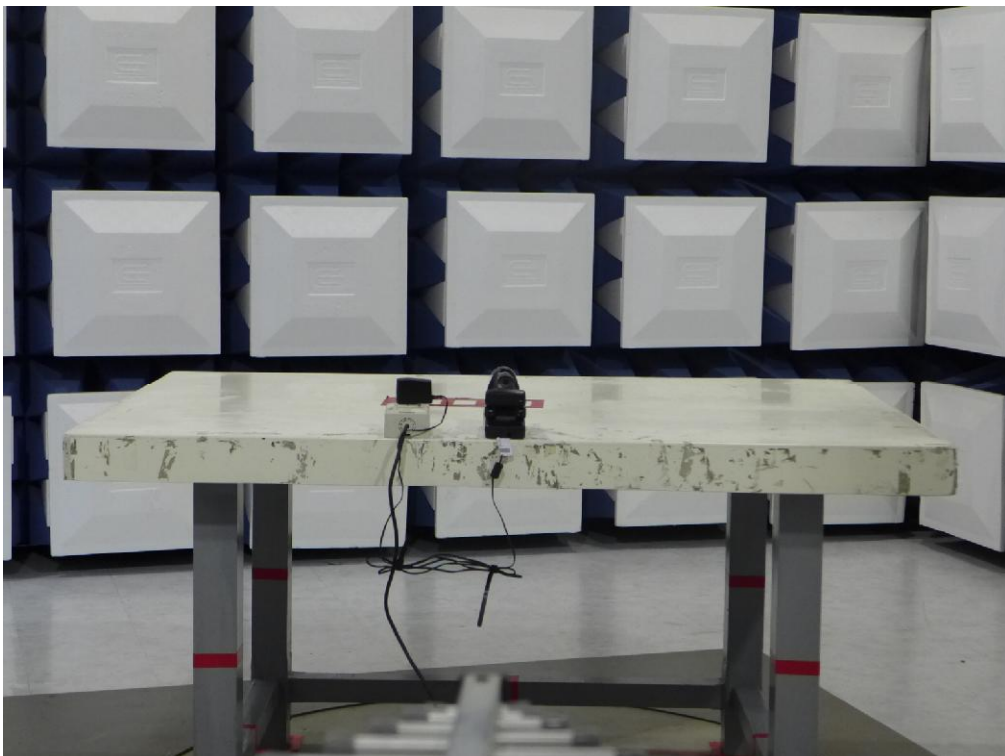
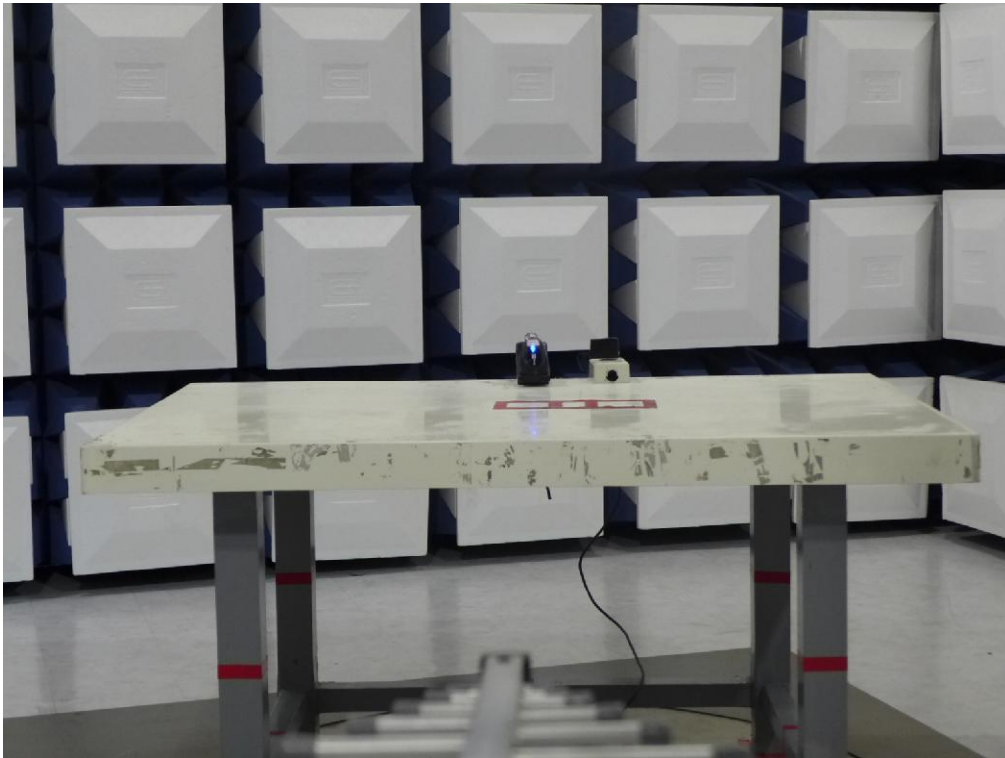

Radiated Measurement Photos

Above 1G

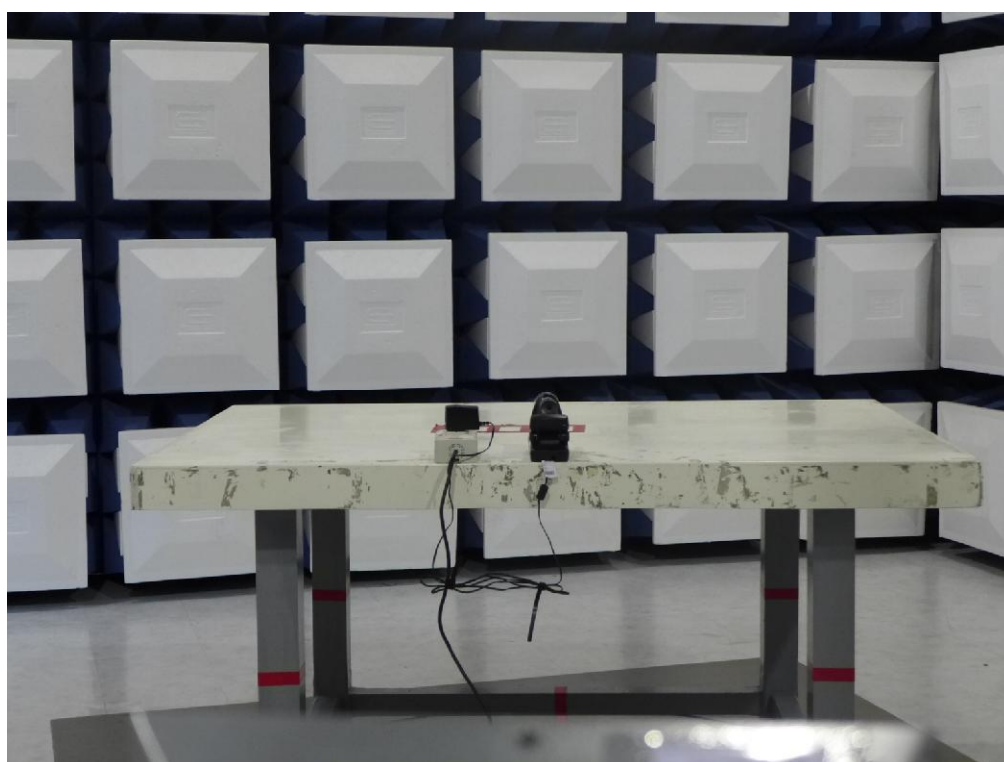

ATTACHMENT A - CONDUCTED EMISSION

Test Mode: N/A

Note: "N/A" denotes test is not applicable to this device.

ATTACHMENT B - RADIATED EMISSION (9KHZ-30MHZ)

Test Mode:	TX Mode
------------	---------

Freq. (MHz)	Ant. 0°/90°	Reading(RA) (dBuV)	Corr.Factor(CF) (dB)	Measured(FS) (dBuV/m)	Limits(QP) (dBuV/m)	Margin (dB)	Note
0.0130	0°	44.20	22.33	66.53	125.33	-58.80	PEAK
0.0130	0°	31.52	22.33	53.85	125.33	-71.48	AV
0.0255	0°	42.10	22.01	64.11	119.47	-55.36	PEAK
0.0255	0°	28.24	22.01	50.25	119.47	-69.22	AV
0.0395	0°	34.64	21.66	56.30	115.67	-59.37	PEAK
0.0395	0°	24.51	21.66	46.17	115.67	-69.50	AV
0.0624	0°	35.92	21.20	57.12	111.70	-54.58	PEAK
0.0624	0°	24.10	21.20	45.30	111.70	-66.40	AV
0.2563	0°	34.18	20.44	54.62	99.43	-44.81	PEAK
0.2563	0°	22.64	20.44	43.08	99.43	-56.35	AV
1.3200	0°	37.34	20.28	57.62	65.19	-7.57	QP

Freq. (MHz)	Ant. 0°/90°	Reading(RA) (dBuV)	Corr.Factor(CF) (dB)	Measured(FS) (dBuV/m)	Limits(QP) (dBuV/m)	Margin (dB)	Note
0.0142	90°	47.34	22.30	69.64	124.56	-54.92	PEAK
0.0142	90°	32.45	22.30	54.75	124.56	-69.81	AV
0.0252	90°	43.15	22.02	65.17	119.58	-54.41	PEAK
0.0252	90°	29.60	22.02	51.62	119.58	-67.96	AV
0.0391	90°	35.47	21.67	57.14	115.76	-58.62	PEAK
0.0391	90°	24.15	21.67	45.82	115.76	-69.94	AV
0.0624	90°	36.74	21.20	57.94	111.70	-53.76	PEAK
0.0624	90°	23.84	21.20	45.04	111.70	-66.66	AV
0.2684	90°	33.37	20.43	53.80	99.03	-45.23	PEAK
0.2684	90°	22.51	20.43	42.94	99.03	-56.09	AV
1.2420	90°	39.45	20.36	59.81	65.72	-5.91	QP

Remark:

- (1) The amplitude of spurious emissions which are attenuated by more than 20 dB below the permissible value has no need to be reported.
- (2) Distance extrapolation factor = 40 log (specific distance / test distance) (dB);
- (3) Limit line = specific limits (dBuV) + distance extrapolation factor.

ATTACHMENT C - RADIATED EMISSION (30MHZ TO 1000MHZ)

Test Mode: TX 2441MHz _CH39_1Mbps

Vertical

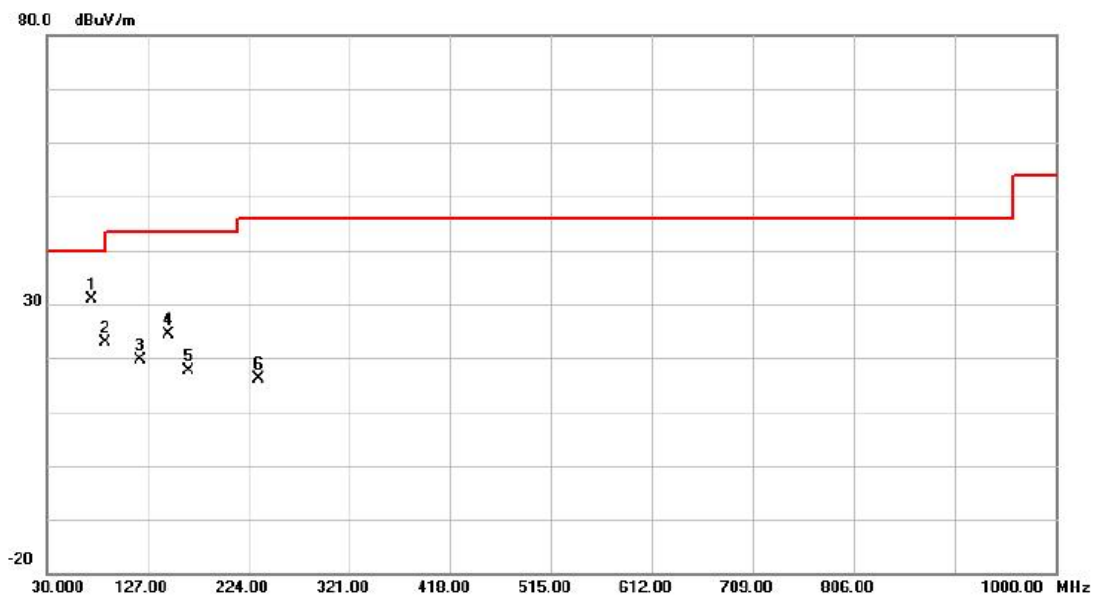

No.	Mk.	Freq. MHz	Reading Level dBuV	Correct Factor dB	Measure- ment dBuV/m	Limit dBuV/m	Over dB	Detector	Comment
1	*	73.6500	47.87	-16.93	30.94	40.00	-9.06	peak	
2		85.7750	42.20	-19.38	22.82	40.00	-17.18	peak	
3		119.7250	36.00	-16.25	19.75	43.50	-23.75	peak	
4		146.4000	38.57	-14.18	24.39	43.50	-19.11	peak	
5		165.8000	31.77	-14.21	17.56	43.50	-25.94	peak	
6		233.7000	31.71	-15.62	16.09	46.00	-29.91	peak	

Test Mode: TX 2441MHz _CH39_1Mbps

Horizontal

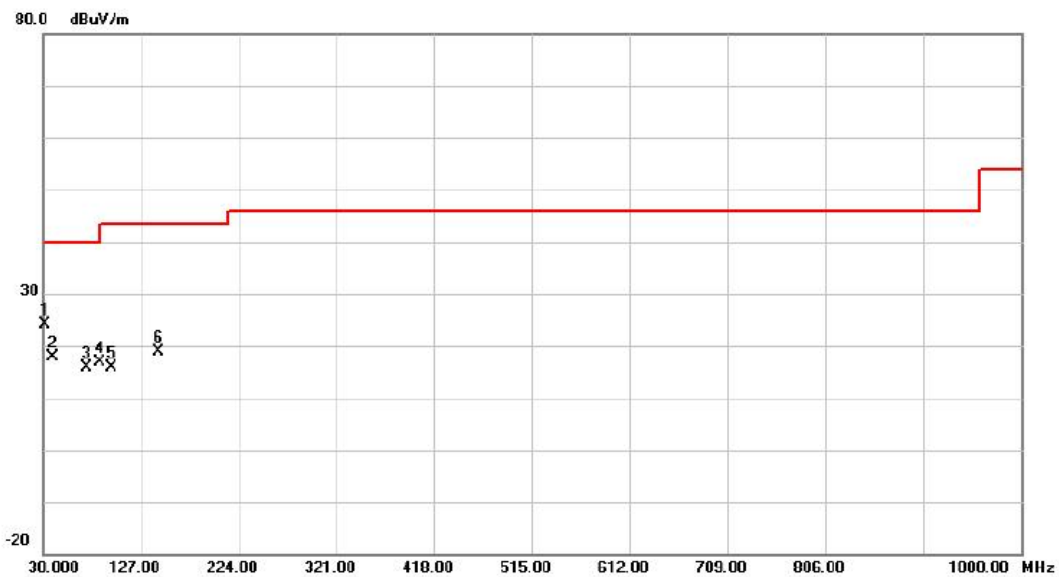

No.	Mk.	Freq. MHz	Reading Level dBuV	Correct Factor dB	Measure- ment dBuV/m	Limit dBuV/m	Over dB	Detector	Comment
1	*	32.4250	39.30	-15.11	24.19	40.00	-15.81	peak	
2		39.7000	32.24	-14.25	17.99	40.00	-22.01	peak	
3		73.6500	32.92	-16.93	15.99	40.00	-24.01	peak	
4		85.7750	36.20	-19.38	16.82	40.00	-23.18	peak	
5		97.9000	35.09	-19.14	15.95	43.50	-27.55	peak	
6		143.9750	33.08	-14.29	18.79	43.50	-24.71	peak	

ATTACHMENT D - RADIATED EMISSION (ABOVE 1000MHZ)

Orthogonal Axis :	X
Test Mode :	TX 2402MHz _CH00_1Mbps

Vertical

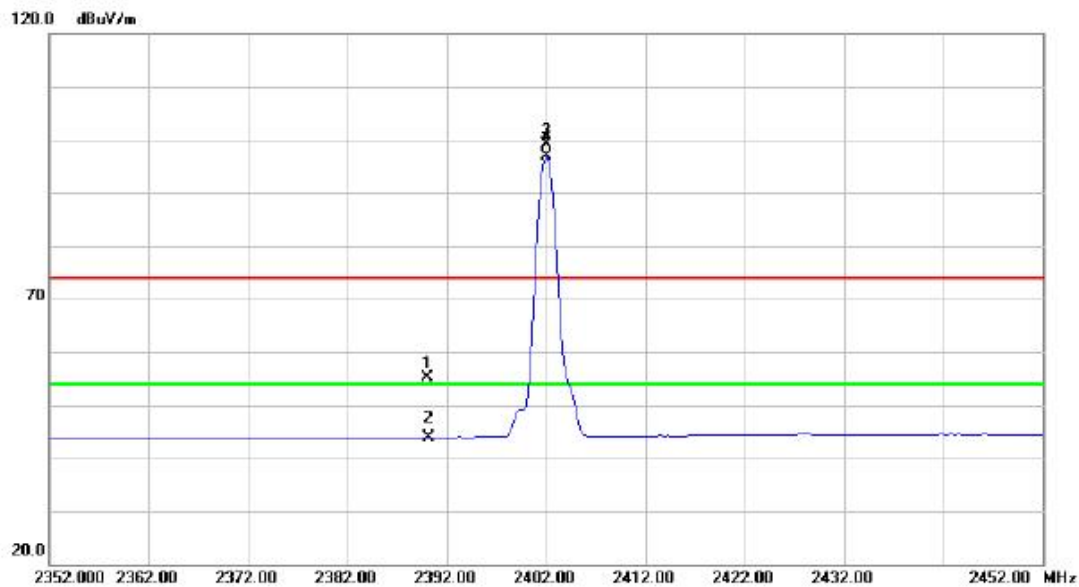

No.	Mk.	Freq.	Reading Level	Correct Factor	Measurement	Limit	Over	Detector	Comment
		MHz	dBuV	dB	dBuV/m	dBuV/m	dB		
1		2390.000	24.11	31.02	55.13	74.00	-18.87	peak	
2		2390.000	12.93	31.02	43.95	54.00	-10.05	AVG	
3	X	2402.000	68.08	31.08	99.16	74.00	25.16	peak	NO LIMIT
4	*	2402.000	65.75	31.08	96.83	54.00	42.83	AVG	NO LIMIT

Orthogonal Axis :	X
Test Mode :	TX 2402MHz _CH00_1Mbps

Vertical

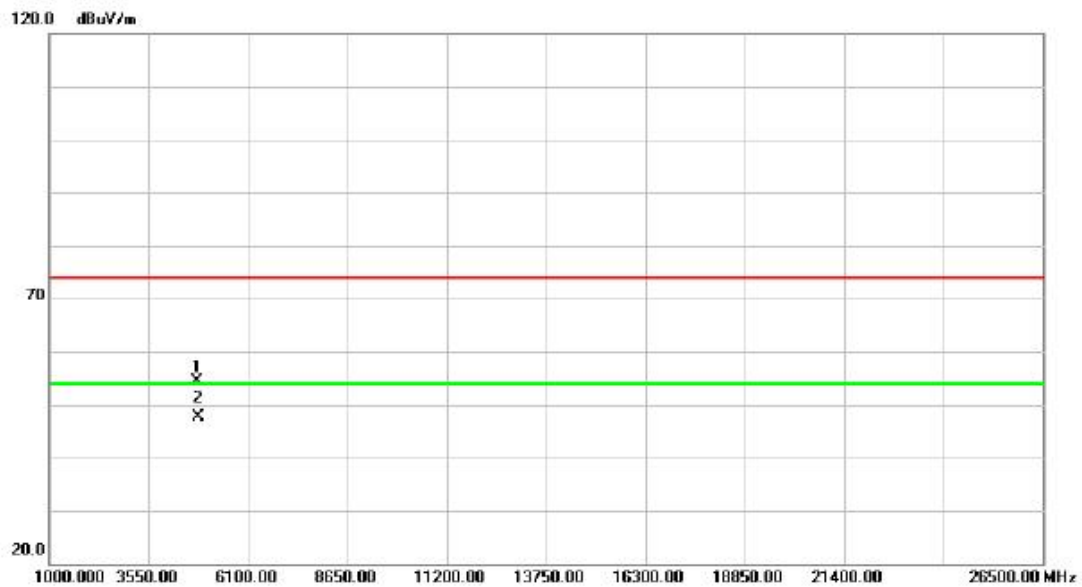

No.	Mk.	Freq. MHz	Reading Level dBuV	Correct Factor dB	Measure- ment dBuV/m	Limit dBuV/m	Over dB	Detector	Comment
1		4804.050	47.56	6.78	54.34	74.00	-19.66	peak	
2	*	4804.050	40.85	6.78	47.63	54.00	-6.37	AVG	

Orthogonal Axis :	X
Test Mode :	TX 2402MHz _CH00_1Mbps

Horizontal

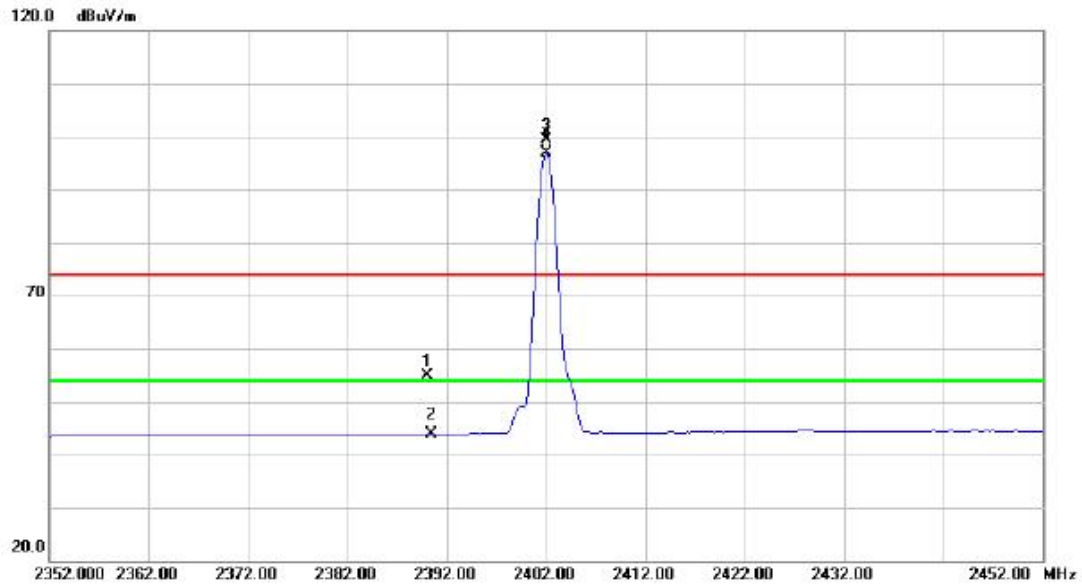

No.	Mk.	Freq.	Reading Level	Correct Factor	Measurement	Limit	Over	Detector	Comment
		MHz	dBuV	dB	dBuV/m	dBuV/m	dB		
1		2390.000	23.75	31.02	54.77	74.00	-19.23	peak	
2		2390.000	12.91	31.02	43.93	54.00	-10.07	AVG	
3	X	2402.000	68.20	31.08	99.28	74.00	25.28	peak	NO LIMIT
4	*	2402.000	65.83	31.08	96.91	54.00	42.91	AVG	NO LIMIT

Orthogonal Axis :	X
Test Mode :	TX 2402MHz _CH00_1Mbps

Horizontal

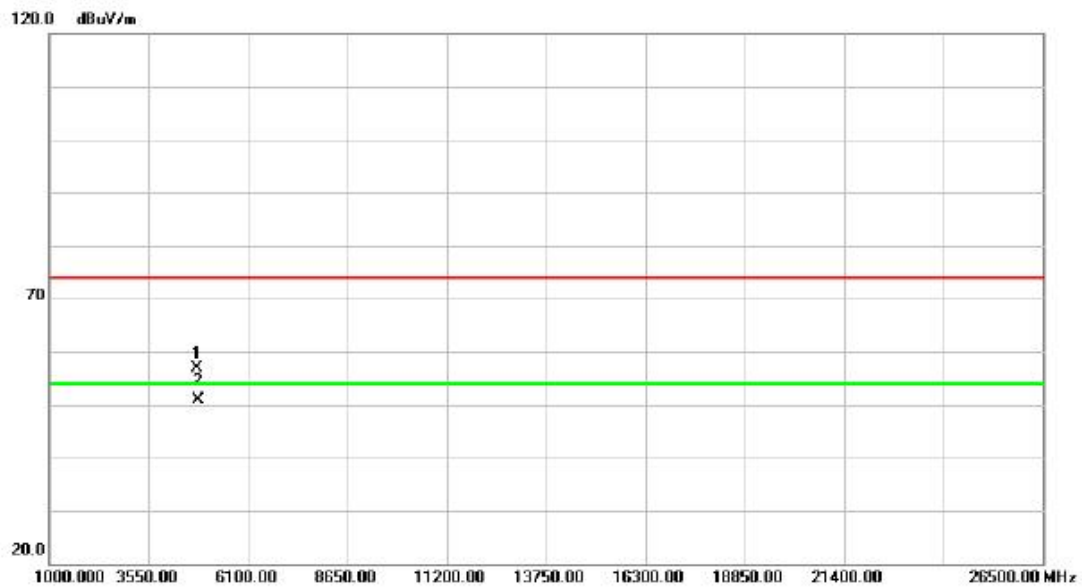

No.	Mk.	Freq. MHz	Reading Level dBuV	Correct Factor dB	Measure- ment dBuV/m	Limit dBuV/m	Over dB	Detector	Comment
1		4804.000	50.20	6.78	56.98	74.00	-17.02	peak	
2	*	4804.000	44.00	6.78	50.78	54.00	-3.22	AVG	

Orthogonal Axis :	X
Test Mode :	TX 2441MHz _CH39_1Mbps

Vertical

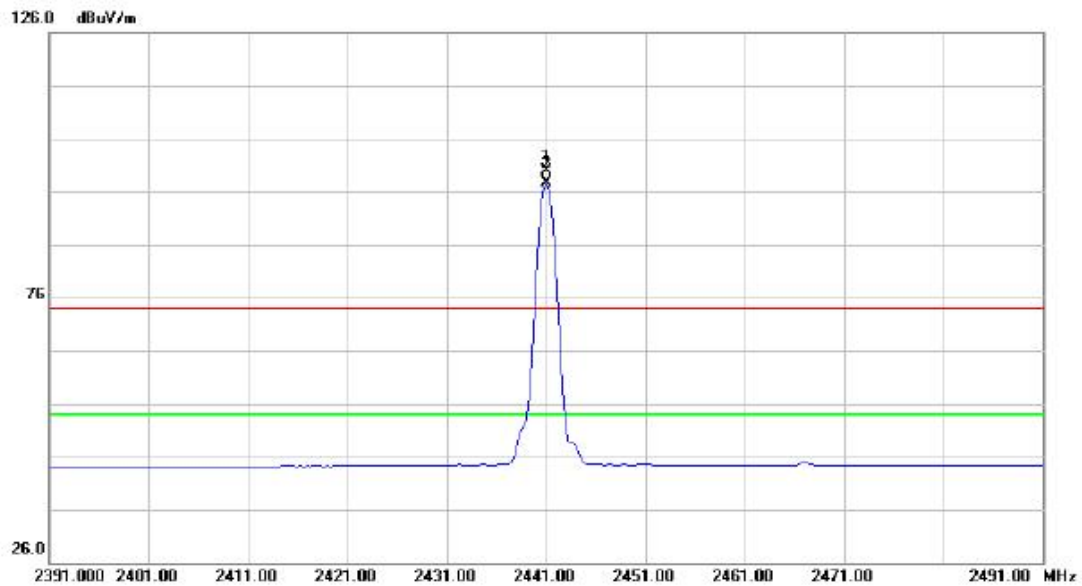

No.	Mk.	Freq.	Reading Level	Correct Factor	Measurement	Limit	Over	Detector	Comment
		MHz	dBuV	dB	dBuV/m	dBuV/m	dB		
1	X	2441.000	68.59	31.26	99.85	74.00	25.85	peak	NO LIMIT
2	*	2441.000	66.27	31.26	97.53	54.00	43.53	AVG	NO LIMIT

Orthogonal Axis :	X
Test Mode :	TX 2441MHz _CH39_1Mbps

Vertical



No. Mk.	Freq. MHz	Reading Level dBuV	Correct Factor dB	Measure- ment dBuV/m	Limit dBuV/m	Over dB	Detector	Comment
1	4882.000	49.34	6.77	56.11	74.00	-17.89	peak	
2 *	4882.000	42.63	6.77	49.40	54.00	-4.60	AVG	

Orthogonal Axis :	X
Test Mode :	TX 2441MHz _CH39_1Mbps

Horizontal

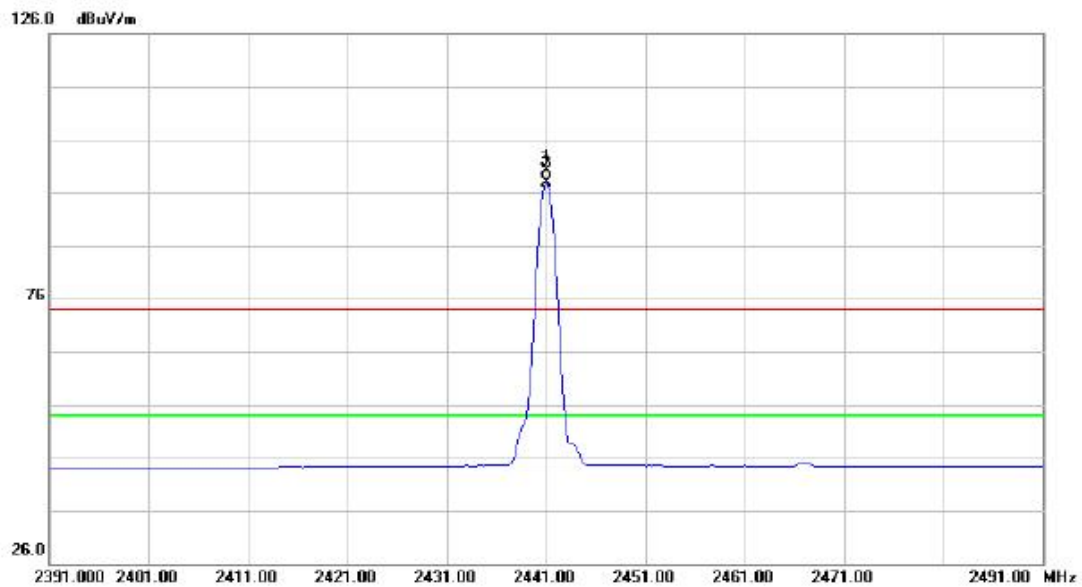

No.	Mk.	Freq.	Reading Level	Correct Factor	Measurement	Limit	Over	Detector	Comment
		MHz	dBuV	dB	dBuV/m	dBuV/m	dB		
1	X	2441.000	68.99	31.26	100.25	74.00	26.25	peak	NO LIMIT
2	*	2441.000	66.58	31.26	97.84	54.00	43.84	AVG	NO LIMIT

Orthogonal Axis :	X
Test Mode :	TX 2441MHz _CH39_1Mbps

Horizontal

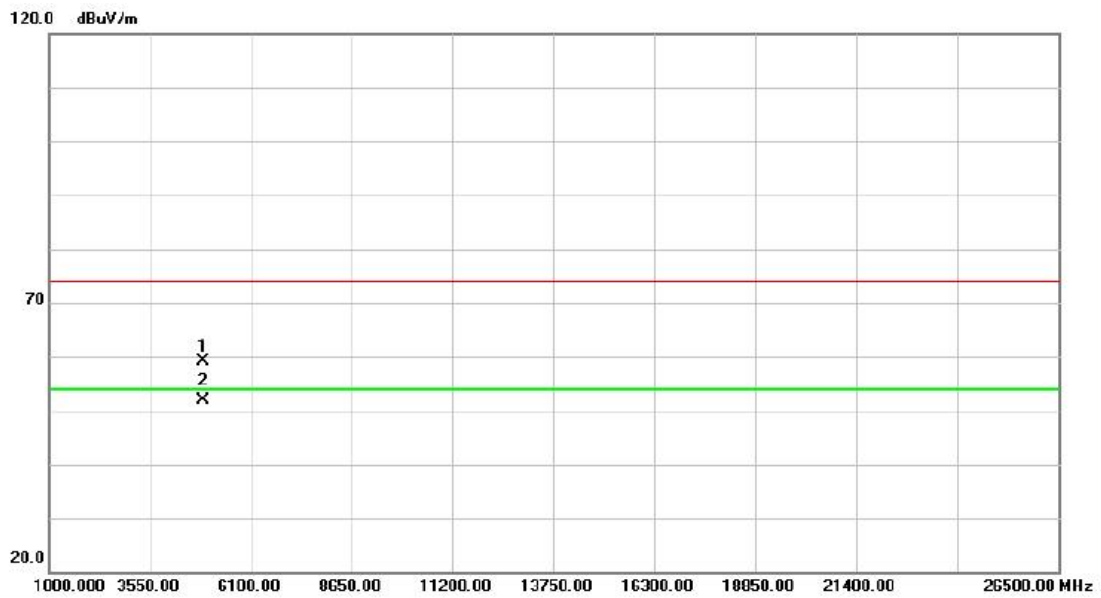

No. Mk.	Freq. MHz	Reading Level dBuV	Correct Factor dB	Measure- ment dBuV/m	Limit dBuV/m	Over dB	Detector	Comment
1	4882.000	52.30	6.77	59.07	74.00	-14.93	peak	
2 *	4882.000	45.21	6.77	51.98	54.00	-2.02	AVG	

Orthogonal Axis :	X
Test Mode :	TX 2480MHz _CH78_1Mbps

Vertical

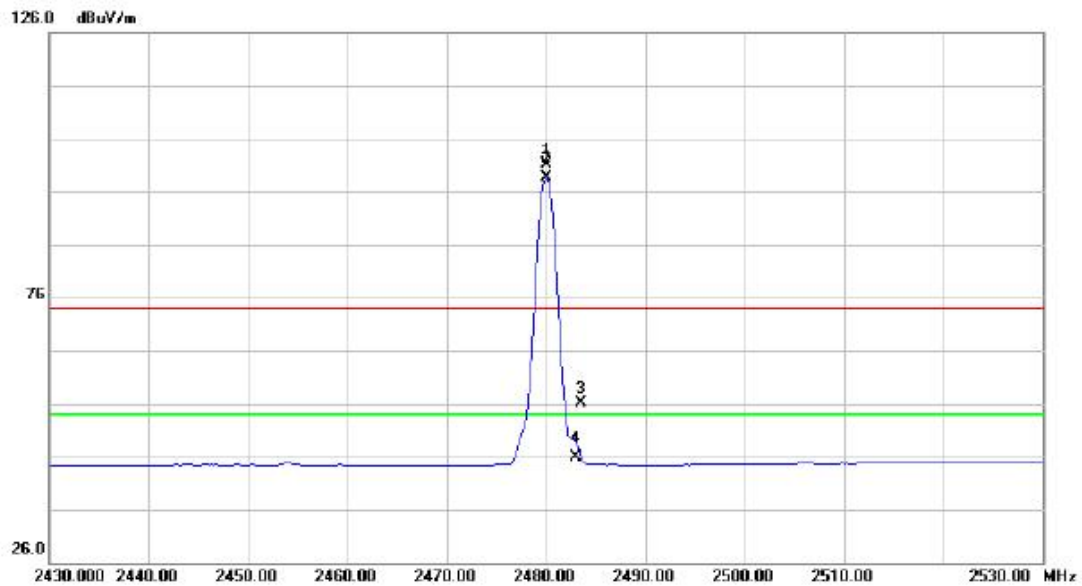

No.	Mk.	Freq.	Reading Level	Correct Factor	Measurement	Limit	Over	Detector	Comment
		MHz	dBuV	dB	dBuV/m	dBuV/m	dB		
1	X	2480.000	69.72	31.44	101.16	74.00	27.16	peak	NO LIMIT
2	*	2480.000	67.23	31.44	98.67	54.00	44.67	AVG	NO LIMIT
3		2483.500	24.60	31.46	56.06	74.00	-17.94	peak	
4		2483.500	14.46	31.46	45.92	54.00	-8.08	AVG	

Orthogonal Axis :	X
Test Mode :	TX 2480MHz _CH78_1Mbps

Vertical

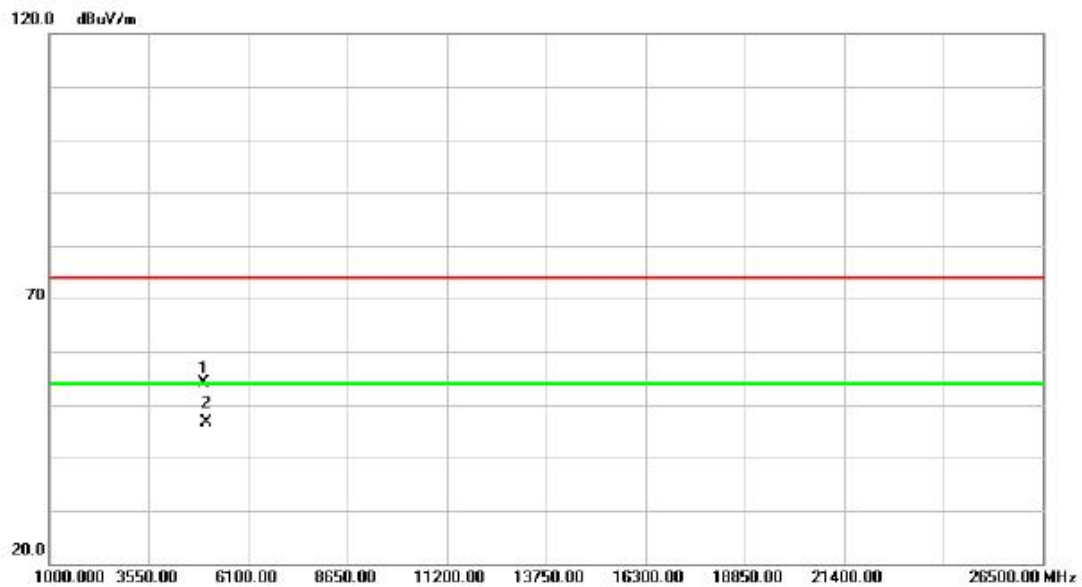

No. Mk.	Freq. MHz	Reading Level dBuV	Correct Factor dB	Measure- ment dBuV/m	Limit dBuV/m	Over dB	Detector	Comment
1	4960.000	47.27	6.76	54.03	74.00	-19.97	peak	
2 *	4960.000	39.79	6.76	46.55	54.00	-7.45	AVG	

Orthogonal Axis :	X
Test Mode :	TX 2480MHz _CH78_1Mbps

Horizontal

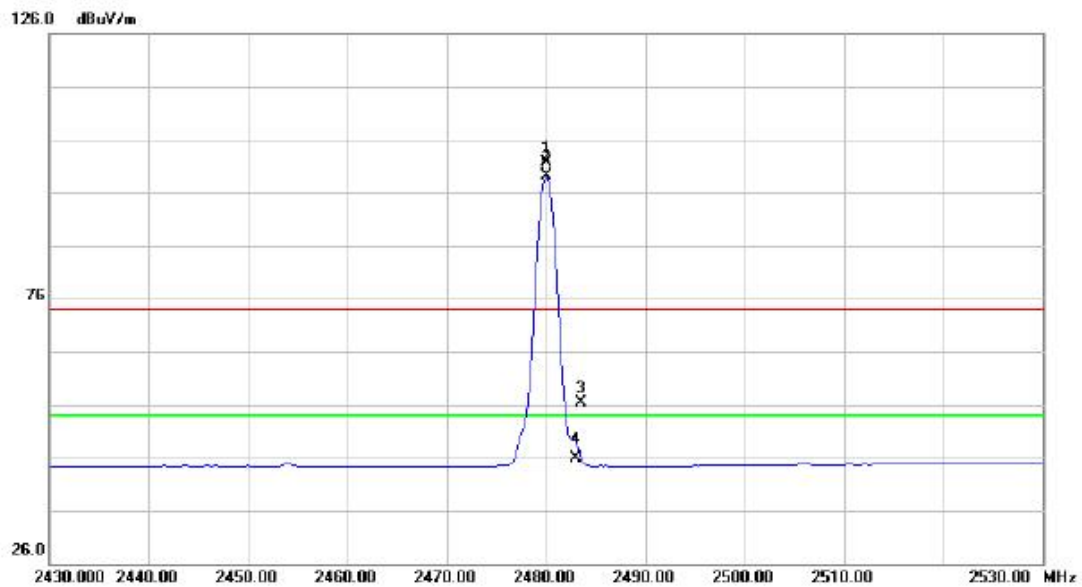

No.	Mk.	Freq.	Reading Level	Correct Factor	Measurement	Limit	Over	Detector	Comment
		MHz	dBuV	dB	dBuV/m	dBuV/m	dB		
1	X	2480.000	70.12	31.44	101.56	74.00	27.56	peak	NO LIMIT
2	*	2480.000	67.65	31.44	99.09	54.00	45.09	AVG	NO LIMIT
3		2483.500	24.85	31.46	56.31	74.00	-17.69	peak	
4		2483.500	14.52	31.46	45.98	54.00	-8.02	AVG	

Orthogonal Axis :	X
Test Mode :	TX 2480MHz _CH78_1Mbps

Horizontal

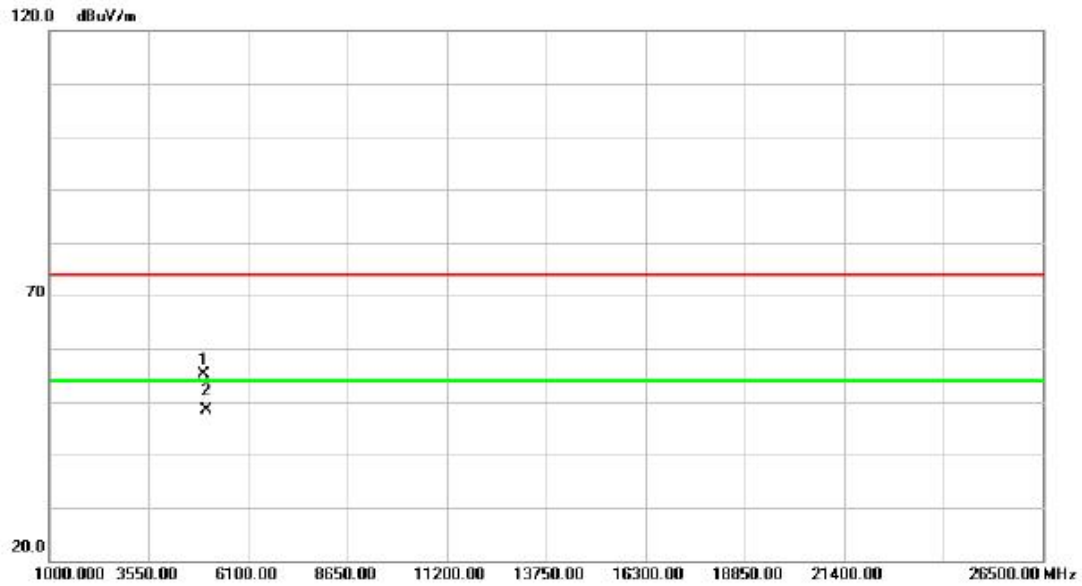

No. Mk.	Freq. MHz	Reading Level dBuV	Correct Factor dB	Measure- ment dBuV/m	Limit dBuV/m	Over dB	Detector	Comment
1	4960.000	48.25	6.76	55.01	74.00	-18.99	peak	
2 *	4960.000	41.65	6.76	48.41	54.00	-5.59	AVG	

Orthogonal Axis :	X
Test Mode :	TX 2402MHz _CH00_3Mbps

Vertical

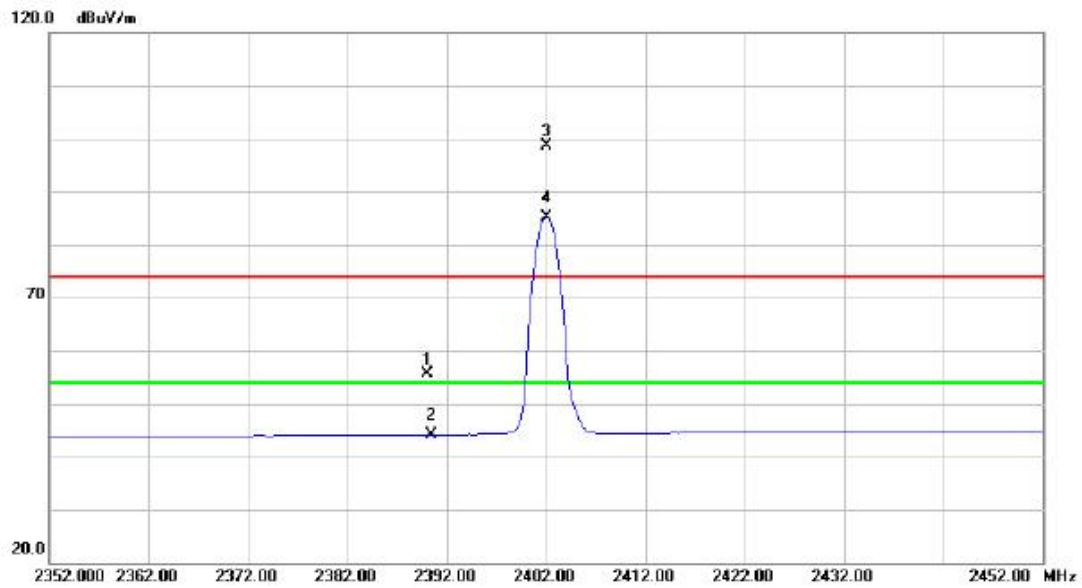

No.	Mk.	Freq. MHz	Reading Level dBuV	Correct Factor dB	Measure- ment dBuV/m	Limit dBuV/m	Over dB	Detector	Comment
1		2390.000	24.72	31.02	55.74	74.00	-18.26	peak	
2		2390.000	13.17	31.02	44.19	54.00	-9.81	AVG	
3	X	2402.000	67.60	31.08	98.68	74.00	24.68	peak	NO LIMIT
4	*	2402.000	54.17	31.08	85.25	54.00	31.25	AVG	NO LIMIT

Orthogonal Axis :	X
Test Mode :	TX 2402MHz _CH00_3Mbps

Vertical

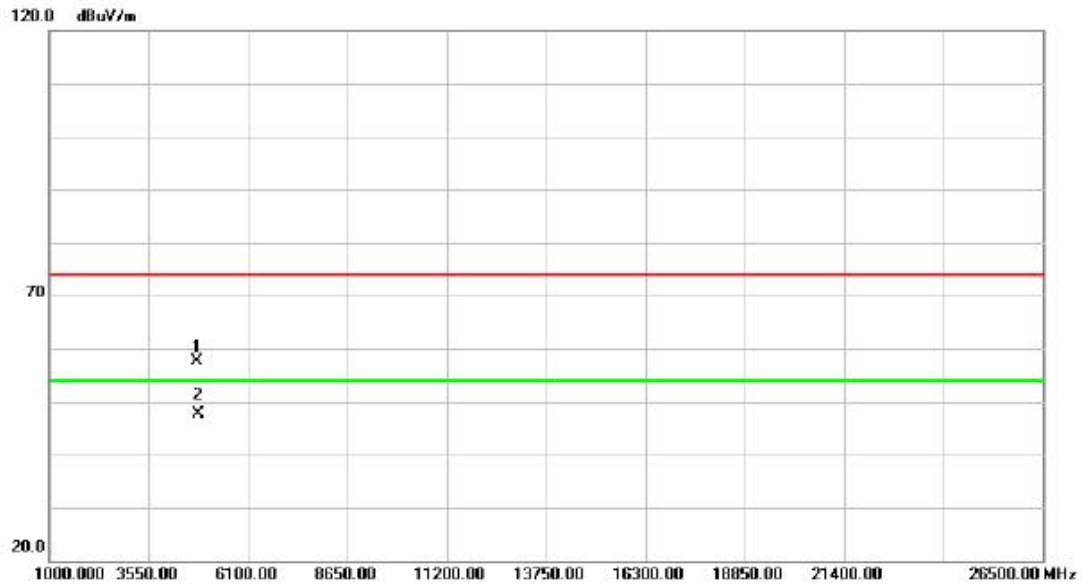

No.	Mk.	Freq. MHz	Reading Level dBuV	Correct Factor dB	Measure- ment dBuV/m	Limit dBuV/m	Over dB	Detector	Comment
1		4804.065	50.80	6.78	57.58	74.00	-16.42	peak	
2	*	4804.065	40.76	6.78	47.54	54.00	-6.46	AVG	

Orthogonal Axis :	X
Test Mode :	TX 2402MHz _CH00_3Mbps

Horizontal

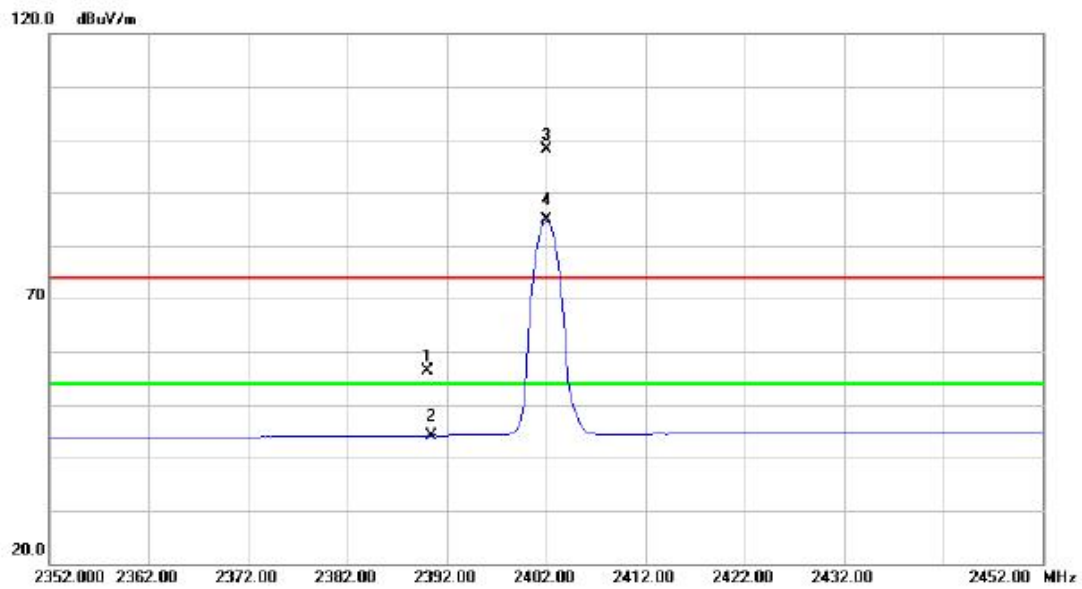

No.	Mk.	Freq. MHz	Reading Level dBuV	Correct Factor dB	Measure- ment dBuV/m	Limit dBuV/m	Over dB	Detector	Comment
1		2390.000	25.31	31.02	56.33	74.00	-17.67	peak	
2		2390.000	13.17	31.02	44.19	54.00	-9.81	AVG	
3	X	2402.000	67.06	31.08	98.14	74.00	24.14	peak	NO LIMIT
4	*	2402.000	53.69	31.08	84.77	54.00	30.77	AVG	NO LIMIT

Orthogonal Axis :	X
Test Mode :	TX 2402MHz _CH00_3Mbps

Horizontal

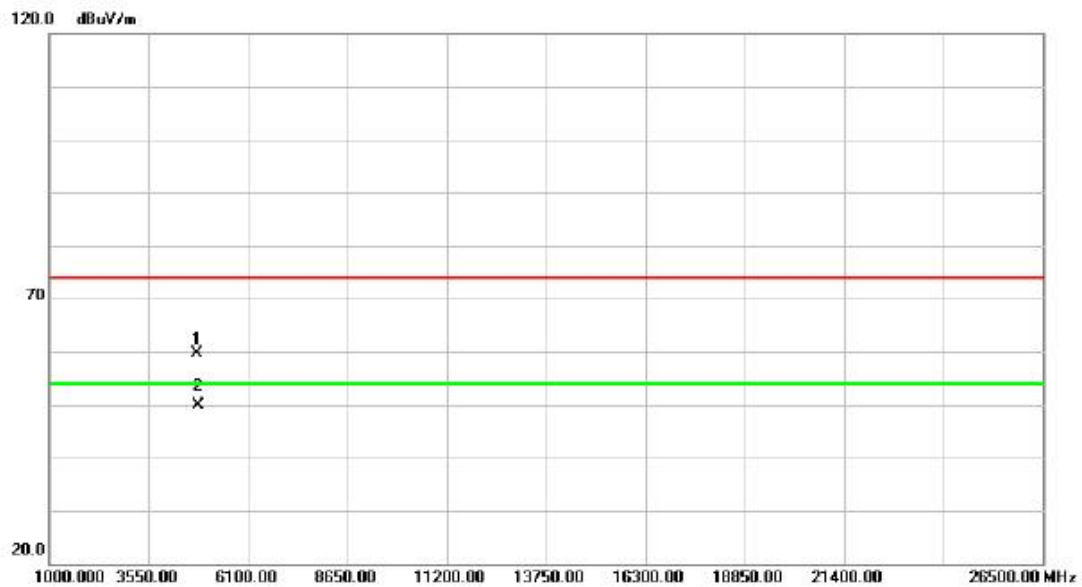

No.	Mk.	Freq.	Reading Level	Correct Factor	Measurement	Limit	Over	Detector	Comment
		MHz	dBuV	dB	dBuV/m	dBuV/m	dB		
1		4804.060	52.73	6.78	59.51	74.00	-14.49	peak	
2	*	4804.060	43.07	6.78	49.85	54.00	-4.15	AVG	

Orthogonal Axis :	X
Test Mode :	TX 2441MHz _CH39_3Mbps

Vertical

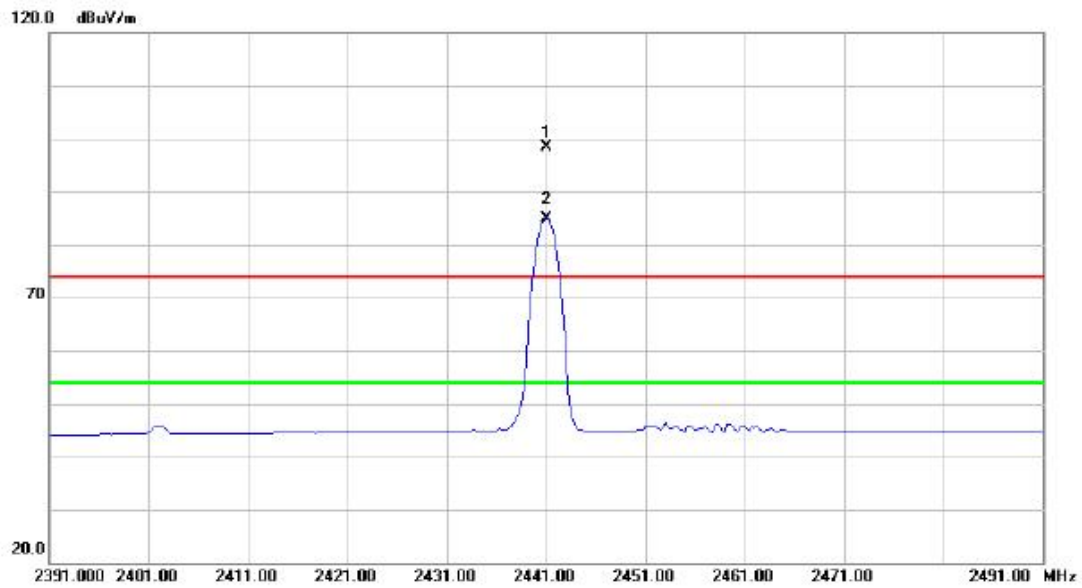

No.	Mk.	Freq.	Reading Level	Correct Factor	Measurement	Limit	Over	Detector	Comment
		MHz	dBuV	dB	dBuV/m	dBuV/m	dB		
1	X	2441.000	67.07	31.26	98.33	74.00	24.33	peak	NO LIMIT
2	*	2441.000	53.72	31.26	84.98	54.00	30.98	AVG	NO LIMIT

Orthogonal Axis :	X
Test Mode :	TX 2441MHz _CH39_3Mbps

Vertical

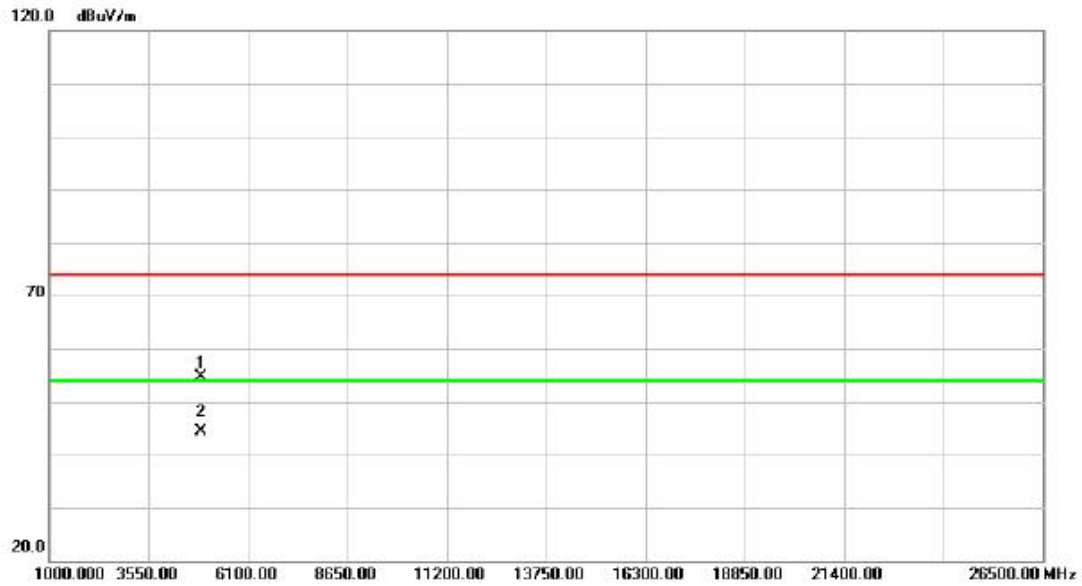

No.	Mk.	Freq. MHz	Reading Level dBuV	Correct Factor dB	Measure- ment dBuV/m	Limit dBuV/m	Over dB	Detector	Comment
1		4882.020	47.76	6.77	54.53	74.00	-19.47	peak	
2	*	4882.020	37.56	6.77	44.33	54.00	-9.67	AVG	

Orthogonal Axis :	X
Test Mode :	TX 2441MHz _CH39_3Mbps

Horizontal

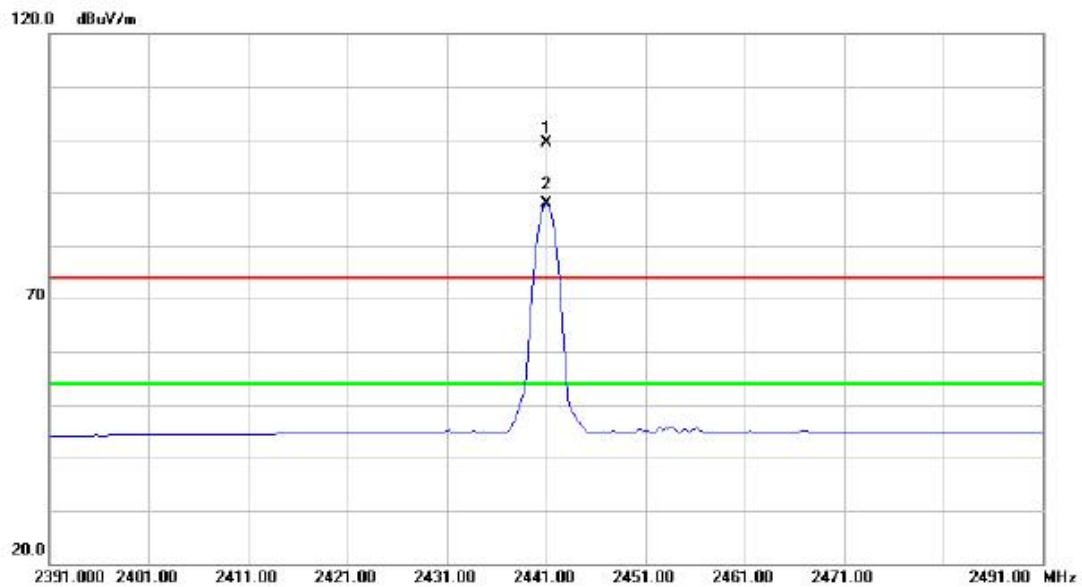

No.	Mk.	Freq.	Reading Level	Correct Factor	Measurement	Limit	Over	Detector	Comment
		MHz	dBuV	dB	dBuV/m	dBuV/m	dB		
1	X	2441.000	68.18	31.26	99.44	74.00	25.44	peak	NO LIMIT
2	*	2441.000	56.73	31.26	87.99	54.00	33.99	AVG	NO LIMIT

Orthogonal Axis :	X
Test Mode :	TX 2441MHz _CH39_3Mbps

Horizontal

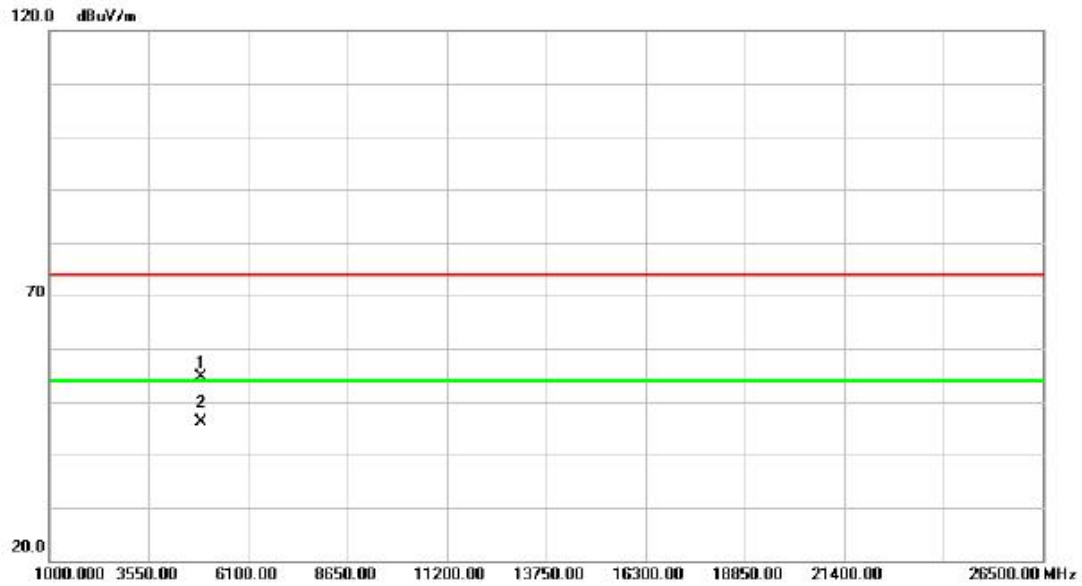

No. Mk.	Freq. MHz	Reading Level dBuV	Correct Factor dB	Measure- ment dBuV/m	Limit dBuV/m	Over dB	Detector	Comment
1	4882.020	47.92	6.77	54.69	74.00	-19.31	peak	
2 *	4882.020	39.32	6.77	46.09	54.00	-7.91	AVG	

Orthogonal Axis :	X
Test Mode :	TX 2480MHz _CH78_3Mbps

Vertical

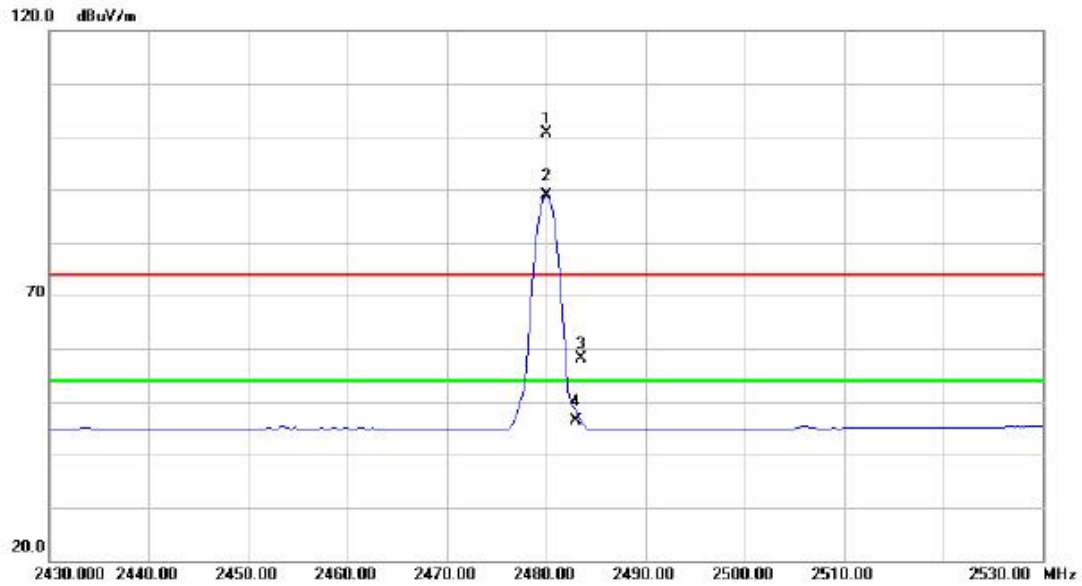

No.	Mk.	Freq.	Reading Level	Correct Factor	Measurement	Limit	Over	Detector	Comment
		MHz	dBuV	dB	dBuV/m	dBuV/m	dB		
1	X	2480.000	69.14	31.44	100.58	74.00	26.58	peak	NO LIMIT
2	*	2480.000	57.49	31.44	88.93	54.00	34.93	AVG	NO LIMIT
3		2483.500	26.69	31.46	58.15	74.00	-15.85	peak	
4		2483.500	15.00	31.46	46.46	54.00	-7.54	AVG	

Orthogonal Axis :	X
Test Mode :	TX 2480MHz _CH78_3Mbps

Vertical

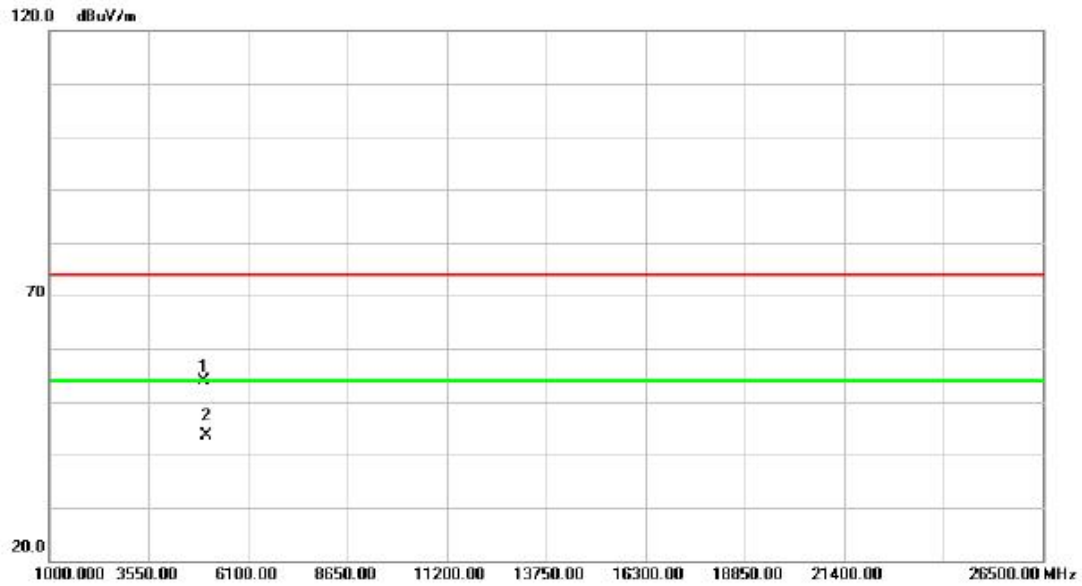

No. Mk.	Freq. MHz	Reading Level dBuV	Correct Factor dB	Measure- ment dBuV/m	Limit dBuV/m	Over dB	Detector	Comment
1	4960.020	47.03	6.76	53.79	74.00	-20.21	peak	
2 *	4960.020	36.93	6.76	43.69	54.00	-10.31	AVG	

Orthogonal Axis :	X
Test Mode :	TX 2480MHz _CH78_3Mbps

Horizontal

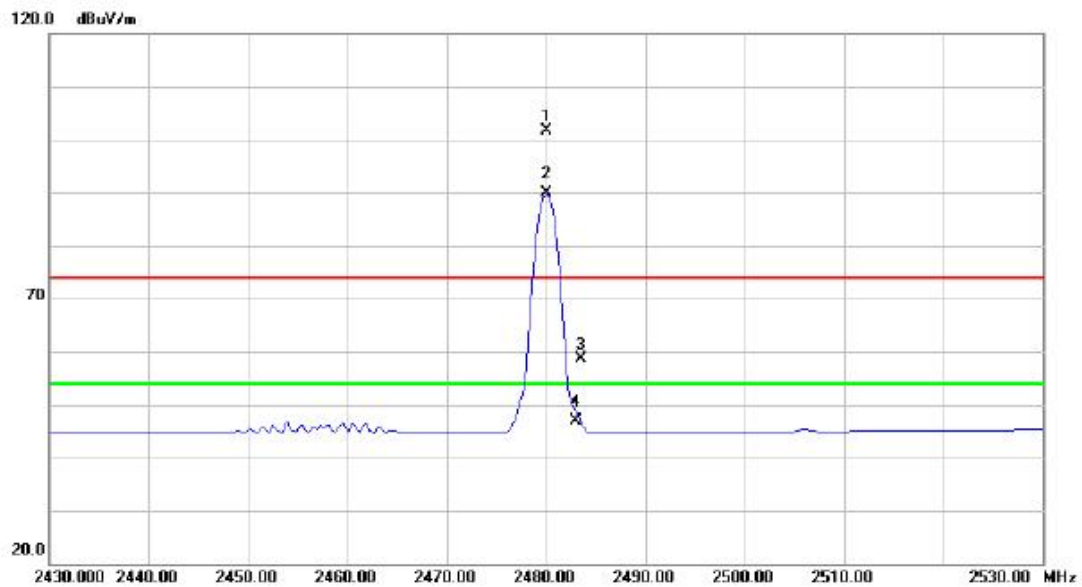

No.	Mk.	Freq. MHz	Reading Level dBuV	Correct Factor dB	Measure- ment dBuV/m	Limit dBuV/m	Over dB	Detector	Comment
1	X	2480.000	70.30	31.44	101.74	74.00	27.74	peak	NO LIMIT
2	*	2480.000	58.36	31.44	89.80	54.00	35.80	AVG	NO LIMIT
3		2483.500	27.15	31.46	58.61	74.00	-15.39	peak	
4		2483.500	15.36	31.46	46.82	54.00	-7.18	AVG	

Orthogonal Axis :	X
Test Mode :	TX 2480MHz _CH78_3Mbps

Horizontal

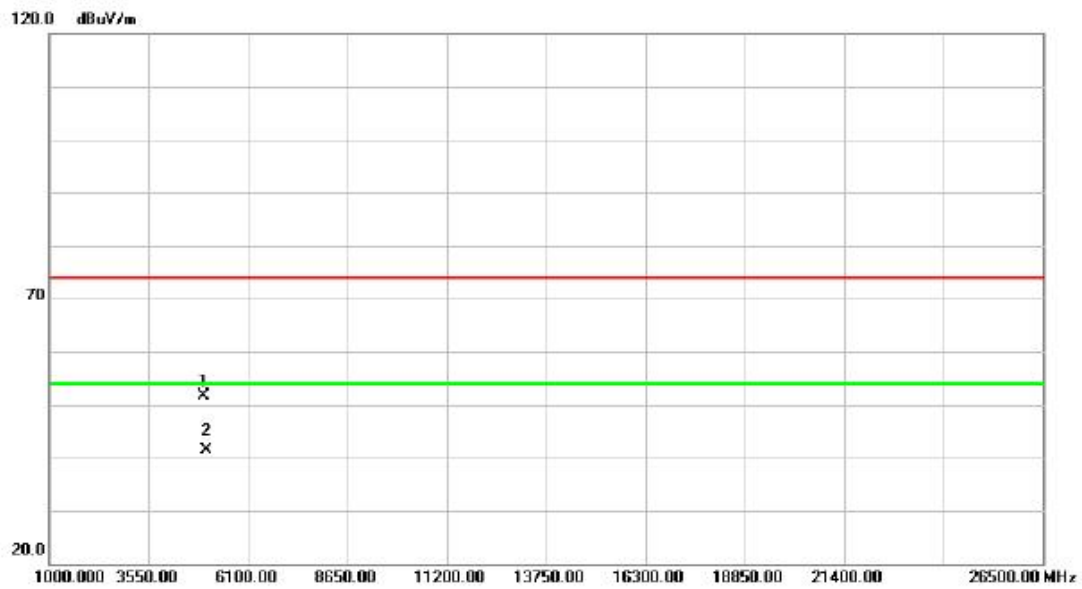

No.	Mk.	Freq.	Reading Level	Correct Factor	Measurement	Limit	Over	Detector	Comment
		MHz	dBuV	dB	dBuV/m	dBuV/m	dB		
1		4960.020	44.93	6.76	51.69	74.00	-22.31	peak	
2	*	4960.020	34.53	6.76	41.29	54.00	-12.71	AVG	

ATTACHMENT E - NUMBER OF HOPPING CHANNEL

Test Mode **Hopping Mode_1Mbps**
 Number of Hopping Channel 79

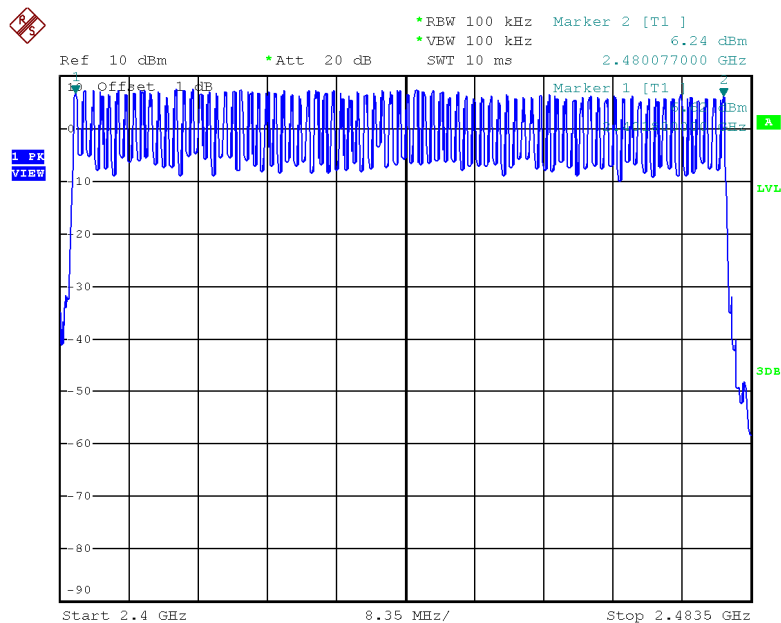

Date: 21.NOV.2014 14:05:08

Test Mode **Hopping Mode_3Mbps**
 Number of Hopping Channel 79

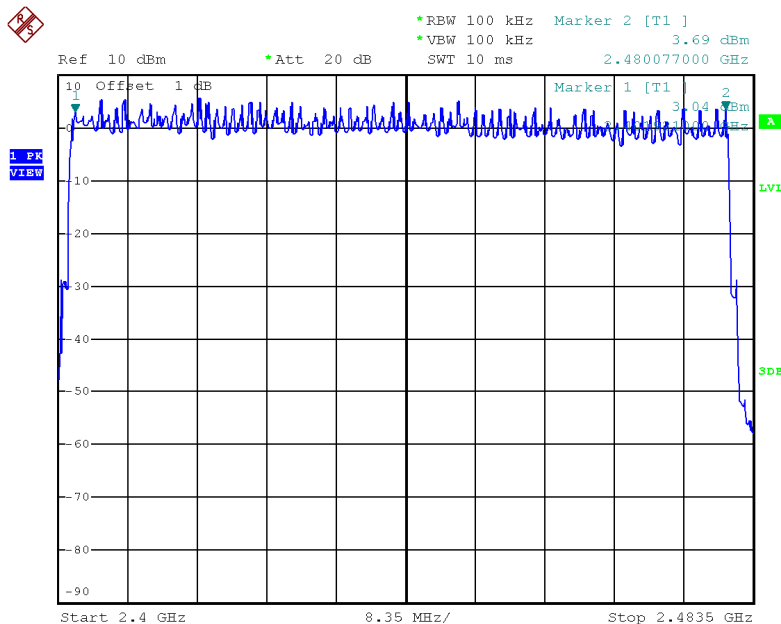

Date: 21.NOV.2014 14:23:50

ATTACHMENT F - AVERAGE TIME OF OCCUPANCY

Test Mode :	TX Mode_1Mbps
-------------	---------------

Data Packet	Frequency (MHz)	Pulse Duration (ms)	Dwell Time (s)	Limits (s)	Test Result
DH5	2402	2.9700	0.3168	0.4000	Complies
DH3	2402	1.7200	0.2752	0.4000	Complies
DH1	2402	0.4600	0.1472	0.4000	Complies
DH5	2441	2.9700	0.3168	0.4000	Complies
DH3	2441	1.7200	0.2752	0.4000	Complies
DH1	2441	0.4600	0.1472	0.4000	Complies
DH5	2480	2.9700	0.3168	0.4000	Complies
DH3	2480	1.7400	0.2784	0.4000	Complies
DH1	2480	0.4600	0.1472	0.4000	Complies

CH00-DH1

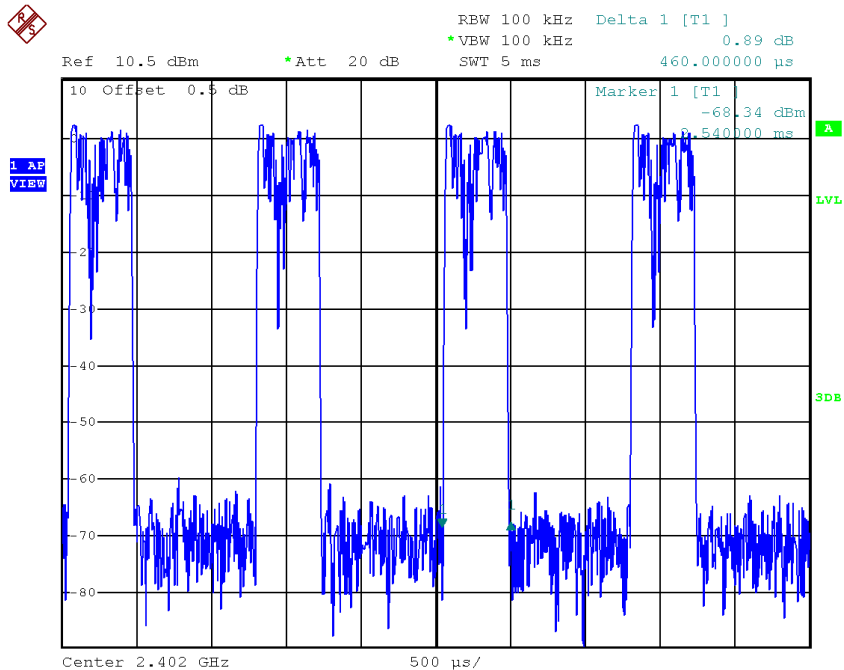

Date: 19.NOV.2014 15:13:50

CH00-DH3

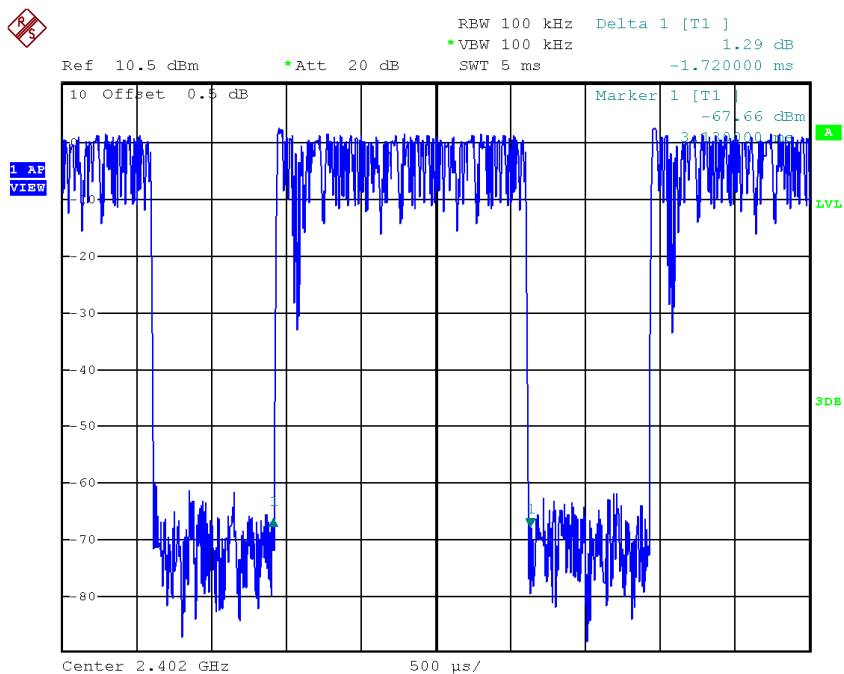

Date: 19.NOV.2014 15:22:12

CH00-DH5

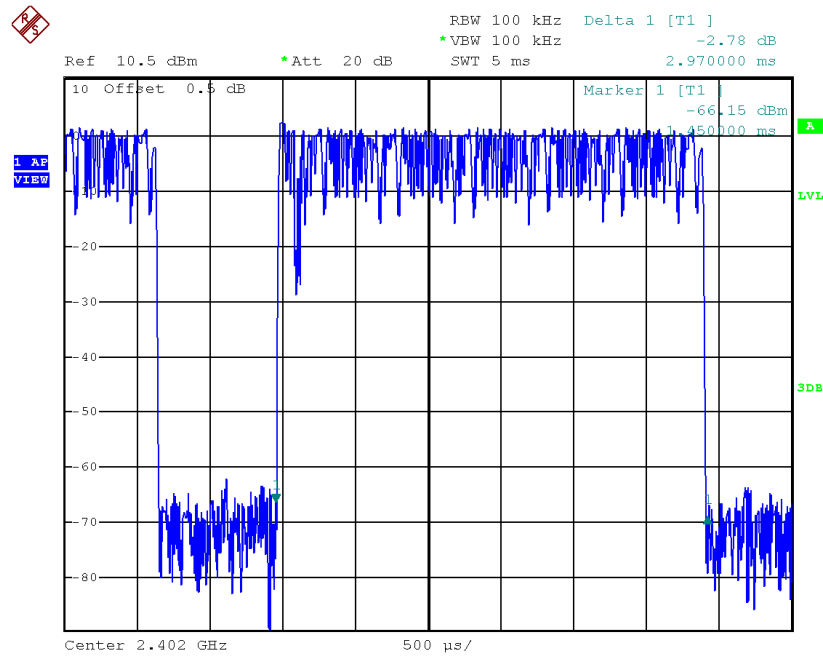

Date: 19.NOV.2014 15:28:34

CH39-DH1

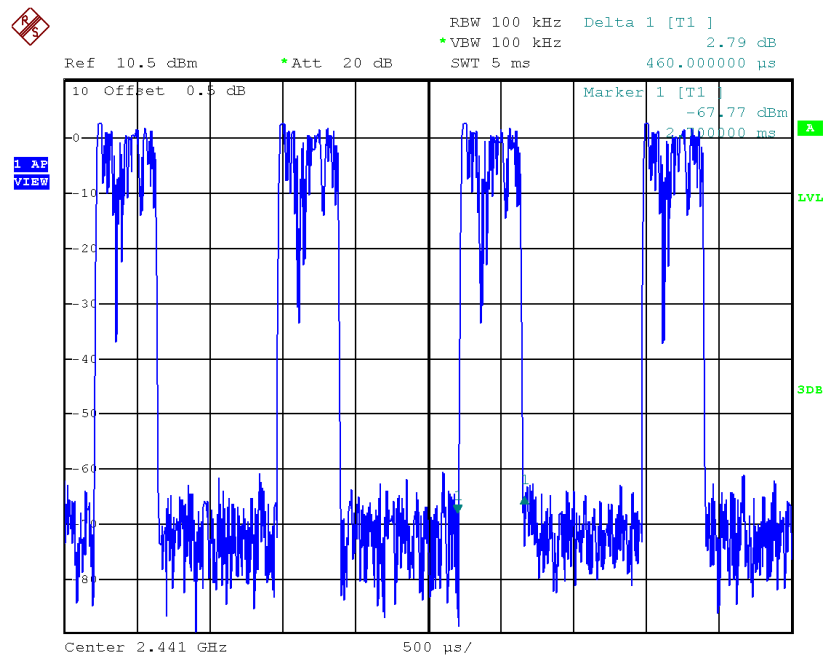

Date: 19.NOV.2014 15:32:01

CH39-DH3

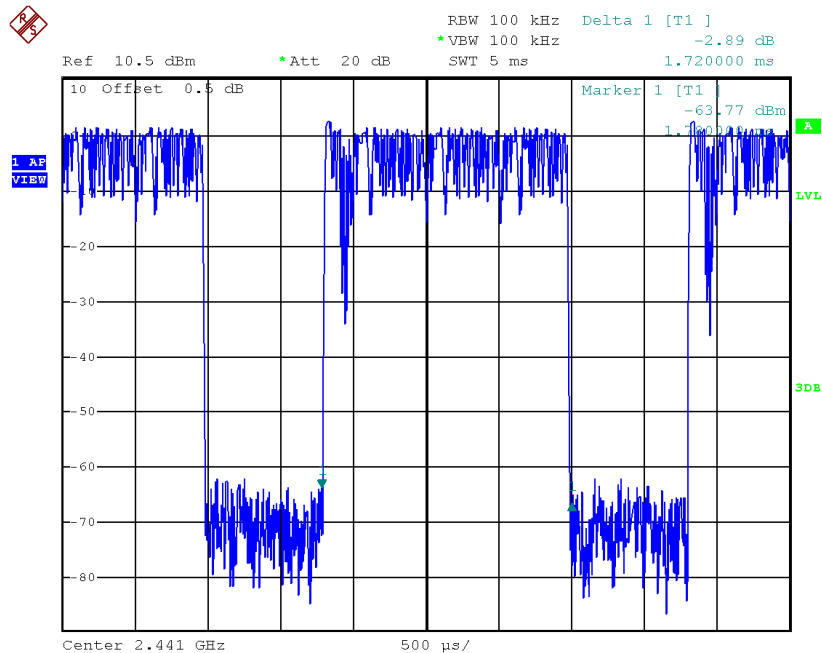

Date: 19.NOV.2014 15:34:47

CH39-DH5

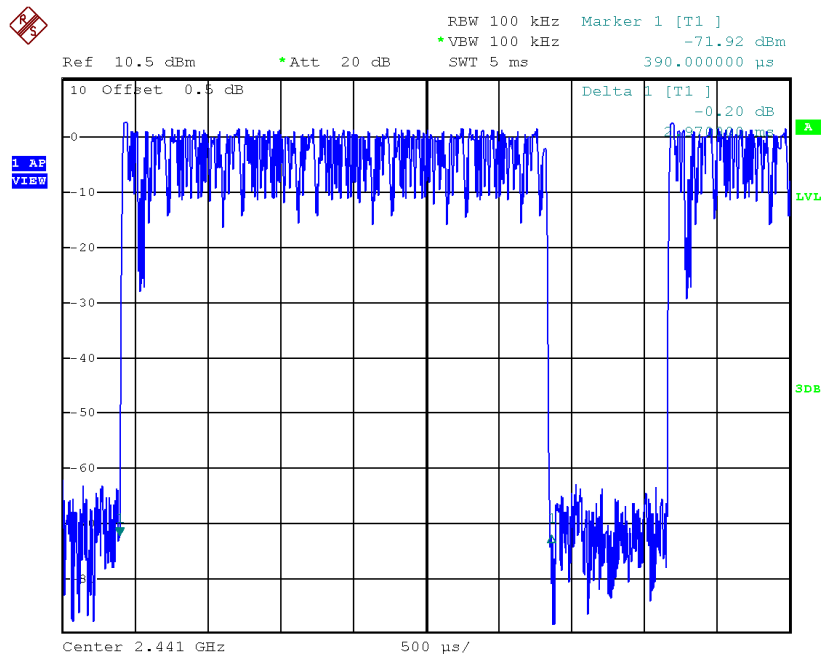

Date: 19.NOV.2014 15:38:24

CH78-DH1

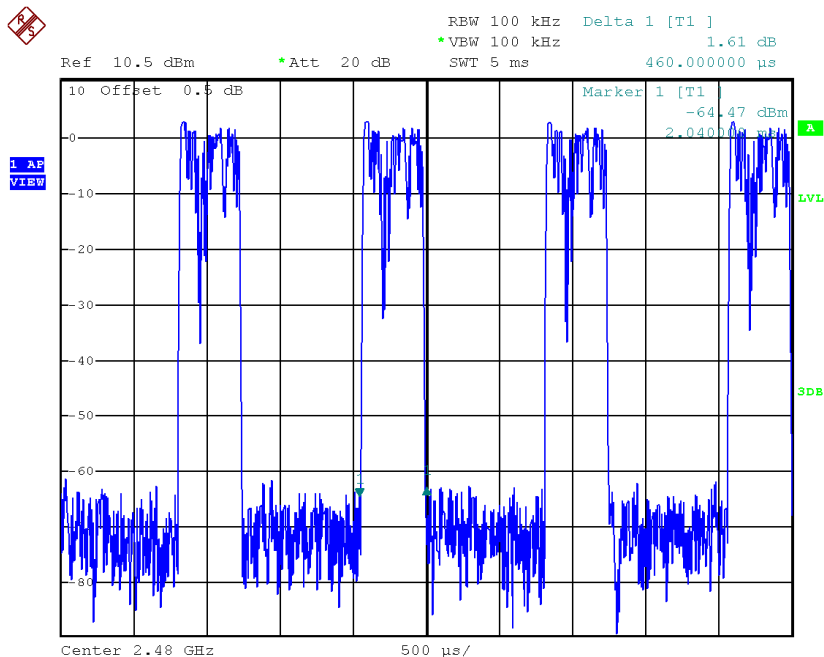

Date: 19.NOV.2014 15:49:15

CH78-DH3

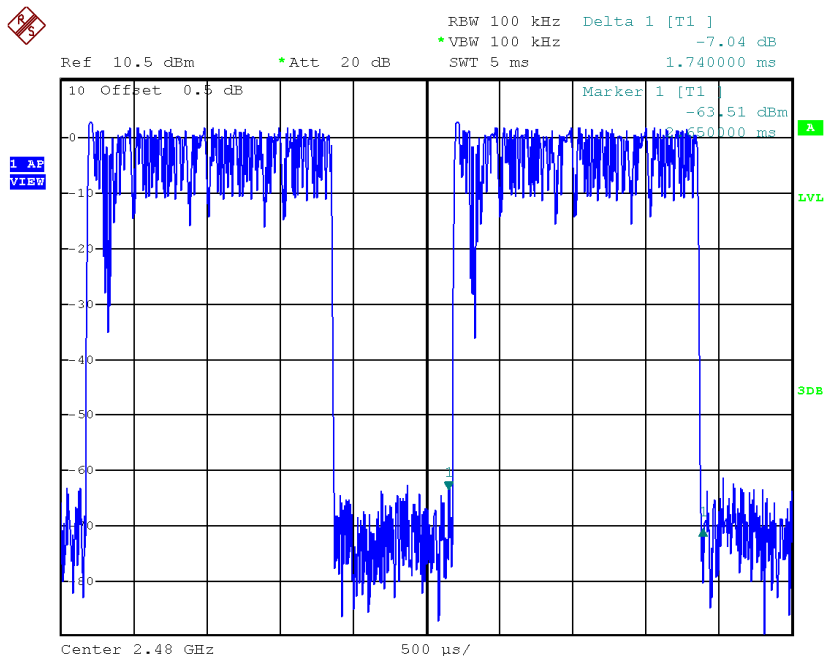

Date: 19.NOV.2014 15:45:04

CH78-DH5

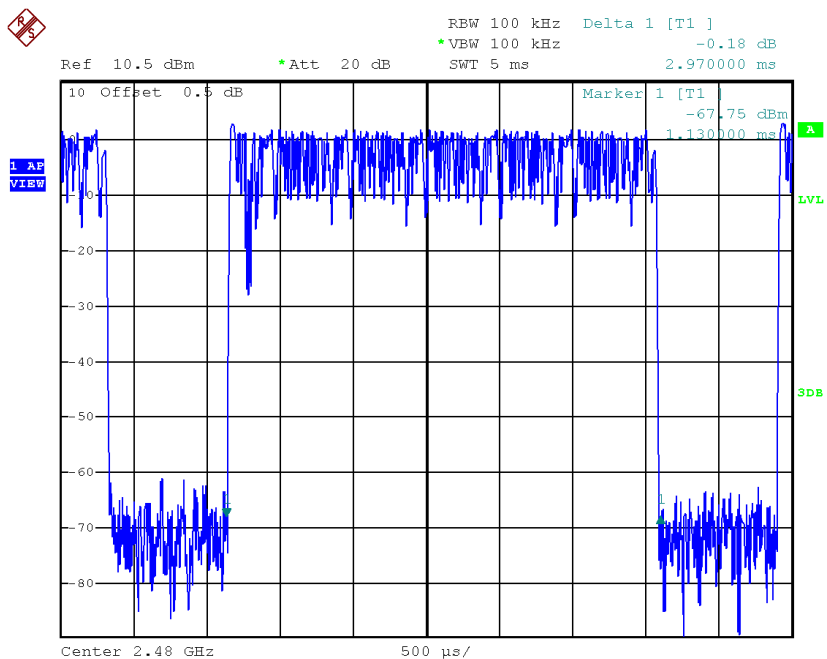

Date: 19.NOV.2014 15:41:24

Test Mode :	TX Mode_3Mbps
-------------	---------------

Data Packet	Frequency (MHz)	Pulse Duration (ms)	Dwell Time (s)	Limits (s)	Test Result
DH5	2402	2.9800	0.3179	0.4000	Complies
DH3	2402	1.7200	0.2752	0.4000	Complies
DH1	2402	0.4700	0.1504	0.4000	Complies
DH5	2441	2.9800	0.3179	0.4000	Complies
DH3	2441	1.7300	0.2768	0.4000	Complies
DH1	2441	0.4700	0.1504	0.4000	Complies
DH5	2480	2.9900	0.3189	0.4000	Complies
DH3	2480	1.7300	0.2768	0.4000	Complies
DH1	2480	0.4800	0.1536	0.4000	Complies

CH00-DH1

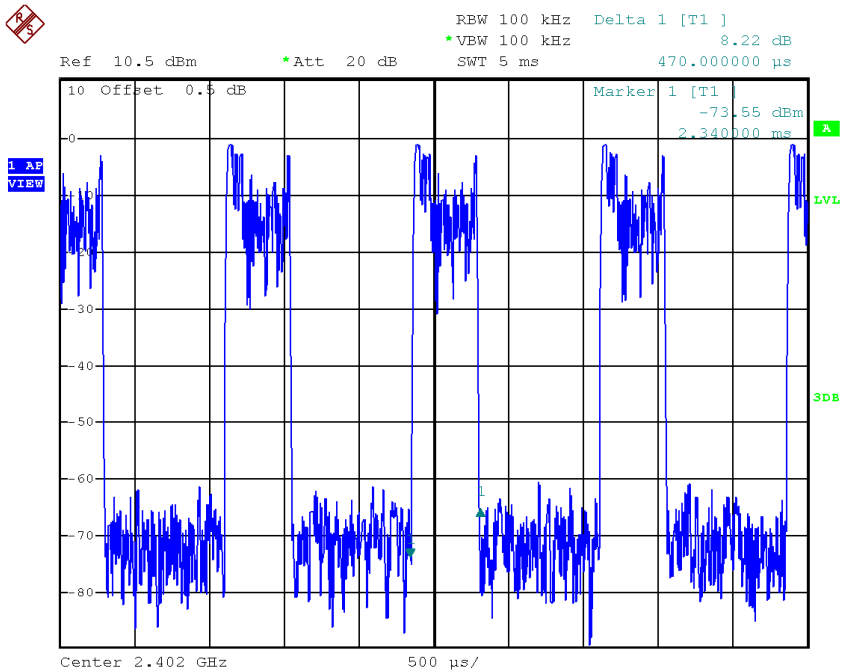

Date: 19.NOV.2014 15:47:38

CH00-DH3

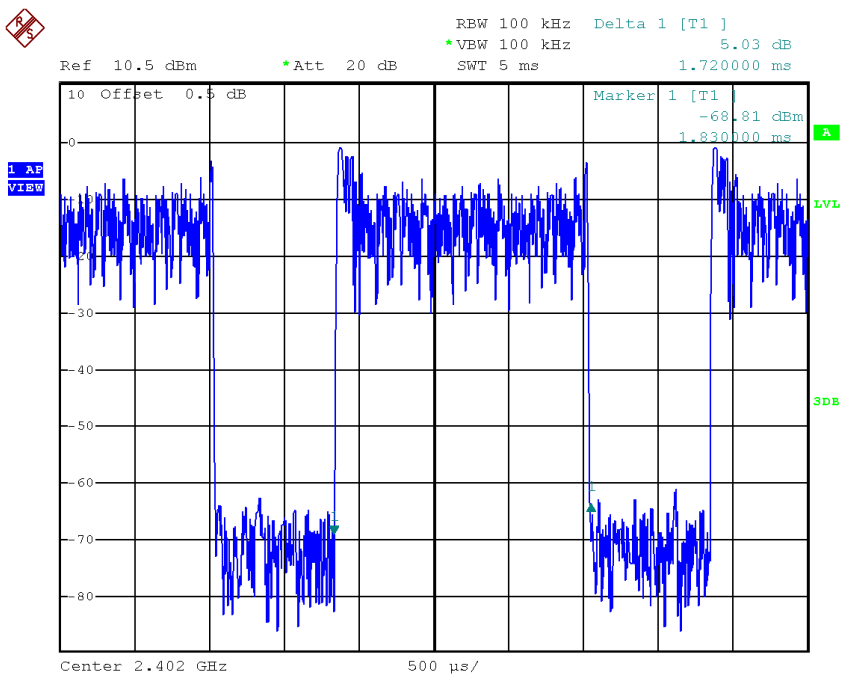

Date: 19.NOV.2014 15:43:06

CH00-DH5

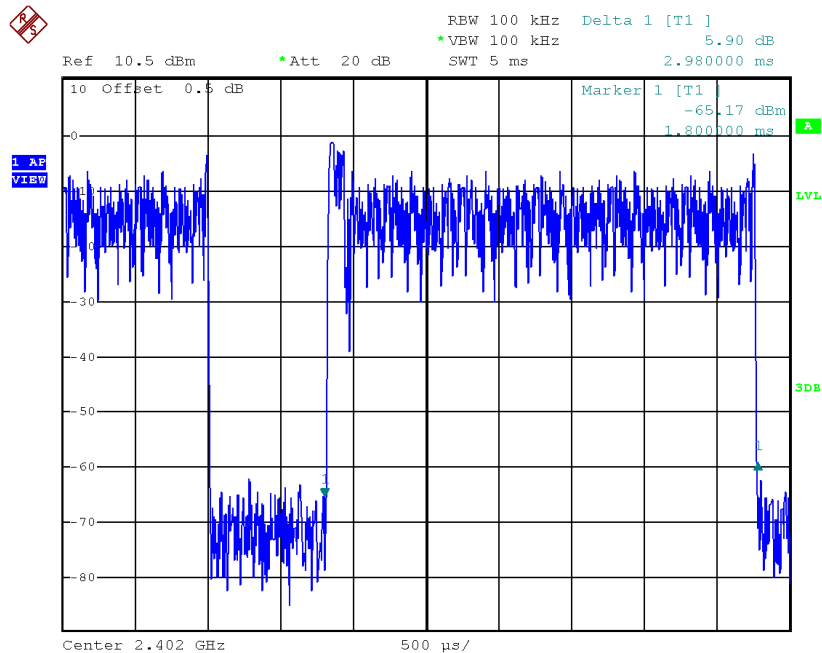

Date: 19.NOV.2014 15:39:54

CH39-DH1

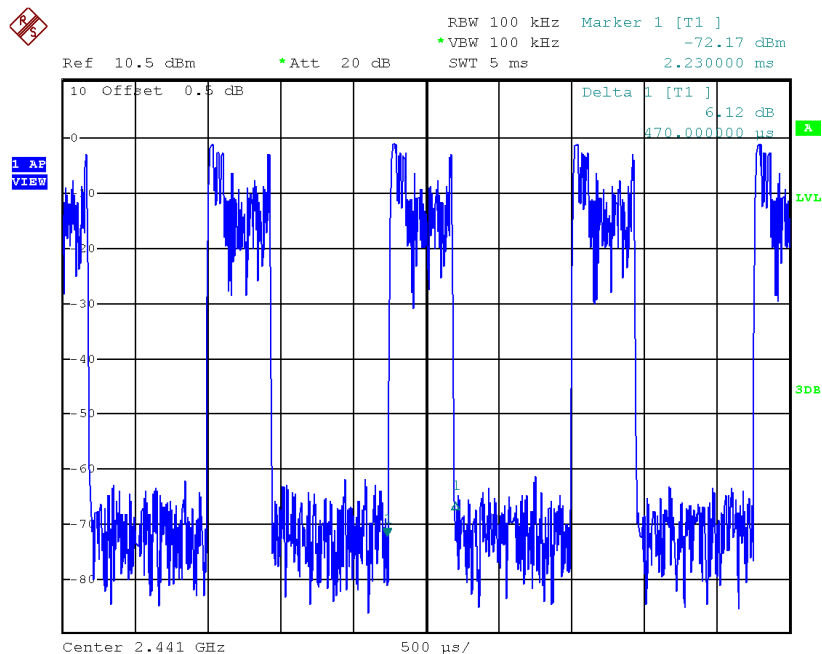

Date: 19.NOV.2014 15:36:17

CH39-DH3

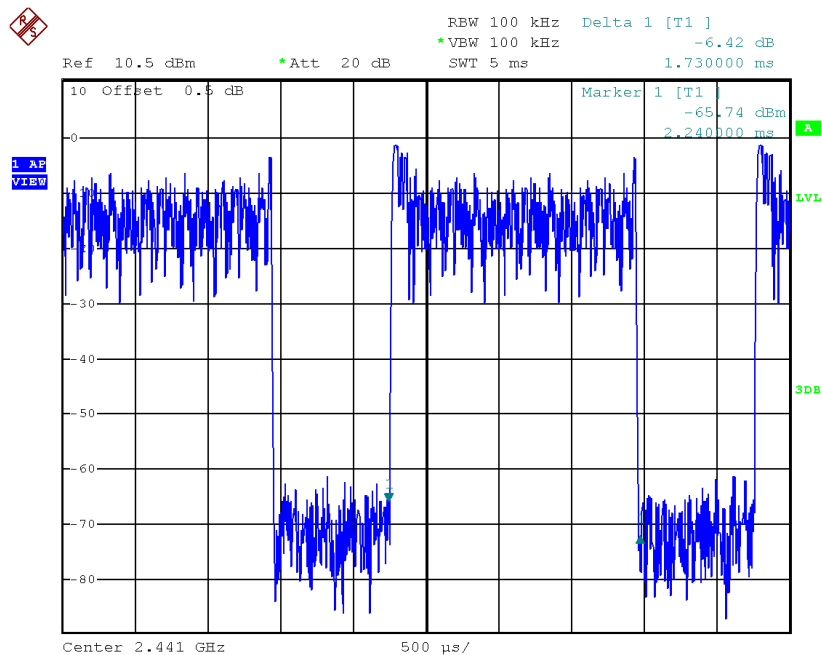

Date: 19.NOV.2014 15:33:28

CH39-DH5

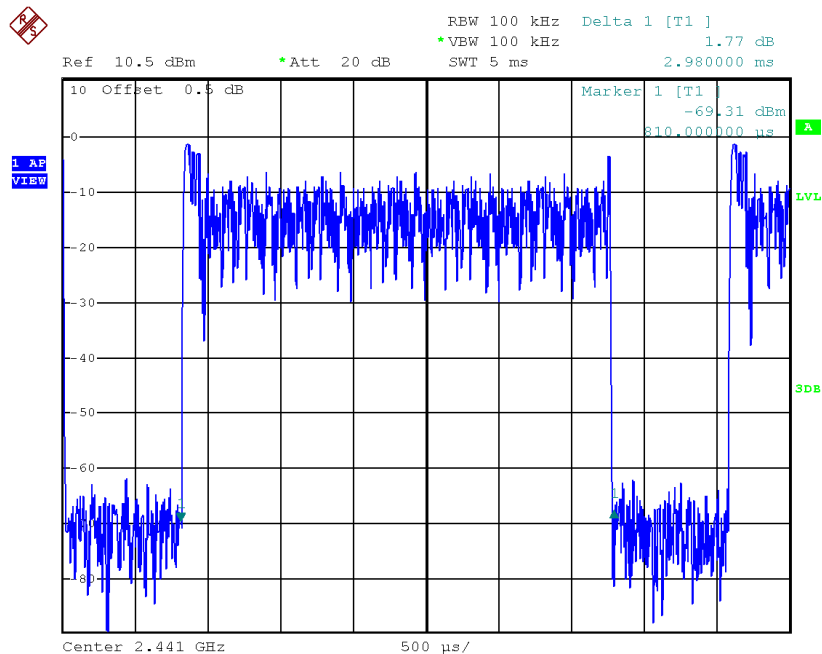

Date: 19.NOV.2014 15:30:16

CH78-DH1

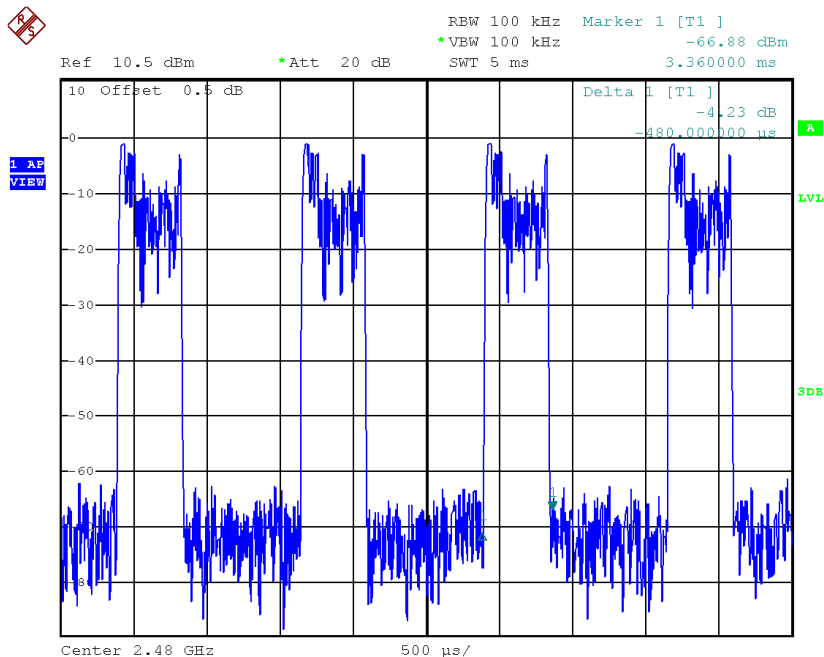

Date: 19.NOV.2014 15:24:08

CH78-DH3

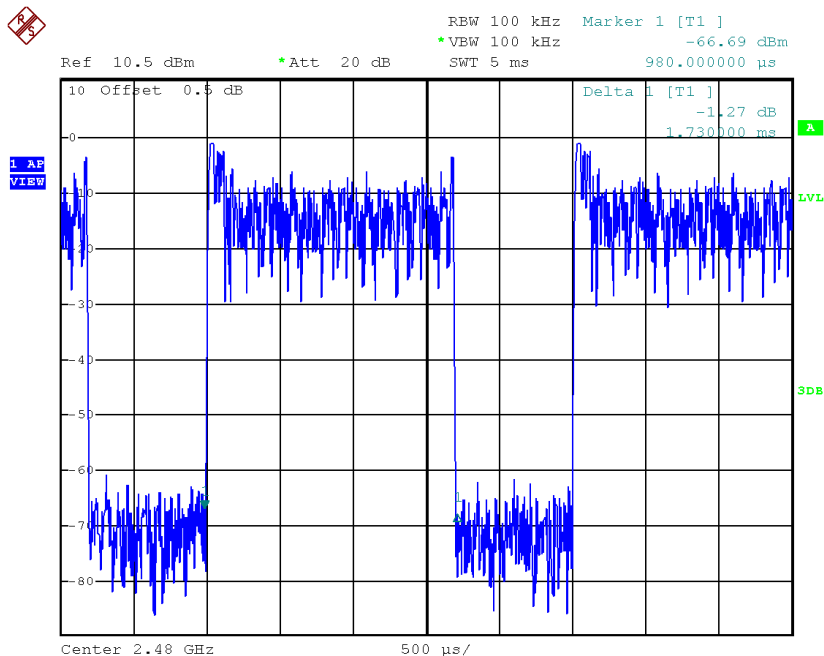

Date: 19.NOV.2014 15:18:07

CH78-DH5

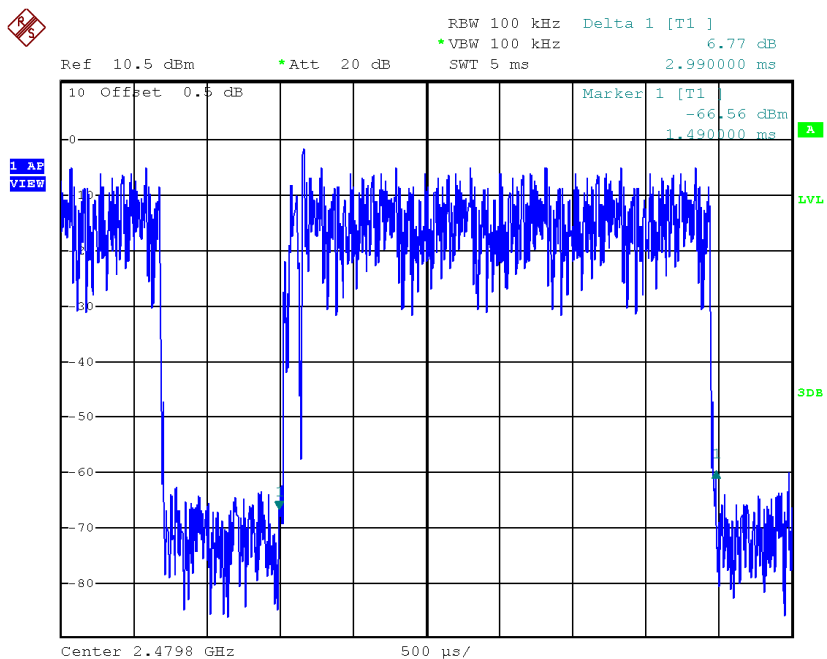

Date: 19.NOV.2014 15:08:58

ATTACHMENT G - HOPPING CHANNEL SEPARATION MEASUREMENT

Test Mode : Hopping on _1Mbps

Frequency (MHz)	Channel Separation (MHz)	2/3 of 20dB Bandwidth (MHz)	Test Result
2402	1.007	0.637	Complies
2441	1.002	0.633	Complies
2480	1.175	0.640	Complies

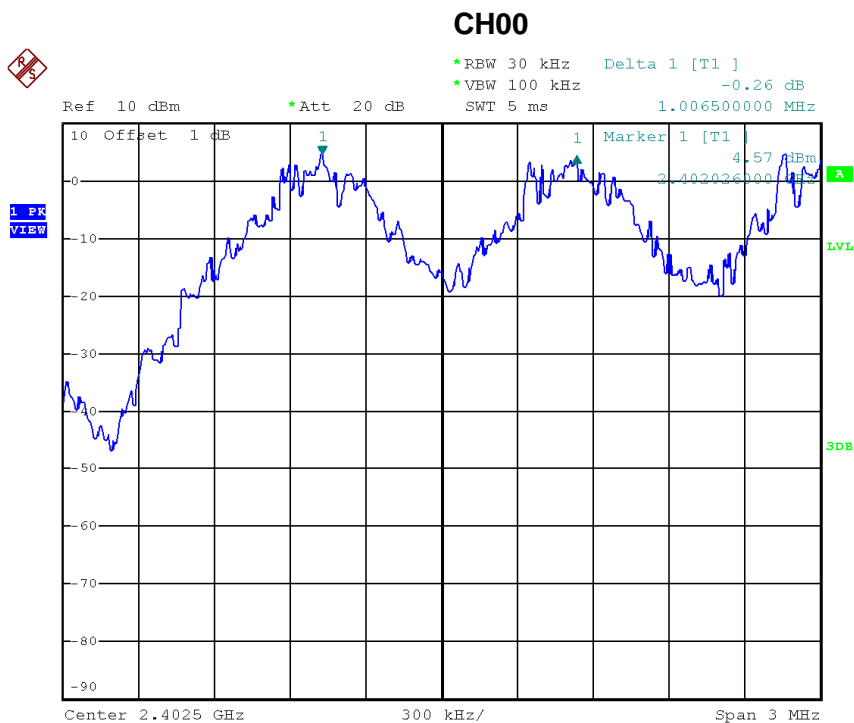

Date: 21.NOV.2014 13:58:12

CH39

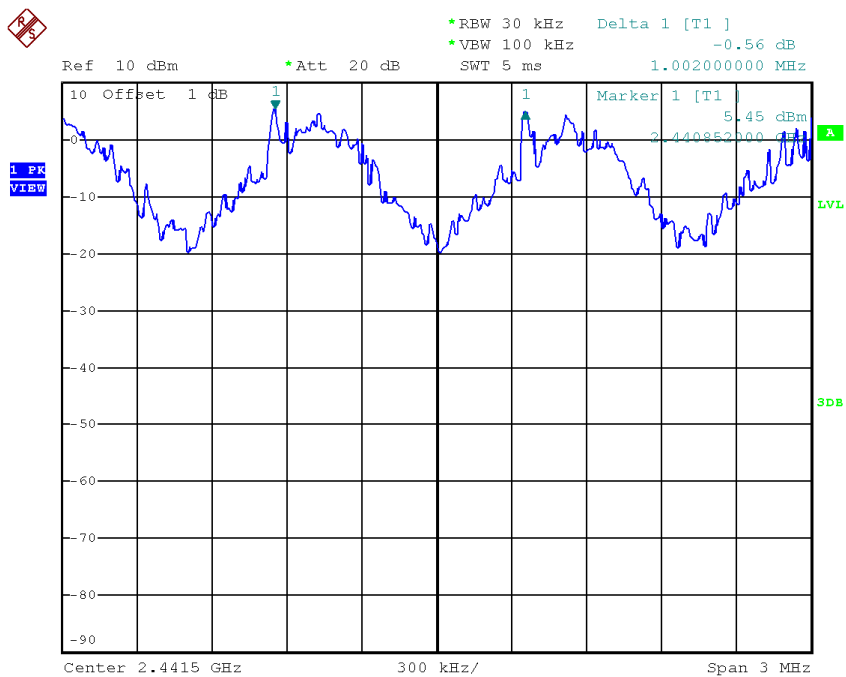

Date: 21.NOV.2014 13:59:17

CH78

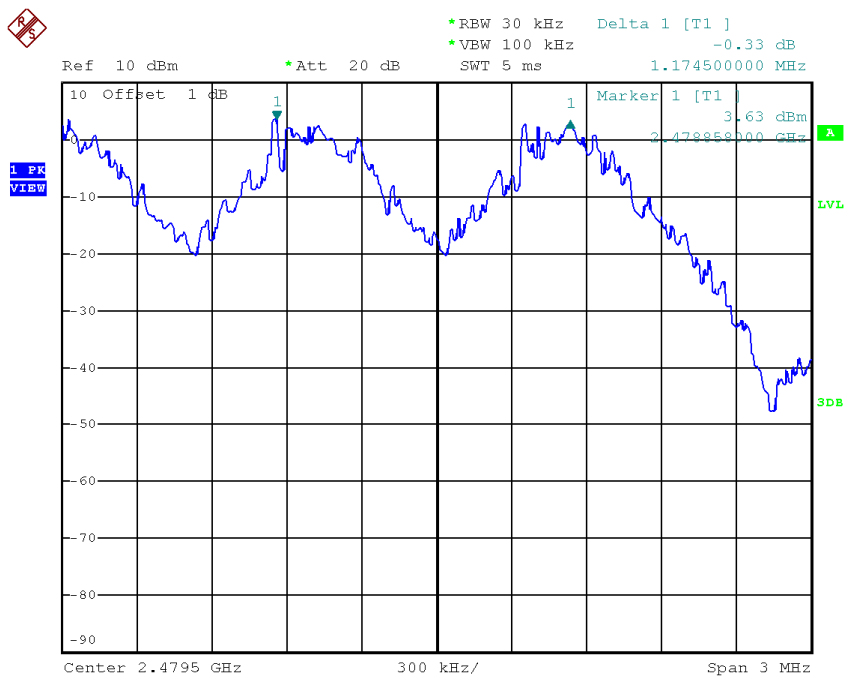

Date: 21.NOV.2014 14:01:05

Test Mode : Hopping on _3Mbps

Frequency (MHz)	Channel Separation (MHz)	2/3 of 20dB Bandwidth (MHz)	Test Result
2402	1.008	0.855	Complies
2441	1.020	0.843	Complies
2480	1.008	0.856	Complies

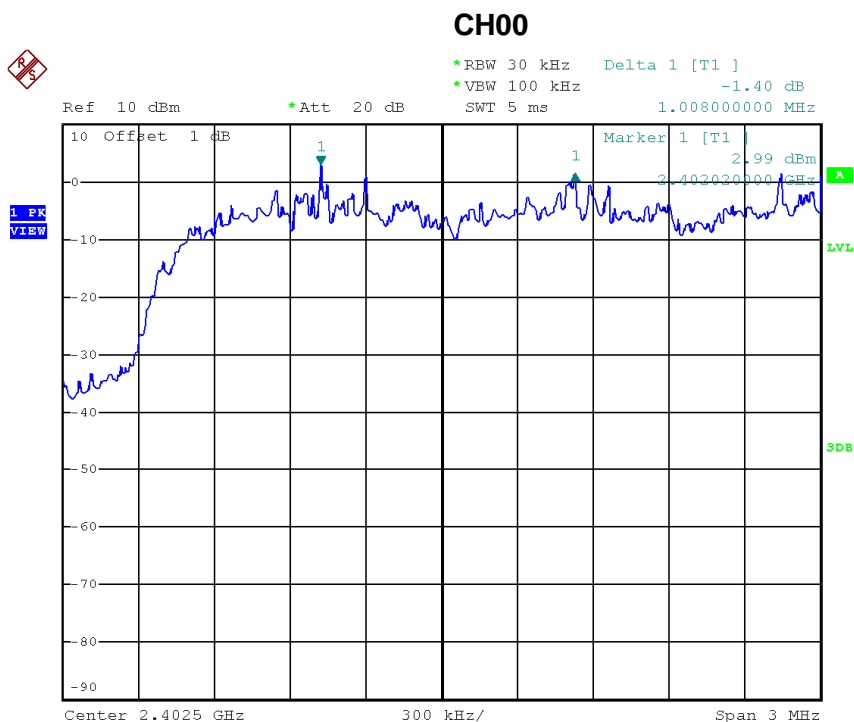

Date: 21.NOV.2014 14:17:38

CH39

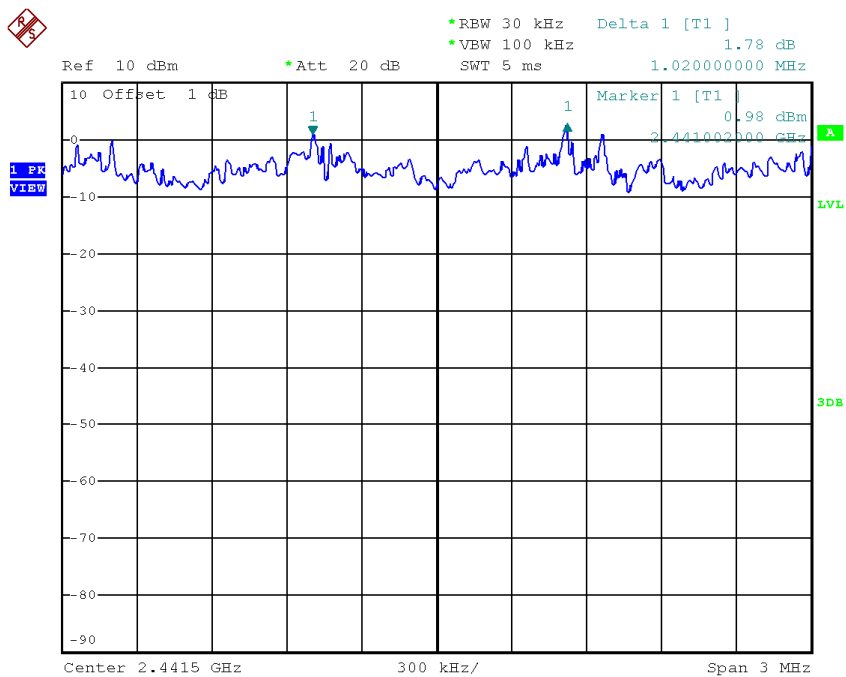

Date: 21.NOV.2014 14:18:43

CH78

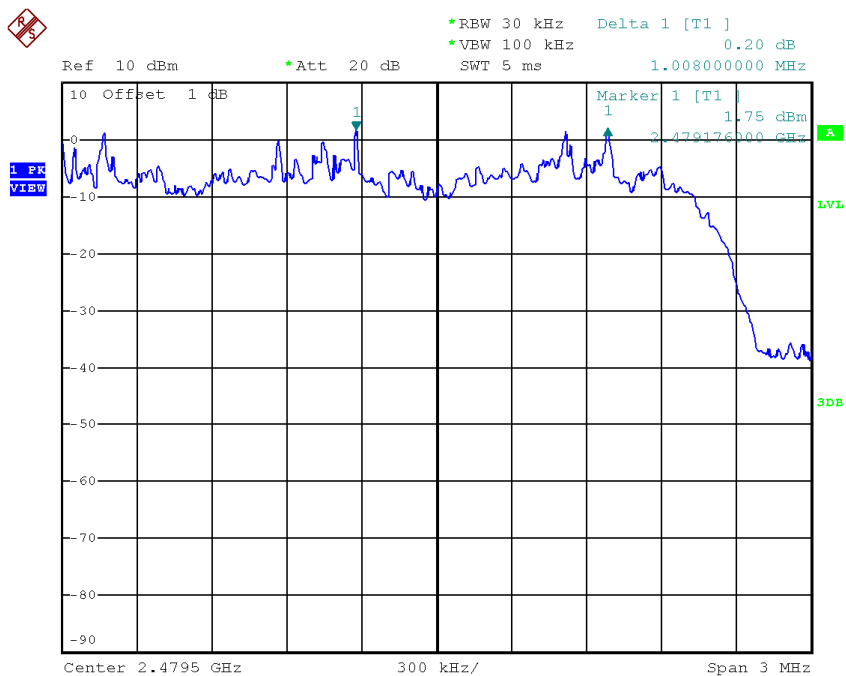

Date: 21.NOV.2014 14:19:48

ATTACHMENT H - BANDWIDTH

Test Mode : TX Mode _1Mbps

Frequency (MHz)	20dB Bandwidth (MHz)	99% Occupied BW (MHz)	Test Result
2402	0.956	0.955	Complies
2441	0.950	0.868	Complies
2480	0.960	0.960	Complies

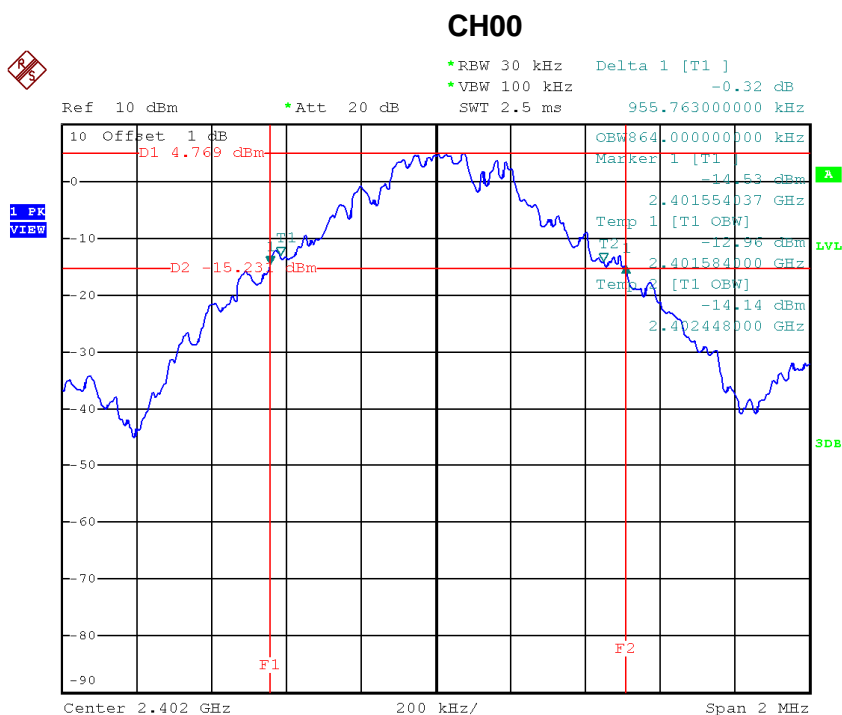

Date: 21.NOV.2014 12:09:03

CH39

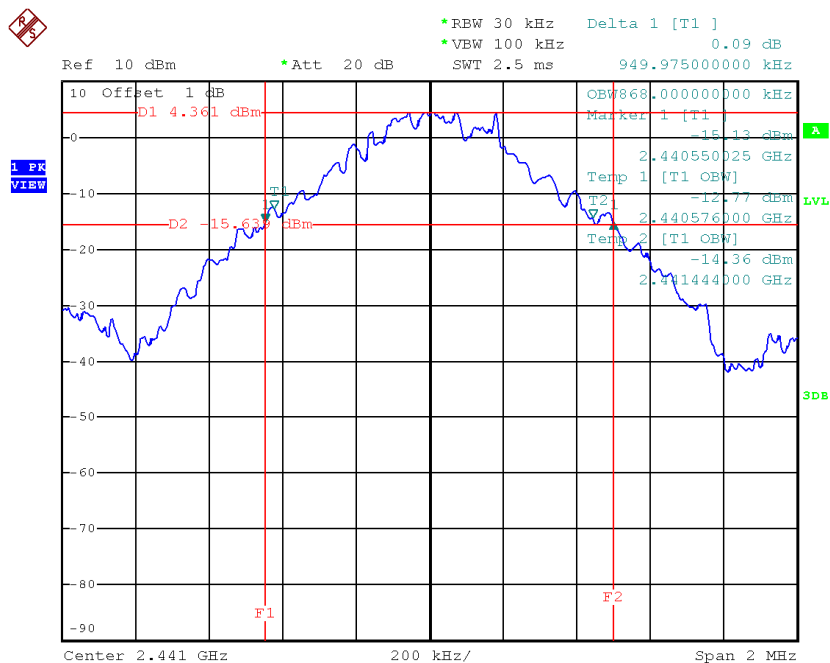

Date: 21.NOV.2014 12:12:11

CH78

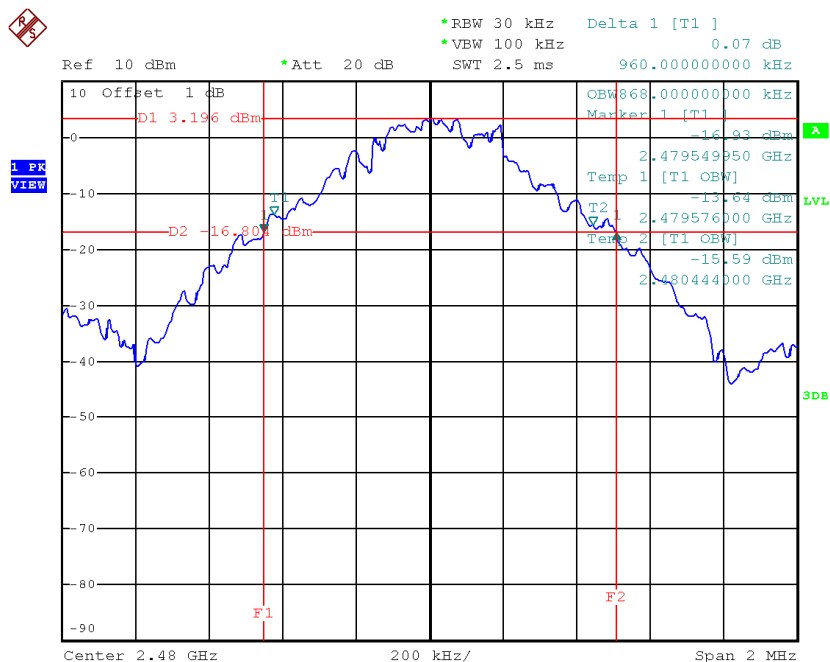

Date: 21.NOV.2014 12:14:16

Test Mode : TX Mode _3Mbps

Frequency (MHz)	20dB Bandwidth (MHz)	99% Occupied BW (MHz)	Test Result
2402	1.282	1.282	Complies
2441	1.264	1.192	Complies
2480	1.284	1.284	Complies

CH00

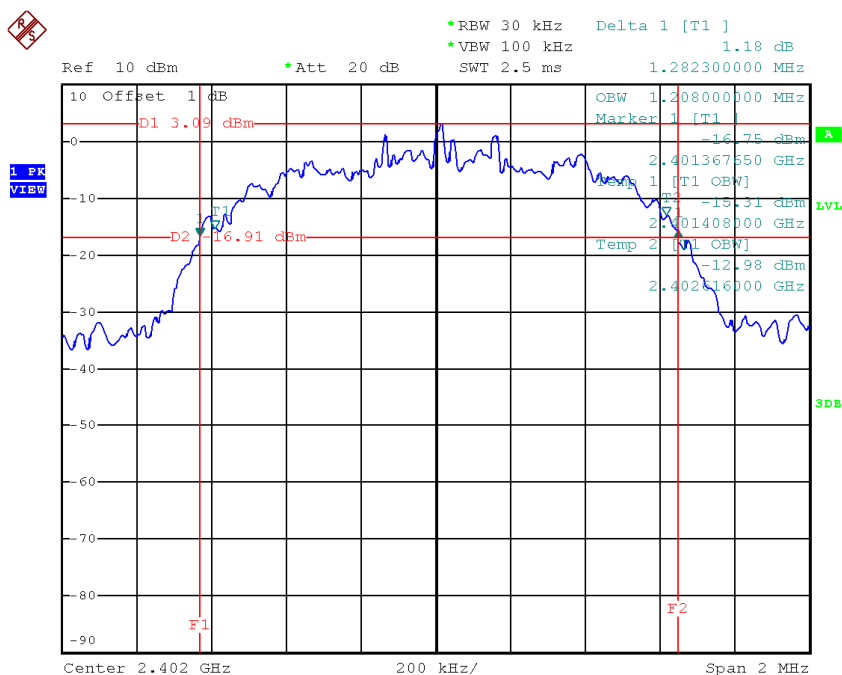

Date: 21.NOV.2014 14:10:46

CH39

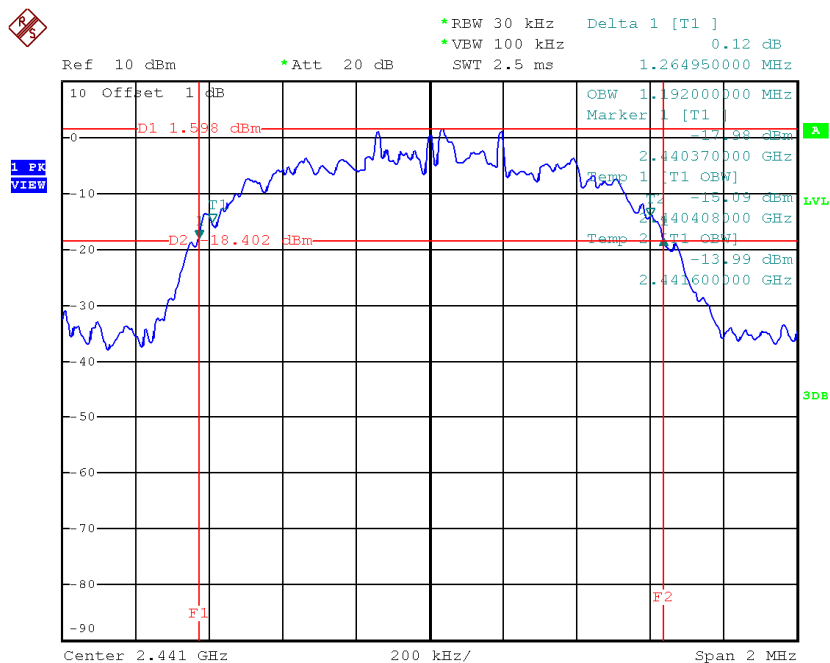

Date: 21.NOV.2014 14:14:09

CH78

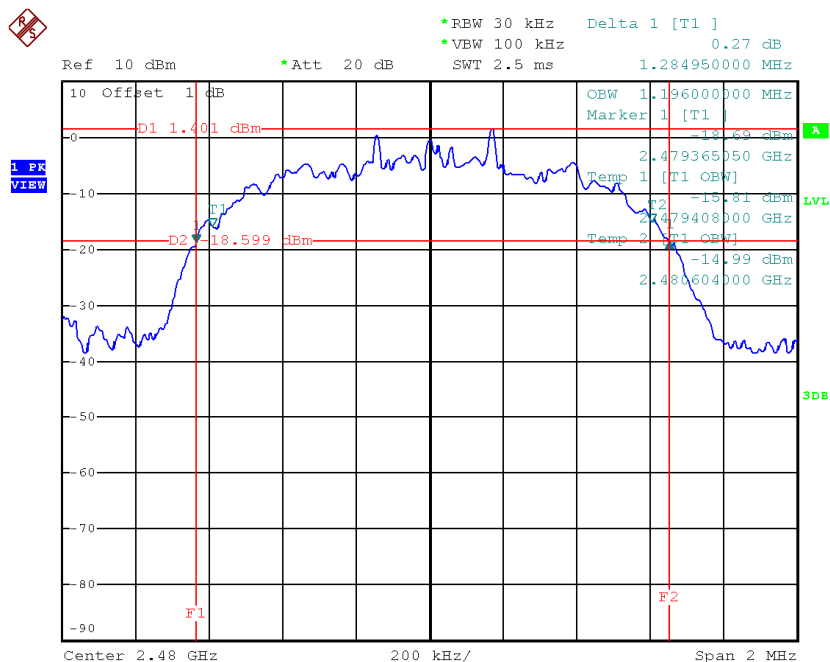

Date: 21.NOV.2014 14:15:35

ATTACHMENT I - PEAK OUTPUT POWER

Test Mode : TX Mode _1Mbps

Frequency (MHz)	Conducted Power (dBm)	Conducted Power (Watt)	Max. Limit (dBm)	Max. Limit (Watt)	Test Result
2402	7.61	0.0058	30.00	1.0000	Complies
2441	7.29	0.0054	30.00	1.0000	Complies
2480	5.98	0.0040	30.00	1.0000	Complies

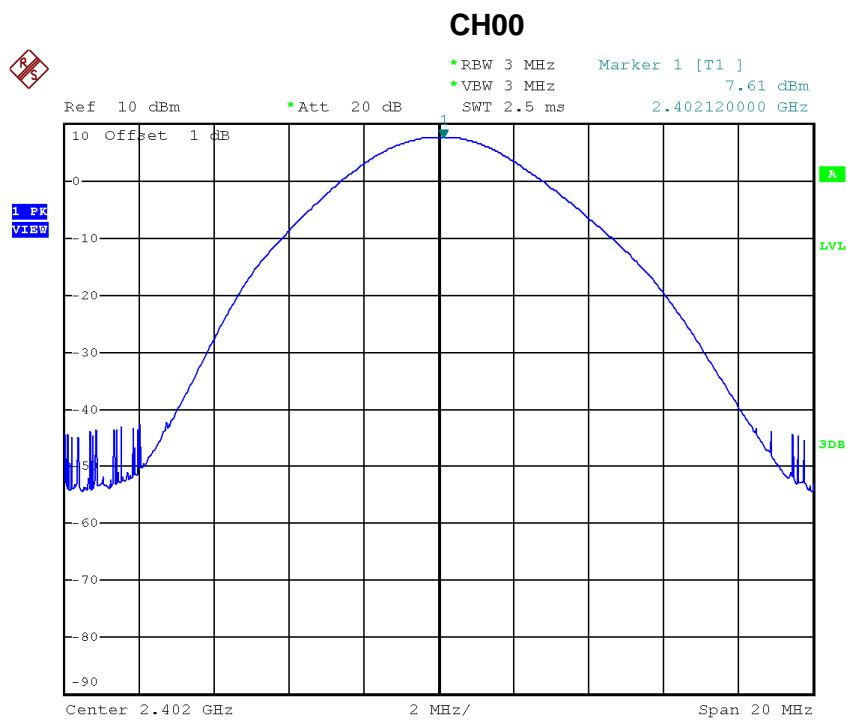

Date: 21.NOV.2014 12:09:18

Test Mode : TX Mode _3Mbps

Frequency (MHz)	Conducted Power (dBm)	Conducted Power (Watt)	Max. Limit (dBm)	Max. Limit (Watt)	Test Result
2402	6.63	0.0046	30.00	1.0000	Complies
2441	5.78	0.0038	30.00	1.0000	Complies
2480	5.00	0.0032	30.00	1.0000	Complies

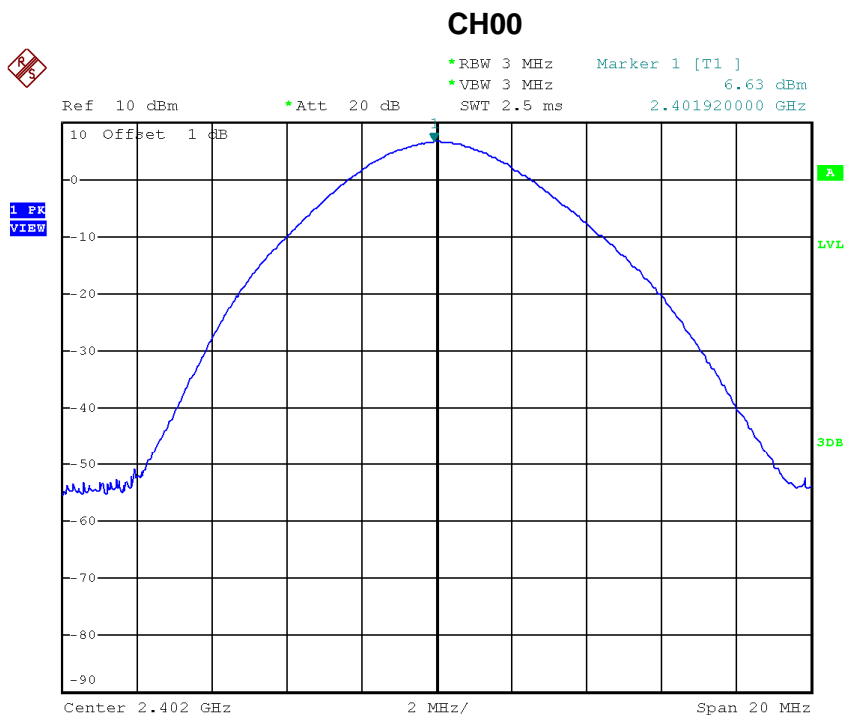

Date: 21.NOV.2014 14:11:18

ATTACHMENT J - ANTENNA CONDUCTED SPURIOUS EMISSION

CH00 (Lower)_1Mbps

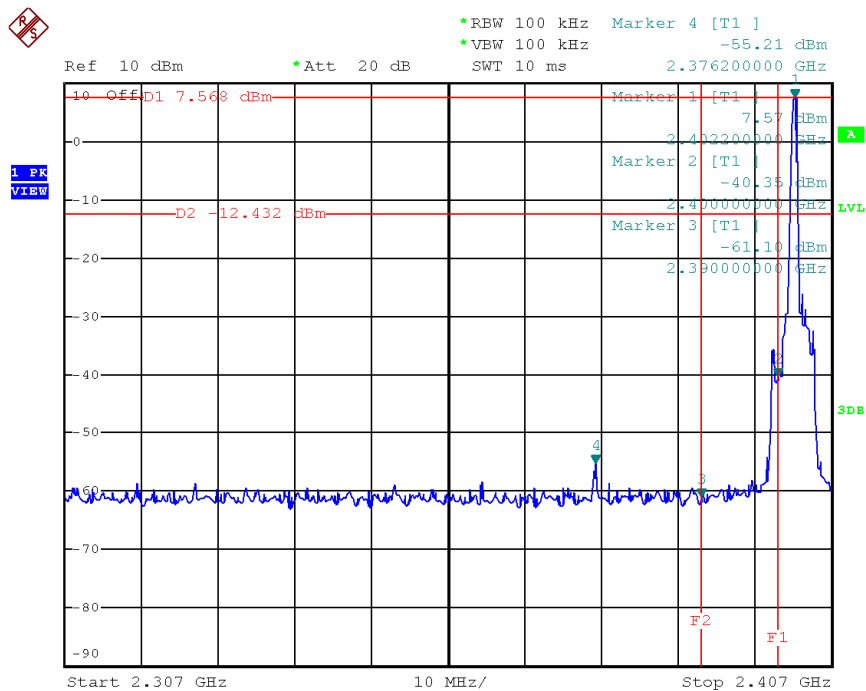

Date: 21.NOV.2014 12:09:11

CH78 (Upper)_1Mbps

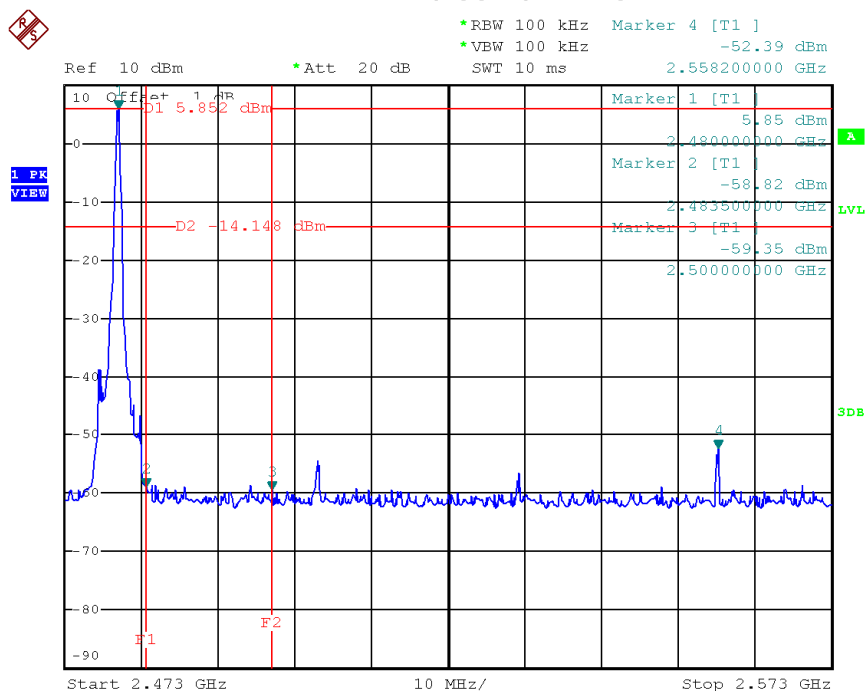

Date: 21.NOV.2014 12:14:25

CH00 (10 Harmonic of the frequency) _1Mbps

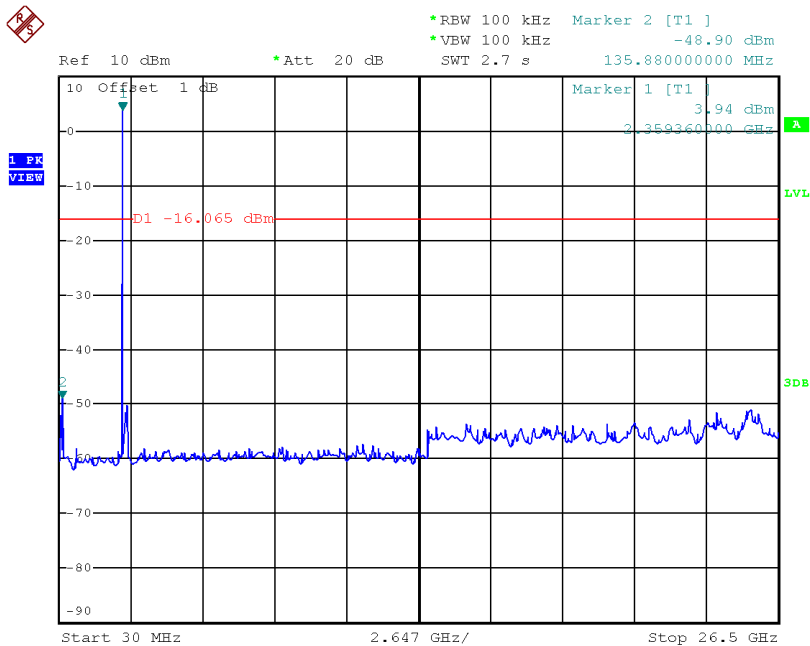

Date: 21.NOV.2014 12:08:16

CH39 (10 Harmonic of the frequency) _1Mbps

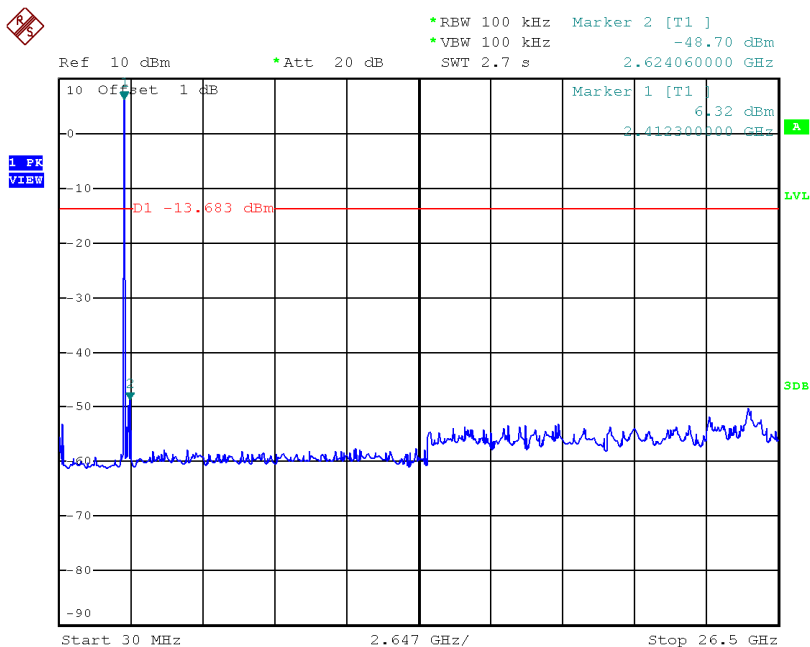

Date: 21.NOV.2014 12:11:24

CH78 (10 Harmonic of the frequency) _1Mbps

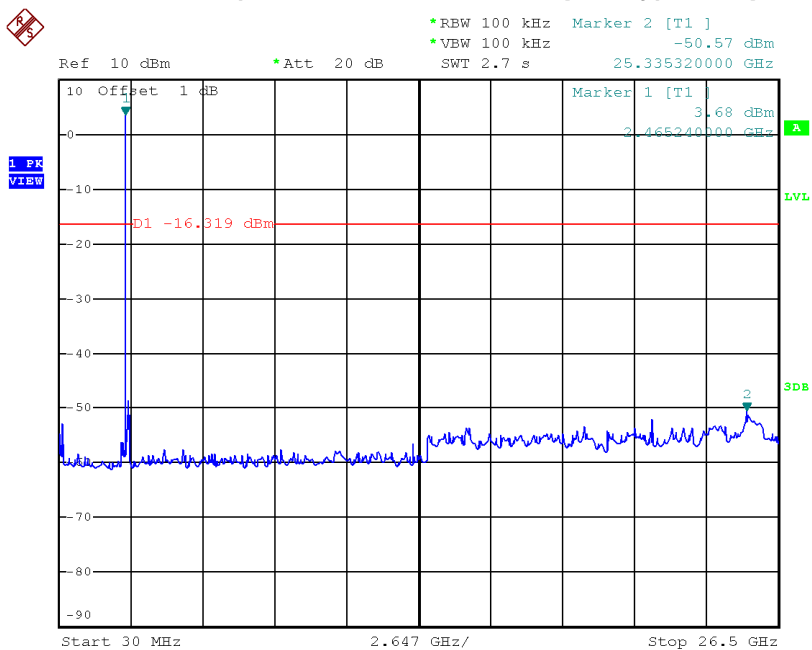

Date: 21.NOV.2014 12:13:29

CH00 (Lower) _3Mbps

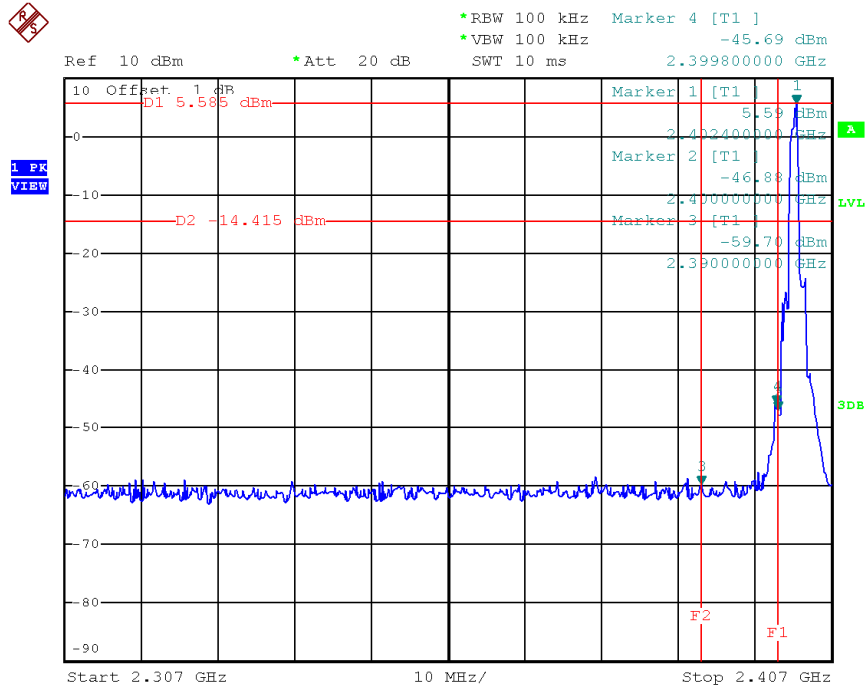

Date: 21.NOV.2014 14:11:12

CH78 (Upper) _3Mbps

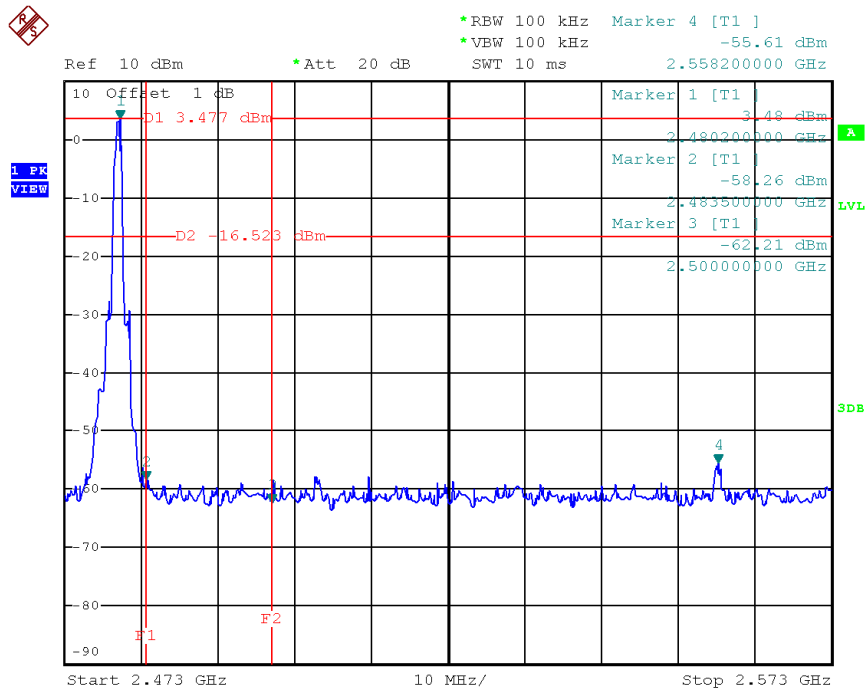

Date: 21.NOV.2014 14:15:44

CH00 (10 Harmonic of the frequency) _3Mbps

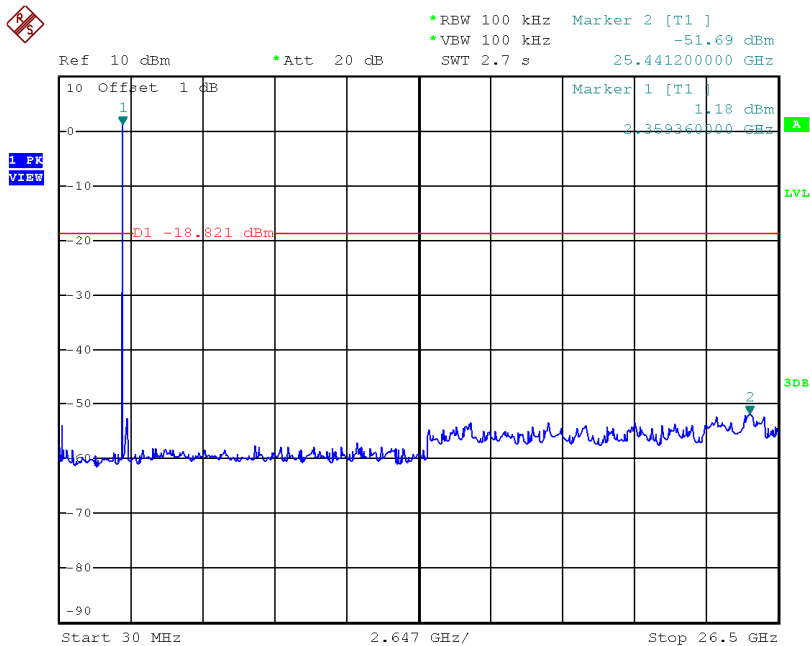

Date: 21.NOV.2014 14:10:16

CH39 (10 Harmonic of the frequency) _3Mbps

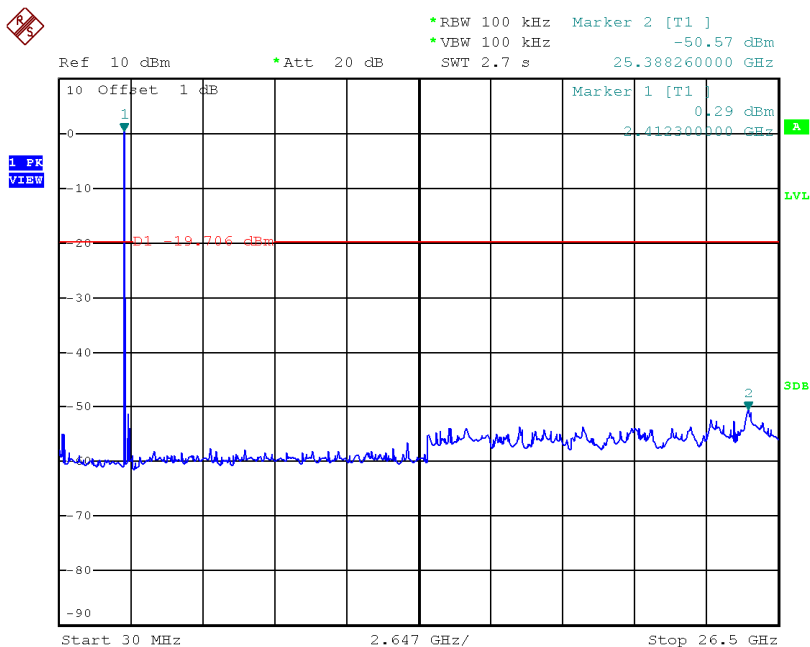

Date: 21.NOV.2014 14:13:38

CH78 (10 Harmonic of the frequency) _3Mbps

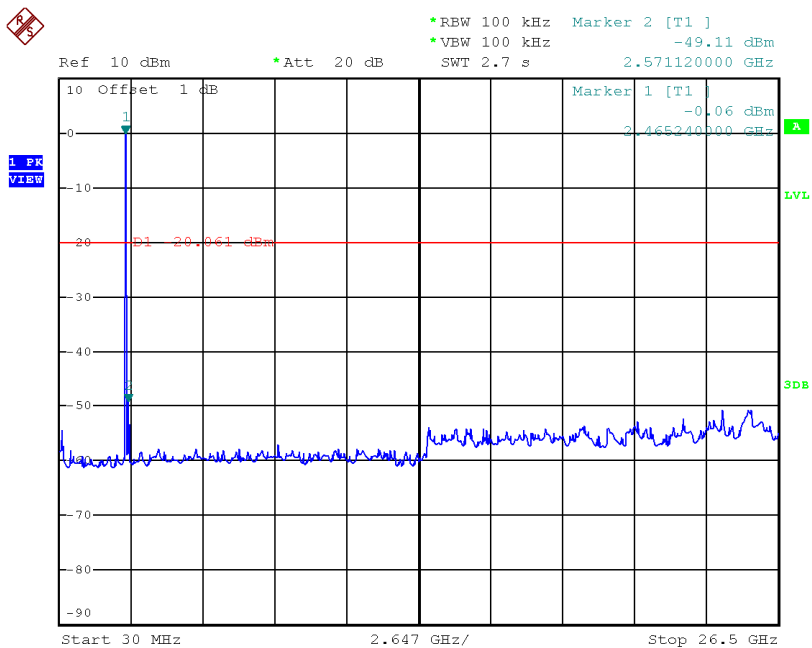

Date: 21.NOV.2014 14:15:06