

FCC Test Report (Part 90 Subpart S)

Report No.: RF180928C18-9 R1

FCC ID: Q3N-RS51

Test Model: RS51

Received Date: Sep. 28, 2018

Test Date: Nov. 29 ~ Dec. 27, 2018

Issued Date: Dec. 28, 2018

Applicant: CIPHERLAB CO., LTD

Address: 12F, 333 Dunhua S. Rd., Sec.2 Taipei, Taiwan 106

Issued By: Bureau Veritas Consumer Products Services (H.K.) Ltd., Taoyuan Branch

Lab Address: No. 47-2, 14th Ling, Chia Pau Vil., Lin Kou Dist., New Taipei City, Taiwan (R.O.C.)

Test Location: No. 19, Hwa Ya 2nd Rd., Wen Hwa Vil., Kwei Shan Dist., Taoyuan City 33383, TAIWAN (R.O.C.)

FCC Registration / 788550 / TW0003

Designation Number:



This report is for your exclusive use. Any copying or replication of this report to or for any other person or entity, or use of our name or trademark, is permitted only with our prior written permission. This report sets forth our findings solely with respect to the test samples identified herein. The results set forth in this report are not indicative or representative of the quality or characteristics of the lot from which a test sample was taken or any similar or identical product specifically and expressly noted. Our report includes all of the tests requested by you and the results thereof based upon the information that you provided to us. You have 60 days from date of issuance of this report to notify us of any material error or omission caused by our negligence, provided, however, that such notice shall be in writing and shall specifically address the issue you wish to raise. A failure to raise such issue within the prescribed time shall constitute your unqualified acceptance of the completeness of this report, the tests conducted and the correctness of the report contents. Unless specific mention, the uncertainty of measurement has been explicitly taken into account to declare the compliance or non-compliance to the specification. The report must not be used by the client to claim product certification, approval, or endorsement by TAF or any government agencies

Table of Contents

Release Control Record	4
1 Certificate of Conformity	5
2 Summary of Test Results	6
2.1 Measurement Uncertainty.....	6
2.2 Test Site and Instruments.....	7
3 General Information	8
3.1 General Description of EUT.....	8
3.2 Configuration of System under Test.....	9
3.2.1 Description of Support Units.....	9
3.3 Test Mode Applicability and Tested Channel Detail.....	10
3.4 EUT Operating Conditions.....	13
3.5 General Description of Applied Standards.....	13
4 Test Types and Results	14
4.1 Output Power Measurement.....	14
4.1.1 Limits of Output Power Measurement.....	14
4.1.2 Test Procedures.....	14
4.1.3 Test Setup.....	15
4.1.4 Test Results.....	16
4.2 Modulation Characteristics Measurement.....	26
4.2.1 Limits of Modulation Characteristics.....	26
4.2.2 Test Procedure.....	26
4.2.3 Test Setu.....	26
4.2.4 Test Results.....	27
4.3 Frequency Stability Measurement.....	28
4.3.1 Limits of Frequency Stability Measurement.....	28
4.3.2 Test Procedure.....	28
4.3.3 Test Setup.....	28
4.3.4 Test Results.....	29
4.4 Occupied Bandwidth Measurement.....	34
4.4.1 Limits of Occupied Bandwidth Measurement.....	34
4.4.2 Test Procedure.....	34
4.4.3 Test Setup.....	34
4.4.4 Test Result.....	35
4.5 Emission Mask Measurement.....	41
4.5.1 Limits of Emission Mask Measurement.....	41
4.5.2 Test Setup.....	41
4.5.3 Test Procedures.....	41
4.5.4 Test Results.....	42
4.6 Peak to Average Ratio.....	50
4.6.1 Limits of Peak to Average Ratio Measurement.....	50
4.6.2 Test Setup.....	50
4.6.3 Test Procedures.....	50
4.6.4 Test Results.....	51
4.7 Conducted Spurious Emissions.....	54
4.7.1 Limits of Conducted Spurious Emissions Measurement.....	54
4.7.2 Test Setup.....	54
4.7.3 Test Procedure.....	54
4.7.4 Test Results.....	55
4.8 Radiated Emission Measurement.....	68
4.8.1 Limits of Radiated Emission Measurement.....	68
4.8.2 Test Procedure.....	68
4.8.3 Deviation from Test Standard.....	68
4.8.4 Test Setup.....	69

4.8.5 Test Results	70
5 Pictures of Test Arrangements.....	87
Appendix – Information on the Testing Laboratories	88

Release Control Record

Issue No.	Description	Date Issued
RF180928C18-9	Original release	Dec. 22, 2018
RF180928C18-9 R1	Added CDMA mode	Dec. 28, 2018

1 Certificate of Conformity

Product: Mobile Computer

Brand: CIPHERLAB

Test Model: RS51

Sample Status: Engineering sample

Applicant: CIPHERLAB CO., LTD

Test Date: Nov. 29 ~ Dec. 27, 2018

Standards: FCC Part 90, Subpart S
FCC Part 2

The above equipment has been tested by **Bureau Veritas Consumer Products Services (H.K.) Ltd., Taoyuan Branch**, and found compliance with the requirement of the above standards. The test record, data evaluation & Equipment Under Test (EUT) configurations represented herein are true and accurate accounts of the measurements of the sample's RF characteristics under the conditions specified in this report.

Prepared by :



Polly Chien / Specialist

Date:

Dec. 28, 2018

Approved by :



Bruce Chen / Project Engineer

Date:

Dec. 28, 2018

2 Summary of Test Results

Applied Standard: FCC Part 90 & Part 2			
FCC Clause	Test Item	Result	Remarks
2.1046 90.635(b)	Maximum Peak Output Power Limit: max. 100 watts e.r.p peak power	Pass	Meet the requirement of limit.
2.1055 90.213	Frequency Stability	Pass	Meet the requirement of limit.
2.1049 90.209	Occupied Bandwidth	Pass	Meet the requirement of limit.
2.1051 90.691	Emission Masks	Pass	Meet the requirement of limit.
---	Peak To Average Ratio	Pass	Meet the requirement of limit.
2.1051 90.691	Conducted Spurious Emissions	Pass	Meet the requirement of limit.
2.1053 90.691	Radiated Spurious Emissions	Pass	Meet the requirement of limit. Minimum passing margin is -33.1dB at 4638.00MHz.

2.1 Measurement Uncertainty

Where relevant, the following measurement uncertainty levels have been estimated for tests performed on the EUT as specified in CISPR 16-4-2:

Measurement	Frequency	Expanded Uncertainty (k=2) (\pm)
Radiated Emissions up to 1 GHz	30MHz ~ 200MHz	3.59 dB
	200MHz ~1000MHz	3.60 dB
Radiated Emissions above 1 GHz	1GHz ~ 18GHz	2.29 dB
	18GHz ~ 40GHz	2.29 dB

2.2 Test Site and Instruments

Description & Manufacturer	Model No.	Serial No.	Cal. Date	Cal. Due
Test Receiver ROHDE & SCHWARZ	ESIB7	100187	May 29, 2018	May 28, 2019
Spectrum Analyzer ROHDE & SCHWARZ	FSP40	100040	Sep. 25, 2018	Sep. 24, 2019
BILOG Antenna SCHWARZBECK	VULB9168	9168-157	Nov. 21, 2018	Nov. 20, 2019
HORN Antenna SCHWARZBECK	BBHA 9120D	9120D-1170	Nov. 25, 2018	Nov. 24, 2019
HORN Antenna SCHWARZBECK	BBHA 9170	BBHA9170241	Nov. 25, 2018	Nov. 24, 2019
Loop Antenna EMCI	EM-6879	269	Sep. 07, 2018	Sep. 06, 2019
Preamplifier Agilent (Below 1GHz)	8447D	2944A10631	Aug. 08, 2018	Aug. 07, 2019
Preamplifier KEYSIGHT (Above 1GHz)	83017A	MY53270295	Jul. 02, 2018	Jul. 01, 2019
RF signal cable HUBER+SUHNER	SUCOFLEX 104	MY 13380+295012/04	Aug. 08, 2018	Aug. 07, 2019
RF signal cable HUBER+SUHNER	SUCOFLEX 104	Cable-CH4-03 (250724)	Aug. 08, 2018	Aug. 07, 2019
Software BV ADT	ADT_Radiated_ V7.6.15.9.5	NA	NA	NA
Antenna Tower inn-co GmbH	MA 4000	010303	NA	NA
Antenna Tower Controller BV ADT	AT100	AT93021703	NA	NA
Turn Table BV ADT	TT100	TT93021703	NA	NA
Turn Table Controller BV ADT	SC100	SC93021703	NA	NA
Boresight Antenna Fixture	FBA-01	FBA-SIP01	NA	NA
Turn Table Controller BV ADT	SC100	SC93021705	NA	NA
WIT Standard Temperature And Humidity Chamber	TH-4S-C	W981030	Jun. 04, 2018	Jun. 03, 2019
JFW 20dB attenuation	50HF-020-SMA	NA	NA	NA
Radio Communication Analyzer	MT8821C	6261786083	Dec. 21, 2017	Dec. 20, 2018
			Dec. 11, 2018	Dec. 10, 2019

- Note: 1. The calibration interval of the above test instruments is 12 months and the calibrations are traceable to NML/ROC and NIST/USA.
2. The test was performed in HwaYa Chamber 4.
3. The FCC Designation Number is TW0003. The number will be varied with the Lab location and scope as attached.
4. The IC Site Registration No. is 7450F-4.

3 General Information

3.1 General Description of EUT

Product	Mobile Computer		
Brand	CIPHERLAB		
Test Model	RS51		
Sample Status	Engineering sample		
Power Supply Rating	5Vdc (adapter) 3.75Vdc (battery)		
Modulation Type	CDMA: QPSK, OQPSK, HPSK LTE: QPSK, 16QAM		
Operating Frequency	CDMA BC10	817.9~823.1MHz	
	LTE Band 26 (Channel Bandwidth 1.4MHz)	814.7~823.3MHz	
	LTE Band 26 (Channel Bandwidth 3MHz)	815.5~822.5MHz	
	LTE Band 26 (Channel Bandwidth 5MHz)	816.5~821.5MHz	
	LTE Band 26 (Channel Bandwidth 10MHz)	819.0MHz	
Emission Designator	CDMA BC10	1M29F9W	
		QPSK	16QAM
	LTE Band 26 (Channel Bandwidth 1.4MHz)	1M08G7D	1M09W7D
	LTE Band 26 (Channel Bandwidth 3MHz)	2M69G7D	2M69W7D
	LTE Band 26 (Channel Bandwidth 5MHz)	4M48G7D	4M48W7D
Max. ERP Power	CDMA BC10	295.121mW (24.7dBm)	
		QPSK	16QAM
	LTE Band 26 (Channel Bandwidth 1.4MHz)	281.838mW (24.5dBm)	223.872mW (23.5dBm)
	LTE Band 26 (Channel Bandwidth 3MHz)	269.153mW (24.3dBm)	223.872mW (23.5dBm)
	LTE Band 26 (Channel Bandwidth 5MHz)	269.153mW (24.3dBm)	218.776mW (23.4dBm)
	LTE Band 26 (Channel Bandwidth 10MHz)	295.121mW (24.7dBm)	229.087mW (23.6dBm)
Antenna Type	Refer to Note		
Antenna Connector	Refer to Note		
Accessory Device	Refer to Note		
Cable Supplied	1.6m non-shielded snapon cable with one core		

Note:

1. The EUT uses following antennas (support units).

Antenna Type	Antenna Connector	Antenna Gain (dBi)		
		Ant.	Main (TX/RX)	Diversity (RX)
PIFA	Spring	CDMA BC10	1.4	-3.17
		LTE Band 26	1.4	-3.17

2. The EUT uses following accessory devices.

Component	Vendor	Model	Specification
Adapter	Sunny COMPUTER TECHNOLOGY CO.,LTD.	SYS1561-1005	I/P: 100-240Vac, 1.0A MAX, 50-60Hz O/P: +5Vdc, 2A, 10W MAX.
Battery	CIPHERLAB	BA-0115A3	Rating: 3.75Vdc, 5300mAh, 19.88Wh

3.2 Configuration of System under Test

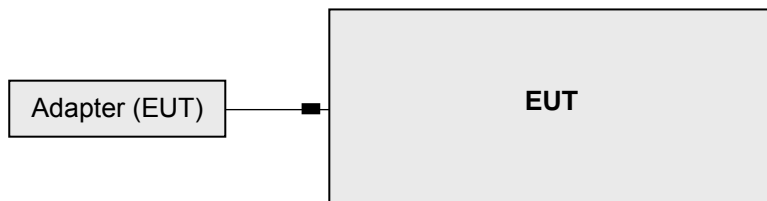

Remote site



3.2.1 Description of Support Units

The EUT has been tested as an independent unit together with other necessary accessories or support units. The following support units or accessories were used to form a representative test configuration during the tests.

ID	Product	Brand	Model No.	Serial No.	FCC ID	Remarks
A.	Radio Communication Analyzer	Anritsu	MT8860C	1702001	NA	-

Note:

1. All power cords of the above support units are non-shielded (1.8m).
2. Item A acted as a communication partner to transfer data.

3.3 Test Mode Applicability and Tested Channel Detail

Pre-Scan has been conducted to determine the worst-case mode from all possible combinations between available modulations, data rates, XYZ axis and antenna ports. The worst case was found when positioned on Z-plane. Following channel(s) was (were) selected for the final test as listed below.

CDMA

EUT Configure Mode	Test Item	Available Channel	Tested Channel	Mode
-	ERP	476 to 684	476(817.9MHz), 580(820.5MHz), 684(823.1MHz)	RC3+SO55
-	Modulation Characteristics	476 to 684	476(817.9MHz), 580(820.5MHz), 684(823.1MHz)	RC1+SO03
-	Frequency Stability	476 to 684	476(817.9MHz), 684(823.1MHz)	RC3+SO55
-	Occupied Bandwidth	476 to 684	476(817.9MHz), 580(820.5MHz), 684(823.1MHz)	RC3+SO55
-	Emission Mask	476 to 684	476(817.9MHz), 684(823.1MHz)	RC3+SO55
-	Peak to Average Ratio	476 to 684	476(817.9MHz), 580(820.5MHz), 684(823.1MHz)	RC3+SO55
-	Conducted Emission	476 to 684	476(817.9MHz), 580(820.5MHz), 684(823.1MHz)	RC3+SO55
-	Radiated Emission Below 1GHz	476 to 684	476(817.9MHz)	RC3+SO55
-	Radiated Emission Above 1GHz	476 to 684	476(817.9MHz), 580(820.5MHz), 684(823.1MHz)	RC3+SO55

LTE Band 26

EUT Configure Mode	Test item	Available channel	Tested channel	Channel Bandwidth	Modulation	Mode
-	ERP	26697 to 26783	26697 (814.7MHz), 26740 (819.0MHz), 26783 (823.3MHz)	1.4MHz	QPSK / 16QAM	1 RB / 0 RB Offset
		26705 to 26775	26705 (815.5MHz), 26740 (819.0MHz), 26775 (822.5MHz)	3MHz	QPSK / 16QAM	1 RB / 0 RB Offset
		26715 to 26765	26715 (816.5MHz), 26740 (819.0MHz), 26765 (821.5MHz)	5MHz	QPSK / 16QAM	1 RB / 0 RB Offset
		26740	26740 (819.0MHz)	10MHz	QPSK / 16QAM	1 RB / 0 RB Offset
-	Modulation Characteristics	26740	26740 (819.0MHz)	10MHz	QPSK / 16QAM	1 RB / 0 RB Offset
-	Frequency Stability	26697 to 26783	26697 (814.7MHz), 26783 (823.3MHz)	1.4MHz	QPSK	1 RB / 0 RB Offset
		26705 to 26775	26705 (815.5MHz), 26775 (822.5MHz)	3MHz	QPSK	1 RB / 0 RB Offset
		26715 to 26765	26715 (816.5MHz), 26765 (821.5MHz)	5MHz	QPSK	1 RB / 0 RB Offset
		26740	26740 (819.0MHz)	10MHz	QPSK	1 RB / 0 RB Offset
-	Occupied Bandwidth	26697 to 26783	26697 (814.7MHz), 26740 (819.0MHz), 26783 (823.3MHz)	1.4MHz	QPSK / 16QAM	1 RB / 0 RB Offset
		26705 to 26775	26705 (815.5MHz), 26740 (819.0MHz), 26775 (822.5MHz)	3MHz	QPSK / 16QAM	1 RB / 0 RB Offset
		26715 to 26765	26715 (816.5MHz), 26740 (819.0MHz), 26765 (821.5MHz)	5MHz	QPSK / 16QAM	1 RB / 0 RB Offset
		26740	26740 (819.0MHz)	10MHz	QPSK / 16QAM	1 RB / 0 RB Offset
-	Emission Masks	26697 to 26783	26697 (814.7MHz), 26783 (823.3MHz)	1.4MHz	QPSK / 16QAM	1 RB / 0 RB Offset 6 RB / 0 RB Offset
		26705 to 26775	26705 (815.5MHz), 26775 (822.5MHz)	3MHz	QPSK / 16QAM	1 RB / 0 RB Offset 15 RB / 0 RB Offset
		26715 to 26765	26715 (816.5MHz), 26765 (821.5MHz)	5MHz	QPSK / 16QAM	1 RB / 0 RB Offset 25 RB / 0 RB Offset
		26740	26740 (819.0MHz)	10MHz	QPSK / 16QAM	1 RB / 0 RB Offset 50 RB / 0 RB Offset
-	Peak to Average Ratio	26697 to 26783	26697 (814.7MHz), 26740 (819.0MHz), 26783 (823.3MHz)	1.4MHz	QPSK / 16QAM	1 RB / 0 RB Offset
		26705 to 26775	26705 (815.5MHz), 26740 (819.0MHz), 26775 (822.5MHz)	3MHz	QPSK / 16QAM	1 RB / 0 RB Offset
		26715 to 26765	26715 (816.5MHz), 26740 (819.0MHz), 26765 (821.5MHz)	5MHz	QPSK / 16QAM	1 RB / 0 RB Offset
		26740	26740 (819.0MHz)	10MHz	QPSK / 16QAM	1 RB / 0 RB Offset

EUT Configure Mode	Test item	Available channel	Tested channel	Channel Bandwidth	Modulation	Mode
-	Conducted Emission	26697 to 26783	26697 (814.7MHz), 26740 (819.0MHz), 26783 (823.3MHz)	1.4MHz	QPSK	1 RB / 0 RB Offset
		26705 to 26775	26705 (815.5MHz), 26740 (819.0MHz), 26775 (822.5MHz)	3MHz	QPSK	1 RB / 0 RB Offset
		26715 to 26765	26715 (816.5MHz), 26740 (819.0MHz), 26765 (821.5MHz)	5MHz	QPSK	1 RB / 0 RB Offset
		26740	26740 (819.0MHz)	10MHz	QPSK	1 RB / 0 RB Offset
-	Radiated Emission Below 1GHz	26697 to 26783	26697 (814.7MHz)	1.4MHz	QPSK	1 RB / 0 RB Offset
		26705 to 26775	26705 (815.5MHz)	3MHz	QPSK	1 RB / 0 RB Offset
		26715 to 26765	26715 (816.5MHz)	5MHz	QPSK	1 RB / 0 RB Offset
		26740	26740 (819.0MHz)	10MHz	QPSK	1 RB / 0 RB Offset
-	Radiated Emission Above 1GHz	26697 to 26783	26697 (814.7MHz), 26740 (819.0MHz), 26783 (823.3MHz)	1.4MHz	QPSK	1 RB / 0 RB Offset
		26715 to 26765	26715 (816.5MHz), 26740 (819.0MHz), 26765 (821.5MHz)	5MHz	QPSK	1 RB / 0 RB Offset
		26740	26740 (819.0MHz)	10MHz	QPSK	1 RB / 0 RB Offset

Note:

1. For radiated emission below 1GHz, low, mid and high channels were pre-tested in chamber. Low channel was the worst case for all final tests.
2. The conducted output power for QPSK and 16QAM, measured value of QPSK is higher than 16QAM mode. Therefore, only occupied bandwidth and Peak to average ratio items had been tested under QPSK and 16QAM modes, the other test items were performed under QPSK mode only.

Test Condition:

Test Item	Environmental Conditions	Input Power	Tested By
ERP	25deg. C, 70%RH	120Vac, 60Hz	Noah Chang
Modulation characteristics	24deg. C, 64%RH	120Vac, 60Hz	Noah Chang
Frequency Stability	24deg. C, 64%RH	120Vac, 60Hz	Noah Chang
Occupied Bandwidth	24deg. C, 64%RH	120Vac, 60Hz	Noah Chang
Emission Mask	24deg. C, 64%RH	120Vac, 60Hz	Noah Chang
Peak To Average Ratio	24deg. C, 64%RH	120Vac, 60Hz	Noah Chang
Conducted Emission	24deg. C, 64%RH	120Vac, 60Hz	Noah Chang
Radiated Emission	25deg. C, 70%RH 25deg. C, 71%RH	120Vac, 60Hz	Noah Chang

3.4 EUT Operating Conditions

The EUT makes a call to the communication simulator. The communication simulator station system controlled a EUT to export maximum output power under transmission mode and specific channel frequency

3.5 General Description of Applied Standards

The EUT is a RF Product. According to the specifications of the manufacturer, it must comply with the requirements of the following standards:

FCC 47 CFR Part 2

FCC 47 CFR Part 90

KDB 971168 D01 Power Meas License Digital Systems v03r01

ANSI/TIA/EIA-603-E 2016

ANSI 63.26-2015

All test items have been performed and recorded as per the above standards.

4 Test Types and Results

4.1 Output Power Measurement

4.1.1 Limits of Output Power Measurement

The radiated peak output power shall be according to the specific rule Part 90.635 that “Mobile station are limited to 100 watts e.r.p”.

4.1.2 Test Procedures

EIRP / ERP Measurement:

- a. All measurements were done at low, middle and high operational frequency range. RWB is 1MHz and VBW is 3MHz.
- b. Substitution method is used for E.I.R.P measurement. In the semi-anechoic chamber, EUT placed on the 0.8m(below or equal 1GHz) and/or 1.5m(above 1GHz) height of Turn Table, rotated the table around 360 degrees to search the maximum radiation power and receiver antenna shall be rotated vertical and horizontal polarization and moved height from 1m to 4m to find the maximum polar radiated power. The “Read Value” is the spectrum reading the maximum power value.
- c. The substitution horn antenna is substituted for EUT at the same position and signals generator export the CW signal to the substitution antenna via a TX cable. Rotated the Turn Table and moved receiving antenna to find the maximum radiation power. Adjust output power level of S.G to get a Value of spectrum reading equal to “Read Value” of step b. Record the power level of S.G
- d. EIRP = Output power level of S.G – TX cable loss + Antenna gain of substitution horn. E.R.P power can be calculated form E.I.R.P power by subtracting the gain of dipole, E.R.P power = E.I.R.P power - 2.15dBi.

Where:

$$ERP/EIRP = P_{Meas} + G_T - L_C$$

P_{Meas} : Measure transmitter output power.

G_T : Gain of the transmitting antenna.

L_C : signal attenuation in the connecting cable between the transmitter and antenna.

Conducted Power Measurement:

The EUT was set up for the maximum power with CDMA and LTE link data modulation and link up with simulator. Set the EUT to transmit under low, middle and high channel and record the power level shown on simulator.

4.1.3 Test Setup

EIRP / ERP Measurement:

For radiated emission 30MHz to 1GHz

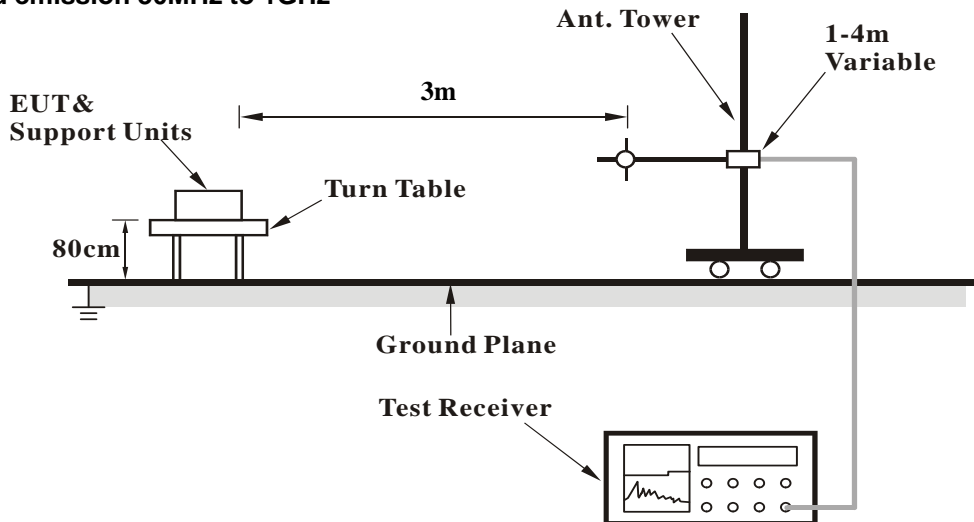

For radiated emission above 1GHz

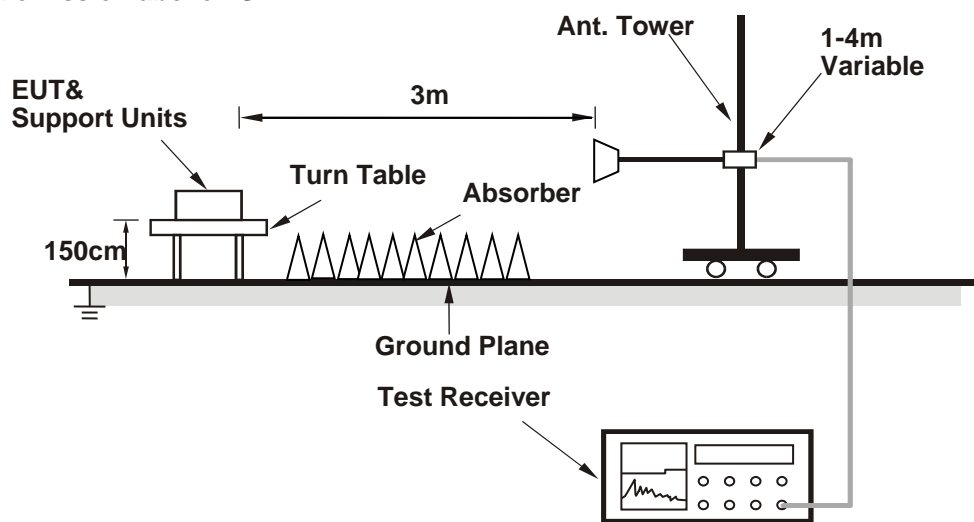

For the actual test configuration, please refer to the attached file (Test Setup Photo).

Conducted Power Measurement:



For the actual test configuration, please refer to the attached file (Test Setup Photo).

4.1.4 Test Results

Conducted Output Power (dBm)

Band	CDMA2000 BC10		
Channel	476	580	684
Frequency (MHz)	817.9	820.5	823.1
RC1+SO55	24.25	24.31	24.26
RC3+SO55	24.29	24.35	24.30
RC3+SO32(+ F-SCH)	24.22	24.28	24.23
RC3+SO32(+SCH)	24.16	24.22	24.17
RC1+SO3, 1/8 Rate	24.19	24.25	24.20
RTAP 153.6	24.12	24.18	24.13
RETAP 4096	24.10	24.16	24.11

LTE Band 26								
BW	MCS Index	RB Size	RB Offset	Mid			3GPP MPR (dB)	Max. Tune-up (dBm)
		Channel		26740				
		Frequency (MHz)		819				
10M	QPSK	1	0	22.43			0	23.5
		1	24	22.45			0	23.5
		1	49	22.55			0	23.5
		25	0	21.57			1	22.5
		25	12	21.60			1	22.5
		25	25	21.58			1	22.5
		50	0	21.55			1	22.5
	16QAM	1	0	21.42			1	22.5
		1	24	21.45			1	22.5
		1	49	21.56			1	22.5
		25	0	20.58			2	21.5
		25	12	20.62			2	21.5
		25	25	20.63			2	21.5
		50	0	20.60			2	21.5
BW	MCS Index	Channel		26715	26740	26765	3GPP MPR	Max. Tune-up
		Frequency (MHz)		816.5	819	821.5		
5M	QPSK	1	0	22.40	22.33	22.53	0	23.5
		1	12	22.46	22.40	22.60	0	23.5
		1	24	22.57	22.45	22.51	0	23.5
		12	0	21.58	21.52	21.74	1	22.5
		12	6	21.62	21.58	21.75	1	22.5
		12	13	21.65	21.62	21.78	1	22.5
		25	0	21.57	21.55	21.72	1	22.5
	16QAM	1	0	21.35	21.36	21.50	1	22.5
		1	12	21.41	21.38	21.52	1	22.5
		1	24	21.52	21.49	21.60	1	22.5
		12	0	20.53	20.45	20.56	2	21.5
		12	6	20.57	20.55	20.58	2	21.5
		12	13	20.60	20.56	20.70	2	21.5
		25	0	20.52	20.48	20.72	2	21.5

LTE Band 26								
BW	MCS Index	Channel		26705	26740	26775	3GPP MPR	Max. Tune-up
		Frequency (MHz)		815.5	819	822.5		
3M	QPSK	1	0	22.44	22.42	22.58	0	23.5
		1	7	22.50	22.48	22.65	0	23.5
		1	14	22.61	22.50	22.33	0	23.5
		8	0	21.62	21.56	21.74	1	22.5
		8	3	21.66	21.63	21.78	1	22.5
		8	7	21.69	21.68	21.80	1	22.5
		15	0	21.61	21.57	21.74	1	22.5
	16QAM	1	0	21.39	21.38	21.54	1	22.5
		1	7	21.45	21.45	21.60	1	22.5
		1	14	21.56	21.58	21.77	1	22.5
		8	0	20.57	20.53	20.70	2	21.5
		8	3	20.61	20.60	20.75	2	21.5
		8	7	20.64	20.63	20.78	2	21.5
		15	0	20.56	20.55	20.74	2	21.5
BW	MCS Index	Channel		26697	26740	26783	3GPP MPR	Max. Tune-up
		Frequency (MHz)		814.7	819	823.3		
1.4M	QPSK	1	0	22.36	22.34	22.55	0	23.5
		1	2	22.42	22.35	22.54	0	23.5
		1	5	22.53	22.52	22.64	0	23.5
		3	0	22.27	22.33	22.47	0	23.5
		3	1	22.31	22.22	22.46	0	23.5
		3	3	22.34	22.35	22.48	0	23.5
		6	0	21.53	21.45	21.58	1	22.5
	16QAM	1	0	21.31	21.36	21.40	1	22.5
		1	2	21.37	21.38	21.56	1	22.5
		1	5	21.48	21.48	21.58	1	22.5
		3	0	21.22	21.15	21.35	1	22.5
		3	1	21.26	21.26	21.45	1	22.5
		3	3	21.29	21.27	21.38	1	22.5
		6	0	20.48	20.48	20.68	2	21.5

ERP Power
CDMA

MODE		TX channel 476					
Antenna Polarity & Test Distance: Horizontal at 3 M							
No.	Freq. (MHz)	Reading (dBm)	S.G Power Value (dBm)	Correction Factor (dB)	EIRP (dBm)	Limit (dBm)	Margin (dB)
1	817.90	-15.4	15.9	-0.2	15.7	50.0	-34.3
Antenna Polarity & Test Distance: Vertical at 3 M							
No.	Freq. (MHz)	Reading (dBm)	S.G Power Value (dBm)	Correction Factor (dB)	EIRP (dBm)	Limit (dBm)	Margin (dB)
1	817.90	-7.2	24.9	-0.2	24.7	50.0	-25.3

MODE		TX channel 580					
Antenna Polarity & Test Distance: Horizontal at 3 M							
No.	Freq. (MHz)	Reading (dBm)	S.G Power Value (dBm)	Correction Factor (dB)	EIRP (dBm)	Limit (dBm)	Margin (dB)
1	820.50	-15.2	16.0	-0.1	15.9	50.0	-34.1
Antenna Polarity & Test Distance: Vertical at 3 M							
No.	Freq. (MHz)	Reading (dBm)	S.G Power Value (dBm)	Correction Factor (dB)	EIRP (dBm)	Limit (dBm)	Margin (dB)
1	820.50	-7.8	24.3	-0.1	24.2	50.0	-25.8

MODE		TX channel 684					
Antenna Polarity & Test Distance: Horizontal at 3 M							
No.	Freq. (MHz)	Reading (dBm)	S.G Power Value (dBm)	Correction Factor (dB)	EIRP (dBm)	Limit (dBm)	Margin (dB)
1	823.10	-15.8	15.5	-0.1	15.4	50.0	-34.6
Antenna Polarity & Test Distance: Vertical at 3 M							
No.	Freq. (MHz)	Reading (dBm)	S.G Power Value (dBm)	Correction Factor (dB)	EIRP (dBm)	Limit (dBm)	Margin (dB)
1	823.10	-7.6	24.4	-0.1	24.3	50.0	-25.7

Note: EIRP (dBm) = S.G Power Value (dBm) + Correction Factor (dB).

Modulation Type: QPSK

LTE Band 26, Channel Bandwidth 1.4MHz

MODE		TX channel 26697					
Antenna Polarity & Test Distance: Horizontal at 3 M							
No.	Freq. (MHz)	Reading (dBm)	S.G Power Value (dBm)	Correction Factor (dB)	ERP (dBm)	Limit (dBm)	Margin (dB)
1	814.70	-12.9	18.5	-0.3	18.2	50.0	-31.8
Antenna Polarity & Test Distance: Vertical at 3 M							
No.	Freq. (MHz)	Reading (dBm)	S.G Power Value (dBm)	Correction Factor (dB)	ERP (dBm)	Limit (dBm)	Margin (dB)
1	814.70	-7.4	24.8	-0.3	24.5	50.0	-25.5

MODE		TX channel 26740					
Antenna Polarity & Test Distance: Horizontal at 3 M							
No.	Freq. (MHz)	Reading (dBm)	S.G Power Value (dBm)	Correction Factor (dB)	ERP (dBm)	Limit (dBm)	Margin (dB)
1	819.00	-13.1	18.2	-0.2	18.0	50.0	-32.0
Antenna Polarity & Test Distance: Vertical at 3 M							
No.	Freq. (MHz)	Reading (dBm)	S.G Power Value (dBm)	Correction Factor (dB)	ERP (dBm)	Limit (dBm)	Margin (dB)
1	819.00	-7.7	24.4	-0.2	24.2	50.0	-25.8

MODE		TX channel 26783					
Antenna Polarity & Test Distance: Horizontal at 3 M							
No.	Freq. (MHz)	Reading (dBm)	S.G Power Value (dBm)	Correction Factor (dB)	ERP (dBm)	Limit (dBm)	Margin (dB)
1	823.30	-13.1	18.2	-0.1	18.1	50.0	-31.9
Antenna Polarity & Test Distance: Vertical at 3 M							
No.	Freq. (MHz)	Reading (dBm)	S.G Power Value (dBm)	Correction Factor (dB)	ERP (dBm)	Limit (dBm)	Margin (dB)
1	823.30	-7.5	24.6	-0.1	24.5	50.0	-25.5

Note: ERP (dBm) = S.G Power Value (dBm) + Correction Factor (dB).

LTE Band 26, Channel Bandwidth 3MHz

MODE		TX channel 26705					
Antenna Polarity & Test Distance: Horizontal at 3 M							
No.	Freq. (MHz)	Reading (dBm)	S.G Power Value (dBm)	Correction Factor (dB)	ERP (dBm)	Limit (dBm)	Margin (dB)
1	815.50	-13.8	17.6	-0.3	17.3	50.0	-32.7
Antenna Polarity & Test Distance: Vertical at 3 M							
No.	Freq. (MHz)	Reading (dBm)	S.G Power Value (dBm)	Correction Factor (dB)	ERP (dBm)	Limit (dBm)	Margin (dB)
1	815.50	-7.9	24.3	-0.3	24.0	50.0	-26.0

MODE		TX channel 26740					
Antenna Polarity & Test Distance: Horizontal at 3 M							
No.	Freq. (MHz)	Reading (dBm)	S.G Power Value (dBm)	Correction Factor (dB)	ERP (dBm)	Limit (dBm)	Margin (dB)
1	819.00	-13.2	18.1	-0.2	17.9	50.0	-32.1
Antenna Polarity & Test Distance: Vertical at 3 M							
No.	Freq. (MHz)	Reading (dBm)	S.G Power Value (dBm)	Correction Factor (dB)	ERP (dBm)	Limit (dBm)	Margin (dB)
1	819.00	-8.2	23.9	-0.2	23.7	50.0	-26.3

MODE		TX channel 26775					
Antenna Polarity & Test Distance: Horizontal at 3 M							
No.	Freq. (MHz)	Reading (dBm)	S.G Power Value (dBm)	Correction Factor (dB)	ERP (dBm)	Limit (dBm)	Margin (dB)
1	822.50	-13.6	17.7	-0.1	17.6	50.0	-32.4
Antenna Polarity & Test Distance: Vertical at 3 M							
No.	Freq. (MHz)	Reading (dBm)	S.G Power Value (dBm)	Correction Factor (dB)	ERP (dBm)	Limit (dBm)	Margin (dB)
1	822.50	-7.6	24.4	-0.1	24.3	50.0	-25.7

Note: ERP (dBm) = S.G Power Value (dBm) + Correction Factor (dB).

LTE Band 26, Channel Bandwidth 5MHz

MODE		TX channel 26715					
Antenna Polarity & Test Distance: Horizontal at 3 M							
No.	Freq. (MHz)	Reading (dBm)	S.G Power Value (dBm)	Correction Factor (dB)	ERP (dBm)	Limit (dBm)	Margin (dB)
1	816.50	-13.3	18.0	-0.2	17.8	50.0	-32.2
Antenna Polarity & Test Distance: Vertical at 3 M							
No.	Freq. (MHz)	Reading (dBm)	S.G Power Value (dBm)	Correction Factor (dB)	ERP (dBm)	Limit (dBm)	Margin (dB)
1	816.50	-7.9	24.2	-0.2	24.0	50.0	-26.0

MODE		TX channel 26740					
Antenna Polarity & Test Distance: Horizontal at 3 M							
No.	Freq. (MHz)	Reading (dBm)	S.G Power Value (dBm)	Correction Factor (dB)	ERP (dBm)	Limit (dBm)	Margin (dB)
1	819.00	-13.3	18.0	-0.2	17.8	50.0	-32.2
Antenna Polarity & Test Distance: Vertical at 3 M							
No.	Freq. (MHz)	Reading (dBm)	S.G Power Value (dBm)	Correction Factor (dB)	ERP (dBm)	Limit (dBm)	Margin (dB)
1	819.00	-7.7	24.4	-0.2	24.2	50.0	-25.8

MODE		TX channel 26765					
Antenna Polarity & Test Distance: Horizontal at 3 M							
No.	Freq. (MHz)	Reading (dBm)	S.G Power Value (dBm)	Correction Factor (dB)	ERP (dBm)	Limit (dBm)	Margin (dB)
1	821.50	-12.9	18.4	-0.1	18.3	50.0	-31.7
Antenna Polarity & Test Distance: Vertical at 3 M							
No.	Freq. (MHz)	Reading (dBm)	S.G Power Value (dBm)	Correction Factor (dB)	ERP (dBm)	Limit (dBm)	Margin (dB)
1	821.50	-7.6	24.4	-0.1	24.3	50.0	-25.7

Note: ERP (dBm) = S.G Power Value (dBm) + Correction Factor (dB).

LTE Band 26, Channel Bandwidth 10MHz

MODE		TX channel 26740					
Antenna Polarity & Test Distance: Horizontal at 3 M							
No.	Freq. (MHz)	Reading (dBm)	S.G Power Value (dBm)	Correction Factor (dB)	ERP (dBm)	Limit (dBm)	Margin (dB)
1	819.00	-13.0	18.3	-0.2	18.1	50.0	-31.9
Antenna Polarity & Test Distance: Vertical at 3 M							
No.	Freq. (MHz)	Reading (dBm)	S.G Power Value (dBm)	Correction Factor (dB)	ERP (dBm)	Limit (dBm)	Margin (dB)
1	819.00	-7.2	24.9	-0.2	24.7	50.0	-25.3

Note: ERP (dBm) = S.G Power Value (dBm) + Correction Factor (dB).

Modulation Type: 16QAM

LTE Band 26, Channel Bandwidth 1.4MHz

MODE		TX channel 26697					
Antenna Polarity & Test Distance: Horizontal at 3 M							
No.	Freq. (MHz)	Reading (dBm)	S.G Power Value (dBm)	Correction Factor (dB)	ERP (dBm)	Limit (dBm)	Margin (dB)
1	814.70	-13.9	17.5	-0.3	17.2	50.0	-32.8
Antenna Polarity & Test Distance: Vertical at 3 M							
No.	Freq. (MHz)	Reading (dBm)	S.G Power Value (dBm)	Correction Factor (dB)	ERP (dBm)	Limit (dBm)	Margin (dB)
1	814.70	-8.6	23.6	-0.3	23.3	50.0	-26.7

MODE		TX channel 26740					
Antenna Polarity & Test Distance: Horizontal at 3 M							
No.	Freq. (MHz)	Reading (dBm)	S.G Power Value (dBm)	Correction Factor (dB)	ERP (dBm)	Limit (dBm)	Margin (dB)
1	819.00	-14.1	17.2	-0.2	17.0	50.0	-33.0
Antenna Polarity & Test Distance: Vertical at 3 M							
No.	Freq. (MHz)	Reading (dBm)	S.G Power Value (dBm)	Correction Factor (dB)	ERP (dBm)	Limit (dBm)	Margin (dB)
1	819.00	-8.4	23.7	-0.2	23.5	50.0	-26.5

MODE		TX channel 26783					
Antenna Polarity & Test Distance: Horizontal at 3 M							
No.	Freq. (MHz)	Reading (dBm)	S.G Power Value (dBm)	Correction Factor (dB)	ERP (dBm)	Limit (dBm)	Margin (dB)
1	823.30	-13.9	17.4	-0.1	17.3	50.0	-32.7
Antenna Polarity & Test Distance: Vertical at 3 M							
No.	Freq. (MHz)	Reading (dBm)	S.G Power Value (dBm)	Correction Factor (dB)	ERP (dBm)	Limit (dBm)	Margin (dB)
1	823.30	-8.5	23.6	-0.1	23.5	50.0	-26.5

Note: ERP (dBm) = S.G Power Value (dBm) + Correction Factor (dB).

LTE Band 26, Channel Bandwidth 3MHz

MODE		TX channel 26705					
Antenna Polarity & Test Distance: Horizontal at 3 M							
No.	Freq. (MHz)	Reading (dBm)	S.G Power Value (dBm)	Correction Factor (dB)	ERP (dBm)	Limit (dBm)	Margin (dB)
1	815.50	-14.7	16.7	-0.3	16.4	50.0	-33.6
Antenna Polarity & Test Distance: Vertical at 3 M							
No.	Freq. (MHz)	Reading (dBm)	S.G Power Value (dBm)	Correction Factor (dB)	ERP (dBm)	Limit (dBm)	Margin (dB)
1	815.50	-8.8	23.4	-0.3	23.1	50.0	-26.9

MODE		TX channel 26740					
Antenna Polarity & Test Distance: Horizontal at 3 M							
No.	Freq. (MHz)	Reading (dBm)	S.G Power Value (dBm)	Correction Factor (dB)	ERP (dBm)	Limit (dBm)	Margin (dB)
1	819.00	-14.2	17.1	-0.2	16.9	50.0	-33.1
Antenna Polarity & Test Distance: Vertical at 3 M							
No.	Freq. (MHz)	Reading (dBm)	S.G Power Value (dBm)	Correction Factor (dB)	ERP (dBm)	Limit (dBm)	Margin (dB)
1	819.00	-9.4	22.7	-0.2	22.5	50.0	-27.5

MODE		TX channel 26775					
Antenna Polarity & Test Distance: Horizontal at 3 M							
No.	Freq. (MHz)	Reading (dBm)	S.G Power Value (dBm)	Correction Factor (dB)	ERP (dBm)	Limit (dBm)	Margin (dB)
1	822.50	-14.4	16.9	-0.1	16.8	50.0	-33.2
Antenna Polarity & Test Distance: Vertical at 3 M							
No.	Freq. (MHz)	Reading (dBm)	S.G Power Value (dBm)	Correction Factor (dB)	ERP (dBm)	Limit (dBm)	Margin (dB)
1	822.50	-8.4	23.6	-0.1	23.5	50.0	-26.5

Note: ERP (dBm) = S.G Power Value (dBm) + Correction Factor (dB).

LTE Band 26, Channel Bandwidth 5MHz

MODE		TX channel 26715					
Antenna Polarity & Test Distance: Horizontal at 3 M							
No.	Freq. (MHz)	Reading (dBm)	S.G Power Value (dBm)	Correction Factor (dB)	ERP (dBm)	Limit (dBm)	Margin (dB)
1	816.50	-14.3	17.0	-0.2	16.8	50.0	-33.2
Antenna Polarity & Test Distance: Vertical at 3 M							
No.	Freq. (MHz)	Reading (dBm)	S.G Power Value (dBm)	Correction Factor (dB)	ERP (dBm)	Limit (dBm)	Margin (dB)
1	816.50	-8.8	23.3	-0.2	23.1	50.0	-26.9

MODE		TX channel 26740					
Antenna Polarity & Test Distance: Horizontal at 3 M							
No.	Freq. (MHz)	Reading (dBm)	S.G Power Value (dBm)	Correction Factor (dB)	ERP (dBm)	Limit (dBm)	Margin (dB)
1	819.00	-14.4	16.9	-0.2	16.7	50.0	-33.3
Antenna Polarity & Test Distance: Vertical at 3 M							
No.	Freq. (MHz)	Reading (dBm)	S.G Power Value (dBm)	Correction Factor (dB)	ERP (dBm)	Limit (dBm)	Margin (dB)
1	819.00	-8.9	23.2	-0.2	23.0	50.0	-27.0

MODE		TX channel 26765					
Antenna Polarity & Test Distance: Horizontal at 3 M							
No.	Freq. (MHz)	Reading (dBm)	S.G Power Value (dBm)	Correction Factor (dB)	ERP (dBm)	Limit (dBm)	Margin (dB)
1	821.50	-13.8	17.6	-0.1	17.5	50.0	-32.5
Antenna Polarity & Test Distance: Vertical at 3 M							
No.	Freq. (MHz)	Reading (dBm)	S.G Power Value (dBm)	Correction Factor (dB)	ERP (dBm)	Limit (dBm)	Margin (dB)
1	821.50	-8.5	23.5	-0.1	23.4	50.0	-26.6

Note: ERP (dBm) = S.G Power Value (dBm) + Correction Factor (dB).

LTE Band 26, Channel Bandwidth 10MHz

MODE		TX channel 26740					
Antenna Polarity & Test Distance: Horizontal at 3 M							
No.	Freq. (MHz)	Reading (dBm)	S.G Power Value (dBm)	Correction Factor (dB)	ERP (dBm)	Limit (dBm)	Margin (dB)
1	819.00	-13.8	17.5	-0.2	17.3	50.0	-32.7
Antenna Polarity & Test Distance: Vertical at 3 M							
No.	Freq. (MHz)	Reading (dBm)	S.G Power Value (dBm)	Correction Factor (dB)	ERP (dBm)	Limit (dBm)	Margin (dB)
1	819.00	-8.2	23.8	-0.2	23.6	50.0	-26.4

Note: ERP (dBm) = S.G Power Value (dBm) + Correction Factor (dB).

4.2 Modulation Characteristics Measurement

4.2.1 Limits of Modulation Characteristics

N/A

4.2.2 Test Procedure

Connect the EUT to Communication Simulator via the antenna connector, The frequency band is set as EUT supported Modulation and Channels, the EUT output is matched with 50 ohm load, the waveform quality and constellation of the EUT was tested.

4.2.3 Test Setup



4.2.4 Test Results

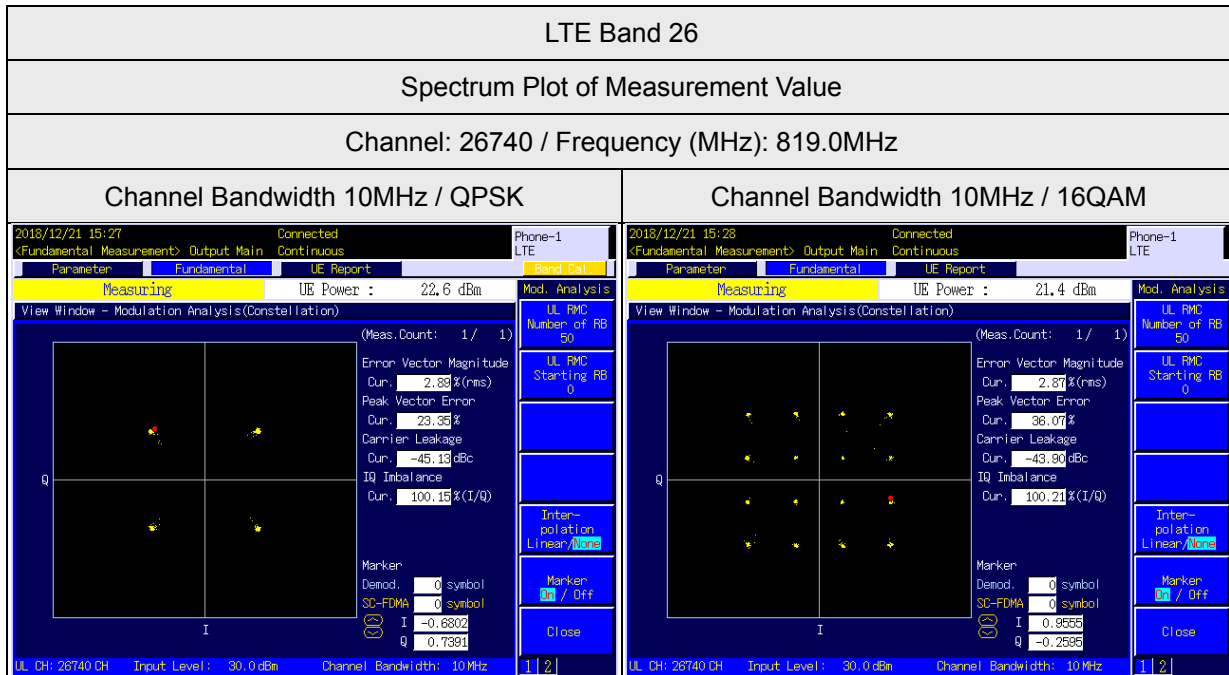
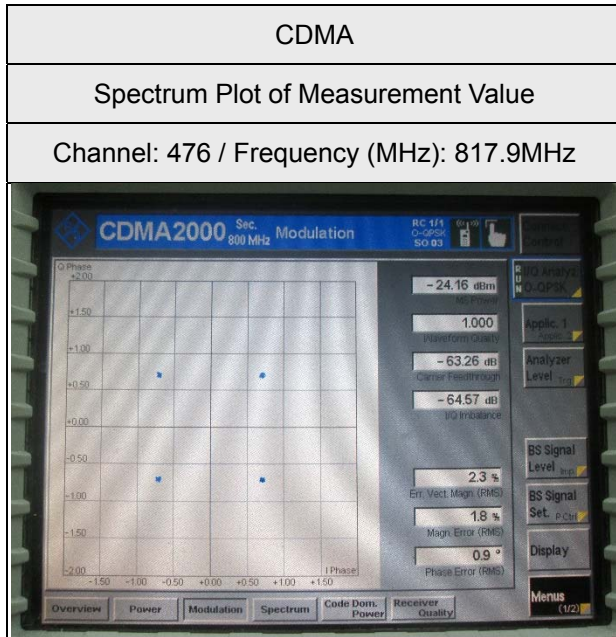

4.3 Frequency Stability Measurement

4.3.1 Limits of Frequency Stability Measurement

1.5 ppm is for base and fixed station. 2.5 ppm is for mobile station.

4.3.2 Test Procedure

- a. Device is placed at the oven room. The oven room could control the temperatures and humidity. Power warm up is at least 15 min and power applied should perform before recording frequency error.
- b. EUT is connected the external power supply to control the DC input power. The test voltage range is from minimum to maximum working voltage. Each step shall be record the frequency error rate.
- c. The temperature range step is 10 degrees in this test items. All temperature levels shall be hold the ± 0.5 °C during the measurement testing. The each temperature step shall be at least 0.5 hours, consider the EUT could be test under the stability condition.

Note: The frequency error was recorded frequency error from the communication simulator.

4.3.3 Test Setup

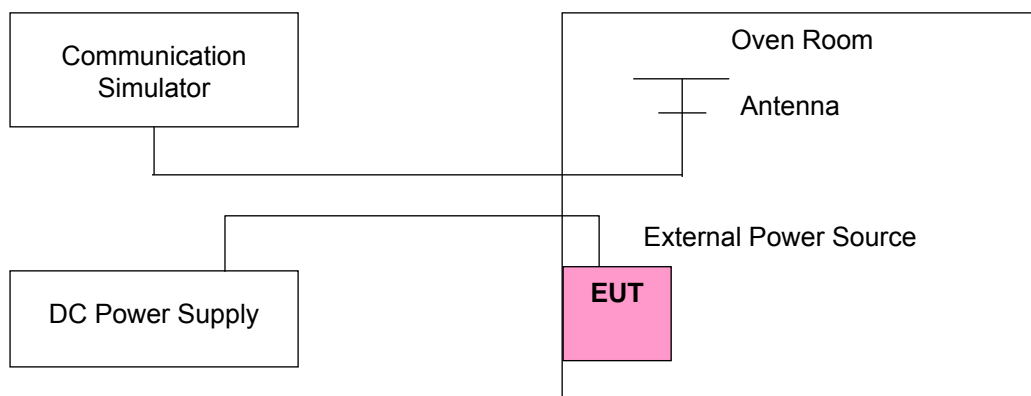

4.3.4 Test Results

Frequency Error vs. Voltage

Voltage (Volts)	CDMA			
	Low Channel		High Channel	
	Frequency (MHz)	Frequency Error (ppm)	Frequency (MHz)	Frequency Error (ppm)
3.20	817.900003	0.003	823.100003	0.003
3.75	817.900003	0.003	823.100003	0.003
4.30	817.900002	0.002	823.100002	0.002

Note: The applicant defined the normal working voltage is from 3.20Vdc to 4.30Vdc.

Frequency Error vs. Temperature

Temp. (°C)	CDMA			
	Low Channel		High Channel	
	Frequency (MHz)	Frequency Error (ppm)	Frequency (MHz)	Frequency Error (ppm)
-30	817.900003	0.004	823.100003	0.004
-20	817.900002	0.003	823.100003	0.004
-10	817.900003	0.003	823.100003	0.003
0	817.900002	0.003	823.100003	0.003
10	817.900002	0.002	823.100002	0.003
20	817.899998	-0.003	823.099997	-0.003
30	817.899997	-0.004	823.099997	-0.003
40	817.899997	-0.004	823.099997	-0.004
50	817.899997	-0.004	823.099997	-0.004
60	817.899997	-0.004	823.099997	-0.004

Frequency Error vs. Voltage

Voltage (Volts)	LTE Band 26			
	Channel Bandwidth: 1.4 MHz			
	Low Channel		High Channel	
	Frequency (MHz)	Frequency Error (ppm)	Frequency (MHz)	Frequency Error (ppm)
3.20	814.700002	0.002	823.300000	0.004
3.75	814.700002	0.002	823.300000	0.004
4.30	814.700001	0.001	823.300000	0.003

Note: The applicant defined the normal working voltage is from 3.20Vdc to 4.30Vdc.

Frequency Error vs. Temperature

Temp. (°C)	LTE Band 26			
	Channel Bandwidth: 1.4 MHz			
	Low Channel		High Channel	
	Frequency (MHz)	Frequency Error (ppm)	Frequency (MHz)	Frequency Error (ppm)
-30	814.700003	0.003	823.300000	0.004
-20	814.700003	0.004	823.300000	0.001
-10	814.700003	0.004	823.300000	0.002
0	814.700003	0.003	823.300000	0.002
10	814.700003	0.004	823.300000	0.002
20	814.699999	-0.001	823.300000	-0.003
30	814.699999	-0.002	823.300000	-0.003
40	814.699997	-0.004	823.300000	-0.003
50	814.699999	-0.002	823.300000	-0.004
60	814.699997	-0.003	823.300000	-0.004

Frequency Error vs. Voltage

Voltage (Volts)	LTE Band 26			
	Channel Bandwidth: 3 MHz			
	Low Channel		High Channel	
	Frequency (MHz)	Frequency Error (ppm)	Frequency (MHz)	Frequency Error (ppm)
3.20	815.500003	0.004	822.500000	0.004
3.75	815.500004	0.005	822.500000	0.005
4.30	815.500004	0.004	822.500000	0.001

Note: The applicant defined the normal working voltage is from 3.20Vdc to 4.30Vdc.

Frequency Error vs. Temperature

Temp. (°C)	LTE Band 26			
	Channel Bandwidth: 3 MHz			
	Low Channel		High Channel	
	Frequency (MHz)	Frequency Error (ppm)	Frequency (MHz)	Frequency Error (ppm)
-30	815.500004	0.004	822.500000	0.002
-20	815.500001	0.001	822.500000	0.004
-10	815.500003	0.004	822.500000	0.002
0	815.500003	0.004	822.500000	0.002
10	815.500004	0.004	822.500000	0.003
20	815.499999	-0.001	822.500000	-0.004
30	815.499999	-0.002	822.500000	-0.004
40	815.499998	-0.003	822.500000	-0.003
50	815.499997	-0.004	822.500000	-0.005
60	815.499996	-0.005	822.500000	-0.001

Frequency Error vs. Voltage

Voltage (Volts)	LTE Band 26			
	Channel Bandwidth: 5 MHz			
	Low Channel		High Channel	
	Frequency (MHz)	Frequency Error (ppm)	Frequency (MHz)	Frequency Error (ppm)
3.20	816.500004	0.004	821.500004	0.005
3.75	816.500004	0.005	821.500001	0.002
4.30	816.500001	0.002	821.500003	0.003

Note: The applicant defined the normal working voltage is from 3.20Vdc to 4.30Vdc.

Frequency Error vs. Temperature

Temp. (°C)	LTE Band 26			
	Channel Bandwidth: 5 MHz			
	Low Channel		High Channel	
	Frequency (MHz)	Frequency Error (ppm)	Frequency (MHz)	Frequency Error (ppm)
-30	816.500001	0.002	821.500002	0.002
-20	816.500002	0.002	821.500004	0.004
-10	816.500003	0.003	821.500003	0.004
0	816.500004	0.005	821.500002	0.002
10	816.500003	0.003	821.500003	0.003
20	816.499996	-0.005	821.499996	-0.004
30	816.499996	-0.005	821.499999	-0.002
40	816.499998	-0.003	821.499998	-0.003
50	816.499998	-0.002	821.499996	-0.005
60	816.499996	-0.005	821.499997	-0.003

Frequency Error vs. Voltage

Voltage (Volts)	LTE Band 26	
	Channel Bandwidth: 10 MHz	
	Frequency (MHz)	Frequency Error (ppm)
3.20	819.000002	0.003
3.75	819.000003	0.004
4.30	819.000003	0.003

Note: The applicant defined the normal working voltage is from 3.20Vdc to 4.30Vdc.

Frequency Error vs. Temperature

Temp. (°C)	LTE Band 13	
	Channel Bandwidth: 10 MHz	
	Frequency (MHz)	Frequency Error (ppm)
-30	819.000003	0.004
-20	819.000003	0.004
-10	819.000003	0.003
0	819.000001	0.001
10	819.000003	0.003
20	818.999996	-0.005
30	818.999996	-0.004
40	818.999996	-0.005
50	818.999997	-0.004
60	818.999997	-0.003

4.4 Occupied Bandwidth Measurement

4.4.1 Limits of Occupied Bandwidth Measurement

The width of a frequency band such that, below the lower and above the upper frequency limits, the mean powers emitted are each equal to a specified percentage 0.5 % of the total mean power of a given emission.

4.4.2 Test Procedure

The width of a frequency band such that, below the lower and above the upper frequency limits, the mean powers emitted are each equal to a specified percentage 0.5 % of the total mean power of a given emission.

4.4.3 Test Setup

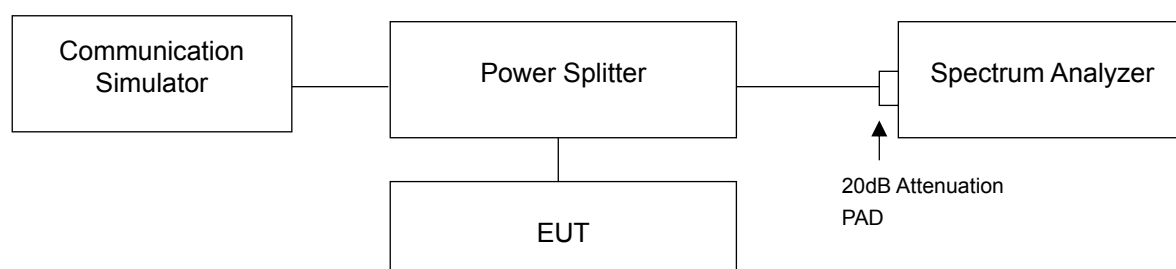

4.4.4 Test Result

Occupied Bandwidth

Channel	Frequency (MHz)	99% Occupied Bandwidth (MHz)
		CDMA
476	817.9	1.27
580	820.5	1.28
684	823.1	1.29

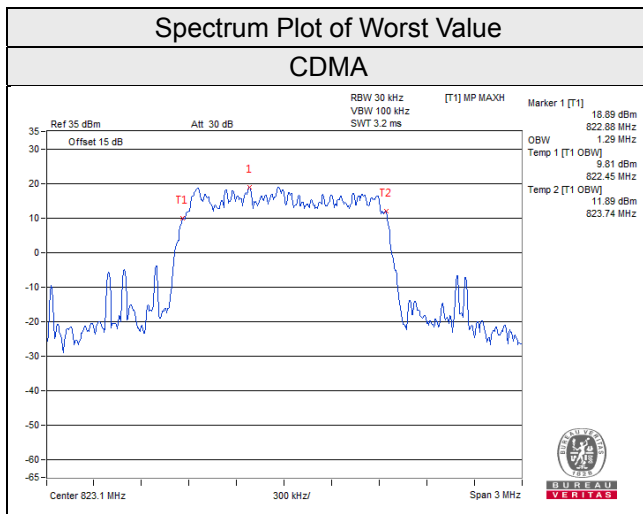

LTE Band 26, Channel Bandwidth 1.4MHz			
Channel	Frequency (MHz)	99% Occupied Bandwidth (MHz)	
		QPSK	16QAM
26697	814.7	1.08	1.09
26740	819.0	1.08	1.08
26783	823.3	1.08	1.08

LTE Band 26, Channel Bandwidth 3MHz			
Channel	Frequency (MHz)	99% Occupied Bandwidth (MHz)	
		QPSK	16QAM
26705	815.5	2.69	2.69
26740	819.0	2.69	2.69
26775	822.5	2.69	2.69

LTE Band 26, Channel Bandwidth 5MHz			
Channel	Frequency (MHz)	99% Occupied Bandwidth (MHz)	
		QPSK	16QAM
26715	816.5	4.47	4.48
26740	819.0	4.47	4.48
26765	821.5	4.48	4.48

LTE Band 26, Channel Bandwidth 10MHz			
Channel	Frequency (MHz)	99% Occupied Bandwidth (MHz)	
		QPSK	16QAM
26740	819.0	8.93	8.93

Spectrum Plot of Worst Value

1.4MHz / 16QAM



3MHz / QPSK



5MHz / 16QAM



10MHz / 16QAM



26dB Bandwidth

Channel	Frequency (MHz)	26dB Bandwidth (MHz)
		CDMA
476	817.9	1.423
580	820.5	1.424
684	823.1	1.475

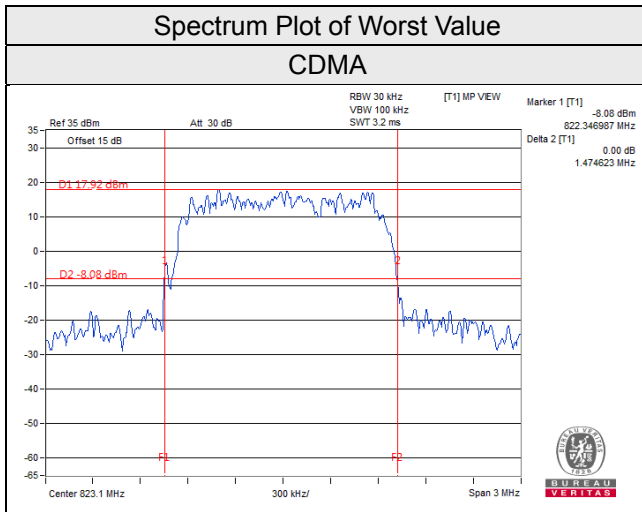

LTE Band 26, Channel Bandwidth 1.4MHz			
Channel	Frequency (MHz)	26dB Bandwidth (MHz)	
		QPSK	16QAM
26697	814.7	1.25	1.25
26740	819.0	1.25	1.25
26783	823.3	1.25	1.25

LTE Band 26, Channel Bandwidth 3MHz			
Channel	Frequency (MHz)	26dB Bandwidth (MHz)	
		QPSK	16QAM
26705	815.5	2.91	2.91
26740	819.0	2.91	2.92
26775	822.5	2.93	2.92

LTE Band 26, Channel Bandwidth 5MHz			
Channel	Frequency (MHz)	26dB Bandwidth (MHz)	
		QPSK	16QAM
26715	816.5	4.78	4.80
26740	819.0	4.79	4.81
26765	821.5	4.79	4.79

LTE Band 26, Channel Bandwidth 10MHz			
Channel	Frequency (MHz)	26dB Bandwidth (MHz)	
		QPSK	16QAM
26740	819.0	9.49	9.51

Spectrum Plot of Worst Value

1.4MHz / 16QAM



3MHz / QPSK



5MHz / 16QAM



10MHz / 16QAM



4.5 Emission Mask Measurement

4.5.1 Limits of Emission Mask Measurement

According to FCC part 90.691 shall be tested the emission mask. For any frequency removed from the EA licensee's frequency block by up to and including 37.5 kHz, the power of any emission shall be attenuated below the transmitter power (P) in watts by at least $116 \text{ Log}_{10}(f/6.1)$ decibels or $50 + 10\text{Log}_{10}(P)$ decibels or 80 decibels, whichever is the lesser attenuation, where f is the frequency removed from the center of the outer channel in the block in kilohertz and where f is greater than 12.5 kHz.

For any frequency removed from the EA licensee's frequency block greater than 37.5 kHz, the power of any emission shall be attenuated below the transmitter power (P) in watts by at least $43 + 10\text{Log}_{10}(P)$ decibels or 80 decibels, whichever is the lesser attenuation, where f is the frequency removed from the center of the outer channel in the block in kilohertz and where f is greater than 37.5 kHz.

For § 90.691(a), RBW=300 Hz for offset less than 37.5 kHz from channel edge and RBW=100 kHz for offsets greater than 37.5 kHz is allowed.

4.5.2 Test Setup

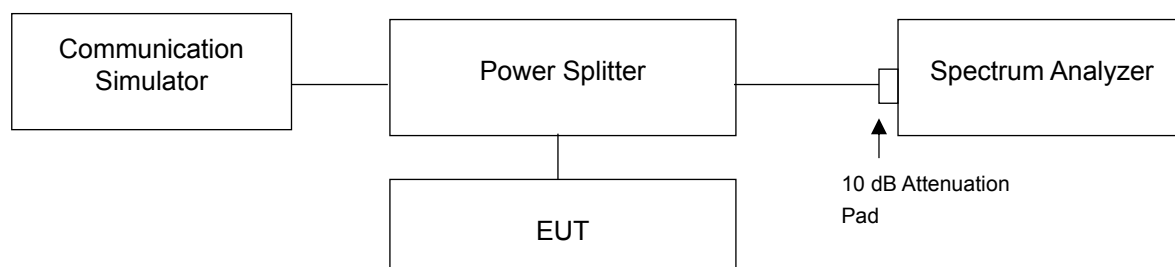

4.5.3 Test Procedures

- The measurement used the power splitter via EUT RF power connector between simulation base station and spectrum analyzer.
- Record the test plot.

4.5.4 Test Results

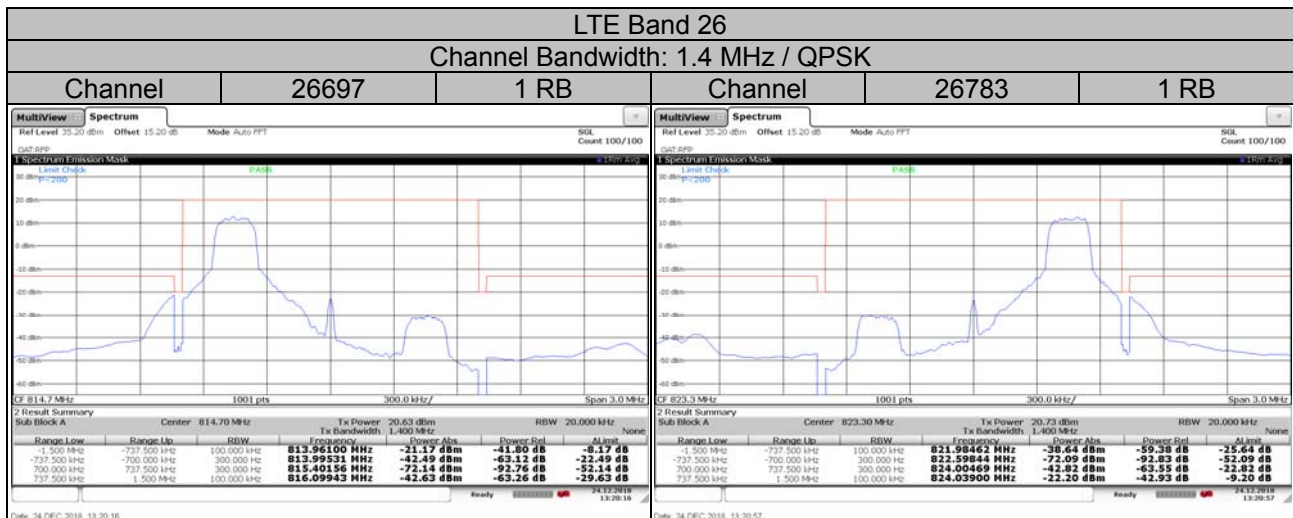
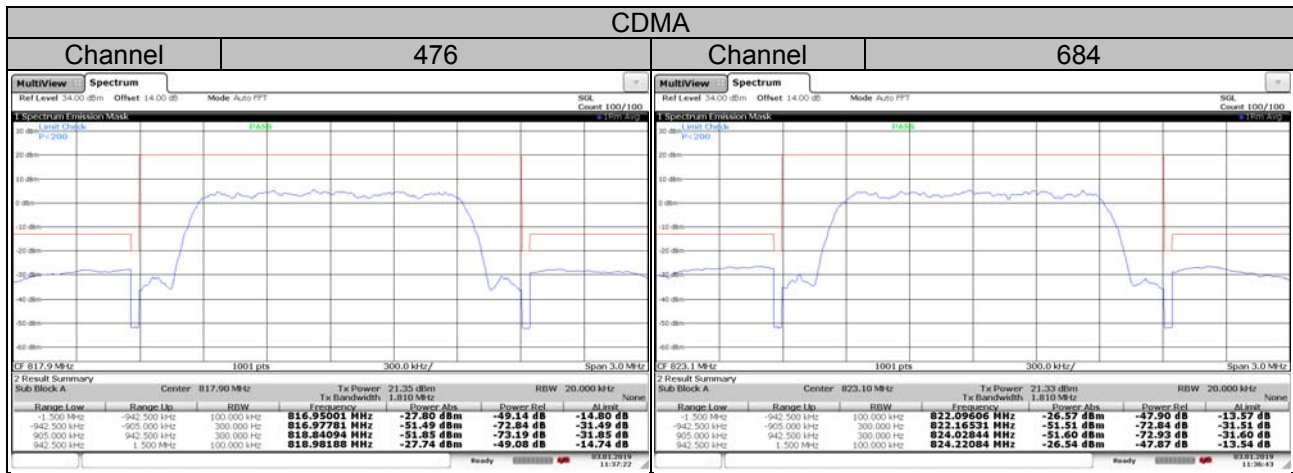

LTE Band 26
Channel Bandwidth: 1.4 MHz / 16QAM

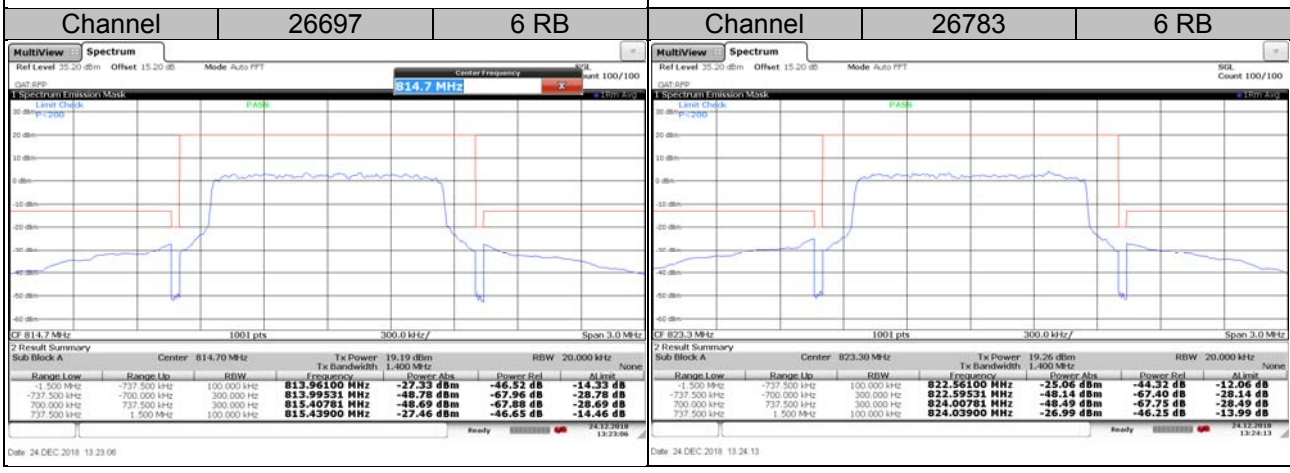
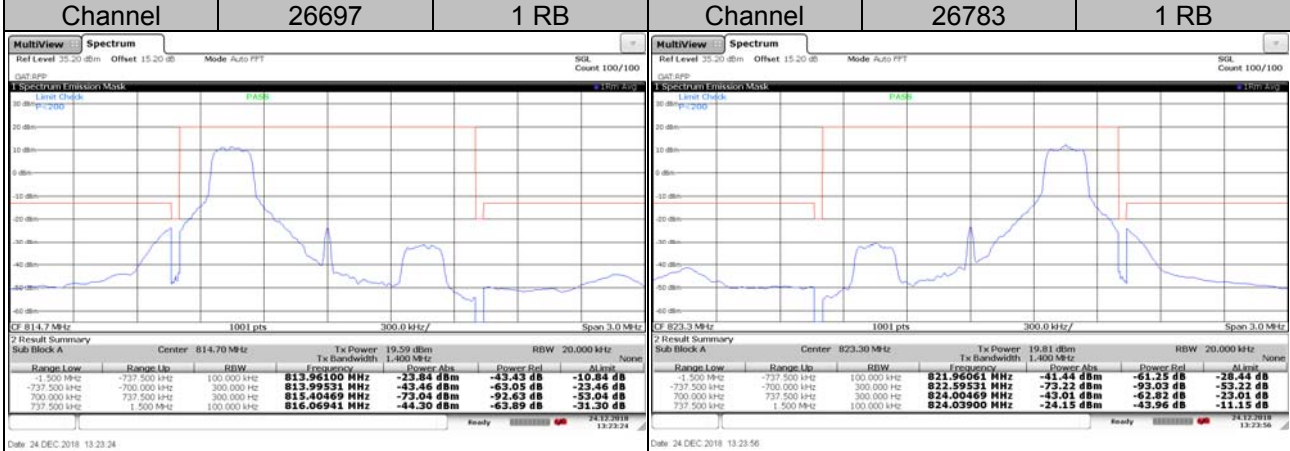

LTE Band 26
Channel Bandwidth: 3 MHz / QPSK

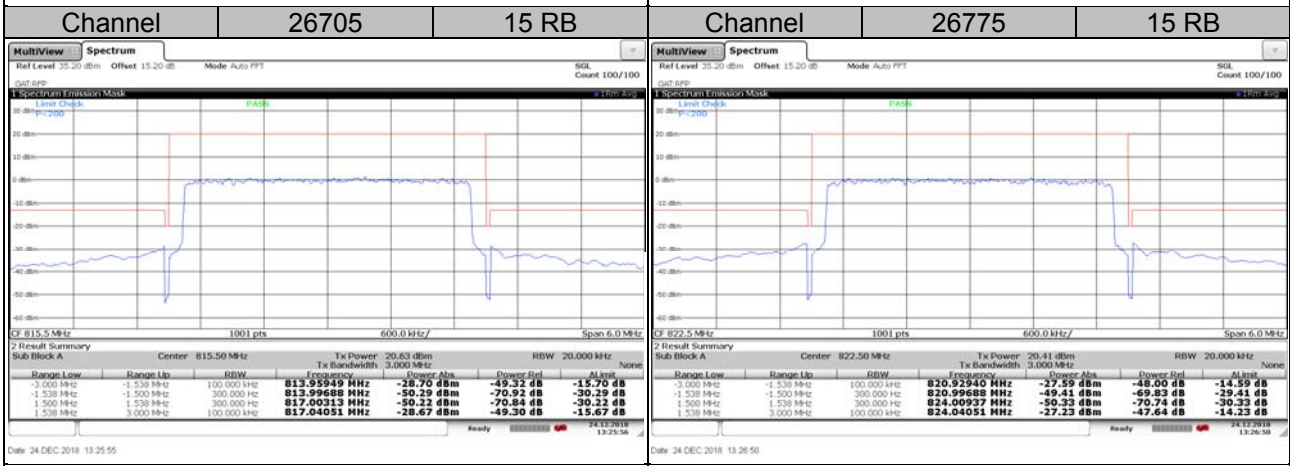
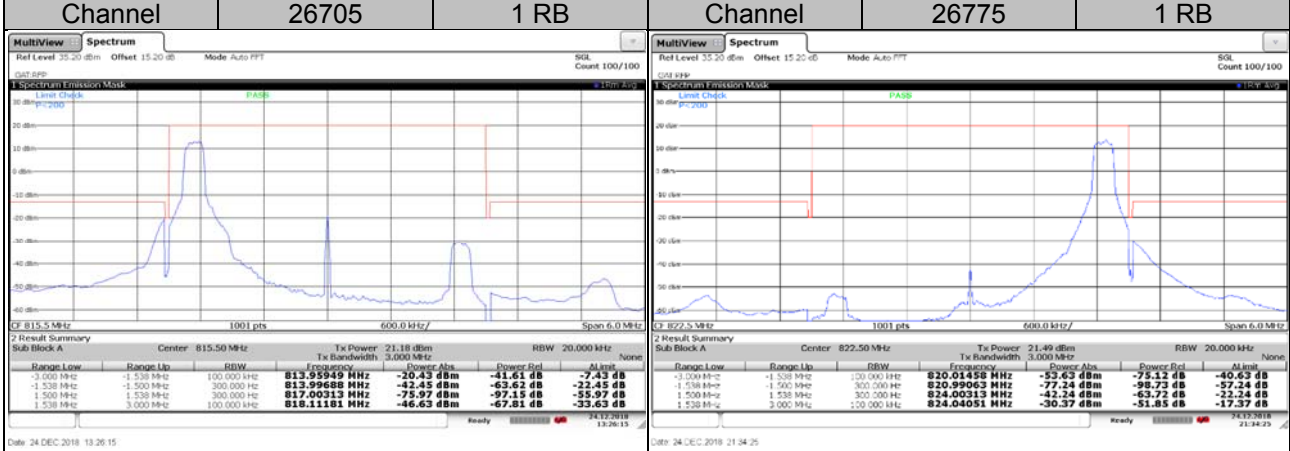

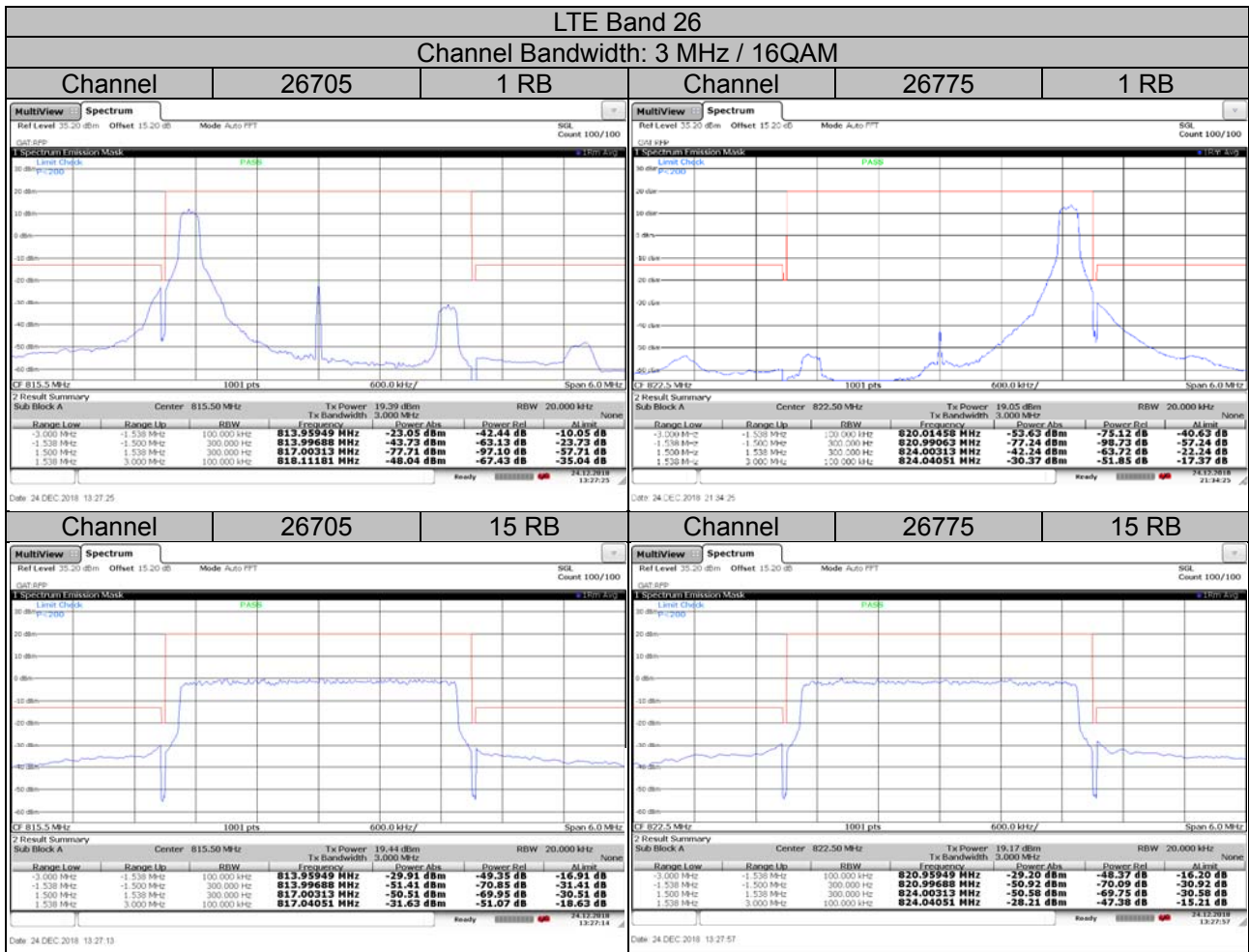

LTE Band 26

Channel Bandwidth: 5 MHz / QPSK

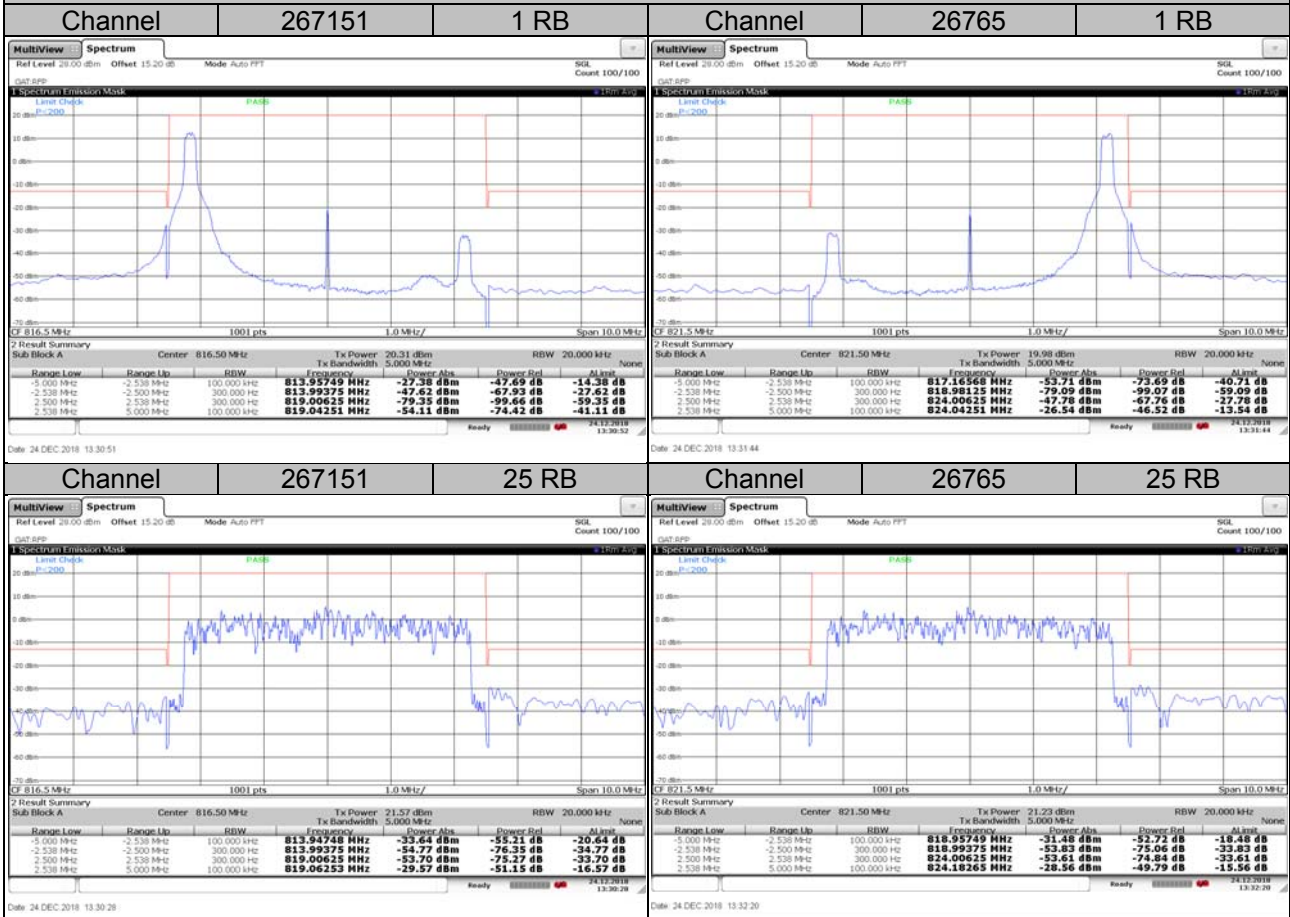

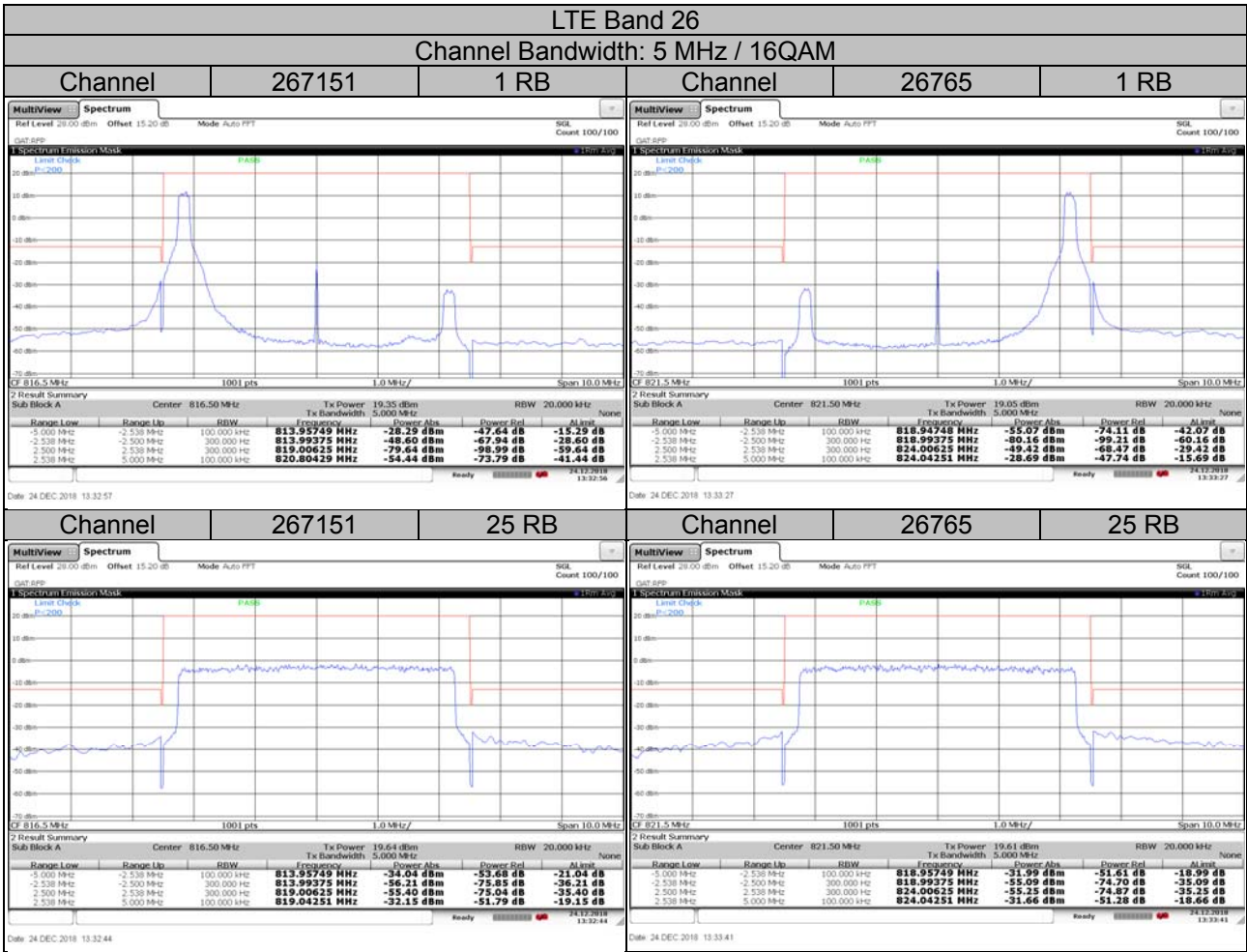

LTE Band 26

Channel Bandwidth: 10 MHz / QPSK

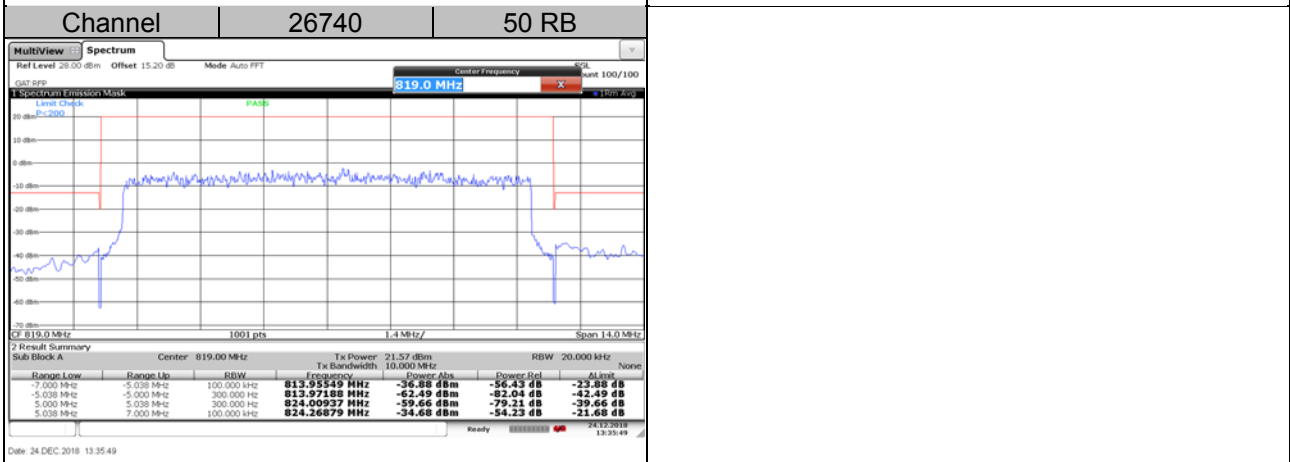
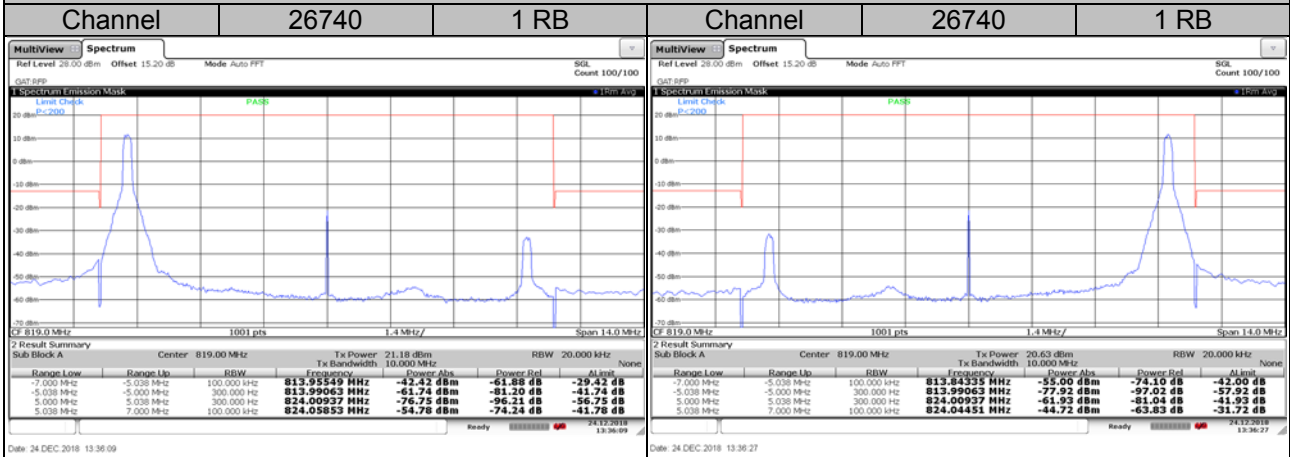

LTE Band 26
Channel Bandwidth: 10 MHz / 16QAM

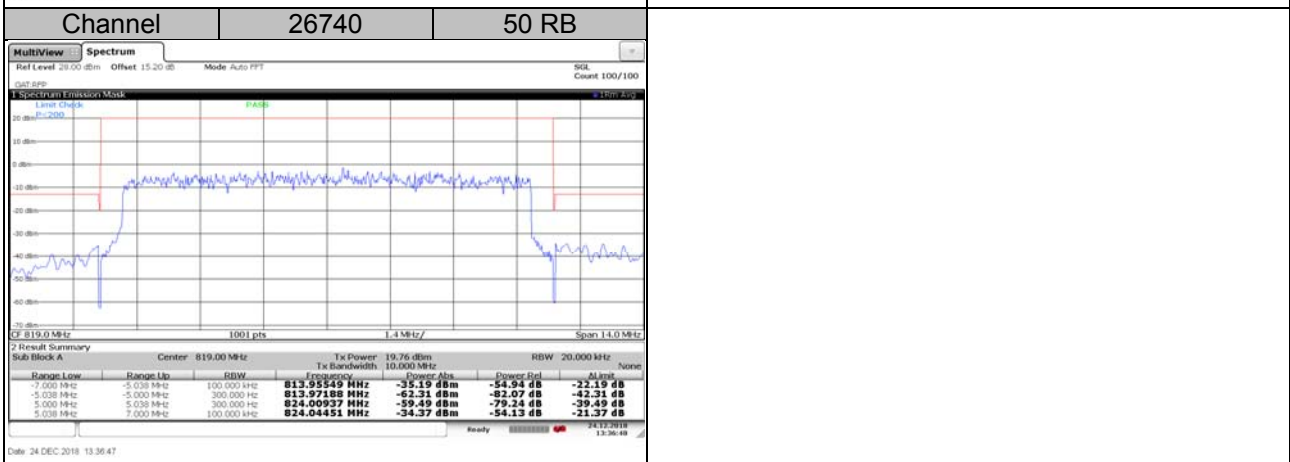
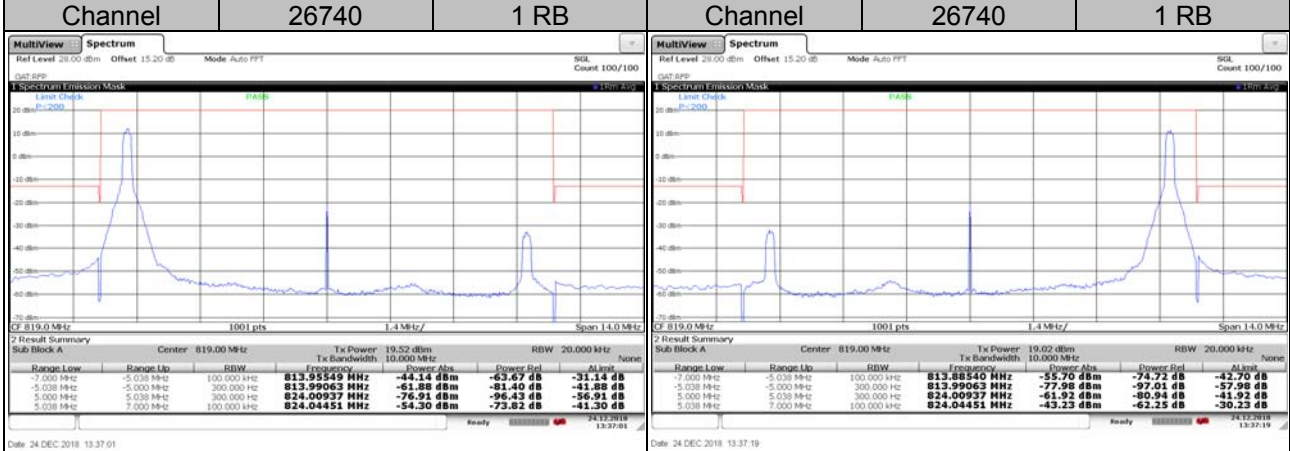

4.6 Peak to Average Ratio

4.6.1 Limits of Peak to Average Ratio Measurement

In measuring transmissions in this band using an average power technique, the peak to-average ratio (PAR) of the transmission may not exceed 13 dB

4.6.2 Test Setup

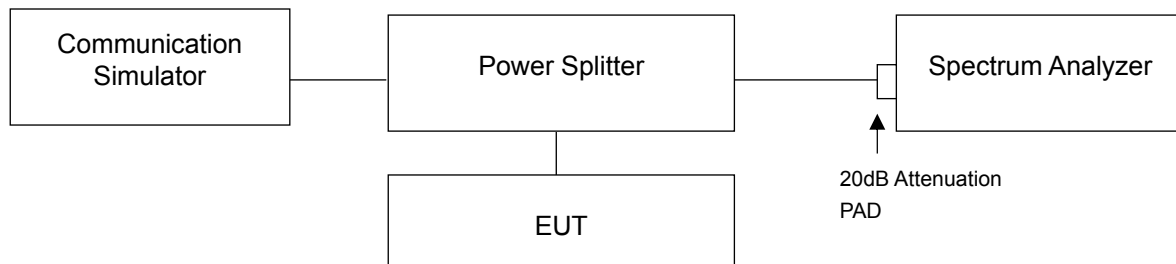

4.6.3 Test Procedures

- Set resolution/measurement bandwidth \geq signal's occupied bandwidth;
- Set the number of counts to a value that stabilizes the measured CCDF curve;
- Record the maximum PAPR level associated with a probability of 0.1%.

4.6.4 Test Results

Channel	Frequency (MHz)	Peak To Average Ratio (dB)
		CDMA
476	817.9	5.02
580	820.5	5.27
684	823.1	4.85

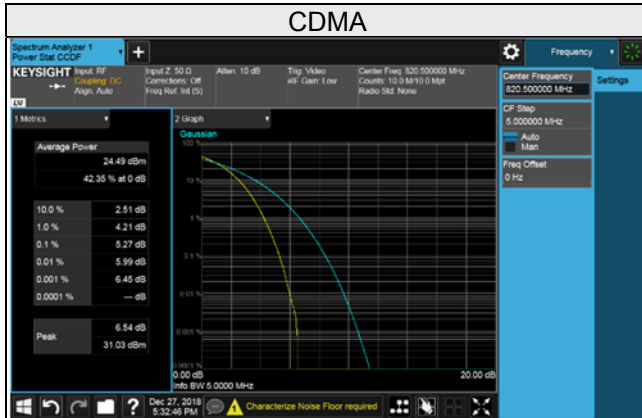

LTE Band 26, Channel Bandwidth 1.4MHz			
Channel	Frequency (MHz)	Peak To Average Ratio (dB)	
		QPSK	16QAM
26697	814.7	3.51	4.26
26740	819.0	3.49	4.24
26783	823.3	3.51	4.21

LTE Band 26, Channel Bandwidth 3MHz			
Channel	Frequency (MHz)	Peak To Average Ratio (dB)	
		QPSK	16QAM
26705	815.5	3.52	4.28
26740	819.0	3.50	4.33
26775	822.5	3.49	4.22

LTE Band 26, Channel Bandwidth 5MHz			
Channel	Frequency (MHz)	Peak To Average Ratio (dB)	
		QPSK	16QAM
26715	816.5	3.48	4.25
26740	819.0	3.49	4.20
26765	821.5	3.45	4.39

LTE Band 26, Channel Bandwidth 10MHz			
Channel	Frequency (MHz)	Peak To Average Ratio (dB)	
		QPSK	16QAM
26740	819.0	3.45	4.18

Spectrum Plot of Worst Value

1.4MHz / 16QAM

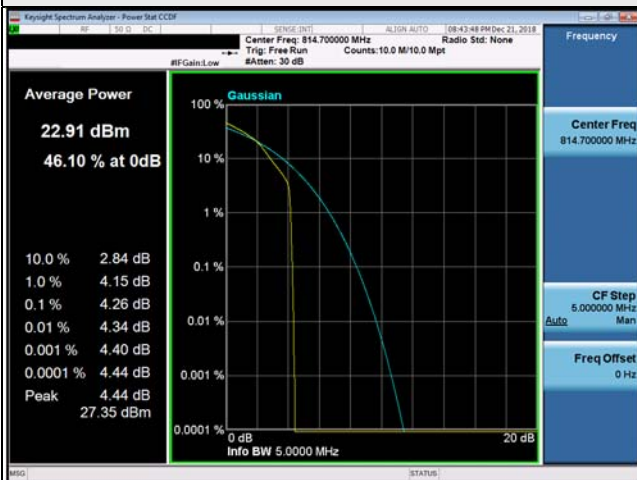

3MHz / 16QAM

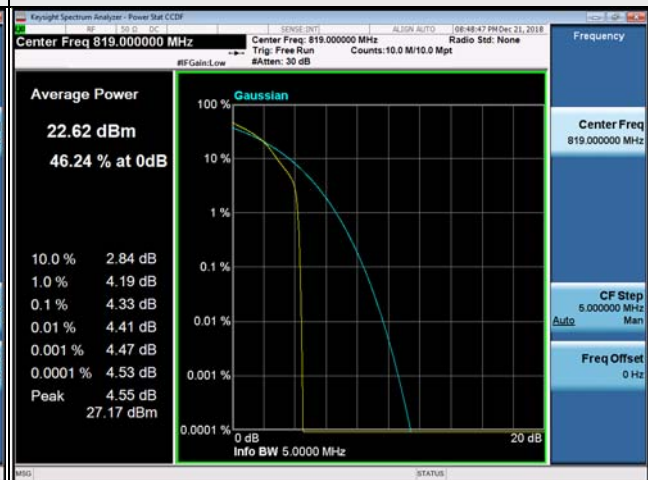

5MHz / 16QAM

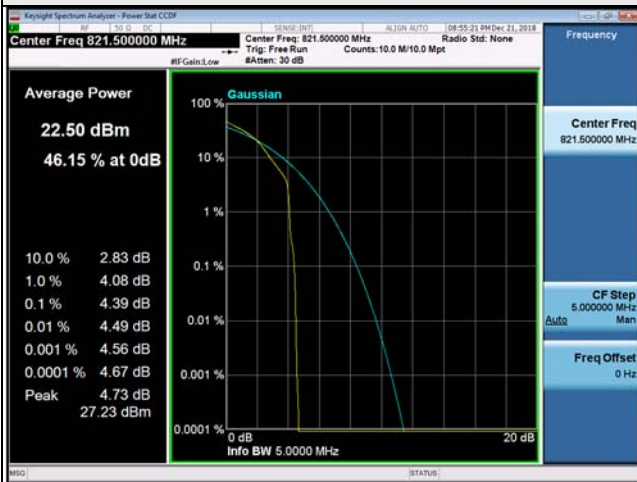

10MHz / 16QAM

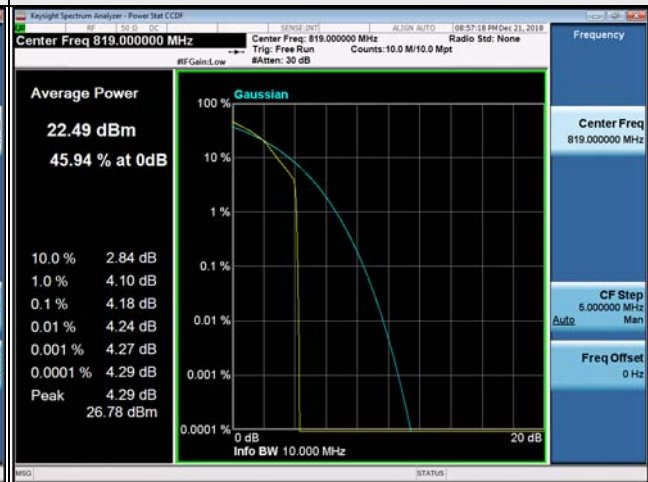

4.7 Conducted Spurious Emissions

4.7.1 Limits of Conducted Spurious Emissions Measurement

The power of any emission outside a licensee's frequency block shall be attenuated below the transmitter power (P) by at least $43 + 10 \log_{10}(P)$ dB. The limit of emission equal to -13dBm .

On all frequencies between 769 – 775 MHz and 799 – 805 MHz, by a factor not less than $65 + 10 \log(P)$ dB in a 6.25 kHz band segment, for mobile and portable stations.

4.7.2 Test Setup

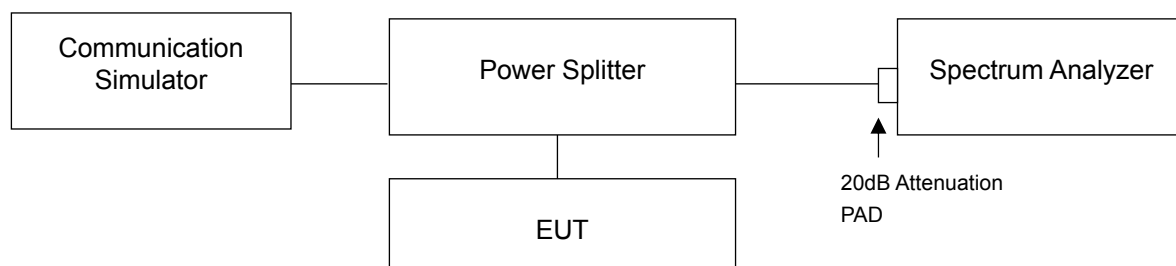

4.7.3 Test Procedure

- The EUT was set up for the maximum peak power with LTE link data modulation. The power was measured with Agilent Spectrum Analyzer.
- The conducted spurious emission used the power splitter via EUT RF power connector between signal generator and spectrum analyzer.
- When the spectrum scanned from 9 kHz to 1GHz. 10 dB attenuation pad is connected with spectrum. RBW = 100 kHz and VBW = 300 kHz for 10GHz to 27GHz and RBW = 1 MHz and VBW = 3 MHz for 1 GHz to 10 GHz are used for conducted emission measurement.

4.7.4 Test Results

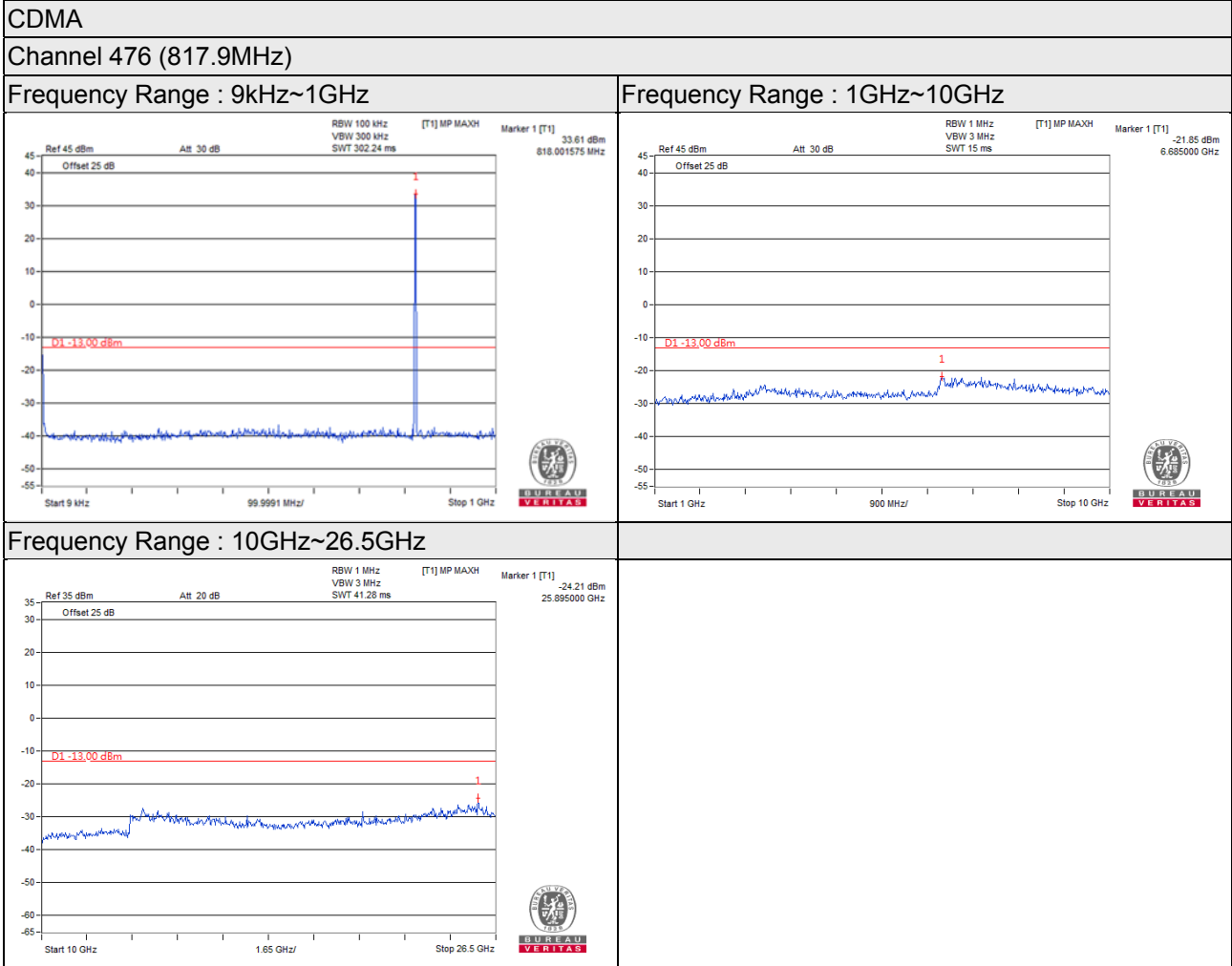

CDMA

Channel 580 (820.5MHz)

Frequency Range : 9kHz~1GHz

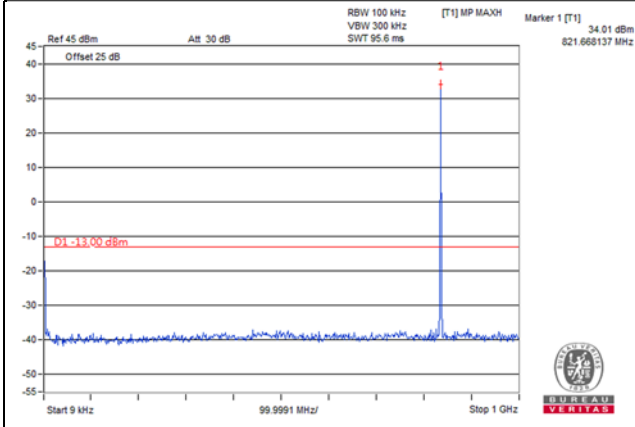

Frequency Range : 1GHz~10GHz

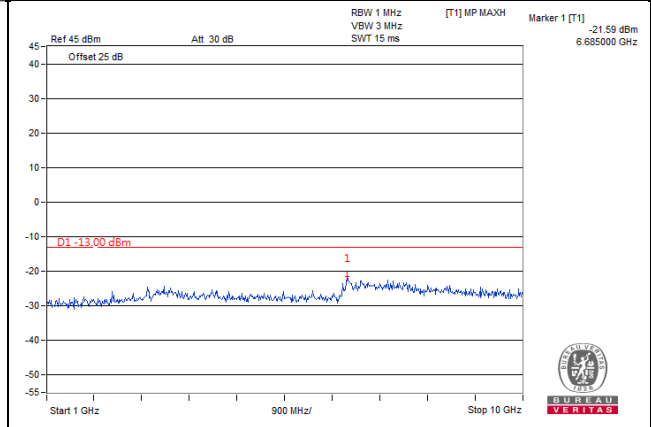

Frequency Range : 10GHz~26.5GHz

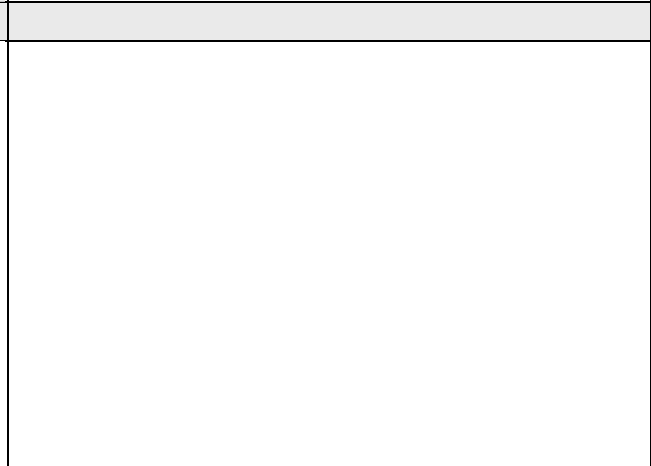
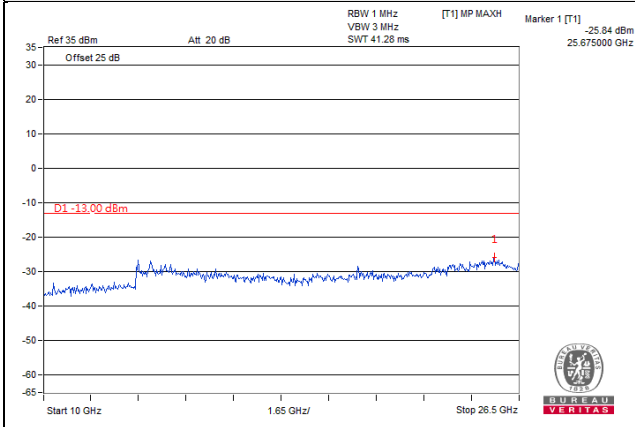

CDMA

Channel 684 (823.1MHz)

Frequency Range : 9kHz~1GHz

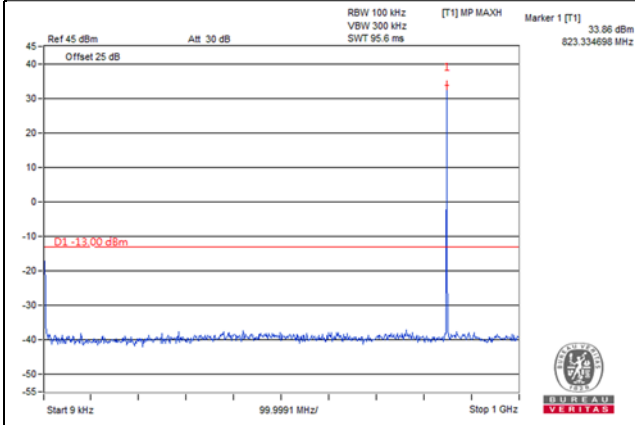

Frequency Range : 1GHz~10GHz

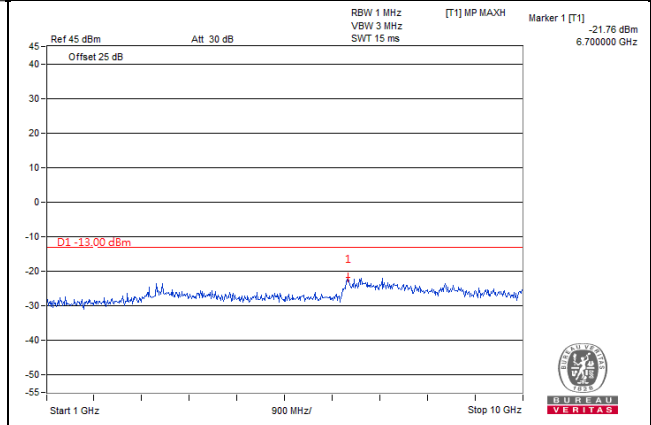

Frequency Range : 10GHz~26.5GHz

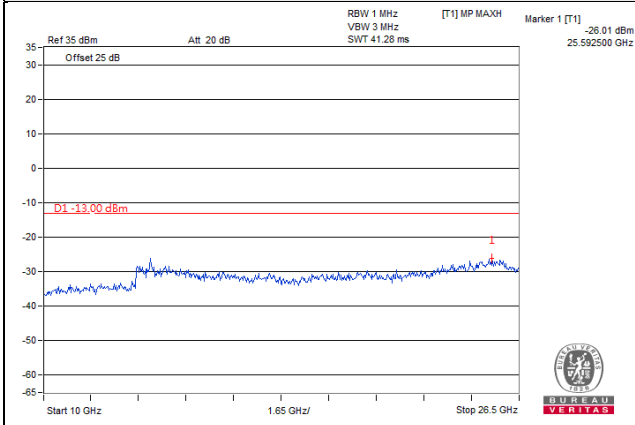

LTE Band 26, Channel Bandwidth 1.4MHz

Channel 26697 (814.7MHz)

Frequency Range : 9kHz~1GHz

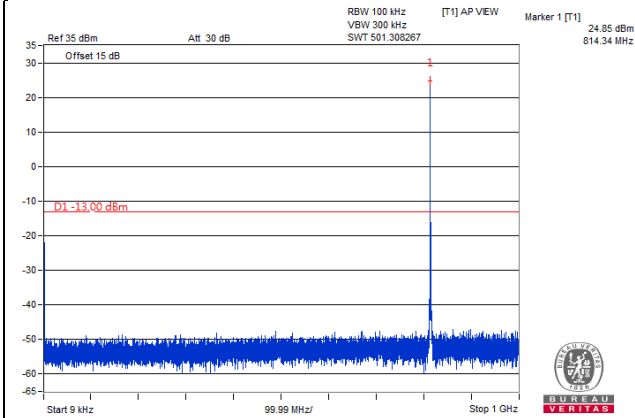

Frequency Range : 1GHz~10GHz

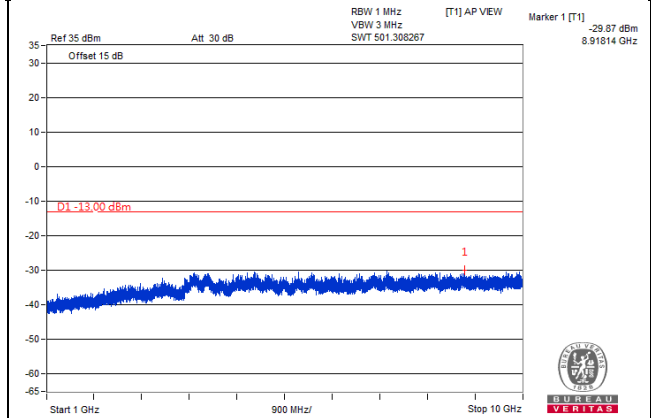

Frequency Range : 10GHz~27GHz

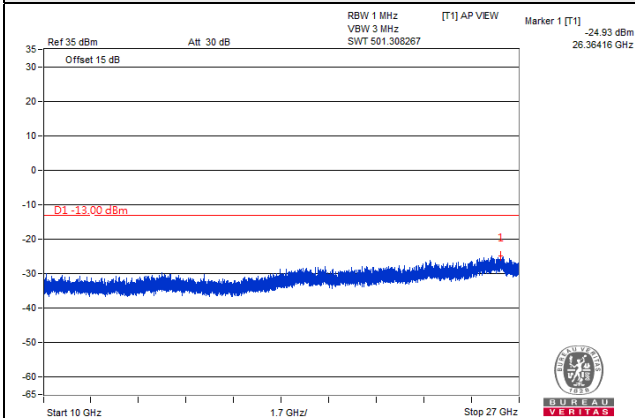

LTE Band 26, Channel Bandwidth 1.4MHz

Channel 26740 (819.0MHz)

Frequency Range : 9kHz~1GHz

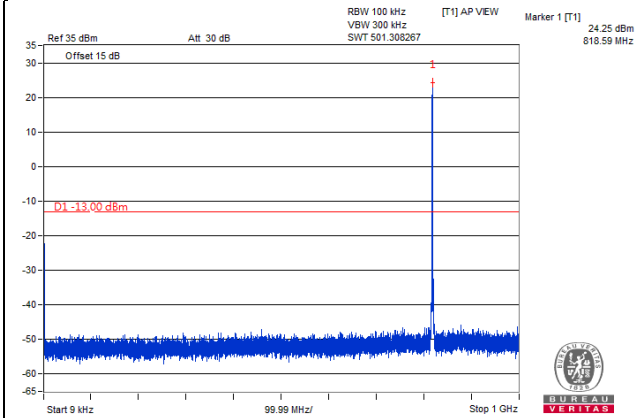

Frequency Range : 1GHz~10GHz

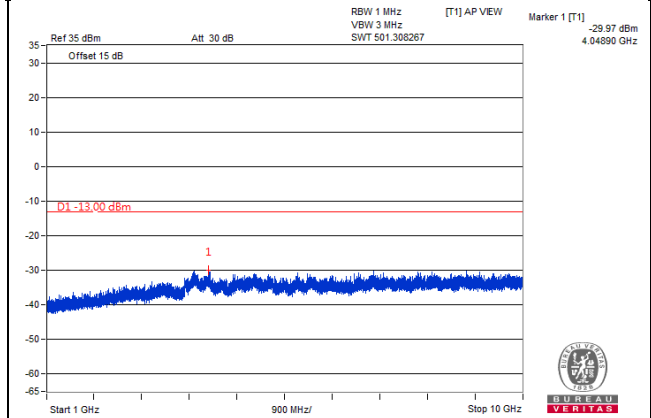

Frequency Range : 10GHz~27GHz

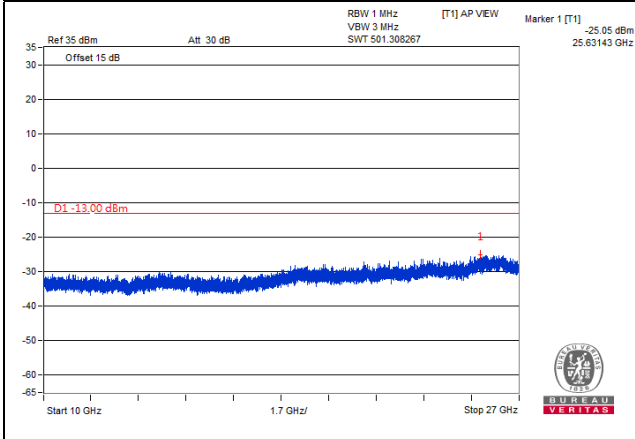

LTE Band 26, Channel Bandwidth 1.4MHz

Channel 26783 (823.3MHz)

Frequency Range : 9kHz~1GHz

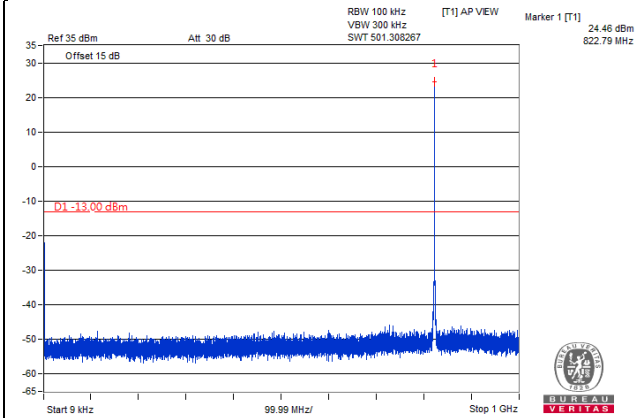

Frequency Range : 1GHz~10GHz

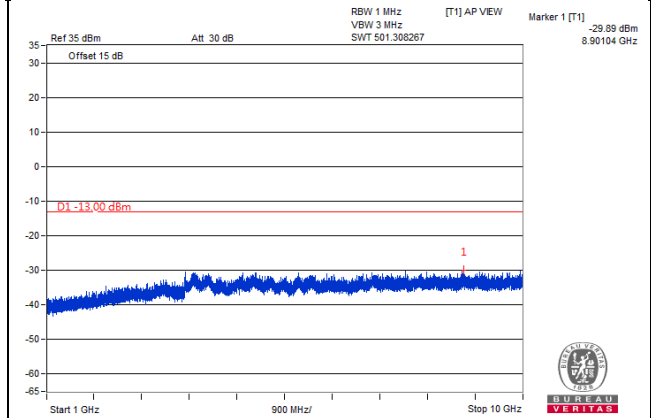

Frequency Range : 10GHz~27GHz

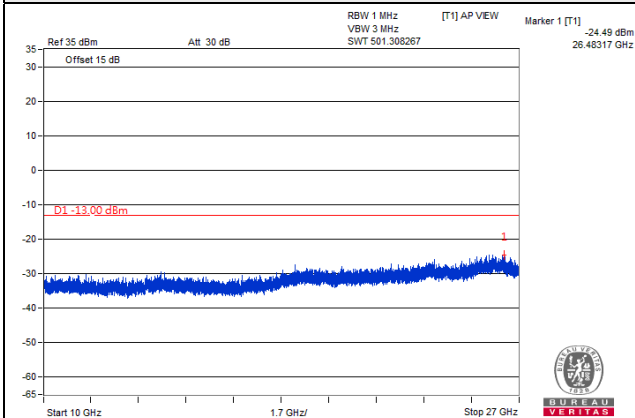

LTE Band 26, Channel Bandwidth 3MHz

Channel 26705 (815.5MHz)

Frequency Range : 9kHz~1GHz

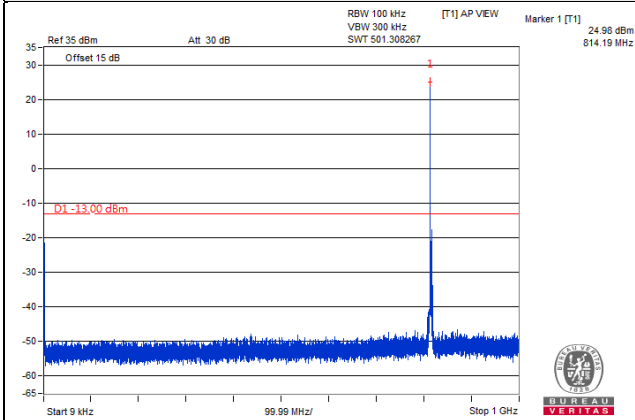

Frequency Range : 1GHz~10GHz

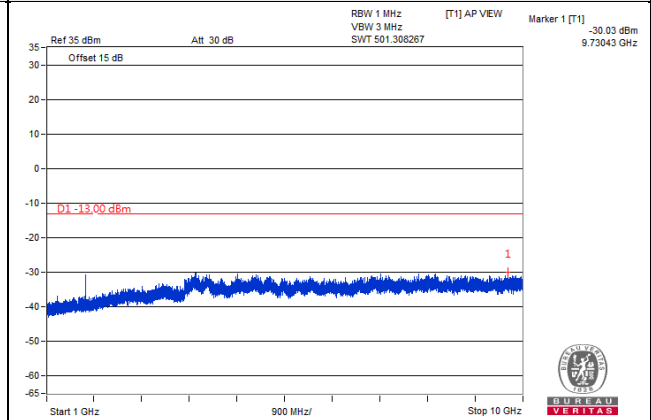

Frequency Range : 10GHz~27GHz

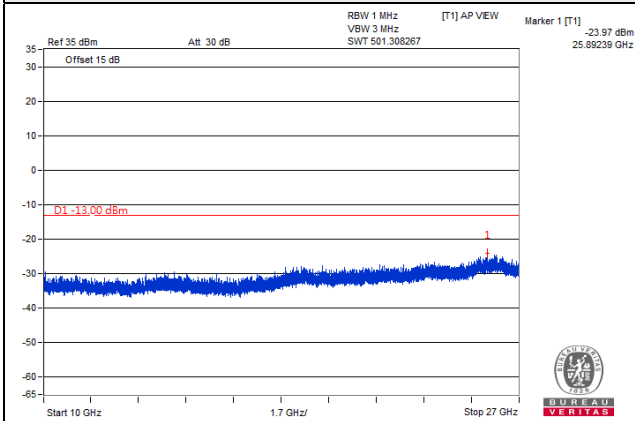

LTE Band 26, Channel Bandwidth 3MHz

Channel 26740 (819.0MHz)

Frequency Range : 9kHz~1GHz

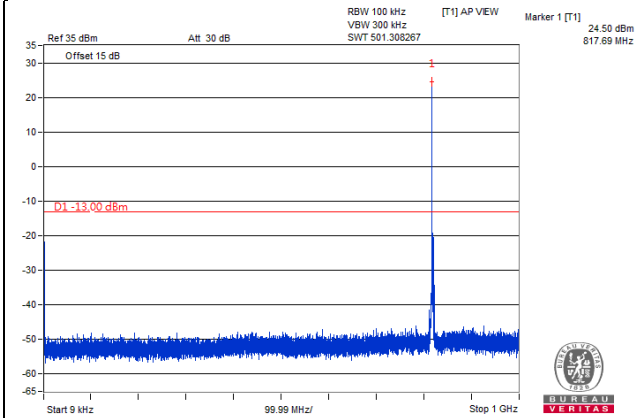

Frequency Range : 1GHz~10GHz

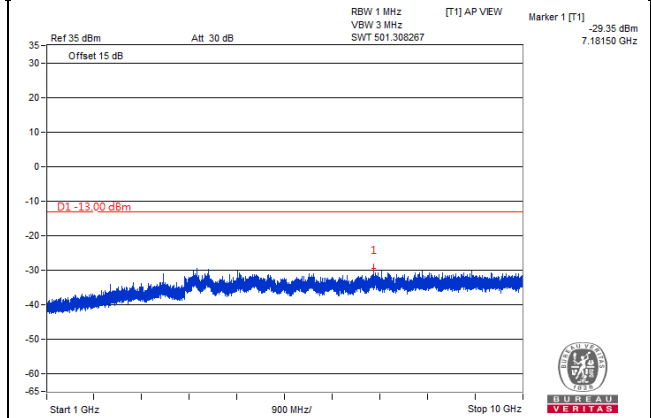

Frequency Range : 10GHz~27GHz

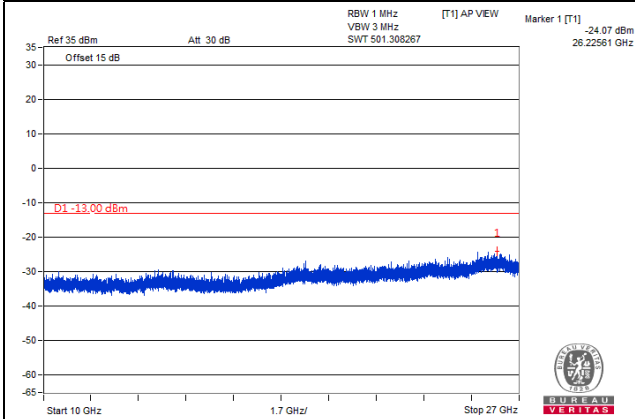

LTE Band 26, Channel Bandwidth 3MHz

Channel 26775 (822.5MHz)

Frequency Range : 9kHz~1GHz

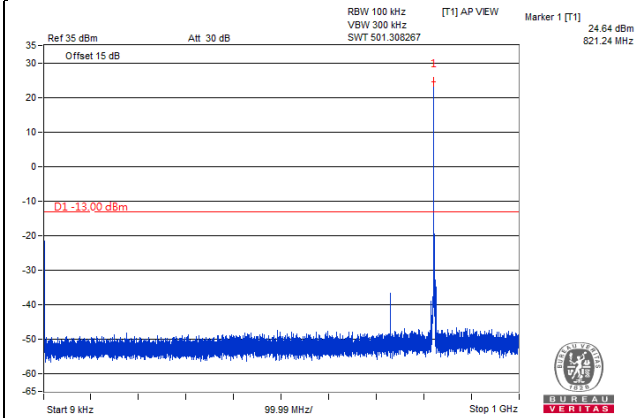

Frequency Range : 1GHz~10GHz

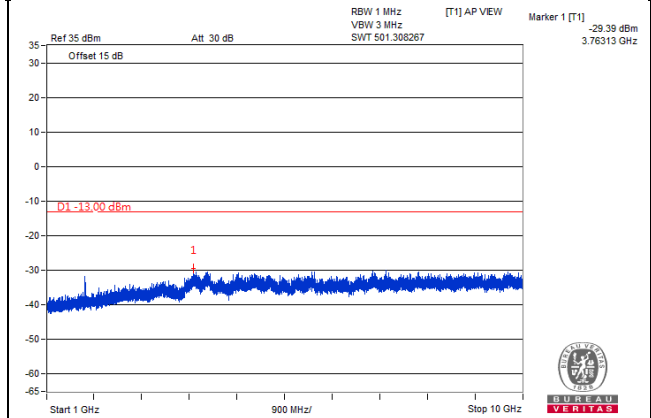

Frequency Range : 10GHz~27GHz

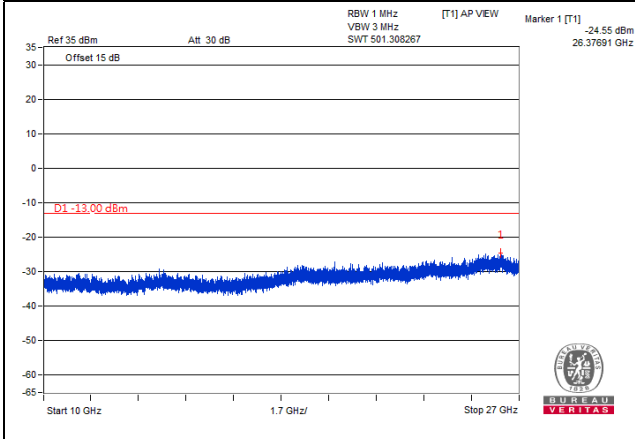

LTE Band 26, Channel Bandwidth 5MHz

Channel 26715 (816.5MHz)

Frequency Range : 9kHz~1GHz

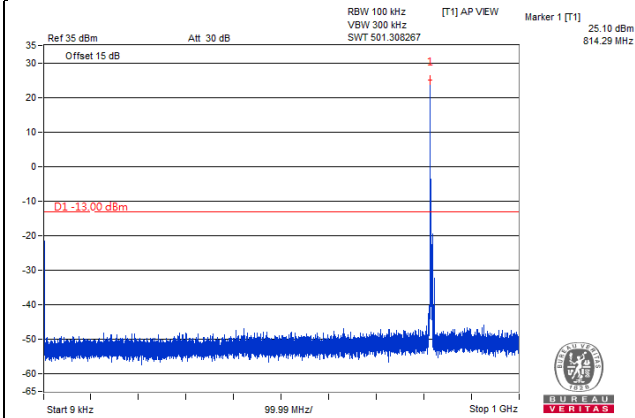

Frequency Range : 1GHz~10GHz

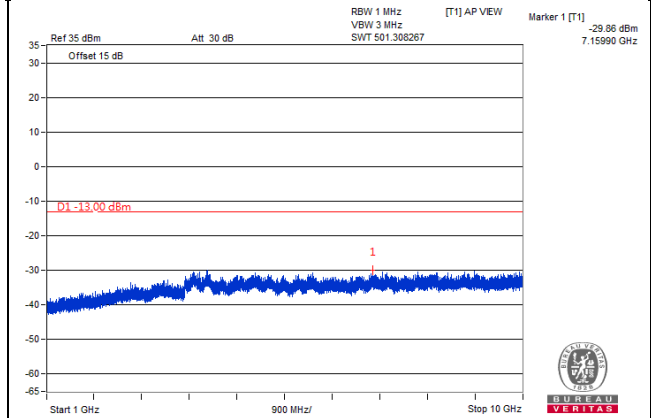

Frequency Range : 10GHz~27GHz

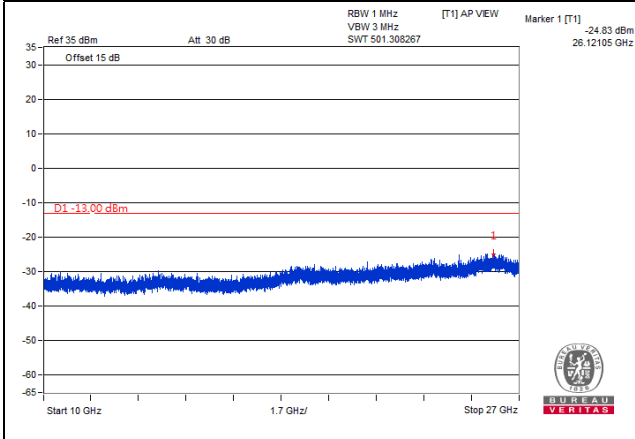

LTE Band 26, Channel Bandwidth 5MHz

Channel 26740 (819.0MHz)

Frequency Range : 9kHz~1GHz

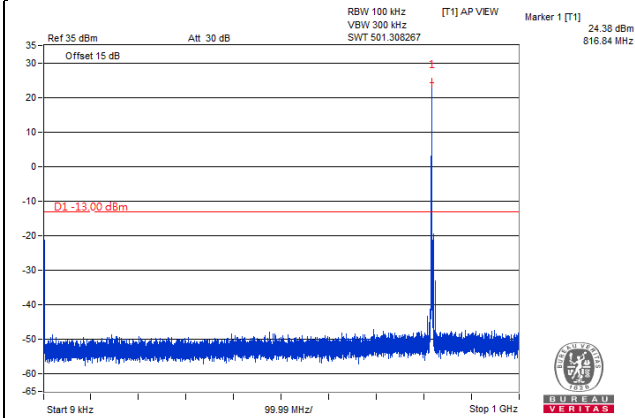

Frequency Range : 1GHz~10GHz

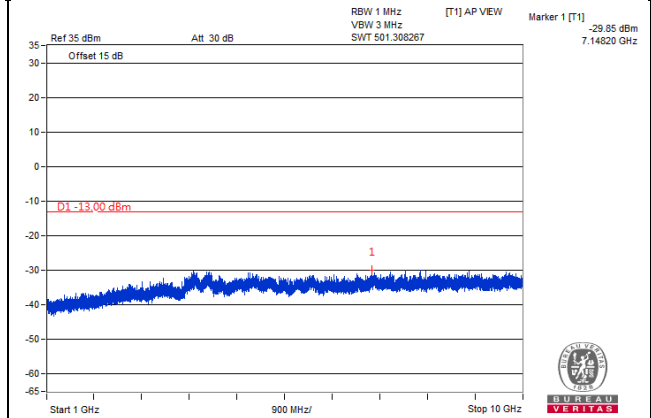

Frequency Range : 10GHz~27GHz

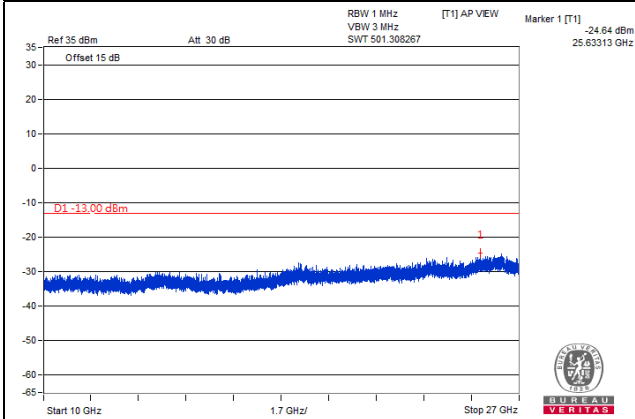

LTE Band 26, Channel Bandwidth 5MHz

Channel 26765 (821.5MHz)

Frequency Range : 9kHz~1GHz

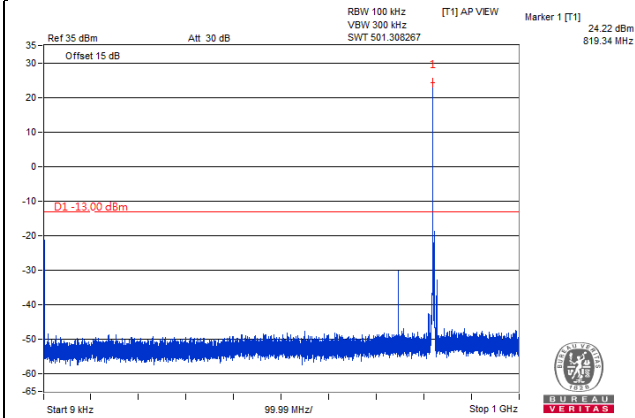

Frequency Range : 1GHz~10GHz

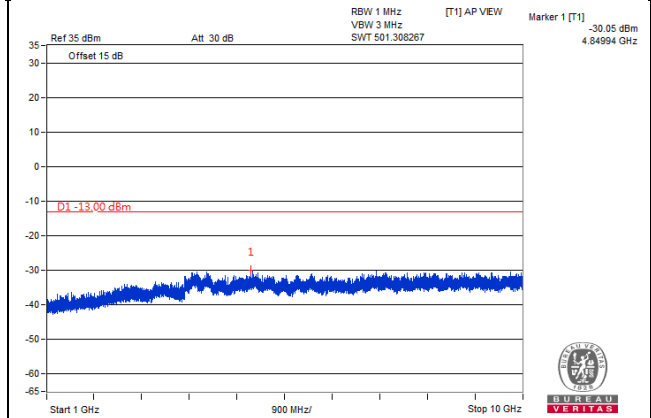

Frequency Range : 10GHz~27GHz

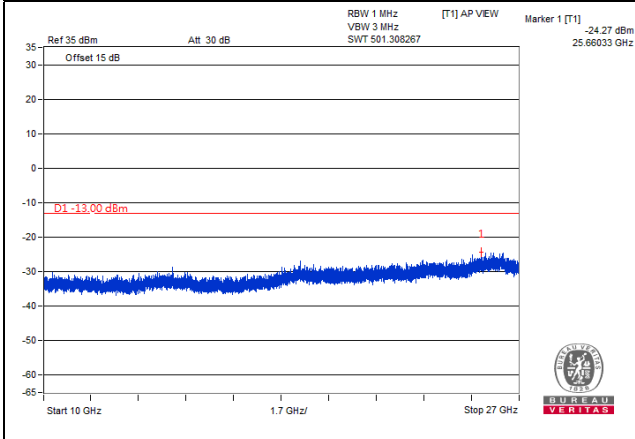

LTE Band 26, Channel Bandwidth 10MHz

Channel 26740 (819.0MHz)

Frequency Range : 9kHz~1GHz

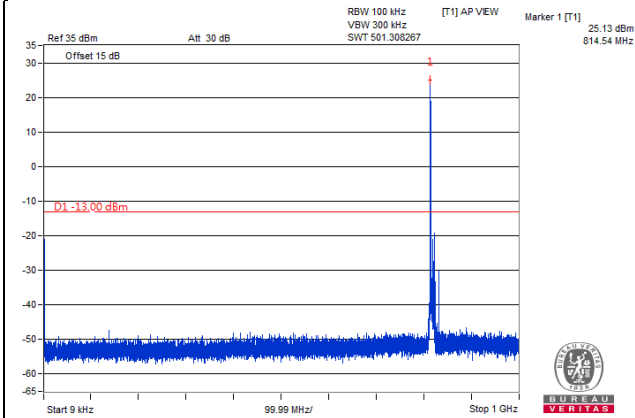

Frequency Range : 1GHz~10GHz

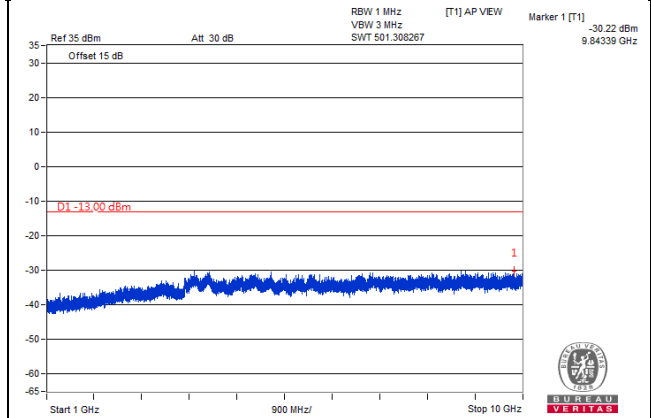

Frequency Range : 10GHz~27GHz

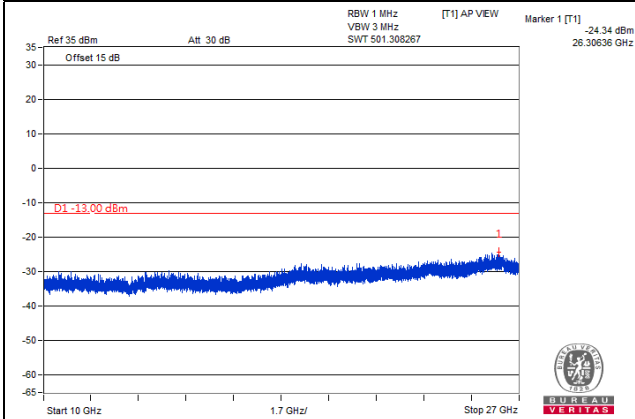

4.8 Radiated Emission Measurement

4.8.1 Limits of Radiated Emission Measurement

The power of any emission outside a licensee's frequency block shall be attenuated below the transmitter power (P) by at least $43 + 10 \log_{10}(P)$ dB. The limit of emission equal to -13dBm .

4.8.2 Test Procedure

- a. Substitution method is used for E.I.R.P measurement. In the semi-anechoic chamber, EUT placed on the 0.8m height of Turn Table, rotated the table around 360 degrees to search the maximum radiation power and receiver antenna shall be rotated vertical and horizontal polarization and moved height from 1m to 4m to find the maximum polar radiated power. The "Read Value" is the spectrum reading the maximum power value.
- b. The substitution horn antenna is substituted for EUT at the same position and signals generator export the CW signal to the substitution antenna via a TX cable. Rotated the Turn Table and moved receiving antenna to find the maximum radiation power. Adjust output power level of S.G to get a Value of spectrum reading equal to "Read Value" of step a. Record the power level of S.G
- c. $\text{EIRP} = \text{Output power level of S.G} - \text{TX cable loss} + \text{Antenna gain of substitution horn}$.
- d. E.R.P power can be calculated form E.I.R.P power by subtracting the gain of dipole, $\text{E.R.P power} = \text{E.I.R.P power} - 2.15\text{dBi}$.

NOTE: The resolution bandwidth and video bandwidth of test receiver/spectrum analyzer is 1MHz/3MHz.

4.8.3 Deviation from Test Standard

No deviation.

4.8.4 Test Setup

For radiated emission 30MHz to 1GHz

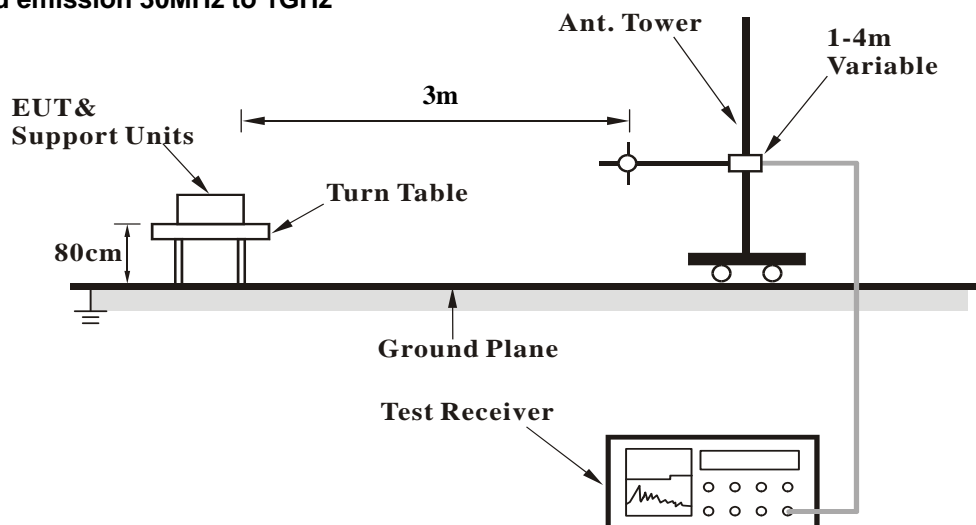

For radiated emission above 1GHz

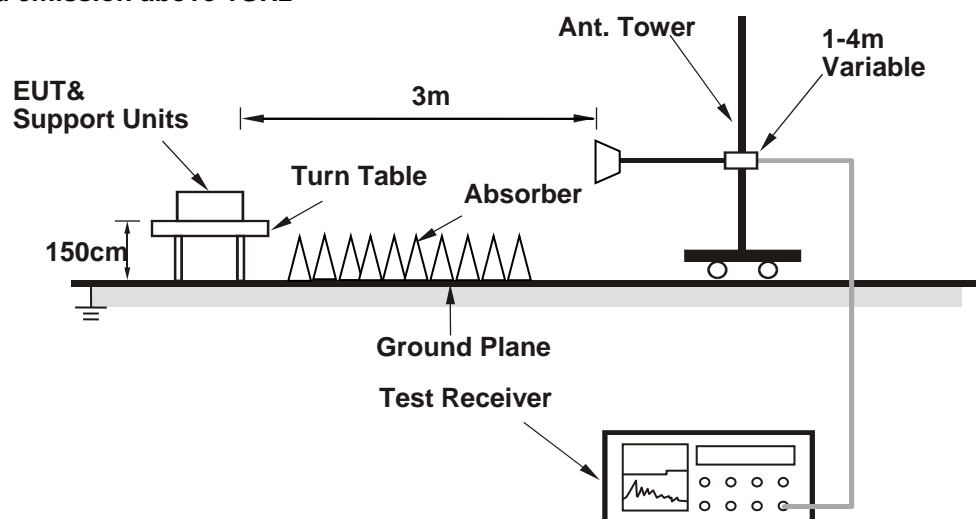

For the actual test configuration, please refer to the attached file (Test Setup Photo).

4.8.5 Test Results

Below 1GHz
CDMA

Mode	TX channel 476 (817.9MHz)	Frequency Range	Below 1000 MHz
Environmental Conditions	25deg. C, 71%RH	Input Power	120Vac, 60Hz
Tested By	Noah Chang		

Antenna Polarity & Test Distance: Horizontal at 3 M							
No.	Freq. (MHz)	Reading (dBm)	S.G Power Value (dBm)	Correction Factor (dB)	ERP (dBm)	Limit (dBm)	Margin (dB)
1	49.40	-52.8	-45.4	-9.3	-54.7	-13.0	-41.7
2	107.60	-58.9	-69.2	0.5	-68.7	-13.0	-55.7
3	202.66	-50.5	-66.7	5.4	-61.3	-13.0	-48.3
4	284.14	-53.6	-64.3	5.2	-59.1	-13.0	-46.1
5	596.48	-66.3	-72.5	4.4	-68.1	-13.0	-55.1
6	893.30	-68.5	-68.1	3.9	-64.2	-13.0	-51.2

Remarks:

- ERP (dBm) = S.G Value (dBm) + Correction Factor (dB).
- Correction Factor (dB) = Substitution Antenna Gain (dB) + Cable Loss (dB).

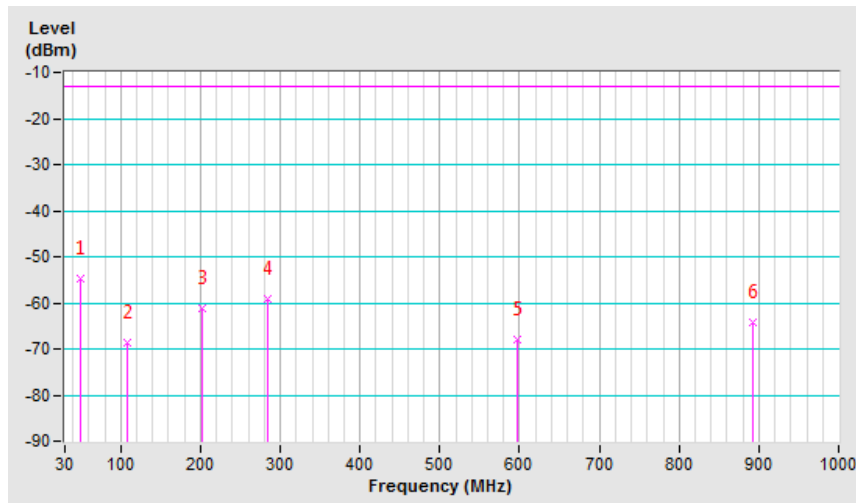

Mode	TX channel 476 (817.9MHz)	Frequency Range	Below 1000 MHz
Environmental Conditions	25deg. C, 71%RH	Input Power	120Vac, 60Hz
Tested By	Noah Chang		

Antenna Polarity & Test Distance: Vertical at 3 M							
No.	Freq. (MHz)	Reading (dBm)	S.G Power Value (dBm)	Correction Factor (dB)	ERP (dBm)	Limit (dBm)	Margin (dB)
1	47.46	-45.8	-44.2	-9.7	-53.9	-13.0	-40.9
2	175.50	-57.6	-62.6	2.3	-60.3	-13.0	-47.3
3	237.58	-56.9	-64.3	5.4	-58.9	-13.0	-45.9
4	404.42	-66.1	-74.5	5.2	-69.3	-13.0	-56.3
5	538.28	-65.5	-71.7	4.7	-67.0	-13.0	-54.0
6	903.00	-72.0	-70.9	3.9	-67.0	-13.0	-54.0

Remarks:

- ERP (dBm) = S.G Value (dBm) + Correction Factor (dB).
- Correction Factor (dB) = Substitution Antenna Gain (dB) + Cable Loss (dB).

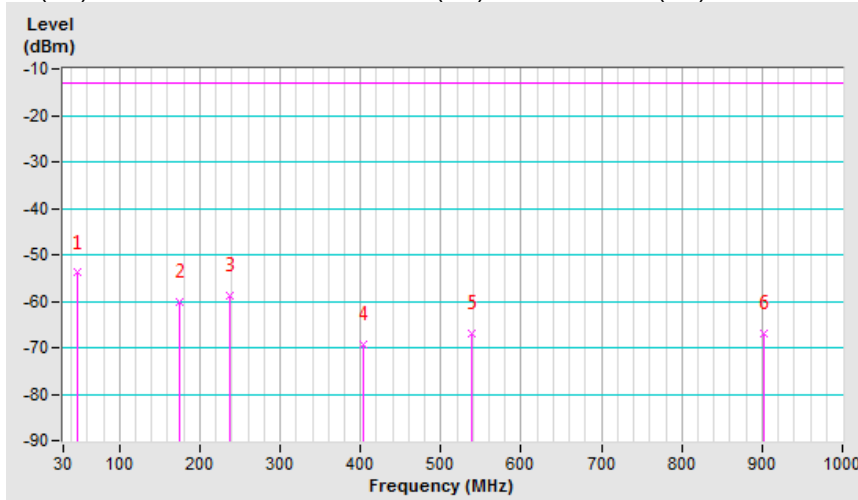

LTE Band 26, Channel Bandwidth 1.4MHz

Mode	TX channel 26697 (814.7MHz)	Frequency Range	Below 1000 MHz
Environmental Conditions	25deg. C, 71%RH	Input Power	120Vac, 60Hz
Tested By	Noah Chang		

Antenna Polarity & Test Distance: Horizontal at 3 M							
No.	Freq. (MHz)	Reading (dBm)	S.G Power Value (dBm)	Correction Factor (dB)	ERP (dBm)	Limit (dBm)	Margin (dB)
1	30.00	-58.2	-44.8	-12.2	-57.0	-13.0	-44.0
2	297.72	-63.6	-74.3	5.1	-69.2	-13.0	-56.2
3	608.12	-69.5	-75.5	4.5	-71.0	-13.0	-58.0
4	885.54	-70.7	-70.3	3.9	-66.4	-13.0	-53.4
5	988.36	-71.8	-70.4	3.9	-66.5	-13.0	-53.5
6	957.32	-70.0	-67.4	3.8	-63.6	-25.0	-38.6

Remarks:

1. ERP (dBm) = S.G Value (dBm) + Correction Factor (dB).
2. Correction Factor (dB) = Substitution Antenna Gain (dB) + Cable Loss (dB).

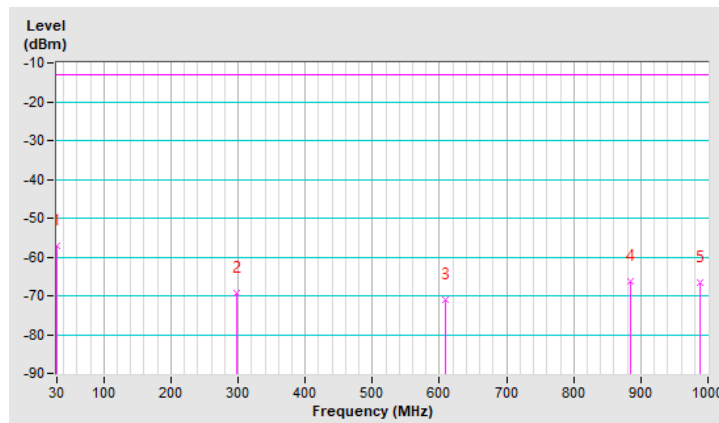

Mode	TX channel 26697 (814.7MHz)	Frequency Range	Below 1000 MHz
Environmental Conditions	25deg. C, 71%RH	Input Power	120Vac, 60Hz
Tested By	Noah Chang		

Antenna Polarity & Test Distance: Vertical at 3 M							
No.	Freq. (MHz)	Reading (dBm)	S.G Power Value (dBm)	Correction Factor (dB)	ERP (dBm)	Limit (dBm)	Margin (dB)
1	66.86	-53.0	-55.8	-5.8	-61.6	-13.0	-48.6
2	258.92	-61.6	-67.9	5.3	-62.6	-13.0	-49.6
3	392.78	-65.8	-73.9	5.2	-68.7	-13.0	-55.7
4	464.56	-63.3	-71.6	5.0	-66.6	-13.0	-53.6
5	796.30	-69.8	-69.7	4.1	-65.6	-13.0	-52.6
6	959.26	-71.1	-68.0	3.9	-64.1	-13.0	-51.1

Remarks:

1. ERP (dBm) = S.G Value (dBm) + Correction Factor (dB).
2. Correction Factor (dB) = Substitution Antenna Gain (dB) + Cable Loss (dB).

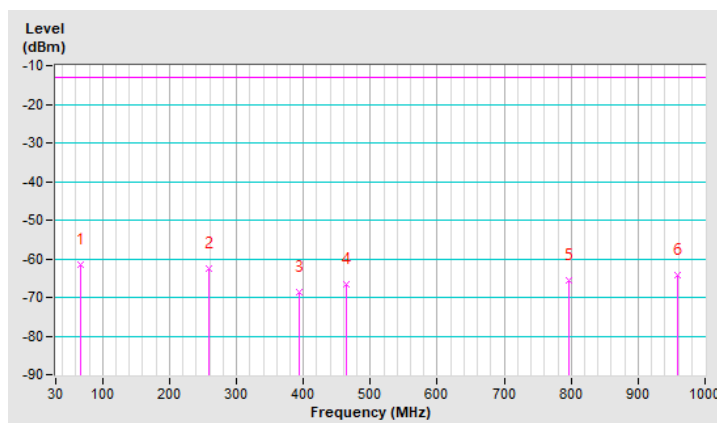

LTE Band 26, Channel Bandwidth 3MHz

Mode	TX channel 26705 (815.5MHz)	Frequency Range	Below 1000 MHz
Environmental Conditions	25deg. C, 71%RH	Input Power	120Vac, 60Hz
Tested By	Noah Chang		

Antenna Polarity & Test Distance: Horizontal at 3 M							
No.	Freq. (MHz)	Reading (dBm)	S.G Power Value (dBm)	Correction Factor (dB)	ERP (dBm)	Limit (dBm)	Margin (dB)
1	68.80	-59.8	-62.7	-5.3	-68.0	-13.0	-55.0
2	216.24	-56.9	-72.7	5.4	-67.3	-13.0	-54.3
3	297.72	-62.3	-73.0	5.1	-67.9	-13.0	-54.9
4	390.84	-66.5	-74.9	5.2	-69.7	-13.0	-56.7
5	534.40	-65.0	-72.7	4.7	-68.0	-13.0	-55.0
6	796.30	-70.2	-71.0	4.1	-66.9	-13.0	-53.9

Remarks:

1. ERP (dBm) = S.G Value (dBm) + Correction Factor (dB).
2. Correction Factor (dB) = Substitution Antenna Gain (dB) + Cable Loss (dB).

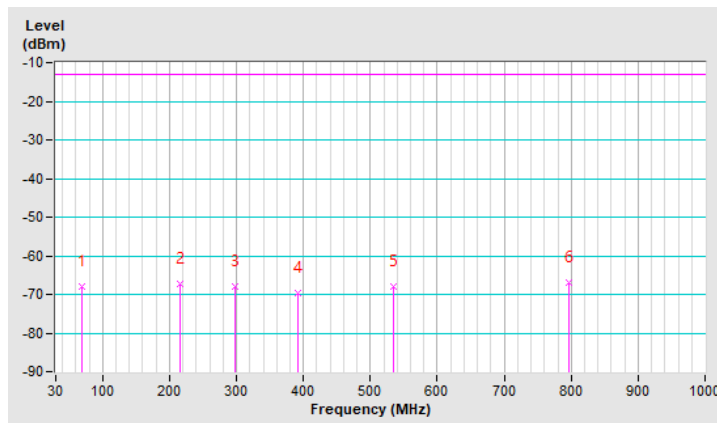

Mode	TX channel 26705 (815.5MHz)	Frequency Range	Below 1000 MHz
Environmental Conditions	25deg. C, 71%RH	Input Power	120Vac, 60Hz
Tested By	Noah Chang		

Antenna Polarity & Test Distance: Vertical at 3 M							
No.	Freq. (MHz)	Reading (dBm)	S.G Power Value (dBm)	Correction Factor (dB)	ERP (dBm)	Limit (dBm)	Margin (dB)
1	115.36	-57.9	-67.0	0.3	-66.7	-13.0	-53.7
2	276.38	-63.4	-68.5	5.3	-63.2	-13.0	-50.2
3	542.16	-63.4	-69.3	4.7	-64.6	-13.0	-51.6
4	736.16	-70.2	-71.7	4.8	-66.9	-13.0	-53.9
5	813.76	-69.2	-69.0	4.0	-65.0	-13.0	-52.0
6	988.36	-71.8	-67.7	3.9	-63.8	-13.0	-50.8

Remarks:

1. ERP (dBm) = S.G Value (dBm) + Correction Factor (dB).
2. Correction Factor (dB) = Substitution Antenna Gain (dB) + Cable Loss (dB).

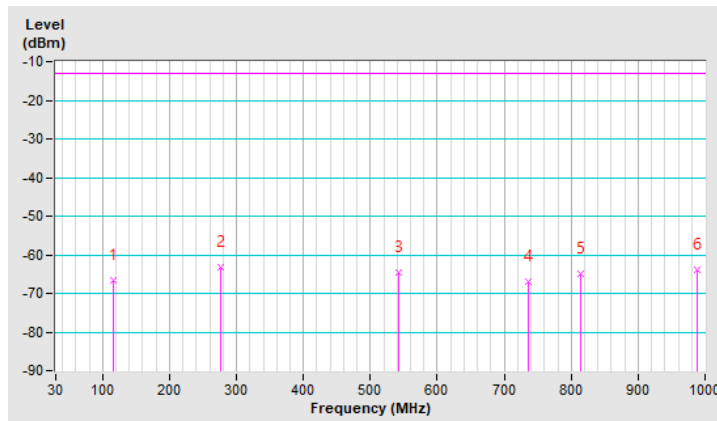

LTE Band 26, Channel Bandwidth 5MHz

Mode	TX channel 26715 (816.5MHz)	Frequency Range	Below 1000 MHz
Environmental Conditions	25deg. C, 71%RH	Input Power	120Vac, 60Hz
Tested By	Noah Chang		

Antenna Polarity & Test Distance: Horizontal at 3 M							
No.	Freq. (MHz)	Reading (dBm)	S.G Power Value (dBm)	Correction Factor (dB)	ERP (dBm)	Limit (dBm)	Margin (dB)
1	66.86	-55.9	-58.2	-5.8	-64.0	-13.0	-51.0
2	173.56	-54.8	-66.4	2.1	-64.3	-13.0	-51.3
3	251.16	-56.9	-70.6	5.4	-65.2	-13.0	-52.2
4	497.54	-64.5	-72.8	4.9	-67.9	-13.0	-54.9
5	720.64	-69.2	-73.8	5.0	-68.8	-13.0	-55.8
6	994.18	-70.2	-68.8	4.0	-64.8	-13.0	-51.8

Remarks:

- ERP (dBm) = S.G Value (dBm) + Correction Factor (dB).
- Correction Factor (dB) = Substitution Antenna Gain (dB) + Cable Loss (dB).

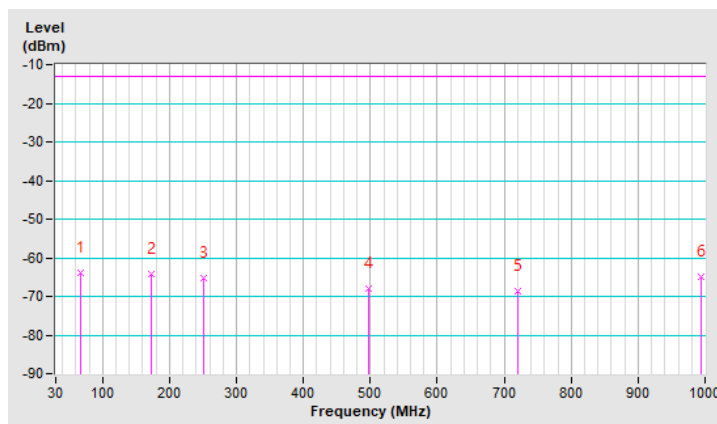

Mode	TX channel 26715 (816.5MHz)	Frequency Range	Below 1000 MHz
Environmental Conditions	25deg. C, 71%RH	Input Power	120Vac, 60Hz
Tested By	Noah Chang		

Antenna Polarity & Test Distance: Vertical at 3 M							
No.	Freq. (MHz)	Reading (dBm)	S.G Power Value (dBm)	Correction Factor (dB)	ERP (dBm)	Limit (dBm)	Margin (dB)
1	30.00	-47.0	-47.4	-12.2	-59.6	-13.0	-46.6
2	270.56	-63.4	-67.7	5.3	-62.4	-13.0	-49.4
3	466.50	-63.3	-71.4	5.0	-66.4	-13.0	-53.4
4	555.74	-63.2	-68.9	4.7	-64.2	-13.0	-51.2
5	604.24	-67.7	-70.5	4.5	-66.0	-13.0	-53.0
6	978.66	-70.9	-67.1	3.9	-63.2	-13.0	-50.2

Remarks:

1. ERP (dBm) = S.G Value (dBm) + Correction Factor (dB).
2. Correction Factor (dB) = Substitution Antenna Gain (dB) + Cable Loss (dB).

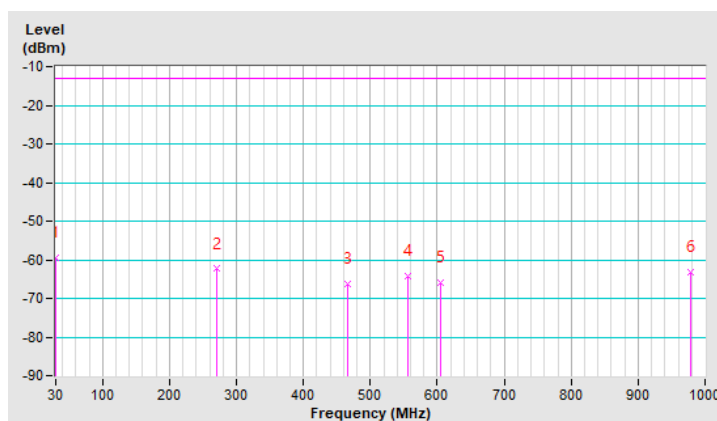

LTE Band 26, Channel Bandwidth 10MHz

Mode	TX channel 26740 (819.0MHz)	Frequency Range	Below 1000 MHz
Environmental Conditions	25deg. C, 71%RH	Input Power	120Vac, 60Hz
Tested By	Noah Chang		

Antenna Polarity & Test Distance: Horizontal at 3 M							
No.	Freq. (MHz)	Reading (dBm)	S.G Power Value (dBm)	Correction Factor (dB)	ERP (dBm)	Limit (dBm)	Margin (dB)
1	55.22	-58.3	-51.8	-8.7	-60.5	-13.0	-47.5
2	289.96	-61.9	-70.3	5.2	-65.1	-13.0	-52.1
3	437.40	-67.5	-73.8	5.2	-68.6	-13.0	-55.6
4	551.86	-68.1	-73.3	4.7	-68.6	-13.0	-55.6
5	792.42	-70.2	-68.9	4.1	-64.8	-13.0	-51.8
6	968.96	-71.5	-67.9	3.9	-64.0	-13.0	-51.0

Remarks:

1. ERP (dBm) = S.G Value (dBm) + Correction Factor (dB).
2. Correction Factor (dB) = Substitution Antenna Gain (dB) + Cable Loss (dB).

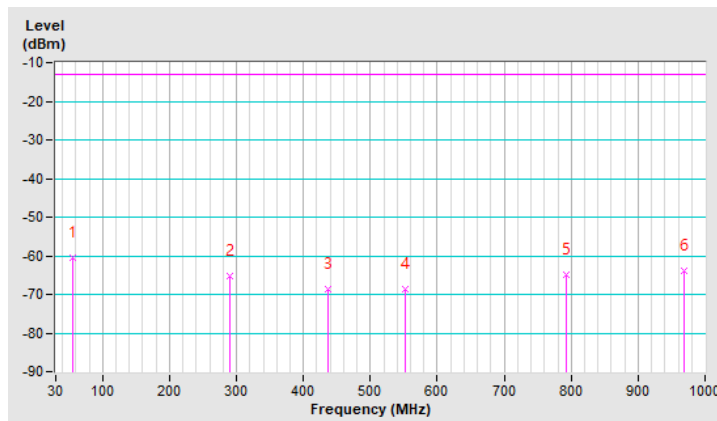

Mode	TX channel 26740 (819.0MHz)	Frequency Range	Below 1000 MHz
Environmental Conditions	25deg. C, 71%RH	Input Power	120Vac, 60Hz
Tested By	Noah Chang		

Antenna Polarity & Test Distance: Vertical at 3 M							
No.	Freq. (MHz)	Reading (dBm)	S.G Power Value (dBm)	Correction Factor (dB)	ERP (dBm)	Limit (dBm)	Margin (dB)
1	88.20	-60.4	-65.8	0.6	-65.2	-13.0	-52.2
2	208.48	-55.9	-62.6	5.4	-57.2	-13.0	-44.2
3	272.50	-63.2	-65.4	5.3	-60.1	-13.0	-47.1
4	546.04	-61.4	-64.9	4.7	-60.2	-13.0	-47.2
5	681.84	-70.4	-70.5	5.1	-65.4	-13.0	-52.4
6	939.86	-68.8	-63.9	3.9	-60.0	-13.0	-47.0

Remarks:

1. ERP (dBm) = S.G Value (dBm) + Correction Factor (dB).
2. Correction Factor (dB) = Substitution Antenna Gain (dB) + Cable Loss (dB).

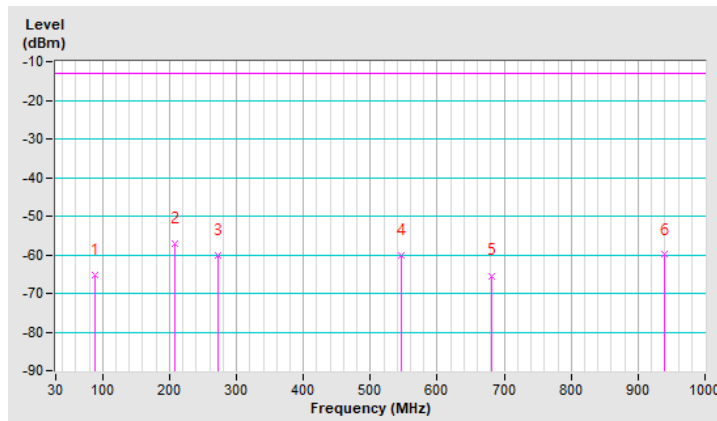

Above 1GHz
CDMA

Mode	TX channel 476 (817.9MHz)	Frequency Range	1GHz~18GHz
Environmental Conditions	25deg. C, 70%RH	Input Power	120Vac, 60Hz
Tested By	Noah Chang		

Antenna Polarity & Test Distance: Horizontal at 3 M							
No.	Freq. (MHz)	Reading (dBm)	S.G Power Value (dBm)	Correction Factor (dB)	ERP (dBm)	Limit (dBm)	Margin (dB)
1	1635.80	-51.2	-54.7	5.5	-49.2	-13.0	-36.2
Antenna Polarity & Test Distance: Vertical at 3 M							
No.	Freq. (MHz)	Reading (dBm)	S.G Power Value (dBm)	Correction Factor (dB)	ERP (dBm)	Limit (dBm)	Margin (dB)
1	1635.80	-51.4	-52.7	5.5	-47.2	-13.0	-34.2

Remarks:

1. ERP (dBm) = S.G Value (dBm) + Correction Factor (dB).
2. Correction Factor (dB) = Substitution Antenna Gain (dB) + Cable Loss (dB).

Mode	TX channel 580 (820.5MHz)	Frequency Range	1GHz~18GHz
Environmental Conditions	25deg. C, 70%RH	Input Power	120Vac, 60Hz
Tested By	Noah Chang		

Antenna Polarity & Test Distance: Horizontal at 3 M							
No.	Freq. (MHz)	Reading (dBm)	S.G Power Value (dBm)	Correction Factor (dB)	ERP (dBm)	Limit (dBm)	Margin (dB)
1	1641.00	-50.9	-54.3	5.5	-48.8	-13.0	-35.8
Antenna Polarity & Test Distance: Vertical at 3 M							
No.	Freq. (MHz)	Reading (dBm)	S.G Power Value (dBm)	Correction Factor (dB)	ERP (dBm)	Limit (dBm)	Margin (dB)
1	1641.00	-51.0	-52.3	5.5	-46.8	-13.0	-33.8

Remarks:

1. ERP (dBm) = S.G Value (dBm) + Correction Factor (dB).
2. Correction Factor (dB) = Substitution Antenna Gain (dB) + Cable Loss (dB).

Mode	TX channel 684 (823.1MHz)	Frequency Range	1GHz~18GHz
Environmental Conditions	25deg. C, 70%RH	Input Power	120Vac, 60Hz
Tested By	Noah Chang		

Antenna Polarity & Test Distance: Horizontal at 3 M							
No.	Freq. (MHz)	Reading (dBm)	S.G Power Value (dBm)	Correction Factor (dB)	ERP (dBm)	Limit (dBm)	Margin (dB)
1	1646.20	-51.6	-54.9	5.5	-49.4	-13.0	-36.4
Antenna Polarity & Test Distance: Vertical at 3 M							
No.	Freq. (MHz)	Reading (dBm)	S.G Power Value (dBm)	Correction Factor (dB)	ERP (dBm)	Limit (dBm)	Margin (dB)
1	1646.20	-51.5	-52.6	5.5	-47.1	-13.0	-34.1

Remarks:

1. $ERP (dBm) = S.G \text{ Value (dBm)} + \text{Correction Factor (dB)}$.
2. $\text{Correction Factor (dB)} = \text{Substitution Antenna Gain (dB)} + \text{Cable Loss (dB)}$.

LTE Band 26, Channel Bandwidth 1.4MHz

Mode	TX channel 26697 (814.7MHz)	Frequency Range	1GHz~18GHz
Environmental Conditions	25deg. C, 70%RH	Input Power	120Vac, 60Hz
Tested By	Noah Chang		

Antenna Polarity & Test Distance: Horizontal at 3 M							
No.	Freq. (MHz)	Reading (dBm)	S.G Power Value (dBm)	Correction Factor (dB)	ERP (dBm)	Limit (dBm)	Margin (dB)
1	1629.40	-48.5	-52.1	5.4	-46.7	-13.0	-33.7
Antenna Polarity & Test Distance: Vertical at 3 M							
No.	Freq. (MHz)	Reading (dBm)	S.G Power Value (dBm)	Correction Factor (dB)	ERP (dBm)	Limit (dBm)	Margin (dB)
1	1629.40	-53.5	-55.9	5.4	-50.5	-13.0	-37.5

Remarks:

1. ERP (dBm) = S.G Value (dBm) + Correction Factor (dB).
2. Correction Factor (dB) = Substitution Antenna Gain (dB) + Cable Loss (dB).

Mode	TX channel 26740 (819.0MHz)	Frequency Range	1GHz~18GHz
Environmental Conditions	25deg. C, 70%RH	Input Power	120Vac, 60Hz
Tested By	Noah Chang		

Antenna Polarity & Test Distance: Horizontal at 3 M							
No.	Freq. (MHz)	Reading (dBm)	S.G Power Value (dBm)	Correction Factor (dB)	ERP (dBm)	Limit (dBm)	Margin (dB)
1	1638.00	-48.4	-52.0	5.5	-46.5	-13.0	-33.5
Antenna Polarity & Test Distance: Vertical at 3 M							
No.	Freq. (MHz)	Reading (dBm)	S.G Power Value (dBm)	Correction Factor (dB)	ERP (dBm)	Limit (dBm)	Margin (dB)
1	1638.00	-53.1	-55.5	5.5	-50.0	-13.0	-37.0

Remarks:

1. ERP (dBm) = S.G Value (dBm) + Correction Factor (dB).
2. Correction Factor (dB) = Substitution Antenna Gain (dB) + Cable Loss (dB).

Mode	TX channel 26783 (823.3MHz)	Frequency Range	1GHz~18GHz
Environmental Conditions	25deg. C, 70%RH	Input Power	120Vac, 60Hz
Tested By	Noah Chang		

Antenna Polarity & Test Distance: Horizontal at 3 M							
No.	Freq. (MHz)	Reading (dBm)	S.G Power Value (dBm)	Correction Factor (dB)	ERP (dBm)	Limit (dBm)	Margin (dB)
1	1646.60	-48.7	-52.2	5.5	-46.7	-13.0	-33.7
Antenna Polarity & Test Distance: Vertical at 3 M							
No.	Freq. (MHz)	Reading (dBm)	S.G Power Value (dBm)	Correction Factor (dB)	ERP (dBm)	Limit (dBm)	Margin (dB)
1	1646.60	-53.6	-55.9	5.5	-50.4	-13.0	-37.4

Remarks:

1. ERP (dBm) = S.G Value (dBm) + Correction Factor (dB).
2. Correction Factor (dB) = Substitution Antenna Gain (dB) + Cable Loss (dB).

LTE Band 26, Channel Bandwidth 5MHz

Mode	TX channel 26715 (816.5MHz)	Frequency Range	1GHz~18GHz
Environmental Conditions	25deg. C, 70%RH	Input Power	120Vac, 60Hz
Tested By	Noah Chang		

Antenna Polarity & Test Distance: Horizontal at 3 M							
No.	Freq. (MHz)	Reading (dBm)	S.G Power Value (dBm)	Correction Factor (dB)	ERP (dBm)	Limit (dBm)	Margin (dB)
1	1633.00	-49.5	-53.1	5.5	-47.6	-13.0	-34.6
Antenna Polarity & Test Distance: Vertical at 3 M							
No.	Freq. (MHz)	Reading (dBm)	S.G Power Value (dBm)	Correction Factor (dB)	ERP (dBm)	Limit (dBm)	Margin (dB)
1	1633.00	-54.6	-57.1	5.5	-51.6	-13.0	-38.6

Remarks:

1. ERP (dBm) = S.G Value (dBm) + Correction Factor (dB).
2. Correction Factor (dB) = Substitution Antenna Gain (dB) + Cable Loss (dB).

Mode	TX channel 26740 (819MHz)	Frequency Range	1GHz~18GHz
Environmental Conditions	25deg. C, 70%RH	Input Power	120Vac, 60Hz
Tested By	Noah Chang		

Antenna Polarity & Test Distance: Horizontal at 3 M							
No.	Freq. (MHz)	Reading (dBm)	S.G Power Value (dBm)	Correction Factor (dB)	ERP (dBm)	Limit (dBm)	Margin (dB)
1	1638.00	-48.6	-52.2	5.5	-46.7	-13.0	-33.7
Antenna Polarity & Test Distance: Vertical at 3 M							
No.	Freq. (MHz)	Reading (dBm)	S.G Power Value (dBm)	Correction Factor (dB)	ERP (dBm)	Limit (dBm)	Margin (dB)
1	1638.00	-54.1	-56.5	5.5	-51.0	-13.0	-38.0

Remarks:

1. ERP (dBm) = S.G Value (dBm) + Correction Factor (dB).
2. Correction Factor (dB) = Substitution Antenna Gain (dB) + Cable Loss (dB).

Mode	TX channel 26765 (821.5MHz)	Frequency Range	1GHz~18GHz
Environmental Conditions	25deg. C, 70%RH	Input Power	120Vac, 60Hz
Tested By	Noah Chang		

Antenna Polarity & Test Distance: Horizontal at 3 M							
No.	Freq. (MHz)	Reading (dBm)	S.G Power Value (dBm)	Correction Factor (dB)	ERP (dBm)	Limit (dBm)	Margin (dB)
1	1643.00	-49.0	-52.5	5.5	-47.0	-13.0	-34.0
Antenna Polarity & Test Distance: Vertical at 3 M							
No.	Freq. (MHz)	Reading (dBm)	S.G Power Value (dBm)	Correction Factor (dB)	ERP (dBm)	Limit (dBm)	Margin (dB)
1	1643.00	-54.0	-56.4	5.5	-50.9	-13.0	-37.9

Remarks:

1. $ERP (dBm) = S.G \text{ Value (dBm)} + \text{Correction Factor (dB)}$.
2. $\text{Correction Factor (dB)} = \text{Substitution Antenna Gain (dB)} + \text{Cable Loss (dB)}$.

LTE Band 26, Channel Bandwidth 10MHz

Mode	TX channel 26740 (819.0MHz)	Frequency Range	1GHz~18GHz
Environmental Conditions	25deg. C, 70%RH	Input Power	120Vac, 60Hz
Tested By	Noah Chang		

Antenna Polarity & Test Distance: Horizontal at 3 M							
No.	Freq. (MHz)	Reading (dBm)	S.G Power Value (dBm)	Correction Factor (dB)	ERP (dBm)	Limit (dBm)	Margin (dB)
1	1638.00	-48.0	-51.6	5.5	-46.1	-13.0	-33.1
Antenna Polarity & Test Distance: Vertical at 3 M							
No.	Freq. (MHz)	Reading (dBm)	S.G Power Value (dBm)	Correction Factor (dB)	ERP (dBm)	Limit (dBm)	Margin (dB)
1	1638.00	-53.4	-55.8	5.5	-50.3	-13.0	-37.3

Remarks:

1. $ERP (dBm) = S.G \text{ Value (dBm)} + \text{Correction Factor (dB)}$.
2. $\text{Correction Factor (dB)} = \text{Substitution Antenna Gain (dB)} + \text{Cable Loss (dB)}$.

5 Pictures of Test Arrangements

Please refer to the attached file (Test Setup Photo).

Appendix – Information on the Testing Laboratories

We, Bureau Veritas Consumer Products Services (H.K.) Ltd., Taoyuan Branch, were founded in 1988 to provide our best service in EMC, Radio, Telecom and Safety consultation. Our laboratories are FCC recognized accredited test firms and accredited and approved according to ISO/IEC 17025.

If you have any comments, please feel free to contact us at the following:

Linko EMC/RF Lab

Tel: 886-2-26052180

Fax: 886-2-26051924

Hsin Chu EMC/RF/Telecom Lab

Tel: 886-3-6668565

Fax: 886-3-6668323

Hwa Ya EMC/RF/Safety Lab

Tel: 886-3-3183232

Fax: 886-3-3270892

Email: service.adt@tw.bureauveritas.com

Web Site: www.bureauveritas-adt.com

The address and road map of all our labs can be found in our web site also.

--- END ---