

FCC Test Report (Part 24)

Report No.: RF180928C18-7 R1

FCC ID: Q3N-RS51

Test Model: RS51

Received Date: Sep. 28, 2018

Test Date: Nov. 20 ~ Dec. 27, 2018

Issued Date: Dec. 28, 2018

Applicant: CIPHERLAB CO., LTD

Address: 12F, 333 Dunhua S. Rd., Sec.2 Taipei, Taiwan 106

Issued By: Bureau Veritas Consumer Products Services (H.K.) Ltd., Taoyuan Branch

Lab Address: No. 47-2, 14th Ling, Chia Pau Vil., Lin Kou Dist., New Taipei City, Taiwan (R.O.C.)

Test Location: No. 19, Hwa Ya 2nd Rd., Wen Hwa Vil., Kwei Shan Dist., Taoyuan City 33383, TAIWAN (R.O.C.)

FCC Registration / 788550 / TW0003

Designation Number:



This report is for your exclusive use. Any copying or replication of this report to or for any other person or entity, or use of our name or trademark, is permitted only with our prior written permission. This report sets forth our findings solely with respect to the test samples identified herein. The results set forth in this report are not indicative or representative of the quality or characteristics of the lot from which a test sample was taken or any similar or identical product specifically and expressly noted. Our report includes all of the tests requested by you and the results thereof based upon the information that you provided to us. You have 60 days from date of issuance of this report to notify us of any material error or omission caused by our negligence, provided, however, that such notice shall be in writing and shall specifically address the issue you wish to raise. A failure to raise such issue within the prescribed time shall constitute your unqualified acceptance of the completeness of this report, the tests conducted and the correctness of the report contents. Unless specific mention, the uncertainty of measurement has been explicitly taken into account to declare the compliance or non-compliance to the specification. The report must not be used by the client to claim product certification, approval, or endorsement by TAF or any government agencies

Table of Contents

Release Control Record	4
1 Certificate of Conformity	5
2 Summary of Test Results	6
2.1 Measurement Uncertainty.....	6
2.2 Test Site and Instruments.....	7
3 General Information	8
3.1 General Description of EUT.....	8
3.2 Configuration of System under Test.....	10
3.2.1 Description of Support Units.....	10
3.3 Test Mode Applicability and Tested Channel Detail.....	11
3.4 EUT Operating Conditions.....	19
3.5 General Description of Applied Standards.....	19
4 Test Types and Results	20
4.1 Output Power Measurement.....	20
4.1.1 Limits of Output Power Measurement.....	20
4.1.2 Test Procedures.....	20
4.1.3 Test Setup.....	21
4.1.4 Test Results.....	22
4.2 Modulation Characteristics Measurement.....	57
4.2.1 Limits of Modulation Characteristics.....	57
4.2.2 Test Procedure.....	57
4.2.3 Test Setup.....	57
4.2.4 Test Results.....	58
4.3 Frequency Stability Measurement.....	62
4.3.1 Limits of Frequency Stability Measurement.....	62
4.3.2 Test Procedure.....	62
4.3.3 Conducted Setup.....	62
4.3.4 Test Results.....	63
4.4 Occupied Bandwidth Measurement.....	79
4.4.1 Test Procedure.....	79
4.4.2 Test Setup.....	79
4.4.3 Test Result.....	80
4.5 Band Edge Measurement.....	94
4.5.1 Limits of Band Edge Measurement.....	94
4.5.2 Test Setup.....	94
4.5.3 Test Procedures.....	94
4.5.4 Test Results.....	95
4.6 Peak to Average Ratio.....	110
4.6.1 Limits of Peak to Average Ratio Measurement.....	110
4.6.2 Test Setup.....	110
4.6.3 Test Procedures.....	110
4.6.4 Test Results.....	111
4.7 Conducted Spurious Emissions.....	118
4.7.1 Limits of Conducted Spurious Emissions Measurement.....	118
4.7.2 Test Setup.....	118
4.7.3 Test Procedure.....	118
4.7.4 Test Results.....	119
4.8 Radiated Emission Measurement.....	176
4.8.1 Limits of Radiated Emission Measurement.....	176
4.8.2 Test Procedure.....	176
4.8.3 Deviation from Test Standard.....	176
4.8.4 Test Setup.....	177
4.8.5 Test Results.....	178

5	Pictures of Test Arrangements.....	226
	Appendix – Information on the Testing Laboratories	227

Release Control Record

Issue No.	Description	Date Issued
RF180928C18-7	Original release	Dec. 07, 2018
RF180928C18-7 R1	Added CDMA mode	Dec. 28, 2018

1 Certificate of Conformity

Product: Mobile Computer

Brand: CIPHERLAB

Test Model: RS51

Sample Status: Engineering sample

Applicant: CIPHERLAB CO., LTD

Test Date: Nov. 20 ~ Dec. 27, 2018

Standards: FCC Part 24, Subpart E

The above equipment has been tested by **Bureau Veritas Consumer Products Services (H.K.) Ltd., Taoyuan Branch**, and found compliance with the requirement of the above standards. The test record, data evaluation & Equipment Under Test (EUT) configurations represented herein are true and accurate accounts of the measurements of the sample's RF characteristics under the conditions specified in this report.

Prepared by : Pettie Chen , **Date:** Dec. 28, 2018
Pettie Chen / Senior Specialist

Approved by : Bruce Chen , **Date:** Dec. 28, 2018
Bruce Chen / Project Engineer

2 Summary of Test Results

Applied Standard: FCC Part 24 & Part 2			
FCC Clause	Test Item	Result	Remarks
2.1046 24.232	Effective radiated power	Pass	Meet the requirement of limit.
2.1046 24.232(d)	Peak To Average Ratio	Pass	Meet the requirement of limit.
2.1047	Modulation Characteristics	Pass	Meet the requirement
2.1055 24.235	Frequency Stability	Pass	Meet the requirement of limit.
2.1049 24.238(b)	Occupied Bandwidth	Pass	Meet the requirement of limit.
24.238(b)	Band Edge Measurements	Pass	Meet the requirement of limit.
2.1051 24.238	Conducted Spurious Emissions	Pass	Meet the requirement of limit.
2.1053 24.238	Radiated Spurious Emissions	Pass	Meet the requirement of limit. Minimum passing margin is -23.2dB at 3828.60MHz.

2.1 Measurement Uncertainty

Where relevant, the following measurement uncertainty levels have been estimated for tests performed on the EUT as specified in CISPR 16-4-2:

Measurement	Frequency	Expanded Uncertainty (k=2) (\pm)
Radiated Emissions up to 1 GHz	30MHz ~ 200MHz	3.63 dB
	200MHz ~1000MHz	3.64 dB
Radiated Emissions above 1 GHz	1GHz ~ 18GHz	2.29 dB
	18GHz ~ 40GHz	2.29 dB

2.2 Test Site and Instruments

Description & Manufacturer	Model No.	Serial No.	Cal. Date	Cal. Due
Test Receiver ROHDE & SCHWARZ	ESIB7	100187	May 29, 2018	May 28, 2019
Spectrum Analyzer ROHDE & SCHWARZ	FSP40	100040	Sep. 25, 2018	Sep. 24, 2019
BILOG Antenna SCHWARZBECK	VULB9168	9168-155	Dec. 11, 2017	Dec. 10, 2018
			Nov. 21, 2018	Nov. 20, 2019
HORN Antenna SCHWARZBECK	9120D	9120D-408	Mar. 25, 2018	Mar. 24, 2019
HORN Antenna SCHWARZBECK	BBHA 9170	BBHA9170241	Dec. 01, 2017	Nov. 30, 2018
			Nov. 25, 2018	Nov. 24, 2019
Loop Antenna EMCI	EM-6879	269	Sep. 07, 2018	Sep. 06, 2019
Preamplifier Agilent (Below 1GHz)	8447D	2944A10631	Aug. 08, 2018	Aug. 07, 2019
Preamplifier KEYSIGHT (Above 1GHz)	83017A	MY53270295	Jul. 02, 2018	Jul. 01, 2019
RF signal cable WOKEN	8D-FB	Cable-CH4-01	Aug. 28, 2018	Aug. 27, 2019
RF signal cable HUBER+SUHNER	SUCOFLEX 104	MY 13380+295012/04	Aug. 08, 2018	Aug. 07, 2019
RF signal cable HUBER+SUHNER	SUCOFLEX 104	Cable-CH4-03 (250724)	Aug. 08, 2018	Aug. 07, 2019
Software BV ADT	ADT_Radiated_ V7.6.15.9.5	NA	NA	NA
Antenna Tower inn-co GmbH	MA 4000	010303	NA	NA
Antenna Tower Controller BV ADT	AT100	AT93021703	NA	NA
Turn Table BV ADT	TT100	TT93021703	NA	NA
Turn Table Controller BV ADT	SC100	SC93021703	NA	NA
Boresight Antenna Fixture	FBA-01	FBA-SIP01	NA	NA
Turn Table Controller BV ADT	SC100	SC93021705	NA	NA
WIT Standard Temperature And Humidity Chamber	TH-4S-C	W981030	Jun. 04, 2018	Jun. 03, 2019
JFW 20dB attenuation	50HF-020-SMA	NA	NA	NA

- Note: 1. The calibration interval of the above test instruments is 12 months and the calibrations are traceable to NML/ROC and NIST/USA.
2. The test was performed in HwaYa Chamber 4.
3. The FCC Designation Number is TW0003. The number will be varied with the Lab location and scope as attached.
4. The IC Site Registration No. is 7450F-4.

3 General Information

3.1 General Description of EUT

Product	Mobile Computer	
Brand	CIPHERLAB	
Test Model	RS51	
Sample Status	Engineering sample	
Power Supply Rating	5Vdc (adapter) 3.75Vdc (battery)	
Modulation Type	PCS, GPRS: GMSK EDGE: 8PSK CDMA: QPSK, OQPSK, HPSK WCDMA: BPSK, QPSK HSDPA: BPSK HSUPA: QPSK LTE: QPSK, 16QAM	
Operating Frequency	PCS/GPRS/EDGE	1850.2~1909.8MHz
	CDMA	1851.25~1908.75MHz
	WCDMA Band 2	1852.4~1907.6MHz
	LTE Band 2 (Channel Bandwidth 1.4MHz)	1850.7~1909.3MHz
	LTE Band 2 (Channel Bandwidth 3MHz)	1851.5~1908.5MHz
	LTE Band 2 (Channel Bandwidth 5MHz)	1852.5~1907.5MHz
	LTE Band 2 (Channel Bandwidth 10MHz)	1855.0~1905.0MHz
	LTE Band 2 (Channel Bandwidth 15MHz)	1857.5~1902.5MHz
	LTE Band 2 (Channel Bandwidth 20MHz)	1860.0~1900.0MHz
	LTE Band 25 (Channel Bandwidth: 1.4MHz)	1850.7~1914.3MHz
	LTE Band 25 (Channel Bandwidth: 3MHz)	1851.5~1913.5MHz
	LTE Band 25 (Channel Bandwidth: 5MHz)	1852.5~1912.5MHz
	LTE Band 25 (Channel Bandwidth: 10MHz)	1855.0~1910.0MHz
	LTE Band 25 (Channel Bandwidth: 15MHz)	1857.5~1907.5MHz
	LTE Band 25 (Channel Bandwidth: 20MHz)	1860.0~1905.0MHz

Max. EIRP Power	PCS/GPRS/EDGE	436.516mW (26.4dBm)		
	CDMA	301.995mW (24.8dBm)		
	WCDMA Band 2	363.078mW (25.6dBm)		
		QPSK	16QAM	
	LTE Band 2 (Channel Bandwidth 1.4MHz)	376.704mW (25.76dBm)	251.189mW (24.00dBm)	
	LTE Band 2 (Channel Bandwidth 3MHz)	309.030mW (24.90dBm)	245.471mW (23.90dBm)	
	LTE Band 2 (Channel Bandwidth 5MHz)	334.965mW (25.25dBm)	234.423mW (23.70dBm)	
	LTE Band 2 (Channel Bandwidth 10MHz)	295.801mW (24.71dBm)	223.872mW (23.50dBm)	
	LTE Band 2 (Channel Bandwidth 15MHz)	316.957mW (25.01dBm)	234.423mW (23.70dBm)	
	LTE Band 2 (Channel Bandwidth 20MHz)	304.789mW (24.84dBm)	234.423mW (23.70dBm)	
	LTE Band 25 (Channel Bandwidth: 1.4MHz)	265.461mW (24.24dBm)	257.040mW (24.10dBm)	
	LTE Band 25 (Channel Bandwidth: 3MHz)	281.190mW (24.49dBm)	263.028mW (24.20dBm)	
	LTE Band 25 (Channel Bandwidth: 5MHz)	256.448mW (24.09dBm)	234.423mW (23.70dBm)	
	LTE Band 25 (Channel Bandwidth: 10MHz)	245.471mW (23.90dBm)	239.883mW (23.80dBm)	
	LTE Band 25 (Channel Bandwidth: 15MHz)	270.396mW (24.32dBm)	245.471mW (23.90dBm)	
	LTE Band 25 (Channel Bandwidth: 20MHz)	287.740mW (24.59dBm)	257.040mW (24.10dBm)	
	Emission Designator	PCS/GPRS/EDGE	260KGXW	
CDMA		1M28F9W		
WCDMA Band 2		4M13F9W		
		QPSK	16QAM	
LTE Band 2 (Channel Bandwidth 1.4MHz)		1M09G7D	1M09W7D	
LTE Band 2 (Channel Bandwidth 3MHz)		2M70G7D	2M70W7D	
LTE Band 2 (Channel Bandwidth 5MHz)		4M49G7D	4M48W7D	
LTE Band 2 (Channel Bandwidth 10MHz)		8M96G7D	8M96W7D	
LTE Band 2 (Channel Bandwidth 15MHz)		13M4G7D	13M4W7D	
LTE Band 2 (Channel Bandwidth 20MHz)		17M9G7D	17M9W7D	
LTE Band 25 (Channel Bandwidth: 1.4MHz)		1M09G7D	1M09W7D	
LTE Band 25 (Channel Bandwidth: 3MHz)		2M70G7D	2M70W7D	
LTE Band 25 (Channel Bandwidth: 5MHz)		4M49G7D	4M49W7D	
LTE Band 25 (Channel Bandwidth: 10MHz)		8M99G7D	8M99W7D	
LTE Band 25 (Channel Bandwidth: 15MHz)		13M4G7D	13M4W7D	
LTE Band 25 (Channel Bandwidth: 20MHz)	17M9G7D	17M9W7D		
Antenna Type	Refer to Note			
Antenna Connector	Refer to Note			
Accessory Device	Refer to Note			
Cable Supplied	1.6m non-shielded snapon cable with one core			

Note:

1. The EUT uses following antennas.

Antenna Type	Antenna Connector	Antenna Gain (dBi)		
		Ant.	Main (TX/RX)	Diversity (RX)
PIFA	Spring	PCS 1900	2.7	2.39
		CDMA BC1	2.7	2.39
		WCDMA Band 2	2.86	2.39
		LTE Band 2	2.7	2.39
		LTE Band 25	2.86	2.39

2. The EUT uses following accessory devices.

Component	Vendor	Model	Specification
Adapter	Sunny COMPUTER TECHNOLOGY CO.,LTD.	SYS1561-1005	I/P: 100-240Vac, 1.0A MAX, 50-60Hz O/P: +5Vdc, 2A, 10W MAX.
Battery	CIPHERLAB	BA-0115A3	Rating: 3.75Vdc, 5300mAh, 19.88Wh

3.2 Configuration of System under Test

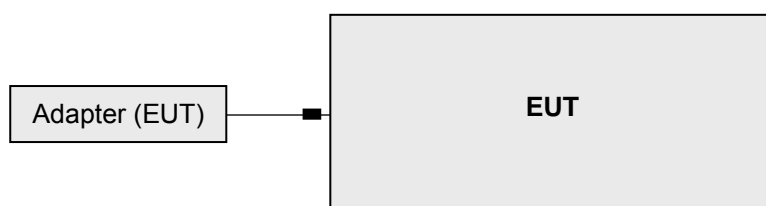

Remote site

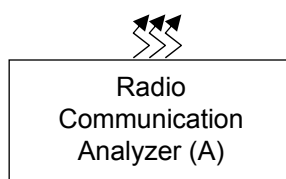

3.2.1 Description of Support Units

The EUT has been tested as an independent unit together with other necessary accessories or support units. The following support units or accessories were used to form a representative test configuration during the tests.

ID	Product	Brand	Model No.	Serial No.	FCC ID	Remarks
A.	Radio Communication Analyzer	Anritsu	MT8860C	1702001	NA	-

Note:

1. All power cords of the above support units are non-shielded (1.8m).
2. Item A acted as a communication partner to transfer data.

3.3 Test Mode Applicability and Tested Channel Detail

Pre-Scan has been conducted to determine the worst-case mode from all possible combinations between available modulations, data rates, XYZ axis and antenna ports. The worst case was found when positioned on Y-plane. Following channel(s) was (were) selected for the final test as listed below:

PCS Mode

EUT Configure Mode	Test Item	Available Channel	Tested Channel	Mode
-	EIRP	512 to 810	512(1850.2MHz), 661(1880.0MHz), 810(1909.8MHz)	PCS
-	Modulation characteristics	512 to 810	661(1880.0MHz)	PCS, GPRS, EDGE
-	Frequency Stability	512 to 810	512(1850.2MHz), 810(1909.8MHz)	PCS
-	Occupied Bandwidth	512 to 810	512(1850.2MHz), 661(1880.0MHz), 810(1909.8MHz)	PCS, GPRS, EDGE
-	Band Edge	512 to 810	512(1850.2MHz), 810(1909.8MHz)	PCS, GPRS, EDGE
-	Peak To Average Ratio	512 to 810	512(1850.2MHz), 661(1880.0MHz), 810(1909.8MHz)	PCS, GPRS, EDGE
-	Conducted Emission	512 to 810	512(1850.2MHz), 661(1880.0MHz), 810(1909.8MHz)	PCS, GPRS, EDGE
-	Radiated Emission Below 1GHz	512 to 810	661(1880.0MHz)	PCS
-	Radiated Emission Above 1GHz	512 to 810	512(1850.2MHz), 661(1880.0MHz), 810(1909.8MHz)	PCS

CDMA Mode

EUT Configure Mode	Test Item	Available Channel	Tested Channel	Mode
-	EIRP	25 to 1175	25(1851.25MHz), 600(1880.00MHz), 1175(1908.75MHz)	RC3+SO55
-	Modulation characteristics	25 to 1175	25(1851.25MHz)	RC1+SO03
-	Frequency Stability	25 to 1175	25(1851.25MHz), 1175(1908.75MHz)	RC3+SO55
-	Occupied Bandwidth	25 to 1175	25(1851.25MHz), 600(1880.00MHz), 1175(1908.75MHz)	RC3+SO55
-	Band Edge	25 to 1175	25(1851.25MHz), 1175(1908.75MHz)	RC3+SO55
-	Peak to Average Ratio	25 to 1175	25(1851.25MHz), 600(1880.00MHz), 1175(1908.75MHz)	RC3+SO55
-	Conducted Emission	25 to 1175	25(1851.25MHz), 600(1880.00MHz), 1175(1908.75MHz)	RC3+SO55
-	Radiated Emission Below 1GHz	25 to 1175	25(1851.25MHz)	RC3+SO55
-	Radiated Emission Above 1GHz	25 to 1175	25(1851.25MHz), 600(1880.00MHz), 1175(1908.75MHz)	RC3+SO55

WCDMA Band 2

EUT Configure Mode	Test Item	Available Channel	Tested Channel	Mode
-	EIRP	9262 to 9538	9262 (1852.4MHz), 9400 (1880.0MHz), 9538 (1907.6MHz)	WCDMA
-	Modulation Characteristics	9262 to 9538	9400 (1880.0MHz)	WCDMA, HSDPA, HSUPA
-	Frequency Stability	9262 to 9538	9262 (1852.4MHz), 9538 (1907.6MHz)	WCDMA
-	Occupied Bandwidth	9262 to 9538	9262 (1852.4MHz), 9400 (1880.0MHz), 9538 (1907.6MHz)	WCDMA, HSDPA, HSUPA
-	Band Edge	9262 to 9538	9262 (1852.4MHz), 9538 (1907.6MHz)	WCDMA, HSDPA, HSUPA
-	Peak To Average Ratio	9262 to 9538	9262 (1852.4MHz), 9400 (1880.0MHz), 9538 (1907.6MHz)	WCDMA, HSDPA, HSUPA
-	Conducted Emission	9262 to 9538	9262 (1852.4MHz), 9400 (1880.0MHz), 9538 (1907.6MHz)	WCDMA, HSDPA, HSUPA
-	Radiated Emission Below 1GHz	9262 to 9538	9262 (1852.4MHz)	WCDMA
-	Radiated Emission Above 1GHz	9262 to 9538	9262 (1852.4MHz), 9400 (1880.0MHz), 9538 (1907.6MHz)	WCDMA

LTE Band 2

EUT Configure Mode	Test item	Available channel	Tested Channel	Channel Bandwidth	Modulation	Mode
-	EIRP	18607 to 19193	18607 (1850.70MHz), 18900 (1880.00MHz), 19193 (1909.30MHz)	1.4MHz	QPSK / 16QAM	1 RB / 5 RB Offset
		18615 to 19185	18615 (1851.50MHz), 18900 (1880.00MHz), 19185 (1908.50MHz)	3MHz	QPSK / 16QAM	1 RB / 14 RB Offset
		18625 to 19175	18625 (1852.50MHz), 18900 (1880.00MHz), 19175 (1907.50MHz)	5MHz	QPSK / 16QAM	1 RB / 24 RB Offset
		18650 to 19150	18650 (1855.00MHz), 18900 (1880.00MHz), 19150 (1905.00MHz)	10MHz	QPSK / 16QAM	1 RB / 49 RB Offset
		18675 to 19125	18675 (1857.50MHz), 18900 (1880.00MHz), 19125 (1902.50MHz)	15MHz	QPSK / 16QAM	1 RB / 74 RB Offset
		18700 to 19100	18700 (1860.00MHz), 18900 (1880.00MHz), 19100 (1900.00MHz)	20MHz	QPSK / 16QAM	1 RB / 99 RB Offset
-	Modulation Characteristics	18700 to 19100	18900 (1880.00MHz)	20MHz	QPSK / 16QAM	100 RB / 0 RB Offset
-	Frequency Stability	18607 to 19193	18607 (1850.70MHz), 19193 (1909.30MHz)	1.4MHz	QPSK	1 RB / 5 RB Offset
		18615 to 19185	18615 (1851.50MHz), 19185 (1908.50MHz)	3MHz	QPSK	1 RB / 14 RB Offset
		18625 to 19175	18625 (1852.50MHz), 19175 (1907.50MHz)	5MHz	QPSK	1 RB / 24 RB Offset
		18650 to 19150	18650 (1855.00MHz), 19150 (1905.00MHz)	10MHz	QPSK	1 RB / 49 RB Offset
		18675 to 19125	18675 (1857.50MHz), 19125 (1902.50MHz)	15MHz	QPSK	1 RB / 74 RB Offset
		18700 to 19100	18700 (1860.00MHz), 19100 (1900.00MHz)	20MHz	QPSK	1 RB / 99 RB Offset
-	Occupied Bandwidth	18607 to 19193	18607 (1850.70MHz), 18900 (1880.00MHz), 19193 (1909.30MHz)	1.4MHz	QPSK / 16QAM	1 RB / 5 RB Offset
		18615 to 19185	18615 (1851.50MHz), 18900 (1880.00MHz), 19185 (1908.50MHz)	3MHz	QPSK / 16QAM	1 RB / 14 RB Offset
		18625 to 19175	18625 (1852.50MHz), 18900 (1880.00MHz), 19175 (1907.50MHz)	5MHz	QPSK / 16QAM	1 RB / 24 RB Offset
		18650 to 19150	18650 (1855.00MHz), 18900 (1880.00MHz), 19150 (1905.00MHz)	10MHz	QPSK / 16QAM	1 RB / 49 RB Offset
		18675 to 19125	18675 (1857.50MHz), 18900 (1880.00MHz), 19125 (1902.50MHz)	15MHz	QPSK / 16QAM	1 RB / 74 RB Offset
		18700 to 19100	18700 (1860.00MHz), 18900 (1880.00MHz), 19100 (1900.00MHz)	20MHz	QPSK / 16QAM	1 RB / 99 RB Offset

EUT Configure Mode	Test item	Available channel	Tested Channel	Channel Bandwidth	Modulation	Mode
-	Band Edge	18607 to 19193	18607 (1850.70MHz), 19193 (1909.30MHz)	1.4MHz	QPSK	1 RB / 0 RB Offset 1 RB / 5 RB Offset 6 RB / 0 RB Offset
		18615 to 19185	18615 (1851.50MHz), 19185 (1908.50MHz)	3MHz	QPSK	1 RB / 0 RB Offset 1 RB / 14 RB Offset 15 RB / 0 RB Offset
		18625 to 19175	18625 (1852.50MHz), 19175 (1907.50MHz)	5MHz	QPSK	1 RB / 0 RB Offset 1 RB / 24 RB Offset 25 RB / 0 RB Offset
		18650 to 19150	18650 (1855.00MHz), 19150 (1905.00MHz)	10MHz	QPSK	1 RB / 0 RB Offset 1 RB / 49 RB Offset 50 RB / 0 RB Offset
		18675 to 19125	18675 (1857.50MHz), 19125 (1902.50MHz)	15MHz	QPSK	1 RB / 0 RB Offset 1 RB / 74 RB Offset 75 RB / 0 RB Offset
		18700 to 19100	18700 (1860.00MHz), 19100 (1900.00MHz)	20MHz	QPSK	1 RB / 0 RB Offset 1 RB / 99 RB Offset 100 RB / 0 RB Offset
-	Peak to Average Ratio	18607 to 19193	18607 (1850.70MHz), 18900 (1880.00MHz), 19193 (1909.30MHz)	1.4MHz	QPSK / 16QAM	1 RB / 5 RB Offset
		18615 to 19185	18615 (1851.50MHz), 18900 (1880.00MHz), 19185 (1908.50MHz)	3MHz	QPSK / 16QAM	1 RB / 14 RB Offset
		18625 to 19175	18625 (1852.50MHz), 18900 (1880.00MHz), 19175 (1907.50MHz)	5MHz	QPSK / 16QAM	1 RB / 24 RB Offset
		18650 to 19150	18650 (1855.00MHz), 18900 (1880.00MHz), 19150 (1905.00MHz)	10MHz	QPSK / 16QAM	1 RB / 49 RB Offset
		18675 to 19125	18675 (1857.50MHz), 18900 (1880.00MHz), 19125 (1902.50MHz)	15MHz	QPSK / 16QAM	1 RB / 74 RB Offset
		18700 to 19100	18700 (1860.00MHz), 18900 (1880.00MHz), 19100 (1900.00MHz)	20MHz	QPSK / 16QAM	1 RB / 99 RB Offset
-	Conducted Emission	18607 to 19193	18607 (1850.70MHz), 18900 (1880.00MHz), 19193 (1909.30MHz)	1.4MHz	QPSK	1 RB / 5 RB Offset
		18615 to 19185	18615 (1851.50MHz), 18900 (1880.00MHz), 19185 (1908.50MHz)	3MHz	QPSK	1 RB / 14 RB Offset
		18625 to 19175	18625 (1852.50MHz), 18900 (1880.00MHz), 19175 (1907.50MHz)	5MHz	QPSK	1 RB / 24 RB Offset
		18650 to 19150	18650 (1855.00MHz), 18900 (1880.00MHz), 19150 (1905.00MHz)	10MHz	QPSK	1 RB / 49 RB Offset
		18675 to 19125	18675 (1857.50MHz), 18900 (1880.00MHz), 19125 (1902.50MHz)	15MHz	QPSK	1 RB / 74 RB Offset
		18700 to 19100	18700 (1860.00MHz), 18900 (1880.00MHz), 19100 (1900.00MHz)	20MHz	QPSK	1 RB / 99 RB Offset

EUT Configure Mode	Test item	Available channel	Tested Channel	Channel Bandwidth	Modulation	Mode
-	Radiated Emission Below 1GHz	18607 to 19193	18607 (1850.70MHz)	1.4MHz	QPSK	1 RB / 5 RB Offset
		18615 to 19185	18615 (1851.50MHz)	3MHz	QPSK	1 RB / 14 RB Offset
		18625 to 19175	18625 (1852.50MHz)	5MHz	QPSK	1 RB / 24 RB Offset
		18650 to 19150	18650 (1855.00MHz)	10MHz	QPSK	1 RB / 49 RB Offset
		18675 to 19125	18675 (1857.50MHz)	15MHz	QPSK	1 RB / 74 RB Offset
		18700 to 19100	18700 (1860.00MHz)	20MHz	QPSK	1 RB / 99 RB Offset
-	Radiated Emission Above 1GHz	18607 to 19193	18607 (1850.70MHz), 18900 (1880.00MHz), 19193 (1909.30MHz)	1.4MHz	QPSK	1 RB / 5 RB Offset
		18615 to 19185	18615 (1851.50MHz), 18900 (1880.00MHz), 19185 (1908.50MHz)	3MHz	QPSK	1 RB / 14 RB Offset
		18625 to 19175	18625 (1852.50MHz), 18900 (1880.00MHz), 19175 (1907.50MHz)	5MHz	QPSK	1 RB / 24 RB Offset
		18650 to 19150	18650 (1855.00MHz), 18900 (1880.00MHz), 19150 (1905.00MHz)	10MHz	QPSK	1 RB / 49 RB Offset
		18675 to 19125	18675 (1857.50MHz), 18900 (1880.00MHz), 19125 (1902.50MHz)	15MHz	QPSK	1 RB / 74 RB Offset
		18700 to 19100	18700 (1860.00MHz), 18900 (1880.00MHz), 19100 (1900.00MHz)	20MHz	QPSK	1 RB / 99 RB Offset

Note:

1. For radiated emission below 1GHz, low, mid and high channels were pre-tested in chamber. Low channel was the worst case for all final tests.
2. The conducted output power for QPSK and 16QAM, measured value of QPSK is higher than 16QAM mode. Therefore, Occupied bandwidth and Peak to average ratio items were tested under QPSK and 16QAM modes, and the other test items were tested under QPSK mode only.

LTE Band 25

EUT Configure Mode	Test item	Available channel	Tested Channel	Channel Bandwidth	Modulation	Mode
-	EIRP	26047 to 26683	26047 (1850.7MHz), 26365 (1882.5MHz), 26683 (1914.3MHz)	1.4MHz	QPSK / 16QAM	1 RB / 0 RB Offset
		26055 to 26675	26055 (1851.5MHz), 26365 (1882.5MHz), 26675 (1913.5MHz)	3MHz	QPSK / 16QAM	1 RB / 0 RB Offset
		26065 to 26665	26065 (1852.5MHz), 26365 (1882.5MHz), 26665 (1912.5MHz)	5MHz	QPSK / 16QAM	1 RB / 0 RB Offset
		26090 to 26640	26090 (1855.0MHz), 26365 (1882.5MHz), 26640 (1910.0MHz)	10MHz	QPSK / 16QAM	1 RB / 0 RB Offset
		26115 to 26615	26115 (1857.5MHz), 26365 (1882.5MHz), 26615 (1907.5MHz)	15MHz	QPSK / 16QAM	1 RB / 0 RB Offset
		26140 to 26590	26140 (1860.0MHz), 26365 (1882.5MHz), 26590 (1905.0MHz)	20MHz	QPSK / 16QAM	1 RB / 0 RB Offset
-	Modulation Characteristics	26065 to 26665	26365 (1882.5MHz)	20MHz	QPSK / 16QAM	100 RB / 0 RB Offset
-	Frequency Stability	26047 to 26683	26047 (1850.7MHz), 26683 (1914.3MHz)	1.4MHz	QPSK	1 RB / 0 RB Offset
		26055 to 26675	26055 (1851.5MHz), 26675 (1913.5MHz)	3MHz	QPSK	1 RB / 0 RB Offset
		26065 to 26665	26065 (1852.5MHz), 26665 (1912.5MHz)	5MHz	QPSK	1 RB / 0 RB Offset
		26090 to 26640	26090 (1855.0MHz), 26640 (1910.0MHz)	10MHz	QPSK	1 RB / 0 RB Offset
		26115 to 26615	26115 (1857.5MHz), 26615 (1907.5MHz)	15MHz	QPSK	1 RB / 0 RB Offset
		26140 to 26590	26140 (1860.0MHz), 26590 (1905.0MHz)	20MHz	QPSK	1 RB / 0 RB Offset
-	Occupied Bandwidth	26047 to 26683	26047 (1850.7MHz), 26365 (1882.5MHz), 26683 (1914.3MHz)	1.4MHz	QPSK / 16QAM	6 RB / 0 RB Offset
		26055 to 26675	26055 (1851.5MHz), 26365 (1882.5MHz), 26675 (1913.5MHz)	3MHz	QPSK / 16QAM	15 RB / 0 RB Offset
		26065 to 26665	26065 (1852.5MHz), 26365 (1882.5MHz), 26665 (1912.5MHz)	5MHz	QPSK / 16QAM	25 RB / 0 RB Offset
		26090 to 26640	26090 (1855.0MHz), 26365 (1882.5MHz), 26640 (1910.0MHz)	10MHz	QPSK / 16QAM	50 RB / 0 RB Offset
		26115 to 26615	26115 (1857.5MHz), 26365 (1882.5MHz), 26615 (1907.5MHz)	15MHz	QPSK / 16QAM	75 RB / 0 RB Offset
		26140 to 26590	26140 (1860.0MHz), 26365 (1882.5MHz), 26590 (1905.0MHz)	20MHz	QPSK / 16QAM	100 RB / 0 RB Offset

EUT Configure Mode	Test item	Available channel	Tested Channel	Channel Bandwidth	Modulation	Mode
-	Band Edge	26047 to 26683	26047 (1850.7MHz), 26683 (1914.3MHz)	1.4MHz	QPSK	1 RB / 0 RB Offset 1 RB / 5 RB Offset 6 RB / 0 RB Offset
		26055 to 26675	26055 (1851.5MHz), 26675 (1913.5MHz)	3MHz	QPSK	1 RB / 0 RB Offset 1 RB / 14 RB Offset 15 RB / 0 RB Offset
		26065 to 26665	26065 (1852.5MHz), 26665 (1912.5MHz)	5MHz	QPSK	1 RB / 0 RB Offset 1 RB / 24 RB Offset 25 RB / 0 RB Offset
		26090 to 26640	26090 (1855.0MHz), 26640 (1910.0MHz)	10MHz	QPSK	1 RB / 0 RB Offset 1 RB / 49 RB Offset 50 RB / 0 RB Offset
		26115 to 26615	26115 (1857.5MHz), 26615 (1907.5MHz)	15MHz	QPSK	1 RB / 0 RB Offset 1 RB / 74 RB Offset 75 RB / 0 RB Offset
		26140 to 26590	26140 (1860.0MHz), 26590 (1905.0MHz)	20MHz	QPSK	1 RB / 0 RB Offset 1 RB / 99 RB Offset 100 RB / 0 RB Offset
-	Peak to Average Ratio	26047 to 26683	26047 (1850.7MHz), 26365 (1882.5MHz), 26683 (1914.3MHz)	1.4MHz	QPSK / 16QAM	1 RB / 0 RB Offset
		26055 to 26675	26055 (1851.5MHz), 26365 (1882.5MHz), 26675 (1913.5MHz)	3MHz	QPSK / 16QAM	1 RB / 0 RB Offset
		26065 to 26665	26065 (1852.5MHz), 26365 (1882.5MHz), 26665 (1912.5MHz)	5MHz	QPSK / 16QAM	1 RB / 0 RB Offset
		26090 to 26640	26090 (1855.0MHz), 26365 (1882.5MHz), 26640 (1910.0MHz)	10MHz	QPSK / 16QAM	1 RB / 0 RB Offset
		26115 to 26615	26115 (1857.5MHz), 26365 (1882.5MHz), 26615 (1907.5MHz)	15MHz	QPSK / 16QAM	1 RB / 0 RB Offset
		26140 to 26590	26140 (1860.0MHz), 26365 (1882.5MHz), 26590 (1905.0MHz)	20MHz	QPSK / 16QAM	1 RB / 0 RB Offset
-	Conducted Emission	26047 to 26683	26047 (1850.7MHz), 26365 (1882.5MHz), 26683 (1914.3MHz)	1.4MHz	QPSK	1 RB / 0 RB Offset
		26055 to 26675	26055 (1851.5MHz), 26365 (1882.5MHz), 26675 (1913.5MHz)	3MHz	QPSK	1 RB / 0 RB Offset
		26065 to 26665	26065 (1852.5MHz), 26365 (1882.5MHz), 26665 (1912.5MHz)	5MHz	QPSK	1 RB / 0 RB Offset
		26090 to 26640	26090 (1855.0MHz), 26365 (1882.5MHz), 26640 (1910.0MHz)	10MHz	QPSK	1 RB / 0 RB Offset
		26115 to 26615	26115 (1857.5MHz), 26365 (1882.5MHz), 26615 (1907.5MHz)	15MHz	QPSK	1 RB / 0 RB Offset
		26140 to 26590	26140 (1860.0MHz), 26365 (1882.5MHz), 26590 (1905.0MHz)	20MHz	QPSK	1 RB / 0 RB Offset
-	Radiated Emission Below 1GHz	26047 to 26683	26047 (1850.7MHz)	1.4MHz	QPSK	1 RB / 0 RB Offset
		26055 to 26675	26055 (1851.5MHz)	3MHz	QPSK	1 RB / 0 RB Offset
		26065 to 26665	26065 (1852.5MHz)	5MHz	QPSK	1 RB / 0 RB Offset
		26090 to 26640	26090 (1855.0MHz)	10MHz	QPSK	1 RB / 0 RB Offset
		26115 to 26615	26115 (1857.5MHz)	15MHz	QPSK	1 RB / 0 RB Offset
		26140 to 26590	26140 (1860.0MHz)	20MHz	QPSK	1 RB / 0 RB Offset

EUT Configure Mode	Test item	Available channel	Tested Channel	Channel Bandwidth	Modulation	Mode
-	Radiated Emission Above 1GHz	26047 to 26683	26047 (1850.7MHz), 26365 (1882.5MHz), 26683 (1914.3MHz)	1.4MHz	QPSK	1 RB / 0 RB Offset
		26055 to 26675	26055 (1851.5MHz), 26365 (1882.5MHz), 26675 (1913.5MHz)	3MHz	QPSK	1 RB / 0 RB Offset
		26065 to 26665	26065 (1852.5MHz), 26365 (1882.5MHz), 26665 (1912.5MHz)	5MHz	QPSK	1 RB / 0 RB Offset
		26090 to 26640	26090 (1855.0MHz), 26365 (1882.5MHz), 26640 (1910.0MHz)	10MHz	QPSK	1 RB / 0 RB Offset
		26115 to 26615	26115 (1857.5MHz), 26365 (1882.5MHz), 26615 (1907.5MHz)	15MHz	QPSK	1 RB / 0 RB Offset
		26140 to 26590	26140 (1860.0MHz), 26365 (1882.5MHz), 26590 (1905.0MHz)	20MHz	QPSK	1 RB / 0 RB Offset

Note:

1. For radiated emission below 1GHz, low, mid and high channels were pre-tested in chamber. Low channel was the worst case for all final tests.
2. The conducted output power for QPSK and 16QAM, measured value of QPSK is higher than 16QAM mode. Therefore, Occupied bandwidth and Peak to average ratio items were tested under QPSK and 16QAM modes, and the other test items were tested under QPSK mode only.

Test Condition:

Test Item	Environmental Conditions	Input Power (system)	Tested By
EIRP	25deg. C, 70%RH	120Vac, 60Hz	Noah Chang
Modulation Characteristics	24deg. C, 64%RH	120Vac, 60Hz	James Yang
Frequency Stability	24deg. C, 64%RH	120Vac, 60Hz	James Yang
Occupied Bandwidth	24deg. C, 64%RH	120Vac, 60Hz	James Yang
Band Edge	24deg. C, 64%RH	120Vac, 60Hz	James Yang
Peak To Average Ratio	24deg. C, 64%RH	120Vac, 60Hz	James Yang
Conducted Emission	24deg. C, 64%RH	120Vac, 60Hz	James Yang
Radiated Emission	25deg. C, 70%RH	120Vac, 60Hz	Noah Chang

3.4 EUT Operating Conditions

The EUT makes a call to the communication simulator. The communication simulator station system controlled a EUT to export maximum output power under transmission mode and specific channel frequency

3.5 General Description of Applied Standards

The EUT is a RF Product. According to the specifications of the manufacturer, it must comply with the requirements of the following standards:

FCC 47 CFR Part 2

FCC 47 CFR Part 24

KDB 971168 D01 Power Meas License Digital Systems v03r01

ANSI/TIA/EIA-603-E 2016

ANSI 63.26-2015

All test items have been performed and recorded as per the above standards.

4 Test Types and Results

4.1 Output Power Measurement

4.1.1 Limits of Output Power Measurement

Mobile / Portable station are limited to 2 watts e.r.p.

4.1.2 Test Procedures

EIRP / ERP Measurement:

- a. All measurements were done at low, middle and high operational frequency range. RBW and VBW is 5MHz for PCS/GPRS/EDGE/CDMA/WCDMA mode and 10MHz for LTE mode.
- b. Substitution method is used for E.I.R.P measurement. In the semi-anechoic chamber, EUT placed on the 0.8m(below or equal 1GHz) and/or 1.5m(above 1GHz) height of Turn Table, rotated the table around 360 degrees to search the maximum radiation power and receiver antenna shall be rotated vertical and horizontal polarization and moved height from 1m to 4m to find the maximum polar radiated power. The "Read Value" is the spectrum reading the maximum power value.
- c. The substitution horn antenna is substituted for EUT at the same position and signals generator export the CW signal to the substitution antenna via a TX cable. Rotated the Turn Table and moved receiving antenna to find the maximum radiation power. Adjust output power level of S.G to get a Value of spectrum reading equal to "Read Value" of step b. Record the power level of S.G
- d. EIRP = Output power level of S.G – TX cable loss + Antenna gain of substitution horn.E.R.P power can be calculated form E.I.R.P power by subtracting the gain of dipole, E.R.P power = E.I.R.P power - 2.15dBi.

Where:

$$ERP/EIRP = P_{Meas} + G_T - L_C$$

P_{Meas} : Measure transmitter output power.

G_T : Gain of the transmitting antenna.

L_C : signal attenuation in the connecting cable between the transmitter and antenna.

Conducted Power Measurement:

The EUT was set up for the maximum power with GSM, CDMA, WCDMA and LTE link data modulation and link up with simulator. Set the EUT to transmit under low, middle and high channel and record the power level shown on simulator.

4.1.3 Test Setup

EIRP / ERP Measurement:

For radiated emission 30MHz to 1GHz

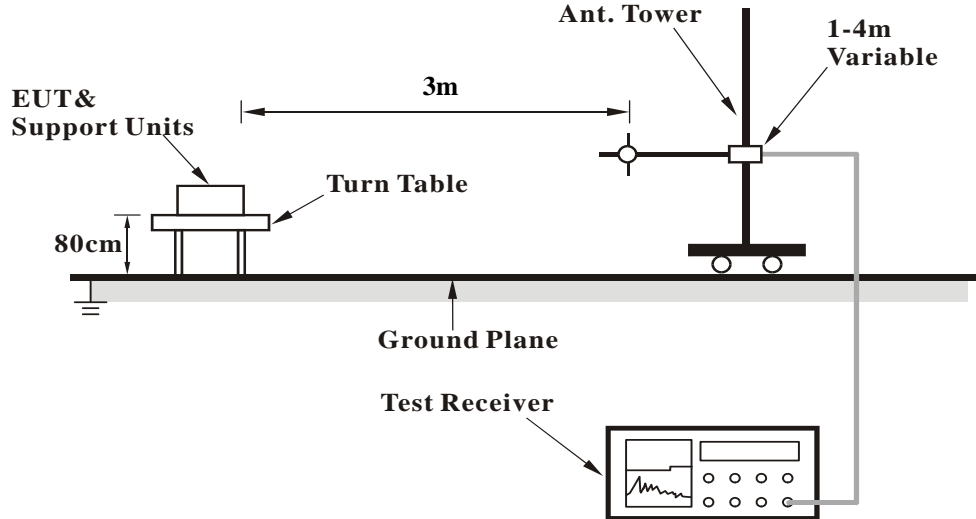

For radiated emission above 1GHz

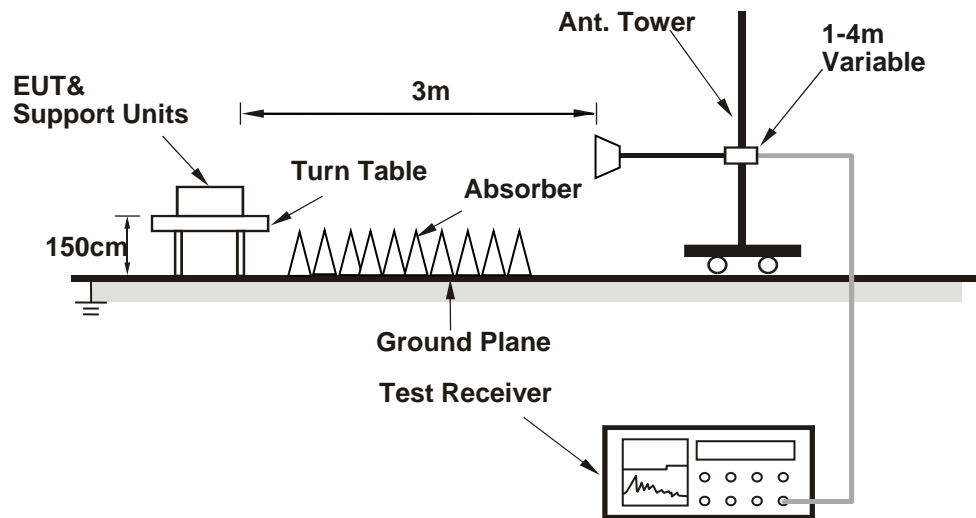

For the actual test configuration, please refer to the attached file (Test Setup Photo).

Conducted Power Measurement:



For the actual test configuration, please refer to the attached file (Test Setup Photo).

4.1.4 Test Results

Conducted Output Power (dBm)

Band	PCS1900		
Channel	512	661	810
Frequency	1850.2	1880	1909.8
PCS	29.47	29.34	29.49
GPRS 1Tx Slot	29.46	29.33	29.48
GPRS 2Tx Slot	28.81	28.68	28.83
GPRS 3Tx Slot	27.77	27.64	27.79
GPRS 4Tx Slot	25.47	25.34	25.49
DTM 9 (GPRS)	28.74	28.61	28.76
DTM 11 (GPRS)	27.75	27.62	27.77
EDGE 1Tx Slot (MCS9)	25.40	25.27	25.42
EDGE 2Tx Slot (MCS9)	24.78	24.65	24.80
EDGE 3Tx Slot (MCS9)	22.64	22.51	22.66
EDGE 4Tx Slot (MCS9)	20.44	20.31	20.46
DTM 9 (EDGE)	24.55	24.42	24.57
DTM 11 (EDGE)	22.62	22.49	22.64

Band	CDMA2000 BC1		
Channel	25	600	1175
Frequency (MHz)	1851.25	1880	1908.75
RC1+SO55	23.32	23.38	23.31
RC3+SO55	23.34	23.40	23.33
RC3+SO32(+ F-SCH)	23.31	23.37	23.30
RC3+SO32(+SCH)	23.26	23.32	23.25
RC1+SO3, 1/8 Rate	23.22	23.28	23.21
RTAP 153.6	23.19	23.25	23.18
RETAP 4096	23.16	23.22	23.15

Band	WCDMA II		
	9262	9400	9538
Channel	1852.4	1880	1907.6
Frequency	22.79	22.94	22.97
RMC 12.2K	22.21	22.36	22.39
HSDPA Subtest-1	22.13	22.28	22.31
HSDPA Subtest-2	21.66	21.81	21.84
HSDPA Subtest-3	21.62	21.77	21.80
DC-HSDPA Subtest-1	22.12	22.27	22.30
DC-HSDPA Subtest-2	22.04	22.19	22.22
DC-HSDPA Subtest-3	21.57	21.72	21.75
DC-HSDPA Subtest-4	21.53	21.68	21.71
HSUPA Subtest-1	22.09	22.24	22.27
HSUPA Subtest-2	20.01	20.16	20.19
HSUPA Subtest-3	21.08	21.23	21.26
HSUPA Subtest-4	20.00	20.15	20.18
HSUPA Subtest-5	22.06	22.21	22.24

LTE Band 2								
BW	MCS Index	RB Size	RB Offset	Low	Mid	High	3GPP MPR (dB)	Max. Tune-up (dBm)
		Channel		18700	18900	19100		
		Frequency (MHz)		1860	1880	1900		
20M	QPSK	1	0	23.42	23.53	23.44	0	24
		1	50	23.36	23.47	23.38	0	24
		1	99	23.24	23.35	23.26	0	24
		50	0	22.31	22.42	22.33	1	23
		50	25	22.28	22.39	22.30	1	23
		50	50	22.26	22.37	22.28	1	23
		100	0	22.29	22.40	22.31	1	23
	16QAM	1	0	22.39	22.50	22.41	1	23
		1	50	22.33	22.44	22.35	1	23
		1	99	22.21	22.32	22.23	1	23
		50	0	21.28	21.39	21.30	2	22
		50	25	21.25	21.36	21.27	2	22
		50	50	21.23	21.34	21.25	2	22
		100	0	21.26	21.37	21.28	2	22
BW	MCS Index	Channel		18675	18900	19125	3GPP MPR	Max. Tune-up
		Frequency (MHz)		1857.5	1880	1902.5		
15M	QPSK	1	0	23.36	23.47	23.38	0	24
		1	37	23.30	23.41	23.32	0	24
		1	74	23.18	23.29	23.20	0	24
		36	0	22.25	22.36	22.27	1	23
		36	19	22.22	22.33	22.24	1	23
		36	39	22.20	22.31	22.22	1	23
		75	0	22.23	22.34	22.25	1	23
	16QAM	1	0	22.33	22.44	22.35	1	23
		1	37	22.27	22.38	22.29	1	23
		1	74	22.15	22.26	22.17	1	23
		36	0	21.22	21.33	21.24	2	22
		36	19	21.19	21.30	21.21	2	22
		36	39	21.17	21.28	21.19	2	22
		75	0	21.20	21.31	21.22	2	22

LTE Band 2								
BW	MCS Index	Channel		18650	18900	19150	3GPP MPR	Max. Tune-up
		Frequency (MHz)		1855	1880	1905		
10M	QPSK	1	0	23.32	23.43	23.34	0	24
		1	24	23.26	23.37	23.28	0	24
		1	49	23.14	23.25	23.16	0	24
		25	0	22.21	22.32	22.23	1	23
		25	12	22.18	22.29	22.20	1	23
		25	25	22.16	22.27	22.18	1	23
		50	0	22.19	22.30	22.21	1	23
	16QAM	1	0	22.29	22.40	22.31	1	23
		1	24	22.23	22.34	22.25	1	23
		1	49	22.11	22.22	22.13	1	23
		25	0	21.18	21.29	21.20	2	22
		25	12	21.15	21.26	21.17	2	22
		25	25	21.13	21.24	21.15	2	22
		50	0	21.16	21.27	21.18	2	22
BW	MCS Index	Channel		18625	18900	19175	3GPP MPR	Max. Tune-up
		Frequency (MHz)		1852.5	1880	1907.5		
5M	QPSK	1	0	23.27	23.38	23.29	0	24
		1	12	23.21	23.32	23.23	0	24
		1	24	23.09	23.20	23.11	0	24
		12	0	22.16	22.27	22.18	1	23
		12	6	22.13	22.24	22.15	1	23
		12	13	22.11	22.22	22.13	1	23
		25	0	22.14	22.25	22.16	1	23
	16QAM	1	0	22.24	22.35	22.26	1	23
		1	12	22.18	22.29	22.20	1	23
		1	24	22.06	22.17	22.08	1	23
		12	0	21.13	21.24	21.15	2	22
		12	6	21.10	21.21	21.12	2	22
		12	13	21.08	21.19	21.10	2	22
		25	0	21.11	21.22	21.13	2	22

LTE Band 2								
BW	MCS Index	Channel		18615	18900	19185	3GPP MPR	Max. Tune-up
		Frequency (MHz)		1851.5	1880	1908.5		
3M	QPSK	1	0	23.29	23.40	23.31	0	24
		1	7	23.23	23.34	23.25	0	24
		1	14	23.11	23.22	23.13	0	24
		8	0	22.18	22.29	22.20	1	23
		8	3	22.15	22.26	22.17	1	23
		8	7	22.13	22.24	22.15	1	23
		15	0	22.16	22.27	22.18	1	23
	16QAM	1	0	22.26	22.37	22.28	1	23
		1	7	22.20	22.31	22.22	1	23
		1	14	22.08	22.19	22.10	1	23
		8	0	21.15	21.26	21.17	2	22
		8	3	21.12	21.23	21.14	2	22
		8	7	21.10	21.21	21.12	2	22
		15	0	21.13	21.24	21.15	2	22
BW	MCS Index	Channel		18607	18900	19193	3GPP MPR	Max. Tune-up
		Frequency (MHz)		1850.7	1880	1909.3		
1.4M	QPSK	1	0	23.26	23.37	23.28	0	24
		1	2	23.20	23.31	23.22	0	24
		1	5	23.08	23.19	23.10	0	24
		3	0	23.13	23.24	23.15	0	24
		3	1	23.10	23.21	23.12	0	24
		3	3	23.08	23.19	23.10	0	24
		6	0	22.13	22.24	22.15	1	23
	16QAM	1	0	22.23	22.34	22.25	1	23
		1	2	22.17	22.28	22.19	1	23
		1	5	22.05	22.16	22.07	1	23
		3	0	22.07	22.18	22.09	1	23
		3	1	22.04	22.15	22.06	1	23
		3	3	22.02	22.13	22.04	1	23
		6	0	21.10	21.21	21.12	2	22

LTE Band 25								
BW	MCS Index	RB Size	RB Offset	Low	Mid	High	3GPP MPR (dB)	Max. Tune-up (dBm)
		Channel		26140	26365	26590		
		Frequency (MHz)		1860	1882.5	1905		
20M	QPSK	1	0	23.45	23.34	23.31	0	24
		1	50	23.43	23.32	23.29	0	24
		1	99	23.27	23.16	23.13	0	24
		50	0	22.39	22.28	22.25	1	23
		50	25	22.36	22.25	22.22	1	23
		50	50	22.33	22.22	22.19	1	23
		100	0	22.37	22.26	22.23	1	23
	16QAM	1	0	22.44	22.33	22.30	1	23
		1	50	22.42	22.31	22.28	1	23
		1	99	22.26	22.15	22.12	1	23
		50	0	21.38	21.27	21.24	2	22
		50	25	21.35	21.24	21.21	2	22
		50	50	21.32	21.21	21.18	2	22
		100	0	21.36	21.25	21.22	2	22
BW	MCS Index	Channel		26115	26365	26615	3GPP MPR	Max. Tune-up
		Frequency (MHz)		1857.5	1882.5	1907.5		
15M	QPSK	1	0	23.40	23.29	23.26	0	24
		1	37	23.38	23.27	23.24	0	24
		1	74	23.22	23.11	23.08	0	24
		36	0	22.34	22.23	22.20	1	23
		36	19	22.31	22.20	22.17	1	23
		36	39	22.28	22.17	22.14	1	23
		75	0	22.32	22.21	22.18	1	23
	16QAM	1	0	22.39	22.28	22.25	1	23
		1	37	22.37	22.26	22.23	1	23
		1	74	22.21	22.10	22.07	1	23
		36	0	21.33	21.22	21.19	2	22
		36	19	21.30	21.19	21.16	2	22
		36	39	21.27	21.16	21.13	2	22
		75	0	21.31	21.20	21.17	2	22

LTE Band 25								
BW	MCS Index	Channel		26090	26365	26640	3GPP MPR	Max. Tune-up
		Frequency (MHz)		1855	1882.5	1910		
10M	QPSK	1	0	23.37	23.26	23.23	0	24
		1	24	23.35	23.24	23.21	0	24
		1	49	23.19	23.08	23.05	0	24
		25	0	22.31	22.20	22.17	1	23
		25	12	22.28	22.17	22.14	1	23
		25	25	22.25	22.14	22.11	1	23
		50	0	22.29	22.18	22.15	1	23
	16QAM	1	0	22.36	22.25	22.22	1	23
		1	24	22.34	22.23	22.20	1	23
		1	49	22.18	22.07	22.04	1	23
		25	0	21.30	21.19	21.16	2	22
		25	12	21.27	21.16	21.13	2	22
		25	25	21.24	21.13	21.10	2	22
		50	0	21.28	21.17	21.14	2	22
BW	MCS Index	Channel		26065	26365	26665	3GPP MPR	Max. Tune-up
		Frequency (MHz)		1852.5	1882.5	1912.5		
5M	QPSK	1	0	23.33	23.22	23.19	0	24
		1	12	23.31	23.20	23.17	0	24
		1	24	23.15	23.04	23.01	0	24
		12	0	22.27	22.16	22.13	1	23
		12	6	22.24	22.13	22.10	1	23
		12	13	22.21	22.10	22.07	1	23
		25	0	22.25	22.14	22.11	1	23
	16QAM	1	0	22.32	22.21	22.18	1	23
		1	12	22.30	22.19	22.16	1	23
		1	24	22.14	22.03	22.00	1	23
		12	0	21.26	21.15	21.12	2	22
		12	6	21.23	21.12	21.09	2	22
		12	13	21.20	21.09	21.06	2	22
		25	0	21.24	21.13	21.10	2	22

LTE Band 25								
BW	MCS Index	Channel		26055	26365	26675	3GPP MPR	Max. Tune-up
		Frequency (MHz)		1851.5	1882.5	1913.5		
3M	QPSK	1	0	23.29	23.18	23.15	0	24
		1	7	23.27	23.16	23.13	0	24
		1	14	23.11	23.00	22.97	0	24
		8	0	22.23	22.12	22.09	1	23
		8	3	22.20	22.09	22.06	1	23
		8	7	22.17	22.06	22.03	1	23
		15	0	22.21	22.10	22.07	1	23
	16QAM	1	0	22.28	22.17	22.14	1	23
		1	7	22.26	22.15	22.12	1	23
		1	14	22.10	21.99	21.96	1	23
		8	0	21.22	21.11	21.08	2	22
		8	3	21.19	21.08	21.05	2	22
		8	7	21.16	21.05	21.02	2	22
		15	0	21.20	21.09	21.06	2	22
BW	MCS Index	Channel		26047	26365	26683	3GPP MPR	Max. Tune-up
		Frequency (MHz)		1850.7	1882.5	1914.3		
1.4M	QPSK	1	0	23.35	23.24	23.21	0	24
		1	2	23.33	23.22	23.19	0	24
		1	5	23.17	23.06	23.03	0	24
		3	0	23.24	23.13	23.10	0	24
		3	1	23.21	23.10	23.07	0	24
		3	3	23.18	23.07	23.04	0	24
		6	0	22.27	22.16	22.13	1	23
	16QAM	1	0	22.34	22.23	22.20	1	23
		1	2	22.32	22.21	22.18	1	23
		1	5	22.16	22.05	22.02	1	23
		3	0	22.23	22.12	22.09	1	23
		3	1	22.20	22.09	22.06	1	23
		3	3	22.17	22.06	22.03	1	23
		6	0	21.26	21.15	21.12	2	22

EIRP Power

PCS Mode

MODE		TX channel 512					
Antenna Polarity & Test Distance: Horizontal at 3 M							
No.	Freq. (MHz)	Reading (dBm)	S.G Power Value (dBm)	Correction Factor (dB)	EIRP (dBm)	Limit (dBm)	Margin (dB)
1	1850.20	-23.7	15.2	1.0	16.2	33.0	-16.8
Antenna Polarity & Test Distance: Vertical at 3 M							
No.	Freq. (MHz)	Reading (dBm)	S.G Power Value (dBm)	Correction Factor (dB)	EIRP (dBm)	Limit (dBm)	Margin (dB)
1	1850.20	-13.0	25.4	1.0	26.4	33.0	-6.6

MODE		TX channel 661					
Antenna Polarity & Test Distance: Horizontal at 3 M							
No.	Freq. (MHz)	Reading (dBm)	S.G Power Value (dBm)	Correction Factor (dB)	EIRP (dBm)	Limit (dBm)	Margin (dB)
1	1880.00	-22.8	16.5	1.1	17.6	33.0	-15.4
Antenna Polarity & Test Distance: Vertical at 3 M							
No.	Freq. (MHz)	Reading (dBm)	S.G Power Value (dBm)	Correction Factor (dB)	EIRP (dBm)	Limit (dBm)	Margin (dB)
1	1880.00	-14.6	23.8	1.1	24.9	33.0	-8.1

MODE		TX channel 810					
Antenna Polarity & Test Distance: Horizontal at 3 M							
No.	Freq. (MHz)	Reading (dBm)	S.G Power Value (dBm)	Correction Factor (dB)	EIRP (dBm)	Limit (dBm)	Margin (dB)
1	1909.80	-23.2	16.5	1.1	17.6	33.0	-15.4
Antenna Polarity & Test Distance: Vertical at 3 M							
No.	Freq. (MHz)	Reading (dBm)	S.G Power Value (dBm)	Correction Factor (dB)	EIRP (dBm)	Limit (dBm)	Margin (dB)
1	1909.80	-14.9	23.6	1.1	24.7	33.0	-8.3

Note: EIRP (dBm) = S.G Power Value (dBm) + Correction Factor (dB).

CDMA

MODE		TX channel 25					
Antenna Polarity & Test Distance: Horizontal at 3 M							
No.	Freq. (MHz)	Reading (dBm)	S.G Power Value (dBm)	Correction Factor (dB)	EIRP (dBm)	Limit (dBm)	Margin (dB)
1	1851.25	-18.8	21.1	1.0	22.1	33.0	-10.9
Antenna Polarity & Test Distance: Vertical at 3 M							
No.	Freq. (MHz)	Reading (dBm)	S.G Power Value (dBm)	Correction Factor (dB)	EIRP (dBm)	Limit (dBm)	Margin (dB)
1	1851.25	-15.3	23.5	1.0	24.5	33.0	-8.5

MODE		TX channel 600					
Antenna Polarity & Test Distance: Horizontal at 3 M							
No.	Freq. (MHz)	Reading (dBm)	S.G Power Value (dBm)	Correction Factor (dB)	EIRP (dBm)	Limit (dBm)	Margin (dB)
1	1880.00	-18.8	21.3	1.1	22.4	33.0	-10.6
Antenna Polarity & Test Distance: Vertical at 3 M							
No.	Freq. (MHz)	Reading (dBm)	S.G Power Value (dBm)	Correction Factor (dB)	EIRP (dBm)	Limit (dBm)	Margin (dB)
1	1880.00	-15.0	23.5	1.1	24.6	33.0	-8.4

MODE		TX channel 1175					
Antenna Polarity & Test Distance: Horizontal at 3 M							
No.	Freq. (MHz)	Reading (dBm)	S.G Power Value (dBm)	Correction Factor (dB)	EIRP (dBm)	Limit (dBm)	Margin (dB)
1	1908.75	-19.4	21.0	1.1	22.1	33.0	-10.9
Antenna Polarity & Test Distance: Vertical at 3 M							
No.	Freq. (MHz)	Reading (dBm)	S.G Power Value (dBm)	Correction Factor (dB)	EIRP (dBm)	Limit (dBm)	Margin (dB)
1	1908.75	-14.7	23.7	1.1	24.8	33.0	-8.2

Note: EIRP (dBm) = S.G Power Value (dBm) + Correction Factor (dB).

WCDMA Band 2

MODE		TX channel 9262					
Antenna Polarity & Test Distance: Horizontal at 3 M							
No.	Freq. (MHz)	Reading (dBm)	S.G Power Value (dBm)	Correction Factor (dB)	EIRP (dBm)	Limit (dBm)	Margin (dB)
1	1852.00	-21.5	17.4	1.0	18.4	33.0	-14.6
Antenna Polarity & Test Distance: Vertical at 3 M							
No.	Freq. (MHz)	Reading (dBm)	S.G Power Value (dBm)	Correction Factor (dB)	EIRP (dBm)	Limit (dBm)	Margin (dB)
1	1852.40	-14.7	23.7	1.0	24.7	33.0	-8.3

MODE		TX channel 9400					
Antenna Polarity & Test Distance: Horizontal at 3 M							
No.	Freq. (MHz)	Reading (dBm)	S.G Power Value (dBm)	Correction Factor (dB)	EIRP (dBm)	Limit (dBm)	Margin (dB)
1	1880.00	-22.2	17.1	1.1	18.2	33.0	-14.8
Antenna Polarity & Test Distance: Vertical at 3 M							
No.	Freq. (MHz)	Reading (dBm)	S.G Power Value (dBm)	Correction Factor (dB)	EIRP (dBm)	Limit (dBm)	Margin (dB)
1	1880.00	-13.9	24.5	1.1	25.6	33.0	-7.4

MODE		TX channel 9538					
Antenna Polarity & Test Distance: Horizontal at 3 M							
No.	Freq. (MHz)	Reading (dBm)	S.G Power Value (dBm)	Correction Factor (dB)	EIRP (dBm)	Limit (dBm)	Margin (dB)
1	1907.60	-21.7	18.0	1.1	19.1	33.0	-13.9
Antenna Polarity & Test Distance: Vertical at 3 M							
No.	Freq. (MHz)	Reading (dBm)	S.G Power Value (dBm)	Correction Factor (dB)	EIRP (dBm)	Limit (dBm)	Margin (dB)
1	1907.60	-14.3	24.2	1.1	25.3	33.0	-7.7

Note: EIRP (dBm) = S.G Power Value (dBm) + Correction Factor (dB).

Modulation Type: QPSK

LTE Band 2, Channel Bandwidth 1.4MHz

MODE		TX channel 18607					
Antenna Polarity & Test Distance: Horizontal at 3 M							
No.	Freq. (MHz)	Reading (dBm)	S.G Power Value (dBm)	Correction Factor (dB)	EIRP (dBm)	Limit (dBm)	Margin (dB)
1	1850.70	-19.54	20.30	1.07	21.37	33.00	-11.63
Antenna Polarity & Test Distance: Vertical at 3 M							
No.	Freq. (MHz)	Reading (dBm)	S.G Power Value (dBm)	Correction Factor (dB)	EIRP (dBm)	Limit (dBm)	Margin (dB)
1	1850.70	-14.05	24.69	1.07	25.76	33.00	-7.24

MODE		TX channel 18900					
Antenna Polarity & Test Distance: Horizontal at 3 M							
No.	Freq. (MHz)	Reading (dBm)	S.G Power Value (dBm)	Correction Factor (dB)	EIRP (dBm)	Limit (dBm)	Margin (dB)
1	1880.00	-18.34	21.79	1.12	22.91	33.00	-10.09
Antenna Polarity & Test Distance: Vertical at 3 M							
No.	Freq. (MHz)	Reading (dBm)	S.G Power Value (dBm)	Correction Factor (dB)	EIRP (dBm)	Limit (dBm)	Margin (dB)
1	1880.00	-14.60	23.88	1.12	25.00	33.00	-8.00

MODE		TX channel 19193					
Antenna Polarity & Test Distance: Horizontal at 3 M							
No.	Freq. (MHz)	Reading (dBm)	S.G Power Value (dBm)	Correction Factor (dB)	EIRP (dBm)	Limit (dBm)	Margin (dB)
1	1909.30	-18.21	22.21	1.11	23.32	33.00	-9.68
Antenna Polarity & Test Distance: Vertical at 3 M							
No.	Freq. (MHz)	Reading (dBm)	S.G Power Value (dBm)	Correction Factor (dB)	EIRP (dBm)	Limit (dBm)	Margin (dB)
1	1909.30	-14.25	24.16	1.11	25.27	33.00	-7.73

Note: EIRP (dBm) = S.G Power Value (dBm) + Correction Factor (dB).

LTE Band 2, Channel Bandwidth 3MHz

MODE		TX channel 18615					
Antenna Polarity & Test Distance: Horizontal at 3 M							
No.	Freq. (MHz)	Reading (dBm)	S.G Power Value (dBm)	Correction Factor (dB)	EIRP (dBm)	Limit (dBm)	Margin (dB)
1	1851.50	-18.32	21.52	1.07	22.59	33.00	-10.41
Antenna Polarity & Test Distance: Vertical at 3 M							
No.	Freq. (MHz)	Reading (dBm)	S.G Power Value (dBm)	Correction Factor (dB)	EIRP (dBm)	Limit (dBm)	Margin (dB)
1	1851.50	-14.92	23.82	1.07	24.89	33.00	-8.11

MODE		TX channel 18900					
Antenna Polarity & Test Distance: Horizontal at 3 M							
No.	Freq. (MHz)	Reading (dBm)	S.G Power Value (dBm)	Correction Factor (dB)	EIRP (dBm)	Limit (dBm)	Margin (dB)
1	1880.00	-17.92	22.21	1.12	23.33	33.00	-9.67
Antenna Polarity & Test Distance: Vertical at 3 M							
No.	Freq. (MHz)	Reading (dBm)	S.G Power Value (dBm)	Correction Factor (dB)	EIRP (dBm)	Limit (dBm)	Margin (dB)
1	1880.00	-14.70	23.78	1.12	24.90	33.00	-8.10

MODE		TX channel 19185					
Antenna Polarity & Test Distance: Horizontal at 3 M							
No.	Freq. (MHz)	Reading (dBm)	S.G Power Value (dBm)	Correction Factor (dB)	EIRP (dBm)	Limit (dBm)	Margin (dB)
1	1908.50	-18.36	22.05	1.11	23.16	33.00	-9.84
Antenna Polarity & Test Distance: Vertical at 3 M							
No.	Freq. (MHz)	Reading (dBm)	S.G Power Value (dBm)	Correction Factor (dB)	EIRP (dBm)	Limit (dBm)	Margin (dB)
1	1908.50	-14.96	23.45	1.11	24.56	33.00	-8.44

Note: EIRP (dBm) = S.G Power Value (dBm) + Correction Factor (dB).

LTE Band 2, Channel Bandwidth 5MHz

MODE		TX channel 18625					
Antenna Polarity & Test Distance: Horizontal at 3 M							
No.	Freq. (MHz)	Reading (dBm)	S.G Power Value (dBm)	Correction Factor (dB)	EIRP (dBm)	Limit (dBm)	Margin (dB)
1	1852.50	-18.15	21.71	1.07	22.78	33.00	-10.22
Antenna Polarity & Test Distance: Vertical at 3 M							
No.	Freq. (MHz)	Reading (dBm)	S.G Power Value (dBm)	Correction Factor (dB)	EIRP (dBm)	Limit (dBm)	Margin (dB)
1	1852.50	-15.23	23.50	1.07	24.57	33.00	-8.43

MODE		TX channel 18900					
Antenna Polarity & Test Distance: Horizontal at 3 M							
No.	Freq. (MHz)	Reading (dBm)	S.G Power Value (dBm)	Correction Factor (dB)	EIRP (dBm)	Limit (dBm)	Margin (dB)
1	1880.00	-18.63	21.50	1.12	22.62	33.00	-10.38
Antenna Polarity & Test Distance: Vertical at 3 M							
No.	Freq. (MHz)	Reading (dBm)	S.G Power Value (dBm)	Correction Factor (dB)	EIRP (dBm)	Limit (dBm)	Margin (dB)
1	1880.00	-14.35	24.13	1.12	25.25	33.00	-7.75

MODE		TX channel 19175					
Antenna Polarity & Test Distance: Horizontal at 3 M							
No.	Freq. (MHz)	Reading (dBm)	S.G Power Value (dBm)	Correction Factor (dB)	EIRP (dBm)	Limit (dBm)	Margin (dB)
1	1907.50	-17.86	22.55	1.11	23.66	33.00	-9.34
Antenna Polarity & Test Distance: Vertical at 3 M							
No.	Freq. (MHz)	Reading (dBm)	S.G Power Value (dBm)	Correction Factor (dB)	EIRP (dBm)	Limit (dBm)	Margin (dB)
1	1907.50	-15.12	23.28	1.11	24.39	33.00	-8.61

Note: EIRP (dBm) = S.G Power Value (dBm) + Correction Factor (dB).

LTE Band 2, Channel Bandwidth 10MHz

MODE		TX channel 18650					
Antenna Polarity & Test Distance: Horizontal at 3 M							
No.	Freq. (MHz)	Reading (dBm)	S.G Power Value (dBm)	Correction Factor (dB)	EIRP (dBm)	Limit (dBm)	Margin (dB)
1	1855.00	-18.42	21.46	1.08	22.54	33.00	-10.46
Antenna Polarity & Test Distance: Vertical at 3 M							
No.	Freq. (MHz)	Reading (dBm)	S.G Power Value (dBm)	Correction Factor (dB)	EIRP (dBm)	Limit (dBm)	Margin (dB)
1	1855.00	-15.32	23.38	1.08	24.46	33.00	-8.54

MODE		TX channel 18900					
Antenna Polarity & Test Distance: Horizontal at 3 M							
No.	Freq. (MHz)	Reading (dBm)	S.G Power Value (dBm)	Correction Factor (dB)	EIRP (dBm)	Limit (dBm)	Margin (dB)
1	1880.00	-17.88	22.25	1.12	23.37	33.00	-9.63
Antenna Polarity & Test Distance: Vertical at 3 M							
No.	Freq. (MHz)	Reading (dBm)	S.G Power Value (dBm)	Correction Factor (dB)	EIRP (dBm)	Limit (dBm)	Margin (dB)
1	1880.00	-15.12	23.36	1.12	24.48	33.00	-8.52

MODE		TX channel 19150					
Antenna Polarity & Test Distance: Horizontal at 3 M							
No.	Freq. (MHz)	Reading (dBm)	S.G Power Value (dBm)	Correction Factor (dB)	EIRP (dBm)	Limit (dBm)	Margin (dB)
1	1905.00	-18.39	22.01	1.11	23.12	33.00	-9.88
Antenna Polarity & Test Distance: Vertical at 3 M							
No.	Freq. (MHz)	Reading (dBm)	S.G Power Value (dBm)	Correction Factor (dB)	EIRP (dBm)	Limit (dBm)	Margin (dB)
1	1905.00	-14.78	23.60	1.11	24.71	33.00	-8.29

Note: EIRP (dBm) = S.G Power Value (dBm) + Correction Factor (dB).

LTE Band 2, Channel Bandwidth 15MHz

MODE		TX channel 18675					
Antenna Polarity & Test Distance: Horizontal at 3 M							
No.	Freq. (MHz)	Reading (dBm)	S.G Power Value (dBm)	Correction Factor (dB)	EIRP (dBm)	Limit (dBm)	Margin (dB)
1	1857.50	-18.31	21.60	1.08	22.68	33.00	-10.32
Antenna Polarity & Test Distance: Vertical at 3 M							
No.	Freq. (MHz)	Reading (dBm)	S.G Power Value (dBm)	Correction Factor (dB)	EIRP (dBm)	Limit (dBm)	Margin (dB)
1	1857.50	-15.33	23.35	1.08	24.43	33.00	-8.57

MODE		TX channel 18900					
Antenna Polarity & Test Distance: Horizontal at 3 M							
No.	Freq. (MHz)	Reading (dBm)	S.G Power Value (dBm)	Correction Factor (dB)	EIRP (dBm)	Limit (dBm)	Margin (dB)
1	1880.00	-18.21	21.92	1.12	23.04	33.00	-9.96
Antenna Polarity & Test Distance: Vertical at 3 M							
No.	Freq. (MHz)	Reading (dBm)	S.G Power Value (dBm)	Correction Factor (dB)	EIRP (dBm)	Limit (dBm)	Margin (dB)
1	1880.00	-14.59	23.89	1.12	25.01	33.00	-7.99

MODE		TX channel 19125					
Antenna Polarity & Test Distance: Horizontal at 3 M							
No.	Freq. (MHz)	Reading (dBm)	S.G Power Value (dBm)	Correction Factor (dB)	EIRP (dBm)	Limit (dBm)	Margin (dB)
1	1902.50	-18.63	21.76	1.11	22.87	33.00	-10.13
Antenna Polarity & Test Distance: Vertical at 3 M							
No.	Freq. (MHz)	Reading (dBm)	S.G Power Value (dBm)	Correction Factor (dB)	EIRP (dBm)	Limit (dBm)	Margin (dB)
1	1902.50	-15.56	22.80	1.11	23.91	33.00	-9.09

Note: EIRP (dBm) = S.G Power Value (dBm) + Correction Factor (dB).

LTE Band 2, Channel Bandwidth 20MHz

MODE		TX channel 18700					
Antenna Polarity & Test Distance: Horizontal at 3 M							
No.	Freq. (MHz)	Reading (dBm)	S.G Power Value (dBm)	Correction Factor (dB)	EIRP (dBm)	Limit (dBm)	Margin (dB)
1	1860.00	-18.48	21.44	1.09	22.53	33.00	-10.47
Antenna Polarity & Test Distance: Vertical at 3 M							
No.	Freq. (MHz)	Reading (dBm)	S.G Power Value (dBm)	Correction Factor (dB)	EIRP (dBm)	Limit (dBm)	Margin (dB)
1	1860.00	-14.90	23.75	1.09	24.84	33.00	-8.16

MODE		TX channel 18900					
Antenna Polarity & Test Distance: Horizontal at 3 M							
No.	Freq. (MHz)	Reading (dBm)	S.G Power Value (dBm)	Correction Factor (dB)	EIRP (dBm)	Limit (dBm)	Margin (dB)
1	1880.00	-17.83	22.30	1.12	23.42	33.00	-9.58
Antenna Polarity & Test Distance: Vertical at 3 M							
No.	Freq. (MHz)	Reading (dBm)	S.G Power Value (dBm)	Correction Factor (dB)	EIRP (dBm)	Limit (dBm)	Margin (dB)
1	1880.00	-15.22	23.26	1.12	24.38	33.00	-8.62

MODE		TX channel 19100					
Antenna Polarity & Test Distance: Horizontal at 3 M							
No.	Freq. (MHz)	Reading (dBm)	S.G Power Value (dBm)	Correction Factor (dB)	EIRP (dBm)	Limit (dBm)	Margin (dB)
1	1900.00	-18.03	22.34	1.11	23.45	33.00	-9.55
Antenna Polarity & Test Distance: Vertical at 3 M							
No.	Freq. (MHz)	Reading (dBm)	S.G Power Value (dBm)	Correction Factor (dB)	EIRP (dBm)	Limit (dBm)	Margin (dB)
1	1900.00	-15.63	22.71	1.11	23.82	33.00	-9.18

Note: EIRP (dBm) = S.G Power Value (dBm) + Correction Factor (dB).

LTE Band 25, Channel Bandwidth 1.4MHz

MODE		TX channel 26047					
Antenna Polarity & Test Distance: Horizontal at 3 M							
No.	Freq. (MHz)	Reading (dBm)	S.G Power Value (dBm)	Correction Factor (dB)	EIRP (dBm)	Limit (dBm)	Margin (dB)
1	1850.70	-17.89	21.95	1.07	23.02	33.00	-9.98
Antenna Polarity & Test Distance: Vertical at 3 M							
No.	Freq. (MHz)	Reading (dBm)	S.G Power Value (dBm)	Correction Factor (dB)	EIRP (dBm)	Limit (dBm)	Margin (dB)
1	1850.70	-15.72	23.02	1.07	24.09	33.00	-8.91

MODE		TX channel 26365					
Antenna Polarity & Test Distance: Horizontal at 3 M							
No.	Freq. (MHz)	Reading (dBm)	S.G Power Value (dBm)	Correction Factor (dB)	EIRP (dBm)	Limit (dBm)	Margin (dB)
1	1882.50	-18.23	21.93	1.12	23.05	33.00	-9.95
Antenna Polarity & Test Distance: Vertical at 3 M							
No.	Freq. (MHz)	Reading (dBm)	S.G Power Value (dBm)	Correction Factor (dB)	EIRP (dBm)	Limit (dBm)	Margin (dB)
1	1882.50	-15.62	22.84	1.12	23.96	33.00	-9.04

MODE		TX channel 26683					
Antenna Polarity & Test Distance: Horizontal at 3 M							
No.	Freq. (MHz)	Reading (dBm)	S.G Power Value (dBm)	Correction Factor (dB)	EIRP (dBm)	Limit (dBm)	Margin (dB)
1	1914.30	-18.12	22.66	0.77	23.43	33.00	-9.57
Antenna Polarity & Test Distance: Vertical at 3 M							
No.	Freq. (MHz)	Reading (dBm)	S.G Power Value (dBm)	Correction Factor (dB)	EIRP (dBm)	Limit (dBm)	Margin (dB)
1	1914.30	-15.32	23.47	0.77	24.24	33.00	-8.76

Note: EIRP (dBm) = S.G Power Value (dBm) + Correction Factor (dB).

LTE Band 25, Channel Bandwidth 3MHz

MODE		TX channel 26055					
Antenna Polarity & Test Distance: Horizontal at 3 M							
No.	Freq. (MHz)	Reading (dBm)	S.G Power Value (dBm)	Correction Factor (dB)	EIRP (dBm)	Limit (dBm)	Margin (dB)
1	1851.50	-17.83	22.01	1.07	23.08	33.00	-9.92
Antenna Polarity & Test Distance: Vertical at 3 M							
No.	Freq. (MHz)	Reading (dBm)	S.G Power Value (dBm)	Correction Factor (dB)	EIRP (dBm)	Limit (dBm)	Margin (dB)
1	1851.50	-15.74	23.00	1.07	24.07	33.00	-8.93

MODE		TX channel 26365					
Antenna Polarity & Test Distance: Horizontal at 3 M							
No.	Freq. (MHz)	Reading (dBm)	S.G Power Value (dBm)	Correction Factor (dB)	EIRP (dBm)	Limit (dBm)	Margin (dB)
1	1882.50	-18.60	21.56	1.12	22.68	33.00	-10.32
Antenna Polarity & Test Distance: Vertical at 3 M							
No.	Freq. (MHz)	Reading (dBm)	S.G Power Value (dBm)	Correction Factor (dB)	EIRP (dBm)	Limit (dBm)	Margin (dB)
1	1882.50	-15.09	23.37	1.12	24.49	33.00	-8.51

MODE		TX channel 26675					
Antenna Polarity & Test Distance: Horizontal at 3 M							
No.	Freq. (MHz)	Reading (dBm)	S.G Power Value (dBm)	Correction Factor (dB)	EIRP (dBm)	Limit (dBm)	Margin (dB)
1	1913.50	-17.88	22.89	0.77	23.66	33.00	-9.34
Antenna Polarity & Test Distance: Vertical at 3 M							
No.	Freq. (MHz)	Reading (dBm)	S.G Power Value (dBm)	Correction Factor (dB)	EIRP (dBm)	Limit (dBm)	Margin (dB)
1	1913.50	-15.21	23.58	0.77	24.35	33.00	-8.65

Note: EIRP (dBm) = S.G Power Value (dBm) + Correction Factor (dB).

LTE Band 25, Channel Bandwidth 5MHz

MODE		TX channel 26065					
Antenna Polarity & Test Distance: Horizontal at 3 M							
No.	Freq. (MHz)	Reading (dBm)	S.G Power Value (dBm)	Correction Factor (dB)	EIRP (dBm)	Limit (dBm)	Margin (dB)
1	1852.50	-18.29	21.57	1.07	22.64	33.00	-10.36
Antenna Polarity & Test Distance: Vertical at 3 M							
No.	Freq. (MHz)	Reading (dBm)	S.G Power Value (dBm)	Correction Factor (dB)	EIRP (dBm)	Limit (dBm)	Margin (dB)
1	1852.50	-15.71	23.02	1.07	24.09	33.00	-8.91

MODE		TX channel 26365					
Antenna Polarity & Test Distance: Horizontal at 3 M							
No.	Freq. (MHz)	Reading (dBm)	S.G Power Value (dBm)	Correction Factor (dB)	EIRP (dBm)	Limit (dBm)	Margin (dB)
1	1882.50	-18.17	21.99	1.12	23.11	33.00	-9.89
Antenna Polarity & Test Distance: Vertical at 3 M							
No.	Freq. (MHz)	Reading (dBm)	S.G Power Value (dBm)	Correction Factor (dB)	EIRP (dBm)	Limit (dBm)	Margin (dB)
1	1882.50	-15.67	22.79	1.12	23.91	33.00	-9.09

MODE		TX channel 26665					
Antenna Polarity & Test Distance: Horizontal at 3 M							
No.	Freq. (MHz)	Reading (dBm)	S.G Power Value (dBm)	Correction Factor (dB)	EIRP (dBm)	Limit (dBm)	Margin (dB)
1	1912.50	-18.12	22.65	0.77	23.42	33.00	-9.58
Antenna Polarity & Test Distance: Vertical at 3 M							
No.	Freq. (MHz)	Reading (dBm)	S.G Power Value (dBm)	Correction Factor (dB)	EIRP (dBm)	Limit (dBm)	Margin (dB)
1	1912.50	-16.12	22.66	0.77	23.43	33.00	-9.57

Note: EIRP (dBm) = S.G Power Value (dBm) + Correction Factor (dB).

LTE Band 25, Channel Bandwidth 10MHz

MODE		TX channel 26090					
Antenna Polarity & Test Distance: Horizontal at 3 M							
No.	Freq. (MHz)	Reading (dBm)	S.G Power Value (dBm)	Correction Factor (dB)	EIRP (dBm)	Limit (dBm)	Margin (dB)
1	1855.00	-17.48	22.40	1.08	23.48	33.00	-9.52
Antenna Polarity & Test Distance: Vertical at 3 M							
No.	Freq. (MHz)	Reading (dBm)	S.G Power Value (dBm)	Correction Factor (dB)	EIRP (dBm)	Limit (dBm)	Margin (dB)
1	1855.00	-15.88	22.82	1.08	23.90	33.00	-9.10

MODE		TX channel 26365					
Antenna Polarity & Test Distance: Horizontal at 3 M							
No.	Freq. (MHz)	Reading (dBm)	S.G Power Value (dBm)	Correction Factor (dB)	EIRP (dBm)	Limit (dBm)	Margin (dB)
1	1882.50	-17.96	22.20	1.12	23.32	33.00	-9.68
Antenna Polarity & Test Distance: Vertical at 3 M							
No.	Freq. (MHz)	Reading (dBm)	S.G Power Value (dBm)	Correction Factor (dB)	EIRP (dBm)	Limit (dBm)	Margin (dB)
1	1882.50	-15.73	22.73	1.12	23.85	33.00	-9.15

MODE		TX channel 26640					
Antenna Polarity & Test Distance: Horizontal at 3 M							
No.	Freq. (MHz)	Reading (dBm)	S.G Power Value (dBm)	Correction Factor (dB)	EIRP (dBm)	Limit (dBm)	Margin (dB)
1	1910.00	-17.87	22.89	0.77	23.66	33.00	-9.34
Antenna Polarity & Test Distance: Vertical at 3 M							
No.	Freq. (MHz)	Reading (dBm)	S.G Power Value (dBm)	Correction Factor (dB)	EIRP (dBm)	Limit (dBm)	Margin (dB)
1	1910.00	-16.37	22.39	0.77	23.16	33.00	-9.84

Note: EIRP (dBm) = S.G Power Value (dBm) + Correction Factor (dB).

LTE Band 25, Channel Bandwidth 15MHz

MODE		TX channel 26115					
Antenna Polarity & Test Distance: Horizontal at 3 M							
No.	Freq. (MHz)	Reading (dBm)	S.G Power Value (dBm)	Correction Factor (dB)	EIRP (dBm)	Limit (dBm)	Margin (dB)
1	1857.50	-18.03	21.88	1.08	22.96	33.00	-10.04
Antenna Polarity & Test Distance: Vertical at 3 M							
No.	Freq. (MHz)	Reading (dBm)	S.G Power Value (dBm)	Correction Factor (dB)	EIRP (dBm)	Limit (dBm)	Margin (dB)
1	1857.50	-15.97	22.71	1.08	23.79	33.00	-9.21

MODE		TX channel 26365					
Antenna Polarity & Test Distance: Horizontal at 3 M							
No.	Freq. (MHz)	Reading (dBm)	S.G Power Value (dBm)	Correction Factor (dB)	EIRP (dBm)	Limit (dBm)	Margin (dB)
1	1882.50	-17.77	22.39	1.12	23.51	33.00	-9.49
Antenna Polarity & Test Distance: Vertical at 3 M							
No.	Freq. (MHz)	Reading (dBm)	S.G Power Value (dBm)	Correction Factor (dB)	EIRP (dBm)	Limit (dBm)	Margin (dB)
1	1882.50	-15.26	23.20	1.12	24.32	33.00	-8.68

MODE		TX channel 26615					
Antenna Polarity & Test Distance: Horizontal at 3 M							
No.	Freq. (MHz)	Reading (dBm)	S.G Power Value (dBm)	Correction Factor (dB)	EIRP (dBm)	Limit (dBm)	Margin (dB)
1	1907.50	-18.00	22.41	1.11	23.52	33.00	-9.48
Antenna Polarity & Test Distance: Vertical at 3 M							
No.	Freq. (MHz)	Reading (dBm)	S.G Power Value (dBm)	Correction Factor (dB)	EIRP (dBm)	Limit (dBm)	Margin (dB)
1	1907.50	-15.44	22.96	1.11	24.07	33.00	-8.93

Note: EIRP (dBm) = S.G Power Value (dBm) + Correction Factor (dB).

LTE Band 25, Channel Bandwidth 20MHz

MODE		TX channel 26140					
Antenna Polarity & Test Distance: Horizontal at 3 M							
No.	Freq. (MHz)	Reading (dBm)	S.G Power Value (dBm)	Correction Factor (dB)	EIRP (dBm)	Limit (dBm)	Margin (dB)
1	1860.00	-17.72	22.20	1.09	23.29	33.00	-9.71
Antenna Polarity & Test Distance: Vertical at 3 M							
No.	Freq. (MHz)	Reading (dBm)	S.G Power Value (dBm)	Correction Factor (dB)	EIRP (dBm)	Limit (dBm)	Margin (dB)
1	1860.00	-15.15	23.50	1.09	24.59	33.00	-8.41

MODE		TX channel 26365					
Antenna Polarity & Test Distance: Horizontal at 3 M							
No.	Freq. (MHz)	Reading (dBm)	S.G Power Value (dBm)	Correction Factor (dB)	EIRP (dBm)	Limit (dBm)	Margin (dB)
1	1882.50	-17.79	22.37	1.12	23.49	33.00	-9.51
Antenna Polarity & Test Distance: Vertical at 3 M							
No.	Freq. (MHz)	Reading (dBm)	S.G Power Value (dBm)	Correction Factor (dB)	EIRP (dBm)	Limit (dBm)	Margin (dB)
1	1882.50	-15.43	23.03	1.12	24.15	33.00	-8.85

MODE		TX channel 26590					
Antenna Polarity & Test Distance: Horizontal at 3 M							
No.	Freq. (MHz)	Reading (dBm)	S.G Power Value (dBm)	Correction Factor (dB)	EIRP (dBm)	Limit (dBm)	Margin (dB)
1	1905.00	-17.51	22.89	1.11	24.00	33.00	-9.00
Antenna Polarity & Test Distance: Vertical at 3 M							
No.	Freq. (MHz)	Reading (dBm)	S.G Power Value (dBm)	Correction Factor (dB)	EIRP (dBm)	Limit (dBm)	Margin (dB)
1	1905.00	-15.11	23.27	1.11	24.38	33.00	-8.62

Note: EIRP (dBm) = S.G Power Value (dBm) + Correction Factor (dB).

Modulation Type: 16QAM

LTE Band 2, Channel Bandwidth 1.4MHz

MODE		TX channel 18607					
Antenna Polarity & Test Distance: Horizontal at 3 M							
No.	Freq. (MHz)	Reading (dBm)	S.G Power Value (dBm)	Correction Factor (dB)	EIRP (dBm)	Limit (dBm)	Margin (dB)
1	1850.70	-20.4	19.5	1.0	20.5	33.0	-12.5
Antenna Polarity & Test Distance: Vertical at 3 M							
No.	Freq. (MHz)	Reading (dBm)	S.G Power Value (dBm)	Correction Factor (dB)	EIRP (dBm)	Limit (dBm)	Margin (dB)
1	1850.70	-15.8	23.0	1.0	24.0	33.0	-9.0

MODE		TX channel 18900					
Antenna Polarity & Test Distance: Horizontal at 3 M							
No.	Freq. (MHz)	Reading (dBm)	S.G Power Value (dBm)	Correction Factor (dB)	EIRP (dBm)	Limit (dBm)	Margin (dB)
1	1880.00	-20.0	20.1	1.1	21.2	33.0	-11.8
Antenna Polarity & Test Distance: Vertical at 3 M							
No.	Freq. (MHz)	Reading (dBm)	S.G Power Value (dBm)	Correction Factor (dB)	EIRP (dBm)	Limit (dBm)	Margin (dB)
1	1880.00	-16.4	22.1	1.1	23.2	33.0	-9.8

MODE		TX channel 19193					
Antenna Polarity & Test Distance: Horizontal at 3 M							
No.	Freq. (MHz)	Reading (dBm)	S.G Power Value (dBm)	Correction Factor (dB)	EIRP (dBm)	Limit (dBm)	Margin (dB)
1	1909.30	-20.1	20.3	1.1	21.4	33.0	-11.6
Antenna Polarity & Test Distance: Vertical at 3 M							
No.	Freq. (MHz)	Reading (dBm)	S.G Power Value (dBm)	Correction Factor (dB)	EIRP (dBm)	Limit (dBm)	Margin (dB)
1	1909.30	-15.9	22.5	1.1	23.6	33.0	-9.4

Note: EIRP (dBm) = S.G Power Value (dBm) + Correction Factor (dB).

LTE Band 2, Channel Bandwidth 3MHz

MODE		TX channel 18615					
Antenna Polarity & Test Distance: Horizontal at 3 M							
No.	Freq. (MHz)	Reading (dBm)	S.G Power Value (dBm)	Correction Factor (dB)	EIRP (dBm)	Limit (dBm)	Margin (dB)
1	1851.50	-20.0	19.9	1.0	20.9	33.0	-12.1
Antenna Polarity & Test Distance: Vertical at 3 M							
No.	Freq. (MHz)	Reading (dBm)	S.G Power Value (dBm)	Correction Factor (dB)	EIRP (dBm)	Limit (dBm)	Margin (dB)
1	1851.50	-15.9	22.9	1.0	23.9	33.0	-9.1

MODE		TX channel 18900					
Antenna Polarity & Test Distance: Horizontal at 3 M							
No.	Freq. (MHz)	Reading (dBm)	S.G Power Value (dBm)	Correction Factor (dB)	EIRP (dBm)	Limit (dBm)	Margin (dB)
1	1880.00	-20.2	19.9	1.1	21.0	33.0	-12.0
Antenna Polarity & Test Distance: Vertical at 3 M							
No.	Freq. (MHz)	Reading (dBm)	S.G Power Value (dBm)	Correction Factor (dB)	EIRP (dBm)	Limit (dBm)	Margin (dB)
1	1880.00	-16.1	22.4	1.1	23.5	33.0	-9.5

MODE		TX channel 19185					
Antenna Polarity & Test Distance: Horizontal at 3 M							
No.	Freq. (MHz)	Reading (dBm)	S.G Power Value (dBm)	Correction Factor (dB)	EIRP (dBm)	Limit (dBm)	Margin (dB)
1	1908.50	-20.4	20.0	1.1	21.1	33.0	-11.9
Antenna Polarity & Test Distance: Vertical at 3 M							
No.	Freq. (MHz)	Reading (dBm)	S.G Power Value (dBm)	Correction Factor (dB)	EIRP (dBm)	Limit (dBm)	Margin (dB)
1	1908.50	-15.9	22.5	1.1	23.6	33.0	-9.4

Note: EIRP (dBm) = S.G Power Value (dBm) + Correction Factor (dB).

LTE Band 2, Channel Bandwidth 5MHz

MODE		TX channel 18625					
Antenna Polarity & Test Distance: Horizontal at 3 M							
No.	Freq. (MHz)	Reading (dBm)	S.G Power Value (dBm)	Correction Factor (dB)	EIRP (dBm)	Limit (dBm)	Margin (dB)
1	1852.50	-20.0	19.9	1.0	20.9	33.0	-12.1
Antenna Polarity & Test Distance: Vertical at 3 M							
No.	Freq. (MHz)	Reading (dBm)	S.G Power Value (dBm)	Correction Factor (dB)	EIRP (dBm)	Limit (dBm)	Margin (dB)
1	1852.50	-16.4	22.4	1.0	23.4	33.0	-9.6

MODE		TX channel 18900					
Antenna Polarity & Test Distance: Horizontal at 3 M							
No.	Freq. (MHz)	Reading (dBm)	S.G Power Value (dBm)	Correction Factor (dB)	EIRP (dBm)	Limit (dBm)	Margin (dB)
1	1880.00	-20.4	19.7	1.1	20.8	33.0	-12.2
Antenna Polarity & Test Distance: Vertical at 3 M							
No.	Freq. (MHz)	Reading (dBm)	S.G Power Value (dBm)	Correction Factor (dB)	EIRP (dBm)	Limit (dBm)	Margin (dB)
1	1880.00	-15.9	22.6	1.1	23.7	33.0	-9.3

MODE		TX channel 19175					
Antenna Polarity & Test Distance: Horizontal at 3 M							
No.	Freq. (MHz)	Reading (dBm)	S.G Power Value (dBm)	Correction Factor (dB)	EIRP (dBm)	Limit (dBm)	Margin (dB)
1	1907.50	-20.1	20.3	1.1	21.4	33.0	-11.6
Antenna Polarity & Test Distance: Vertical at 3 M							
No.	Freq. (MHz)	Reading (dBm)	S.G Power Value (dBm)	Correction Factor (dB)	EIRP (dBm)	Limit (dBm)	Margin (dB)
1	1907.50	-16.0	22.4	1.1	23.5	33.0	-9.5

Note: EIRP (dBm) = S.G Power Value (dBm) + Correction Factor (dB).

LTE Band 2, Channel Bandwidth 10MHz

MODE		TX channel 18650					
Antenna Polarity & Test Distance: Horizontal at 3 M							
No.	Freq. (MHz)	Reading (dBm)	S.G Power Value (dBm)	Correction Factor (dB)	EIRP (dBm)	Limit (dBm)	Margin (dB)
1	1855.00	-20.2	19.8	1.0	20.8	33.0	-12.2
Antenna Polarity & Test Distance: Vertical at 3 M							
No.	Freq. (MHz)	Reading (dBm)	S.G Power Value (dBm)	Correction Factor (dB)	EIRP (dBm)	Limit (dBm)	Margin (dB)
1	1855.00	-16.4	22.4	1.0	23.4	33.0	-9.6

MODE		TX channel 18900					
Antenna Polarity & Test Distance: Horizontal at 3 M							
No.	Freq. (MHz)	Reading (dBm)	S.G Power Value (dBm)	Correction Factor (dB)	EIRP (dBm)	Limit (dBm)	Margin (dB)
1	1880.00	-20.5	19.6	1.1	20.7	33.0	-12.3
Antenna Polarity & Test Distance: Vertical at 3 M							
No.	Freq. (MHz)	Reading (dBm)	S.G Power Value (dBm)	Correction Factor (dB)	EIRP (dBm)	Limit (dBm)	Margin (dB)
1	1880.00	-16.2	22.3	1.1	23.4	33.0	-9.6

MODE		TX channel 19150					
Antenna Polarity & Test Distance: Horizontal at 3 M							
No.	Freq. (MHz)	Reading (dBm)	S.G Power Value (dBm)	Correction Factor (dB)	EIRP (dBm)	Limit (dBm)	Margin (dB)
1	1905.00	-20.1	20.3	1.1	21.4	33.0	-11.6
Antenna Polarity & Test Distance: Vertical at 3 M							
No.	Freq. (MHz)	Reading (dBm)	S.G Power Value (dBm)	Correction Factor (dB)	EIRP (dBm)	Limit (dBm)	Margin (dB)
1	1905.00	-16.0	22.4	1.1	23.5	33.0	-9.5

Note: EIRP (dBm) = S.G Power Value (dBm) + Correction Factor (dB).

LTE Band 2, Channel Bandwidth 15MHz

MODE		TX channel 18675					
Antenna Polarity & Test Distance: Horizontal at 3 M							
No.	Freq. (MHz)	Reading (dBm)	S.G Power Value (dBm)	Correction Factor (dB)	EIRP (dBm)	Limit (dBm)	Margin (dB)
1	1857.50	-20.3	19.6	1.1	20.7	33.0	-12.3
Antenna Polarity & Test Distance: Vertical at 3 M							
No.	Freq. (MHz)	Reading (dBm)	S.G Power Value (dBm)	Correction Factor (dB)	EIRP (dBm)	Limit (dBm)	Margin (dB)
1	1857.50	-16.2	22.5	1.1	23.6	33.0	-9.4

MODE		TX channel 18900					
Antenna Polarity & Test Distance: Horizontal at 3 M							
No.	Freq. (MHz)	Reading (dBm)	S.G Power Value (dBm)	Correction Factor (dB)	EIRP (dBm)	Limit (dBm)	Margin (dB)
1	1880.00	-20.5	19.6	1.1	20.7	33.0	-12.3
Antenna Polarity & Test Distance: Vertical at 3 M							
No.	Freq. (MHz)	Reading (dBm)	S.G Power Value (dBm)	Correction Factor (dB)	EIRP (dBm)	Limit (dBm)	Margin (dB)
1	1880.00	-15.9	22.6	1.1	23.7	33.0	-9.3

MODE		TX channel 19125					
Antenna Polarity & Test Distance: Horizontal at 3 M							
No.	Freq. (MHz)	Reading (dBm)	S.G Power Value (dBm)	Correction Factor (dB)	EIRP (dBm)	Limit (dBm)	Margin (dB)
1	1902.50	-20.1	20.3	1.1	21.4	33.0	-11.6
Antenna Polarity & Test Distance: Vertical at 3 M							
No.	Freq. (MHz)	Reading (dBm)	S.G Power Value (dBm)	Correction Factor (dB)	EIRP (dBm)	Limit (dBm)	Margin (dB)
1	1902.50	-15.9	22.5	1.1	23.6	33.0	-9.4

Note: EIRP (dBm) = S.G Power Value (dBm) + Correction Factor (dB).

LTE Band 2, Channel Bandwidth 20MHz

MODE		TX channel 18700					
Antenna Polarity & Test Distance: Horizontal at 3 M							
No.	Freq. (MHz)	Reading (dBm)	S.G Power Value (dBm)	Correction Factor (dB)	EIRP (dBm)	Limit (dBm)	Margin (dB)
1	1860.00	-20.2	19.7	1.1	20.8	33.0	-12.2
Antenna Polarity & Test Distance: Vertical at 3 M							
No.	Freq. (MHz)	Reading (dBm)	S.G Power Value (dBm)	Correction Factor (dB)	EIRP (dBm)	Limit (dBm)	Margin (dB)
1	1860.00	-16.1	22.5	1.1	23.6	33.0	-9.4

MODE		TX channel 18900					
Antenna Polarity & Test Distance: Horizontal at 3 M							
No.	Freq. (MHz)	Reading (dBm)	S.G Power Value (dBm)	Correction Factor (dB)	EIRP (dBm)	Limit (dBm)	Margin (dB)
1	1880.00	-20.5	19.6	1.1	20.7	33.0	-12.3
Antenna Polarity & Test Distance: Vertical at 3 M							
No.	Freq. (MHz)	Reading (dBm)	S.G Power Value (dBm)	Correction Factor (dB)	EIRP (dBm)	Limit (dBm)	Margin (dB)
1	1880.00	-15.9	22.6	1.1	23.7	33.0	-9.3

MODE		TX channel 19100					
Antenna Polarity & Test Distance: Horizontal at 3 M							
No.	Freq. (MHz)	Reading (dBm)	S.G Power Value (dBm)	Correction Factor (dB)	EIRP (dBm)	Limit (dBm)	Margin (dB)
1	1900.00	-20.2	20.2	1.1	21.3	33.0	-11.7
Antenna Polarity & Test Distance: Vertical at 3 M							
No.	Freq. (MHz)	Reading (dBm)	S.G Power Value (dBm)	Correction Factor (dB)	EIRP (dBm)	Limit (dBm)	Margin (dB)
1	1900.00	-16.3	22.0	1.1	23.1	33.0	-9.9

Note: EIRP (dBm) = S.G Power Value (dBm) + Correction Factor (dB).

LTE Band 25, Channel Bandwidth 1.4MHz

MODE		TX channel 26047					
Antenna Polarity & Test Distance: Horizontal at 3 M							
No.	Freq. (MHz)	Reading (dBm)	S.G Power Value (dBm)	Correction Factor (dB)	EIRP (dBm)	Limit (dBm)	Margin (dB)
1	1850.70	-17.4	21.5	1.0	22.5	33.0	-10.5
Antenna Polarity & Test Distance: Vertical at 3 M							
No.	Freq. (MHz)	Reading (dBm)	S.G Power Value (dBm)	Correction Factor (dB)	EIRP (dBm)	Limit (dBm)	Margin (dB)
1	1850.70	-15.4	23.0	1.0	24.0	33.0	-9.0

MODE		TX channel 26365					
Antenna Polarity & Test Distance: Horizontal at 3 M							
No.	Freq. (MHz)	Reading (dBm)	S.G Power Value (dBm)	Correction Factor (dB)	EIRP (dBm)	Limit (dBm)	Margin (dB)
1	1882.50	-17.7	21.6	1.1	22.7	33.0	-10.3
Antenna Polarity & Test Distance: Vertical at 3 M							
No.	Freq. (MHz)	Reading (dBm)	S.G Power Value (dBm)	Correction Factor (dB)	EIRP (dBm)	Limit (dBm)	Margin (dB)
1	1882.50	-15.9	22.5	1.1	23.6	33.0	-9.4

MODE		TX channel 26683					
Antenna Polarity & Test Distance: Horizontal at 3 M							
No.	Freq. (MHz)	Reading (dBm)	S.G Power Value (dBm)	Correction Factor (dB)	EIRP (dBm)	Limit (dBm)	Margin (dB)
1	1914.30	-17.7	22.4	0.7	23.1	33.0	-9.9
Antenna Polarity & Test Distance: Vertical at 3 M							
No.	Freq. (MHz)	Reading (dBm)	S.G Power Value (dBm)	Correction Factor (dB)	EIRP (dBm)	Limit (dBm)	Margin (dB)
1	1914.30	-15.6	23.4	0.7	24.1	33.0	-8.9

Note: EIRP (dBm) = S.G Power Value (dBm) + Correction Factor (dB).

LTE Band 25, Channel Bandwidth 3MHz

MODE		TX channel 26055					
Antenna Polarity & Test Distance: Horizontal at 3 M							
No.	Freq. (MHz)	Reading (dBm)	S.G Power Value (dBm)	Correction Factor (dB)	EIRP (dBm)	Limit (dBm)	Margin (dB)
1	1851.50	-17.2	21.7	1.0	22.7	33.0	-10.3
Antenna Polarity & Test Distance: Vertical at 3 M							
No.	Freq. (MHz)	Reading (dBm)	S.G Power Value (dBm)	Correction Factor (dB)	EIRP (dBm)	Limit (dBm)	Margin (dB)
1	1851.50	-15.6	22.8	1.0	23.8	33.0	-9.2

MODE		TX channel 26365					
Antenna Polarity & Test Distance: Horizontal at 3 M							
No.	Freq. (MHz)	Reading (dBm)	S.G Power Value (dBm)	Correction Factor (dB)	EIRP (dBm)	Limit (dBm)	Margin (dB)
1	1882.50	-18.5	20.8	1.1	21.9	33.0	-11.1
Antenna Polarity & Test Distance: Vertical at 3 M							
No.	Freq. (MHz)	Reading (dBm)	S.G Power Value (dBm)	Correction Factor (dB)	EIRP (dBm)	Limit (dBm)	Margin (dB)
1	1882.50	-15.3	23.1	1.1	24.2	33.0	-8.8

MODE		TX channel 26675					
Antenna Polarity & Test Distance: Horizontal at 3 M							
No.	Freq. (MHz)	Reading (dBm)	S.G Power Value (dBm)	Correction Factor (dB)	EIRP (dBm)	Limit (dBm)	Margin (dB)
1	1913.50	-17.8	22.3	0.7	23.0	33.0	-10.0
Antenna Polarity & Test Distance: Vertical at 3 M							
No.	Freq. (MHz)	Reading (dBm)	S.G Power Value (dBm)	Correction Factor (dB)	EIRP (dBm)	Limit (dBm)	Margin (dB)
1	1913.50	-15.5	23.5	0.7	24.2	33.0	-8.8

Note: EIRP (dBm) = S.G Power Value (dBm) + Correction Factor (dB).

LTE Band 25, Channel Bandwidth 5MHz

MODE		TX channel 26065					
Antenna Polarity & Test Distance: Horizontal at 3 M							
No.	Freq. (MHz)	Reading (dBm)	S.G Power Value (dBm)	Correction Factor (dB)	EIRP (dBm)	Limit (dBm)	Margin (dB)
1	1852.50	-17.9	21.0	1.0	22.0	33.0	-11.0
Antenna Polarity & Test Distance: Vertical at 3 M							
No.	Freq. (MHz)	Reading (dBm)	S.G Power Value (dBm)	Correction Factor (dB)	EIRP (dBm)	Limit (dBm)	Margin (dB)
1	1852.50	-15.7	22.7	1.0	23.7	33.0	-9.3

MODE		TX channel 26365					
Antenna Polarity & Test Distance: Horizontal at 3 M							
No.	Freq. (MHz)	Reading (dBm)	S.G Power Value (dBm)	Correction Factor (dB)	EIRP (dBm)	Limit (dBm)	Margin (dB)
1	1882.50	-18.2	21.1	1.1	22.2	33.0	-10.8
Antenna Polarity & Test Distance: Vertical at 3 M							
No.	Freq. (MHz)	Reading (dBm)	S.G Power Value (dBm)	Correction Factor (dB)	EIRP (dBm)	Limit (dBm)	Margin (dB)
1	1882.50	-15.9	22.5	1.1	23.6	33.0	-9.4

MODE		TX channel 26665					
Antenna Polarity & Test Distance: Horizontal at 3 M							
No.	Freq. (MHz)	Reading (dBm)	S.G Power Value (dBm)	Correction Factor (dB)	EIRP (dBm)	Limit (dBm)	Margin (dB)
1	1912.50	-18.7	21.4	0.7	22.1	33.0	-10.9
Antenna Polarity & Test Distance: Vertical at 3 M							
No.	Freq. (MHz)	Reading (dBm)	S.G Power Value (dBm)	Correction Factor (dB)	EIRP (dBm)	Limit (dBm)	Margin (dB)
1	1912.50	-16.7	22.3	0.7	23.0	33.0	-10.0

Note: EIRP (dBm) = S.G Power Value (dBm) + Correction Factor (dB).

LTE Band 25, Channel Bandwidth 10MHz

MODE		TX channel 26090					
Antenna Polarity & Test Distance: Horizontal at 3 M							
No.	Freq. (MHz)	Reading (dBm)	S.G Power Value (dBm)	Correction Factor (dB)	EIRP (dBm)	Limit (dBm)	Margin (dB)
1	1855.00	-16.8	22.1	1.0	23.1	33.0	-9.9
Antenna Polarity & Test Distance: Vertical at 3 M							
No.	Freq. (MHz)	Reading (dBm)	S.G Power Value (dBm)	Correction Factor (dB)	EIRP (dBm)	Limit (dBm)	Margin (dB)
1	1855.00	-15.6	22.8	1.0	23.8	33.0	-9.2

MODE		TX channel 26365					
Antenna Polarity & Test Distance: Horizontal at 3 M							
No.	Freq. (MHz)	Reading (dBm)	S.G Power Value (dBm)	Correction Factor (dB)	EIRP (dBm)	Limit (dBm)	Margin (dB)
1	1882.50	-17.9	21.4	1.1	22.5	33.0	-10.5
Antenna Polarity & Test Distance: Vertical at 3 M							
No.	Freq. (MHz)	Reading (dBm)	S.G Power Value (dBm)	Correction Factor (dB)	EIRP (dBm)	Limit (dBm)	Margin (dB)
1	1882.50	-15.8	22.6	1.1	23.7	33.0	-9.3

MODE		TX channel 26640					
Antenna Polarity & Test Distance: Horizontal at 3 M							
No.	Freq. (MHz)	Reading (dBm)	S.G Power Value (dBm)	Correction Factor (dB)	EIRP (dBm)	Limit (dBm)	Margin (dB)
1	1910.00	-17.8	22.3	0.7	23.0	33.0	-10.0
Antenna Polarity & Test Distance: Vertical at 3 M							
No.	Freq. (MHz)	Reading (dBm)	S.G Power Value (dBm)	Correction Factor (dB)	EIRP (dBm)	Limit (dBm)	Margin (dB)
1	1910.00	-16.2	22.8	0.7	23.5	33.0	-9.5

Note: EIRP (dBm) = S.G Power Value (dBm) + Correction Factor (dB).

LTE Band 25, Channel Bandwidth 15MHz

MODE		TX channel 26115					
Antenna Polarity & Test Distance: Horizontal at 3 M							
No.	Freq. (MHz)	Reading (dBm)	S.G Power Value (dBm)	Correction Factor (dB)	EIRP (dBm)	Limit (dBm)	Margin (dB)
1	1857.50	-17.3	21.6	1.1	22.7	33.0	-10.3
Antenna Polarity & Test Distance: Vertical at 3 M							
No.	Freq. (MHz)	Reading (dBm)	S.G Power Value (dBm)	Correction Factor (dB)	EIRP (dBm)	Limit (dBm)	Margin (dB)
1	1857.50	-15.9	22.4	1.1	23.5	33.0	-9.5

MODE		TX channel 26365					
Antenna Polarity & Test Distance: Horizontal at 3 M							
No.	Freq. (MHz)	Reading (dBm)	S.G Power Value (dBm)	Correction Factor (dB)	EIRP (dBm)	Limit (dBm)	Margin (dB)
1	1882.50	-17.7	21.6	1.1	22.7	33.0	-10.3
Antenna Polarity & Test Distance: Vertical at 3 M							
No.	Freq. (MHz)	Reading (dBm)	S.G Power Value (dBm)	Correction Factor (dB)	EIRP (dBm)	Limit (dBm)	Margin (dB)
1	1882.50	-15.6	22.8	1.1	23.9	33.0	-9.1

MODE		TX channel 26615					
Antenna Polarity & Test Distance: Horizontal at 3 M							
No.	Freq. (MHz)	Reading (dBm)	S.G Power Value (dBm)	Correction Factor (dB)	EIRP (dBm)	Limit (dBm)	Margin (dB)
1	1907.50	-18.2	21.5	1.1	22.6	33.0	-10.4
Antenna Polarity & Test Distance: Vertical at 3 M							
No.	Freq. (MHz)	Reading (dBm)	S.G Power Value (dBm)	Correction Factor (dB)	EIRP (dBm)	Limit (dBm)	Margin (dB)
1	1907.50	-16.2	22.3	1.1	23.4	33.0	-9.6

Note: EIRP (dBm) = S.G Power Value (dBm) + Correction Factor (dB).

LTE Band 25, Channel Bandwidth 20MHz

MODE		TX channel 26140					
Antenna Polarity & Test Distance: Horizontal at 3 M							
No.	Freq. (MHz)	Reading (dBm)	S.G Power Value (dBm)	Correction Factor (dB)	EIRP (dBm)	Limit (dBm)	Margin (dB)
1	1860.00	-17.3	21.6	1.1	22.7	33.0	-10.3
Antenna Polarity & Test Distance: Vertical at 3 M							
No.	Freq. (MHz)	Reading (dBm)	S.G Power Value (dBm)	Correction Factor (dB)	EIRP (dBm)	Limit (dBm)	Margin (dB)
1	1860.00	-15.5	22.8	1.1	23.9	33.0	-9.1

MODE		TX channel 26365					
Antenna Polarity & Test Distance: Horizontal at 3 M							
No.	Freq. (MHz)	Reading (dBm)	S.G Power Value (dBm)	Correction Factor (dB)	EIRP (dBm)	Limit (dBm)	Margin (dB)
1	1882.50	-17.3	22.0	1.1	23.1	33.0	-9.9
Antenna Polarity & Test Distance: Vertical at 3 M							
No.	Freq. (MHz)	Reading (dBm)	S.G Power Value (dBm)	Correction Factor (dB)	EIRP (dBm)	Limit (dBm)	Margin (dB)
1	1882.50	-15.5	22.9	1.1	24.0	33.0	-9.0

MODE		TX channel 26590					
Antenna Polarity & Test Distance: Horizontal at 3 M							
No.	Freq. (MHz)	Reading (dBm)	S.G Power Value (dBm)	Correction Factor (dB)	EIRP (dBm)	Limit (dBm)	Margin (dB)
1	1905.00	-17.6	22.0	1.1	23.1	33.0	-9.9
Antenna Polarity & Test Distance: Vertical at 3 M							
No.	Freq. (MHz)	Reading (dBm)	S.G Power Value (dBm)	Correction Factor (dB)	EIRP (dBm)	Limit (dBm)	Margin (dB)
1	1905.00	-15.5	23.0	1.1	24.1	33.0	-8.9

Note: EIRP (dBm) = S.G Power Value (dBm) + Correction Factor (dB).

4.2 Modulation Characteristics Measurement

4.2.1 Limits of Modulation Characteristics

N/A

4.2.2 Test Procedure

Connect the EUT to Communication Simulator via the antenna connector, The frequency band is set as EUT supported Modulation and Channels, the EUT output is matched with 50 ohm load, the waveform quality and constellation of the EUT was tested.

4.2.3 Test Setup



4.2.4 Test Results

Spectrum Plot of Measurement Value

Channel: 661 / Frequency (MHz): 1880.0MHz

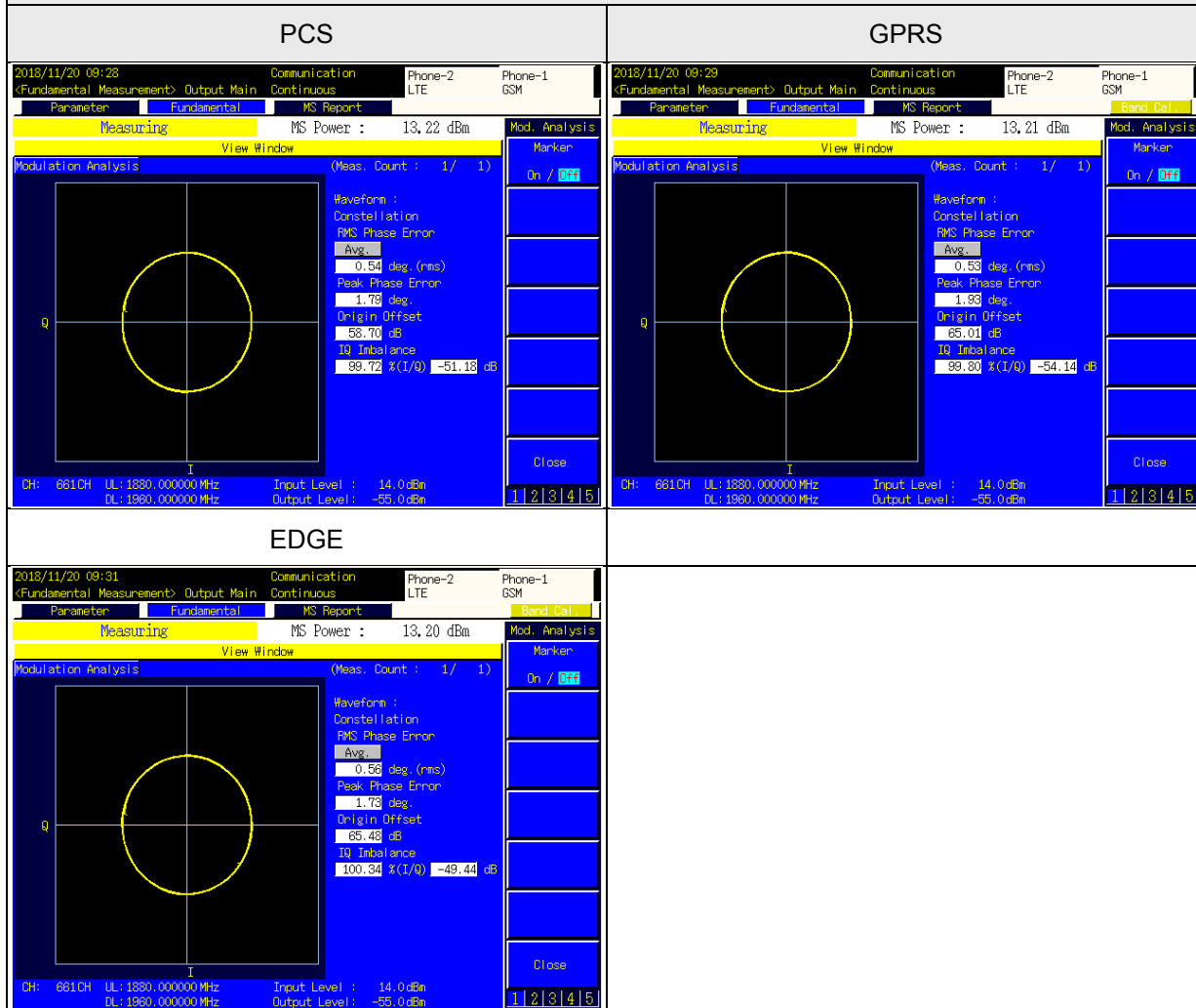

CDMA

Spectrum Plot of Measurement Value

Channel: 25 / Frequency (MHz): 1851.25MHz

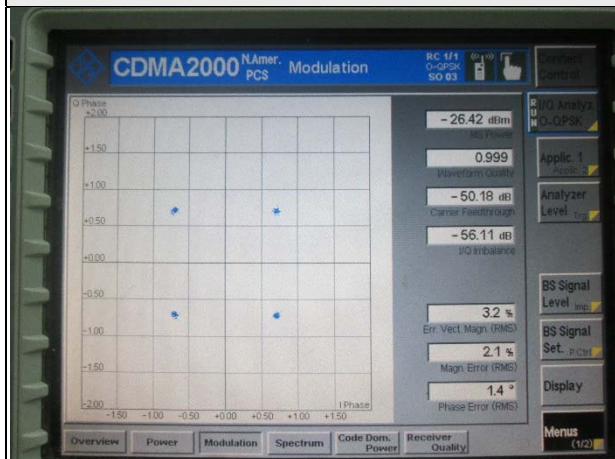

WCDMA Band 2

Spectrum Plot of Measurement Value

Channel: 9400 / Frequency (MHz): 1880.0MHz

WCDMA

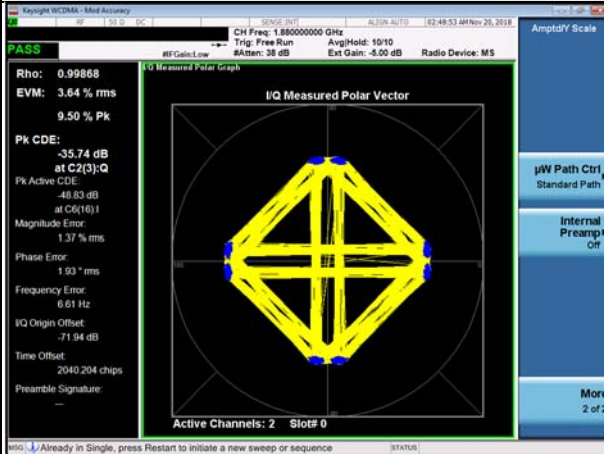

HSDPA

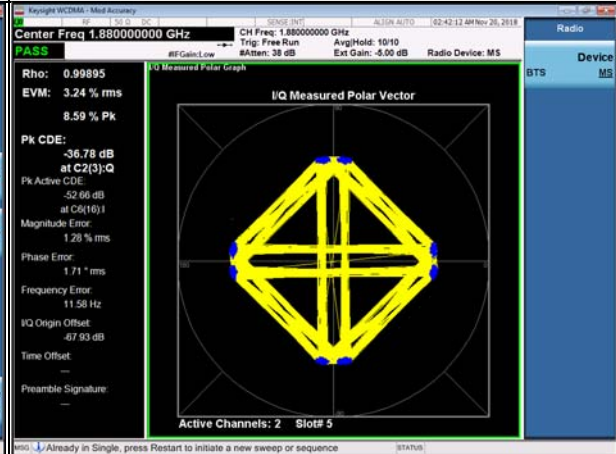

HSUPA

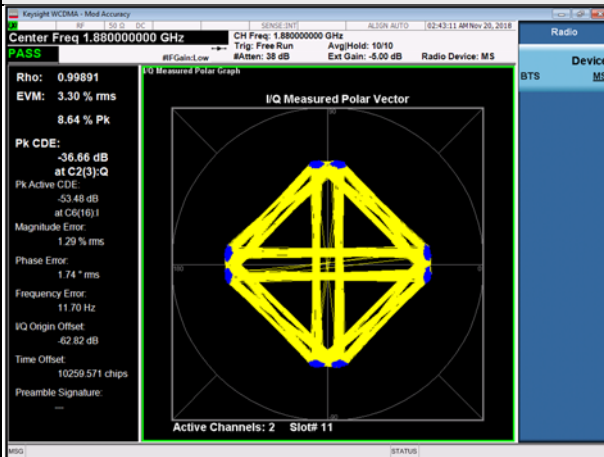

LTE Band 2

Spectrum Plot of Measurement Value

Channel: 18900 / Frequency (MHz): 1880.0MHz

QPSK

16QAM

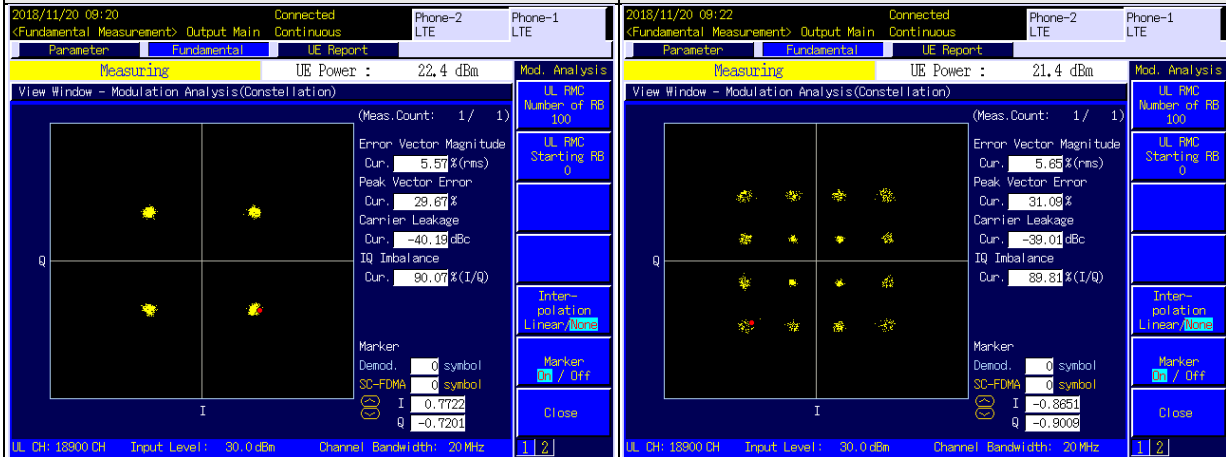

LTE Band 25

Spectrum Plot of Measurement Value

Channel: 26365 / Frequency (MHz): 1882.5MHz

QPSK

16QAM

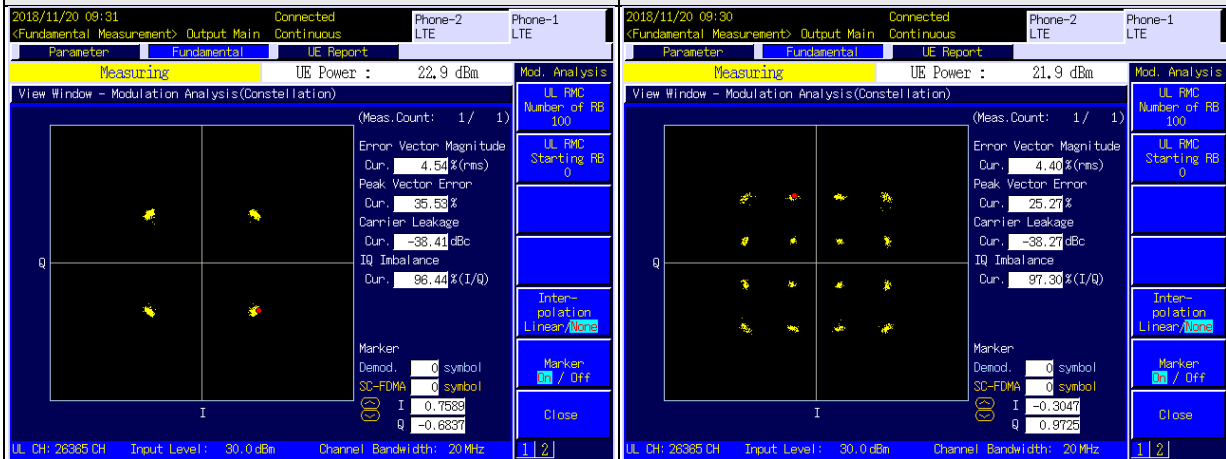

4.3 Frequency Stability Measurement

4.3.1 Limits of Frequency Stability Measurement

1.5 ppm is for base and fixed station. 2.5 ppm is for mobile station.

4.3.2 Test Procedure

- Device is placed at the oven room. The oven room could control the temperatures and humidity. Power warm up is at least 15 min and power applied should perform before recording frequency error.
- EUT is connected the external power supply to control the DC input power. The test voltage range is from minimum to maximum working voltage. Each step shall be record the frequency error rate.
- The temperature range step is 10 degrees in this test items. All temperature levels shall be hold the ± 0.5 °C during the measurement testing. The each temperature step shall be at least 0.5 hours, consider the EUT could be test under the stability condition.

Note: The frequency error was recorded frequency error from the communication simulator.

4.3.3 Conducted Setup

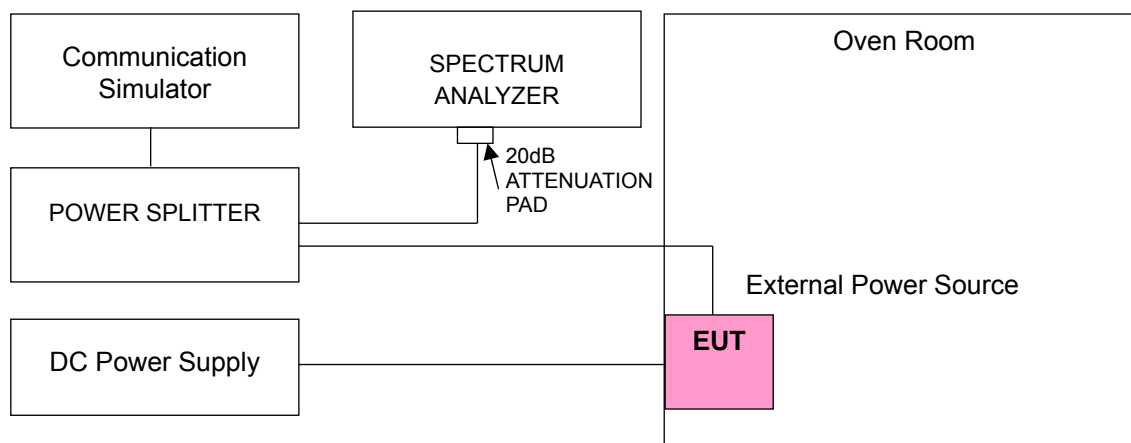

4.3.4 Test Results

Frequency Error vs. Voltage

Voltage (Volts)	PCS 1900			
	Low Channel		High Channel	
	Frequency (MHz)	Frequency Error (ppm)	Frequency (MHz)	Frequency Error (ppm)
3.20	1850.200003	0.002	1909.800004	0.002
3.75	1850.200003	0.001	1909.800004	0.002
4.30	1850.200002	0.001	1909.800004	0.002

Note: The applicant defined the normal working voltage is from 3.20Vdc to 4.30Vdc.

Frequency Error vs. Temperature

Temp. (°C)	PCS 1900			
	Low Channel		High Channel	
	Frequency (MHz)	Frequency Error (ppm)	Frequency (MHz)	Frequency Error (ppm)
-30	1850.200004	0.002	1909.800002	0.001
-20	1850.200003	0.001	1909.800003	0.002
-10	1850.200002	0.001	1909.800004	0.002
0	1850.200002	0.001	1909.800003	0.002
10	1850.200001	0.001	1909.800004	0.002
20	1850.199997	-0.001	1909.799999	-0.001
30	1850.199997	-0.002	1909.799998	-0.001
40	1850.199997	-0.002	1909.799996	-0.002
50	1850.199997	-0.001	1909.799998	-0.001
60	1850.199997	-0.002	1909.799998	-0.001

Frequency Error vs. Voltage

Voltage (Volts)	EDGE 1900			
	Low Channel		High Channel	
	Frequency (MHz)	Frequency Error (ppm)	Frequency (MHz)	Frequency Error (ppm)
3.20	1850.200004	0.002	1909.800004	0.002
3.75	1850.200003	0.002	1909.800004	0.002
4.30	1850.200002	0.001	1909.800001	0.001

Note: The applicant defined the normal working voltage is from 3.20Vdc to 4.30Vdc.

Frequency Error vs. Temperature

Temp. (°C)	EDGE 1900			
	Low Channel		High Channel	
	Frequency (MHz)	Frequency Error (ppm)	Frequency (MHz)	Frequency Error (ppm)
-30	1850.200003	0.001	1909.800002	0.001
-20	1850.200002	0.001	1909.800003	0.002
-10	1850.200002	0.001	1909.800002	0.001
0	1850.200003	0.002	1909.800004	0.002
10	1850.200002	0.001	1909.800002	0.001
20	1850.199996	-0.002	1909.799998	-0.001
30	1850.199999	-0.001	1909.799999	-0.001
40	1850.199998	-0.001	1909.799997	-0.002
50	1850.199997	-0.002	1909.799998	-0.001
60	1850.199996	-0.002	1909.799998	-0.001

Frequency Error vs. Voltage

Voltage (Volts)	CDMA			
	Low Channel		High Channel	
	Frequency (MHz)	Frequency Error (ppm)	Frequency (MHz)	Frequency Error (ppm)
3.20	1851.250003	0.002	1908.750003	0.001
3.75	1851.250002	0.001	1908.750003	0.001
4.30	1851.250002	0.001	1908.750002	0.001

Note: The applicant defined the normal working voltage is from 3.20Vdc to 4.30Vdc.

Frequency Error vs. Temperature

Temp. (°C)	CDMA			
	Low Channel		High Channel	
	Frequency (MHz)	Frequency Error (ppm)	Frequency (MHz)	Frequency Error (ppm)
-30	1851.250003	0.001	1908.750003	0.002
-20	1851.250003	0.002	1908.750003	0.001
-10	1851.250003	0.001	1908.750003	0.001
0	1851.250002	0.001	1908.750002	0.001
10	1851.250002	0.001	1908.750002	0.001
20	1851.249997	-0.001	1908.749997	-0.001
30	1851.249997	-0.002	1908.749998	-0.001
40	1851.249997	-0.002	1908.749996	-0.002
50	1851.249997	-0.002	1908.749996	-0.002
60	1851.249997	-0.002	1908.749996	-0.002

Frequency Error vs. Voltage

Voltage (Volts)	WCDMA Band 2			
	Low Channel		High Channel	
	Frequency (MHz)	Frequency Error (ppm)	Frequency (MHz)	Frequency Error (ppm)
3.20	1852.400002	0.001	1907.600003	0.002
3.75	1852.400004	0.002	1907.600002	0.001
4.30	1852.400002	0.001	1907.600003	0.001

Note: The applicant defined the normal working voltage is from 3.20Vdc to 4.30Vdc.

Frequency Error vs. Temperature

Temp. (°C)	WCDMA Band 2			
	Low Channel		High Channel	
	Frequency (MHz)	Frequency Error (ppm)	Frequency (MHz)	Frequency Error (ppm)
-30	1852.400003	0.002	1907.600003	0.002
-20	1852.400002	0.001	1907.600001	0.001
-10	1852.400002	0.001	1907.600001	0.001
0	1852.400002	0.001	1907.600002	0.001
10	1852.400003	0.002	1907.600002	0.001
20	1852.399999	-0.001	1907.599997	-0.002
30	1852.399998	-0.001	1907.599997	-0.001
40	1852.399998	-0.001	1907.599998	-0.001
50	1852.399999	-0.001	1907.599997	-0.002
60	1852.399999	-0.001	1907.599998	-0.001

Frequency Error vs. Voltage

Voltage (Volts)	LTE Band 2			
	Channel Bandwidth: 1.4 MHz			
	Low Channel		High Channel	
	Frequency (MHz)	Frequency Error (ppm)	Frequency (MHz)	Frequency Error (ppm)
3.20	1850.700001	0.001	1909.300000	0.001
3.75	1850.700003	0.002	1909.300001	0.001
4.30	1850.700001	0.001	1909.300002	0.001

Note: The applicant defined the normal working voltage is from 3.20Vdc to 4.30Vdc.

Frequency Error vs. Temperature

Temp. (°C)	LTE Band 2			
	Channel Bandwidth: 1.4 MHz			
	Low Channel		High Channel	
	Frequency (MHz)	Frequency Error (ppm)	Frequency (MHz)	Frequency Error (ppm)
-30	1850.700002	0.001	1909.300001	0.001
-20	1850.700002	0.001	1909.300002	0.001
-10	1850.700002	0.001	1909.300003	0.002
0	1850.700002	0.001	1909.300001	0.001
10	1850.700004	0.002	1909.300004	0.002
20	1850.699999	-0.001	1909.299996	-0.002
30	1850.699996	-0.002	1909.299998	-0.001
40	1850.699997	-0.002	1909.299997	-0.002
50	1850.699998	-0.001	1909.299998	-0.001
60	1850.699997	-0.002	1909.299998	-0.001

Frequency Error vs. Voltage

Voltage (Volts)	LTE Band 2			
	Channel Bandwidth: 3 MHz			
	Low Channel		High Channel	
	Frequency (MHz)	Frequency Error (ppm)	Frequency (MHz)	Frequency Error (ppm)
3.20	1851.500003	0.002	1907.500003	0.001
3.75	1851.500002	0.001	1907.500003	0.001
4.30	1851.500002	0.001	1907.500004	0.002

Note: The applicant defined the normal working voltage is from 3.20Vdc to 4.30Vdc.

Frequency Error vs. Temperature

Temp. (°C)	LTE Band 2			
	Channel Bandwidth: 3 MHz			
	Low Channel		High Channel	
	Frequency (MHz)	Frequency Error (ppm)	Frequency (MHz)	Frequency Error (ppm)
-30	1851.500003	0.002	1907.500002	0.001
-20	1851.500002	0.001	1907.500003	0.002
-10	1851.500002	0.001	1907.500004	0.002
0	1851.500003	0.002	1907.500002	0.001
10	1851.500001	0.001	1907.500003	0.002
20	1851.499997	-0.001	1907.499998	-0.001
30	1851.499998	-0.001	1907.499998	-0.001
40	1851.499997	-0.001	1907.499997	-0.002
50	1851.499996	-0.002	1907.499998	-0.001
60	1851.499996	-0.002	1907.499997	-0.002

Frequency Error vs. Voltage

Voltage (Volts)	LTE Band 2			
	Channel Bandwidth: 5 MHz			
	Low Channel		High Channel	
	Frequency (MHz)	Frequency Error (ppm)	Frequency (MHz)	Frequency Error (ppm)
3.20	1852.500002	0.001	1907.500003	0.002
3.75	1852.500004	0.002	1907.500002	0.001
4.30	1852.500004	0.002	1907.500002	0.001

Note: The applicant defined the normal working voltage is from 3.20Vdc to 4.30Vdc.

Frequency Error vs. Temperature

Temp. (°C)	LTE Band 2			
	Channel Bandwidth: 5 MHz			
	Low Channel		High Channel	
	Frequency (MHz)	Frequency Error (ppm)	Frequency (MHz)	Frequency Error (ppm)
-30	1852.500003	0.002	1907.500001	0.001
-20	1852.500002	0.001	1907.500001	0.001
-10	1852.500004	0.002	1907.500003	0.002
0	1852.500004	0.002	1907.500004	0.002
10	1852.500002	0.001	1907.500003	0.002
20	1852.499998	-0.001	1907.499998	-0.001
30	1852.499999	-0.001	1907.499997	-0.001
40	1852.499998	-0.001	1907.499997	-0.001
50	1852.499998	-0.001	1907.499998	-0.001
60	1852.499996	-0.002	1907.499998	-0.001

Frequency Error vs. Voltage

Voltage (Volts)	LTE Band 2			
	Channel Bandwidth: 10 MHz			
	Low Channel		High Channel	
	Frequency (MHz)	Frequency Error (ppm)	Frequency (MHz)	Frequency Error (ppm)
3.20	1855.000001	0.001	1905.000004	0.002
3.75	1855.000003	0.001	1905.000003	0.001
4.30	1855.000002	0.001	1905.000001	0.001

Note: The applicant defined the normal working voltage is from 3.20Vdc to 4.30Vdc.

Frequency Error vs. Temperature

Temp. (°C)	LTE Band 2			
	Channel Bandwidth: 10 MHz			
	Low Channel		High Channel	
	Frequency (MHz)	Frequency Error (ppm)	Frequency (MHz)	Frequency Error (ppm)
-30	1855.000002	0.001	1905.000004	0.002
-20	1855.000003	0.001	1905.000004	0.002
-10	1855.000003	0.001	1905.000003	0.001
0	1855.000004	0.002	1905.000001	0.001
10	1855.000001	0.001	1905.000003	0.001
20	1854.999998	-0.001	1904.999999	-0.001
30	1854.999997	-0.002	1904.999998	-0.001
40	1854.999997	-0.002	1904.999998	-0.001
50	1854.999996	-0.002	1904.999999	-0.001
60	1854.999999	-0.001	1904.999999	-0.001

Frequency Error vs. Voltage

Voltage (Volts)	LTE Band 2			
	Channel Bandwidth: 15 MHz			
	Low Channel		High Channel	
	Frequency (MHz)	Frequency Error (ppm)	Frequency (MHz)	Frequency Error (ppm)
3.20	1857.500003	0.002	1902.500004	0.002
3.75	1857.500004	0.002	1902.500003	0.001
4.30	1857.500001	0.001	1902.500002	0.001

Note: The applicant defined the normal working voltage is from 3.20Vdc to 4.30Vdc.

Frequency Error vs. Temperature

Temp. (°C)	LTE Band 2			
	Channel Bandwidth: 15 MHz			
	Low Channel		High Channel	
	Frequency (MHz)	Frequency Error (ppm)	Frequency (MHz)	Frequency Error (ppm)
-30	1857.500003	0.002	1902.500003	0.002
-20	1857.500003	0.001	1902.500003	0.001
-10	1857.500003	0.002	1902.500001	0.001
0	1857.500002	0.001	1902.500002	0.001
10	1857.500002	0.001	1902.500003	0.001
20	1857.499997	-0.002	1902.499996	-0.002
30	1857.499997	-0.002	1902.499997	-0.002
40	1857.499998	-0.001	1902.499998	-0.001
50	1857.499998	-0.001	1902.499998	-0.001
60	1857.499997	-0.002	1902.499999	-0.001

Frequency Error vs. Voltage

Voltage (Volts)	LTE Band 2			
	Channel Bandwidth: 20 MHz			
	Low Channel		High Channel	
	Frequency (MHz)	Frequency Error (ppm)	Frequency (MHz)	Frequency Error (ppm)
3.20	1860.000002	0.001	1900.000003	0.002
3.75	1860.000001	0.001	1900.000001	0.001
4.30	1860.000003	0.001	1900.000004	0.002

Note: The applicant defined the normal working voltage is from 3.20Vdc to 4.30Vdc.

Frequency Error vs. Temperature

Temp. (°C)	LTE Band 2			
	Channel Bandwidth: 20 MHz			
	Low Channel		High Channel	
	Frequency (MHz)	Frequency Error (ppm)	Frequency (MHz)	Frequency Error (ppm)
-30	1860.000004	0.002	1900.000003	0.001
-20	1860.000004	0.002	1900.000002	0.001
-10	1860.000002	0.001	1900.000003	0.002
0	1860.000003	0.001	1900.000001	0.001
10	1860.000001	0.001	1900.000004	0.002
20	1859.999999	-0.001	1899.999996	-0.002
30	1859.999998	-0.001	1899.999998	-0.001
40	1859.999998	-0.001	1899.999998	-0.001
50	1859.999996	-0.002	1899.999999	-0.001
60	1859.999996	-0.002	1899.999997	-0.002

Frequency Error vs. Voltage

Voltage (Volts)	LTE Band 25			
	Channel Bandwidth: 1.4 MHz			
	Low Channel		High Channel	
	Frequency (MHz)	Frequency Error (ppm)	Frequency (MHz)	Frequency Error (ppm)
3.20	1850.700002	0.001	1914.300002	0.001
3.75	1850.700001	0.001	1914.300002	0.001
4.30	1850.700001	0.001	1914.300003	0.001

Note: The applicant defined the normal working voltage is from 3.20Vdc to 4.30Vdc.

Frequency Error vs. Temperature

Temp. (°C)	LTE Band 25			
	Channel Bandwidth: 1.4 MHz			
	Low Channel		High Channel	
	Frequency (MHz)	Frequency Error (ppm)	Frequency (MHz)	Frequency Error (ppm)
-30	1850.700001	0.001	1914.300002	0.001
-20	1850.700002	0.001	1914.300002	0.001
-10	1850.700004	0.002	1914.300003	0.001
0	1850.700002	0.001	1914.300003	0.002
10	1850.700004	0.002	1914.300002	0.001
20	1850.699996	-0.002	1914.299996	-0.002
30	1850.699996	-0.002	1914.299998	-0.001
40	1850.699997	-0.002	1914.299998	-0.001
50	1850.699996	-0.002	1914.299996	-0.002
60	1850.699998	-0.001	1914.299998	-0.001

Frequency Error vs. Voltage

Voltage (Volts)	LTE Band 25			
	Channel Bandwidth: 3 MHz			
	Low Channel		High Channel	
	Frequency (MHz)	Frequency Error (ppm)	Frequency (MHz)	Frequency Error (ppm)
3.20	1851.500004	0.002	1913.500001	0.001
3.75	1851.500003	0.002	1913.500003	0.001
4.30	1851.500001	0.001	1913.500003	0.001

Note: The applicant defined the normal working voltage is from 3.20Vdc to 4.30Vdc.

Frequency Error vs. Temperature

Temp. (°C)	LTE Band 25			
	Channel Bandwidth: 3 MHz			
	Low Channel		High Channel	
	Frequency (MHz)	Frequency Error (ppm)	Frequency (MHz)	Frequency Error (ppm)
-30	1851.500002	0.001	1913.500002	0.001
-20	1851.500004	0.002	1913.500002	0.001
-10	1851.500001	0.001	1913.500004	0.002
0	1851.500001	0.001	1913.500002	0.001
10	1851.500002	0.001	1913.500004	0.002
20	1851.499997	-0.002	1913.499999	-0.001
30	1851.499999	-0.001	1913.499996	-0.002
40	1851.499999	-0.001	1913.499996	-0.002
50	1851.499996	-0.002	1913.499996	-0.002
60	1851.499998	-0.001	1913.499996	-0.002

Frequency Error vs. Voltage

Voltage (Volts)	LTE Band 25			
	Channel Bandwidth: 5 MHz			
	Low Channel		High Channel	
	Frequency (MHz)	Frequency Error (ppm)	Frequency (MHz)	Frequency Error (ppm)
3.20	1852.500004	0.002	1912.500003	0.001
3.75	1852.500003	0.002	1912.500004	0.002
4.30	1852.500002	0.001	1912.500003	0.002

Note: The applicant defined the normal working voltage is from 3.20Vdc to 4.30Vdc.

Frequency Error vs. Temperature

Temp. (°C)	LTE Band 25			
	Channel Bandwidth: 5 MHz			
	Low Channel		High Channel	
	Frequency (MHz)	Frequency Error (ppm)	Frequency (MHz)	Frequency Error (ppm)
-30	1852.500002	0.001	1912.500001	0.001
-20	1852.500003	0.001	1912.500003	0.002
-10	1852.500003	0.002	1912.500002	0.001
0	1852.500002	0.001	1912.500004	0.002
10	1852.500002	0.001	1912.500001	0.001
20	1852.499997	-0.002	1912.499998	-0.001
30	1852.499996	-0.002	1912.499996	-0.002
40	1852.499997	-0.002	1912.499997	-0.002
50	1852.499998	-0.001	1912.499997	-0.002
60	1852.499997	-0.002	1912.499998	-0.001

Frequency Error vs. Voltage

Voltage (Volts)	LTE Band 25			
	Channel Bandwidth: 10 MHz			
	Low Channel		High Channel	
	Frequency (MHz)	Frequency Error (ppm)	Frequency (MHz)	Frequency Error (ppm)
3.20	1855.000004	0.002	1910.000004	0.002
3.75	1855.000003	0.002	1910.000002	0.001
4.30	1855.000001	0.001	1910.000003	0.002

Note: The applicant defined the normal working voltage is from 3.20Vdc to 4.30Vdc.

Frequency Error vs. Temperature

Temp. (°C)	LTE Band 25			
	Channel Bandwidth: 10 MHz			
	Low Channel		High Channel	
	Frequency (MHz)	Frequency Error (ppm)	Frequency (MHz)	Frequency Error (ppm)
-30	1855.000002	0.001	1910.000004	0.002
-20	1855.000002	0.001	1910.000004	0.002
-10	1855.000002	0.001	1910.000002	0.001
0	1855.000004	0.002	1910.000003	0.002
10	1855.000002	0.001	1910.000002	0.001
20	1854.999999	-0.001	1909.999997	-0.002
30	1854.999997	-0.001	1909.999998	-0.001
40	1854.999997	-0.001	1909.999999	-0.001
50	1854.999998	-0.001	1909.999998	-0.001
60	1854.999997	-0.002	1909.999996	-0.002

Frequency Error vs. Voltage

Voltage (Volts)	LTE Band 25			
	Channel Bandwidth: 15 MHz			
	Low Channel		High Channel	
	Frequency (MHz)	Frequency Error (ppm)	Frequency (MHz)	Frequency Error (ppm)
3.20	1857.500002	0.001	1907.500002	0.001
3.75	1857.500002	0.001	1907.500003	0.001
4.30	1857.500002	0.001	1907.500002	0.001

Note: The applicant defined the normal working voltage is from 3.20Vdc to 4.30Vdc.

Frequency Error vs. Temperature

Temp. (°C)	LTE Band 25			
	Channel Bandwidth: 15 MHz			
	Low Channel		High Channel	
	Frequency (MHz)	Frequency Error (ppm)	Frequency (MHz)	Frequency Error (ppm)
-30	1857.500002	0.001	1907.500002	0.001
-20	1857.500002	0.001	1907.500003	0.002
-10	1857.500003	0.002	1907.500003	0.002
0	1857.500004	0.002	1907.500003	0.002
10	1857.500004	0.002	1907.500001	0.001
20	1857.499997	-0.002	1907.499998	-0.001
30	1857.499997	-0.002	1907.499998	-0.001
40	1857.499998	-0.001	1907.499996	-0.002
50	1857.499999	-0.001	1907.499998	-0.001
60	1857.499996	-0.002	1907.499998	-0.001

Frequency Error vs. Voltage

Voltage (Volts)	LTE Band 25			
	Channel Bandwidth: 20 MHz			
	Low Channel		High Channel	
	Frequency (MHz)	Frequency Error (ppm)	Frequency (MHz)	Frequency Error (ppm)
3.20	1860.000003	0.002	1905.000002	0.001
3.75	1860.000002	0.001	1905.000001	0.001
4.30	1860.000003	0.001	1905.000002	0.001

Note: The applicant defined the normal working voltage is from 3.20Vdc to 4.30Vdc.

Frequency Error vs. Temperature

Temp. (°C)	LTE Band 25			
	Channel Bandwidth: 20 MHz			
	Low Channel		High Channel	
	Frequency (MHz)	Frequency Error (ppm)	Frequency (MHz)	Frequency Error (ppm)
-30	1860.000001	0.001	1905.000004	0.002
-20	1860.000003	0.002	1905.000003	0.001
-10	1860.000004	0.002	1905.000003	0.001
0	1860.000002	0.001	1905.000003	0.001
10	1860.000001	0.001	1905.000004	0.002
20	1859.999997	-0.001	1904.999997	-0.002
30	1859.999997	-0.001	1904.999999	-0.001
40	1859.999997	-0.002	1904.999996	-0.002
50	1859.999998	-0.001	1904.999998	-0.001
60	1859.999998	-0.001	1904.999998	-0.001

4.4 Occupied Bandwidth Measurement

4.4.1 Test Procedure

The EUT makes a call to the communication simulator. All measurements were done at low, middle and high operational frequency range. The communication simulator station system controlled a EUT to export maximum output power under transmission mode and specific channel frequency. Use OBW measurement function of Spectrum analyzer to measure 99 % occupied bandwidth.

4.4.2 Test Setup

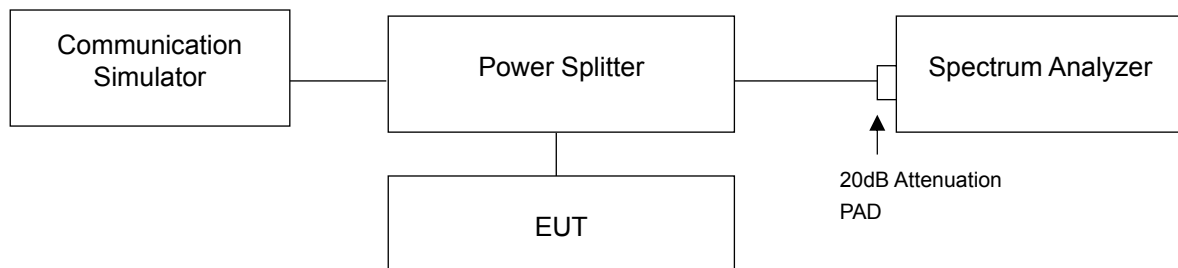

4.4.3 Test Result

Occupied Bandwidth

Channel	Frequency (MHz)	99% Occupied Bandwidth (kHz)		
		PCS	GPRS	EDGE
512	1850.2	250	250	250
661	1880.0	260	260	260
810	1909.8	250	260	250

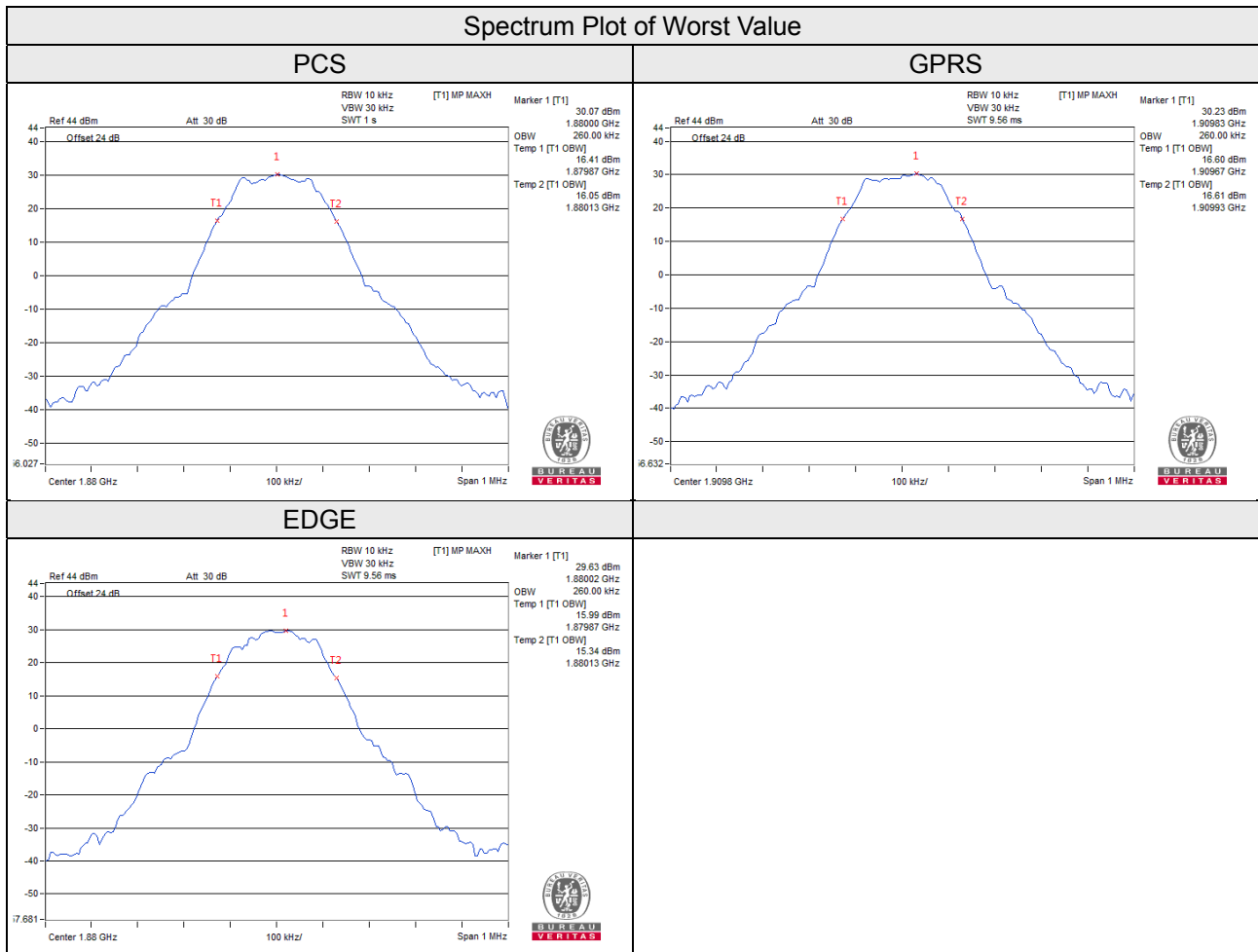

Channel	Frequency (MHz)	99% Occupied Bandwidth (MHz)
		CDMA
25	1851.25	1.26
600	1880.00	1.28
1175	1908.75	1.27

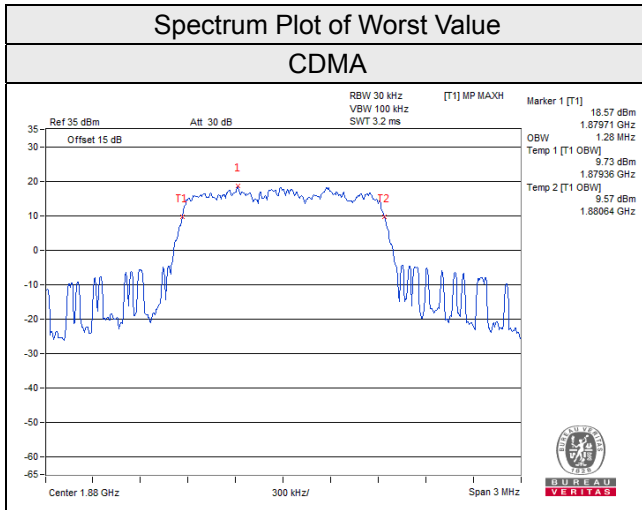

WCDMA Band 2				
Channel	Frequency (MHz)	99% Occupied Bandwidth (MHz)		
		WCDMA	HSDPA	HSUPA
9262	1852.4	4.13	4.13	4.11
9400	1880.0	4.11	4.13	4.13
9538	1907.6	4.13	4.13	4.11

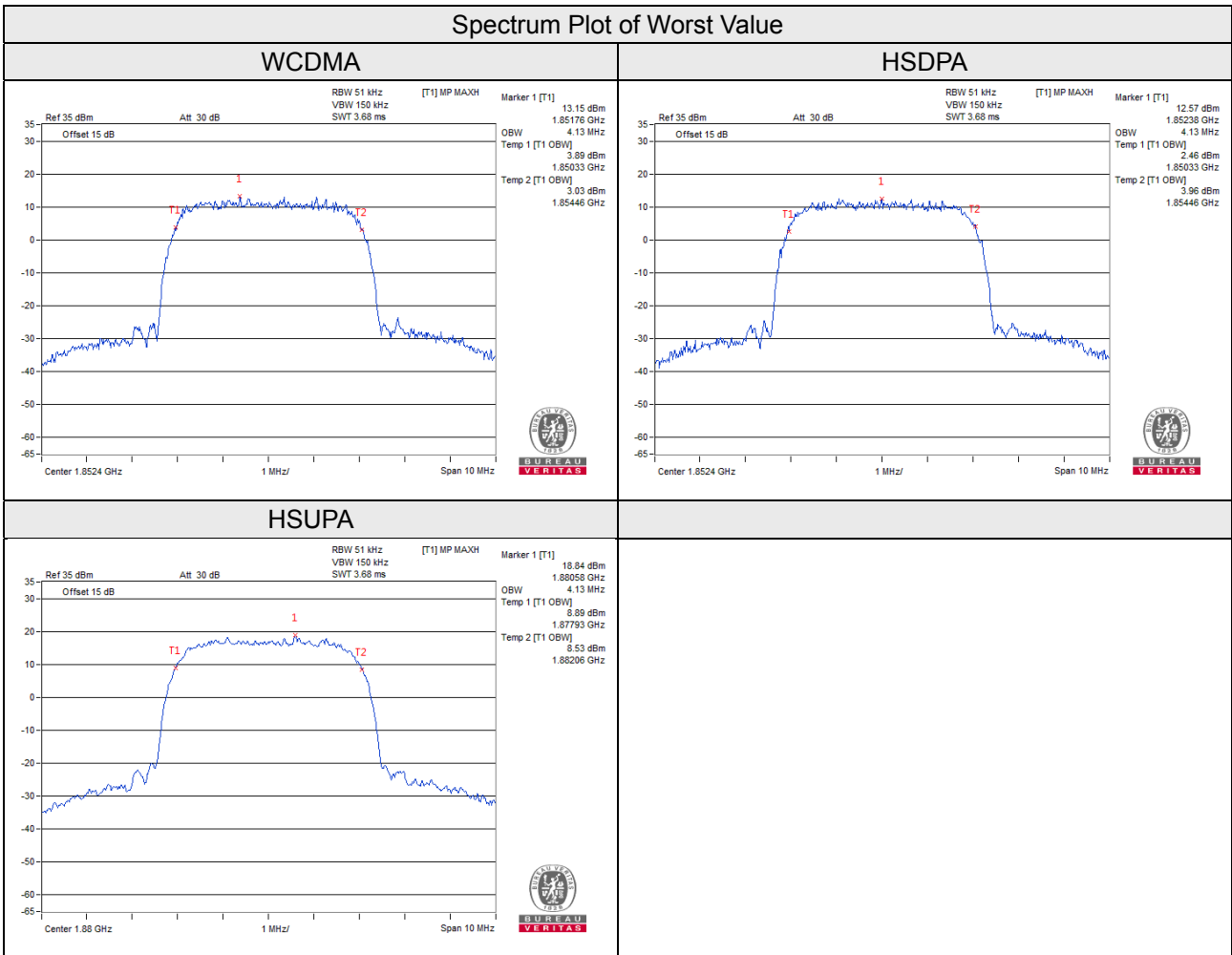

LTE Band 2, Channel Bandwidth 1.4MHz			
Channel	Frequency (MHz)	99% Occupied Bandwidth (MHz)	
		QPSK	16QAM
18607	1850.7	1.09	1.09
18900	1880.0	1.09	1.09
19193	1909.3	1.09	1.09

LTE Band 2, Channel Bandwidth 3MHz			
Channel	Frequency (MHz)	99% Occupied Bandwidth (MHz)	
		QPSK	16QAM
18615	1851.5	2.70	2.70
18900	1880.0	2.70	2.70
19185	1908.5	2.70	2.70

LTE Band 2, Channel Bandwidth 5MHz			
Channel	Frequency (MHz)	99% Occupied Bandwidth (MHz)	
		QPSK	16QAM
18625	1852.5	4.48	4.48
18900	1880.0	4.48	4.48
19175	1907.5	4.49	4.48

LTE Band 2, Channel Bandwidth 10MHz			
Channel	Frequency (MHz)	99% Occupied Bandwidth (MHz)	
		QPSK	16QAM
18650	1855.0	8.96	8.96
18900	1880.0	8.95	8.95
19150	1905.0	8.93	8.93

LTE Band 2, Channel Bandwidth 15MHz			
Channel	Frequency (MHz)	99% Occupied Bandwidth (MHz)	
		QPSK	16QAM
18675	1857.5	13.43	13.42
18900	1880.0	13.40	13.39
19125	1902.5	13.36	13.35

LTE Band 2, Channel Bandwidth 20MHz			
Channel	Frequency (MHz)	99% Occupied Bandwidth (MHz)	
		QPSK	16QAM
18700	1860.0	17.90	17.92
18900	1880.0	17.84	17.87
19100	1900.0	17.82	17.84

Spectrum Plot of Worst Value

1.4MHz / 16QAM



3MHz / QPSK



5MHz / QPSK



10MHz / 16QAM



15MHz / QPSK



20MHz / 16QAM



LTE Band 25, Channel Bandwidth 1.4MHz			
Channel	Frequency (MHz)	99% Occupied Bandwidth (MHz)	
		QPSK	16QAM
26047	1850.7	1.09	1.09
26365	1882.5	1.09	1.09
26683	1914.3	1.09	1.09

LTE Band 25, Channel Bandwidth 3MHz			
Channel	Frequency (MHz)	99% Occupied Bandwidth (MHz)	
		QPSK	16QAM
26055	1851.5	2.70	2.70
26365	1882.5	2.70	2.70
26675	1913.5	2.70	2.70

LTE Band 25, Channel Bandwidth 5MHz			
Channel	Frequency (MHz)	99% Occupied Bandwidth (MHz)	
		QPSK	16QAM
26065	1852.5	4.48	4.49
26365	1882.5	4.49	4.48
26665	1912.5	4.49	4.49

LTE Band 25, Channel Bandwidth 10MHz			
Channel	Frequency (MHz)	99% Occupied Bandwidth (MHz)	
		QPSK	16QAM
26090	1855.0	8.95	8.96
26365	1882.5	8.95	8.95
26640	1910.0	8.99	8.99

LTE Band 25, Channel Bandwidth 15MHz			
Channel	Frequency (MHz)	99% Occupied Bandwidth (MHz)	
		QPSK	16QAM
26115	1857.5	13.43	13.42
26365	1882.5	13.41	13.40
26615	1907.5	13.45	13.43

LTE Band 25, Channel Bandwidth 20MHz			
Channel	Frequency (MHz)	99% Occupied Bandwidth (MHz)	
		QPSK	16QAM
26140	1860.0	17.91	17.93
26365	1882.5	17.86	17.88
26590	1905.0	17.86	17.88

Spectrum Plot of Worst Value

1.4MHz / 16QAM



3MHz / QPSK



5MHz / 16QAM



10MHz / QPSK



15MHz / QPSK



20MHz / 16QAM



26dB Bandwidth

Channel	Frequency (MHz)	26dBc Bandwidth (MHz)		
		PCS	GPRS	EDGE
512	1850.2	0.317	0.318	0.313
661	1880.0	0.314	0.317	0.313
810	1909.8	0.313	0.313	0.314

Spectrum Plot of Worst Value

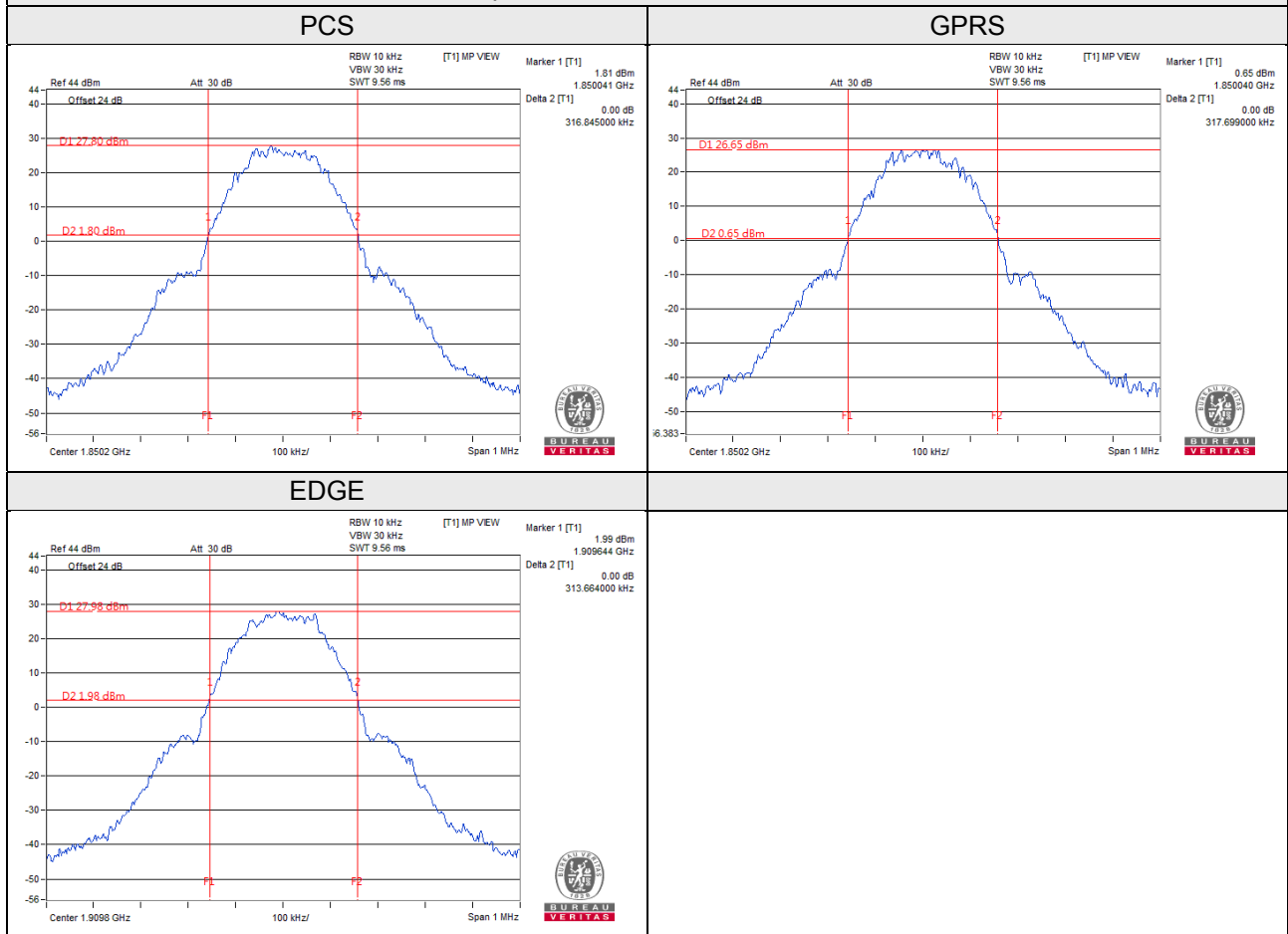

Channel	Frequency (MHz)	26dBc Bandwidth (MHz)
		CDMA
25	1851.25	1.397
600	1880.00	1.420
1175	1908.75	1.421

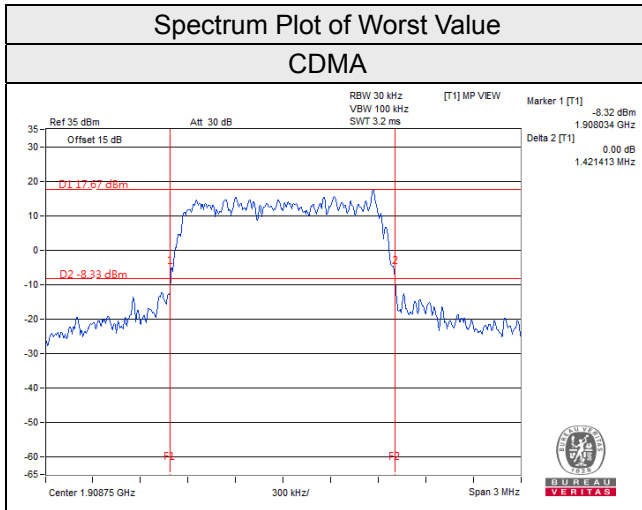

WCDMA Band 2				
Channel	Frequency (MHz)	26dBc Bandwidth (MHz)		
		WCDMA	HSDPA	HSUPA
9262	1852.4	4.700	4.705	4.734
9400	1880.0	4.693	4.719	4.703
9538	1907.6	4.689	4.695	4.672

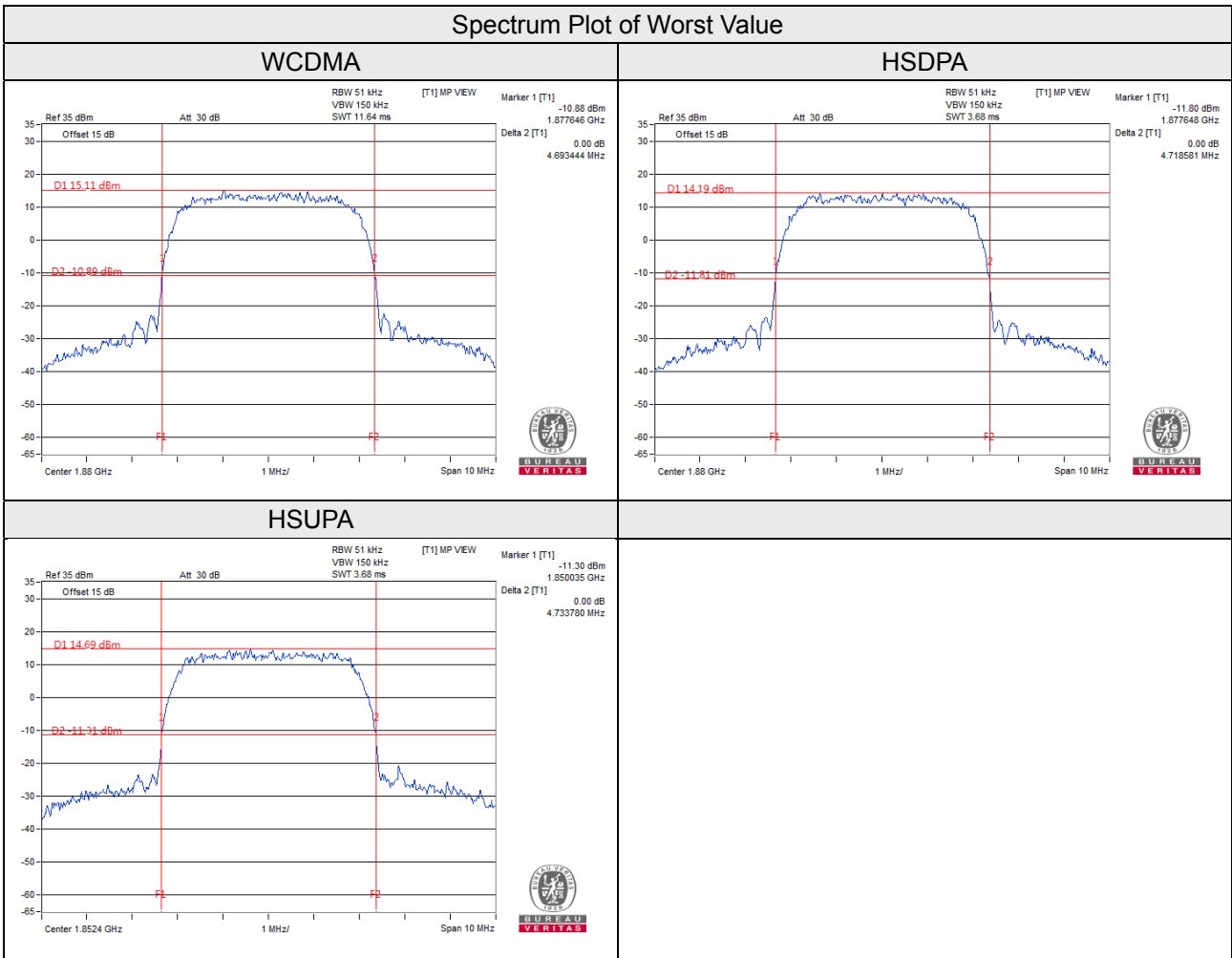

LTE Band 2, Channel Bandwidth 1.4MHz			
Channel	Frequency (MHz)	26dBc Bandwidth (MHz)	
		QPSK	16QAM
18607	1850.7	1.27	1.26
18900	1880.0	1.27	1.28
19193	1909.3	1.28	1.28

LTE Band 2, Channel Bandwidth 3MHz			
Channel	Frequency (MHz)	26dBc Bandwidth (MHz)	
		QPSK	16QAM
18615	1851.5	2.94	2.94
18900	1880.0	2.94	2.93
19185	1908.5	2.94	2.95

LTE Band 2, Channel Bandwidth 5MHz			
Channel	Frequency (MHz)	26dBc Bandwidth (MHz)	
		QPSK	16QAM
18625	1852.5	4.82	4.83
18900	1880.0	4.80	4.82
19175	1907.5	4.80	4.83

LTE Band 2, Channel Bandwidth 10MHz			
Channel	Frequency (MHz)	26dBc Bandwidth (MHz)	
		QPSK	16QAM
18650	1855.0	9.53	9.51
18900	1880.0	9.56	9.51
19150	1905.0	9.48	9.50

LTE Band 2, Channel Bandwidth 15MHz			
Channel	Frequency (MHz)	26dBc Bandwidth (MHz)	
		QPSK	16QAM
18675	1857.5	14.26	14.23
18900	1880.0	14.22	14.22
19125	1902.5	14.19	14.18

LTE Band 2, Channel Bandwidth 20MHz			
Channel	Frequency (MHz)	26dBc Bandwidth (MHz)	
		QPSK	16QAM
18700	1860.0	19.02	19.03
18900	1880.0	18.97	19.00
19100	1900.0	18.96	18.97

Spectrum Plot of Worst Value

1.4MHz / 16QAM

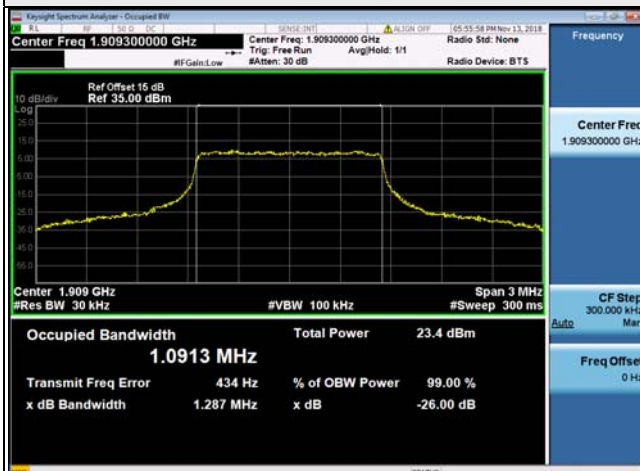

3MHz / 16QAM



5MHz / 16QAM

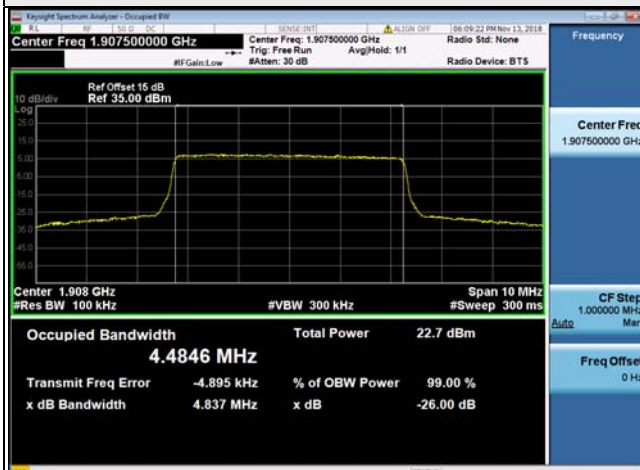

10MHz / QPSK



15MHz / QPSK



20MHz / 16QAM



LTE Band 25, Channel Bandwidth 1.4MHz			
Channel	Frequency (MHz)	26dBc Bandwidth (MHz)	
		QPSK	16QAM
26047	1850.7	1.27	1.27
26365	1882.5	1.27	1.27
26683	1914.3	1.30	1.28

LTE Band 25, Channel Bandwidth 3MHz			
Channel	Frequency (MHz)	26dBc Bandwidth (MHz)	
		QPSK	16QAM
26055	1851.5	2.93	2.94
26365	1882.5	2.93	2.94
26675	1913.5	2.94	2.94

LTE Band 25, Channel Bandwidth 5MHz			
Channel	Frequency (MHz)	26dBc Bandwidth (MHz)	
		QPSK	16QAM
26065	1852.5	4.81	4.83
26365	1882.5	4.83	4.83
26665	1912.5	4.85	4.87

LTE Band 25, Channel Bandwidth 10MHz			
Channel	Frequency (MHz)	26dBc Bandwidth (MHz)	
		QPSK	16QAM
26090	1855.0	9.53	9.52
26365	1882.5	9.52	9.52
26640	1910.0	9.61	9.58

LTE Band 25, Channel Bandwidth 15MHz			
Channel	Frequency (MHz)	26dBc Bandwidth (MHz)	
		QPSK	16QAM
26115	1857.5	14.26	14.25
26365	1882.5	14.23	14.21
26615	1907.5	14.27	14.24

LTE Band 25, Channel Bandwidth 20MHz			
Channel	Frequency (MHz)	26dBc Bandwidth (MHz)	
		QPSK	16QAM
26140	1860.0	19.03	19.03
26365	1882.5	19.00	18.99
26590	1905.0	18.99	19.00

Spectrum Plot of Worst Value

1.4MHz / QPSK



3MHz / QPSK



5MHz / 16QAM



10MHz / QPSK



15MHz / QPSK



20MHz / QPSK



4.5 Band Edge Measurement

4.5.1 Limits of Band Edge Measurement

Power of any emission outside of the authorized operating frequency ranges must be attenuated below the transmitting power (P) by a factor of at least $43 + 10 \log(P)$ dB. In the 1 MHz bands immediately outside and adjacent to the frequency block a resolution bandwidth of at least one percent of the emission bandwidth of the fundamental emission of the transmitter may be employed.

4.5.2 Test Setup

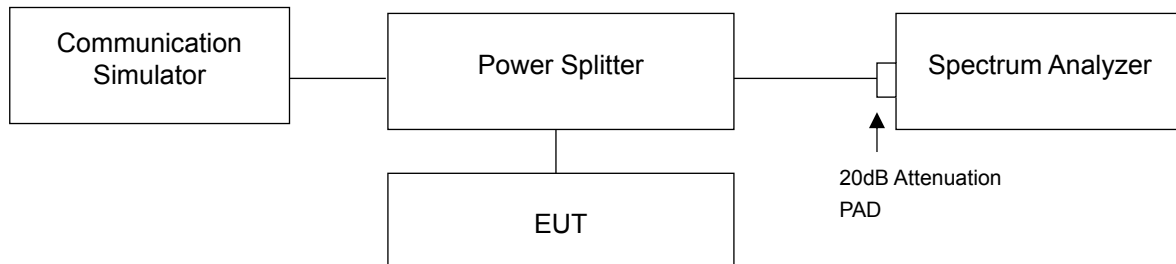

4.5.3 Test Procedures

- a. All measurements were done at low and high operational frequency range.
- b. The center frequency of spectrum is the band edge frequency and span is 1.5MHz. RB of the spectrum is 10kHz and VB of the spectrum is 30kHz (PCS / GPRS / EDGE).
- c. The center frequency of spectrum is the band edge frequency and span is 3MHz. RB of the spectrum is 15kHz and VB of the spectrum is 51kHz (CDMA).
- d. The center frequency of spectrum is the band edge frequency and span is 10MHz. RB of the spectrum is 51kHz and VB of the spectrum is 150kHz (WCDMA / HSDPA / HSUPA).
- e. The center frequency of spectrum is the band edge frequency and span is 1.5MHz. RB of the spectrum is 15kHz and VB of the spectrum is 51kHz (LTE Channel Bandwidth 1.4MHz).
- f. The center frequency of spectrum is the band edge frequency and span is 1.5MHz. RB of the spectrum is 30kHz and VB of the spectrum is 100kHz (LTE Channel Bandwidth 3MHz).
- g. The center frequency of spectrum is the band edge frequency and span is 1.5MHz. RB of the spectrum is 62kHz and VB of the spectrum is 200kHz (LTE Channel Bandwidth 5MHz).
- h. The center frequency of spectrum is the band edge frequency and span is 1.5MHz. RB of the spectrum is 100kHz and VB of the spectrum is 300kHz (LTE Channel Bandwidth 10MHz).
- i. The center frequency of spectrum is the band edge frequency and span is 1.5MHz. RB of the spectrum is 150kHz and VB of the spectrum is 470kHz (LTE Channel Bandwidth 15MHz).
- j. Record the max trace plot into the test report.

4.5.4 Test Results

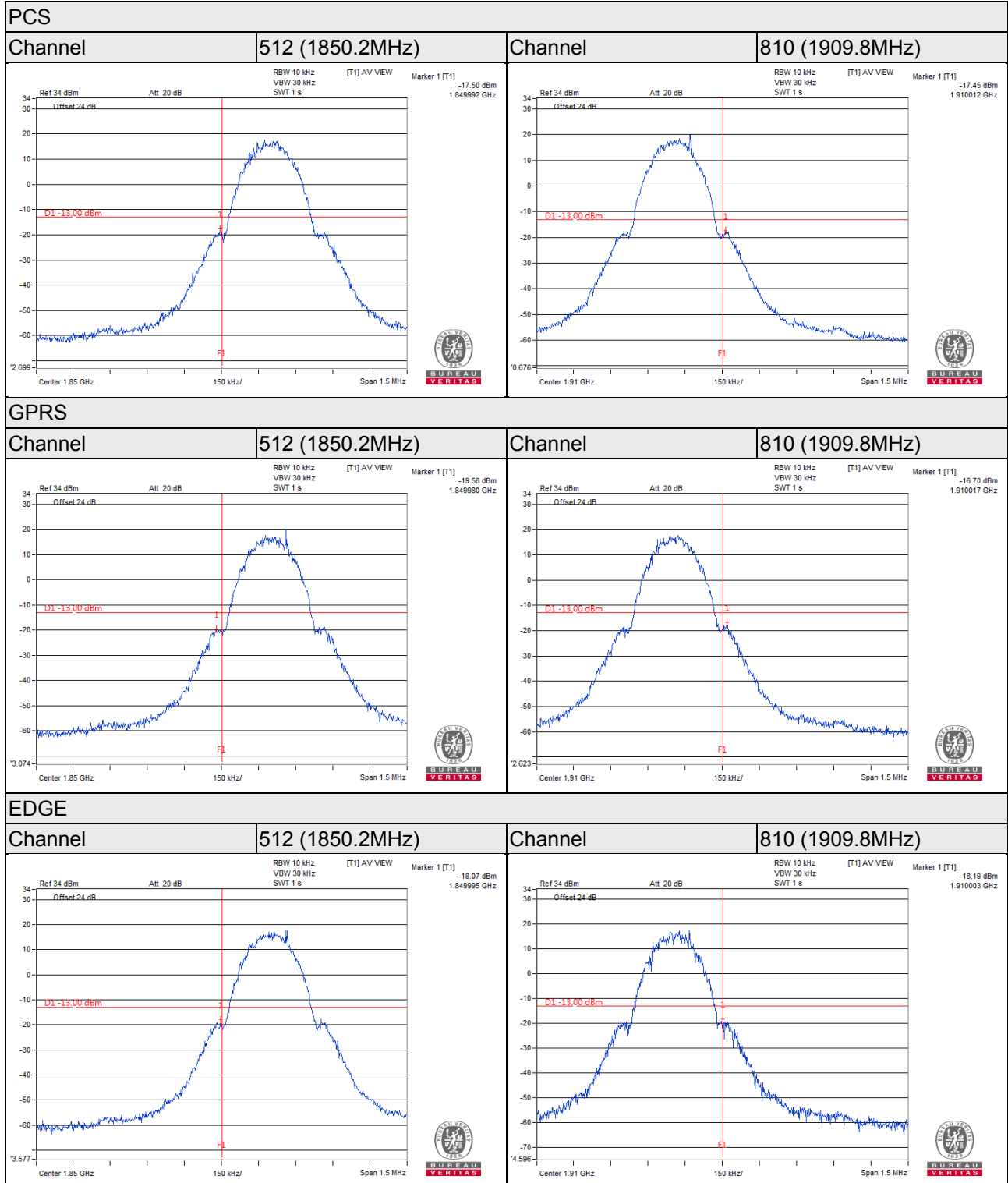

CDMA

Channel 25 (1851.25MHz)	Channel 1175 (1908.75MHz)
--------------------------------	----------------------------------

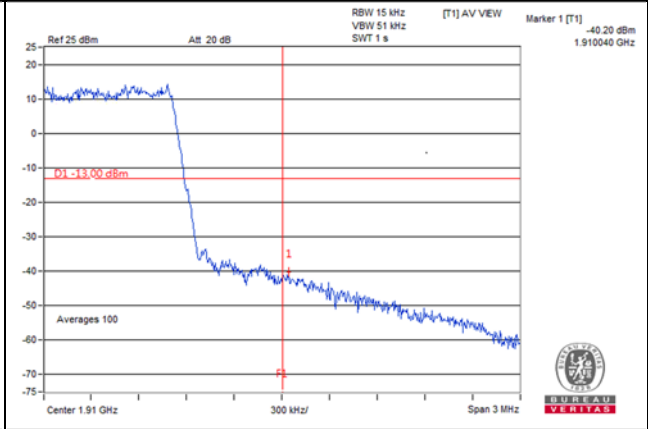
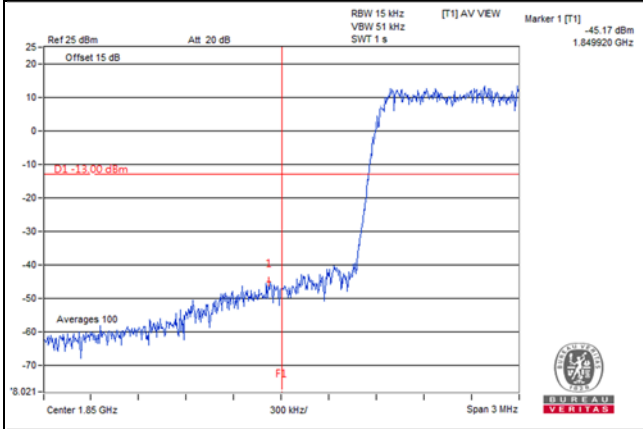

WCDMA

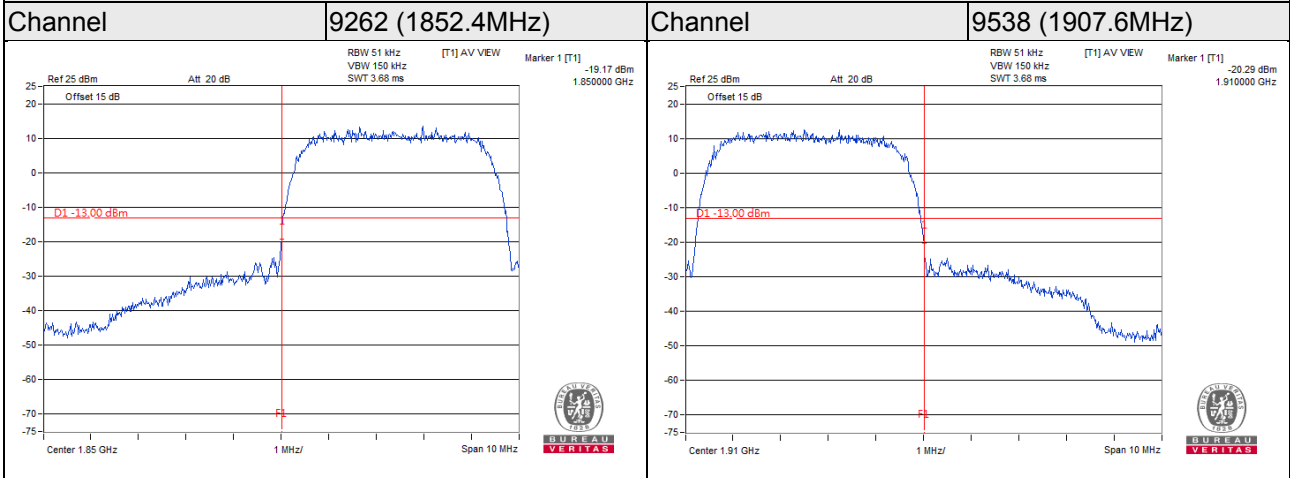

HSDPA

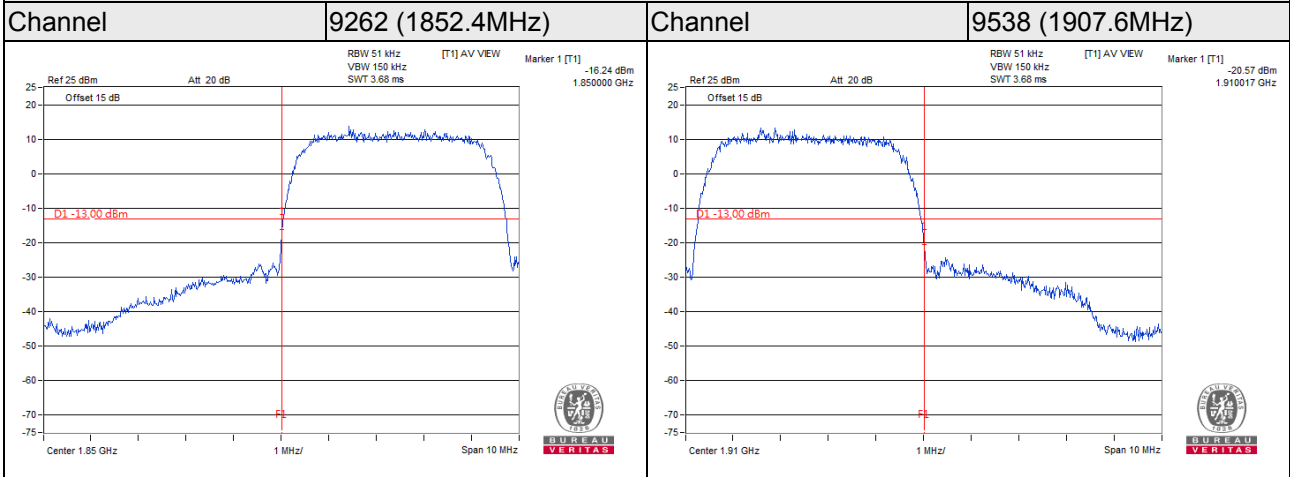

HSUPA

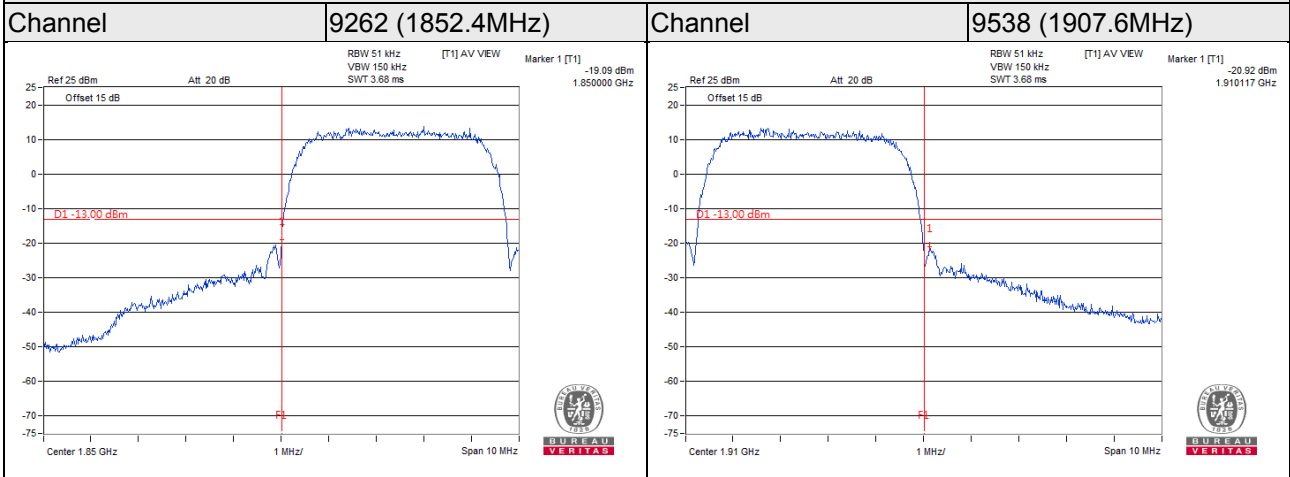

LTE Band 2, Channel Bandwidth 1.4MHz

Channel 18607
(1850.70MHz)

QPSK

1 RB / 0 RB Offset

Channel 19193
(1909.30MHz)

QPSK

1 RB / 5 RB Offset

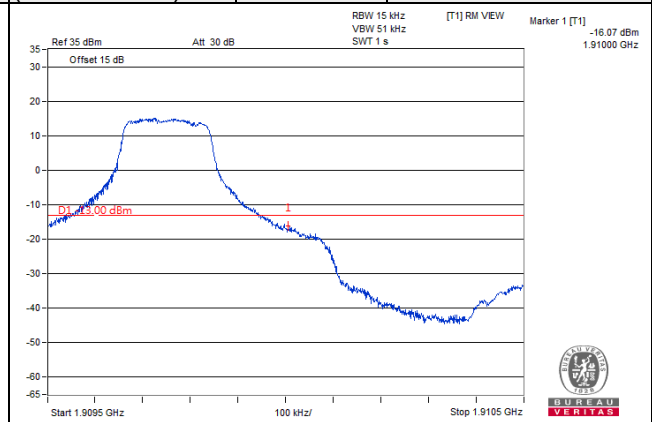
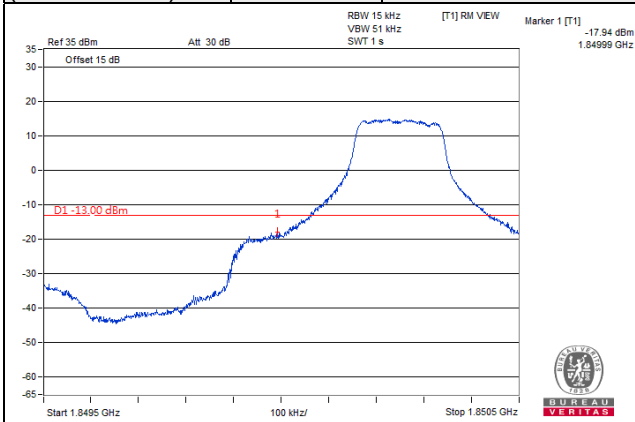

Channel 18607
(1850.70MHz)

QPSK

6 RB / 0 RB Offset

Channel 19193
(1909.30MHz)

QPSK

6 RB / 0 RB Offset

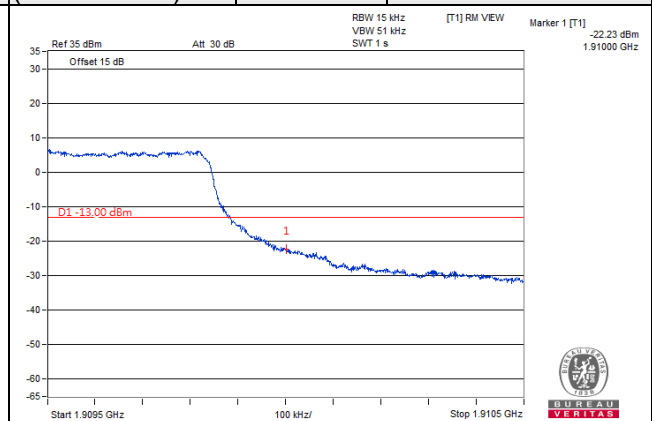
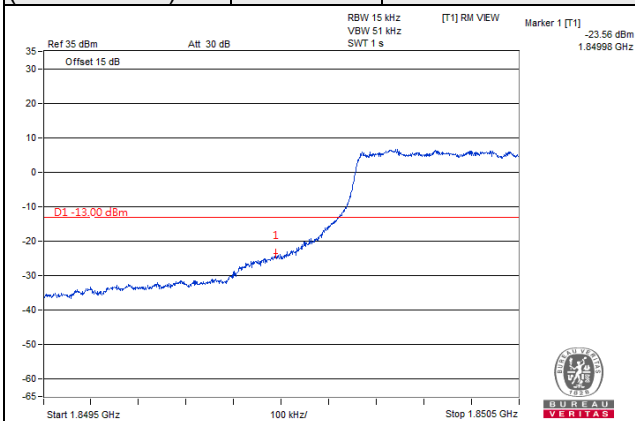

LTE Band 2, Channel Bandwidth 3MHz

Channel 18615 (1851.50MHz)	QPSK	1 RB / 0 RB Offset	Channel 19185 (1908.50MHz)	QPSK	1 RB / 14 RB Offset
---------------------------------------	-------------	---------------------------	---------------------------------------	-------------	----------------------------

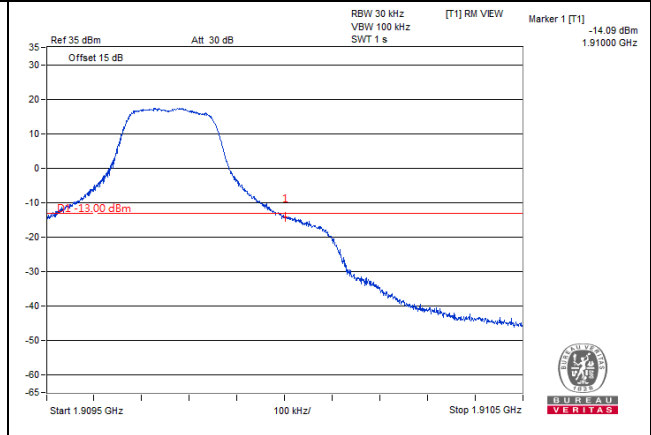
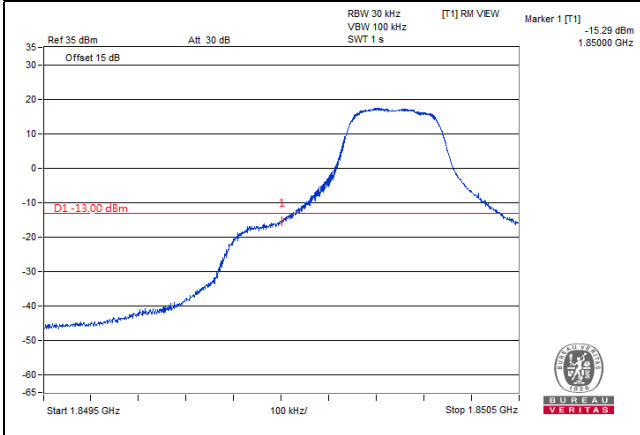

Channel 18615 (1851.50MHz)	QPSK	15 RB / 0 RB Offset	Channel 19185 (1908.50MHz)	QPSK	15 RB / 0 RB Offset
---------------------------------------	-------------	----------------------------	---------------------------------------	-------------	----------------------------

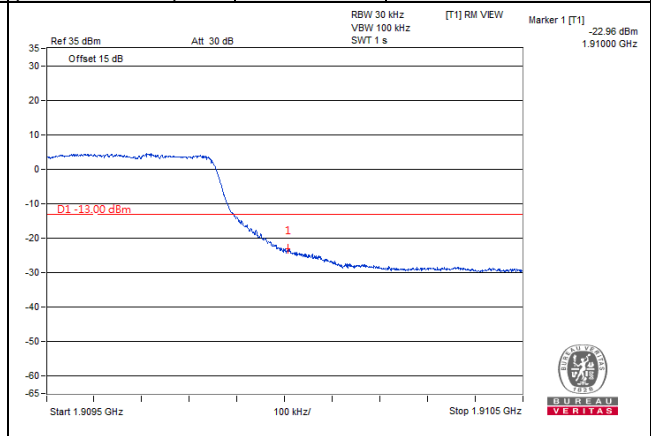
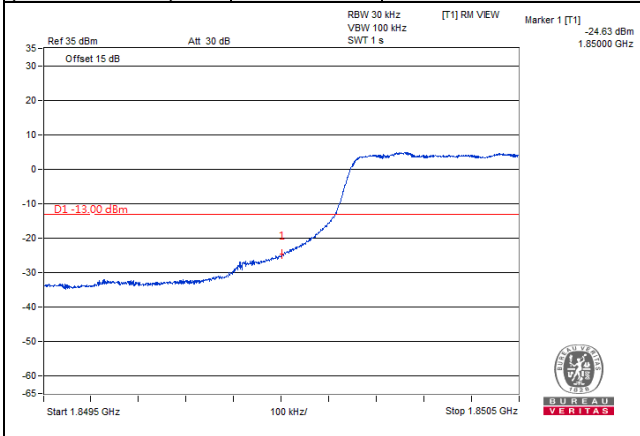

LTE Band 2, Channel Bandwidth 5MHz

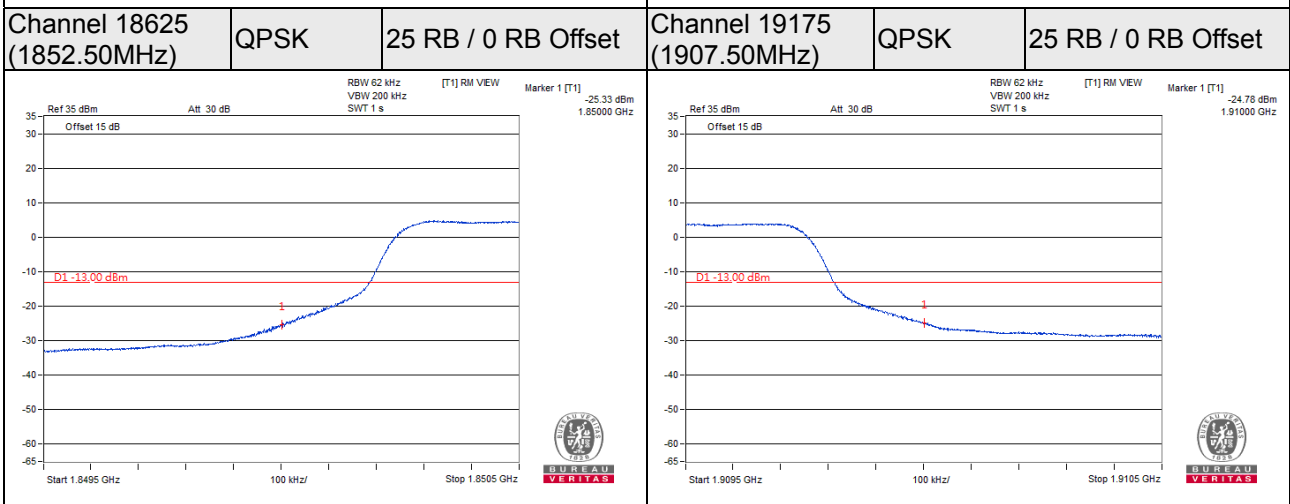
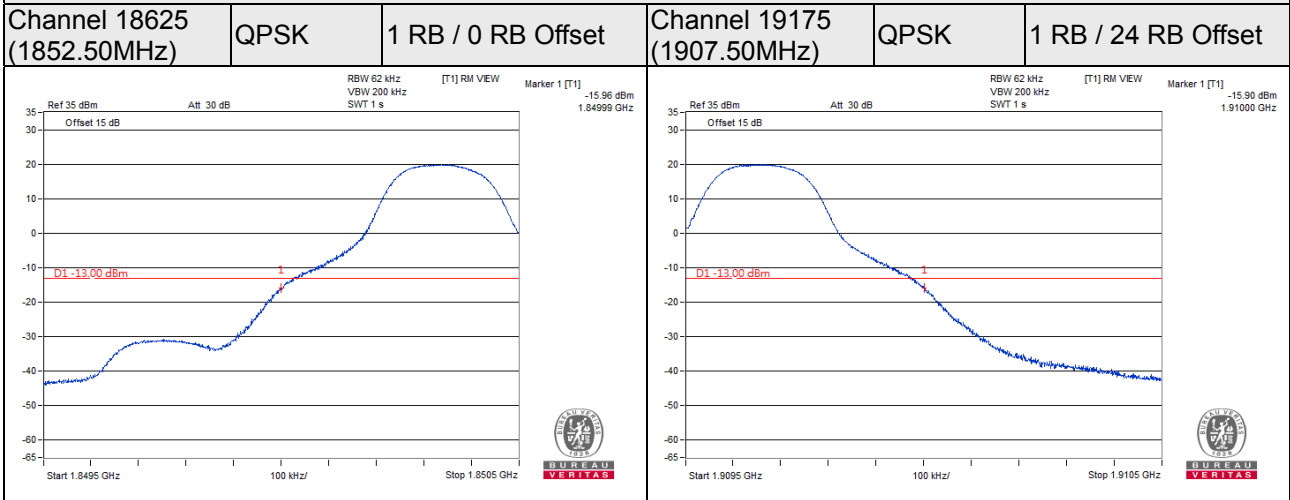

LTE Band 2, Channel Bandwidth 10MHz

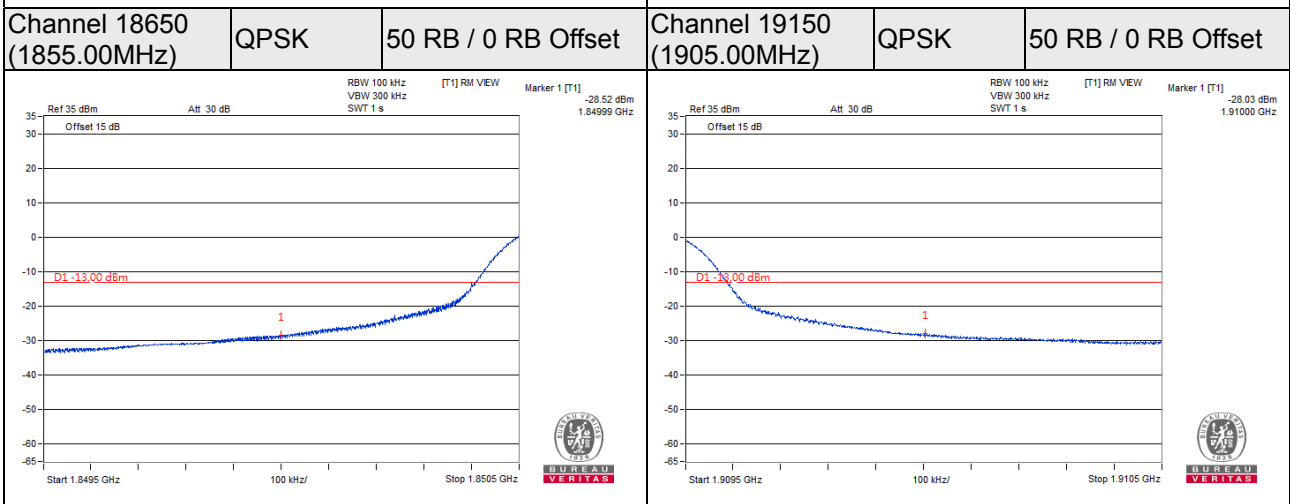
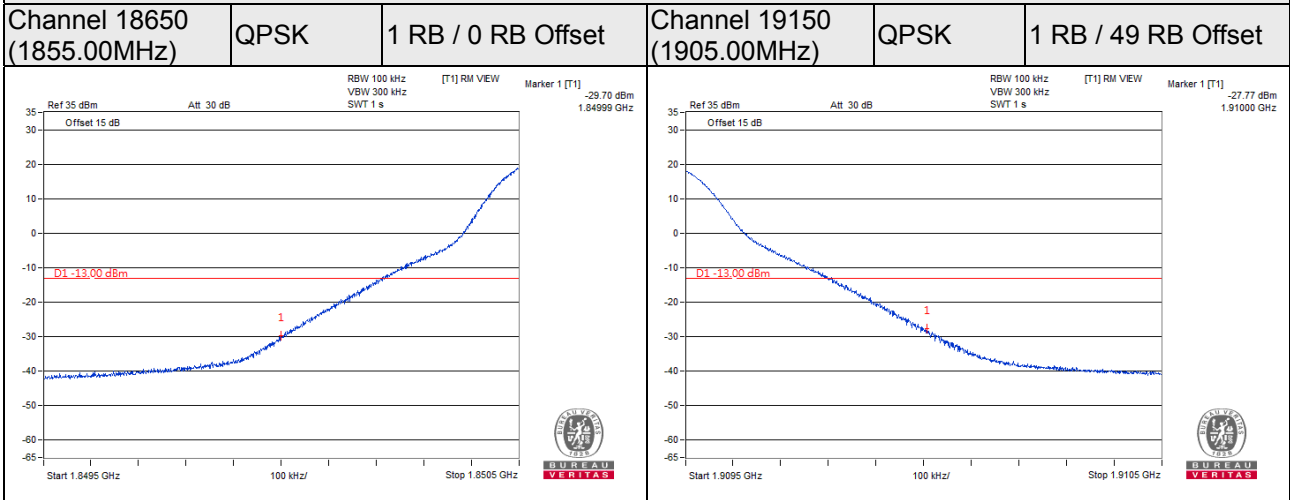

LTE Band 2, Channel Bandwidth 15MHz

Channel 18675 (1857.50MHz)	QPSK	1 RB / 0 RB Offset	Channel 19125 (1902.50MHz)	QPSK	1 RB / 74 RB Offset
-------------------------------	------	--------------------	-------------------------------	------	---------------------

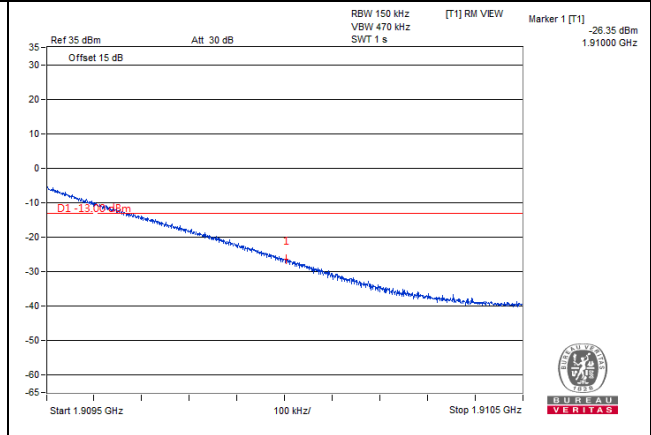
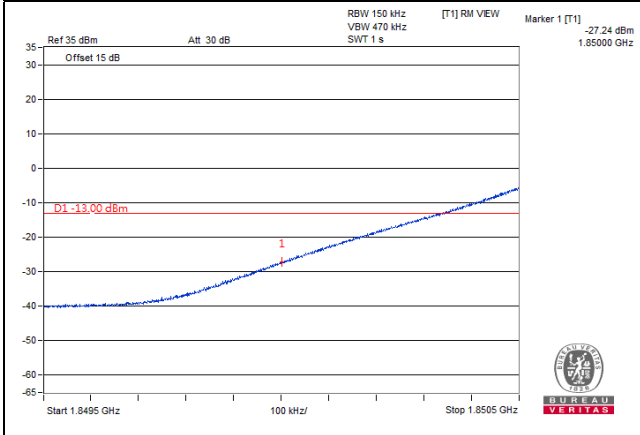

Channel 18675 (1857.50MHz)	QPSK	75 RB / 0 RB Offset	Channel 19125 (1902.50MHz)	QPSK	75 RB / 0 RB Offset
-------------------------------	------	---------------------	-------------------------------	------	---------------------

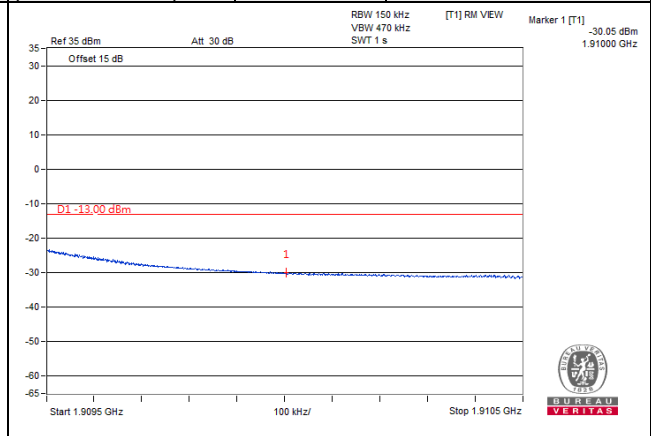
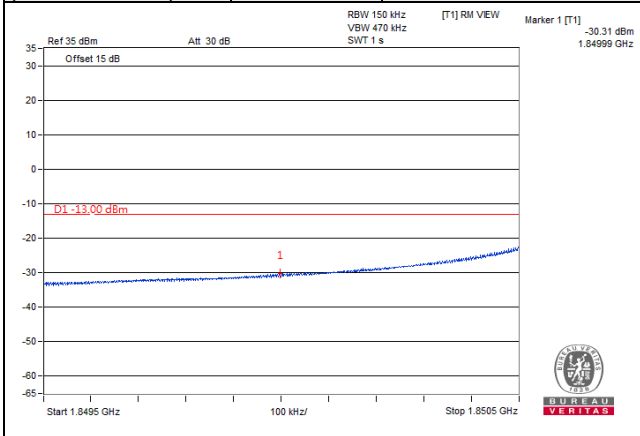

LTE Band 2, Channel Bandwidth 20MHz

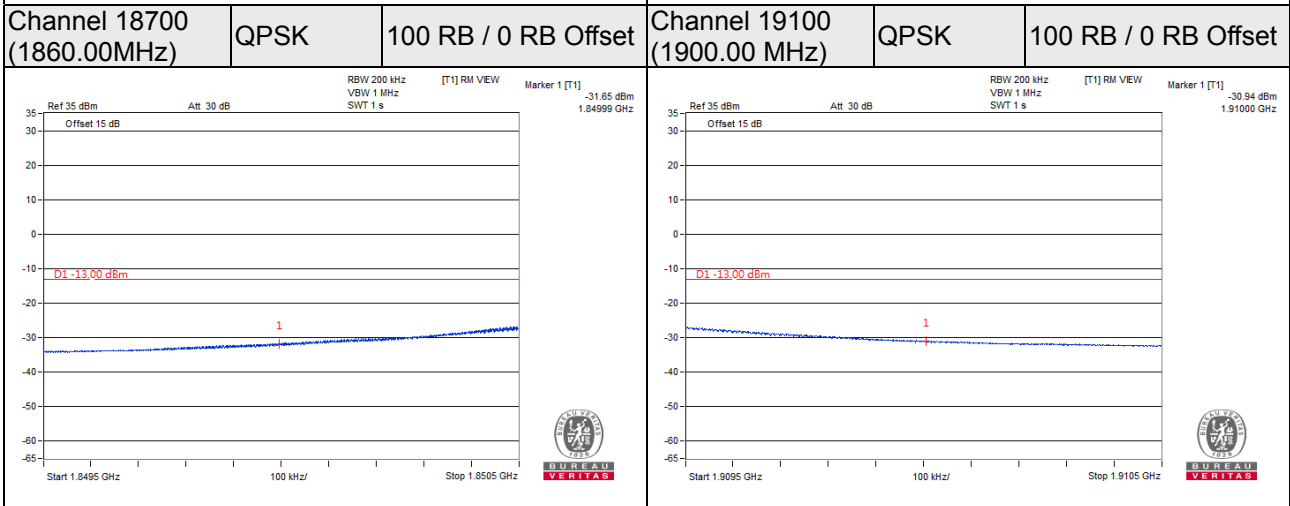
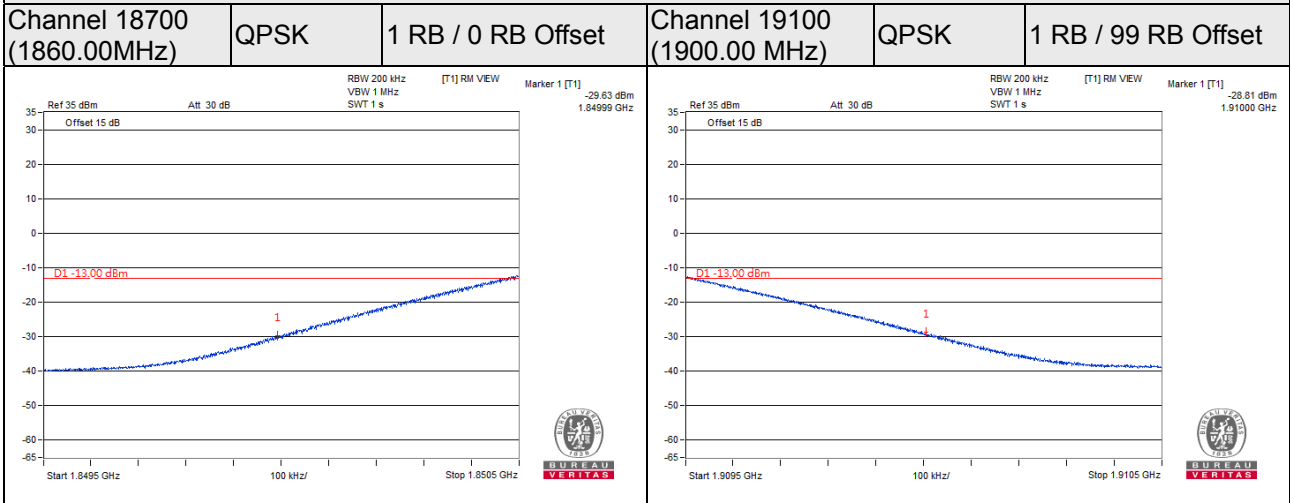

LTE Band 25, Channel Bandwidth 1.4MHz

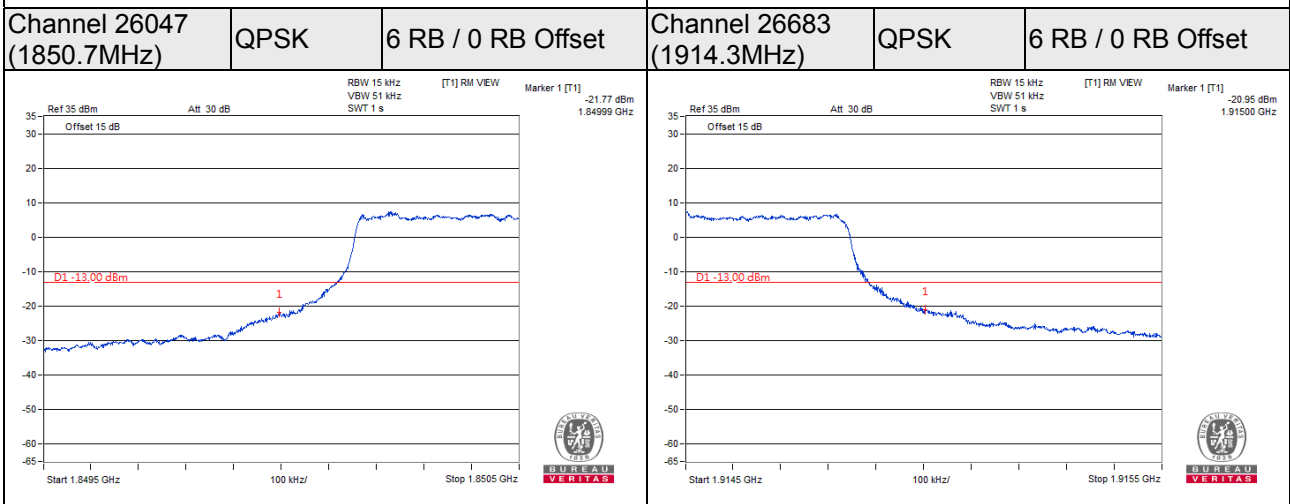
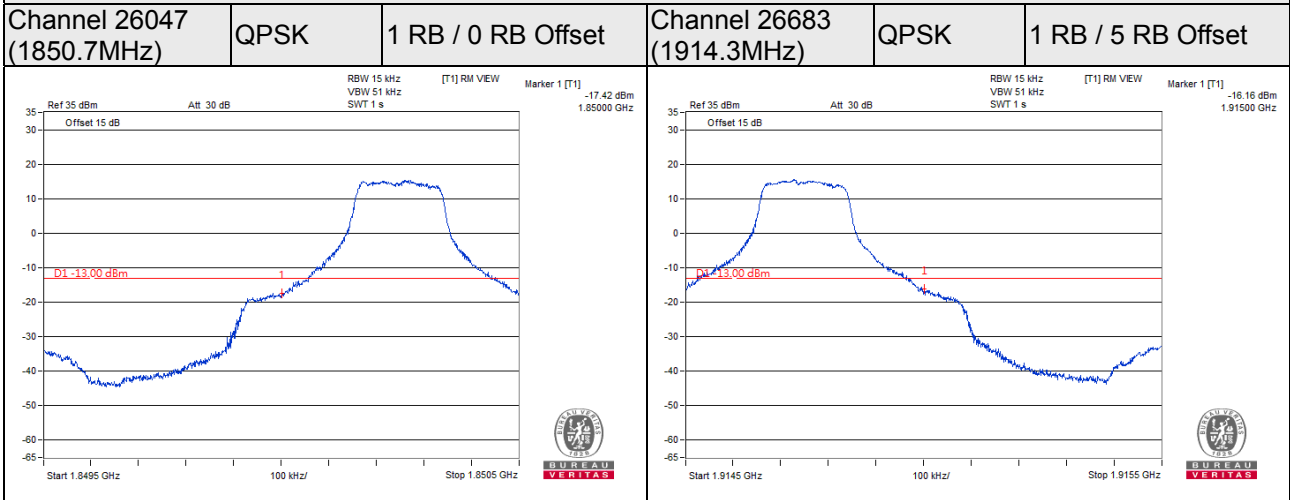

LTE Band 25, Channel Bandwidth 3MHz

Channel 26055 (1851.5MHz)	QPSK	1 RB / 0 RB Offset	Channel 26675 (1913.5MHz)	QPSK	1 RB / 14 RB Offset
------------------------------	------	--------------------	------------------------------	------	---------------------

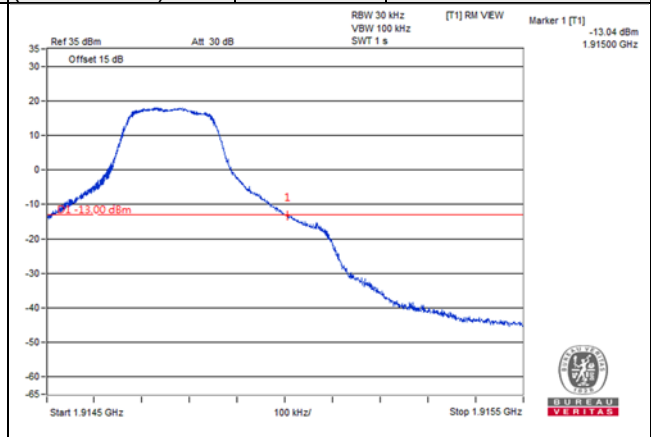
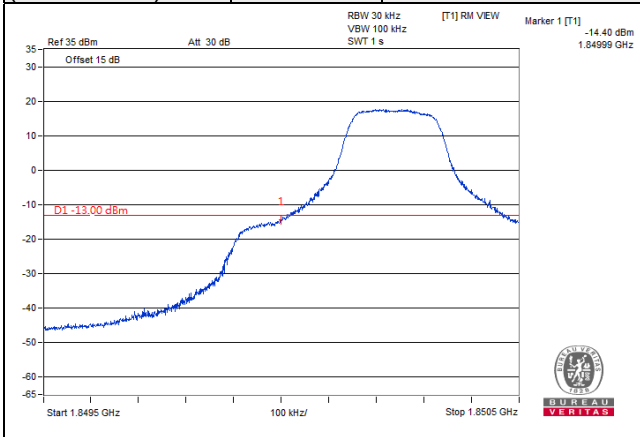

Channel 26055 (1851.5MHz)	QPSK	15 RB / 0 RB Offset	Channel 26675 (1913.5MHz)	QPSK	15 RB / 0 RB Offset
------------------------------	------	---------------------	------------------------------	------	---------------------

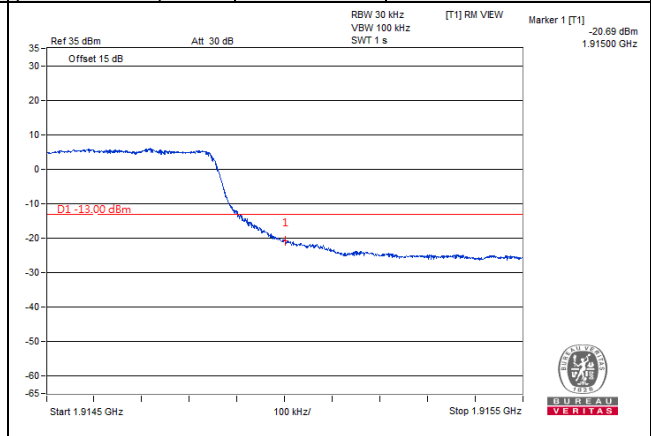
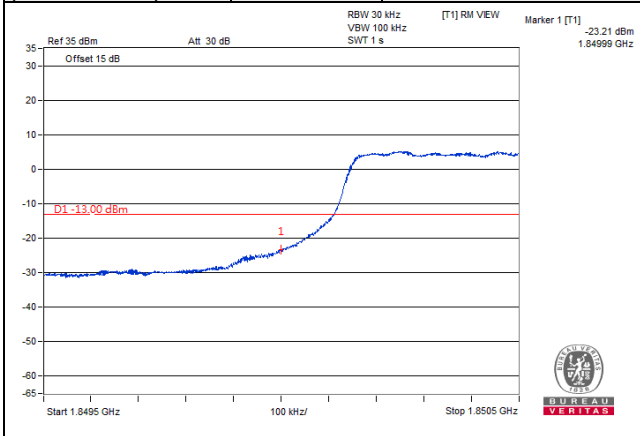

LTE Band 25, Channel Bandwidth 5MHz

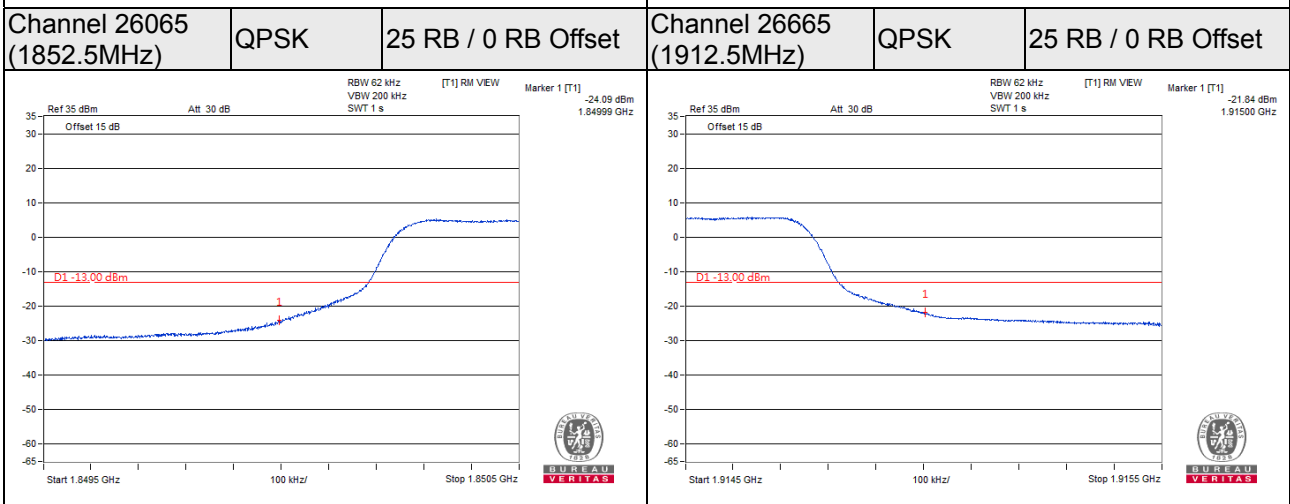
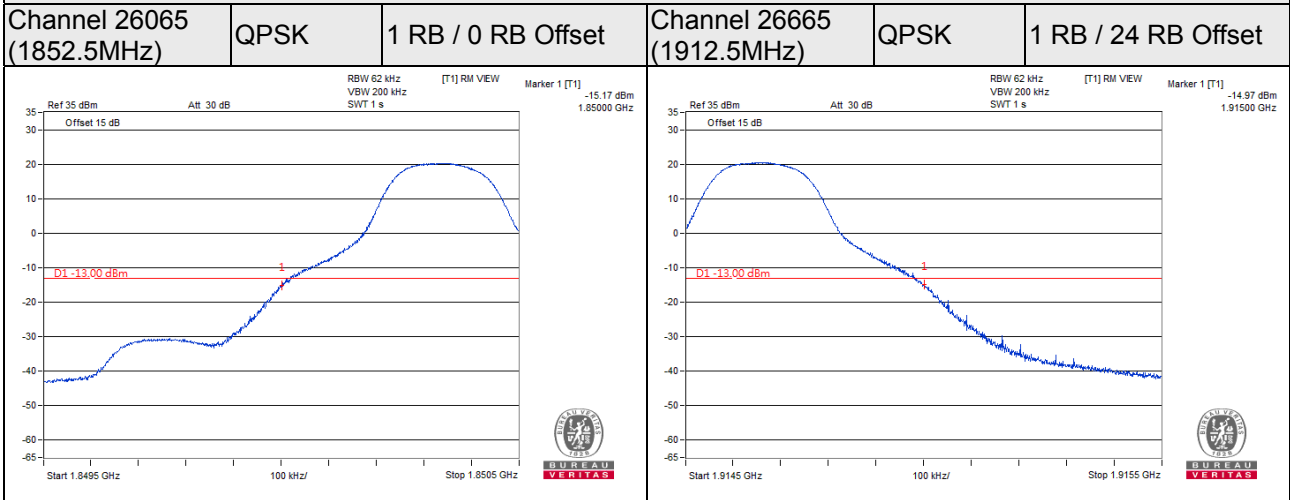

LTE Band 25, Channel Bandwidth 10MHz

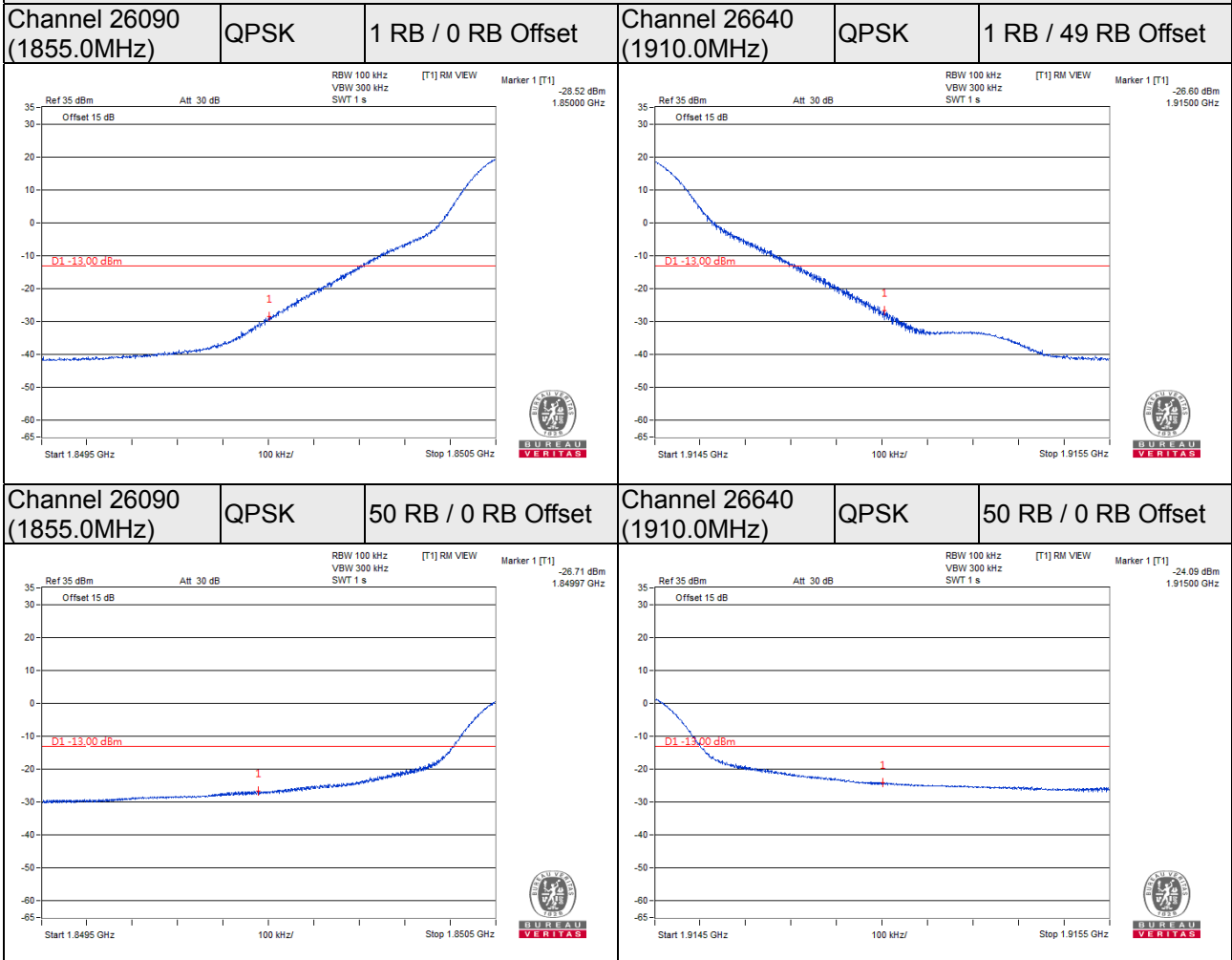

LTE Band 25, Channel Bandwidth 15MHz

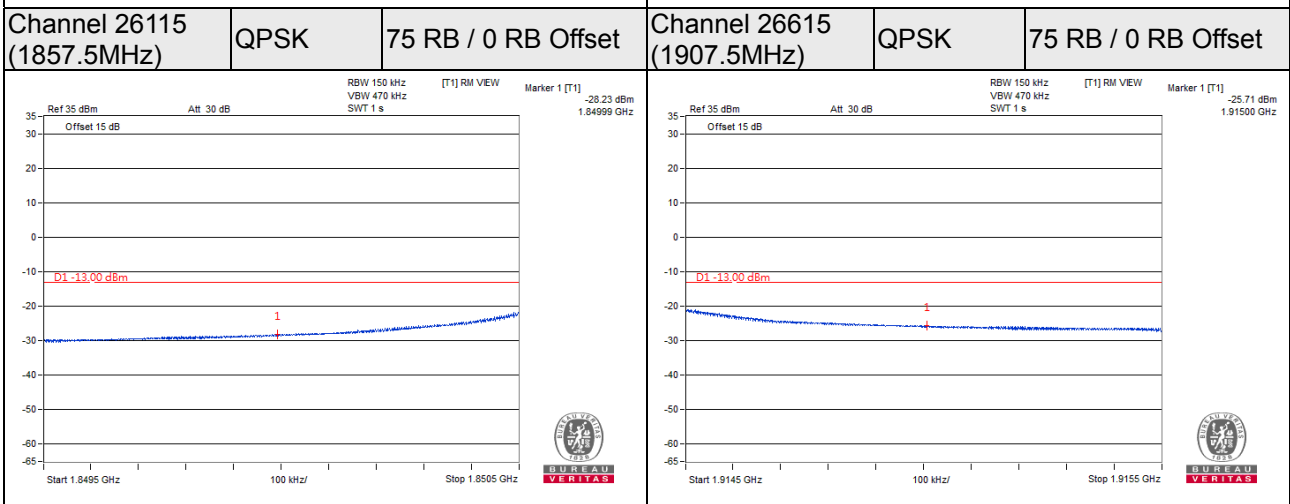
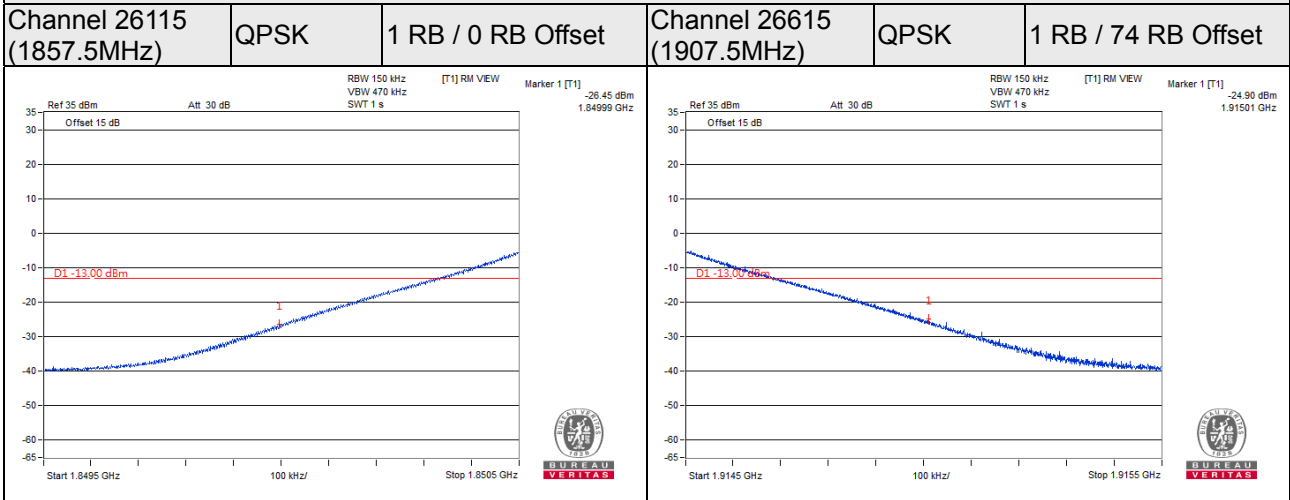

LTE Band 25, Channel Bandwidth 20MHz

Channel 26140 (1860.0MHz)	QPSK	1 RB / 0 RB Offset	Channel 26590 (1905.0MHz)	QPSK	1 RB / 99 RB Offset
------------------------------	------	--------------------	------------------------------	------	---------------------

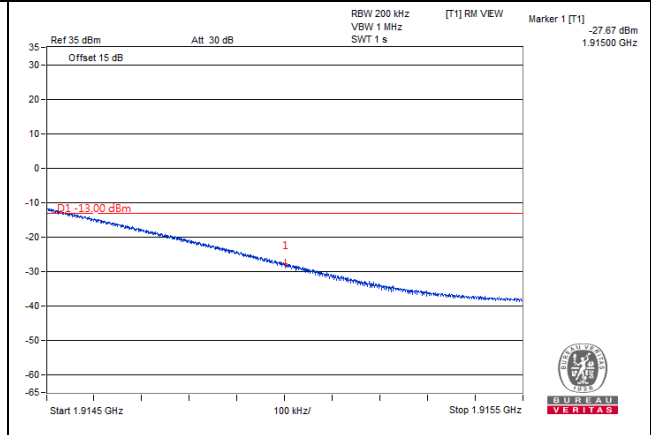
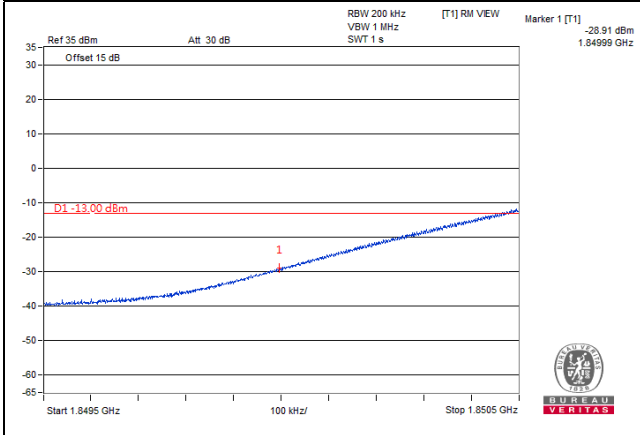

Channel 26140 (1860.0MHz)	QPSK	100 RB / 0 RB Offset	Channel 26590 (1905.0MHz)	QPSK	100 RB / 0 RB Offset
------------------------------	------	----------------------	------------------------------	------	----------------------

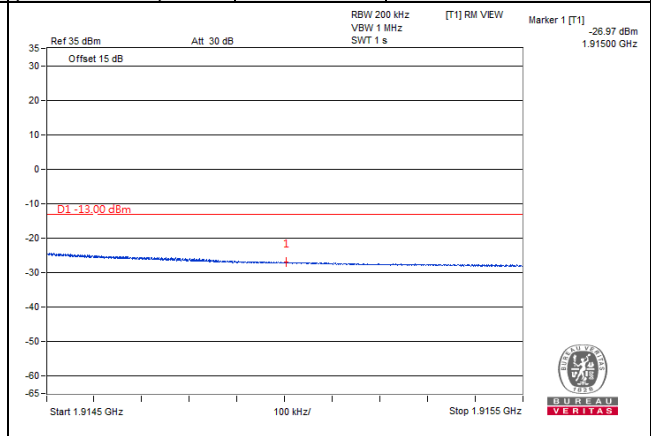
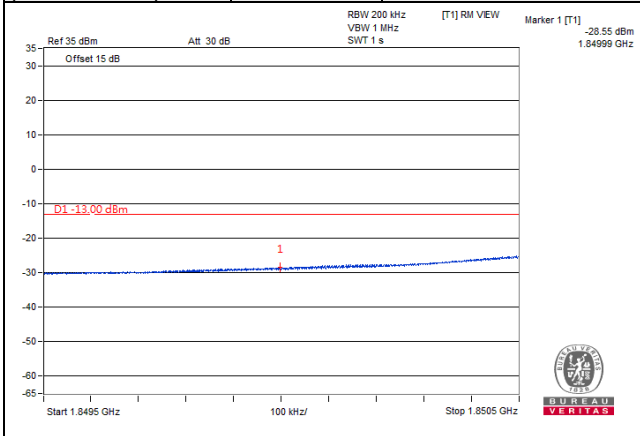

4.6 Peak to Average Ratio

4.6.1 Limits of Peak to Average Ratio Measurement

In measuring transmissions in this band using an average power technique, the peak to-average ratio (PAR) of the transmission may not exceed 13 dB

4.6.2 Test Setup

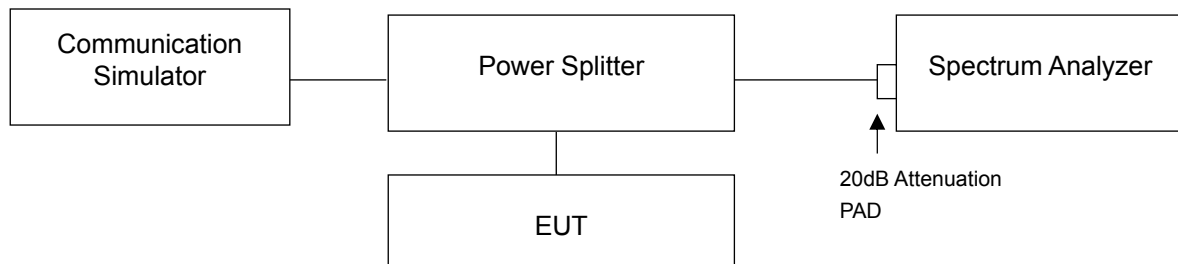

4.6.3 Test Procedures

- Set resolution/measurement bandwidth \geq signal's occupied bandwidth;
- Set the number of counts to a value that stabilizes the measured CCDF curve;
- Record the maximum PAPR level associated with a probability of 0.1%.

4.6.4 Test Results

Channel	Frequency (MHz)	Peak To Average Ratio (dB)		
		PCS	GPRS	EDGE
512	1850.2	2.70	2.70	2.78
661	1880.0	2.79	2.79	2.79
810	1909.8	2.80	2.80	2.80

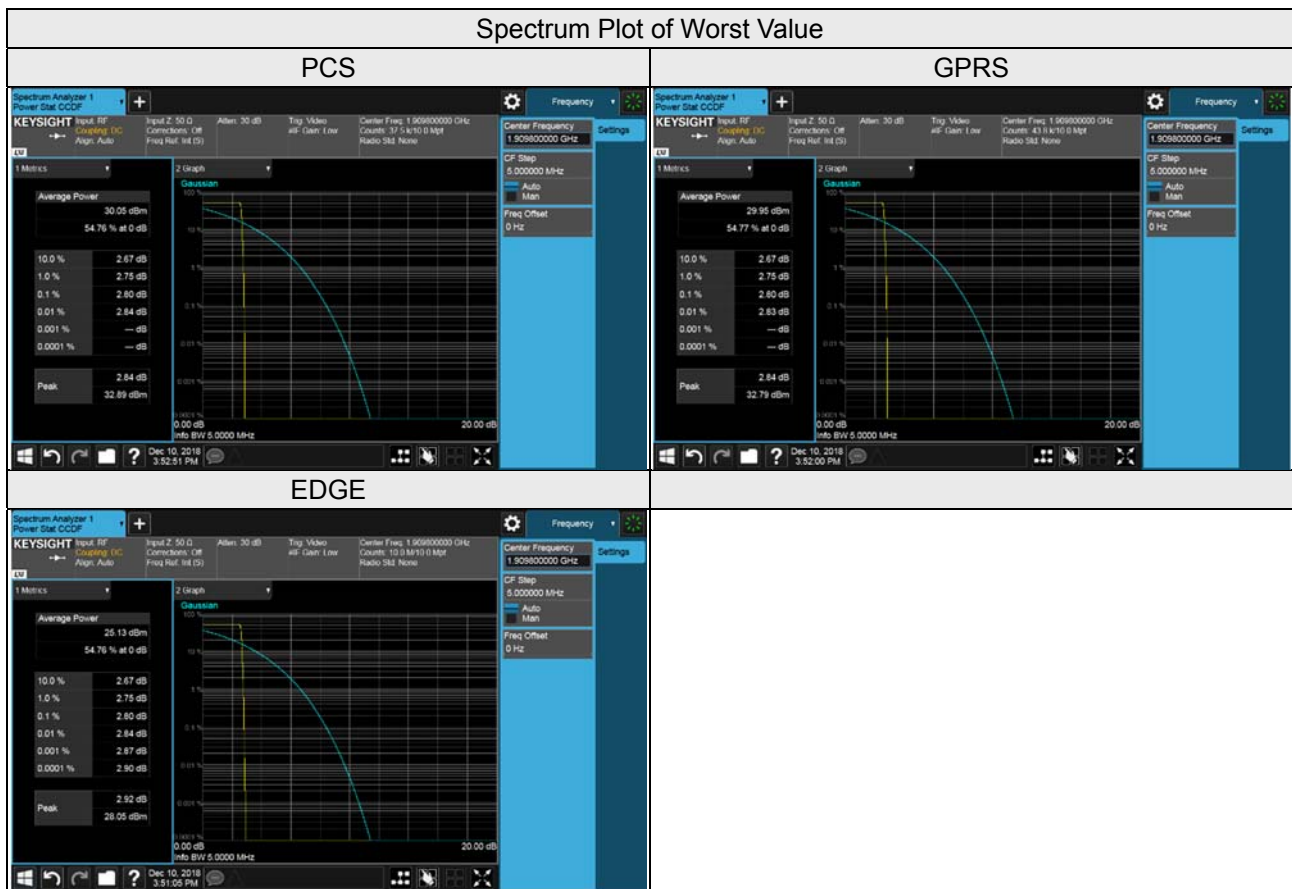

Channel	Frequency (MHz)	Peak To Average Ratio (dB)
		CDMA
25	1851.25	5.95
600	1880.00	5.43
1175	1908.75	5.46

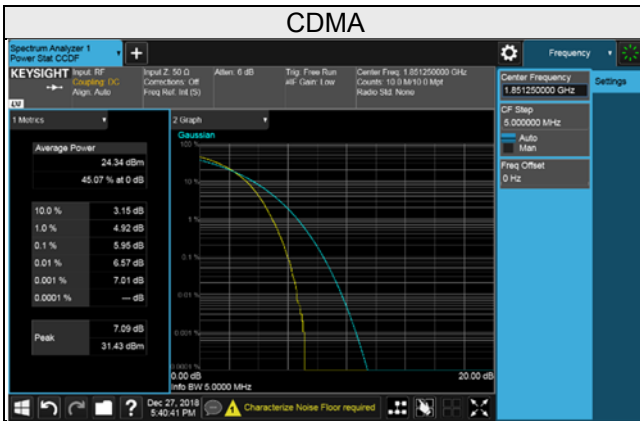

WCDMA Band 2				
Channel	Frequency (MHz)	Peak To Average Ratio (dB)		
		WCDMA	HSDPA	HSUPA
9262	1852.4	3.04	3.04	3.05
9400	1880.0	3.08	3.08	3.05
9538	1907.6	3.09	3.08	3.08

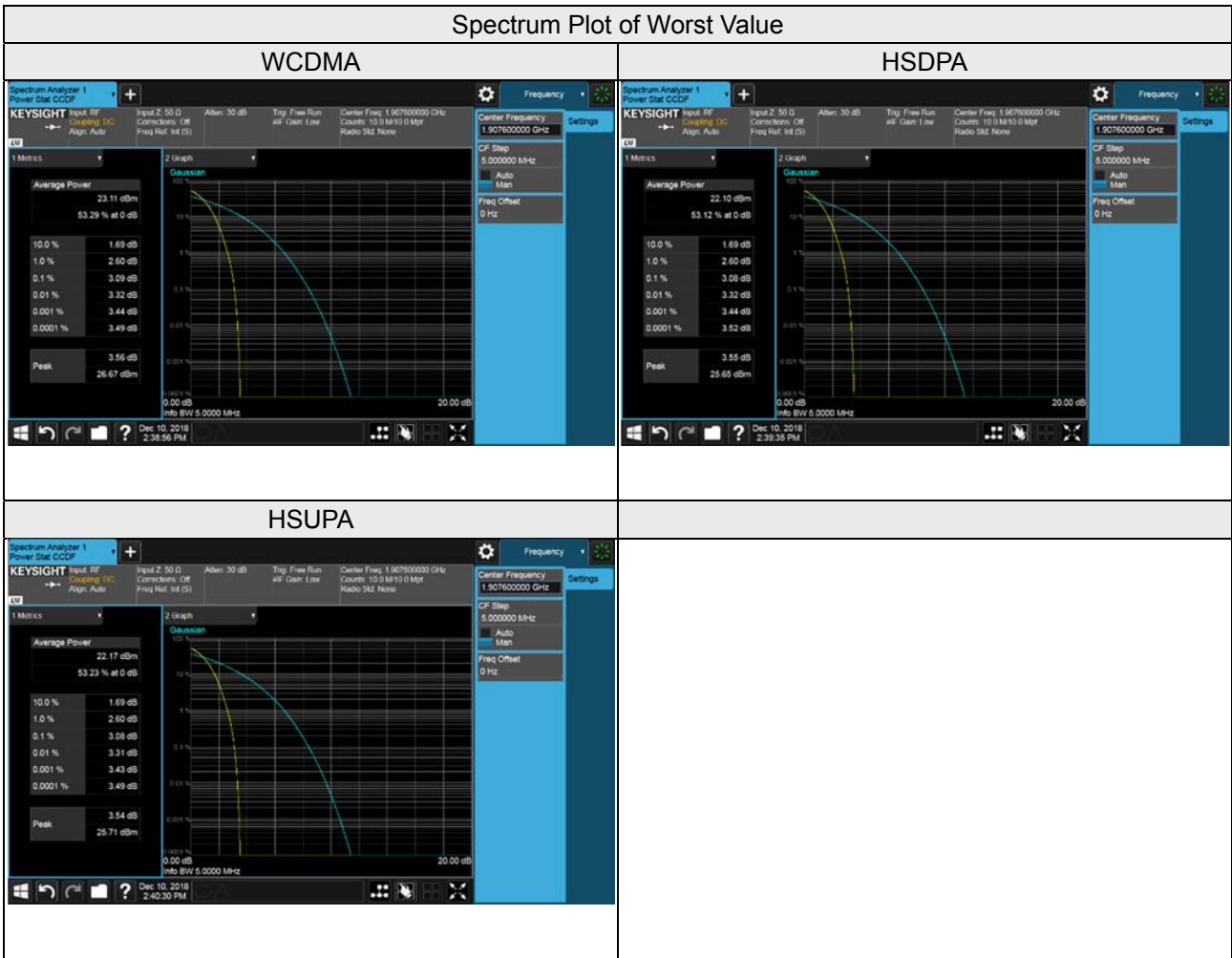

LTE Band 2, Channel Bandwidth 1.4MHz			
Channel	Frequency (MHz)	Peak To Average Ratio (dB)	
		QPSK	16QAM
18607	1850.7	4.18	5.02
18900	1880.0	4.18	4.91
19193	1909.3	4.46	5.05

LTE Band 2, Channel Bandwidth 3MHz			
Channel	Frequency (MHz)	Peak To Average Ratio (dB)	
		QPSK	16QAM
18615	1851.5	4.18	4.99
18900	1880.0	4.21	5.22
19185	1908.5	4.18	4.91

LTE Band 2, Channel Bandwidth 5MHz			
Channel	Frequency (MHz)	Peak To Average Ratio (dB)	
		QPSK	16QAM
18625	1852.5	4.17	5.00
18900	1880.0	4.18	5.02
19175	1907.5	4.03	4.83

LTE Band 2, Channel Bandwidth 10MHz			
Channel	Frequency (MHz)	Peak To Average Ratio (dB)	
		QPSK	16QAM
18650	1855.0	4.15	4.93
18900	1880.0	4.13	5.12
19150	1905.0	4.12	4.96

LTE Band 2, Channel Bandwidth 15MHz			
Channel	Frequency (MHz)	Peak To Average Ratio (dB)	
		QPSK	16QAM
18675	1857.5	4.11	4.90
18900	1880.0	4.17	5.00
19125	1902.5	4.19	5.08

LTE Band 2, Channel Bandwidth 20MHz			
Channel	Frequency (MHz)	Peak To Average Ratio (dB)	
		QPSK	16QAM
18700	1860.0	4.11	4.96
18900	1880.0	4.15	5.00
19100	1900.0	4.13	4.90

Spectrum Plot of Worst Value

1.4MHz / 16QAM

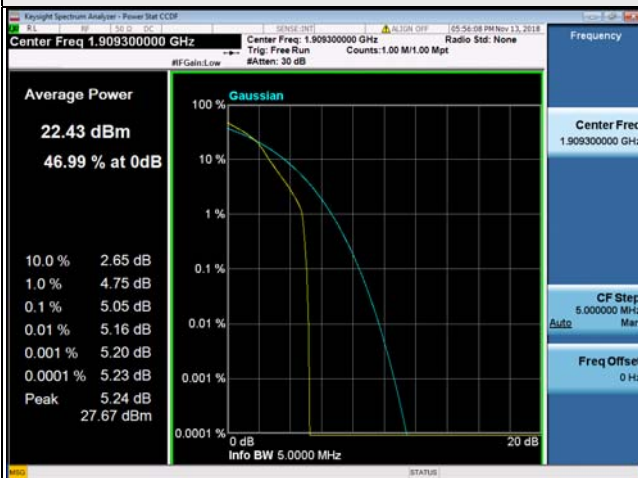

3MHz / 16QAM

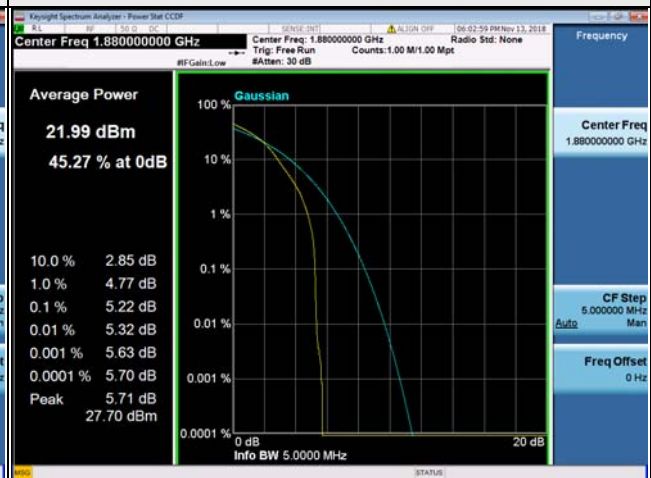

5MHz / 16QAM

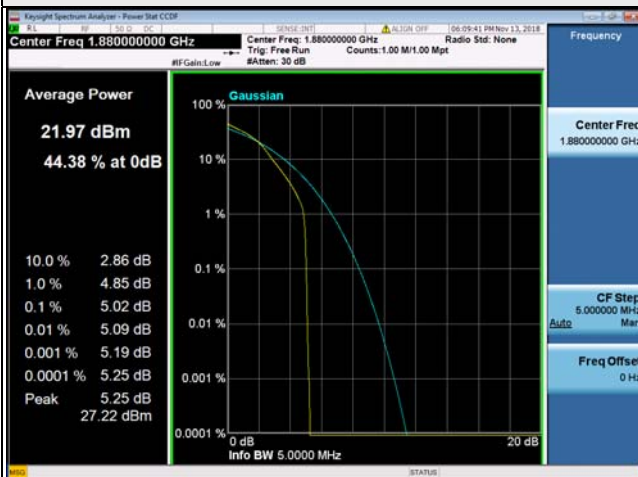

10MHz / 16QAM



15MHz / 16QAM

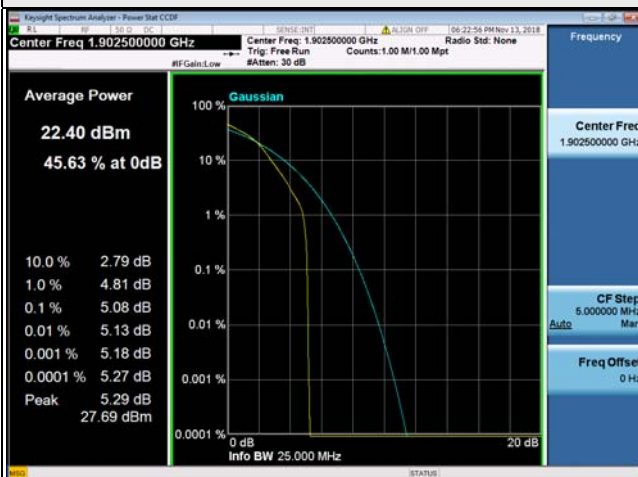

20MHz / 16QAM

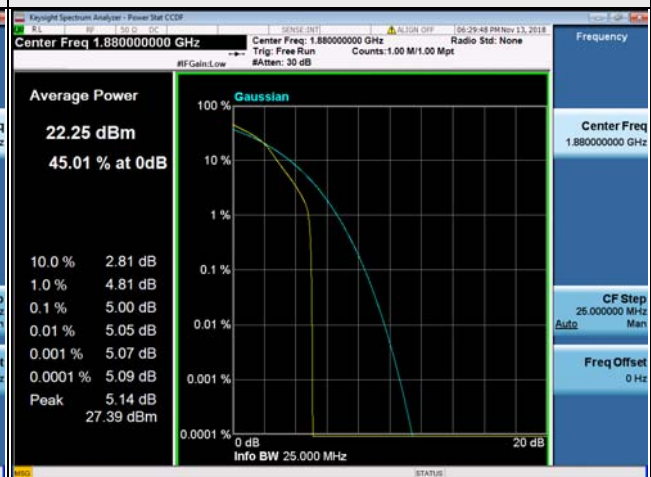

LTE Band 25, Channel Bandwidth 1.4MHz			
Channel	Frequency (MHz)	Peak To Average Ratio (dB)	
		QPSK	16QAM
26047	1850.7	4.11	4.92
26365	1882.5	4.13	4.86
26683	1914.3	4.22	4.89

LTE Band 25, Channel Bandwidth 3MHz			
Channel	Frequency (MHz)	Peak To Average Ratio (dB)	
		QPSK	16QAM
26055	1851.5	4.13	4.96
26365	1882.5	4.12	4.84
26675	1913.5	4.41	5.02

LTE Band 25, Channel Bandwidth 5MHz			
Channel	Frequency (MHz)	Peak To Average Ratio (dB)	
		QPSK	16QAM
26065	1852.5	4.09	4.87
26365	1882.5	4.06	4.87
26665	1912.5	4.44	4.96

LTE Band 25, Channel Bandwidth 10MHz			
Channel	Frequency (MHz)	Peak To Average Ratio (dB)	
		QPSK	16QAM
26090	1855.0	4.08	4.89
26365	1882.5	4.05	4.86
26640	1910.0	4.01	4.71

LTE Band 25, Channel Bandwidth 15MHz			
Channel	Frequency (MHz)	Peak To Average Ratio (dB)	
		QPSK	16QAM
26115	1857.5	4.06	4.86
26365	1882.5	4.15	4.92
26615	1907.5	4.07	4.87

LTE Band 25, Channel Bandwidth 20MHz			
Channel	Frequency (MHz)	Peak To Average Ratio (dB)	
		QPSK	16QAM
26140	1860.0	3.98	4.90
26365	1882.5	4.21	4.92
26590	1905.0	4.16	4.82

Spectrum Plot of Worst Value

1.4MHz / 16QAM

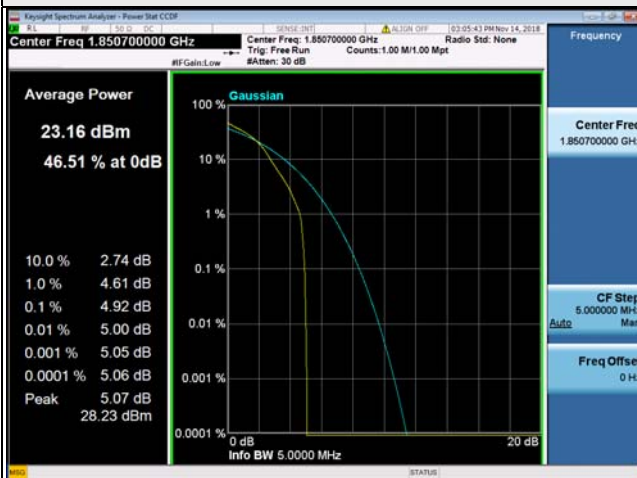

3MHz / 16QAM

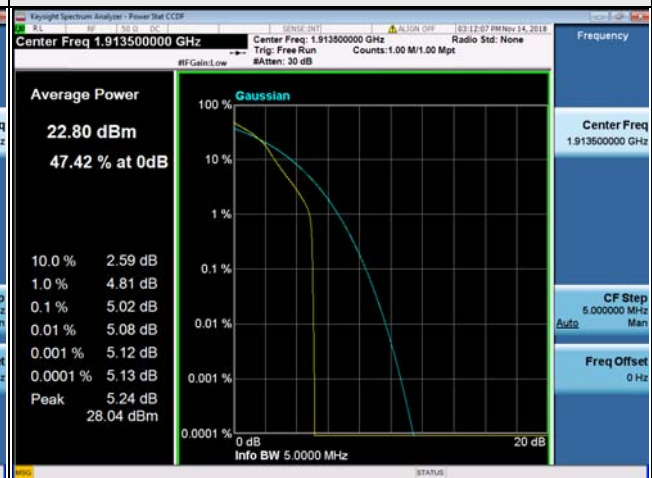

5MHz / 16QAM



10MHz / 16QAM

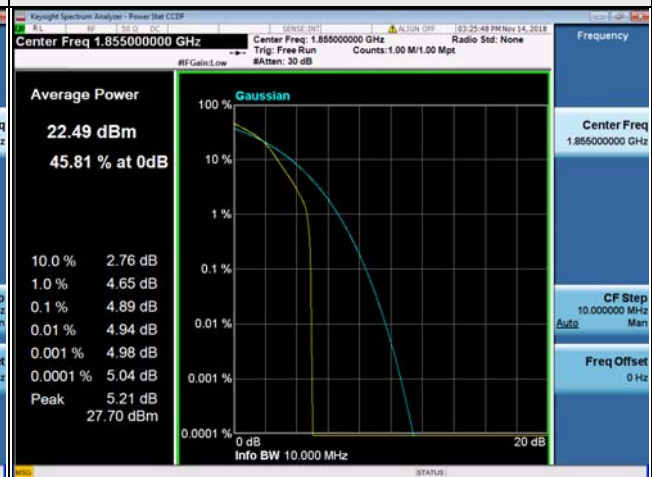

15MHz / 16QAM

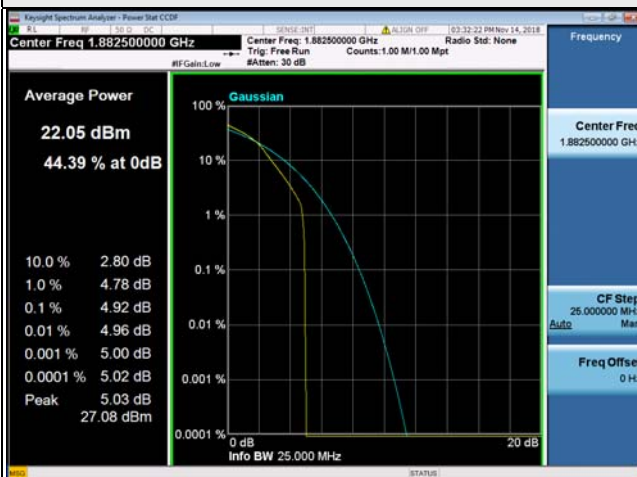

20MHz / 16QAM



4.7 Conducted Spurious Emissions

4.7.1 Limits of Conducted Spurious Emissions Measurement

The power of any emission outside of the authorized operating frequency ranges must be attenuated below the transmitting power (P) by a factor of at least $43 + 10 \log(P)$ dB. The emission limit equal to -13dBm .

4.7.2 Test Setup

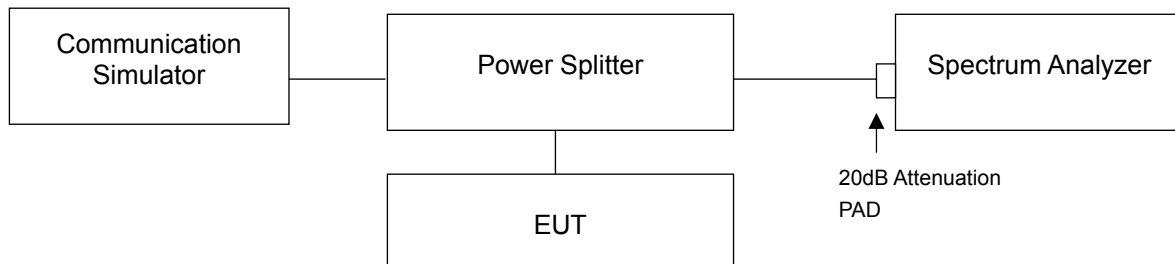

4.7.3 Test Procedure

- The EUT makes a phone call to the communication simulator. All measurements were done at low, middle and high operational frequency range.
- Measuring frequency range is from 9 kHz to 1GHz. 20dB attenuation pad is connected with spectrum. RBW=100kHz and VBW=300kHz is used for conducted emission measurement.
- Measuring frequency range is from 1GHz to 26.5GHz. 20dB attenuation pad is connected with spectrum. RBW=1MHz and VBW=3MHz is used for conducted emission measurement.

4.7.4 Test Results

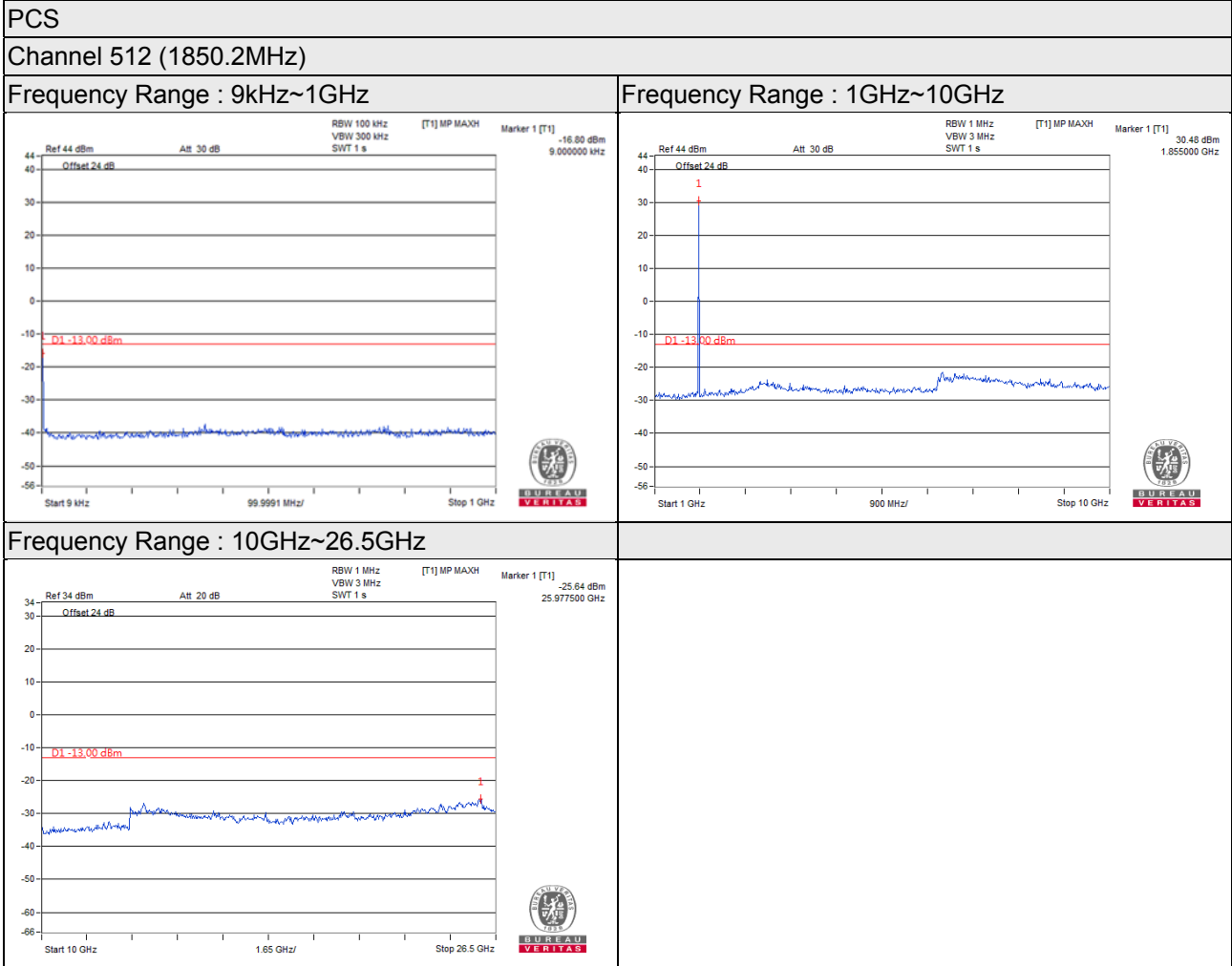

PCS

Channel 661 (1880.0MHz)

Frequency Range : 9kHz~1GHz

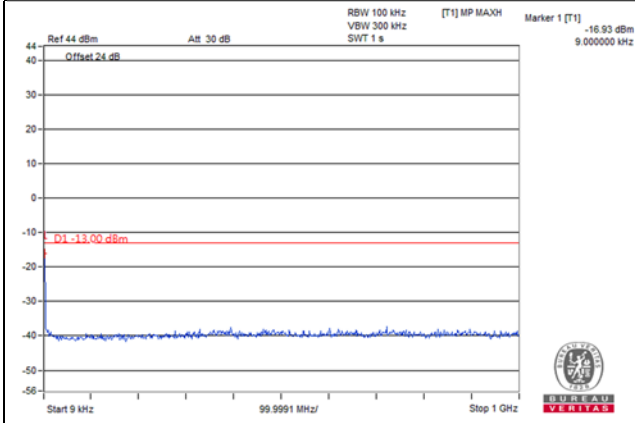

Frequency Range : 1GHz~10GHz

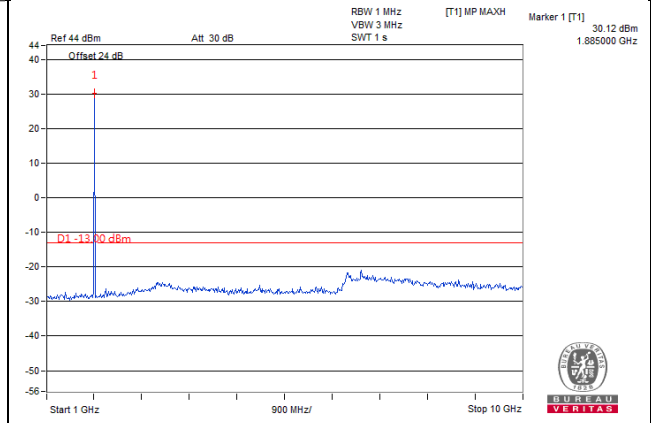

Frequency Range : 10GHz~26.5GHz

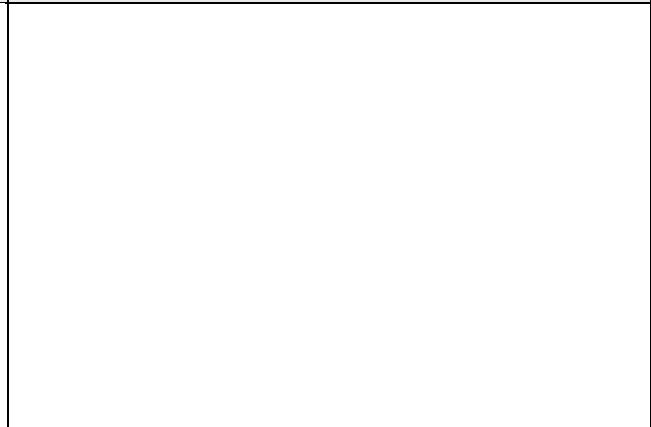
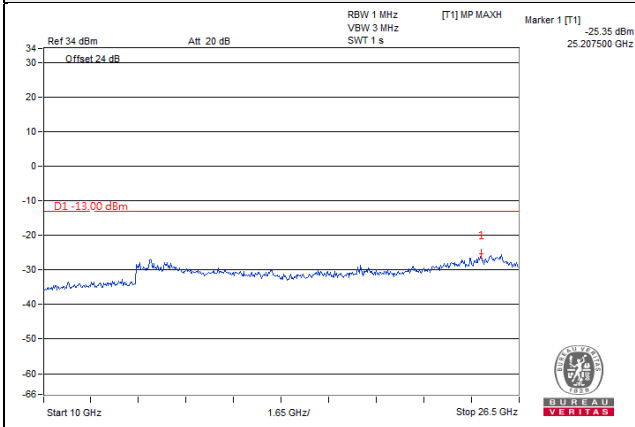

PCS

Channel 810 (1909.8MHz)

Frequency Range : 9kHz~1GHz

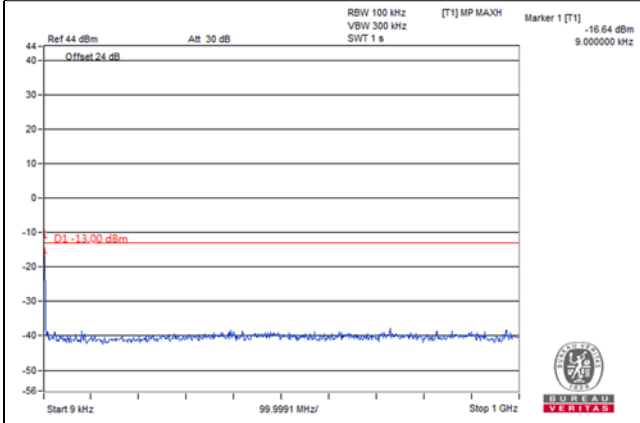

Frequency Range : 1GHz~10GHz

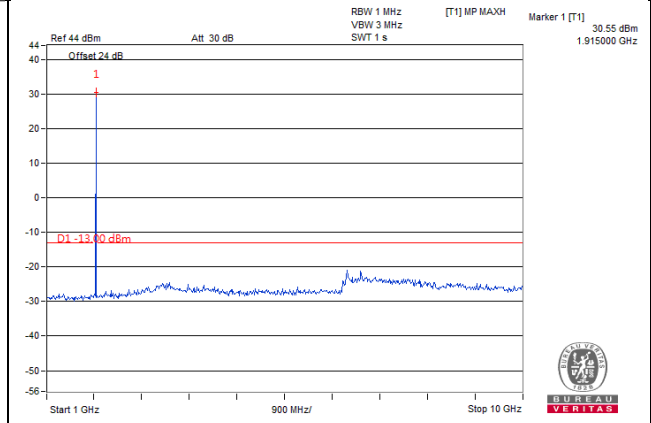

Frequency Range : 10GHz~26.5GHz

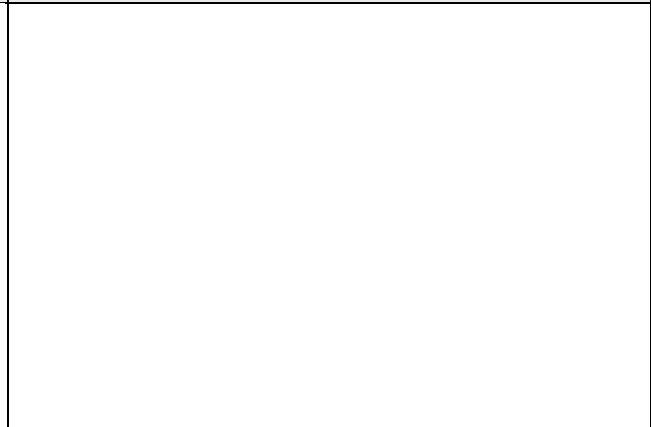
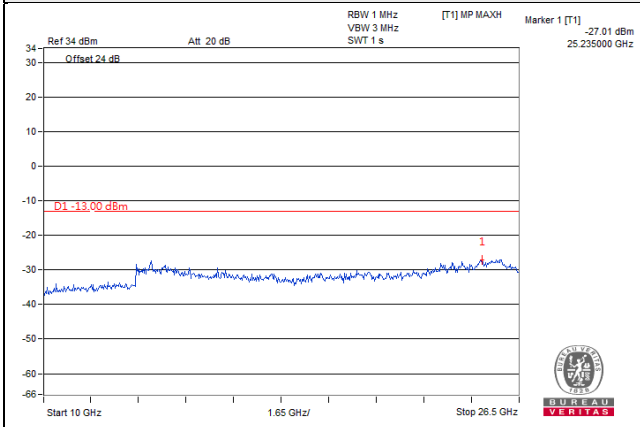

GPRS

Channel 512 (1850.2MHz)

Frequency Range : 9kHz~1GHz

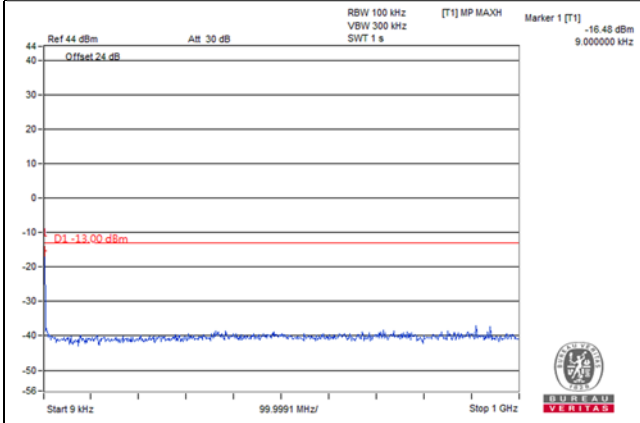

Frequency Range : 1GHz~10GHz

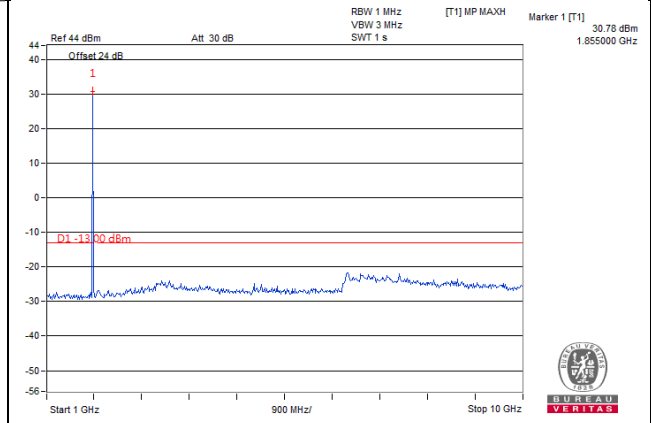

Frequency Range : 10GHz~26.5GHz

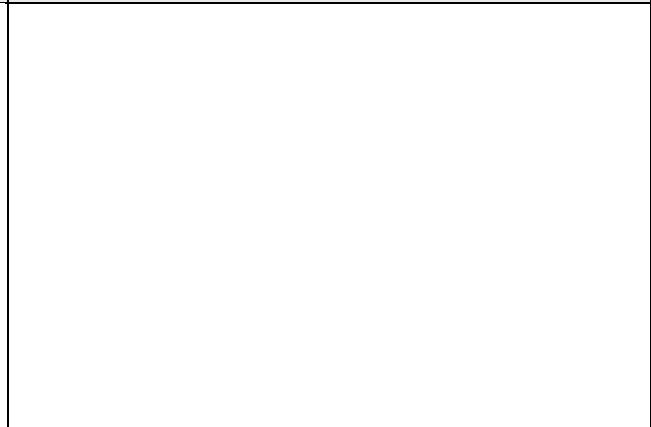
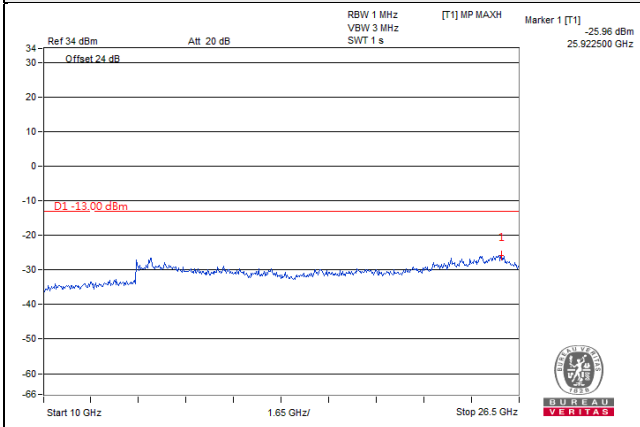

GPRS

Channel 661 (1880.0MHz)

Frequency Range : 9kHz~1GHz

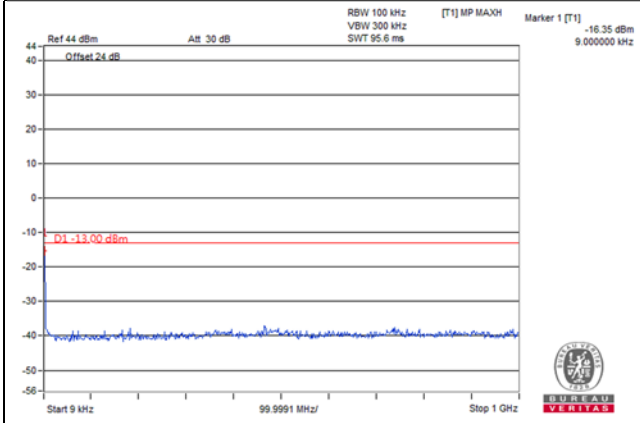

Frequency Range : 1GHz~10GHz

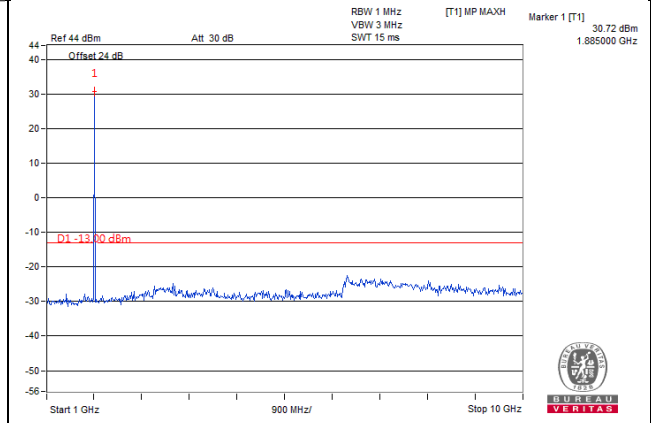

Frequency Range : 10GHz~26.5GHz

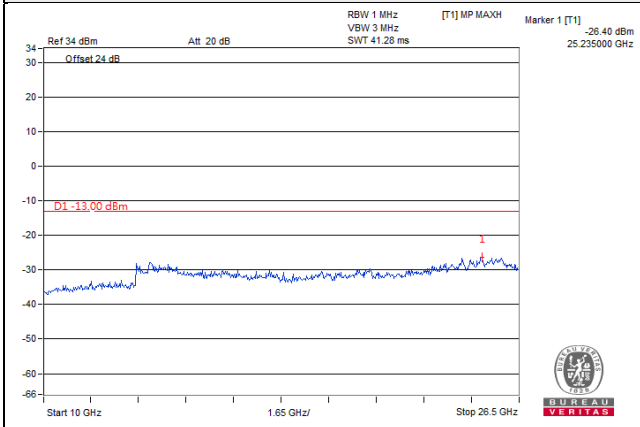

GPRS

Channel 810 (1909.8MHz)

Frequency Range : 9kHz~1GHz

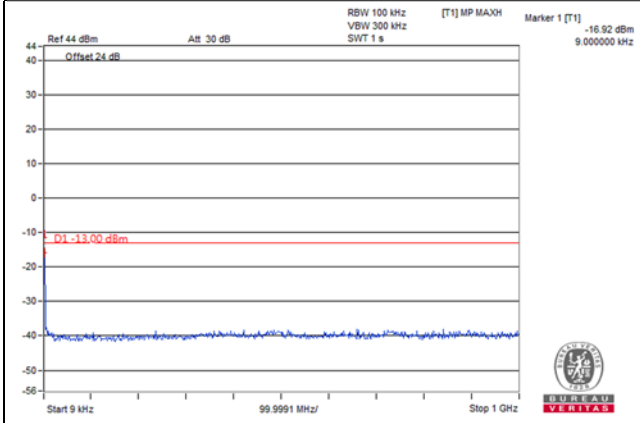

Frequency Range : 1GHz~10GHz

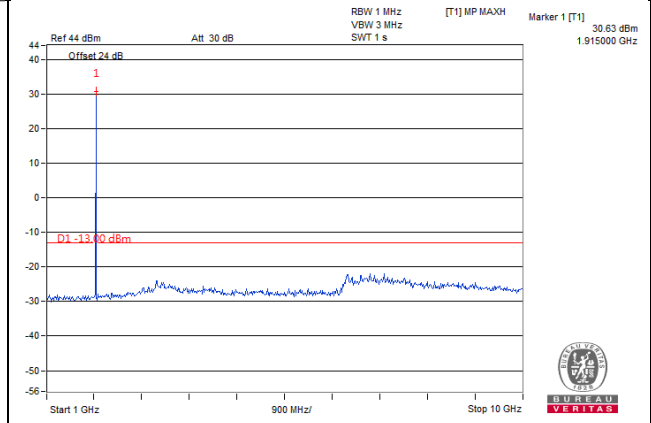

Frequency Range : 10GHz~26.5GHz

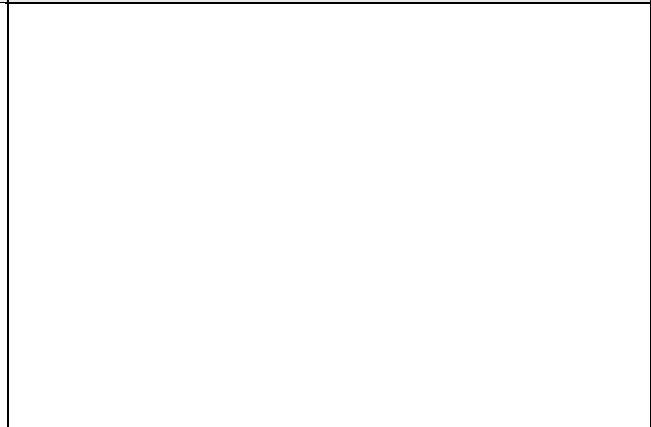
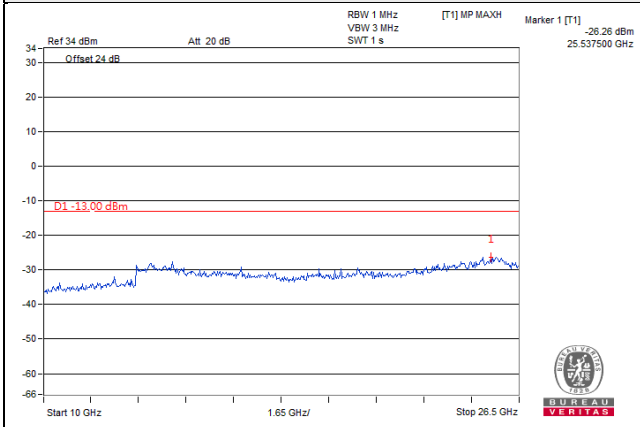

EDGE

Channel 512 (1850.2MHz)

Frequency Range : 9kHz~1GHz

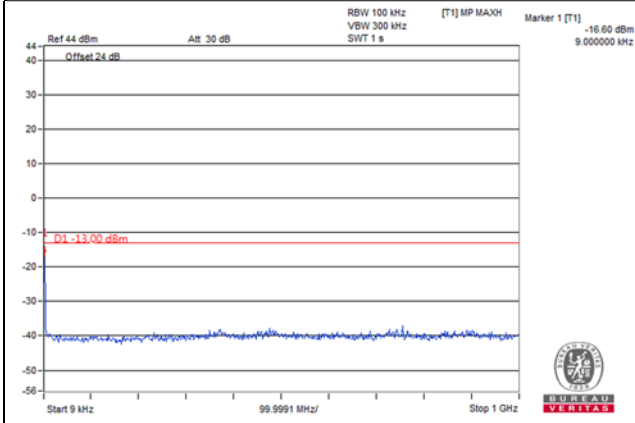

Frequency Range : 1GHz~10GHz

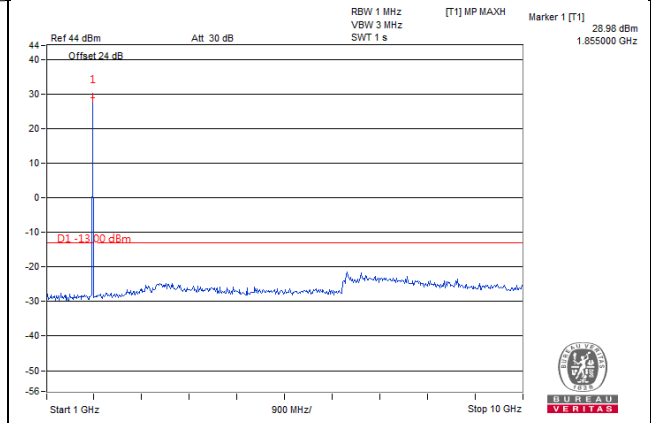

Frequency Range : 10GHz~26.5GHz

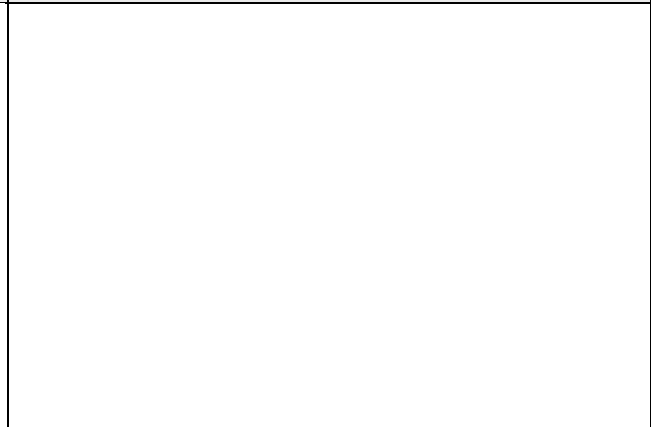
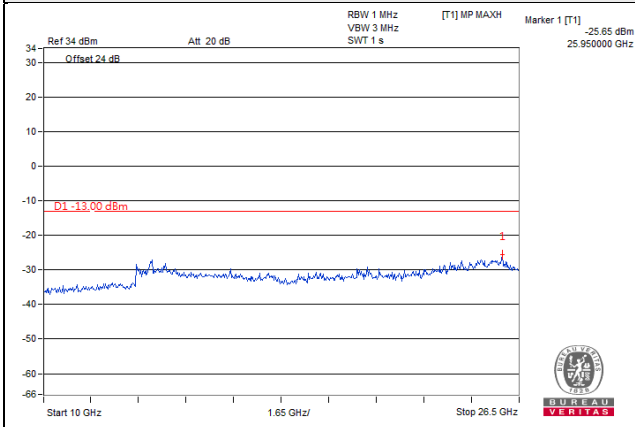

EDGE

Channel 661 (1880.0MHz)

Frequency Range : 9kHz~1GHz

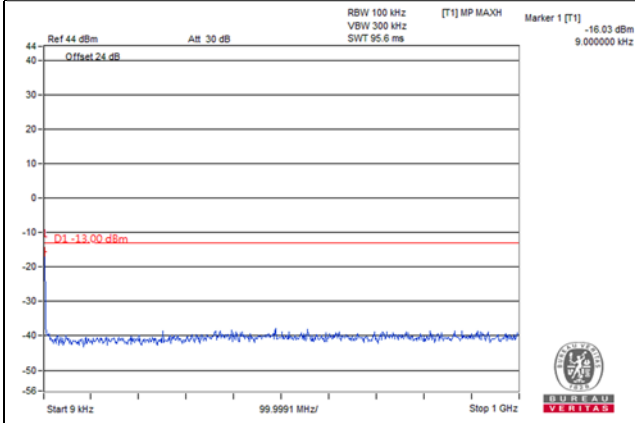

Frequency Range : 1GHz~10GHz

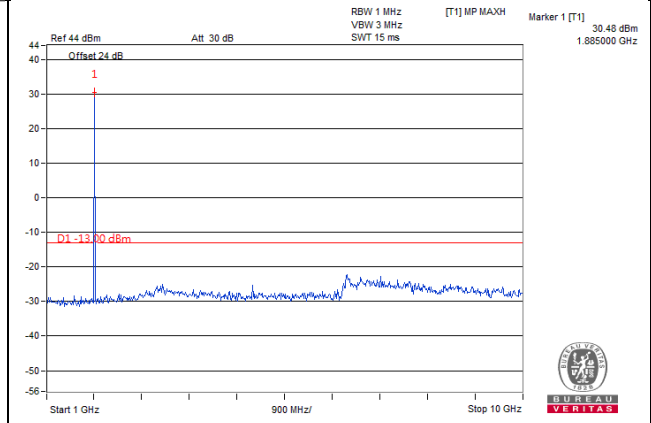

Frequency Range : 10GHz~26.5GHz

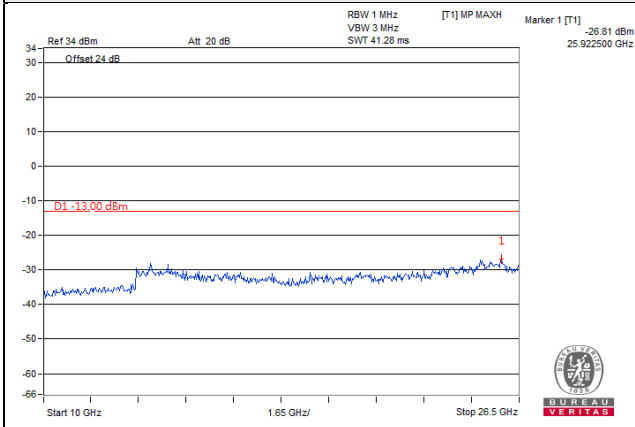

EDGE

Channel 810 (1909.8MHz)

Frequency Range : 9kHz~1GHz

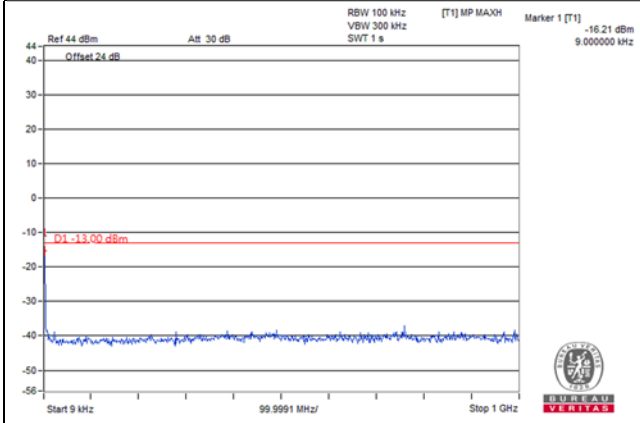

Frequency Range : 1GHz~10GHz

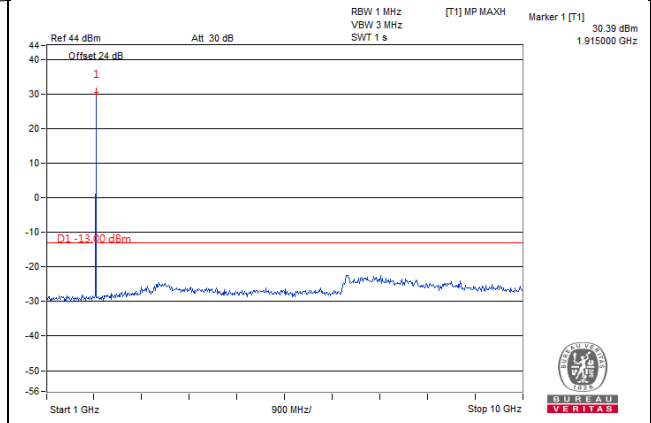

Frequency Range : 10GHz~26.5GHz

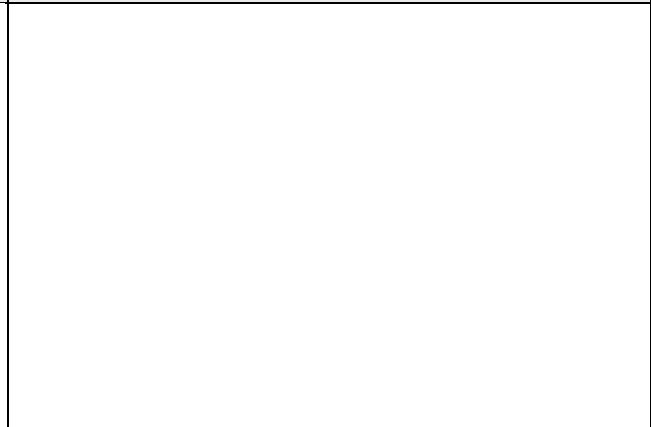
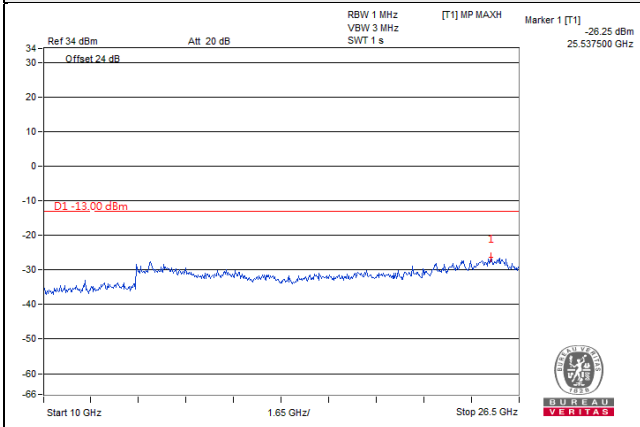

CDMA

Channel 25 (1851.25MHz)

Frequency Range : 9kHz~1GHz

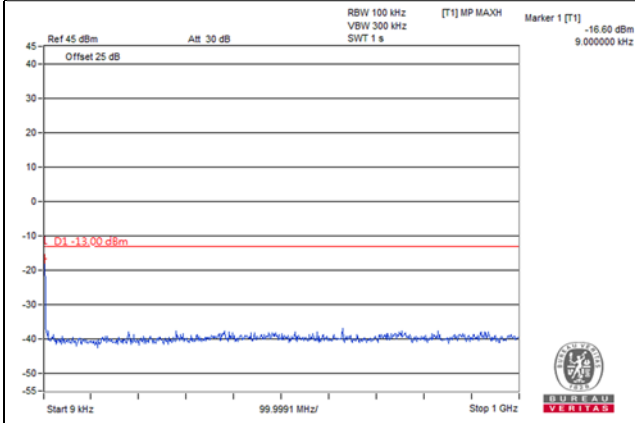

Frequency Range : 1GHz~10GHz

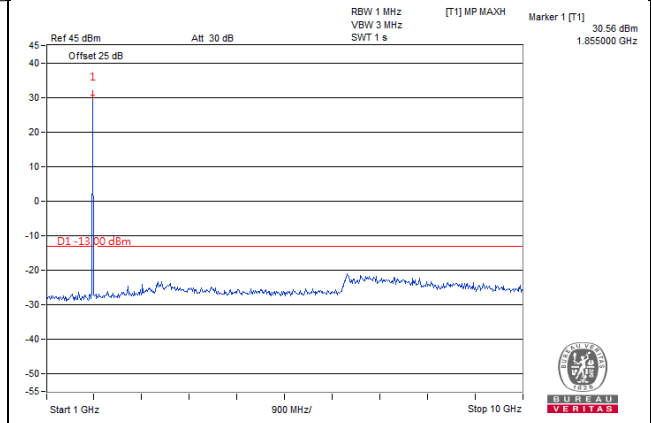

Frequency Range : 10GHz~26.5GHz

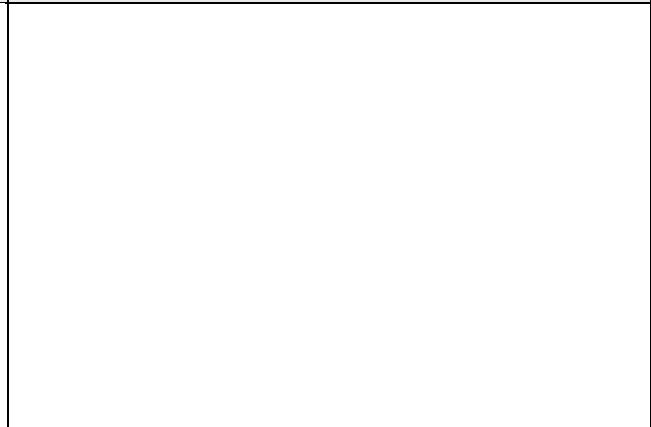
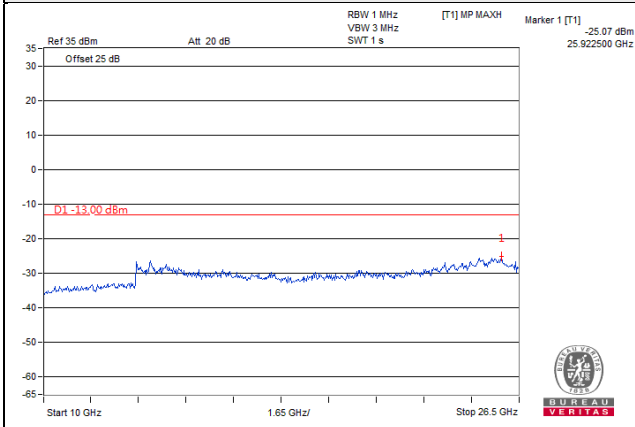

CDMA

Channel 600 (1880.00MHz)

Frequency Range : 9kHz~1GHz

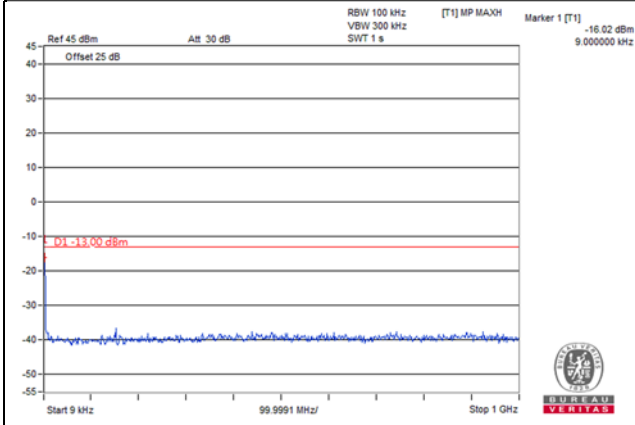

Frequency Range : 1GHz~10GHz

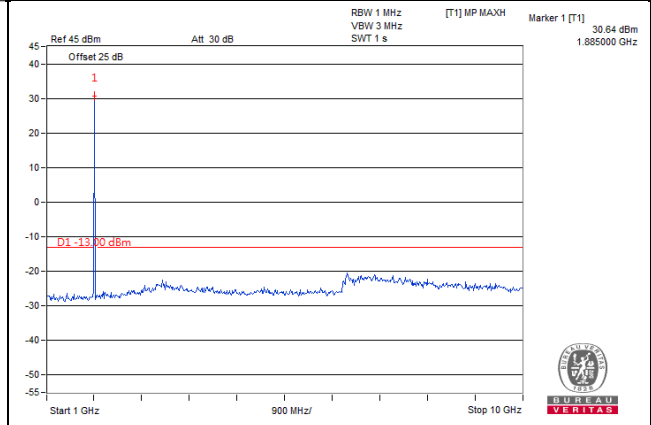

Frequency Range : 10GHz~26.5GHz

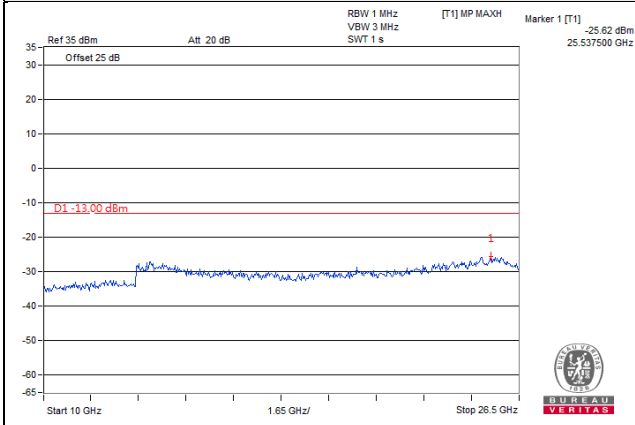

CDMA

Channel 1175 (1908.75MHz)

Frequency Range : 9kHz~1GHz

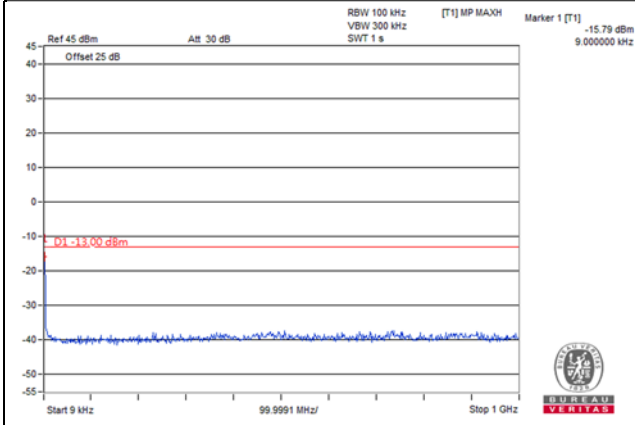

Frequency Range : 1GHz~10GHz

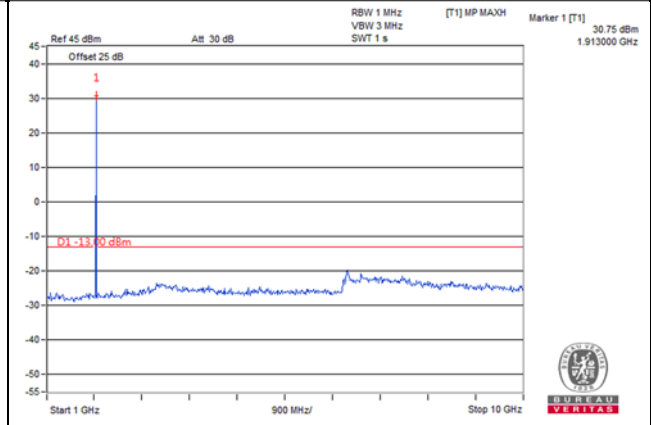

Frequency Range : 10GHz~26.5GHz

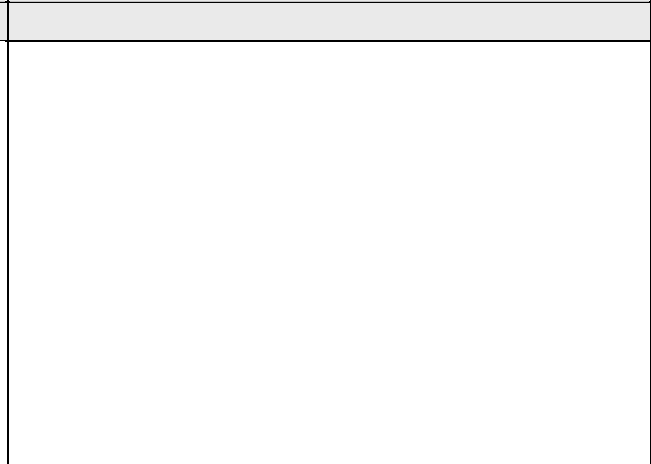
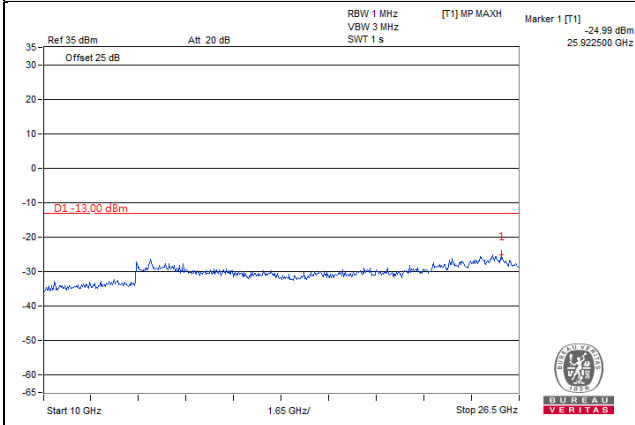

WCDMA

Channel 9262 (1852.4MHz)

Frequency Range : 9kHz~1GHz

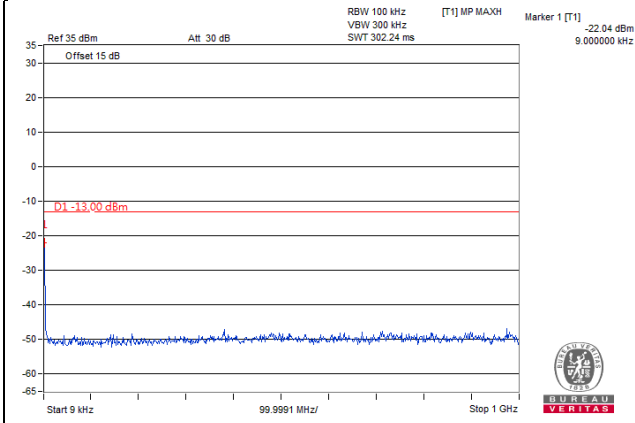

Frequency Range : 1GHz~10GHz

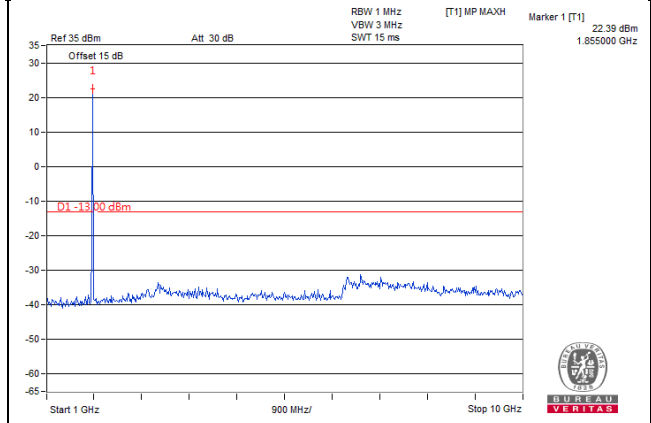

Frequency Range : 10GHz~26.5GHz

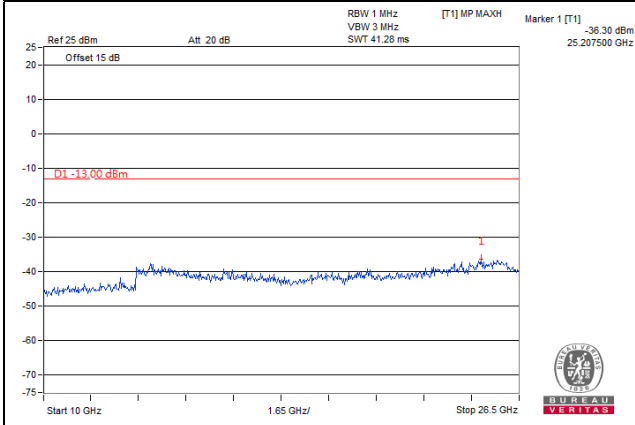

WCDMA

Channel 9400 (1880.0MHz)

Frequency Range : 9kHz~1GHz

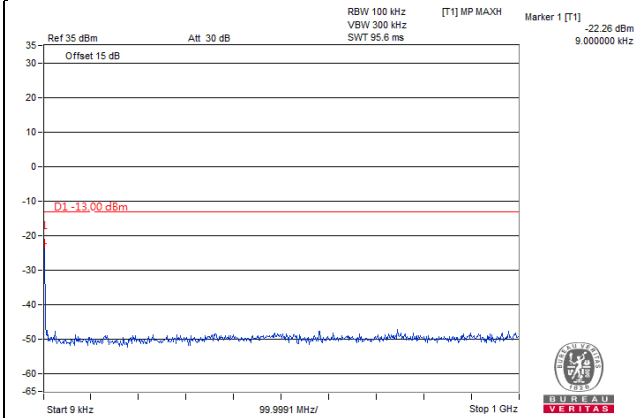

Frequency Range : 1GHz~10GHz

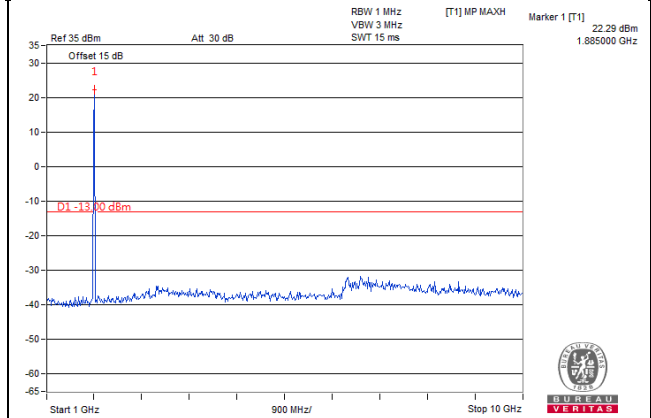

Frequency Range : 10GHz~26.5GHz

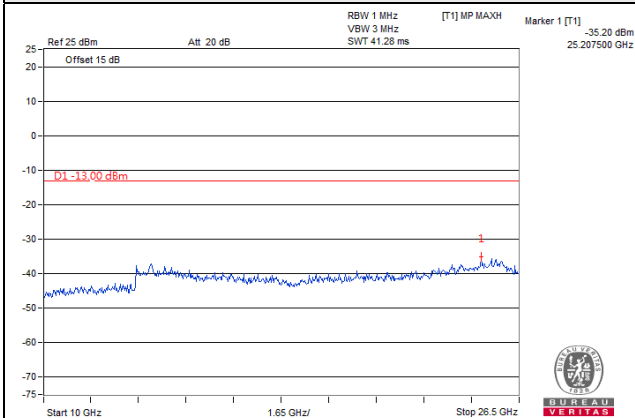

WCDMA

Channel 9538 (1907.6MHz)

Frequency Range : 9kHz~1GHz

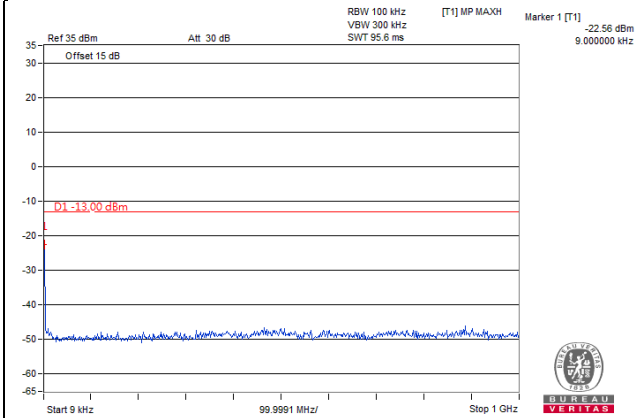

Frequency Range : 1GHz~10GHz

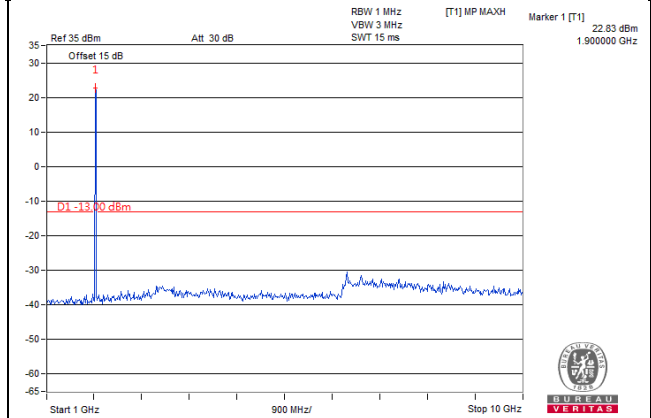

Frequency Range : 10GHz~26.5GHz

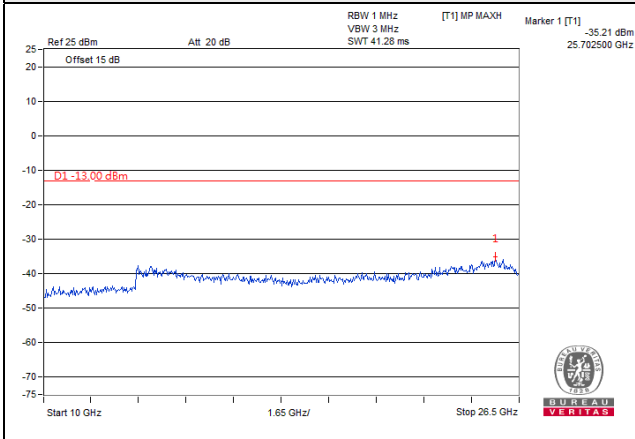

HSDPA

Channel 9262 (1852.4MHz)

Frequency Range : 9kHz~1GHz

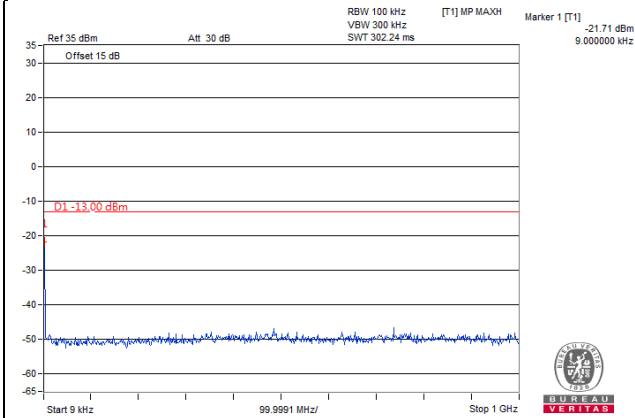

Frequency Range : 1GHz~10GHz

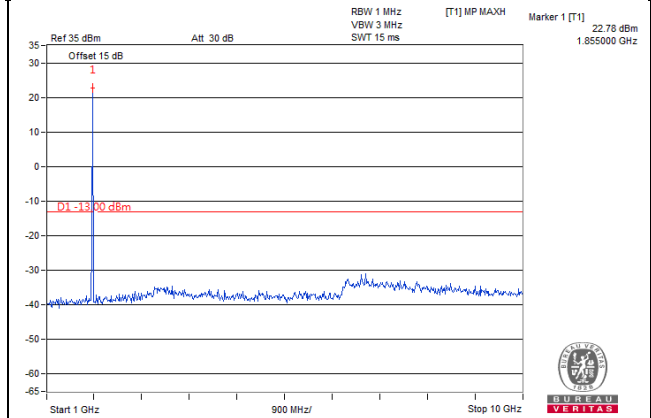

Frequency Range : 10GHz~26.5GHz

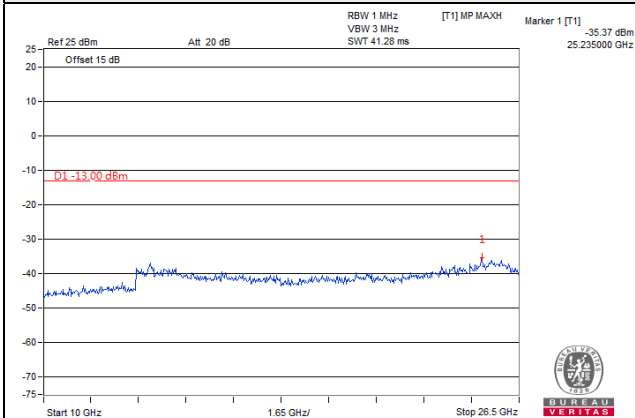

HSDPA

Channel 9400 (1880.0MHz)

Frequency Range : 9kHz~1GHz

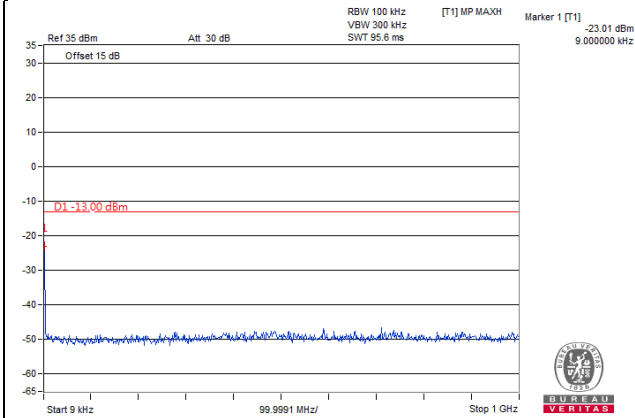

Frequency Range : 1GHz~10GHz

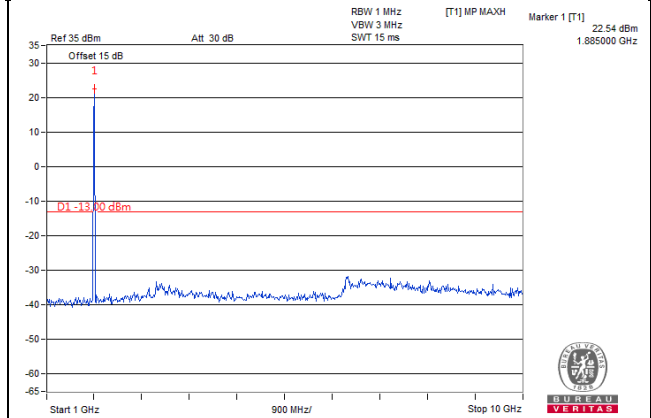

Frequency Range : 10GHz~26.5GHz

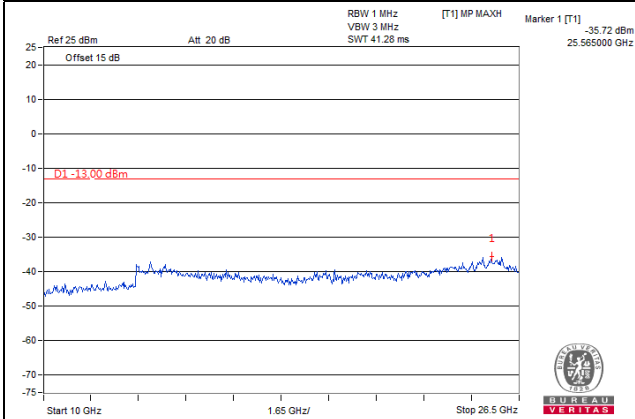

HSDPA

Channel 9538 (1907.6MHz)

Frequency Range : 9kHz~1GHz

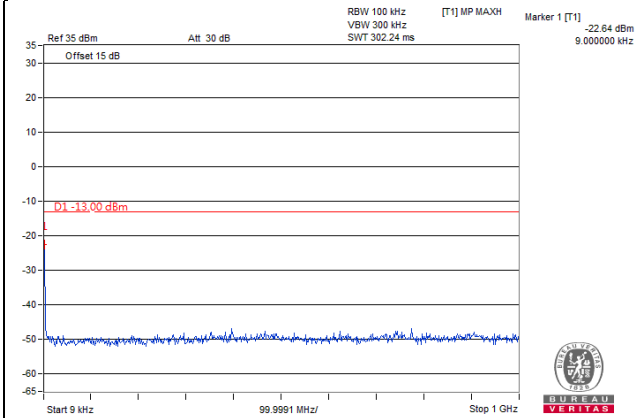

Frequency Range : 1GHz~10GHz

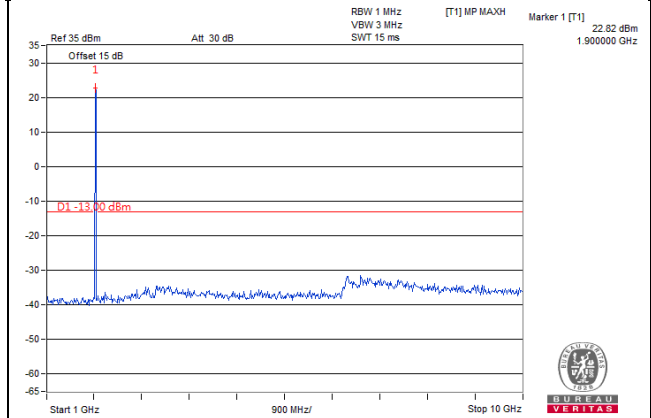

Frequency Range : 10GHz~26.5GHz

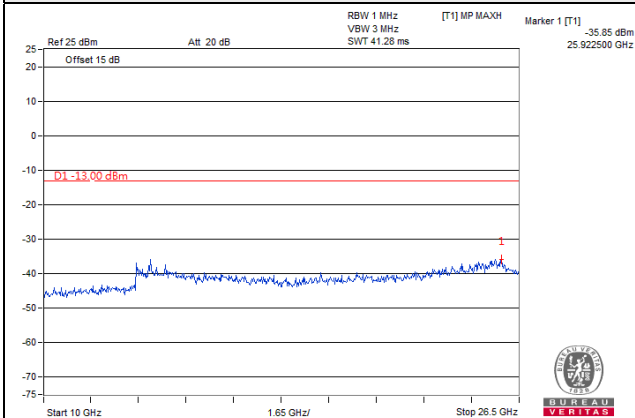

HSUPA

Channel 9262 (1852.4MHz)

Frequency Range : 9kHz~1GHz

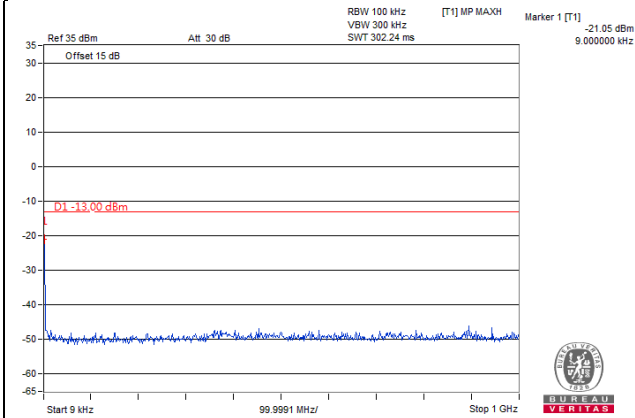

Frequency Range : 1GHz~10GHz

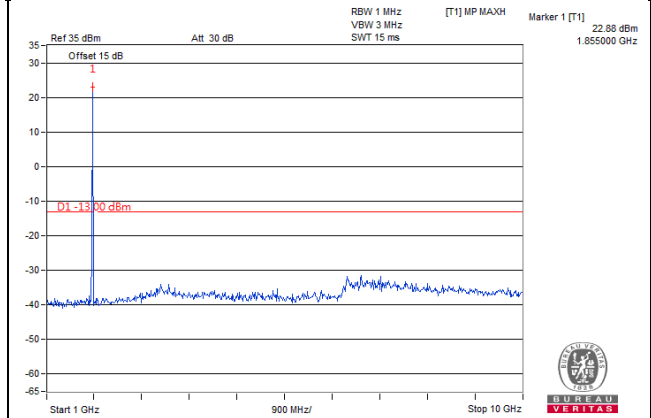

Frequency Range : 10GHz~26.5GHz

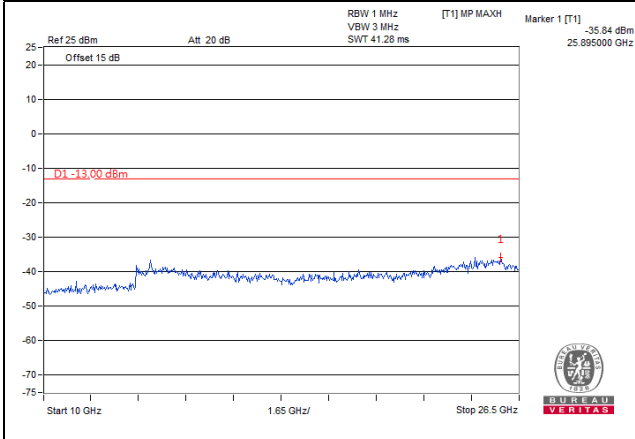

HSUPA

Channel 9400 (1880.0MHz)

Frequency Range : 9kHz~1GHz

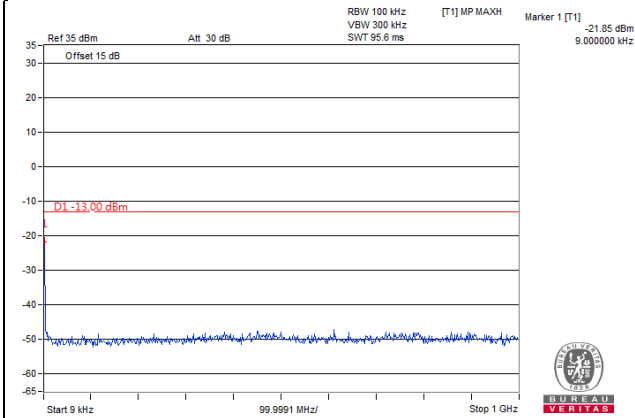

Frequency Range : 1GHz~10GHz

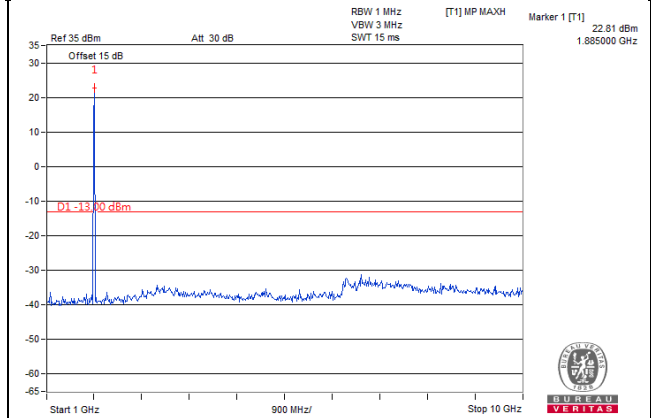

Frequency Range : 10GHz~26.5GHz

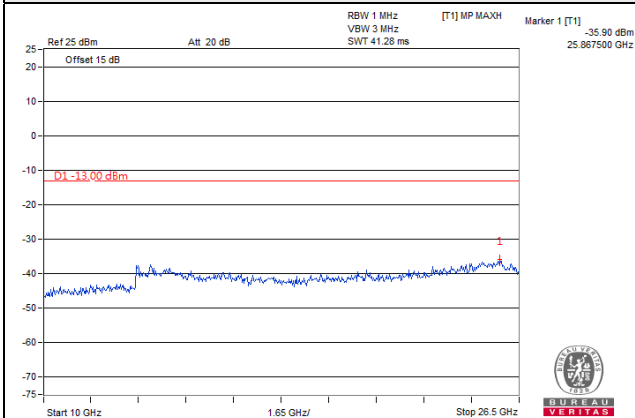

HSUPA

Channel 9538 (1907.6MHz)

Frequency Range : 9kHz~1GHz

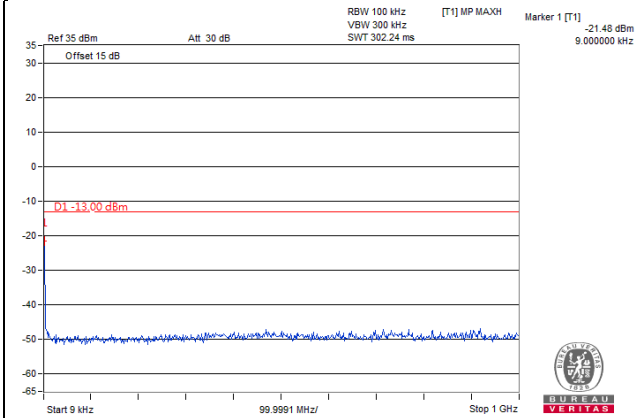

Frequency Range : 1GHz~10GHz

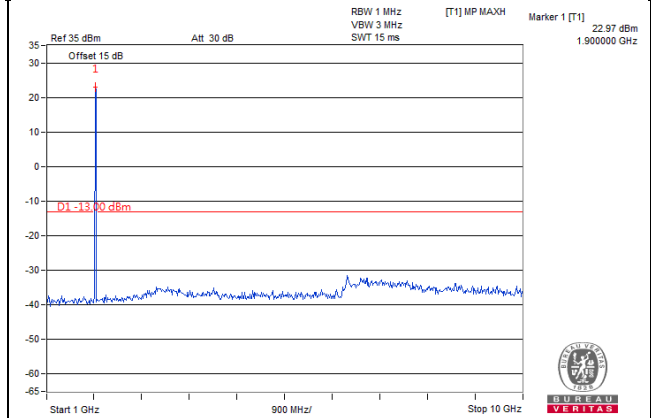

Frequency Range : 10GHz~26.5GHz

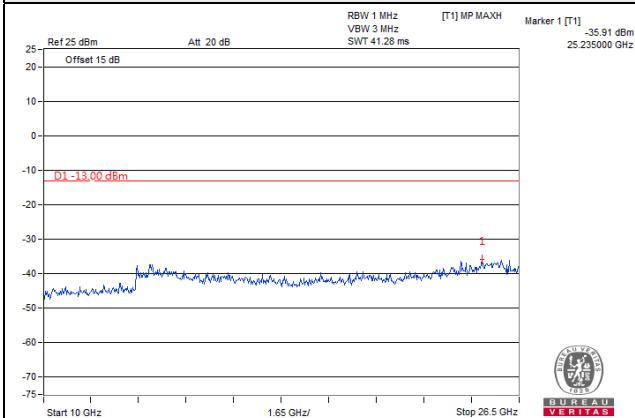

LTE Band 2, Channel Bandwidth 1.4MHz

Channel 18607 (1850.70MHz)

Frequency Range : 9kHz~1GHz

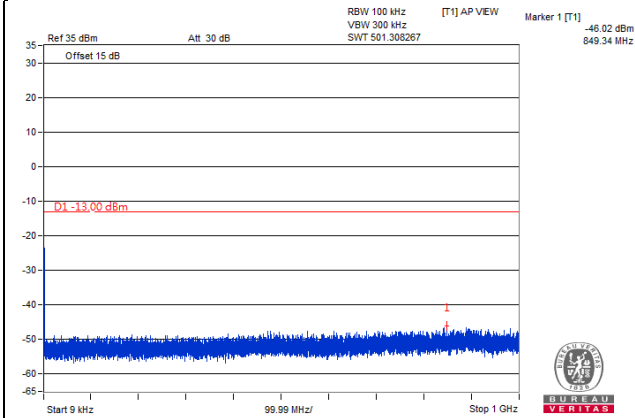

Frequency Range : 1GHz~10GHz

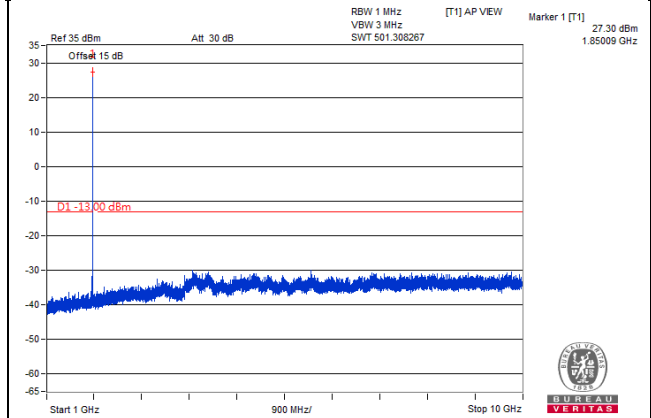

Frequency Range : 10GHz~27GHz

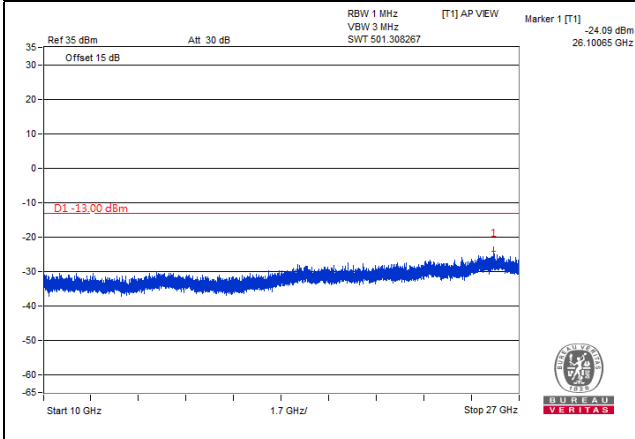

LTE Band 2, Channel Bandwidth 1.4MHz

Channel 18900 (1880.00MHz)

Frequency Range : 9kHz~1GHz

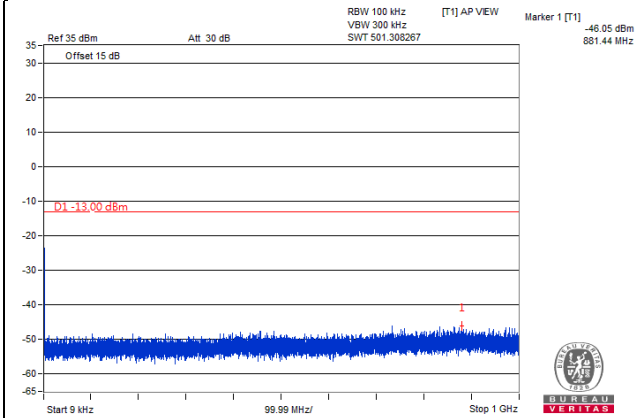

Frequency Range : 1GHz~10GHz

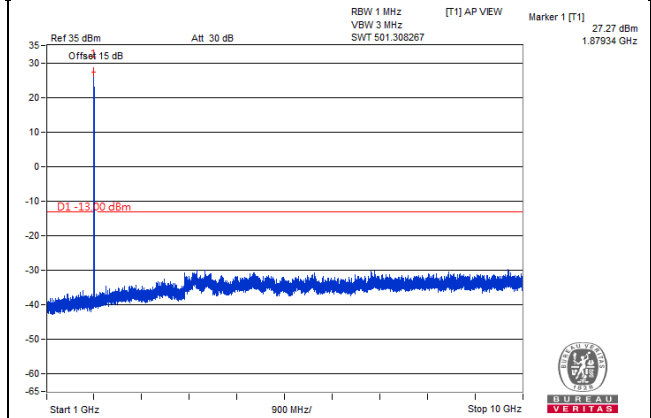

Frequency Range : 10GHz~27GHz

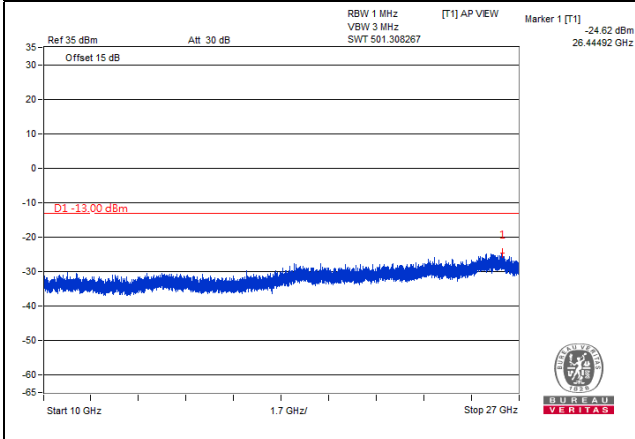

LTE Band 2, Channel Bandwidth 1.4MHz

Channel 19193 (1909.30MHz)

Frequency Range : 9kHz~1GHz

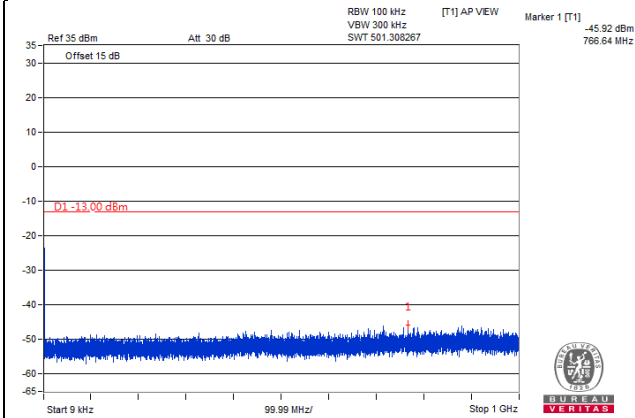

Frequency Range : 1GHz~10GHz

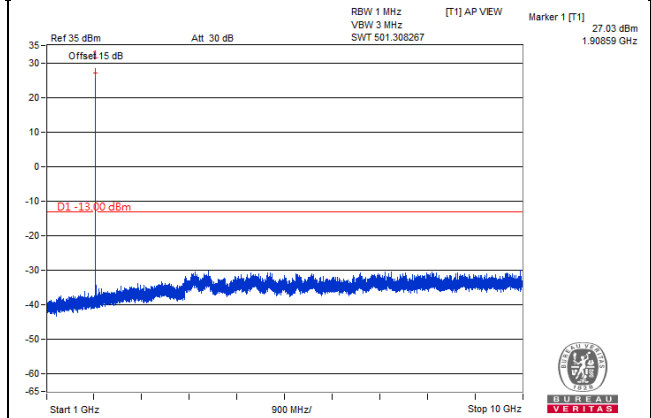

Frequency Range : 10GHz~27GHz

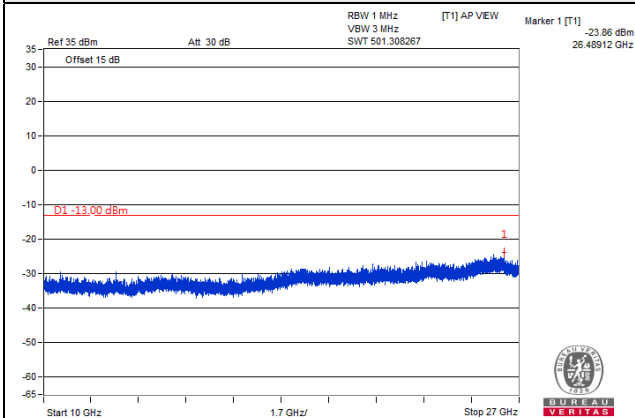

LTE Band 2, Channel Bandwidth 3MHz

Channel 18615 (1851.50MHz)

Frequency Range : 9kHz~1GHz

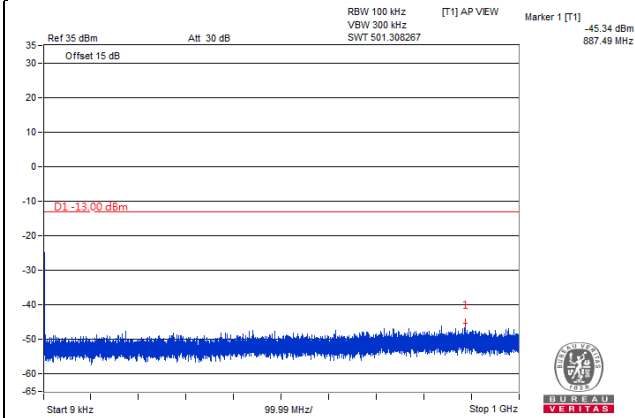

Frequency Range : 1GHz~10GHz

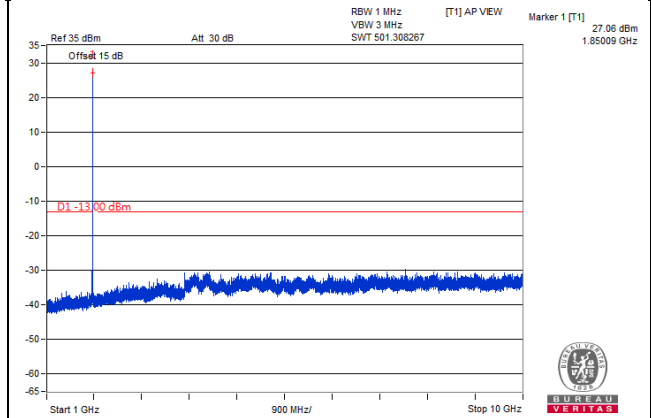

Frequency Range : 10GHz~27GHz

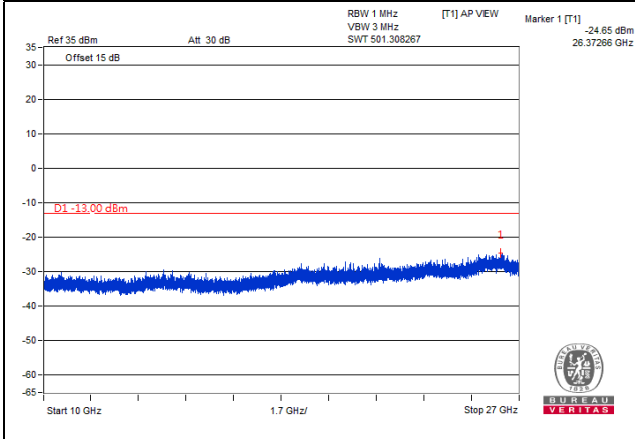

LTE Band 2, Channel Bandwidth 3MHz

Channel 18900 (1880.00MHz)

Frequency Range : 9kHz~1GHz

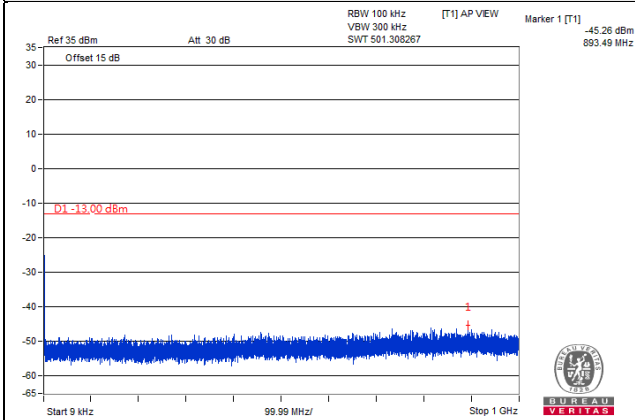

Frequency Range : 1GHz~10GHz

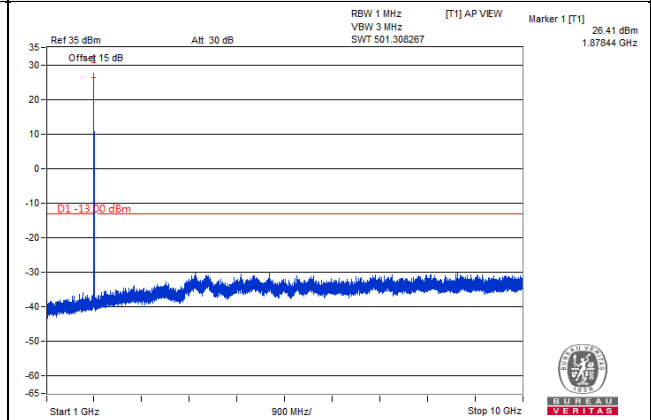

Frequency Range : 10GHz~27GHz

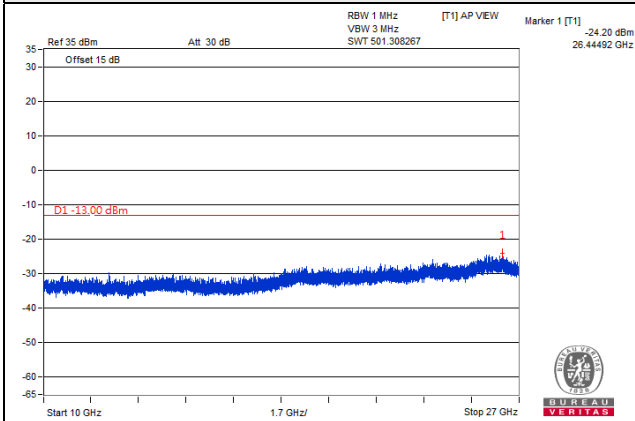

LTE Band 2, Channel Bandwidth 3MHz

Channel 19185 (1908.50MHz)

Frequency Range : 9kHz~1GHz

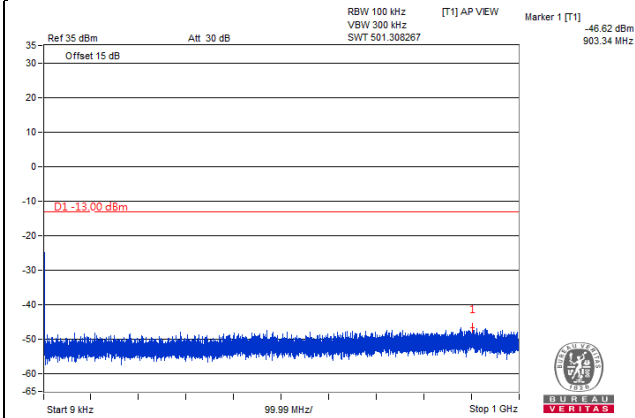

Frequency Range : 1GHz~10GHz

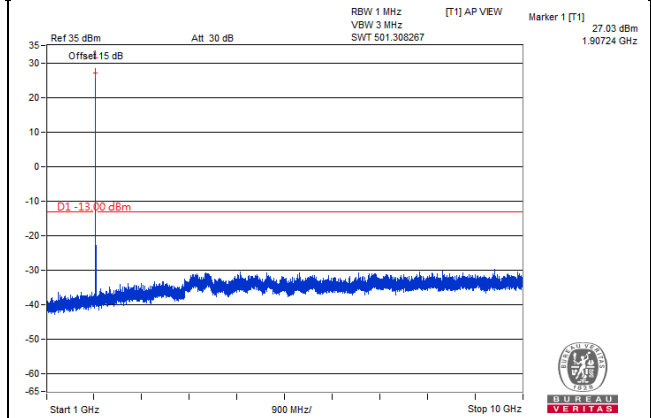

Frequency Range : 10GHz~27GHz

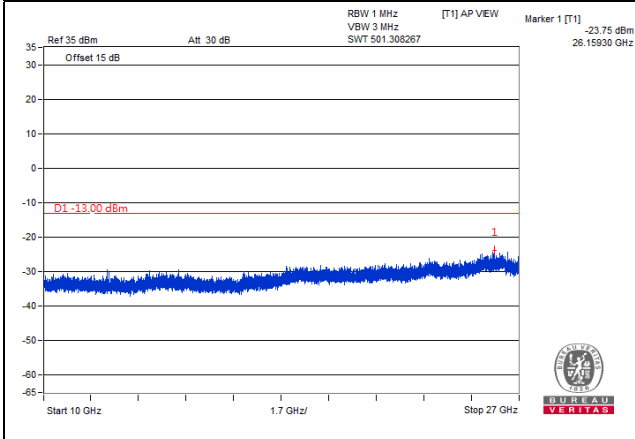

LTE Band 2, Channel Bandwidth 5MHz

Channel 18625 (1852.50MHz)

Frequency Range : 9kHz~1GHz

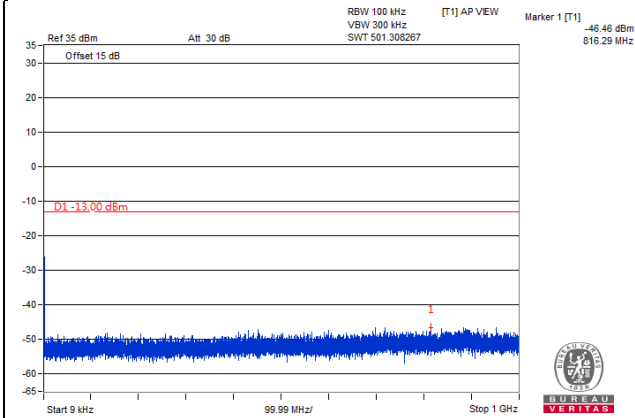

Frequency Range : 1GHz~10GHz

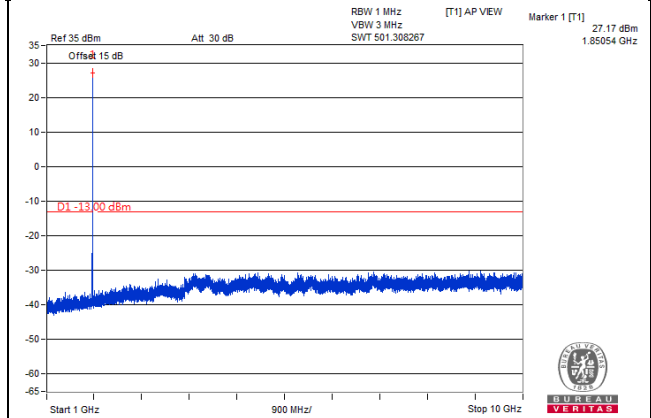

Frequency Range : 10GHz~27GHz

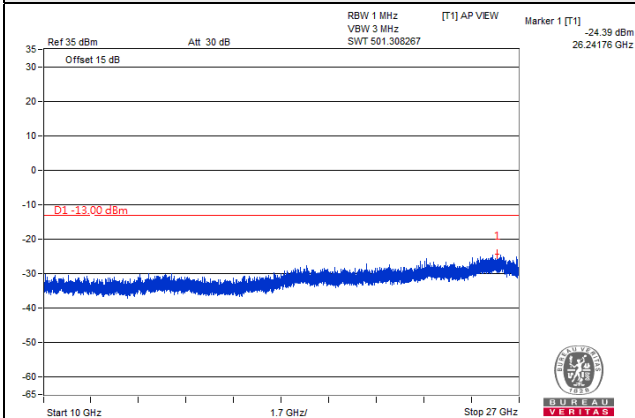

LTE Band 2, Channel Bandwidth 5MHz

Channel 18900 (1880.00MHz)

Frequency Range : 9kHz~1GHz

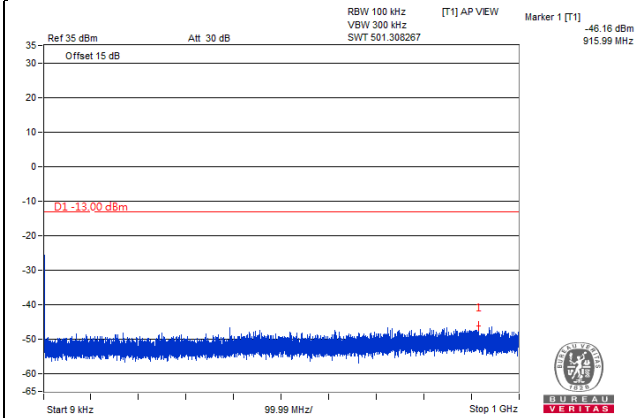

Frequency Range : 1GHz~10GHz

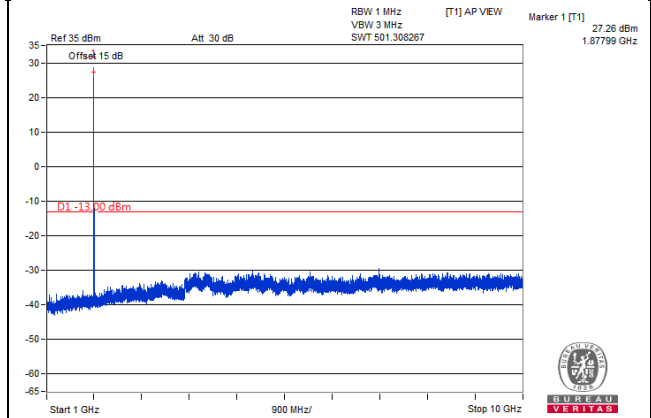

Frequency Range : 10GHz~27GHz

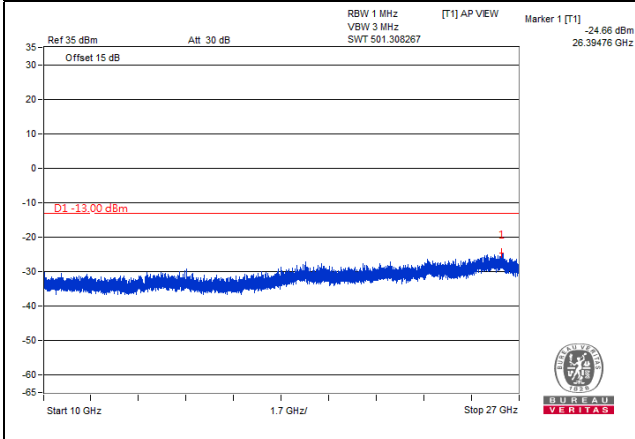

LTE Band 2, Channel Bandwidth 5MHz

Channel 19175 (1907.50MHz)

Frequency Range : 9kHz~1GHz

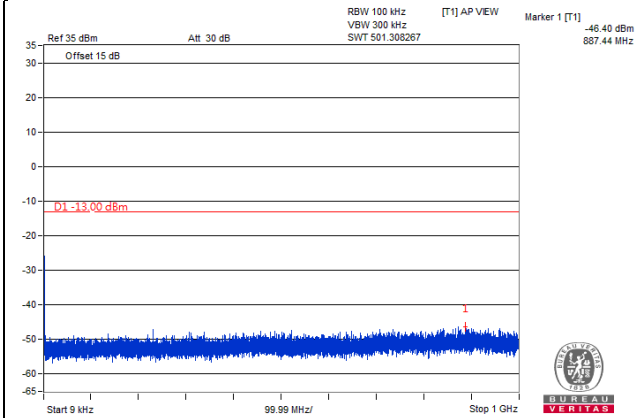

Frequency Range : 1GHz~10GHz

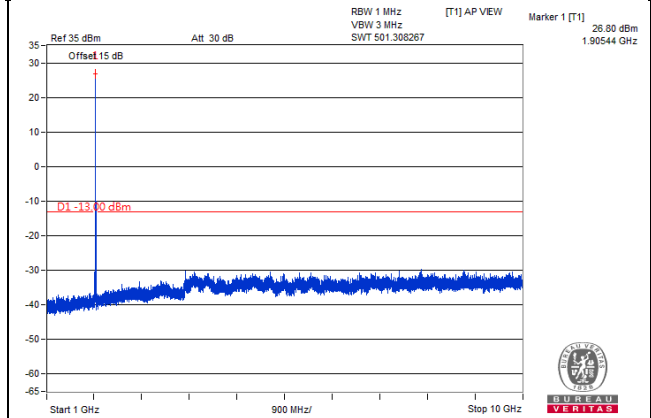

Frequency Range : 10GHz~27GHz

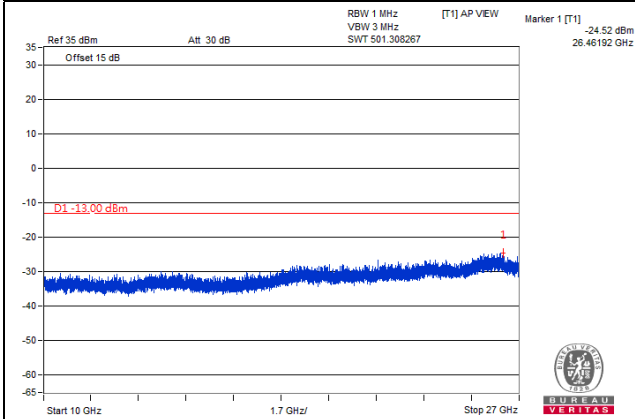

LTE Band 2, Channel Bandwidth 10MHz

Channel 18650 (1855.00MHz)

Frequency Range : 9kHz~1GHz

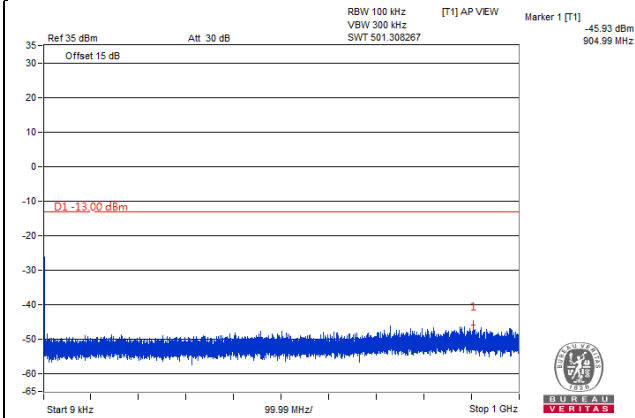

Frequency Range : 1GHz~10GHz

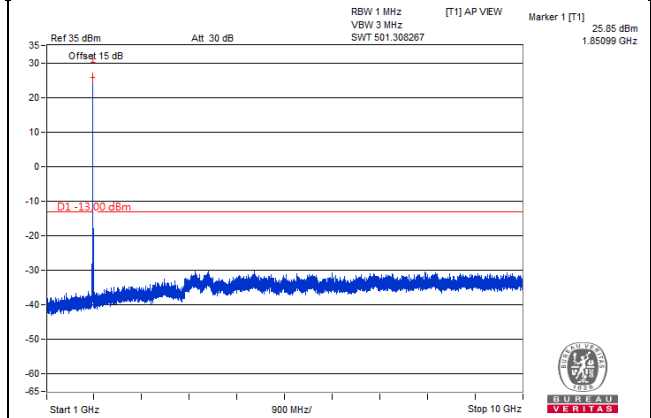

Frequency Range : 10GHz~27GHz

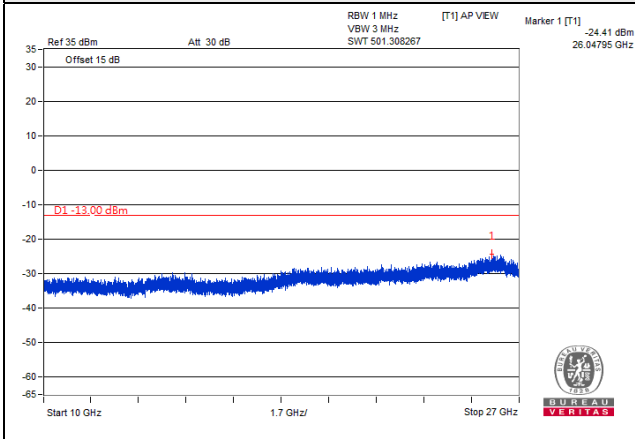

LTE Band 2, Channel Bandwidth 10MHz

Channel 18900 (1880.00MHz)

Frequency Range : 9kHz~1GHz

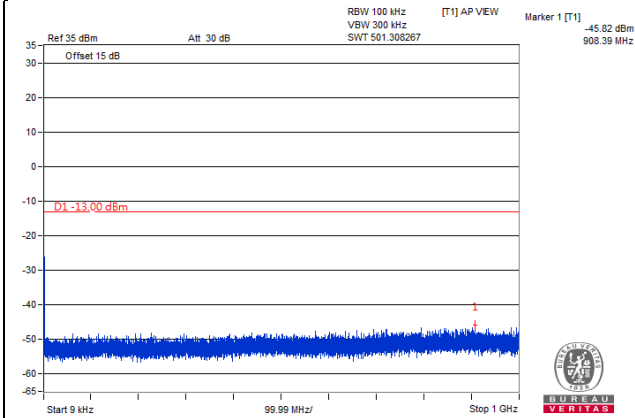

Frequency Range : 1GHz~10GHz

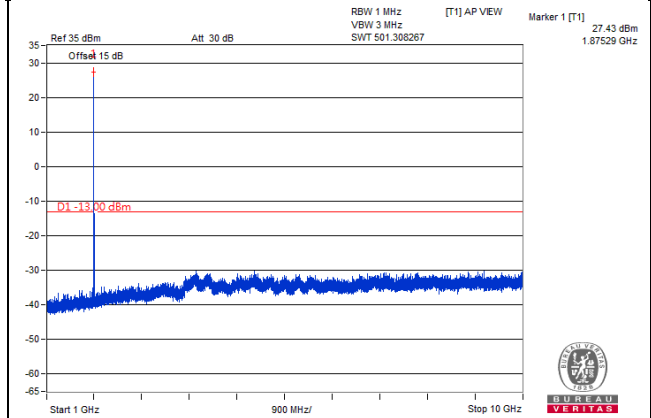

Frequency Range : 10GHz~27GHz

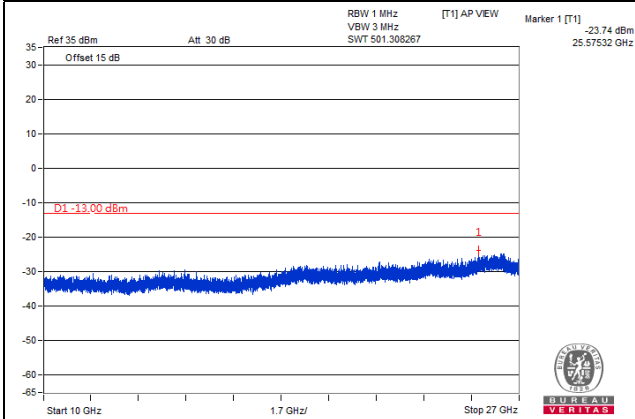

LTE Band 2, Channel Bandwidth 10MHz

Channel 19150 (1905.00MHz)

Frequency Range : 9kHz~1GHz

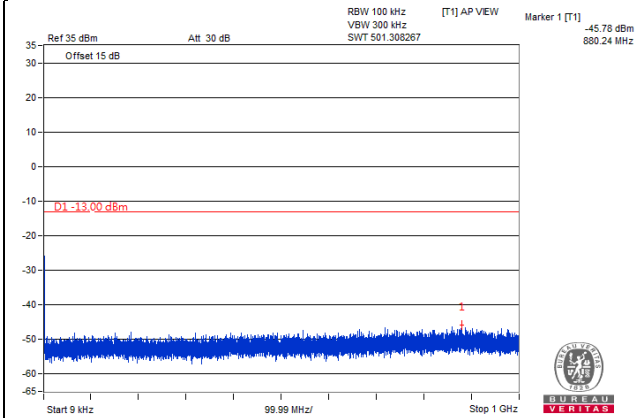

Frequency Range : 1GHz~10GHz

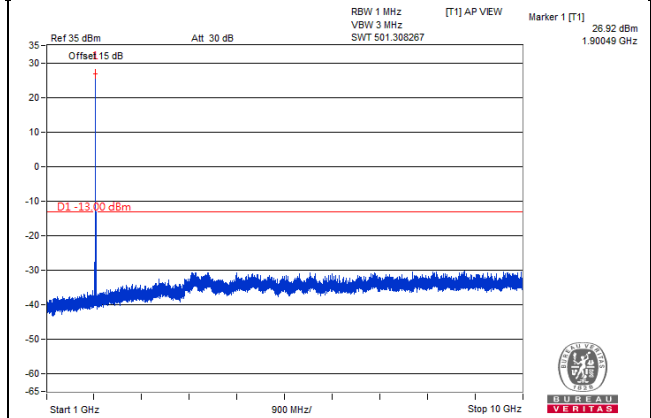

Frequency Range : 10GHz~27GHz

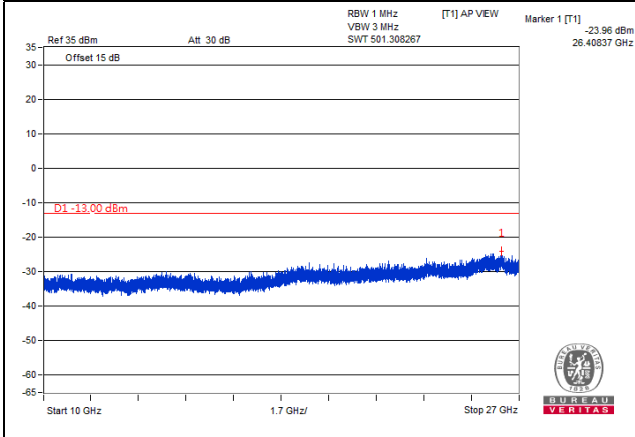

LTE Band 2, Channel Bandwidth 15MHz

Channel 18675 (1857.50MHz)

Frequency Range : 9kHz~1GHz

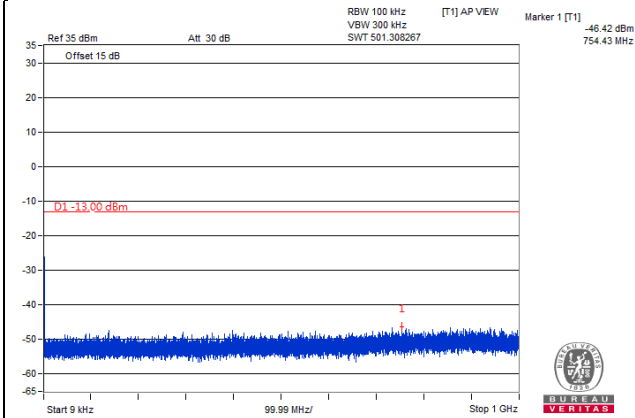

Frequency Range : 1GHz~10GHz

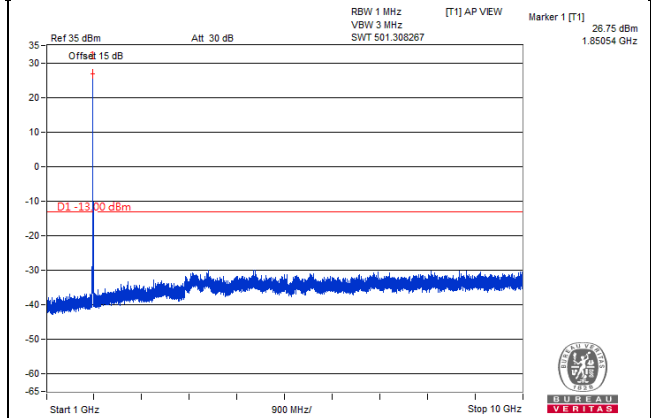

Frequency Range : 10GHz~27GHz

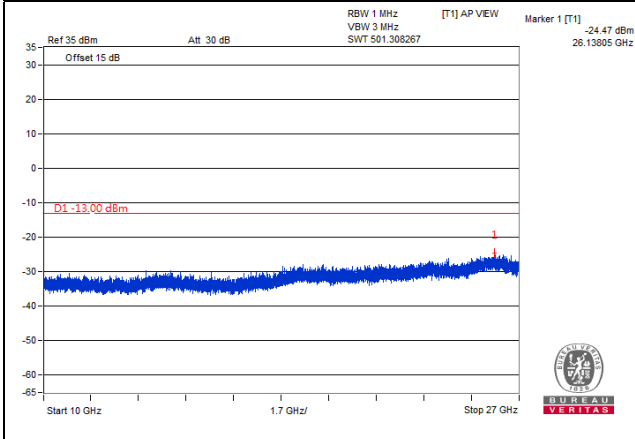

LTE Band 2, Channel Bandwidth 15MHz

Channel 18900 (1880.00MHz)

Frequency Range : 9kHz~1GHz

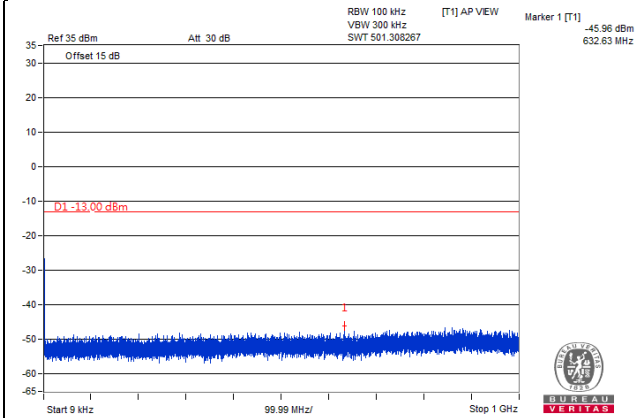

Frequency Range : 1GHz~10GHz

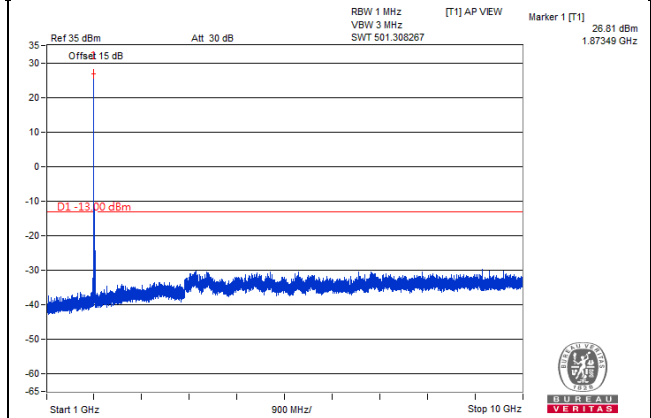

Frequency Range : 10GHz~27GHz

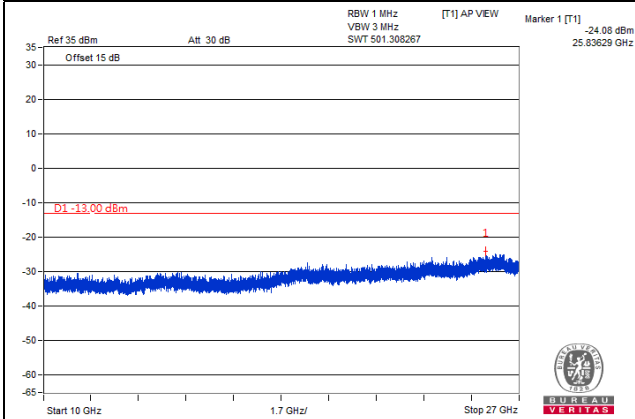

LTE Band 2, Channel Bandwidth 15MHz

Channel 19125 (1902.50MHz)

Frequency Range : 9kHz~1GHz

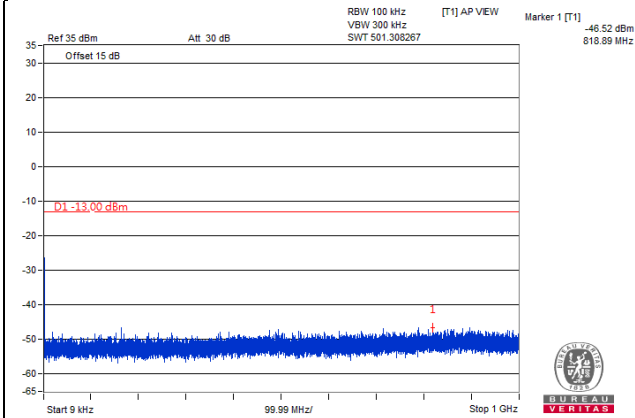

Frequency Range : 1GHz~10GHz

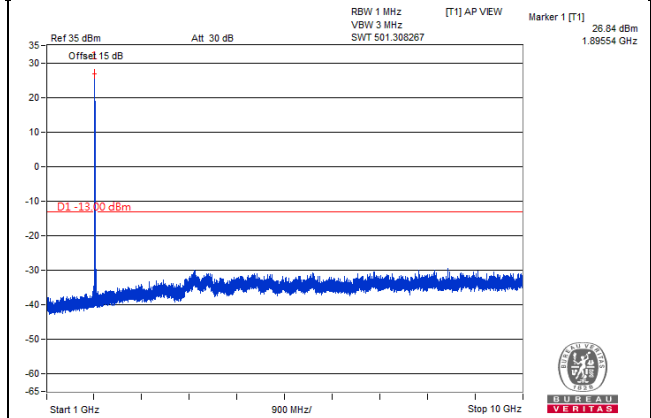

Frequency Range : 10GHz~27GHz

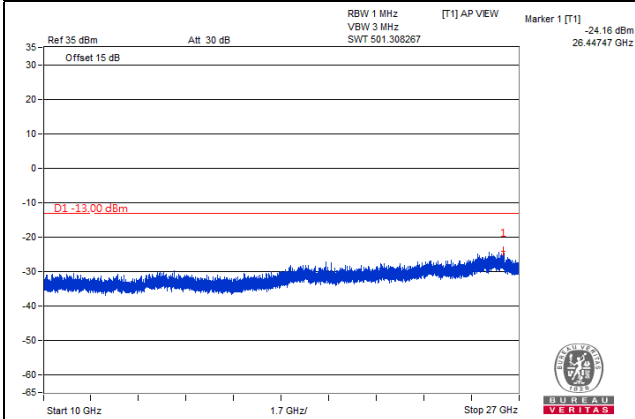

LTE Band 2, Channel Bandwidth 20MHz

Channel 18700 (1860.00MHz)

Frequency Range : 9kHz~1GHz

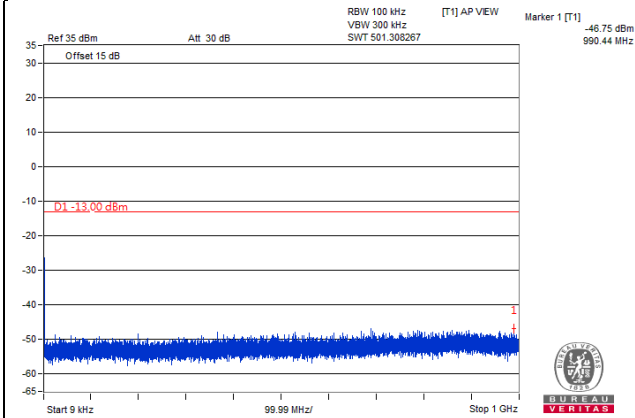

Frequency Range : 1GHz~10GHz

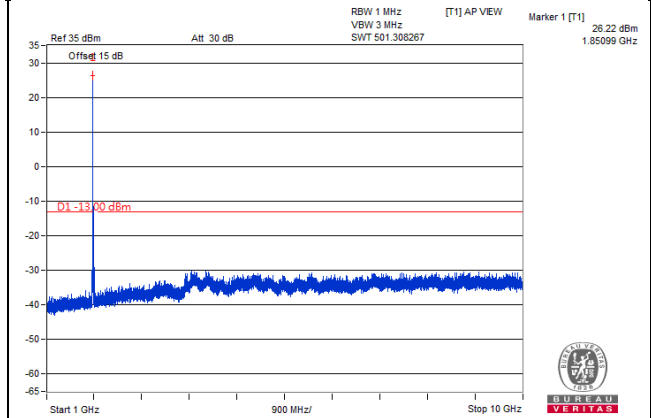

Frequency Range : 10GHz~27GHz

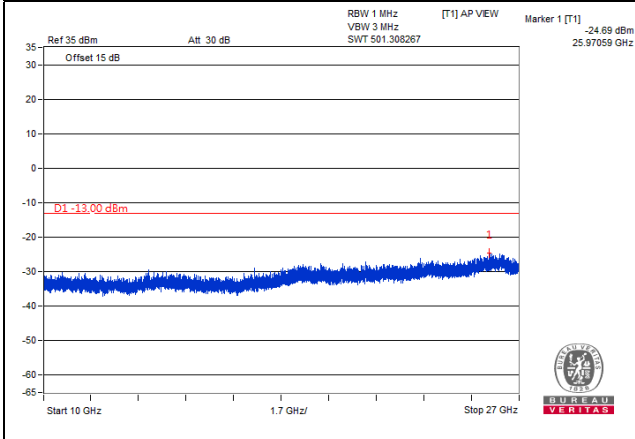

LTE Band 2, Channel Bandwidth 20MHz

Channel 18900 (1880.00MHz)

Frequency Range : 9kHz~1GHz

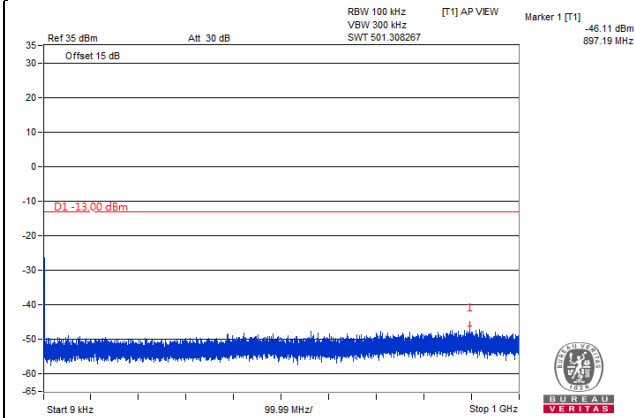

Frequency Range : 1GHz~10GHz

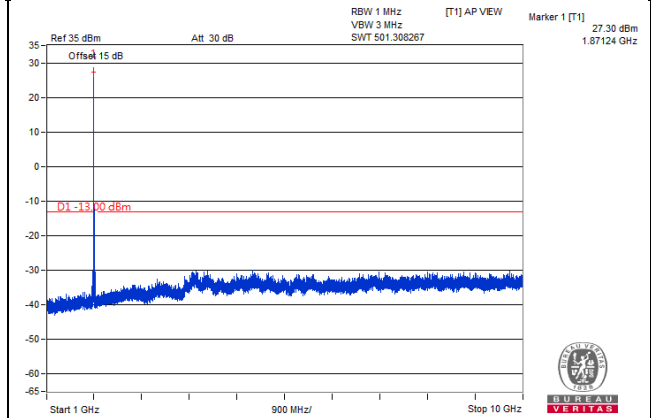

Frequency Range : 10GHz~27GHz

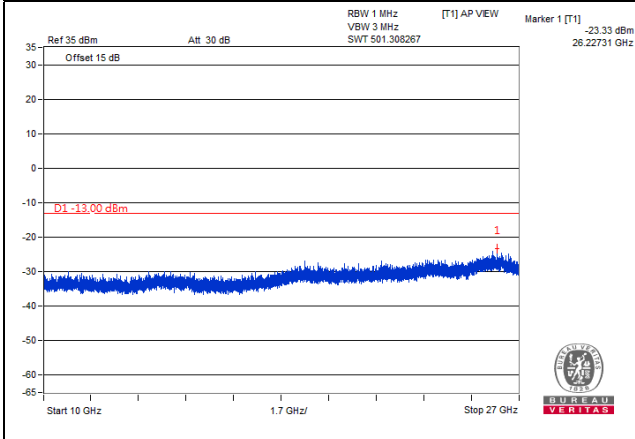

LTE Band 2, Channel Bandwidth 20MHz

Channel 19100 (1900.00MHz)

Frequency Range : 9kHz~1GHz

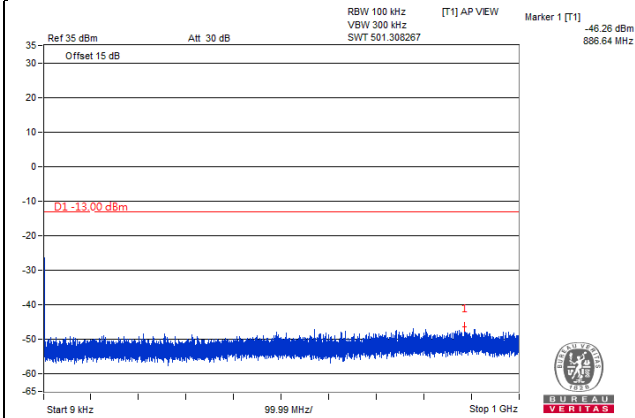

Frequency Range : 1GHz~10GHz

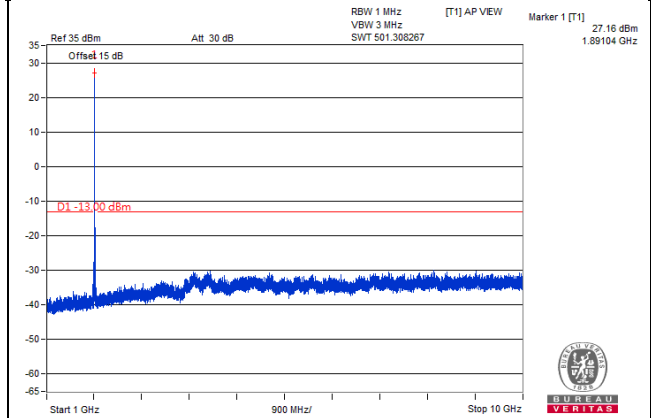

Frequency Range : 10GHz~27GHz

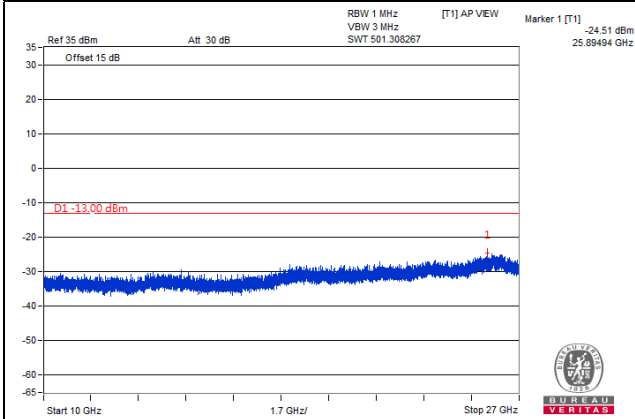

LTE Band 25, Channel Bandwidth 1.4MHz

Channel 26047 (1850.7MHz)

Frequency Range : 9kHz~1GHz

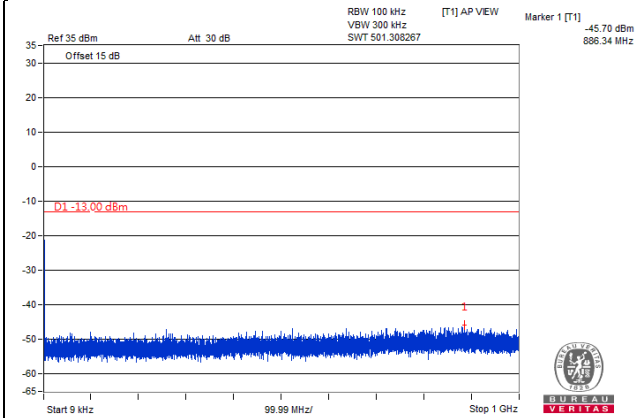

Frequency Range : 1GHz~10GHz

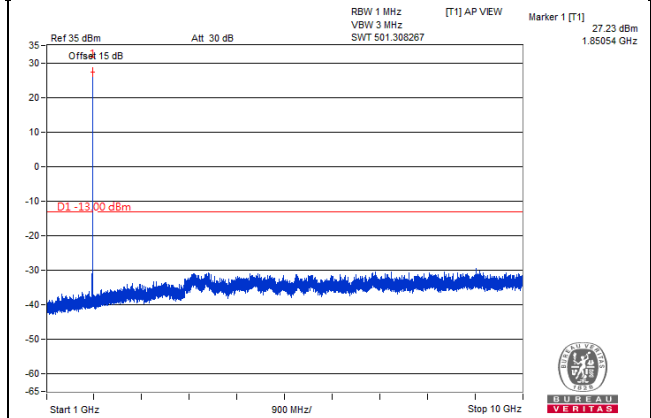

Frequency Range : 10GHz~27GHz

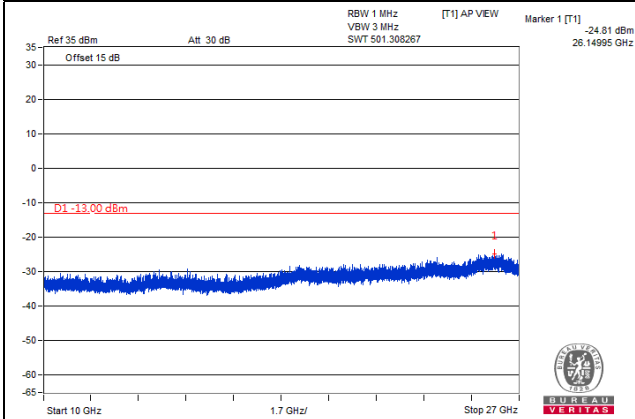

LTE Band 25, Channel Bandwidth 1.4MHz

Channel 26365 (1882.5MHz)

Frequency Range : 9kHz~1GHz

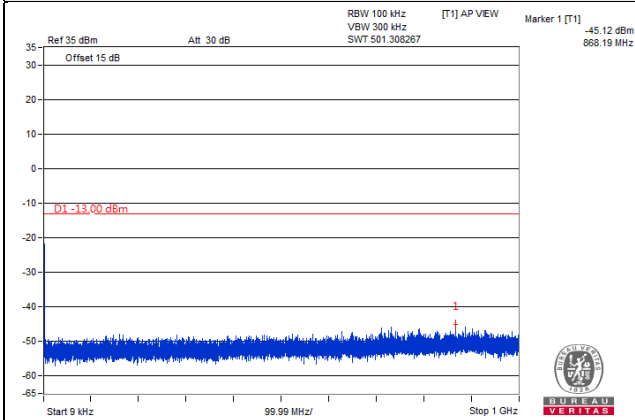

Frequency Range : 1GHz~10GHz

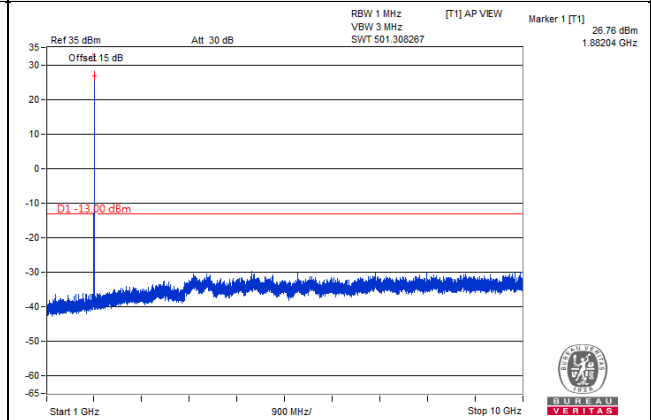

Frequency Range : 10GHz~27GHz

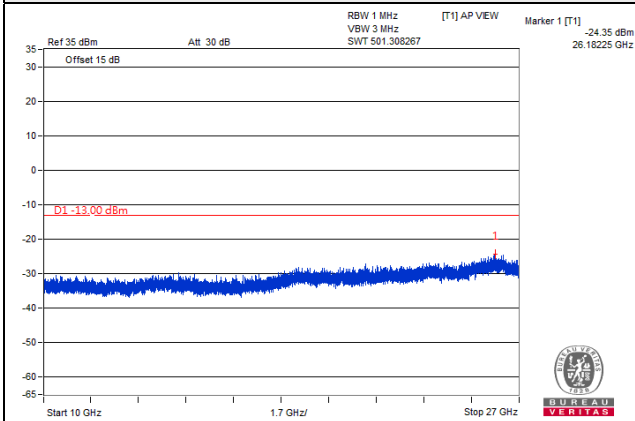

LTE Band 25, Channel Bandwidth 1.4MHz

Channel 26683 (1914.3MHz)

Frequency Range : 9kHz~1GHz

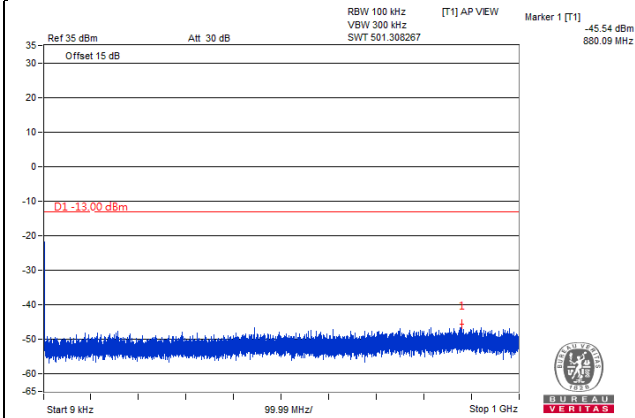

Frequency Range : 1GHz~10GHz

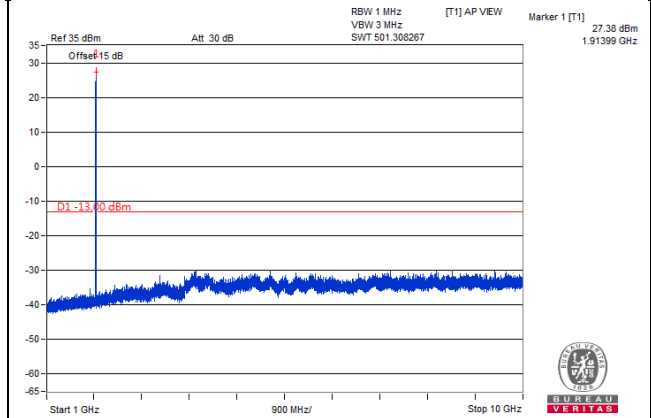

Frequency Range : 10GHz~27GHz

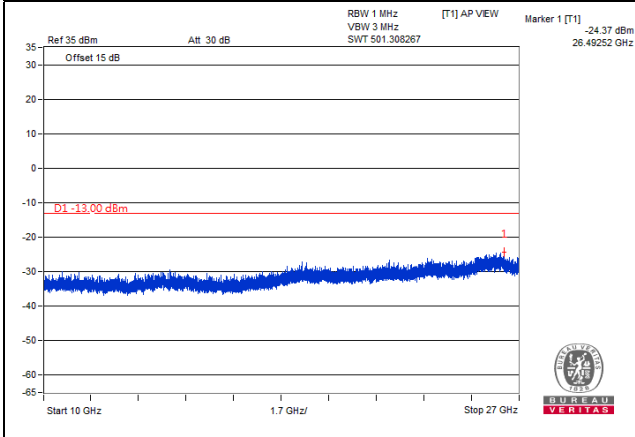

LTE Band 25, Channel Bandwidth 3MHz

Channel 26055 (1851.5MHz)

Frequency Range : 9kHz~1GHz

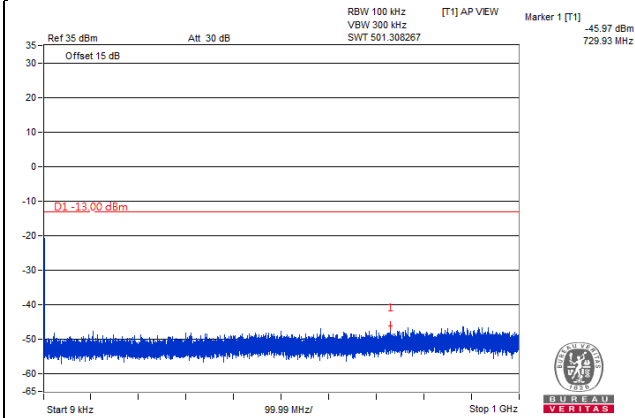

Frequency Range : 1GHz~10GHz

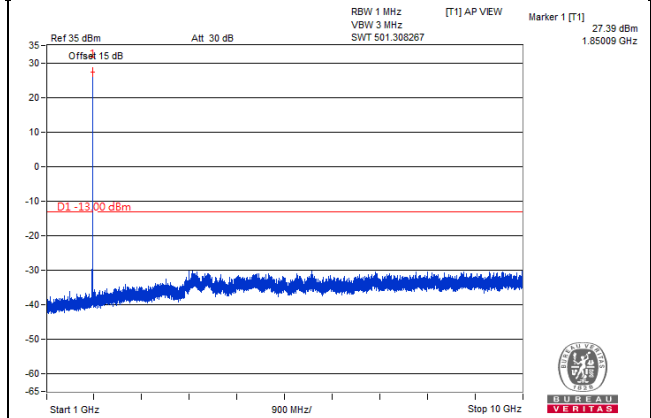

Frequency Range : 10GHz~27GHz

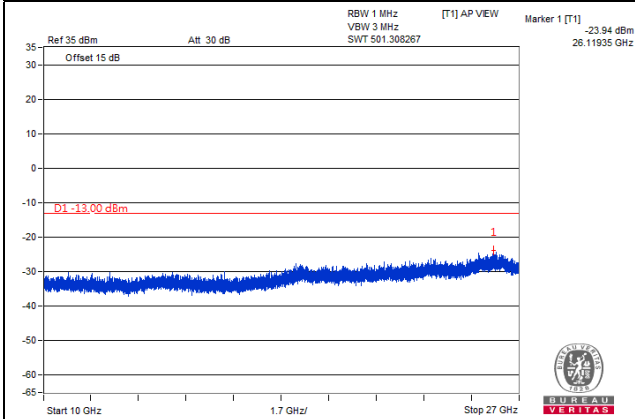

LTE Band 25, Channel Bandwidth 3MHz

Channel 26365 (1882.5MHz)

Frequency Range : 9kHz~1GHz

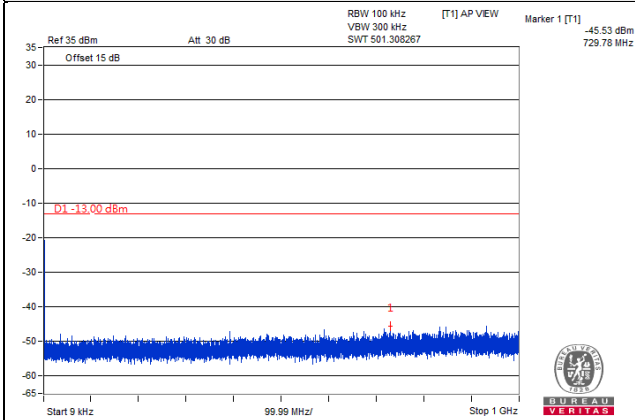

Frequency Range : 1GHz~10GHz

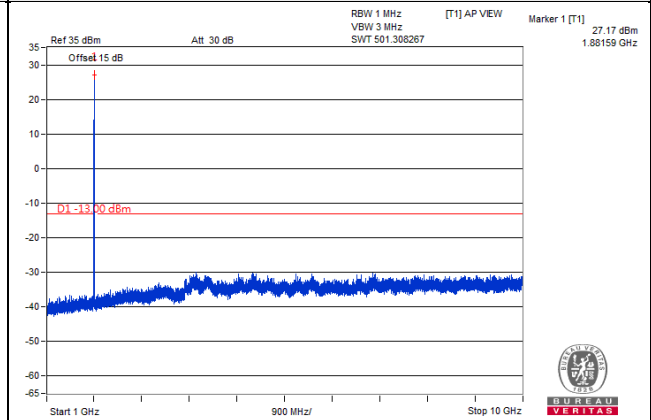

Frequency Range : 10GHz~27GHz

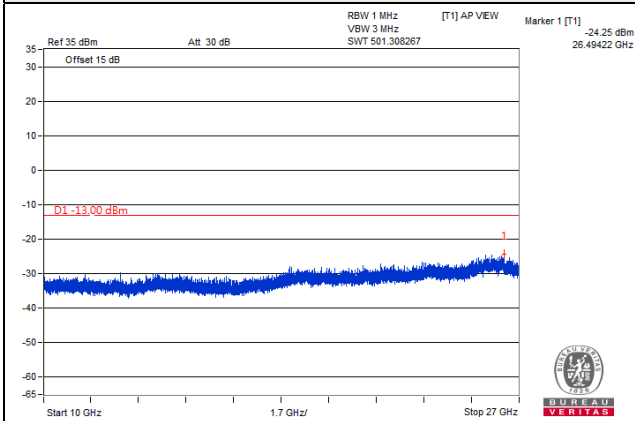

LTE Band 25, Channel Bandwidth 3MHz

Channel 26675 (1913.5MHz)

Frequency Range : 9kHz~1GHz

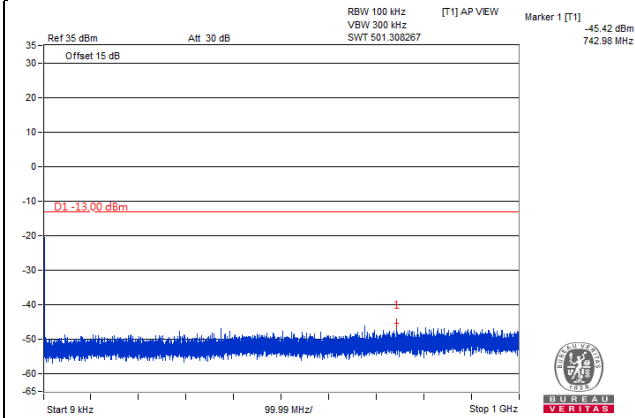

Frequency Range : 1GHz~10GHz

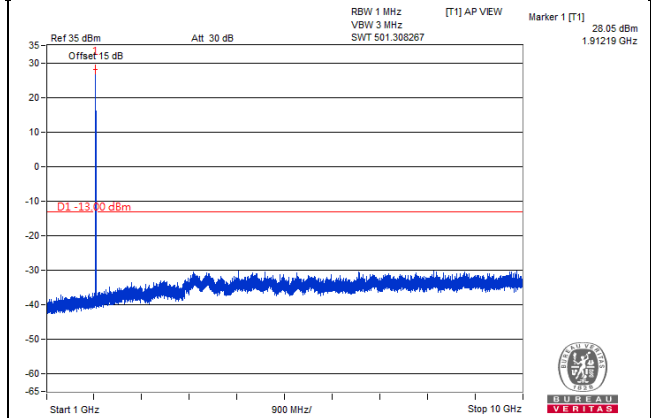

Frequency Range : 10GHz~27GHz

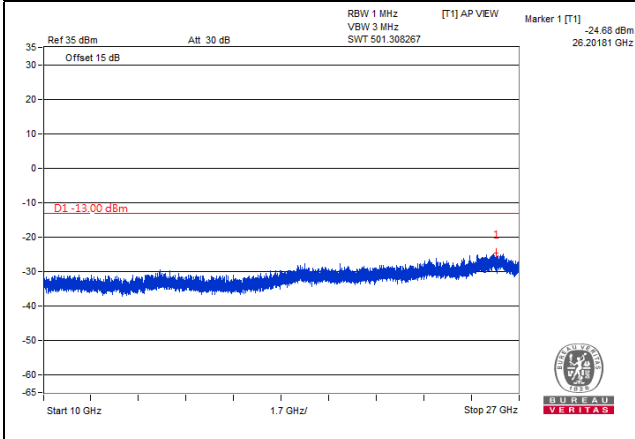

LTE Band 25, Channel Bandwidth 5MHz

Channel 26065 (1852.5MHz)

Frequency Range : 9kHz~1GHz

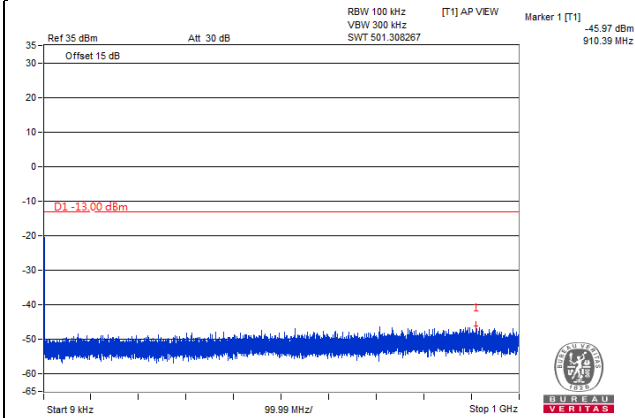

Frequency Range : 1GHz~10GHz

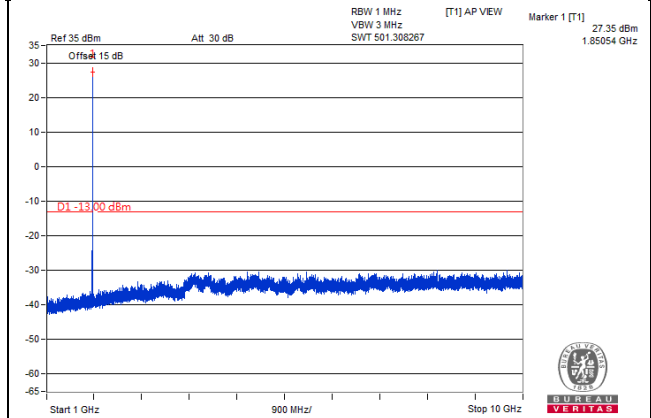

Frequency Range : 10GHz~27GHz

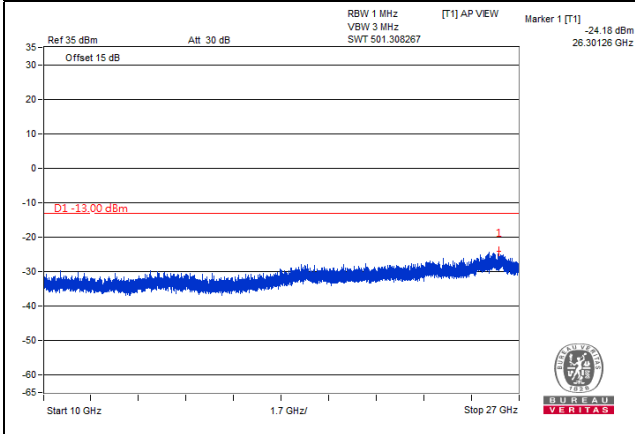

LTE Band 25, Channel Bandwidth 5MHz

Channel 26365 (1882.5MHz)

Frequency Range : 9kHz~1GHz

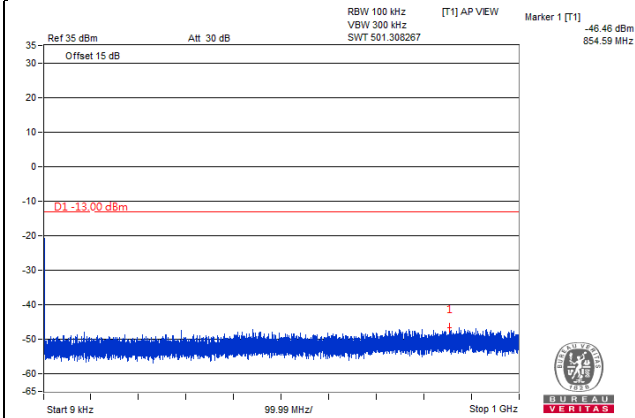

Frequency Range : 1GHz~10GHz

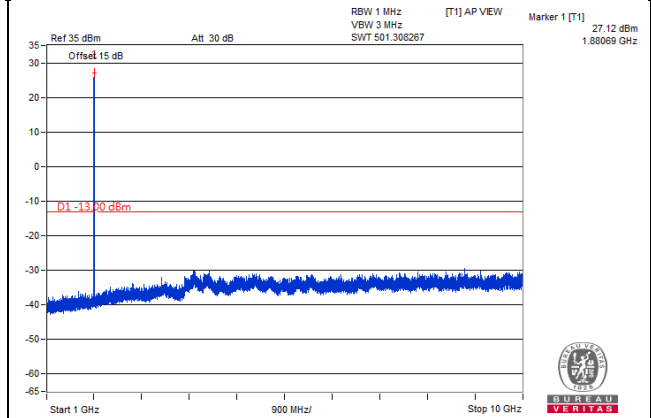

Frequency Range : 10GHz~27GHz

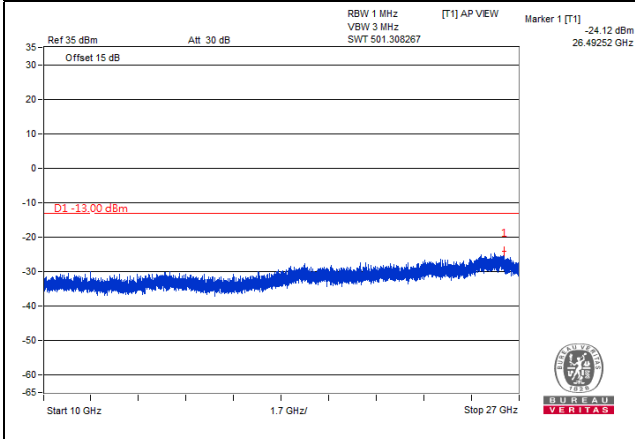

LTE Band 25, Channel Bandwidth 5MHz

Channel 26665 (1912.5MHz)

Frequency Range : 9kHz~1GHz

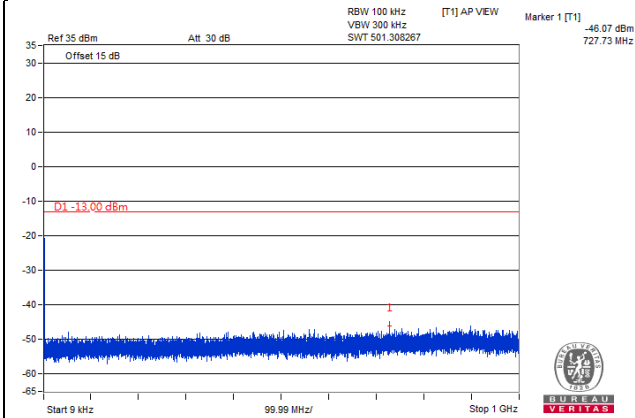

Frequency Range : 1GHz~10GHz

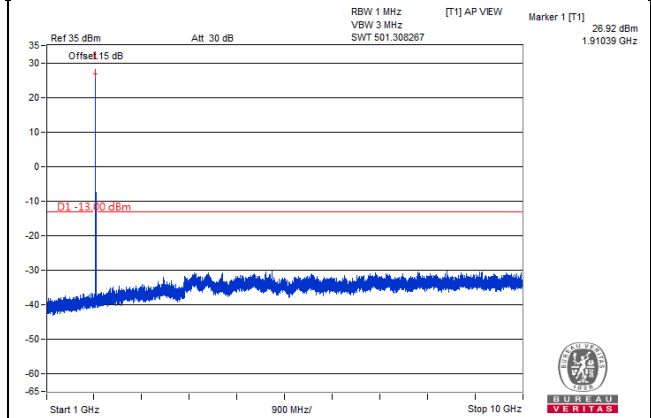

Frequency Range : 10GHz~27GHz

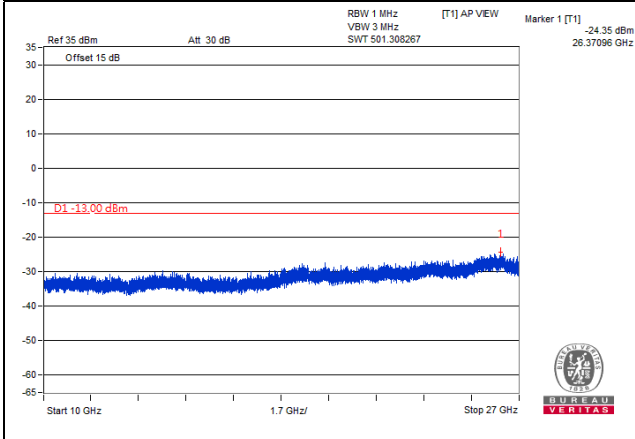

LTE Band 25, Channel Bandwidth 10MHz

Channel 26090 (1855.0MHz)

Frequency Range : 9kHz~1GHz

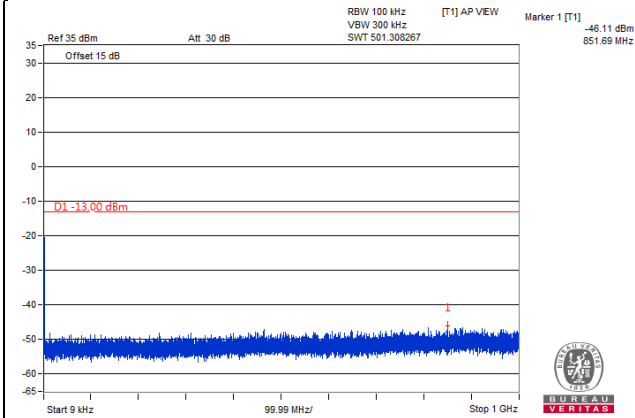

Frequency Range : 1GHz~10GHz

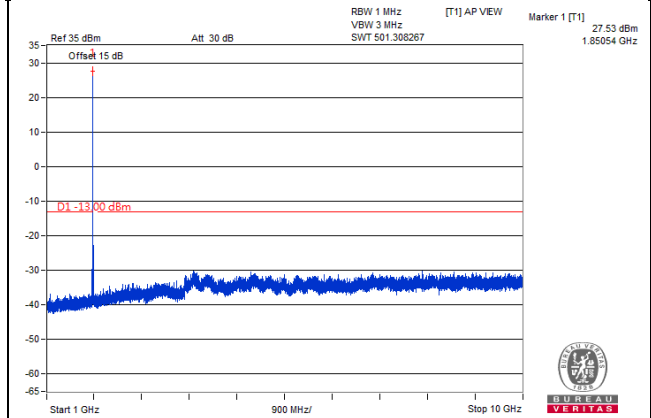

Frequency Range : 10GHz~27GHz

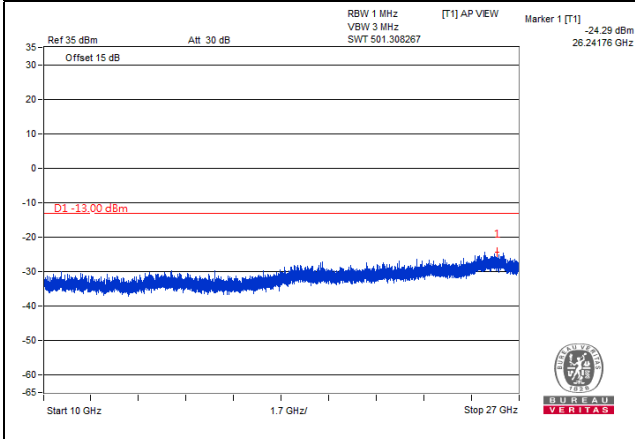

LTE Band 25, Channel Bandwidth 10MHz

Channel 26365 (1882.5MHz)

Frequency Range : 9kHz~1GHz

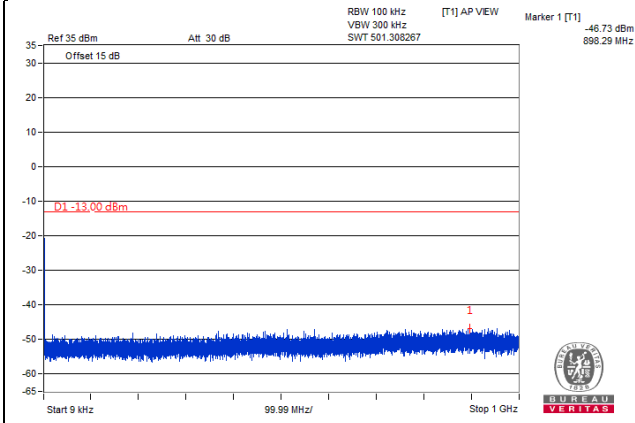

Frequency Range : 1GHz~10GHz

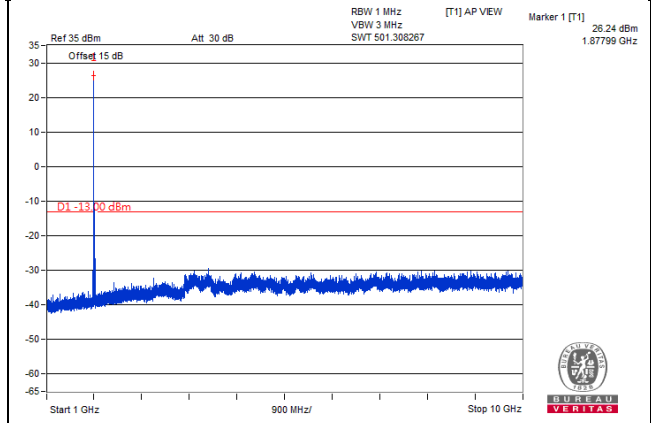

Frequency Range : 10GHz~27GHz

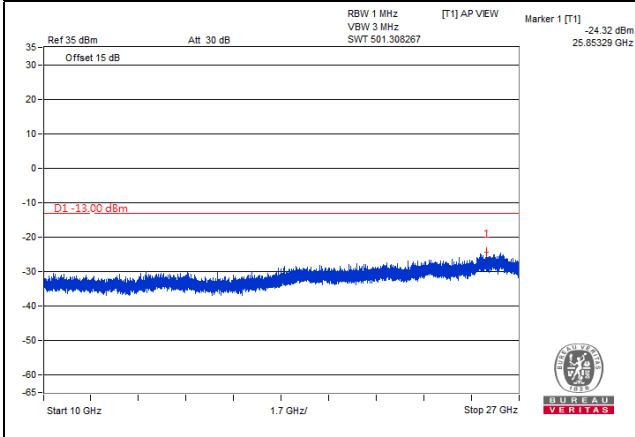

LTE Band 25, Channel Bandwidth 10MHz

Channel 26640 (1910.0MHz)

Frequency Range : 9kHz~1GHz

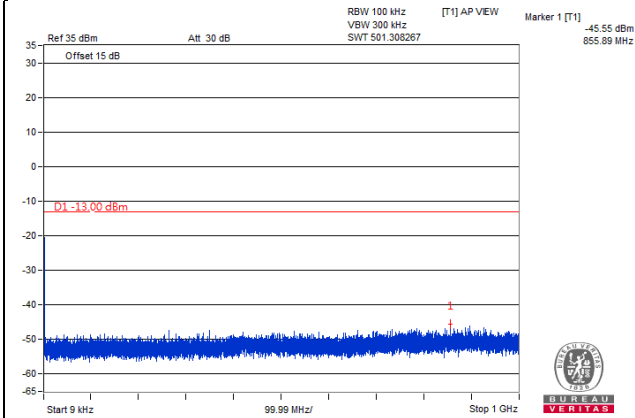

Frequency Range : 1GHz~10GHz

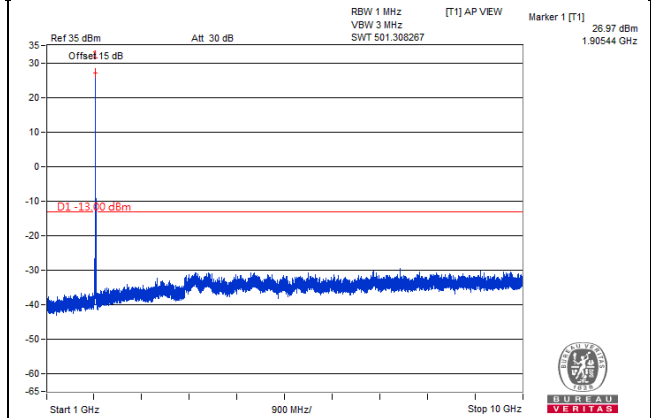

Frequency Range : 10GHz~27GHz

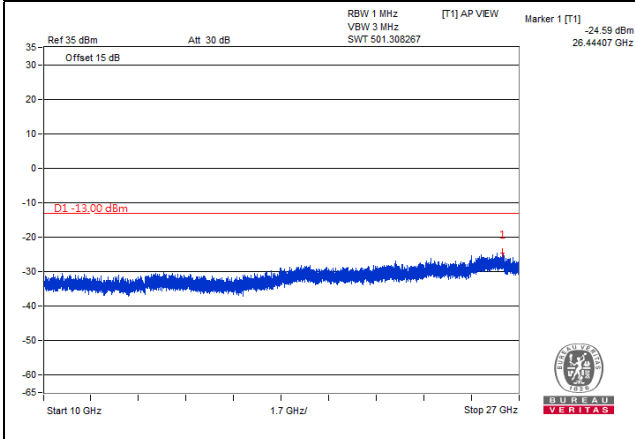

LTE Band 25, Channel Bandwidth 15MHz

Channel 26115 (1857.5MHz)

Frequency Range : 9kHz~1GHz

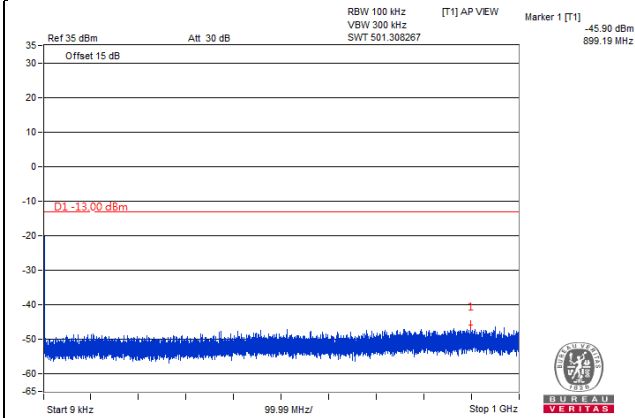

Frequency Range : 1GHz~10GHz

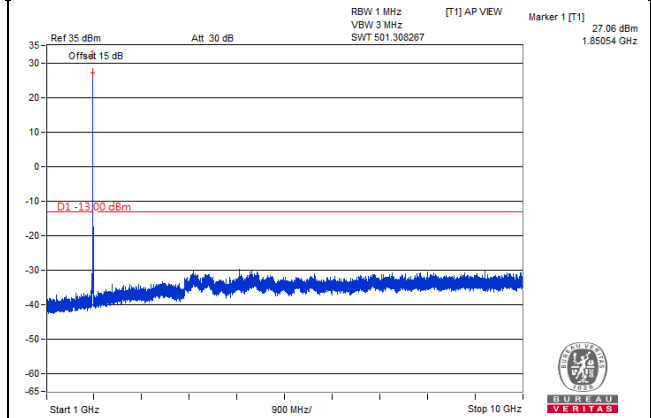

Frequency Range : 10GHz~27GHz

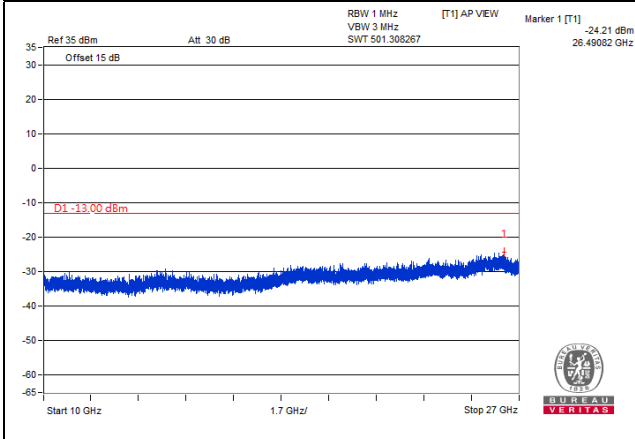

LTE Band 25, Channel Bandwidth 15MHz

Channel 26365 (1882.5MHz)

Frequency Range : 9kHz~1GHz

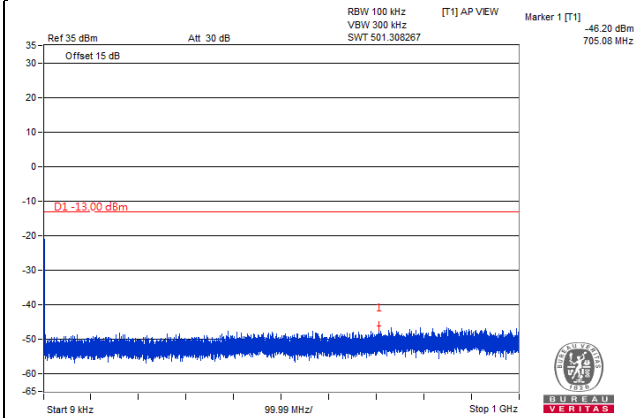

Frequency Range : 1GHz~10GHz

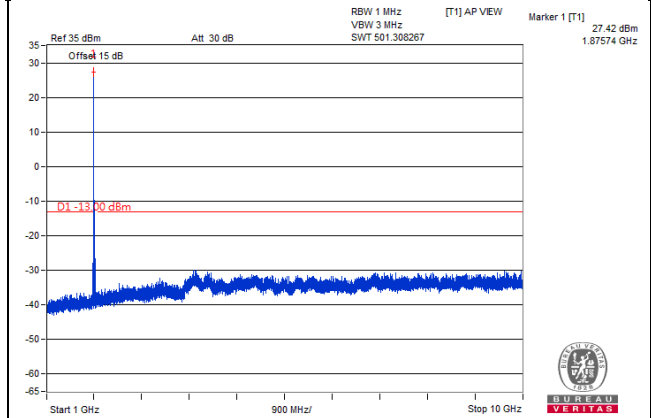

Frequency Range : 10GHz~27GHz

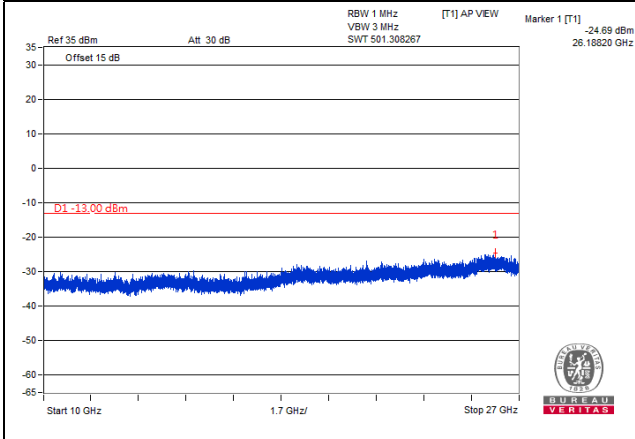

LTE Band 25, Channel Bandwidth 15MHz

Channel 26615 (1907.5MHz)

Frequency Range : 9kHz~1GHz

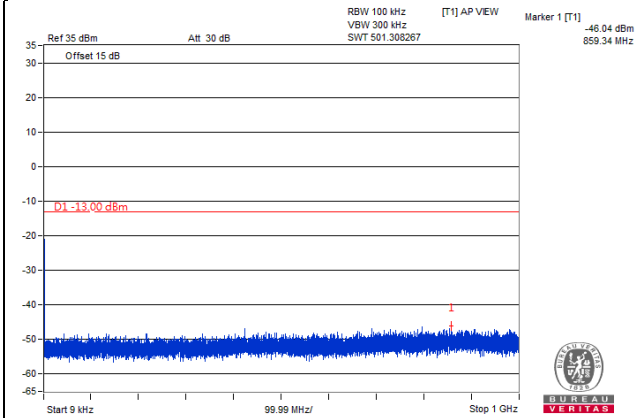

Frequency Range : 1GHz~10GHz

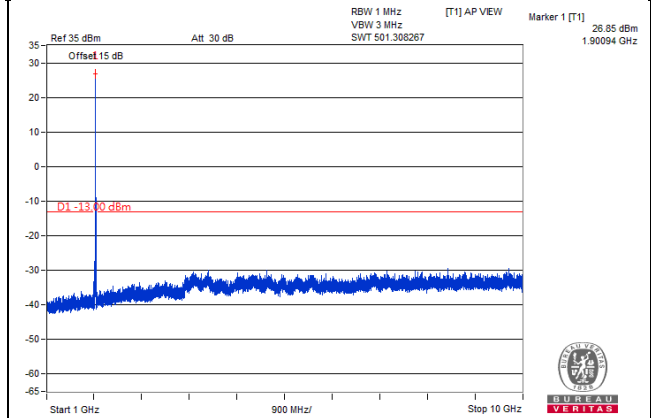

Frequency Range : 10GHz~27GHz

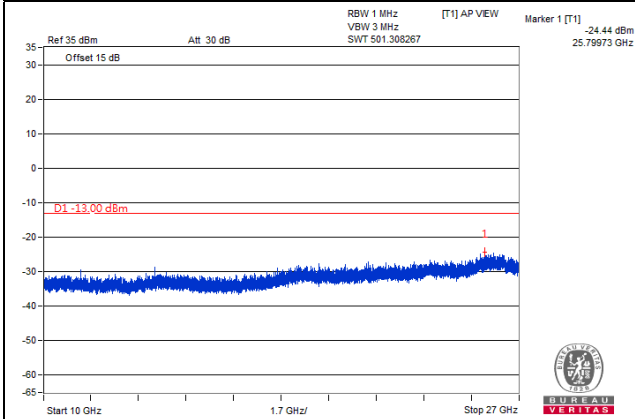

LTE Band 25, Channel Bandwidth 20MHz

Channel 26140 (1860.0MHz)

Frequency Range : 9kHz~1GHz

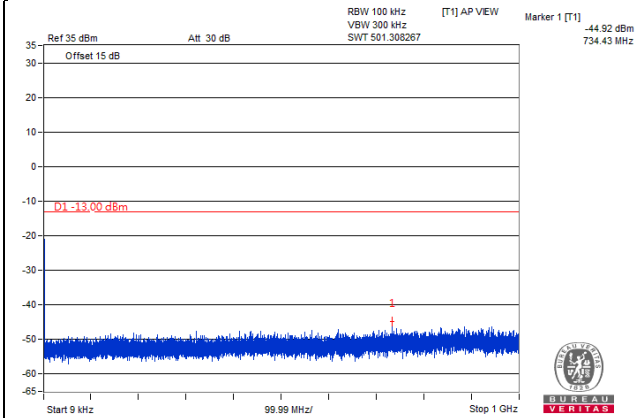

Frequency Range : 1GHz~10GHz

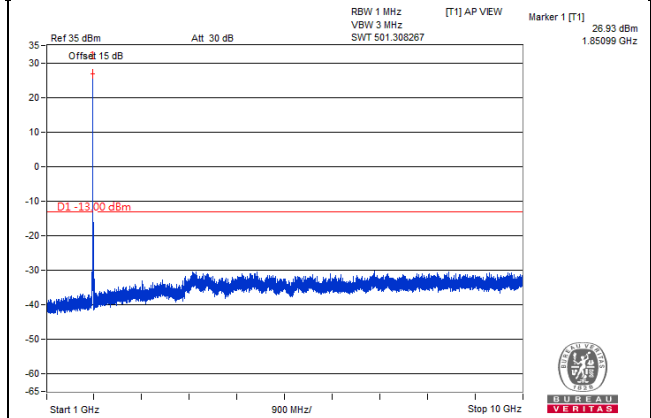

Frequency Range : 10GHz~27GHz

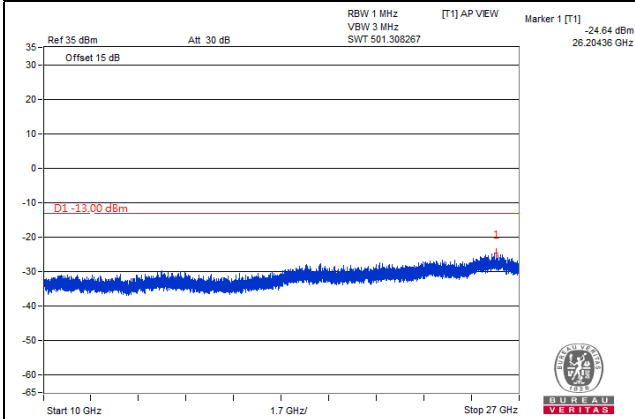

LTE Band 25, Channel Bandwidth 20MHz

Channel 26365 (1882.5MHz)

Frequency Range : 9kHz~1GHz

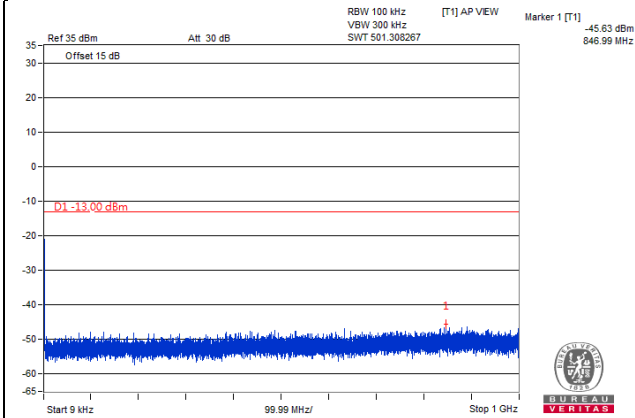

Frequency Range : 1GHz~10GHz

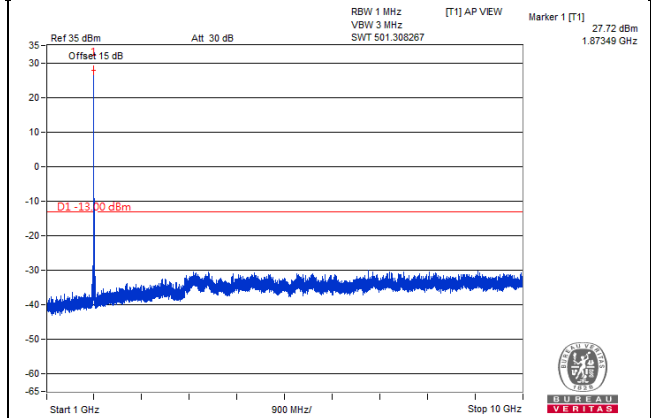

Frequency Range : 10GHz~27GHz

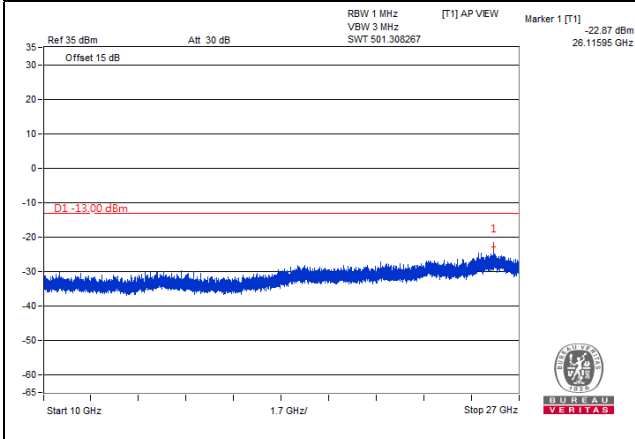

LTE Band 25, Channel Bandwidth 20MHz

Channel 26590 (1905.0MHz)

Frequency Range : 9kHz~1GHz

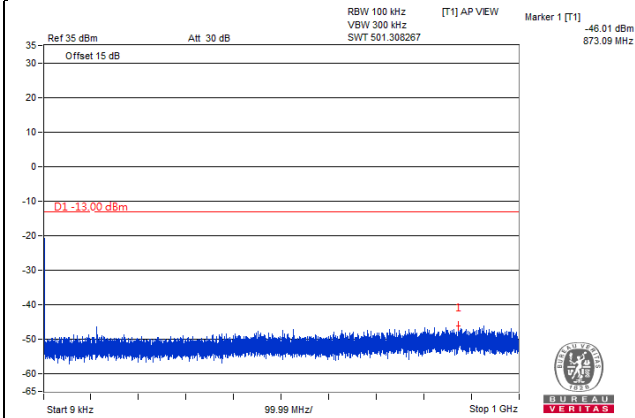

Frequency Range : 1GHz~10GHz

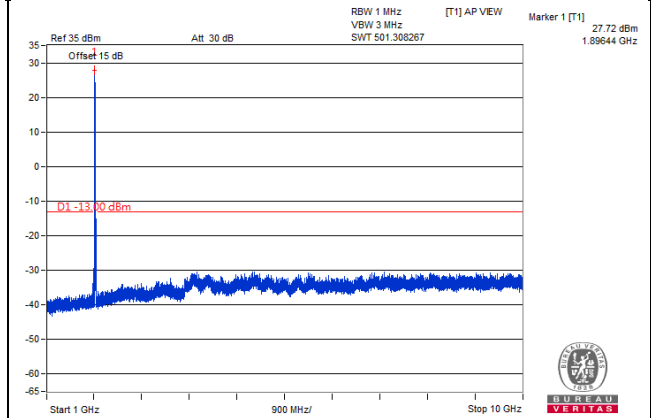

Frequency Range : 10GHz~27GHz

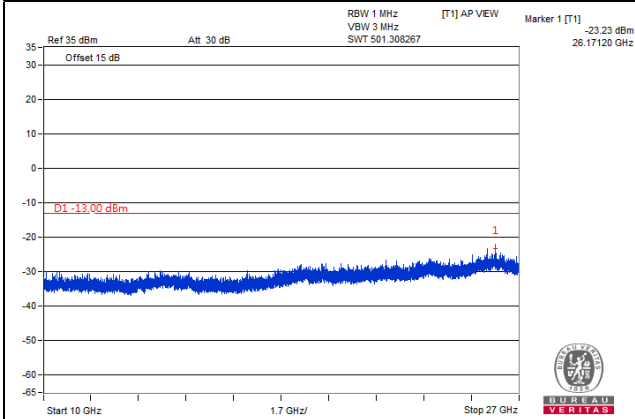

4.8 Radiated Emission Measurement

4.8.1 Limits of Radiated Emission Measurement

The power of any emission outside of the authorized operating frequency ranges must be attenuated below the transmitting power (P) by a factor of at least $43 + 10 \log(P)$ dB. The emission limit equal to -13dBm .

4.8.2 Test Procedure

- a. Substitution method is used for E.I.R.P measurement. In the semi-anechoic chamber, EUT placed on the 0.8m height of Turn Table, rotated the table around 360 degrees to search the maximum radiation power and receiver antenna shall be rotated vertical and horizontal polarization and moved height from 1m to 4m to find the maximum polar radiated power. The "Read Value" is the spectrum reading the maximum power value.
- b. The substitution horn antenna is substituted for EUT at the same position and signals generator export the CW signal to the substitution antenna via a TX cable. Rotated the Turn Table and moved receiving antenna to find the maximum radiation power. Adjust output power level of S.G to get a Value of spectrum reading equal to "Read Value" of step a. Record the power level of S.G
- c. $\text{EIRP} = \text{Output power level of S.G} - \text{TX cable loss} + \text{Antenna gain of substitution horn}$.
- d. E.R.P power can be calculated form E.I.R.P power by subtracting the gain of dipole, $\text{E.R.P power} = \text{E.I.R.P power} - 2.15\text{dBi}$.

NOTE: The resolution bandwidth and video bandwidth of test receiver/spectrum analyzer is 1MHz/3MHz.

4.8.3 Deviation from Test Standard

No deviation.

4.8.4 Test Setup

For radiated emission 30MHz to 1GHz

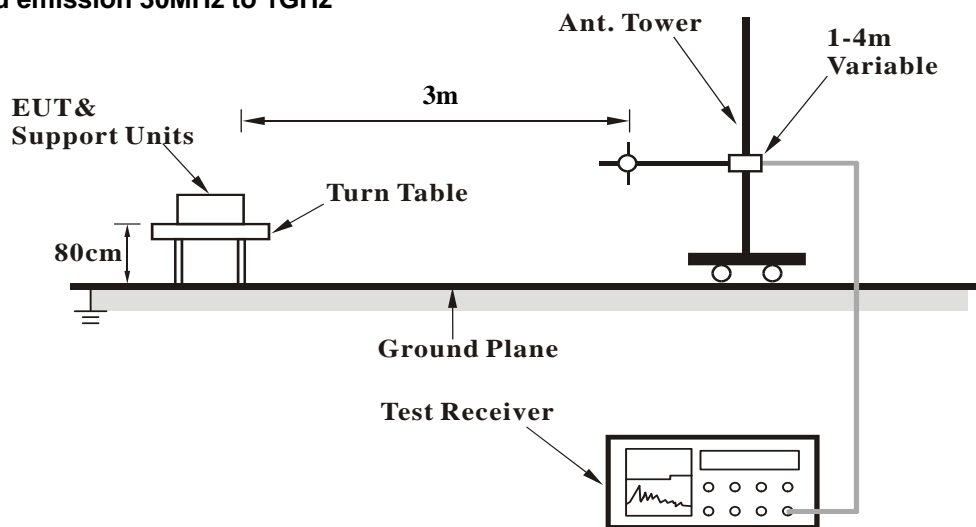

For radiated emission above 1GHz

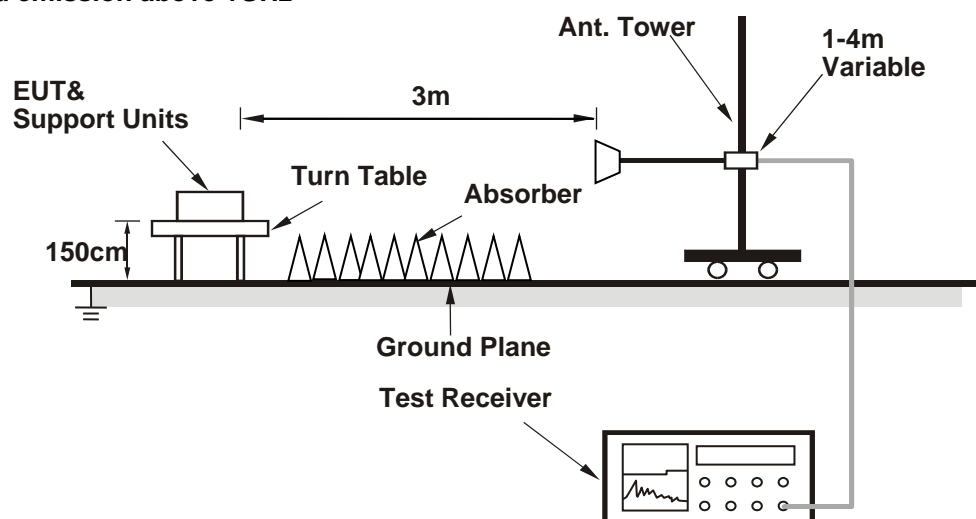

For the actual test configuration, please refer to the attached file (Test Setup Photo).

4.8.5 Test Results

Below 1GHz
PCS Mode

Mode	TX channel 661 (1880.0MHz)	Frequency Range	Below 1000 MHz
Environmental Conditions	25deg. C, 71%RH	Input Power	120Vac, 60Hz
Tested By	Noah Chang		

Antenna Polarity & Test Distance: Horizontal at 3 M							
No.	Freq. (MHz)	Reading (dBm)	S.G Power Value (dBm)	Correction Factor (dB)	EIRP (dBm)	Limit (dBm)	Margin (dB)
1	47.46	-54.38	-43.07	-10.16	-53.23	-13.00	-40.23
2	202.66	-51.78	-65.89	5.46	-60.43	-13.00	-47.43
3	282.20	-53.94	-63.14	5.22	-57.92	-13.00	-44.92
4	546.04	-64.80	-69.97	4.66	-65.31	-13.00	-52.31
5	747.80	-46.63	-47.70	4.65	-43.05	-13.00	-30.05
6	833.16	-69.34	-67.54	3.98	-63.56	-13.00	-50.56

Remarks:

1. EIRP (dBm) = S.G Value (dBm) + Correction Factor (dB).
2. Correction Factor (dB) = Substitution Antenna Gain (dB) + Cable Loss (dB).

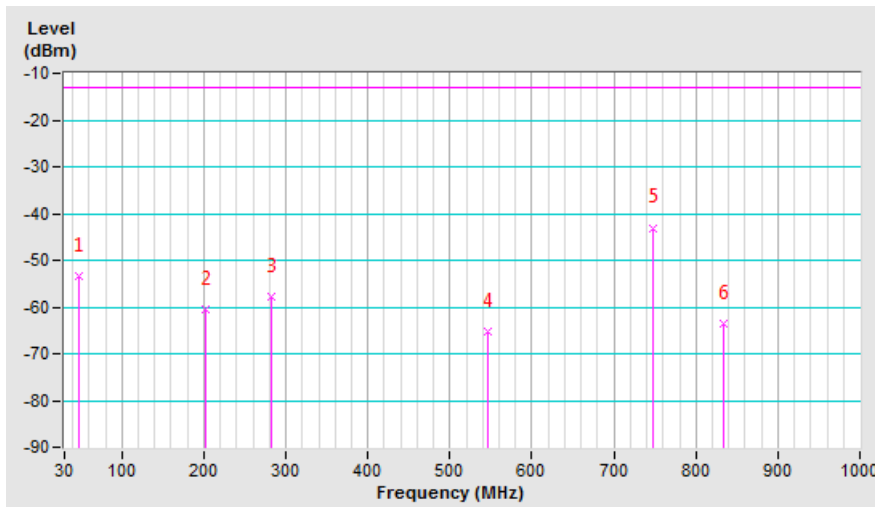

Mode	TX channel 661 (1880.0MHz)	Frequency Range	Below 1000 MHz
Environmental Conditions	25deg. C, 71%RH	Input Power	120Vac, 60Hz
Tested By	Noah Chang		

Antenna Polarity & Test Distance: Vertical at 3 M							
No.	Freq. (MHz)	Reading (dBm)	S.G Power Value (dBm)	Correction Factor (dB)	EIRP (dBm)	Limit (dBm)	Margin (dB)
1	47.46	-44.30	-40.14	-10.16	-50.30	-13.00	-37.30
2	171.62	-58.07	-59.56	1.86	-57.70	-13.00	-44.70
3	247.28	-56.52	-61.63	5.41	-56.22	-13.00	-43.22
4	547.98	-62.25	-65.72	4.65	-61.07	-13.00	-48.07
5	644.98	-68.99	-69.24	4.80	-64.44	-13.00	-51.44
6	848.68	-68.98	-66.50	3.97	-62.53	-13.00	-49.53

Remarks:

1. EIRP (dBm) = S.G Value (dBm) + Correction Factor (dB).
2. Correction Factor (dB) = Substitution Antenna Gain (dB) + Cable Loss (dB).

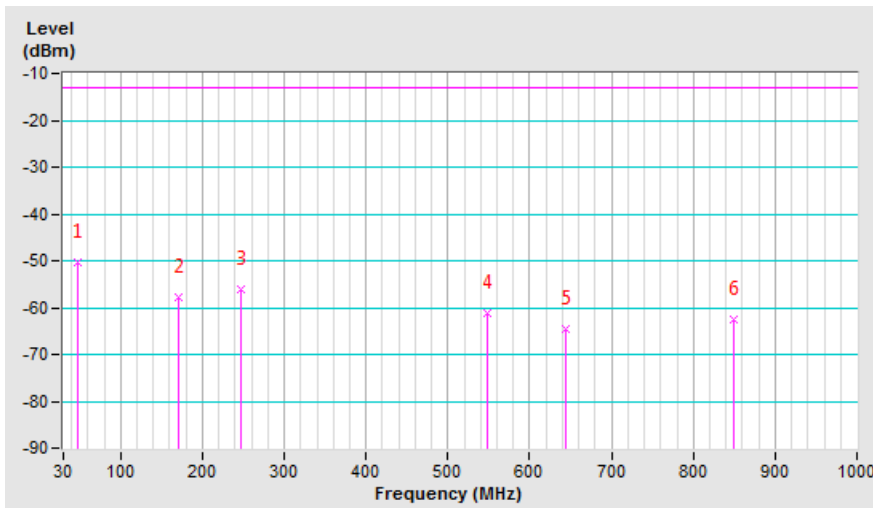

CDMA Mode

Mode	TX channel 25 (1851.25MHz)	Frequency Range	Below 1000 MHz
Environmental Conditions	25deg. C, 71%RH	Input Power	120Vac, 60Hz
Tested By	Noah Chang		

Antenna Polarity & Test Distance: Horizontal at 3 M							
No.	Freq. (MHz)	Reading (dBm)	S.G Power Value (dBm)	Correction Factor (dB)	EIRP (dBm)	Limit (dBm)	Margin (dB)
1	51.34	-57.2	-49.5	-8.9	-58.4	-13.0	-45.4
2	173.56	-59.5	-69.0	2.1	-66.9	-13.0	-53.9
3	288.02	-55.4	-63.9	5.2	-58.7	-13.0	-45.7
4	392.78	-65.3	-71.5	5.2	-66.3	-13.0	-53.3
5	662.44	-71.3	-74.7	4.9	-69.8	-13.0	-56.8
6	937.92	-70.2	-67.0	3.9	-63.1	-13.0	-50.1

Remarks:

1. EIRP (dBm) = S.G Value (dBm) + Correction Factor (dB).
2. Correction Factor (dB) = Substitution Antenna Gain (dB) + Cable Loss (dB).

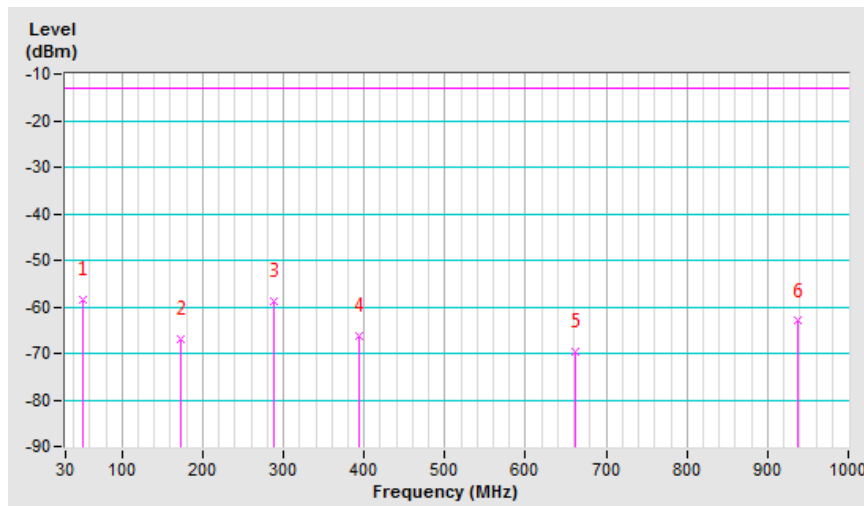

Mode	TX channel 25 (1851.25MHz)	Frequency Range	Below 1000 MHz
Environmental Conditions	25deg. C, 71%RH	Input Power	120Vac, 60Hz
Tested By	Noah Chang		

Antenna Polarity & Test Distance: Vertical at 3 M							
No.	Freq. (MHz)	Reading (dBm)	S.G Power Value (dBm)	Correction Factor (dB)	EIRP (dBm)	Limit (dBm)	Margin (dB)
1	47.46	-46.2	-42.5	-9.7	-52.2	-13.0	-39.2
2	167.74	-61.0	-62.3	1.3	-61.0	-13.0	-48.0
3	233.70	-58.4	-63.8	5.4	-58.4	-13.0	-45.4
4	524.70	-64.2	-68.9	4.8	-64.1	-13.0	-51.1
5	670.20	-72.6	-72.5	5.0	-67.5	-13.0	-54.5
6	889.42	-72.7	-69.8	3.9	-65.9	-13.0	-52.9

Remarks:

1. EIRP (dBm) = S.G Value (dBm) + Correction Factor (dB).
2. Correction Factor (dB) = Substitution Antenna Gain (dB) + Cable Loss (dB).

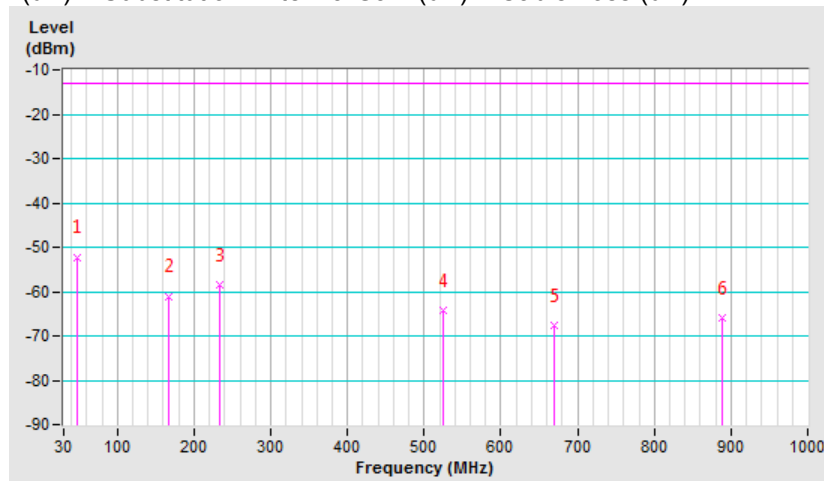

WCDMA Band 2

Mode	TX channel 9262 (1852.4MHz)	Frequency Range	Below 1000 MHz
Environmental Conditions	25deg. C, 71%RH	Input Power	120Vac, 60Hz
Tested By	Noah Chang		

Antenna Polarity & Test Distance: Horizontal at 3 M							
No.	Freq. (MHz)	Reading (dBm)	S.G Power Value (dBm)	Correction Factor (dB)	EIRP (dBm)	Limit (dBm)	Margin (dB)
1	47.46	-55.90	-45.10	-9.70	-54.80	-13.00	-41.80
2	113.42	-55.60	-63.50	0.30	-63.20	-13.00	-50.20
3	202.66	-52.10	-66.10	5.40	-60.70	-13.00	-47.70
4	419.94	-65.10	-71.50	5.20	-66.30	-13.00	-53.30
5	728.40	-70.70	-72.50	4.90	-67.60	-13.00	-54.60
6	935.98	-58.10	-55.00	3.90	-51.10	-13.00	-38.10

Remarks:

1. EIRP (dBm) = S.G Value (dBm) + Correction Factor (dB).
2. Correction Factor (dB) = Substitution Antenna Gain (dB) + Cable Loss (dB).

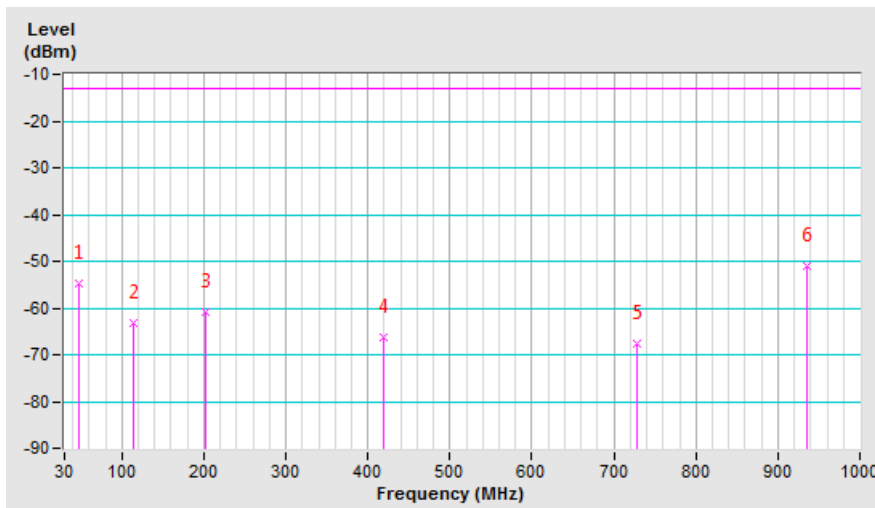

Mode	TX channel 9262 (1852.4MHz)	Frequency Range	Below 1000 MHz
Environmental Conditions	25deg. C, 71%RH	Input Power	120Vac, 60Hz
Tested By	Noah Chang		

Antenna Polarity & Test Distance: Vertical at 3 M							
No.	Freq. (MHz)	Reading (dBm)	S.G Power Value (dBm)	Correction Factor (dB)	EIRP (dBm)	Limit (dBm)	Margin (dB)
1	47.46	-45.03	-40.87	-10.16	-51.03	-13.00	-38.03
2	235.64	-57.58	-62.68	5.42	-57.26	-13.00	-44.26
3	272.50	-64.08	-66.29	5.28	-61.01	-13.00	-48.01
4	542.16	-64.47	-68.14	4.68	-63.46	-13.00	-50.46
5	819.58	-70.16	-67.74	3.97	-63.77	-13.00	-50.77
6	934.04	-55.11	-50.35	3.92	-46.43	-13.00	-33.43

Remarks:

1. EIRP (dBm) = S.G Value (dBm) + Correction Factor (dB).
2. Correction Factor (dB) = Substitution Antenna Gain (dB) + Cable Loss (dB).

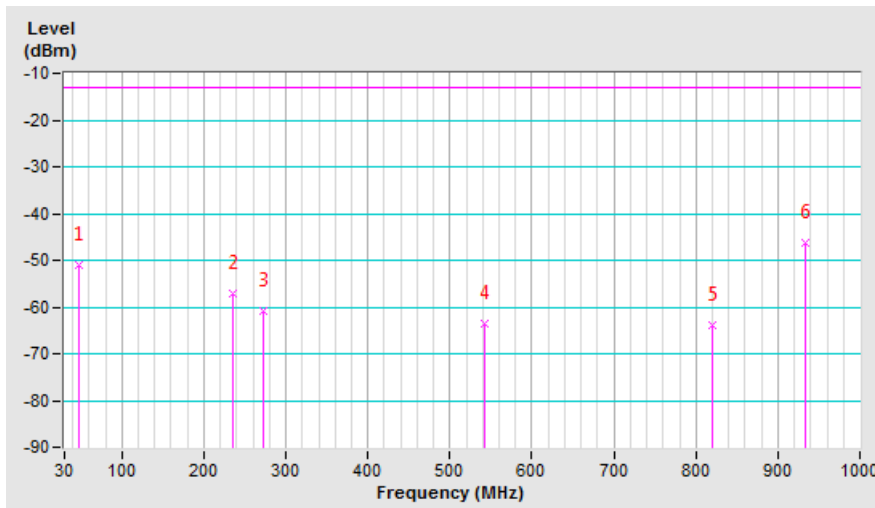

LTE Band 2, Channel Bandwidth: 1.4MHz

Mode	TX channel 18607 (1850.70MHz)	Frequency Range	Below 1000 MHz
Environmental Conditions	25deg. C, 71%RH	Input Power	120Vac, 60Hz
Tested By	Noah Chang		

Antenna Polarity & Test Distance: Horizontal at 3 M

No.	Freq. (MHz)	Reading (dBm)	S.G Power Value (dBm)	Correction Factor (dB)	EIRP (dBm)	Limit (dBm)	Margin (dB)
1	47.46	-54.10	-42.79	-10.16	-52.95	-13.00	-39.95
2	169.68	-60.87	-69.08	1.61	-67.47	-13.00	-54.47
3	200.72	-51.70	-65.88	5.47	-60.41	-13.00	-47.41
4	289.96	-55.62	-64.02	5.18	-58.84	-13.00	-45.84
5	747.80	-61.46	-62.53	4.65	-57.88	-13.00	-44.88
6	935.98	-71.60	-68.49	3.92	-64.57	-13.00	-51.57

Remarks:

1. EIRP (dBm) = S.G Value (dBm) + Correction Factor (dB).
2. Correction Factor (dB) = Substitution Antenna Gain (dB) + Cable Loss (dB).

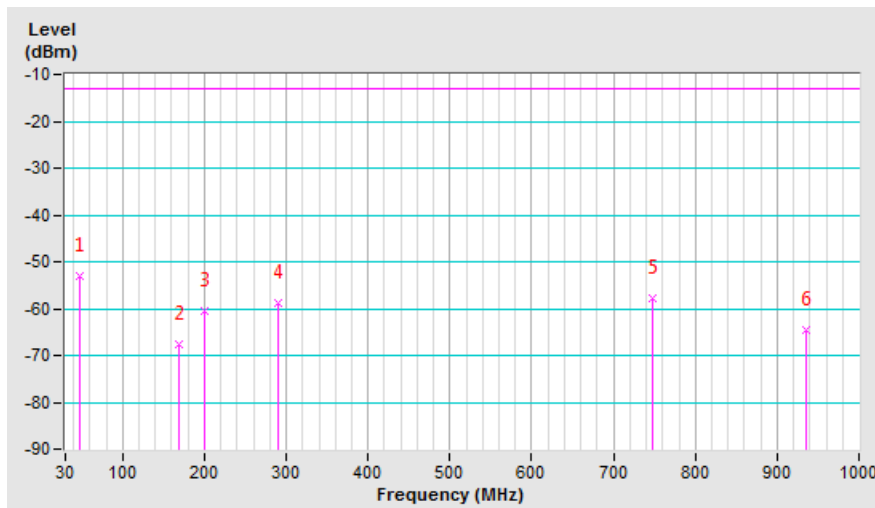

Mode	TX channel 18607 (1850.70MHz)	Frequency Range	Below 1000 MHz
Environmental Conditions	25deg. C, 71%RH	Input Power	120Vac, 60Hz
Tested By	Noah Chang		

Antenna Polarity & Test Distance: Vertical at 3 M							
No.	Freq. (MHz)	Reading (dBm)	S.G Power Value (dBm)	Correction Factor (dB)	EIRP (dBm)	Limit (dBm)	Margin (dB)
1	47.46	-44.78	-40.62	-10.16	-50.78	-13.00	-37.78
2	235.64	-58.72	-63.82	5.42	-58.40	-13.00	-45.40
3	538.28	-65.63	-69.59	4.71	-64.88	-13.00	-51.88
4	563.50	-66.69	-69.51	4.59	-64.92	-13.00	-51.92
5	790.48	-71.44	-69.31	4.15	-65.16	-13.00	-52.16
6	937.92	-70.26	-65.38	3.92	-61.46	-13.00	-48.46

Remarks:

1. EIRP (dBm) = S.G Value (dBm) + Correction Factor (dB).
2. Correction Factor (dB) = Substitution Antenna Gain (dB) + Cable Loss (dB).

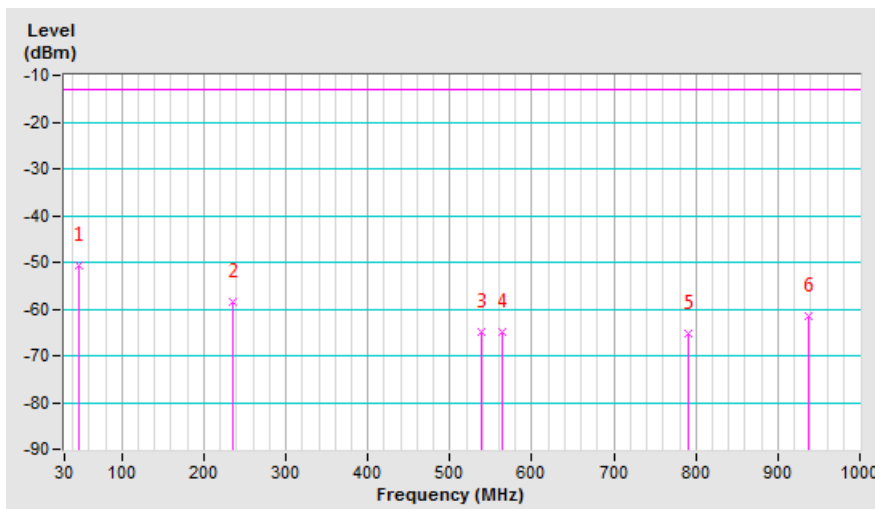

LTE Band 2, Channel Bandwidth: 3MHz

Mode	TX channel 18615 (1851.50MHz)	Frequency Range	Below 1000 MHz
Environmental Conditions	25deg. C, 71%RH	Input Power	120Vac, 60Hz
Tested By	Noah Chang		

Antenna Polarity & Test Distance: Horizontal at 3 M							
No.	Freq. (MHz)	Reading (dBm)	S.G Power Value (dBm)	Correction Factor (dB)	EIRP (dBm)	Limit (dBm)	Margin (dB)
1	47.46	-53.37	-42.06	-10.16	-52.22	-13.00	-39.22
2	284.14	-55.05	-63.68	5.21	-58.47	-13.00	-45.47
3	412.18	-60.70	-66.85	5.24	-61.61	-13.00	-48.61
4	522.76	-64.55	-70.20	4.78	-65.42	-13.00	-52.42
5	747.80	-59.60	-60.67	4.65	-56.02	-13.00	-43.02
6	870.02	-69.21	-67.21	3.95	-63.26	-13.00	-50.26

Remarks:

1. EIRP (dBm) = S.G Value (dBm) + Correction Factor (dB).
2. Correction Factor (dB) = Substitution Antenna Gain (dB) + Cable Loss (dB).

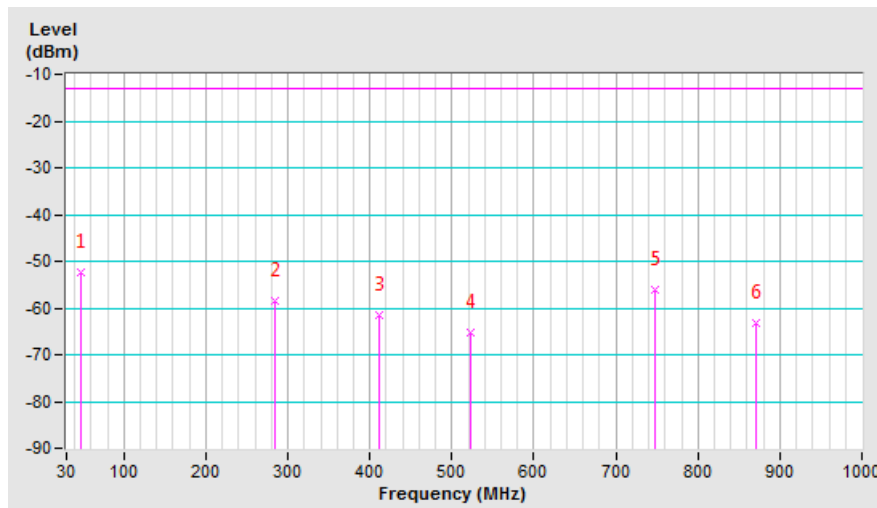

Mode	TX channel 18615 (1851.50MHz)	Frequency Range	Below 1000 MHz
Environmental Conditions	25deg. C, 71%RH	Input Power	120Vac, 60Hz
Tested By	Noah Chang		

Antenna Polarity & Test Distance: Vertical at 3 M							
No.	Freq. (MHz)	Reading (dBm)	S.G Power Value (dBm)	Correction Factor (dB)	EIRP (dBm)	Limit (dBm)	Margin (dB)
1	49.40	-44.71	-41.04	-9.85	-50.89	-13.00	-37.89
2	237.58	-56.85	-62.12	5.42	-56.70	-13.00	-43.70
3	443.22	-64.00	-70.35	5.10	-65.25	-13.00	-52.25
4	555.74	-65.33	-68.70	4.62	-64.08	-13.00	-51.08
5	747.80	-64.63	-63.63	4.65	-58.98	-13.00	-45.98
6	937.92	-63.90	-59.02	3.92	-55.10	-13.00	-42.10

Remarks:

1. EIRP (dBm) = S.G Value (dBm) + Correction Factor (dB).
2. Correction Factor (dB) = Substitution Antenna Gain (dB) + Cable Loss (dB).

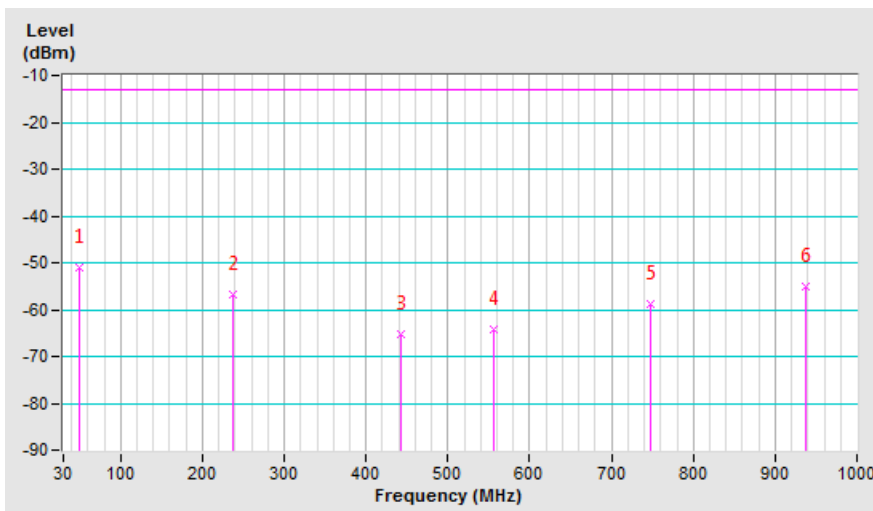

LTE Band 2, Channel Bandwidth: 5MHz

Mode	TX channel 18625 (1852.50MHz)	Frequency Range	Below 1000 MHz
Environmental Conditions	25deg. C, 71%RH	Input Power	120Vac, 60Hz
Tested By	Noah Chang		

Antenna Polarity & Test Distance: Horizontal at 3 M							
No.	Freq. (MHz)	Reading (dBm)	S.G Power Value (dBm)	Correction Factor (dB)	EIRP (dBm)	Limit (dBm)	Margin (dB)
1	45.52	-54.58	-43.25	-9.97	-53.22	-13.00	-40.22
2	66.86	-53.56	-53.76	-5.82	-59.58	-13.00	-46.58
3	284.14	-54.34	-62.97	5.21	-57.76	-13.00	-44.76
4	396.66	-63.67	-70.39	5.27	-65.12	-13.00	-52.12
5	633.34	-69.65	-73.30	4.70	-68.60	-13.00	-55.60
6	934.04	-63.17	-59.99	3.92	-56.07	-13.00	-43.07

Remarks:

1. EIRP (dBm) = S.G Value (dBm) + Correction Factor (dB).
2. Correction Factor (dB) = Substitution Antenna Gain (dB) + Cable Loss (dB).

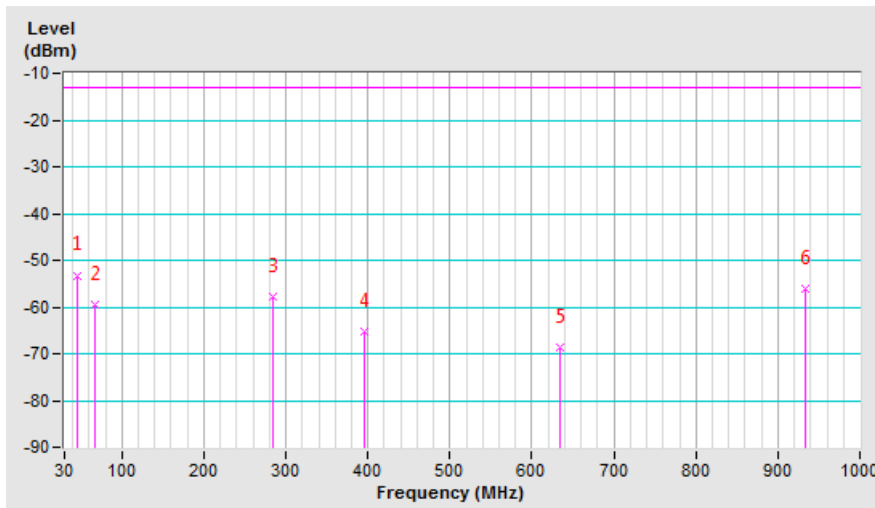

Mode	TX channel 18625 (1852.50MHz)	Frequency Range	Below 1000 MHz
Environmental Conditions	25deg. C, 71%RH	Input Power	120Vac, 60Hz
Tested By	Noah Chang		

Antenna Polarity & Test Distance: Vertical at 3 M							
No.	Freq. (MHz)	Reading (dBm)	S.G Power Value (dBm)	Correction Factor (dB)	EIRP (dBm)	Limit (dBm)	Margin (dB)
1	47.46	-44.92	-40.76	-10.16	-50.92	-13.00	-37.92
2	165.80	-59.14	-60.49	1.12	-59.37	-13.00	-46.37
3	231.76	-57.83	-63.71	5.42	-58.29	-13.00	-45.29
4	272.50	-64.52	-66.73	5.28	-61.45	-13.00	-48.45
5	542.16	-65.25	-68.92	4.68	-64.24	-13.00	-51.24
6	937.92	-68.40	-63.52	3.92	-59.60	-13.00	-46.60

Remarks:

1. EIRP (dBm) = S.G Value (dBm) + Correction Factor (dB).
2. Correction Factor (dB) = Substitution Antenna Gain (dB) + Cable Loss (dB).

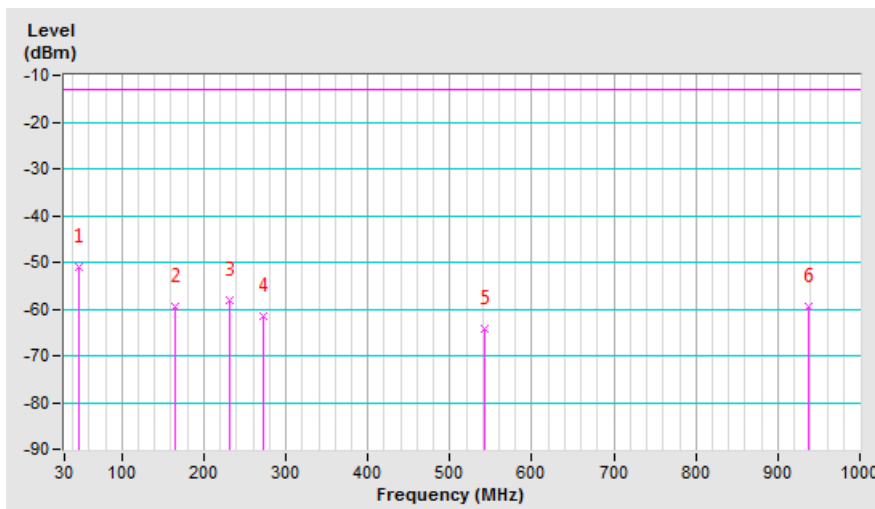

LTE Band 2, Channel Bandwidth: 10MHz

Mode	TX channel 18650 (1855.00MHz)	Frequency Range	Below 1000 MHz
Environmental Conditions	25deg. C, 71%RH	Input Power	120Vac, 60Hz
Tested By	Noah Chang		

Antenna Polarity & Test Distance: Horizontal at 3 M							
No.	Freq. (MHz)	Reading (dBm)	S.G Power Value (dBm)	Correction Factor (dB)	EIRP (dBm)	Limit (dBm)	Margin (dB)
1	45.52	-54.10	-42.77	-9.97	-52.74	-13.00	-39.74
2	161.92	-62.07	-68.49	0.63	-67.86	-13.00	-54.86
3	249.22	-53.31	-65.43	5.40	-60.03	-13.00	-47.03
4	284.14	-55.87	-64.50	5.21	-59.29	-13.00	-46.29
5	396.66	-63.10	-69.82	5.27	-64.55	-13.00	-51.55
6	937.92	-67.94	-64.74	3.92	-60.82	-13.00	-47.82

Remarks:

1. EIRP (dBm) = S.G Value (dBm) + Correction Factor (dB).
2. Correction Factor (dB) = Substitution Antenna Gain (dB) + Cable Loss (dB).

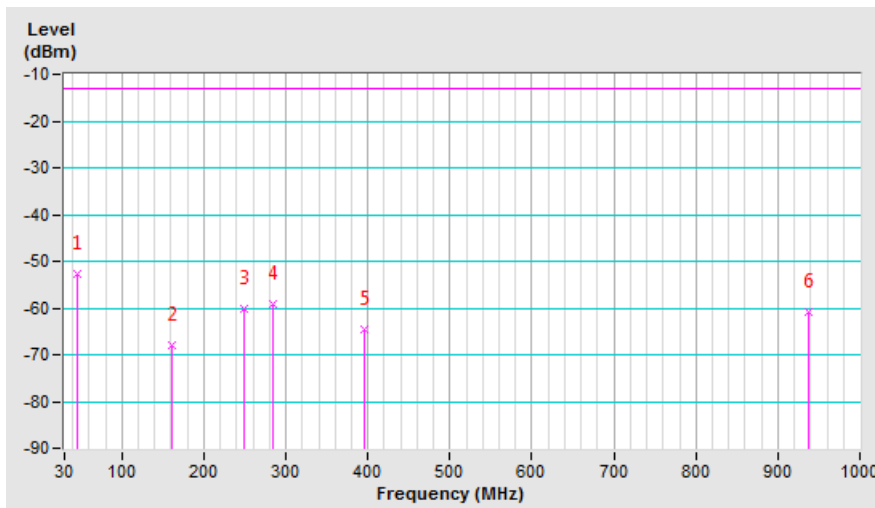

Mode	TX channel 18650 (1855.00MHz)	Frequency Range	Below 1000 MHz
Environmental Conditions	25deg. C, 71%RH	Input Power	120Vac, 60Hz
Tested By	Noah Chang		

Antenna Polarity & Test Distance: Vertical at 3 M							
No.	Freq. (MHz)	Reading (dBm)	S.G Power Value (dBm)	Correction Factor (dB)	EIRP (dBm)	Limit (dBm)	Margin (dB)
1	47.46	-44.44	-40.28	-10.16	-50.44	-13.00	-37.44
2	171.62	-59.52	-61.01	1.86	-59.15	-13.00	-46.15
3	235.64	-58.06	-63.16	5.42	-57.74	-13.00	-44.74
4	272.50	-65.09	-67.30	5.28	-62.02	-13.00	-49.02
5	540.22	-64.80	-68.62	4.70	-63.92	-13.00	-50.92
6	937.92	-68.68	-63.80	3.92	-59.88	-13.00	-46.88

Remarks:

1. EIRP (dBm) = S.G Value (dBm) + Correction Factor (dB).
2. Correction Factor (dB) = Substitution Antenna Gain (dB) + Cable Loss (dB).

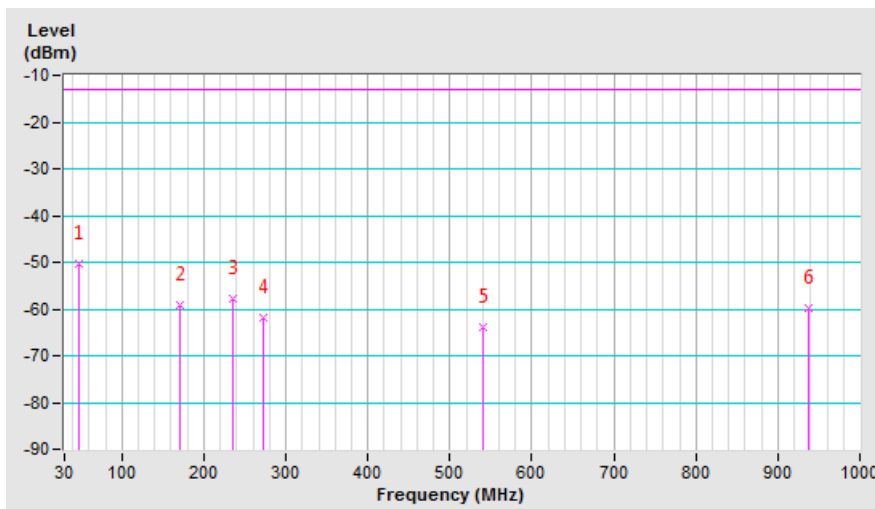

LTE Band 2, Channel Bandwidth: 15MHz

Mode	TX channel 18675 (1857.50MHz)	Frequency Range	Below 1000 MHz
Environmental Conditions	25deg. C, 71%RH	Input Power	120Vac, 60Hz
Tested By	Noah Chang		

Antenna Polarity & Test Distance: Horizontal at 3 M							
No.	Freq. (MHz)	Reading (dBm)	S.G Power Value (dBm)	Correction Factor (dB)	EIRP (dBm)	Limit (dBm)	Margin (dB)
1	47.46	-53.88	-42.57	-10.16	-52.73	-13.00	-39.73
2	198.78	-52.75	-66.91	5.31	-61.60	-13.00	-48.60
3	282.20	-54.30	-63.50	5.22	-58.28	-13.00	-45.28
4	414.12	-64.55	-70.71	5.23	-65.48	-13.00	-52.48
5	788.54	-70.20	-68.99	4.17	-64.82	-13.00	-51.82
6	937.92	-66.48	-63.28	3.92	-59.36	-13.00	-46.36

Remarks:

1. EIRP (dBm) = S.G Value (dBm) + Correction Factor (dB).
2. Correction Factor (dB) = Substitution Antenna Gain (dB) + Cable Loss (dB).

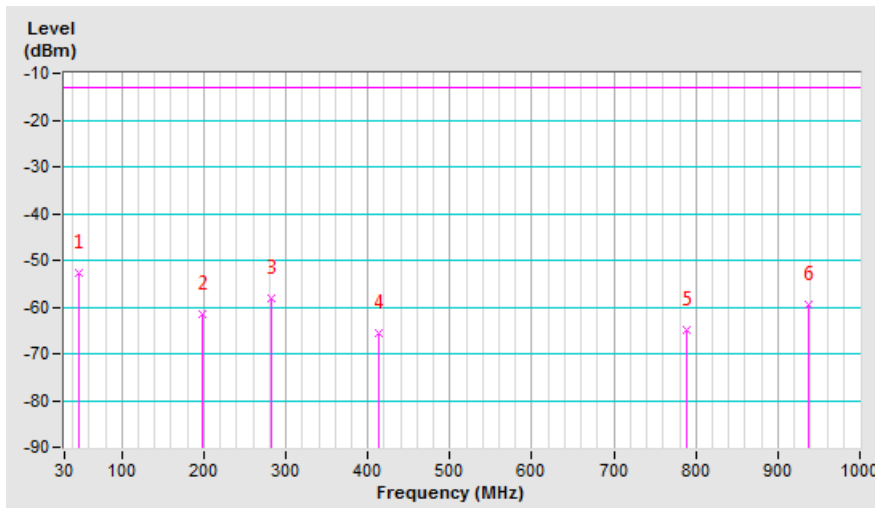

Mode	TX channel 18675 (1857.50MHz)	Frequency Range	Below 1000 MHz
Environmental Conditions	25deg. C, 71%RH	Input Power	120Vac, 60Hz
Tested By	Noah Chang		

Antenna Polarity & Test Distance: Vertical at 3 M							
No.	Freq. (MHz)	Reading (dBm)	S.G Power Value (dBm)	Correction Factor (dB)	EIRP (dBm)	Limit (dBm)	Margin (dB)
1	175.50	-58.83	-61.65	2.34	-59.31	-13.00	-46.31
2	247.28	-56.40	-61.51	5.41	-56.10	-13.00	-43.10
3	542.16	-61.53	-65.20	4.68	-60.52	-13.00	-47.52
4	699.30	-68.13	-68.72	5.24	-63.48	-13.00	-50.48
5	773.02	-70.30	-68.36	4.35	-64.01	-13.00	-51.01
6	932.10	-66.50	-61.91	3.91	-58.00	-13.00	-45.00

Remarks:

1. EIRP (dBm) = S.G Value (dBm) + Correction Factor (dB).
2. Correction Factor (dB) = Substitution Antenna Gain (dB) + Cable Loss (dB).

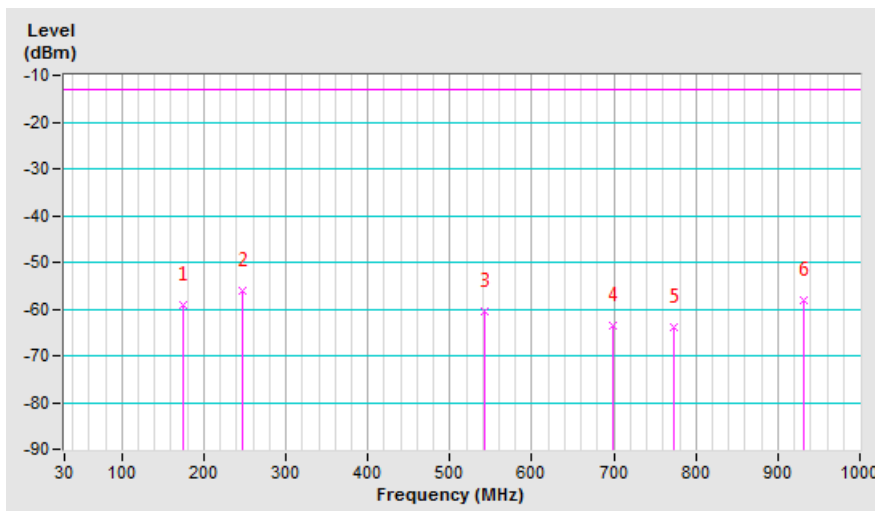

LTE Band 2, Channel Bandwidth: 20MHz

Mode	TX channel 18700 (1860.00MHz)	Frequency Range	Below 1000 MHz
Environmental Conditions	25deg. C, 71%RH	Input Power	120Vac, 60Hz
Tested By	Noah Chang		

Antenna Polarity & Test Distance: Horizontal at 3 M							
No.	Freq. (MHz)	Reading (dBm)	S.G Power Value (dBm)	Correction Factor (dB)	EIRP (dBm)	Limit (dBm)	Margin (dB)
1	47.46	-55.16	-43.85	-10.16	-54.01	-13.00	-41.01
2	107.60	-61.07	-69.31	0.58	-68.73	-13.00	-55.73
3	282.20	-54.65	-63.85	5.22	-58.63	-13.00	-45.63
4	414.12	-65.28	-71.44	5.23	-66.21	-13.00	-53.21
5	596.48	-68.47	-72.57	4.45	-68.12	-13.00	-55.12
6	932.10	-67.31	-64.17	3.91	-60.26	-13.00	-47.26

Remarks:

1. EIRP (dBm) = S.G Value (dBm) + Correction Factor (dB).
2. Correction Factor (dB) = Substitution Antenna Gain (dB) + Cable Loss (dB).

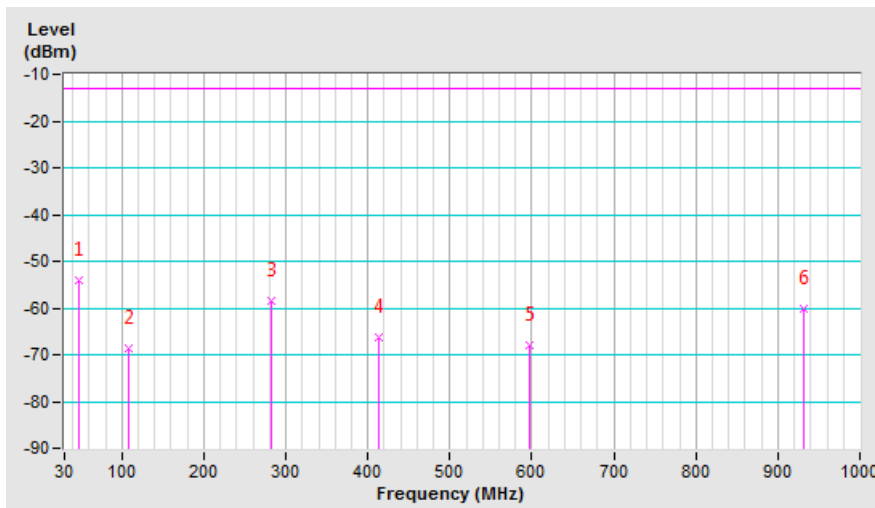

Mode	TX channel 18700 (1860.00MHz)	Frequency Range	Below 1000 MHz
Environmental Conditions	25deg. C, 71%RH	Input Power	120Vac, 60Hz
Tested By	Noah Chang		

Antenna Polarity & Test Distance: Vertical at 3 M							
No.	Freq. (MHz)	Reading (dBm)	S.G Power Value (dBm)	Correction Factor (dB)	EIRP (dBm)	Limit (dBm)	Margin (dB)
1	47.46	-44.88	-40.72	-10.16	-50.88	-13.00	-37.88
2	202.66	-55.80	-63.36	5.46	-57.90	-13.00	-44.90
3	235.64	-56.91	-62.01	5.42	-56.59	-13.00	-43.59
4	421.88	-65.06	-71.95	5.19	-66.76	-13.00	-53.76
5	534.40	-64.98	-69.20	4.73	-64.47	-13.00	-51.47
6	926.28	-70.35	-66.00	3.91	-62.09	-13.00	-49.09

Remarks:

1. EIRP (dBm) = S.G Value (dBm) + Correction Factor (dB).
2. Correction Factor (dB) = Substitution Antenna Gain (dB) + Cable Loss (dB).

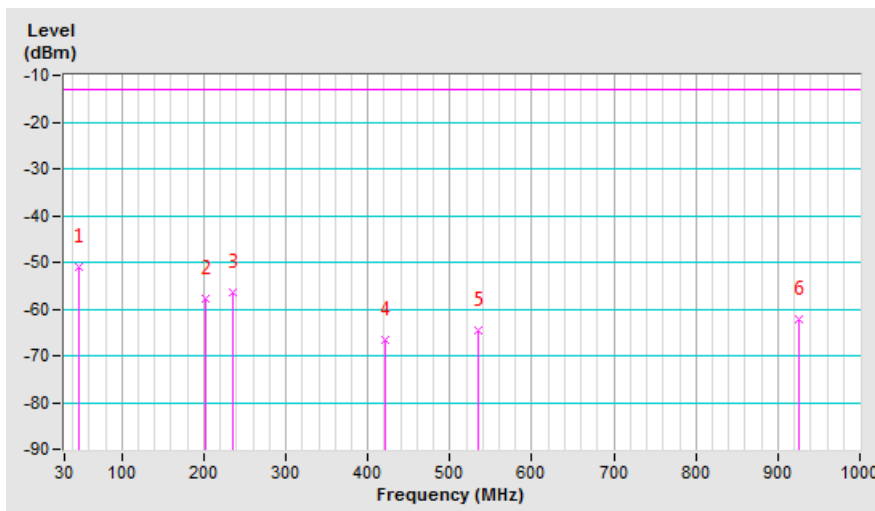

LTE Band 25, Channel Bandwidth: 1.4MHz

Mode	TX channel 26047 (1850.7MHz)	Frequency Range	Below 1000 MHz
Environmental Conditions	25deg. C, 71%RH	Input Power	120Vac, 60Hz
Tested By	Noah Chang		

Antenna Polarity & Test Distance: Horizontal at 3 M							
No.	Freq. (MHz)	Reading (dBm)	S.G Power Value (dBm)	Correction Factor (dB)	EIRP (dBm)	Limit (dBm)	Margin (dB)
1	49.40	-53.19	-43.15	-9.85	-53.00	-13.00	-40.00
2	194.90	-51.83	-65.66	4.82	-60.84	-13.00	-47.84
3	414.12	-63.32	-69.48	5.23	-64.25	-13.00	-51.25
4	672.14	-69.68	-72.99	5.02	-67.97	-13.00	-54.97
5	821.52	-70.83	-68.99	3.97	-65.02	-13.00	-52.02
6	877.78	-70.71	-68.48	3.94	-64.54	-13.00	-51.54

Remarks:

1. EIRP (dBm) = S.G Value (dBm) + Correction Factor (dB).
2. Correction Factor (dB) = Substitution Antenna Gain (dB) + Cable Loss (dB).

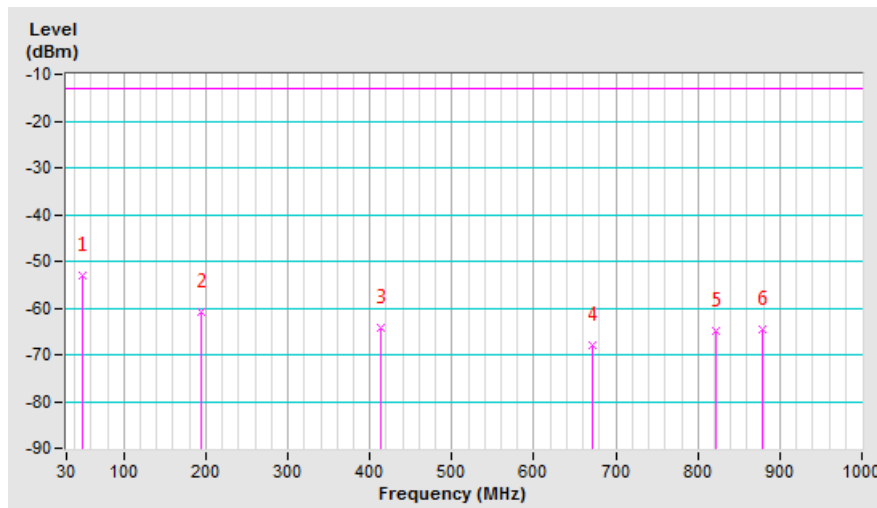

Mode	TX channel 26047 (1850.7MHz)	Frequency Range	Below 1000 MHz
Environmental Conditions	25deg. C, 71%RH	Input Power	120Vac, 60Hz
Tested By	Noah Chang		

Antenna Polarity & Test Distance: Vertical at 3 M							
No.	Freq. (MHz)	Reading (dBm)	S.G Power Value (dBm)	Correction Factor (dB)	EIRP (dBm)	Limit (dBm)	Margin (dB)
1	47.46	-43.31	-39.15	-10.16	-49.31	-13.00	-36.31
2	181.32	-51.70	-56.34	3.08	-53.26	-13.00	-40.26
3	245.34	-54.25	-59.92	5.41	-54.51	-13.00	-41.51
4	385.02	-69.83	-76.35	5.25	-71.10	-13.00	-58.10
5	487.84	-65.30	-71.41	4.92	-66.49	-13.00	-53.49
6	613.94	-69.59	-69.27	4.53	-64.74	-13.00	-51.74

Remarks:

1. EIRP (dBm) = S.G Value (dBm) + Correction Factor (dB).
2. Correction Factor (dB) = Substitution Antenna Gain (dB) + Cable Loss (dB).

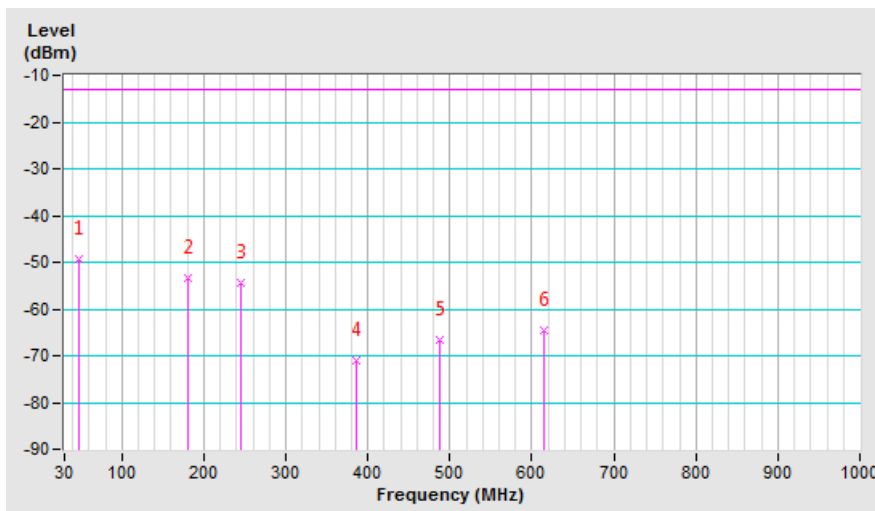

LTE Band 25, Channel Bandwidth: 3MHz

Mode	TX channel 26055 (1851.5MHz)	Frequency Range	Below 1000 MHz
Environmental Conditions	25deg. C, 71%RH	Input Power	120Vac, 60Hz
Tested By	Noah Chang		

Antenna Polarity & Test Distance: Horizontal at 3 M							
No.	Freq. (MHz)	Reading (dBm)	S.G Power Value (dBm)	Correction Factor (dB)	EIRP (dBm)	Limit (dBm)	Margin (dB)
1	47.46	-50.91	-39.60	-10.16	-49.76	-13.00	-36.76
2	173.56	-52.49	-61.97	2.10	-59.87	-13.00	-46.87
3	278.32	-57.40	-67.51	5.24	-62.27	-13.00	-49.27
4	398.60	-63.17	-69.90	5.27	-64.63	-13.00	-51.63
5	848.68	-70.95	-69.27	3.97	-65.30	-13.00	-52.30
6	934.04	-67.79	-64.61	3.92	-60.69	-13.00	-47.69

Remarks:

1. EIRP (dBm) = S.G Value (dBm) + Correction Factor (dB).
2. Correction Factor (dB) = Substitution Antenna Gain (dB) + Cable Loss (dB).

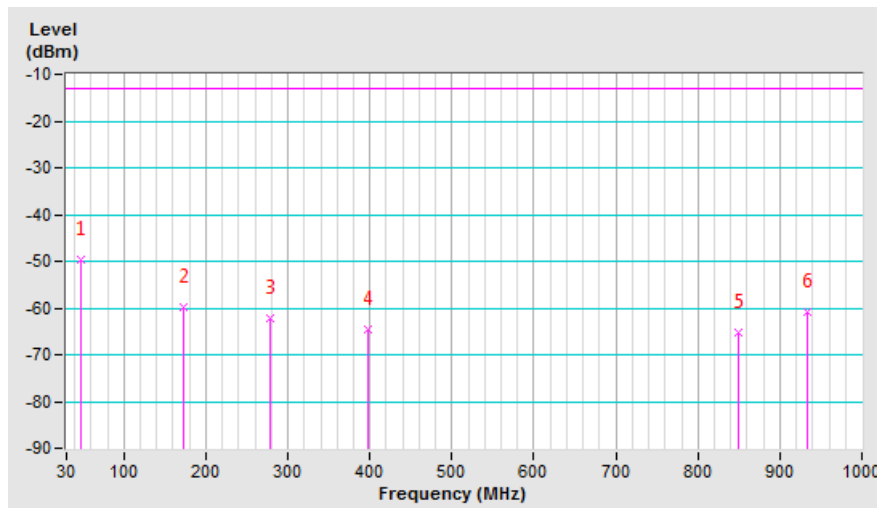

Mode	TX channel 26055 (1851.5MHz)	Frequency Range	Below 1000 MHz
Environmental Conditions	25deg. C, 71%RH	Input Power	120Vac, 60Hz
Tested By	Noah Chang		

Antenna Polarity & Test Distance: Vertical at 3 M							
No.	Freq. (MHz)	Reading (dBm)	S.G Power Value (dBm)	Correction Factor (dB)	EIRP (dBm)	Limit (dBm)	Margin (dB)
1	47.46	-43.28	-39.12	-10.16	-49.28	-13.00	-36.28
2	175.50	-51.44	-54.26	2.34	-51.92	-13.00	-38.92
3	247.28	-54.22	-59.33	5.41	-53.92	-13.00	-40.92
4	398.60	-64.24	-70.25	5.27	-64.98	-13.00	-51.98
5	536.34	-60.38	-64.46	4.71	-59.75	-13.00	-46.75
6	934.04	-66.59	-61.83	3.92	-57.91	-13.00	-44.91

Remarks:

1. EIRP (dBm) = S.G Value (dBm) + Correction Factor (dB).
2. Correction Factor (dB) = Substitution Antenna Gain (dB) + Cable Loss (dB).

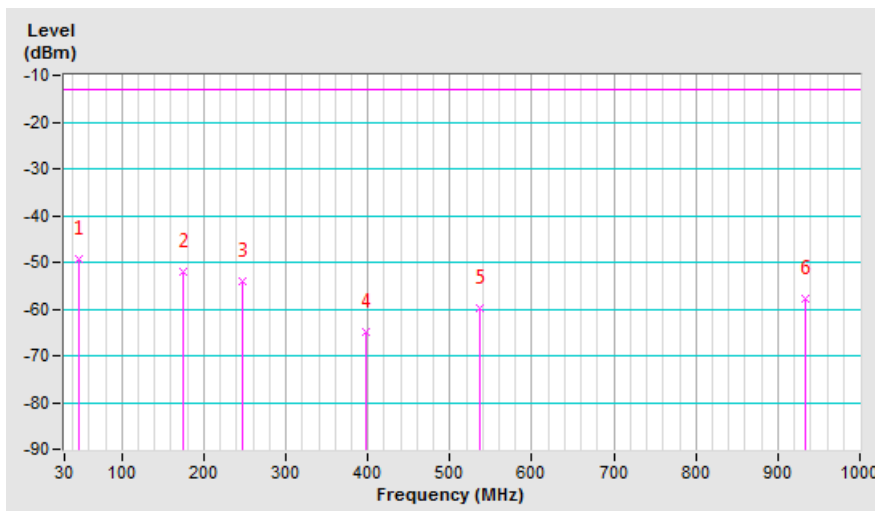

LTE Band 25, Channel Bandwidth: 5MHz

Mode	TX channel 26065 (1852.5MHz)	Frequency Range	Below 1000 MHz
Environmental Conditions	25deg. C, 71%RH	Input Power	120Vac, 60Hz
Tested By	Noah Chang		

Antenna Polarity & Test Distance: Horizontal at 3 M							
No.	Freq. (MHz)	Reading (dBm)	S.G Power Value (dBm)	Correction Factor (dB)	EIRP (dBm)	Limit (dBm)	Margin (dB)
1	47.46	-51.81	-40.50	-10.16	-50.66	-13.00	-37.66
2	177.44	-52.57	-63.01	2.59	-60.42	-13.00	-47.42
3	247.28	-53.72	-66.54	5.41	-61.13	-13.00	-48.13
4	379.20	-66.77	-73.14	5.25	-67.89	-13.00	-54.89
5	549.92	-67.41	-72.51	4.63	-67.88	-13.00	-54.88
6	972.84	-72.59	-68.92	3.91	-65.01	-13.00	-52.01

Remarks:

1. EIRP (dBm) = S.G Value (dBm) + Correction Factor (dB).
2. Correction Factor (dB) = Substitution Antenna Gain (dB) + Cable Loss (dB).

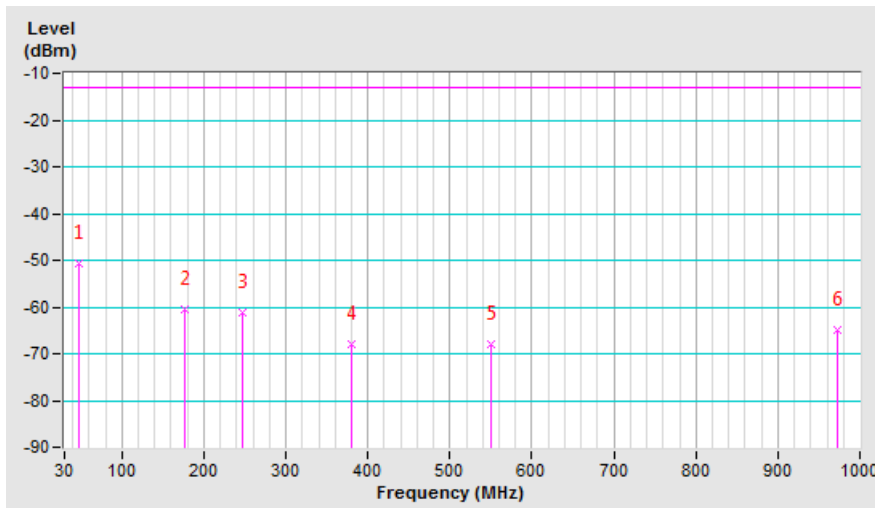

Mode	TX channel 26065 (1852.5MHz)	Frequency Range	Below 1000 MHz
Environmental Conditions	25deg. C, 71%RH	Input Power	120Vac, 60Hz
Tested By	Noah Chang		

Antenna Polarity & Test Distance: Vertical at 3 M							
No.	Freq. (MHz)	Reading (dBm)	S.G Power Value (dBm)	Correction Factor (dB)	EIRP (dBm)	Limit (dBm)	Margin (dB)
1	47.46	-43.17	-39.01	-10.16	-49.17	-13.00	-36.17
2	175.50	-51.82	-54.64	2.34	-52.30	-13.00	-39.30
3	251.16	-60.49	-65.52	5.40	-60.12	-13.00	-47.12
4	456.80	-62.54	-68.61	5.06	-63.55	-13.00	-50.55
5	534.40	-60.41	-64.63	4.73	-59.90	-13.00	-46.90
6	934.04	-67.77	-63.01	3.92	-59.09	-13.00	-46.09

Remarks:

1. EIRP (dBm) = S.G Value (dBm) + Correction Factor (dB).
2. Correction Factor (dB) = Substitution Antenna Gain (dB) + Cable Loss (dB).

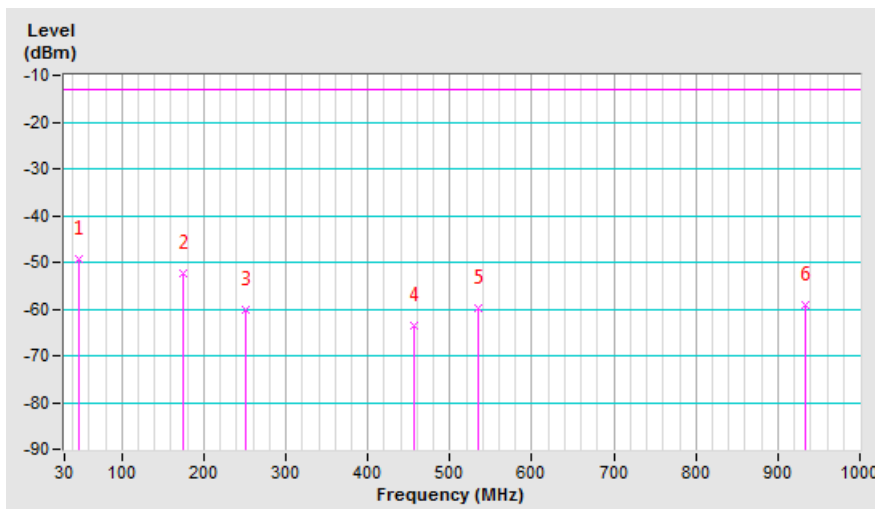

LTE Band 25, Channel Bandwidth: 10MHz

Mode	TX channel 26090 (1855.0MHz)	Frequency Range	Below 1000 MHz
Environmental Conditions	25deg. C, 71%RH	Input Power	120Vac, 60Hz
Tested By	Noah Chang		

Antenna Polarity & Test Distance: Horizontal at 3 M							
No.	Freq. (MHz)	Reading (dBm)	S.G Power Value (dBm)	Correction Factor (dB)	EIRP (dBm)	Limit (dBm)	Margin (dB)
1	47.46	-51.70	-40.39	-10.16	-50.55	-13.00	-37.55
2	173.56	-52.64	-62.12	2.10	-60.02	-13.00	-47.02
3	278.32	-57.02	-67.13	5.24	-61.89	-13.00	-48.89
4	464.56	-63.02	-69.27	5.02	-64.25	-13.00	-51.25
5	621.70	-70.42	-73.99	4.61	-69.38	-13.00	-56.38
6	765.26	-70.76	-70.68	4.45	-66.23	-13.00	-53.23

Remarks:

1. EIRP (dBm) = S.G Value (dBm) + Correction Factor (dB).
2. Correction Factor (dB) = Substitution Antenna Gain (dB) + Cable Loss (dB).

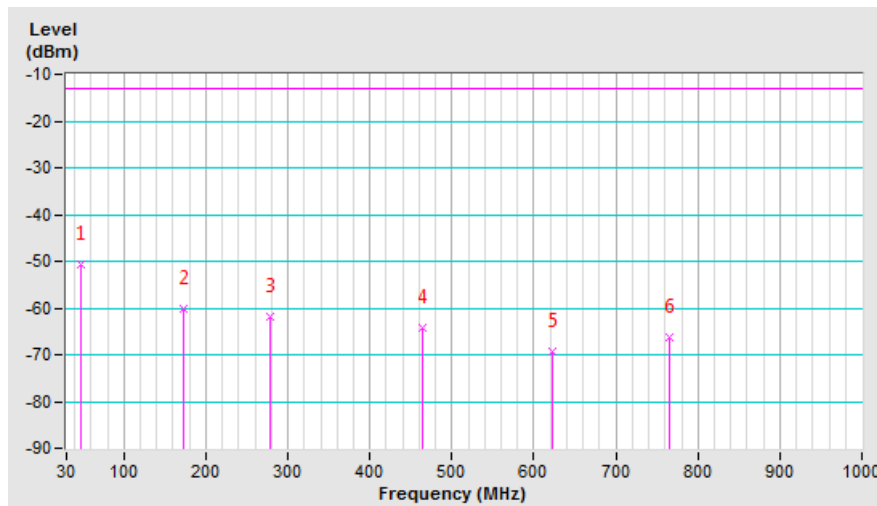

Mode	TX channel 26090 (1855.0MHz)	Frequency Range	Below 1000 MHz
Environmental Conditions	25deg. C, 71%RH	Input Power	120Vac, 60Hz
Tested By	Noah Chang		

Antenna Polarity & Test Distance: Vertical at 3 M							
No.	Freq. (MHz)	Reading (dBm)	S.G Power Value (dBm)	Correction Factor (dB)	EIRP (dBm)	Limit (dBm)	Margin (dB)
1	171.62	-52.91	-54.40	1.86	-52.54	-13.00	-39.54
2	284.14	-67.12	-71.29	5.21	-66.08	-13.00	-53.08
3	418.00	-62.21	-68.91	5.21	-63.70	-13.00	-50.70
4	547.98	-61.10	-64.57	4.65	-59.92	-13.00	-46.92
5	837.04	-71.89	-69.38	3.98	-65.40	-13.00	-52.40
6	937.92	-69.01	-64.13	3.92	-60.21	-13.00	-47.21

Remarks:

1. EIRP (dBm) = S.G Value (dBm) + Correction Factor (dB).
2. Correction Factor (dB) = Substitution Antenna Gain (dB) + Cable Loss (dB).

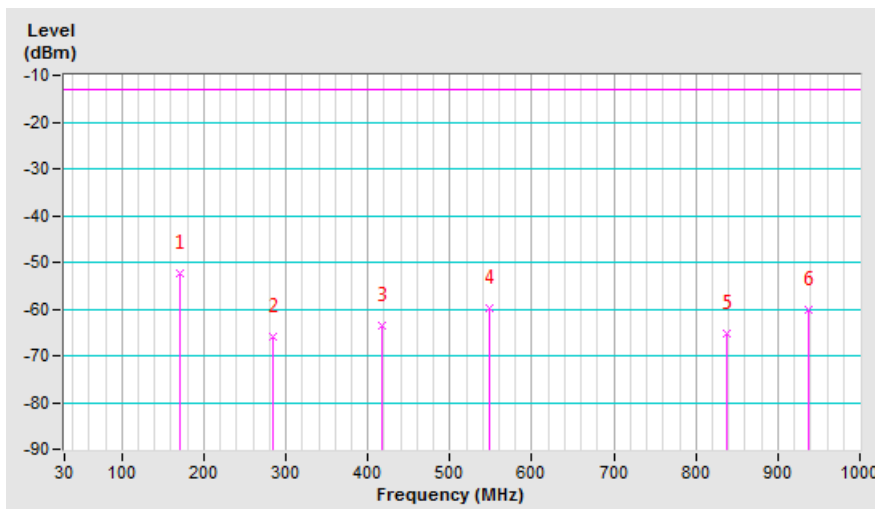

LTE Band 25, Channel Bandwidth: 15MHz

Mode	TX channel 26115 (1857.5MHz)	Frequency Range	Below 1000 MHz
Environmental Conditions	25deg. C, 71%RH	Input Power	120Vac, 60Hz
Tested By	Noah Chang		

Antenna Polarity & Test Distance: Horizontal at 3 M							
No.	Freq. (MHz)	Reading (dBm)	S.G Power Value (dBm)	Correction Factor (dB)	EIRP (dBm)	Limit (dBm)	Margin (dB)
1	169.68	-57.22	-65.43	1.61	-63.82	-13.00	-50.82
2	278.32	-56.92	-67.03	5.24	-61.79	-13.00	-48.79
3	414.12	-63.08	-69.24	5.23	-64.01	-13.00	-51.01
4	526.64	-65.51	-71.04	4.76	-66.28	-13.00	-53.28
5	736.16	-71.17	-72.58	4.81	-67.77	-13.00	-54.77
6	809.88	-71.85	-70.19	4.02	-66.17	-13.00	-53.17

Remarks:

1. EIRP (dBm) = S.G Value (dBm) + Correction Factor (dB).
2. Correction Factor (dB) = Substitution Antenna Gain (dB) + Cable Loss (dB).

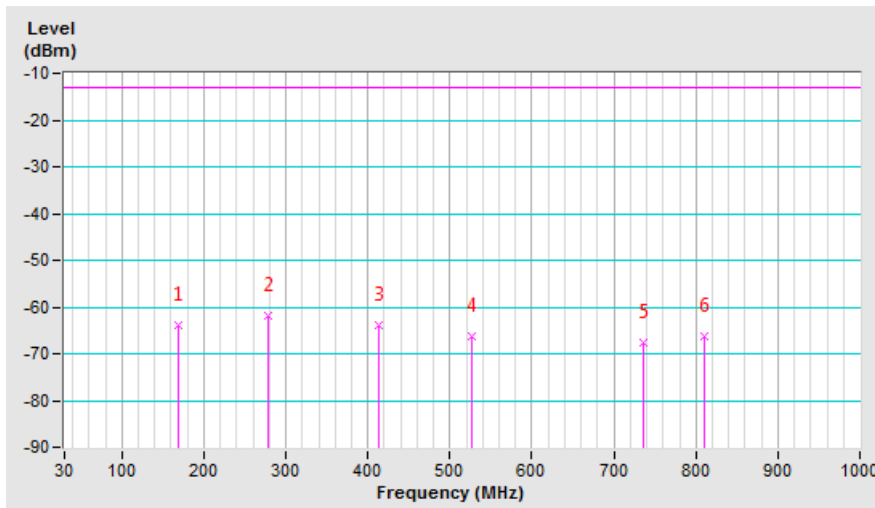

Mode	TX channel 26115 (1857.5MHz)	Frequency Range	Below 1000 MHz
Environmental Conditions	25deg. C, 71%RH	Input Power	120Vac, 60Hz
Tested By	Noah Chang		

Antenna Polarity & Test Distance: Vertical at 3 M							
No.	Freq. (MHz)	Reading (dBm)	S.G Power Value (dBm)	Correction Factor (dB)	EIRP (dBm)	Limit (dBm)	Margin (dB)
1	175.50	-49.84	-52.66	2.34	-50.32	-13.00	-37.32
2	235.64	-54.45	-59.55	5.42	-54.13	-13.00	-41.13
3	406.36	-65.85	-72.20	5.26	-66.94	-13.00	-53.94
4	528.58	-64.96	-69.36	4.74	-64.62	-13.00	-51.62
5	722.58	-70.89	-70.24	4.97	-65.27	-13.00	-52.27
6	934.04	-68.41	-63.65	3.92	-59.73	-13.00	-46.73

Remarks:

1. EIRP (dBm) = S.G Value (dBm) + Correction Factor (dB).
2. Correction Factor (dB) = Substitution Antenna Gain (dB) + Cable Loss (dB).

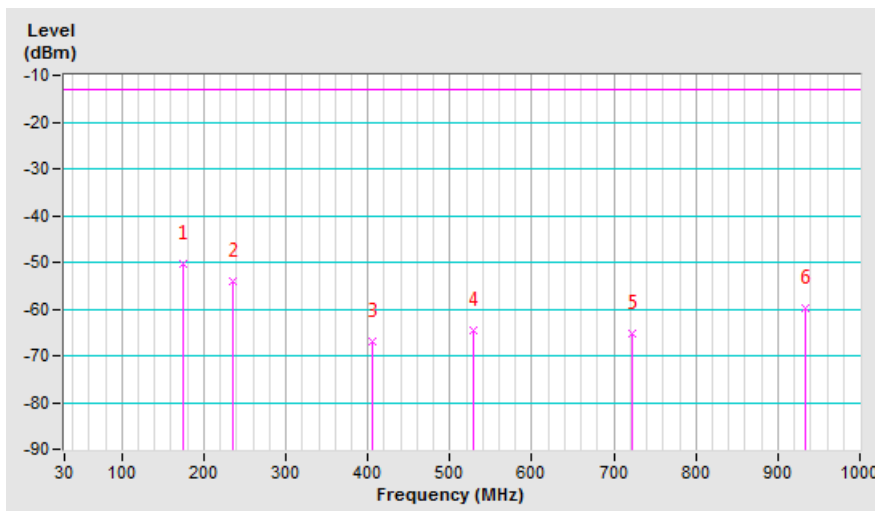

LTE Band 25, Channel Bandwidth: 20MHz

Mode	TX channel 26140 (1860.0MHz)	Frequency Range	Below 1000 MHz
Environmental Conditions	25deg. C, 71%RH	Input Power	120Vac, 60Hz
Tested By	Noah Chang		

Antenna Polarity & Test Distance: Horizontal at 3 M							
No.	Freq. (MHz)	Reading (dBm)	S.G Power Value (dBm)	Correction Factor (dB)	EIRP (dBm)	Limit (dBm)	Margin (dB)
1	152.22	-68.27	-72.51	-0.04	-72.55	-13.00	-59.55
2	249.22	-55.21	-67.33	5.40	-61.93	-13.00	-48.93
3	383.08	-67.61	-73.80	5.25	-68.55	-13.00	-55.55
4	464.56	-64.19	-70.44	5.02	-65.42	-13.00	-52.42
5	656.62	-70.64	-73.99	4.89	-69.10	-13.00	-56.10
6	932.10	-68.72	-65.58	3.91	-61.67	-13.00	-48.67

Remarks:

1. EIRP (dBm) = S.G Value (dBm) + Correction Factor (dB).
2. Correction Factor (dB) = Substitution Antenna Gain (dB) + Cable Loss (dB).

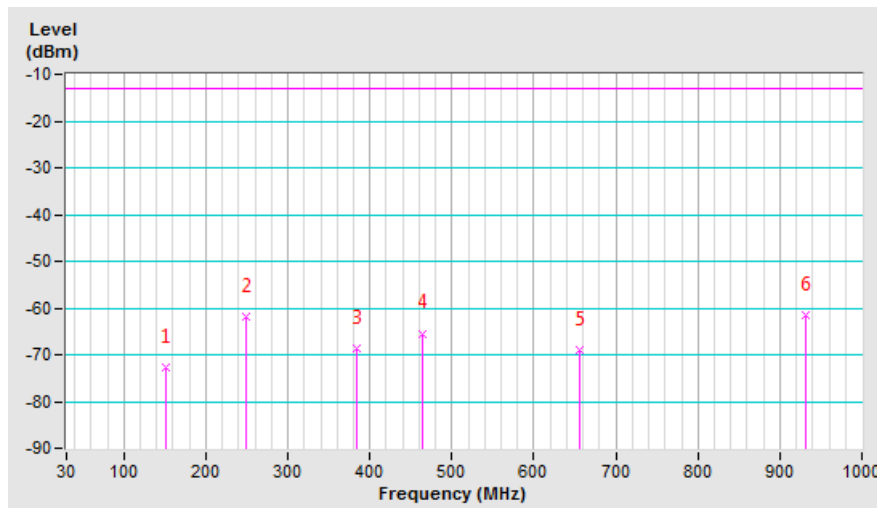

Mode	TX channel 26140 (1860.0MHz)	Frequency Range	Below 1000 MHz
Environmental Conditions	25deg. C, 71%RH	Input Power	120Vac, 60Hz
Tested By	Noah Chang		

Antenna Polarity & Test Distance: Vertical at 3 M							
No.	Freq. (MHz)	Reading (dBm)	S.G Power Value (dBm)	Correction Factor (dB)	EIRP (dBm)	Limit (dBm)	Margin (dB)
1	117.30	-59.73	-66.20	0.18	-66.02	-13.00	-53.02
2	175.50	-50.10	-52.92	2.34	-50.58	-13.00	-37.58
3	243.40	-54.04	-59.67	5.40	-54.27	-13.00	-41.27
4	412.18	-65.31	-72.06	5.24	-66.82	-13.00	-53.82
5	561.56	-65.35	-68.25	4.61	-63.64	-13.00	-50.64
6	932.10	-67.83	-63.24	3.91	-59.33	-13.00	-46.33

Remarks:

1. EIRP (dBm) = S.G Value (dBm) + Correction Factor (dB).
2. Correction Factor (dB) = Substitution Antenna Gain (dB) + Cable Loss (dB).

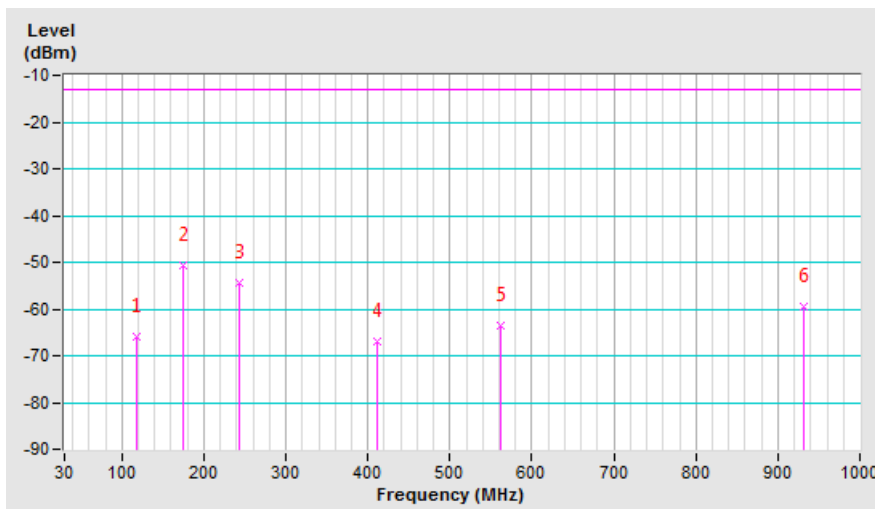

Above 1GHz
PCS 1900

Mode	TX channel 512 (1850.2MHz)	Frequency Range	1GHz ~ 18GHz
Environmental Conditions	25deg. C, 70%RH	Input Power	120Vac, 60Hz
Tested By	Noah Chang		

Antenna Polarity & Test Distance: Horizontal at 3 M							
No.	Freq. (MHz)	Reading (dBm)	S.G Power Value (dBm)	Correction Factor (dB)	EIRP (dBm)	Limit (dBm)	Margin (dB)
1	3700.40	-53.80	-47.70	7.10	-40.60	-13.00	-27.60
Antenna Polarity & Test Distance: Vertical at 3 M							
No.	Freq. (MHz)	Reading (dBm)	S.G Power Value (dBm)	Correction Factor (dB)	EIRP (dBm)	Limit (dBm)	Margin (dB)
1	3700.40	-56.40	-50.30	7.10	-43.20	-13.00	-30.20

Remarks:

1. EIRP (dBm) = S.G Value (dBm) + Correction Factor (dB).
2. Correction Factor (dB) = Substitution Antenna Gain (dB) + Cable Loss (dB).

Mode	TX channel 661 (1880.0MHz)	Frequency Range	1GHz ~ 18GHz
Environmental Conditions	25deg. C, 70%RH	Input Power	120Vac, 60Hz
Tested By	Noah Chang		

Antenna Polarity & Test Distance: Horizontal at 3 M							
No.	Freq. (MHz)	Reading (dBm)	S.G Power Value (dBm)	Correction Factor (dB)	EIRP (dBm)	Limit (dBm)	Margin (dB)
1	3760.00	-53.20	-47.40	7.10	-40.30	-13.00	-27.30
Antenna Polarity & Test Distance: Vertical at 3 M							
No.	Freq. (MHz)	Reading (dBm)	S.G Power Value (dBm)	Correction Factor (dB)	EIRP (dBm)	Limit (dBm)	Margin (dB)
1	3760.00	-56.90	-51.00	7.10	-43.90	-13.00	-30.90

Remarks:

1. EIRP (dBm) = S.G Value (dBm) + Correction Factor (dB).
2. Correction Factor (dB) = Substitution Antenna Gain (dB) + Cable Loss (dB).

Mode	TX channel 810 (1909.8MHz)	Frequency Range	1GHz ~ 18GHz
Environmental Conditions	25deg. C, 70%RH	Input Power	120Vac, 60Hz
Tested By	Noah Chang		

Antenna Polarity & Test Distance: Horizontal at 3 M							
No.	Freq. (MHz)	Reading (dBm)	S.G Power Value (dBm)	Correction Factor (dB)	EIRP (dBm)	Limit (dBm)	Margin (dB)
1	3819.60	-53.00	-47.20	7.10	-40.10	-13.00	-27.10
Antenna Polarity & Test Distance: Vertical at 3 M							
No.	Freq. (MHz)	Reading (dBm)	S.G Power Value (dBm)	Correction Factor (dB)	EIRP (dBm)	Limit (dBm)	Margin (dB)
1	3819.60	-56.60	-50.70	7.10	-43.60	-13.00	-30.60

Remarks:

1. EIRP (dBm) = S.G Value (dBm) + Correction Factor (dB).
2. Correction Factor (dB) = Substitution Antenna Gain (dB) + Cable Loss (dB).

CDMA

Mode	TX channel 25 (1851.25MHz)	Frequency Range	1GHz ~ 18GHz
Environmental Conditions	25deg. C, 70%RH	Input Power	120Vac, 60Hz
Tested By	Noah Chang		

Antenna Polarity & Test Distance: Horizontal at 3 M							
No.	Freq. (MHz)	Reading (dBm)	S.G Power Value (dBm)	Correction Factor (dB)	EIRP (dBm)	Limit (dBm)	Margin (dB)
1	3702.50	-56.5	-50.5	7.1	-43.4	-13.0	-30.4
Antenna Polarity & Test Distance: Vertical at 3 M							
No.	Freq. (MHz)	Reading (dBm)	S.G Power Value (dBm)	Correction Factor (dB)	EIRP (dBm)	Limit (dBm)	Margin (dB)
1	3702.50	-56.1	-49.0	7.1	-41.9	-13.0	-28.9

Remarks:

1. EIRP (dBm) = S.G Value (dBm) + Correction Factor (dB).
2. Correction Factor (dB) = Substitution Antenna Gain (dB) + Cable Loss (dB).

Mode	TX channel 600 (1880.0MHz)	Frequency Range	1GHz ~ 18GHz
Environmental Conditions	25deg. C, 70%RH	Input Power	120Vac, 60Hz
Tested By	Noah Chang		

Antenna Polarity & Test Distance: Horizontal at 3 M							
No.	Freq. (MHz)	Reading (dBm)	S.G Power Value (dBm)	Correction Factor (dB)	EIRP (dBm)	Limit (dBm)	Margin (dB)
1	3760.00	-56.7	-50.2	7.1	-43.1	-13.0	-30.1
Antenna Polarity & Test Distance: Vertical at 3 M							
No.	Freq. (MHz)	Reading (dBm)	S.G Power Value (dBm)	Correction Factor (dB)	EIRP (dBm)	Limit (dBm)	Margin (dB)
1	3760.00	-56.0	-48.6	7.1	-41.5	-13.0	-28.5

Remarks:

1. EIRP (dBm) = S.G Value (dBm) + Correction Factor (dB).
2. Correction Factor (dB) = Substitution Antenna Gain (dB) + Cable Loss (dB).

Mode	TX channel 1175 (1908.75MHz)	Frequency Range	1GHz ~ 18GHz
Environmental Conditions	25deg. C, 70%RH	Input Power	120Vac, 60Hz
Tested By	Noah Chang		

Antenna Polarity & Test Distance: Horizontal at 3 M							
No.	Freq. (MHz)	Reading (dBm)	S.G Power Value (dBm)	Correction Factor (dB)	EIRP (dBm)	Limit (dBm)	Margin (dB)
1	3817.50	-57.7	-51.0	7.1	-43.9	-13.0	-30.9
Antenna Polarity & Test Distance: Vertical at 3 M							
No.	Freq. (MHz)	Reading (dBm)	S.G Power Value (dBm)	Correction Factor (dB)	EIRP (dBm)	Limit (dBm)	Margin (dB)
1	3817.50	-55.9	-48.2	7.1	-41.1	-13.0	-28.1

Remarks:

1. $EIRP (dBm) = S.G \text{ Value (dBm)} + \text{Correction Factor (dB)}$.
2. $\text{Correction Factor (dB)} = \text{Substitution Antenna Gain (dB)} + \text{Cable Loss (dB)}$.

WCDMA Band 2

Mode	TX channel 9262 (1852.4MHz)	Frequency Range	1GHz ~ 18GHz
Environmental Conditions	25deg. C, 70%RH	Input Power	120Vac, 60Hz
Tested By	Noah Chang		

Antenna Polarity & Test Distance: Horizontal at 3 M							
No.	Freq. (MHz)	Reading (dBm)	S.G Power Value (dBm)	Correction Factor (dB)	EIRP (dBm)	Limit (dBm)	Margin (dB)
1	3704.80	-53.20	-47.10	7.10	-40.00	-13.00	-27.00
Antenna Polarity & Test Distance: Vertical at 3 M							
No.	Freq. (MHz)	Reading (dBm)	S.G Power Value (dBm)	Correction Factor (dB)	EIRP (dBm)	Limit (dBm)	Margin (dB)
1	3704.80	-56.60	-50.50	7.10	-43.40	-13.00	-30.40

Remarks:

1. EIRP (dBm) = S.G Value (dBm) + Correction Factor (dB).
2. Correction Factor (dB) = Substitution Antenna Gain (dB) + Cable Loss (dB).

Mode	TX channel 9400 (1880.0MHz)	Frequency Range	1GHz ~ 18GHz
Environmental Conditions	25deg. C, 70%RH	Input Power	120Vac, 60Hz
Tested By	Noah Chang		

Antenna Polarity & Test Distance: Horizontal at 3 M							
No.	Freq. (MHz)	Reading (dBm)	S.G Power Value (dBm)	Correction Factor (dB)	EIRP (dBm)	Limit (dBm)	Margin (dB)
1	3760.00	-53.50	-47.70	7.10	-40.60	-13.00	-27.60
Antenna Polarity & Test Distance: Vertical at 3 M							
No.	Freq. (MHz)	Reading (dBm)	S.G Power Value (dBm)	Correction Factor (dB)	EIRP (dBm)	Limit (dBm)	Margin (dB)
1	3760.00	-56.60	-50.70	7.10	-43.60	-13.00	-30.60

Remarks:

1. EIRP (dBm) = S.G Value (dBm) + Correction Factor (dB).
2. Correction Factor (dB) = Substitution Antenna Gain (dB) + Cable Loss (dB).

Mode	TX channel 9538 (1907.6MHz)	Frequency Range	1GHz ~ 18GHz
Environmental Conditions	25deg. C, 70%RH	Input Power	120Vac, 60Hz
Tested By	Noah Chang		

Antenna Polarity & Test Distance: Horizontal at 3 M							
No.	Freq. (MHz)	Reading (dBm)	S.G Power Value (dBm)	Correction Factor (dB)	EIRP (dBm)	Limit (dBm)	Margin (dB)
1	3815.20	-52.90	-47.10	7.10	-40.00	-13.00	-27.00
Antenna Polarity & Test Distance: Vertical at 3 M							
No.	Freq. (MHz)	Reading (dBm)	S.G Power Value (dBm)	Correction Factor (dB)	EIRP (dBm)	Limit (dBm)	Margin (dB)
1	3815.20	-56.40	-50.50	7.10	-43.40	-13.00	-30.40

Remarks:

1. EIRP (dBm) = S.G Value (dBm) + Correction Factor (dB).
2. Correction Factor (dB) = Substitution Antenna Gain (dB) + Cable Loss (dB).

LTE Band 2, Channel Bandwidth 1.4MHz

Mode	TX channel 18607 (1850.70MHz)	Frequency Range	1GHz ~ 18GHz
Environmental Conditions	25deg. C, 70%RH	Input Power	120Vac, 60Hz
Tested By	Noah Chang		

Antenna Polarity & Test Distance: Horizontal at 3 M							
No.	Freq. (MHz)	Reading (dBm)	S.G Power Value (dBm)	Correction Factor (dB)	EIRP (dBm)	Limit (dBm)	Margin (dB)
1	3701.40	-53.84	-47.91	7.16	-40.75	-13.00	-27.75
Antenna Polarity & Test Distance: Vertical at 3 M							
No.	Freq. (MHz)	Reading (dBm)	S.G Power Value (dBm)	Correction Factor (dB)	EIRP (dBm)	Limit (dBm)	Margin (dB)
1	3701.40	-56.34	-49.36	7.16	-42.20	-13.00	-29.20

Remarks:

1. EIRP (dBm) = S.G Value (dBm) + Correction Factor (dB).
2. Correction Factor (dB) = Substitution Antenna Gain (dB) + Cable Loss (dB).

Mode	TX channel 18900 (1880.00MHz)	Frequency Range	1GHz ~ 18GHz
Environmental Conditions	25deg. C, 70%RH	Input Power	120Vac, 60Hz
Tested By	Noah Chang		

Antenna Polarity & Test Distance: Horizontal at 3 M							
No.	Freq. (MHz)	Reading (dBm)	S.G Power Value (dBm)	Correction Factor (dB)	EIRP (dBm)	Limit (dBm)	Margin (dB)
1	3760.00	-54.23	-47.68	7.10	-40.58	-13.00	-27.58
Antenna Polarity & Test Distance: Vertical at 3 M							
No.	Freq. (MHz)	Reading (dBm)	S.G Power Value (dBm)	Correction Factor (dB)	EIRP (dBm)	Limit (dBm)	Margin (dB)
1	3760.00	-55.90	-48.48	7.10	-41.38	-13.00	-28.38

Remarks:

1. EIRP (dBm) = S.G Value (dBm) + Correction Factor (dB).
2. Correction Factor (dB) = Substitution Antenna Gain (dB) + Cable Loss (dB).

Mode	TX channel 19193 (1909.30MHz)	Frequency Range	1GHz ~ 18GHz
Environmental Conditions	25deg. C, 70%RH	Input Power	120Vac, 60Hz
Tested By	Noah Chang		

Antenna Polarity & Test Distance: Horizontal at 3 M							
No.	Freq. (MHz)	Reading (dBm)	S.G Power Value (dBm)	Correction Factor (dB)	EIRP (dBm)	Limit (dBm)	Margin (dB)
1	3818.60	-53.11	-46.34	7.05	-39.29	-13.00	-26.29
Antenna Polarity & Test Distance: Vertical at 3 M							
No.	Freq. (MHz)	Reading (dBm)	S.G Power Value (dBm)	Correction Factor (dB)	EIRP (dBm)	Limit (dBm)	Margin (dB)
1	3818.60	-55.32	-47.55	7.05	-40.50	-13.00	-27.50

Remarks:

1. EIRP (dBm) = S.G Value (dBm) + Correction Factor (dB).
2. Correction Factor (dB) = Substitution Antenna Gain (dB) + Cable Loss (dB).

LTE Band 2, Channel Bandwidth 5MHz

Mode	TX channel 18625 (1852.50MHz)	Frequency Range	1GHz ~ 18GHz
Environmental Conditions	25deg. C, 70%RH	Input Power	120Vac, 60Hz
Tested By	Noah Chang		

Antenna Polarity & Test Distance: Horizontal at 3 M							
No.	Freq. (MHz)	Reading (dBm)	S.G Power Value (dBm)	Correction Factor (dB)	EIRP (dBm)	Limit (dBm)	Margin (dB)
1	3705.00	-53.39	-47.42	7.15	-40.27	-13.00	-27.27
Antenna Polarity & Test Distance: Vertical at 3 M							
No.	Freq. (MHz)	Reading (dBm)	S.G Power Value (dBm)	Correction Factor (dB)	EIRP (dBm)	Limit (dBm)	Margin (dB)
1	3705.00	-56.33	-49.31	7.15	-42.16	-13.00	-29.16

Remarks:

1. EIRP (dBm) = S.G Value (dBm) + Correction Factor (dB).
2. Correction Factor (dB) = Substitution Antenna Gain (dB) + Cable Loss (dB).

Mode	TX channel 18900 (1880.00MHz)	Frequency Range	1GHz ~ 18GHz
Environmental Conditions	25deg. C, 70%RH	Input Power	120Vac, 60Hz
Tested By	Noah Chang		

Antenna Polarity & Test Distance: Horizontal at 3 M							
No.	Freq. (MHz)	Reading (dBm)	S.G Power Value (dBm)	Correction Factor (dB)	EIRP (dBm)	Limit (dBm)	Margin (dB)
1	3760.00	-54.20	-47.65	7.10	-40.55	-13.00	-27.55
Antenna Polarity & Test Distance: Vertical at 3 M							
No.	Freq. (MHz)	Reading (dBm)	S.G Power Value (dBm)	Correction Factor (dB)	EIRP (dBm)	Limit (dBm)	Margin (dB)
1	3760.00	-55.72	-48.30	7.10	-41.20	-13.00	-28.20

Remarks:

1. EIRP (dBm) = S.G Value (dBm) + Correction Factor (dB).
2. Correction Factor (dB) = Substitution Antenna Gain (dB) + Cable Loss (dB).

Mode	TX channel 19175 (1907.50MHz)	Frequency Range	1GHz ~ 18GHz
Environmental Conditions	25deg. C, 70%RH	Input Power	120Vac, 60Hz
Tested By	Noah Chang		

Antenna Polarity & Test Distance: Horizontal at 3 M							
No.	Freq. (MHz)	Reading (dBm)	S.G Power Value (dBm)	Correction Factor (dB)	EIRP (dBm)	Limit (dBm)	Margin (dB)
1	3815.00	-53.93	-47.13	7.06	-40.07	-13.00	-27.07
Antenna Polarity & Test Distance: Vertical at 3 M							
No.	Freq. (MHz)	Reading (dBm)	S.G Power Value (dBm)	Correction Factor (dB)	EIRP (dBm)	Limit (dBm)	Margin (dB)
1	3815.00	-56.02	-48.27	7.06	-41.21	-13.00	-28.21

Remarks:

1. EIRP (dBm) = S.G Value (dBm) + Correction Factor (dB).
2. Correction Factor (dB) = Substitution Antenna Gain (dB) + Cable Loss (dB).

LTE Band 2, Channel Bandwidth 20MHz

Mode	TX channel 18700 (1860.00MHz)	Frequency Range	1GHz ~ 18GHz
Environmental Conditions	25deg. C, 70%RH	Input Power	120Vac, 60Hz
Tested By	Noah Chang		

Antenna Polarity & Test Distance: Horizontal at 3 M							
No.	Freq. (MHz)	Reading (dBm)	S.G Power Value (dBm)	Correction Factor (dB)	EIRP (dBm)	Limit (dBm)	Margin (dB)
1	3720.00	-54.10	-47.97	7.14	-40.83	-13.00	-27.83
Antenna Polarity & Test Distance: Vertical at 3 M							
No.	Freq. (MHz)	Reading (dBm)	S.G Power Value (dBm)	Correction Factor (dB)	EIRP (dBm)	Limit (dBm)	Margin (dB)
1	3720.00	-55.92	-48.80	7.14	-41.66	-13.00	-28.66

Remarks:

1. EIRP (dBm) = S.G Value (dBm) + Correction Factor (dB).
2. Correction Factor (dB) = Substitution Antenna Gain (dB) + Cable Loss (dB).

Mode	TX channel 18900 (1880.00MHz)	Frequency Range	1GHz ~ 18GHz
Environmental Conditions	25deg. C, 70%RH	Input Power	120Vac, 60Hz
Tested By	Noah Chang		

Antenna Polarity & Test Distance: Horizontal at 3 M							
No.	Freq. (MHz)	Reading (dBm)	S.G Power Value (dBm)	Correction Factor (dB)	EIRP (dBm)	Limit (dBm)	Margin (dB)
1	3760.00	-54.63	-48.08	7.10	-40.98	-13.00	-27.98
Antenna Polarity & Test Distance: Vertical at 3 M							
No.	Freq. (MHz)	Reading (dBm)	S.G Power Value (dBm)	Correction Factor (dB)	EIRP (dBm)	Limit (dBm)	Margin (dB)
1	3760.00	-55.47	-48.05	7.10	-40.95	-13.00	-27.95

Remarks:

1. EIRP (dBm) = S.G Value (dBm) + Correction Factor (dB).
2. Correction Factor (dB) = Substitution Antenna Gain (dB) + Cable Loss (dB).

Mode	TX channel 19100 (1900.00MHz)	Frequency Range	1GHz ~ 18GHz
Environmental Conditions	25deg. C, 70%RH	Input Power	120Vac, 60Hz
Tested By	Noah Chang		

Antenna Polarity & Test Distance: Horizontal at 3 M							
No.	Freq. (MHz)	Reading (dBm)	S.G Power Value (dBm)	Correction Factor (dB)	EIRP (dBm)	Limit (dBm)	Margin (dB)
1	3800.00	-53.28	-46.31	7.06	-39.25	-13.00	-26.25
Antenna Polarity & Test Distance: Vertical at 3 M							
No.	Freq. (MHz)	Reading (dBm)	S.G Power Value (dBm)	Correction Factor (dB)	EIRP (dBm)	Limit (dBm)	Margin (dB)
1	3800.00	-55.26	-47.54	7.06	-40.48	-13.00	-27.48

Remarks:

1. EIRP (dBm) = S.G Value (dBm) + Correction Factor (dB).
2. Correction Factor (dB) = Substitution Antenna Gain (dB) + Cable Loss (dB).

LTE Band 25, Channel Bandwidth 1.4MHz

Mode	TX channel 26047 (1850.7MHz)	Frequency Range	1GHz ~ 18GHz
Environmental Conditions	25deg. C, 70%RH	Input Power	120Vac, 60Hz
Tested By	Noah Chang		

Antenna Polarity & Test Distance: Horizontal at 3 M							
No.	Freq. (MHz)	Reading (dBm)	S.G Power Value (dBm)	Correction Factor (dB)	EIRP (dBm)	Limit (dBm)	Margin (dB)
1	3701.40	-56.10	-50.10	7.10	-43.00	-13.00	-30.00
Antenna Polarity & Test Distance: Vertical at 3 M							
No.	Freq. (MHz)	Reading (dBm)	S.G Power Value (dBm)	Correction Factor (dB)	EIRP (dBm)	Limit (dBm)	Margin (dB)
1	3701.40	-55.40	-48.40	7.10	-41.30	-13.00	-28.30

Remarks:

1. EIRP (dBm) = S.G Value (dBm) + Correction Factor (dB).
2. Correction Factor (dB) = Substitution Antenna Gain (dB) + Cable Loss (dB).

Mode	TX channel 26365 (1882.5MHz)	Frequency Range	1GHz ~ 18GHz
Environmental Conditions	25deg. C, 70%RH	Input Power	120Vac, 60Hz
Tested By	Noah Chang		

Antenna Polarity & Test Distance: Horizontal at 3 M							
No.	Freq. (MHz)	Reading (dBm)	S.G Power Value (dBm)	Correction Factor (dB)	EIRP (dBm)	Limit (dBm)	Margin (dB)
1	3765.00	-55.80	-49.20	7.10	-42.10	-13.00	-29.10
Antenna Polarity & Test Distance: Vertical at 3 M							
No.	Freq. (MHz)	Reading (dBm)	S.G Power Value (dBm)	Correction Factor (dB)	EIRP (dBm)	Limit (dBm)	Margin (dB)
1	3765.00	-55.40	-47.90	7.10	-40.80	-13.00	-27.80

Remarks:

1. EIRP (dBm) = S.G Value (dBm) + Correction Factor (dB).
2. Correction Factor (dB) = Substitution Antenna Gain (dB) + Cable Loss (dB).

Mode	TX channel 26683 (1914.3MHz)	Frequency Range	1GHz ~ 18GHz
Environmental Conditions	25deg. C, 70%RH	Input Power	120Vac, 60Hz
Tested By	Noah Chang		

Antenna Polarity & Test Distance: Horizontal at 3 M							
No.	Freq. (MHz)	Reading (dBm)	S.G Power Value (dBm)	Correction Factor (dB)	EIRP (dBm)	Limit (dBm)	Margin (dB)
1	3828.60	-51.10	-44.50	7.10	-37.40	-13.00	-24.40
Antenna Polarity & Test Distance: Vertical at 3 M							
No.	Freq. (MHz)	Reading (dBm)	S.G Power Value (dBm)	Correction Factor (dB)	EIRP (dBm)	Limit (dBm)	Margin (dB)
1	3828.60	-51.00	-43.30	7.10	-36.20	-13.00	-23.20

Remarks:

1. EIRP (dBm) = S.G Value (dBm) + Correction Factor (dB).
2. Correction Factor (dB) = Substitution Antenna Gain (dB) + Cable Loss (dB).

LTE Band 25, Channel Bandwidth 5MHz

Mode	TX channel 26065 (1852.5MHz)	Frequency Range	1GHz ~ 18GHz
Environmental Conditions	25deg. C, 70%RH	Input Power	120Vac, 60Hz
Tested By	Noah Chang		

Antenna Polarity & Test Distance: Horizontal at 3 M							
No.	Freq. (MHz)	Reading (dBm)	S.G Power Value (dBm)	Correction Factor (dB)	EIRP (dBm)	Limit (dBm)	Margin (dB)
1	3705.00	-56.50	-50.50	7.10	-43.40	-13.00	-30.40
Antenna Polarity & Test Distance: Vertical at 3 M							
No.	Freq. (MHz)	Reading (dBm)	S.G Power Value (dBm)	Correction Factor (dB)	EIRP (dBm)	Limit (dBm)	Margin (dB)
1	3705.00	-56.10	-49.00	7.10	-41.90	-13.00	-28.90

Remarks:

1. EIRP (dBm) = S.G Value (dBm) + Correction Factor (dB).
2. Correction Factor (dB) = Substitution Antenna Gain (dB) + Cable Loss (dB).

Mode	TX channel 26365 (1882.5MHz)	Frequency Range	1GHz ~ 18GHz
Environmental Conditions	25deg. C, 70%RH	Input Power	120Vac, 60Hz
Tested By	Noah Chang		

Antenna Polarity & Test Distance: Horizontal at 3 M							
No.	Freq. (MHz)	Reading (dBm)	S.G Power Value (dBm)	Correction Factor (dB)	EIRP (dBm)	Limit (dBm)	Margin (dB)
1	3765.00	-55.90	-49.30	7.10	-42.20	-13.00	-29.20
Antenna Polarity & Test Distance: Vertical at 3 M							
No.	Freq. (MHz)	Reading (dBm)	S.G Power Value (dBm)	Correction Factor (dB)	EIRP (dBm)	Limit (dBm)	Margin (dB)
1	3765.00	-55.60	-48.10	7.10	-41.00	-13.00	-28.00

Remarks:

1. EIRP (dBm) = S.G Value (dBm) + Correction Factor (dB).
2. Correction Factor (dB) = Substitution Antenna Gain (dB) + Cable Loss (dB).

Mode	TX channel 26665 (1912.5MHz)	Frequency Range	1GHz ~ 18GHz
Environmental Conditions	25deg. C, 70%RH	Input Power	120Vac, 60Hz
Tested By	Noah Chang		

Antenna Polarity & Test Distance: Horizontal at 3 M							
No.	Freq. (MHz)	Reading (dBm)	S.G Power Value (dBm)	Correction Factor (dB)	EIRP (dBm)	Limit (dBm)	Margin (dB)
1	3825.00	-58.90	-52.20	7.10	-45.10	-13.00	-32.10
Antenna Polarity & Test Distance: Vertical at 3 M							
No.	Freq. (MHz)	Reading (dBm)	S.G Power Value (dBm)	Correction Factor (dB)	EIRP (dBm)	Limit (dBm)	Margin (dB)
1	3825.00	-52.60	-44.90	7.10	-37.80	-13.00	-24.80

Remarks:

1. EIRP (dBm) = S.G Value (dBm) + Correction Factor (dB).
2. Correction Factor (dB) = Substitution Antenna Gain (dB) + Cable Loss (dB).

LTE Band 25, Channel Bandwidth 20MHz

Mode	TX channel 26140 (1860.0MHz)	Frequency Range	1GHz ~ 18GHz
Environmental Conditions	25deg. C, 70%RH	Input Power	120Vac, 60Hz
Tested By	Noah Chang		

Antenna Polarity & Test Distance: Horizontal at 3 M							
No.	Freq. (MHz)	Reading (dBm)	S.G Power Value (dBm)	Correction Factor (dB)	EIRP (dBm)	Limit (dBm)	Margin (dB)
1	3720.00	-56.90	-50.70	7.10	-43.60	-13.00	-30.60
Antenna Polarity & Test Distance: Vertical at 3 M							
No.	Freq. (MHz)	Reading (dBm)	S.G Power Value (dBm)	Correction Factor (dB)	EIRP (dBm)	Limit (dBm)	Margin (dB)
1	3720.00	-56.00	-48.80	7.10	-41.70	-13.00	-28.70

Remarks:

1. EIRP (dBm) = S.G Value (dBm) + Correction Factor (dB).
2. Correction Factor (dB) = Substitution Antenna Gain (dB) + Cable Loss (dB).

Mode	TX channel 26365 (1882.5MHz)	Frequency Range	1GHz ~ 18GHz
Environmental Conditions	25deg. C, 70%RH	Input Power	120Vac, 60Hz
Tested By	Noah Chang		

Antenna Polarity & Test Distance: Horizontal at 3 M							
No.	Freq. (MHz)	Reading (dBm)	S.G Power Value (dBm)	Correction Factor (dB)	EIRP (dBm)	Limit (dBm)	Margin (dB)
1	3765.00	-57.60	-51.00	7.10	-43.90	-13.00	-30.90
Antenna Polarity & Test Distance: Vertical at 3 M							
No.	Freq. (MHz)	Reading (dBm)	S.G Power Value (dBm)	Correction Factor (dB)	EIRP (dBm)	Limit (dBm)	Margin (dB)
1	3765.00	-57.60	-50.10	7.10	-43.00	-13.00	-30.00

Remarks:

1. EIRP (dBm) = S.G Value (dBm) + Correction Factor (dB).
2. Correction Factor (dB) = Substitution Antenna Gain (dB) + Cable Loss (dB).

Mode	TX channel 26590 (1905.0MHz)	Frequency Range	1GHz ~ 18GHz
Environmental Conditions	25deg. C, 70%RH	Input Power	120Vac, 60Hz
Tested By	Noah Chang		

Antenna Polarity & Test Distance: Horizontal at 3 M							
No.	Freq. (MHz)	Reading (dBm)	S.G Power Value (dBm)	Correction Factor (dB)	EIRP (dBm)	Limit (dBm)	Margin (dB)
1	3810.00	-53.30	-46.50	7.10	-39.40	-13.00	-26.40
Antenna Polarity & Test Distance: Vertical at 3 M							
No.	Freq. (MHz)	Reading (dBm)	S.G Power Value (dBm)	Correction Factor (dB)	EIRP (dBm)	Limit (dBm)	Margin (dB)
1	3810.00	-54.40	-46.70	7.10	-39.60	-13.00	-26.60

Remarks:

1. EIRP (dBm) = S.G Value (dBm) + Correction Factor (dB).
2. Correction Factor (dB) = Substitution Antenna Gain (dB) + Cable Loss (dB).

5 Pictures of Test Arrangements

Please refer to the attached file (Test Setup Photo).

Appendix – Information on the Testing Laboratories

We, Bureau Veritas Consumer Products Services (H.K.) Ltd., Taoyuan Branch, were founded in 1988 to provide our best service in EMC, Radio, Telecom and Safety consultation. Our laboratories are FCC recognized accredited test firms and accredited and approved according to ISO/IEC 17025.

If you have any comments, please feel free to contact us at the following:

Linko EMC/RF Lab

Tel: 886-2-26052180
Fax: 886-2-26051924

Hsin Chu EMC/RF/Telecom Lab

Tel: 886-3-6668565
Fax: 886-3-6668323

Hwa Ya EMC/RF/Safety Lab

Tel: 886-3-3183232
Fax: 886-3-3270892

Email: service.adt@tw.bureauveritas.com

Web Site: www.bureauveritas-adt.com

The address and road map of all our labs can be found in our web site also.

--- END ---