

FCC Test Report (Part 24)

Report No.: RF170412C17-7

FCC ID: Q3N-RS50

Test Model: RS50

Received Date: Apr. 12, 2017

Test Date: Apr. 15 ~ May 24, 2017

Issued Date: May 31, 2017

Applicant: CIPHERLAB CO., LTD

Address: 12F, 333 Dunhua S. Rd., Sec. 2 Taipei, Taiwan 106

Issued By: Bureau Veritas Consumer Products Services (H.K.) Ltd., Taoyuan Branch

Lab Address: No. 47-2, 14th Ling, Chia Pau Vil., Lin Kou Dist., New Taipei City, Taiwan (R.O.C.)

Test Location: No. 19, Hwa Ya 2nd Rd., Wen Hwa Vil., Kwei Shan Dist., Taoyuan City 33383, TAIWAN (R.O.C.)



This report is for your exclusive use. Any copying or replication of this report to or for any other person or entity, or use of our name or trademark, is permitted only with our prior written permission. This report sets forth our findings solely with respect to the test samples identified herein. The results set forth in this report are not indicative or representative of the quality or characteristics of the lot from which a test sample was taken or any similar or identical product unless specifically and expressly noted. Our report includes all of the tests requested by you and the results thereof based upon the information that you provided to us. You have 60 days from date of issuance of this report to notify us of any material error or omission caused by our negligence, provided, however, that such notice shall be in writing and shall specifically address the issue you wish to raise. A failure to raise such issue within the prescribed time shall constitute your unqualified acceptance of the completeness of this report, the tests conducted and the correctness of the report contents. Unless specifically mentioned, the uncertainty of measurement has been explicitly taken into account to declare the compliance or non-compliance to the specification. The report must not be used by the client to claim product certification, approval, or endorsement by TAF or any government agencies

Table of Contents

Release Control Record	4
1 Certificate of Conformity	5
2 Summary of Test Results	6
2.1 Measurement Uncertainty.....	6
2.2 Test Site and Instruments.....	7
3 General Information	8
3.1 General Description of EUT.....	8
3.2 Configuration of System under Test.....	9
3.2.1 Description of Support Units.....	9
3.3 Test Mode Applicability and Tested Channel Detail.....	10
3.4 EUT Operating Conditions.....	14
3.5 General Description of Applied Standards.....	14
4 Test Types and Results	15
4.1 Output Power Measurement.....	15
4.1.1 Limits of Output Power Measurement.....	15
4.1.2 Test Procedures.....	15
4.1.3 Test Setup.....	16
4.1.4 Test Results.....	17
4.2 Modulation Characteristics Measurement.....	28
4.2.1 Limits of Modulation Characteristics.....	28
4.2.2 Test Procedure.....	28
4.2.3 Test Setup.....	28
4.2.4 Test Results.....	29
4.3 Frequency Stability Measurement.....	32
4.3.1 Limits of Frequency Stability Measurement.....	32
4.3.2 Test Procedure.....	32
4.3.3 Test Setup.....	32
4.3.4 Test Results.....	33
4.4 Occupied Bandwidth Measurement.....	34
4.4.1 Test Procedure.....	34
4.4.2 Test Setup.....	34
4.4.3 Test Result.....	35
4.5 Band Edge Measurement.....	45
4.5.1 Limits of Band Edge Measurement.....	45
4.5.2 Test Setup.....	45
4.5.3 Test Procedures.....	45
4.5.4 Test Results.....	46
4.6 Peak to Average Ratio.....	54
4.6.1 Limits of Peak to Average Ratio Measurement.....	54
4.6.2 Test Setup.....	54
4.6.3 Test Procedures.....	54
4.6.4 Test Results.....	55
4.7 Conducted Spurious Emissions.....	60
4.7.1 Limits of Conducted Spurious Emissions Measurement.....	60
4.7.2 Test Setup.....	60
4.7.3 Test Procedure.....	60
4.7.4 Test Results.....	61
4.8 Radiated Emission Measurement.....	97
4.8.1 Limits of Radiated Emission Measurement.....	97
4.8.2 Test Procedure.....	97
4.8.3 Deviation from Test Standard.....	97
4.8.4 Test Setup.....	98
4.8.5 Test Results.....	99

5	Pictures of Test Arrangements.....	123
	Appendix – Information on the Testing Laboratories	124

Release Control Record

Issue No.	Description	Date Issued
RF170412C17-7	Original release	May 31, 2017

1 Certificate of Conformity

Product: Mobile Computer

Brand: CIPHERLAB

Test Model: RS50

Sample Status: Engineering sample

Applicant: CIPHERLAB CO., LTD

Test Date: Apr. 15 ~ May 24, 2017

Standards: FCC Part 24, Subpart E

The above equipment has been tested by **Bureau Veritas Consumer Products Services (H.K.) Ltd., Taoyuan Branch**, and found compliance with the requirement of the above standards. The test record, data evaluation & Equipment Under Test (EUT) configurations represented herein are true and accurate accounts of the measurements of the sample's EMC characteristics under the conditions specified in this report.

Prepared by : , **Date:** May 31, 2017
Pettie Chen / Senior Specialist

Approved by : , **Date:** May 31, 2017
Bruce Chen / Project Engineer

2 Summary of Test Results

Applied Standard: FCC Part 24 & Part 2			
FCC Clause	Test Item	Result	Remarks
2.1046 24.232	Effective radiated power	Pass	Meet the requirement of limit.
2.1046 24.232(d)	Peak To Average Ratio	Pass	Meet the requirement of limit.
2.1047	Modulation characteristics	PASS	Meet the requirement
2.1055 24.235	Frequency Stability	Pass	Meet the requirement of limit.
2.1049 24.238(b)	Occupied Bandwidth	Pass	Meet the requirement of limit.
24.238(b)	Band Edge Measurements	Pass	Meet the requirement of limit.
2.1051 24.238	Conducted Spurious Emissions	Pass	Meet the requirement of limit.
2.1053 24.238	Radiated Spurious Emissions	Pass	Meet the requirement of limit. Minimum passing margin is -10.1dB at 5640.0MHz.

2.1 Measurement Uncertainty

Where relevant, the following measurement uncertainty levels have been estimated for tests performed on the EUT as specified in CISPR 16-4-2:

Measurement	Frequency	Expanded Uncertainty (k=2) (\pm)
Radiated Emissions up to 1 GHz	30MHz ~ 200MHz	3.86 dB
	200MHz ~1000MHz	3.87 dB
Radiated Emissions above 1 GHz	1GHz ~ 18GHz	2.29 dB
	18GHz ~ 40GHz	2.29 dB

2.2 Test Site and Instruments

Description & Manufacturer	Model No.	Serial No.	Cal. Date	Cal. Due
Test Receiver ROHDE & SCHWARZ	ESIB7	100187	May 02, 2017	May 01, 2018
Spectrum Analyzer ROHDE & SCHWARZ	FSP40	100041	Nov. 16, 2016	Nov. 15, 2017
BILOG Antenna SCHWARZBECK	VULB9168	9168-171	Dec. 28, 2016	Dec. 27, 2017
HORN Antenna SCHWARZBECK	9120D	209	Dec. 27, 2016	Dec. 26, 2017
HORN Antenna SCHWARZBECK	BBHA 9170	BBHA9170241	Dec. 14, 2016	Dec. 13, 2017
Loop Antenna	EM-6879	269	Aug. 11, 2016	Aug. 10, 2017
Preamplifier Agilent	8447D	2944A10738	Aug. 22, 2016	Aug. 21, 2017
Preamplifier Agilent	8449B	3008A01922	Sep. 18, 2016	Sep. 17, 2017
RF signal cable HUBER+SUHNER	SUCOFLEX 104	Cable-CH3-03 (214378)	Aug. 22, 2016	Aug. 21, 2017
RF signal cable HUBER+SUHNER	SUCOFLEX 106	Cable-CH3-03 (309224+12738)	Aug. 22, 2016	Aug. 21, 2017
Software BV ADT	ADT_Radiated_ V7.6.15.9.4	NA	NA	NA
Antenna Tower inn-co GmbH	MA 4000	013303	NA	NA
Antenna Tower Controller BV ADT	AT100	AT93021702	NA	NA
Turn Table BV ADT	TT100	TT93021702	NA	NA
Turn Table Controller BV ADT	SC100	SC93021702	NA	NA
JFW 20dB attenuation	50HF-020-SMA	NA	NA	NA

- Note:
1. The calibration interval of the above test instruments is 12 months and the calibrations are traceable to NML/ROC and NIST/USA.
 2. The test was performed in HwaYa Chamber 3.
 3. The horn antenna and preamplifier (model: 8449B) are used only for the measurement of emission frequency above 1GHz if tested.
 4. The FCC Site Registration No. is 988962.
 5. The IC Site Registration No. is IC 7450F-3.

3 General Information

3.1 General Description of EUT

Product	Mobile Computer	
Brand	CIPHERLAB	
Test Model	RS50	
Sample Status	Engineering sample	
Power Supply Rating	5Vdc (adapter) 3.8Vdc (battery)	
Modulation Type	GSM, GPRS: GMSK EDGE: 8PSK WCDMA: BPSK, QPSK HSDPA: BPSK HSUPA: QPSK LTE: QPSK, 16QAM	
Operating Frequency	GSM	1850.2MHz ~ 1909.8MHz
	WCDMA Band 2	1852.4MHz ~ 1907.6MHz
	LTE Band 2 (Channel Bandwidth 1.4MHz)	1850.7MHz ~ 1909.3MHz
	LTE Band 2 (Channel Bandwidth 3MHz)	1851.5MHz ~ 1908.5MHz
	LTE Band 2 (Channel Bandwidth 5MHz)	1852.5MHz ~ 1907.5MHz
	LTE Band 2 (Channel Bandwidth 10MHz)	1855.0MHz ~ 1905.0MHz
	LTE Band 2 (Channel Bandwidth 15MHz)	1857.5MHz ~ 1902.5MHz
	LTE Band 2 (Channel Bandwidth 20MHz)	1860.0MHz ~ 1900.0MHz
Max. ERP Power	GSM	1949.845mW (32.9dBm)
	WCDMA Band 2	295.121mW (24.7dBm)
	LTE Band 2 (Channel Bandwidth 1.4MHz)	1122.018mW (30.5dBm)
	LTE Band 2 (Channel Bandwidth 3MHz)	724.436mW (28.6dBm)
	LTE Band 2 (Channel Bandwidth 5MHz)	891.251mW (29.5dBm)
	LTE Band 2 (Channel Bandwidth 10MHz)	676.083mW (28.3dBm)
	LTE Band 2 (Channel Bandwidth 15MHz)	870.964mW (29.4dBm)
	LTE Band 2 (Channel Bandwidth 20MHz)	851.138mW (29.3dBm)
Antenna Type	GSM: PIFA antenna with 3.92dBi gain WCDMA Band 2: PIFA antenna with 3.92dBi gain LTE Band 2: Main Ant.: PIFA antenna with 3.92dBi gain Aux. Ant.: PIFA antenna with 1.65dBi gain	
Antenna Connector	spring	
Accessory Device	Adapter, Battery	
Data Cable Supplied	1.5m shielded USB cable with 1 core	

Note:

1. The EUT uses following accessory devices.

Component	Vendor	Model	Specification
Adapter	Sunny COMPUTER TECHNOLOGY CO.,LTD.	SYS1561-1005	I/P: 100-240Vac, 1.0A MAX, 50-60Hz O/P: +5Vdc, 2A, 10W MAX.
Battery	CIPHERLAB	BA-0115A3	3.8Vdc

3.2 Configuration of System under Test

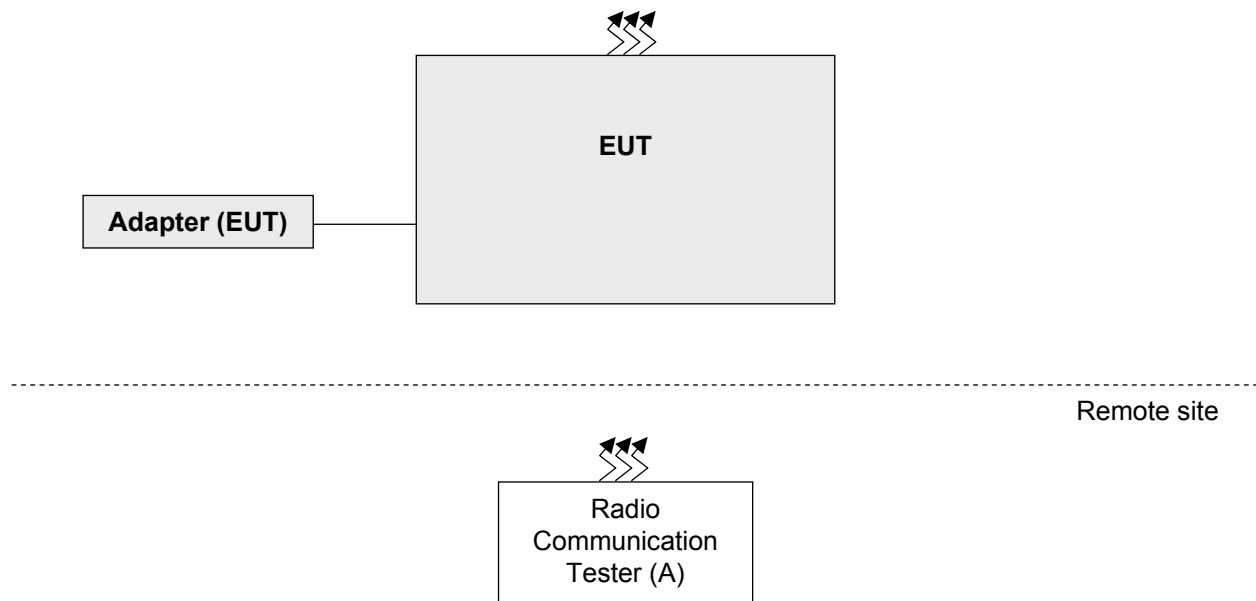

3.2.1 Description of Support Units

The EUT has been tested as an independent unit together with other necessary accessories or support units. The following support units or accessories were used to form a representative test configuration during the tests.

ID	Product	Brand	Model No.	Serial No.	FCC ID	Remarks
A.	Radio Communication Tester	R&S	CMU200	123112	NA	-

Note:

1. All power cords of the above support units are non-shielded (1.8m).
2. Item A acted as a communication partner to transfer data.

3.3 Test Mode Applicability and Tested Channel Detail

Pre-Scan has been conducted to determine the worst-case mode from all possible combinations between available modulations, data rates, XYZ axis and antenna ports. The worst case was found when positioned on Y-plane. Following channel(s) was (were) selected for the final test as listed below:

GSM Mode

EUT Configure Mode	Test Item	Available Channel	Tested Channel	Mode
-	EIRP	512 to 810	512(1850.2MHz), 661(1880.0MHz), 810(1909.8MHz)	GSM
-	Modulation Characteristics	512 to 810	661(1880.0MHz)	GSM, GPRS, EDGE
-	Frequency Stability	512 to 810	661(1880.0MHz)	GSM
-	Occupied Bandwidth	512 to 810	512(1850.2MHz), 661(1880.0MHz), 810(1909.8MHz)	GSM, GPRS, EDGE
-	Band Edge	512 to 810	512(1850.2MHz), 810(1909.8MHz)	GSM, GPRS, EDGE
-	Peak To Average Ratio	512 to 810	512(1850.2MHz), 661(1880.0MHz), 810(1909.8MHz)	GSM, GPRS, EDGE
-	Conducted Emission	512 to 810	512(1850.2MHz), 661(1880.0MHz), 810(1909.8MHz)	GSM, GPRS, EDGE
-	Radiated Emission Below 1GHz	512 to 810	512(1850.2MHz)	GSM
-	Radiated Emission Above 1GHz	512 to 810	512(1850.2MHz), 661(1880.0MHz), 810(1909.8MHz)	GSM

WCDMA Mode

EUT Configure Mode	Test Item	Available Channel	Tested Channel	Mode
-	EIRP	9262 to 9538	9262(1852.4MHz), 9400(1880.0MHz), 9538(1907.6MHz)	WCDMA
-	Modulation Characteristics	9262 to 9538	9400(1880.0MHz)	WCDMA, HSDPA, HSUPA
-	Frequency Stability	9262 to 9538	9400(1880.0MHz)	WCDMA
-	Occupied Bandwidth	9262 to 9538	9262(1852.4MHz), 9400(1880.0MHz), 9538(1907.6MHz)	WCDMA, HSDPA, HSUPA
-	Band Edge	9262 to 9538	9262(1852.4MHz), 9538(1907.6MHz)	WCDMA, HSDPA, HSUPA
-	Peak To Average Ratio	9262 to 9538	9262(1852.4MHz), 9400(1880.0MHz), 9538(1907.6MHz)	WCDMA, HSDPA, HSUPA
-	Conducted Emission	9262 to 9538	9262(1852.4MHz), 9400(1880.0MHz), 9538(1907.6MHz)	WCDMA, HSDPA, HSUPA
-	Radiated Emission Below 1GHz	9262 to 9538	9262(1852.4MHz)	WCDMA
-	Radiated Emission Above 1GHz	9262 to 9538	9262(1852.4MHz), 9400(1880.0MHz), 9538(1907.6MHz)	WCDMA

LTE Band 2

Test item	Available channel	Tested Channel	Channel Bandwidth	Modulation	Mode
EIRP	18607 to 19193	18607(1850.70MHz), 18900(1880.00MHz), 19193(1909.30MHz)	1.4MHz	QPSK	1 RB / 5 RB Offset
	18615 to 19185	18615(1851.50MHz), 18900(1880.00MHz), 19185(1908.50MHz)	3MHz	QPSK	1 RB / 14 RB Offset
	18625 to 19175	18625(1852.50MHz), 18900(1880.00MHz), 19175(1907.50MHz)	5MHz	QPSK	1 RB / 24 RB Offset
	18650 to 19150	18650(1855.00MHz), 18900(1880.00MHz), 19150(1905.00MHz)	10MHz	QPSK	1 RB / 49 RB Offset
	18675 to 19125	18675(1857.50MHz), 18900(1880.00MHz), 19125(1902.50MHz)	15MHz	QPSK	1 RB / 74 RB Offset
	18700 to 19100	18700(1860.00MHz), 18900(1880.00MHz), 19100(1900.00MHz)	20MHz	QPSK	1 RB / 99 RB Offset
Modulation characteristics	18607 to 19193	18900(1880.00MHz)	1.4MHz	QPSK	1 RB / 5 RB Offset
	18700 to 19100	18900(1880.00MHz)	20MHz	QPSK	1 RB / 99 RB Offset
Frequency Stability	18607 to 19193	18900(1880.00MHz)	1.4MHz	QPSK	1 RB / 5 RB Offset
Occupied Bandwidth	18607 to 19193	18607(1850.70MHz), 18900(1880.00MHz), 19193(1909.30MHz)	1.4MHz	QPSK / 16QAM	1 RB / 5 RB Offset
	18615 to 19185	18615(1851.50MHz), 18900(1880.00MHz), 19185(1908.50MHz)	3MHz	QPSK / 16QAM	1 RB / 14 RB Offset
	18625 to 19175	18625(1852.50MHz), 18900(1880.00MHz), 19175(1907.50MHz)	5MHz	QPSK / 16QAM	1 RB / 24 RB Offset
	18650 to 19150	18650(1855.00MHz), 18900(1880.00MHz), 19150(1905.00MHz)	10MHz	QPSK / 16QAM	1 RB / 49 RB Offset
	18675 to 19125	18675(1857.50MHz), 18900(1880.00MHz), 19125(1902.50MHz)	15MHz	QPSK / 16QAM	1 RB / 74 RB Offset
	18700 to 19100	18700(1860.00MHz), 18900(1880.00MHz), 19100(1900.00MHz)	20MHz	QPSK / 16QAM	1 RB / 99 RB Offset
Band Edge	18607 to 19193	18607(1850.70MHz), 19193(1909.30MHz)	1.4MHz	QPSK	1 RB / 0 RB Offset 1 RB / 5 RB Offset 6 RB / 0 RB Offset
	18615 to 19185	18615(1851.50MHz), 19185(1908.50MHz)	3MHz	QPSK	1 RB / 0 RB Offset 1 RB / 14 RB Offset 15 RB / 0 RB Offset
	18625 to 19175	18625(1852.50MHz), 19175(1907.50MHz)	5MHz	QPSK	1 RB / 0 RB Offset 1 RB / 24 RB Offset 25 RB / 0 RB Offset
	18650 to 19150	18650(1855.00MHz), 19150(1905.00MHz)	10MHz	QPSK	1 RB / 0 RB Offset 1 RB / 49 RB Offset 50 RB / 0 RB Offset
	18675 to 19125	18675(1857.50MHz), 19125(1902.50MHz)	15MHz	QPSK	1 RB / 0 RB Offset 1 RB / 74 RB Offset 75 RB / 0 RB Offset
	18700 to 19100	18700(1860.00MHz), 19100(1900.00MHz)	20MHz	QPSK	1 RB / 0 RB Offset 1 RB / 99 RB Offset 100 RB / 0 RB Offset

Test item	Available channel	Tested Channel	Channel Bandwidth	Modulation	Mode
Peak to Average Ratio	18607 to 19193	18607(1850.70MHz), 18900(1880.00MHz), 19193(1909.30MHz)	1.4MHz	QPSK / 16QAM	1 RB / 5 RB Offset
	18615 to 19185	18615(1851.50MHz), 18900(1880.00MHz), 19185(1908.50MHz)	3MHz	QPSK / 16QAM	1 RB / 14 RB Offset
	18625 to 19175	18625(1852.50MHz), 18900(1880.00MHz), 19175(1907.50MHz)	5MHz	QPSK / 16QAM	1 RB / 24 RB Offset
	18650 to 19150	18650(1855.00MHz), 18900(1880.00MHz), 19150(1905.00MHz)	10MHz	QPSK / 16QAM	1 RB / 49 RB Offset
	18675 to 19125	18675(1857.50MHz), 18900(1880.00MHz), 19125(1902.50MHz)	15MHz	QPSK / 16QAM	1 RB / 74 RB Offset
	18700 to 19100	18700(1860.00MHz), 18900(1880.00MHz), 19100(1900.00MHz)	20MHz	QPSK / 16QAM	1 RB / 99 RB Offset
Conducted Emission	18607 to 19193	18607(1850.70MHz), 18900(1880.00MHz), 19193(1909.30MHz)	1.4MHz	QPSK	1 RB / 5 RB Offset
	18615 to 19185	18615(1851.50MHz), 18900(1880.00MHz), 19185(1908.50MHz)	3MHz	QPSK	1 RB / 14 RB Offset
	18625 to 19175	18625(1852.50MHz), 18900(1880.00MHz), 19175(1907.50MHz)	5MHz	QPSK	1 RB / 24 RB Offset
	18650 to 19150	18650(1855.00MHz), 18900(1880.00MHz), 19150(1905.00MHz)	10MHz	QPSK	1 RB / 49 RB Offset
	18675 to 19125	18675(1857.50MHz), 18900(1880.00MHz), 19125(1902.50MHz)	15MHz	QPSK	1 RB / 74 RB Offset
	18700 to 19100	18700(1860.00MHz), 18900(1880.00MHz), 19100(1900.00MHz)	20MHz	QPSK	1 RB / 99 RB Offset
Radiated Emission Below 1GHz	18607 to 19193	18607(1850.70MHz)	1.4MHz	QPSK	1 RB / 5 RB Offset
	18615 to 19185	18615(1851.50MHz)	3MHz	QPSK	1 RB / 14 RB Offset
	18625 to 19175	18625(1852.50MHz)	5MHz	QPSK	1 RB / 24 RB Offset
	18650 to 19150	18650(1855.00MHz)	10MHz	QPSK	1 RB / 49 RB Offset
	18675 to 19125	18675(1857.50MHz)	15MHz	QPSK	1 RB / 74 RB Offset
	18700 to 19100	18700(1860.00MHz)	20MHz	QPSK	1 RB / 99 RB Offset
Radiated Emission Above 1GHz	18607 to 19193	18607(1850.70MHz), 18900(1880.00MHz), 19193(1909.30MHz)	1.4MHz	QPSK	1 RB / 5 RB Offset
	18615 to 19185	18615(1851.50MHz), 18900(1880.00MHz), 19185(1908.50MHz)	3MHz	QPSK	1 RB / 14 RB Offset
	18625 to 19175	18625(1852.50MHz), 18900(1880.00MHz), 19175(1907.50MHz)	5MHz	QPSK	1 RB / 24 RB Offset
	18650 to 19150	18650(1855.00MHz), 18900(1880.00MHz), 19150(1905.00MHz)	10MHz	QPSK	1 RB / 49 RB Offset
	18675 to 19125	18675(1857.50MHz), 18900(1880.00MHz), 19125(1902.50MHz)	15MHz	QPSK	1 RB / 74 RB Offset
	18700 to 19100	18700(1860.00MHz), 18900(1880.00MHz), 19100(1900.00MHz)	20MHz	QPSK	1 RB / 99 RB Offset

Note:

1. For radiated emission below 1GHz, the low, mid and high channels were pre-tested in chamber. The low channel was the worst case and chosen for final test.
2. The conducted output power for QPSK and 16QAM, measured value of QPSK is higher than 16QAM mode. Therefore, only occupied bandwidth and Peak to average ratio items had been tested under QPSK and 16QAM modes, the other test items were performed under QPSK mode only.
3. The EUT supported 1 antenna transmitter for licence parameter.

Test Condition:

Test Item	Environmental Conditions	Input Power (System)	Tested By
EIRP	24deg. C, 64%RH	120Vac, 60Hz	Match Tsui
Modulation characteristics	24deg. C, 64%RH	120Vac, 60Hz	Match Tsui
Frequency Stability	24deg. C, 64%RH	3.8Vdc	Match Tsui
Occupied Bandwidth	24deg. C, 64%RH	120Vac, 60Hz	Match Tsui
Band Edge	24deg. C, 64%RH	120Vac, 60Hz	Match Tsui
Peak To Average Ratio	24deg. C, 64%RH	120Vac, 60Hz	Match Tsui
Conducted Emission	24deg. C, 64%RH	120Vac, 60Hz	Match Tsui
Radiated Emission	16deg. C, 66%RH 25deg. C, 66%RH 19deg. C, 66%RH 20deg. C, 66%RH	120Vac, 60Hz	James Yang Jones Chang Chris Lin

3.4 EUT Operating Conditions

The EUT makes a call to the communication simulator. The communication simulator station system controlled a EUT to export maximum output power under transmission mode and specific channel frequency

3.5 General Description of Applied Standards

The EUT is a RF Product. According to the specifications of the manufacturer, it must comply with the requirements of the following standards:

FCC 47 CFR Part 2

FCC 47 CFR Part 24

KDB 971168 D01 Power Meas License Digital Systems v02r02

ANSI/TIA/EIA-603-D 2010

All test items have been performed and recorded as per the above standards.

Note: The EUT has been verified to comply with the requirements of FCC Part 15, Subpart B, Class B (DoC). The test report has been issued separately.

4 Test Types and Results

4.1 Output Power Measurement

4.1.1 Limits of Output Power Measurement

Mobile / Portable station are limited to 2 watts e.r.p.

4.1.2 Test Procedures

EIRP / ERP Measurement:

- a. All measurements were done at low, middle and high operational frequency range. RBW and VBW is 1MHz for GSM, 5MHz for WCDMA mode and 10MHz for LTE mode.
- b. Substitution method is used for E.I.R.P measurement. In the semi-anechoic chamber, EUT placed on the 0.8m height of Turn Table, rotated the table around 360 degrees to search the maximum radiation power and receiver antenna shall be rotated vertical and horizontal polarization and moved height from 1m to 4m to find the maximum polar radiated power. The "Read Value" is the spectrum reading the maximum power value.
- c. The substitution horn antenna is substituted for EUT at the same position and signals generator export the CW signal to the substitution antenna via a TX cable. Rotated the Turn Table and moved receiving antenna to find the maximum radiation power. Adjust output power level of S.G to get a Value of spectrum reading equal to "Read Value" of step b. Record the power level of S.G
- d. $EIRP = \text{Output power level of S.G} - \text{TX cable loss} + \text{Antenna gain of substitution horn}$. E.R.P power can be calculated form E.I.R.P power by subtracting the gain of dipole, $E.R.P \text{ power} = E.I.R.P \text{ power} - 2.15\text{dBi}$.

Conducted Power Measurement:

The EUT was set up for the maximum power with GSM, WCDMA, LTE link data modulation and link up with simulator. Set the EUT to transmit under low, middle and high channel and record the power level shown on simulator.

4.1.3 Test Setup

EIRP / ERP Measurement:

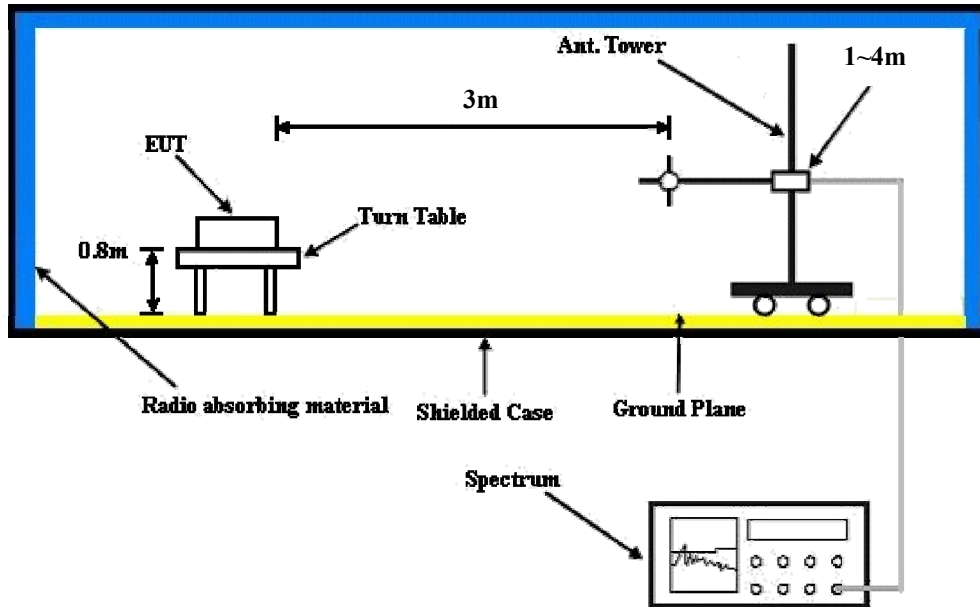

For the actual test configuration, please refer to the attached file (Test Setup Photo).

Conducted Power Measurement:



For the actual test configuration, please refer to the attached file (Test Setup Photo).

4.1.4 Test Results

Conducted Output Power (dBm)

Band	GSM1900		
Channel	512	661	810
Frequency	1850.2	1880	1909.8
GSM	30.57	30.28	30.05
GPRS 8	29.99	29.92	29.61
GPRS 10	29.29	28.99	28.78
GPRS 11	27.68	27.41	27.21
GPRS 12	26.69	26.37	26.14
EDGE 8 (MCS9)	26.53	26.28	26.02
EDGE 10 (MCS9)	25.52	25.27	25.01
EDGE 11 (MCS9)	23.55	23.19	22.91
EDGE 12 (MCS9)	22.36	22.02	21.84

Band	WCDMA II		
Channel	9262	9400	9538
Frequency	1852.4	1880	1907.6
RMC 12.2K	23.17	23.24	23.13
HSDPA Subtest-1	22.32	22.36	22.25
HSDPA Subtest-2	22.24	22.32	22.13
HSDPA Subtest-3	21.80	21.85	21.73
HSDPA Subtest-4	21.76	21.83	21.72
HSUPA Subtest-1	22.26	22.35	22.17
HSUPA Subtest-2	20.33	20.40	20.30
HSUPA Subtest-3	21.29	21.38	21.18
HSUPA Subtest-4	19.83	19.89	19.79
HSUPA Subtest-5	22.25	22.30	22.12

Conducted Output Power (dBm)

Band / BW	RB Size	RB Offset	QPSK			16QAM		
			CH 18607	CH 18900	CH 19193	CH 18607	CH 18900	CH 19193
			1850.7 MHz	1880 MHz	1909.3 MHz	1850.7 MHz	1880 MHz	1909.3 MHz
2 / 1.4MHz	1	0	23.63	23.59	23.66	22.67	22.62	22.70
	1	2	23.49	23.39	23.56	22.52	22.47	22.58
	1	5	23.33	23.27	23.46	22.40	22.33	22.43
	3	0	23.36	23.29	23.47	22.41	22.30	22.52
	3	1	23.18	23.11	23.32	22.17	22.06	22.35
	3	3	23.03	23.00	23.14	22.01	21.96	22.10
	6	0	22.28	22.21	22.30	21.26	21.18	21.29

Band / BW	RB Size	RB Offset	QPSK			16QAM		
			CH 18615	CH 18900	CH 19185	CH 18615	CH 18900	CH 19185
			1851.5 MHz	1880 MHz	1908.5 MHz	1851.5 MHz	1880 MHz	1908.5 MHz
2 / 3MHz	1	0	23.68	23.61	23.70	22.76	22.70	22.77
	1	7	23.56	23.47	23.62	22.61	22.52	22.65
	1	14	23.43	23.35	23.49	22.48	22.43	22.56
	8	0	22.48	22.45	22.61	21.59	21.52	21.71
	8	3	22.36	22.32	22.46	21.38	21.29	21.49
	8	7	22.24	22.20	22.27	21.21	21.16	21.25
	15	0	22.38	22.33	22.42	21.43	21.34	21.49

Band / BW	RB Size	RB Offset	QPSK			16QAM		
			CH 18625	CH 18900	CH 19175	CH 18625	CH 18900	CH 19175
			1852.5 MHz	1880 MHz	1907.5 MHz	1852.5 MHz	1880 MHz	1907.5 MHz
2 / 5MHz	1	0	23.74	23.70	23.76	22.80	22.72	22.82
	1	12	23.63	23.58	23.68	22.64	22.59	22.71
	1	24	23.53	23.50	23.60	22.55	22.48	22.63
	12	0	22.68	22.64	22.72	21.67	21.61	21.75
	12	6	22.54	22.49	22.61	21.52	21.39	21.53
	12	13	22.40	22.37	22.46	21.32	21.30	21.36
	25	0	22.58	22.51	22.60	21.52	21.42	21.55

Band / BW	RB Size	RB Offset	QPSK			16QAM		
			CH 18650	CH 18900	CH 19150	CH 18650	CH 18900	CH 19150
			1855 MHz	1880 MHz	1905 MHz	1855 MHz	1880 MHz	1905 MHz
2 / 10MHz	1	0	23.81	23.77	23.82	22.83	22.78	22.85
	1	24	23.71	23.67	23.73	22.71	22.65	22.73
	1	49	23.65	23.61	23.69	22.61	22.59	22.66
	25	0	22.80	22.75	22.89	21.78	21.72	21.81
	25	12	22.66	22.61	22.69	21.60	21.56	21.70
	25	25	22.57	22.51	22.59	21.50	21.47	21.52
	50	0	22.69	22.64	22.70	21.65	21.57	21.70

Band / BW	RB Size	RB Offset	QPSK			16QAM		
			CH 18675	CH 18900	CH 19125	CH 18675	CH 18900	CH 19125
			1857.5 MHz	1880 MHz	1902.5 MHz	1857.5 MHz	1880 MHz	1902.5 MHz
2 / 15MHz	1	0	23.86	23.82	23.87	22.91	22.88	22.92
	1	37	23.78	23.74	23.79	22.80	22.78	22.85
	1	74	23.71	23.68	23.74	22.73	22.71	22.75
	36	0	22.86	22.83	22.88	21.88	21.84	21.91
	36	19	22.76	22.72	22.80	21.76	21.69	21.80
	36	39	22.67	22.65	22.69	21.62	21.60	21.66
	75	0	22.77	22.73	22.80	21.80	21.72	21.81

Band / BW	RB Size	RB Offset	QPSK			16QAM		
			CH 18700	CH 18900	CH 19100	CH 18700	CH 18900	CH 19100
			1860 MHz	1880 MHz	1900 MHz	1860 MHz	1880 MHz	1900 MHz
2 / 20MHz	1	0	23.91	23.88	23.92	22.96	22.92	22.97
	1	50	23.83	23.81	23.87	22.87	22.82	22.89
	1	99	23.79	23.76	23.82	22.80	22.77	22.83
	50	0	22.96	22.93	22.99	21.96	21.93	21.98
	50	25	22.88	22.86	22.90	21.86	21.84	21.90
	50	50	22.82	22.80	22.85	21.78	21.75	21.82
	100	0	22.89	22.87	22.91	21.88	21.85	21.90

EIRP Power (dBm)
GSM Mode

MODE		TX channel 512					
Antenna Polarity & Test Distance: Horizontal at 3 M							
No.	Freq. (MHz)	Reading (dBm)	S.G Power Value (dBm)	Correction Factor (dB)	EIRP (dBm)	Limit (dBm)	Margin (dB)
1	1850.20	-13.4	25.5	1.0	26.5	33.0	-6.5
Antenna Polarity & Test Distance: Vertical at 3 M							
No.	Freq. (MHz)	Reading (dBm)	S.G Power Value (dBm)	Correction Factor (dB)	EIRP (dBm)	Limit (dBm)	Margin (dB)
1	1850.20	-6.5	31.9	1.0	32.9	33.0	-0.1

MODE		TX channel 661					
Antenna Polarity & Test Distance: Horizontal at 3 M							
No.	Freq. (MHz)	Reading (dBm)	S.G Power Value (dBm)	Correction Factor (dB)	EIRP (dBm)	Limit (dBm)	Margin (dB)
1	1880.00	-14.7	24.6	1.1	25.7	33.0	-7.3
Antenna Polarity & Test Distance: Vertical at 3 M							
No.	Freq. (MHz)	Reading (dBm)	S.G Power Value (dBm)	Correction Factor (dB)	EIRP (dBm)	Limit (dBm)	Margin (dB)
1	1880.00	-7.3	31.1	1.1	32.2	33.0	-0.8

MODE		TX channel 810					
Antenna Polarity & Test Distance: Horizontal at 3 M							
No.	Freq. (MHz)	Reading (dBm)	S.G Power Value (dBm)	Correction Factor (dB)	EIRP (dBm)	Limit (dBm)	Margin (dB)
1	1909.80	-13.9	25.8	1.1	26.9	33.0	-6.1
Antenna Polarity & Test Distance: Vertical at 3 M							
No.	Freq. (MHz)	Reading (dBm)	S.G Power Value (dBm)	Correction Factor (dB)	EIRP (dBm)	Limit (dBm)	Margin (dB)
1	1909.80	-8.6	29.9	1.1	31.0	33.0	-2.0

Note: EIRP (dBm) = S.G Power Value (dBm) + Correction Factor (dB).

WCDMA Mode

MODE		TX channel 9262					
Antenna Polarity & Test Distance: Horizontal at 3 M							
No.	Freq. (MHz)	Reading (dBm)	S.G Power Value (dBm)	Correction Factor (dB)	EIRP (dBm)	Limit (dBm)	Margin (dB)
1	1852.40	-21.7	17.2	1.0	18.2	33.0	-14.8
Antenna Polarity & Test Distance: Vertical at 3 M							
No.	Freq. (MHz)	Reading (dBm)	S.G Power Value (dBm)	Correction Factor (dB)	EIRP (dBm)	Limit (dBm)	Margin (dB)
1	1852.40	-14.7	23.7	1.0	24.7	33.0	-8.3

MODE		TX channel 9400					
Antenna Polarity & Test Distance: Horizontal at 3 M							
No.	Freq. (MHz)	Reading (dBm)	S.G Power Value (dBm)	Correction Factor (dB)	EIRP (dBm)	Limit (dBm)	Margin (dB)
1	1880.00	-23.7	15.6	1.1	16.7	33.0	-16.3
Antenna Polarity & Test Distance: Vertical at 3 M							
No.	Freq. (MHz)	Reading (dBm)	S.G Power Value (dBm)	Correction Factor (dB)	EIRP (dBm)	Limit (dBm)	Margin (dB)
1	1880.00	-16.1	22.3	1.1	23.4	33.0	-9.6

MODE		TX channel 9538					
Antenna Polarity & Test Distance: Horizontal at 3 M							
No.	Freq. (MHz)	Reading (dBm)	S.G Power Value (dBm)	Correction Factor (dB)	EIRP (dBm)	Limit (dBm)	Margin (dB)
1	1907.60	-23.5	16.2	1.1	17.3	33.0	-15.7
Antenna Polarity & Test Distance: Vertical at 3 M							
No.	Freq. (MHz)	Reading (dBm)	S.G Power Value (dBm)	Correction Factor (dB)	EIRP (dBm)	Limit (dBm)	Margin (dB)
1	1907.60	-16.6	21.9	1.1	23.0	33.0	-10.0

Note: EIRP (dBm) = S.G Power Value (dBm) + Correction Factor (dB).

LTE Band 2, Channel Bandwidth: 1.4MHz

MODE		TX channel 18607					
Antenna Polarity & Test Distance: Horizontal at 3 M							
No.	Freq. (MHz)	Reading (dBm)	S.G Power Value (dBm)	Correction Factor (dB)	EIRP (dBm)	Limit (dBm)	Margin (dB)
1	1850.70	-18.8	21.1	1.0	22.1	33.0	-10.9
Antenna Polarity & Test Distance: Vertical at 3 M							
No.	Freq. (MHz)	Reading (dBm)	S.G Power Value (dBm)	Correction Factor (dB)	EIRP (dBm)	Limit (dBm)	Margin (dB)
1	1850.70	-9.3	29.5	1.0	30.5	33.0	-2.5

MODE		TX channel 18900					
Antenna Polarity & Test Distance: Horizontal at 3 M							
No.	Freq. (MHz)	Reading (dBm)	S.G Power Value (dBm)	Correction Factor (dB)	EIRP (dBm)	Limit (dBm)	Margin (dB)
1	1880.00	-18.8	21.3	1.1	22.4	33.0	-10.6
Antenna Polarity & Test Distance: Vertical at 3 M							
No.	Freq. (MHz)	Reading (dBm)	S.G Power Value (dBm)	Correction Factor (dB)	EIRP (dBm)	Limit (dBm)	Margin (dB)
1	1880.00	-9.8	28.7	1.1	29.8	33.0	-3.2

MODE		TX channel 19193					
Antenna Polarity & Test Distance: Horizontal at 3 M							
No.	Freq. (MHz)	Reading (dBm)	S.G Power Value (dBm)	Correction Factor (dB)	EIRP (dBm)	Limit (dBm)	Margin (dB)
1	1909.30	-18.9	21.5	1.1	22.6	33.0	-10.4
Antenna Polarity & Test Distance: Vertical at 3 M							
No.	Freq. (MHz)	Reading (dBm)	S.G Power Value (dBm)	Correction Factor (dB)	EIRP (dBm)	Limit (dBm)	Margin (dB)
1	1909.30	-9.5	28.9	1.1	30.0	33.0	-3.0

Note: EIRP (dBm) = S.G Power Value (dBm) + Correction Factor (dB).

LTE Band 2, Channel Bandwidth: 3MHz

MODE		TX channel 18615					
Antenna Polarity & Test Distance: Horizontal at 3 M							
No.	Freq. (MHz)	Reading (dBm)	S.G Power Value (dBm)	Correction Factor (dB)	EIRP (dBm)	Limit (dBm)	Margin (dB)
1	1851.50	-18.3	21.6	1.0	22.6	33.0	-10.4
Antenna Polarity & Test Distance: Vertical at 3 M							
No.	Freq. (MHz)	Reading (dBm)	S.G Power Value (dBm)	Correction Factor (dB)	EIRP (dBm)	Limit (dBm)	Margin (dB)
1	1851.50	-11.2	27.6	1.0	28.6	33.0	-4.4

MODE		TX channel 18900					
Antenna Polarity & Test Distance: Horizontal at 3 M							
No.	Freq. (MHz)	Reading (dBm)	S.G Power Value (dBm)	Correction Factor (dB)	EIRP (dBm)	Limit (dBm)	Margin (dB)
1	1880.00	-17.1	23.0	1.1	24.1	33.0	-8.9
Antenna Polarity & Test Distance: Vertical at 3 M							
No.	Freq. (MHz)	Reading (dBm)	S.G Power Value (dBm)	Correction Factor (dB)	EIRP (dBm)	Limit (dBm)	Margin (dB)
1	1880.00	-11.5	27.0	1.1	28.1	33.0	-4.9

MODE		TX channel 19185					
Antenna Polarity & Test Distance: Horizontal at 3 M							
No.	Freq. (MHz)	Reading (dBm)	S.G Power Value (dBm)	Correction Factor (dB)	EIRP (dBm)	Limit (dBm)	Margin (dB)
1	1908.50	-18.6	21.8	1.1	22.9	33.0	-10.1
Antenna Polarity & Test Distance: Vertical at 3 M							
No.	Freq. (MHz)	Reading (dBm)	S.G Power Value (dBm)	Correction Factor (dB)	EIRP (dBm)	Limit (dBm)	Margin (dB)
1	1908.50	-11.3	27.1	1.1	28.2	33.0	-4.8

Note: EIRP (dBm) = S.G Power Value (dBm) + Correction Factor (dB).

LTE Band 2, Channel Bandwidth: 5MHz

MODE		TX channel 18625					
Antenna Polarity & Test Distance: Horizontal at 3 M							
No.	Freq. (MHz)	Reading (dBm)	S.G Power Value (dBm)	Correction Factor (dB)	EIRP (dBm)	Limit (dBm)	Margin (dB)
1	1852.50	-18.4	21.5	1.0	22.5	33.0	-10.5
Antenna Polarity & Test Distance: Vertical at 3 M							
No.	Freq. (MHz)	Reading (dBm)	S.G Power Value (dBm)	Correction Factor (dB)	EIRP (dBm)	Limit (dBm)	Margin (dB)
1	1852.50	-10.3	28.5	1.0	29.5	33.0	-3.5

MODE		TX channel 18900					
Antenna Polarity & Test Distance: Horizontal at 3 M							
No.	Freq. (MHz)	Reading (dBm)	S.G Power Value (dBm)	Correction Factor (dB)	EIRP (dBm)	Limit (dBm)	Margin (dB)
1	1880.00	-16.9	23.2	1.1	24.3	33.0	-8.7
Antenna Polarity & Test Distance: Vertical at 3 M							
No.	Freq. (MHz)	Reading (dBm)	S.G Power Value (dBm)	Correction Factor (dB)	EIRP (dBm)	Limit (dBm)	Margin (dB)
1	1880.00	-11.0	27.5	1.1	28.6	33.0	-4.4

MODE		TX channel 19175					
Antenna Polarity & Test Distance: Horizontal at 3 M							
No.	Freq. (MHz)	Reading (dBm)	S.G Power Value (dBm)	Correction Factor (dB)	EIRP (dBm)	Limit (dBm)	Margin (dB)
1	1907.50	-17.6	22.8	1.1	23.9	33.0	-9.1
Antenna Polarity & Test Distance: Vertical at 3 M							
No.	Freq. (MHz)	Reading (dBm)	S.G Power Value (dBm)	Correction Factor (dB)	EIRP (dBm)	Limit (dBm)	Margin (dB)
1	1907.50	-11.5	26.9	1.1	28.0	33.0	-5.0

Note: EIRP (dBm) = S.G Power Value (dBm) + Correction Factor (dB).

LTE Band 2, Channel Bandwidth: 10MHz

MODE		TX channel 18650					
Antenna Polarity & Test Distance: Horizontal at 3 M							
No.	Freq. (MHz)	Reading (dBm)	S.G Power Value (dBm)	Correction Factor (dB)	EIRP (dBm)	Limit (dBm)	Margin (dB)
1	1855.00	-18.5	21.5	1.0	22.5	33.0	-10.5
Antenna Polarity & Test Distance: Vertical at 3 M							
No.	Freq. (MHz)	Reading (dBm)	S.G Power Value (dBm)	Correction Factor (dB)	EIRP (dBm)	Limit (dBm)	Margin (dB)
1	1855.00	-11.7	27.1	1.0	28.1	33.0	-4.9

MODE		TX channel 18900					
Antenna Polarity & Test Distance: Horizontal at 3 M							
No.	Freq. (MHz)	Reading (dBm)	S.G Power Value (dBm)	Correction Factor (dB)	EIRP (dBm)	Limit (dBm)	Margin (dB)
1	1880.00	-17.5	22.6	1.1	23.7	33.0	-9.3
Antenna Polarity & Test Distance: Vertical at 3 M							
No.	Freq. (MHz)	Reading (dBm)	S.G Power Value (dBm)	Correction Factor (dB)	EIRP (dBm)	Limit (dBm)	Margin (dB)
1	1880.00	-11.6	26.9	1.1	28.0	33.0	-5.0

MODE		TX channel 19150					
Antenna Polarity & Test Distance: Horizontal at 3 M							
No.	Freq. (MHz)	Reading (dBm)	S.G Power Value (dBm)	Correction Factor (dB)	EIRP (dBm)	Limit (dBm)	Margin (dB)
1	1905.00	-16.3	24.1	1.1	25.2	33.0	-7.8
Antenna Polarity & Test Distance: Vertical at 3 M							
No.	Freq. (MHz)	Reading (dBm)	S.G Power Value (dBm)	Correction Factor (dB)	EIRP (dBm)	Limit (dBm)	Margin (dB)
1	1905.00	-11.2	27.2	1.1	28.3	33.0	-4.7

Note: EIRP (dBm) = S.G Power Value (dBm) + Correction Factor (dB).

LTE Band 2, Channel Bandwidth: 15MHz

MODE		TX channel 18675					
Antenna Polarity & Test Distance: Horizontal at 3 M							
No.	Freq. (MHz)	Reading (dBm)	S.G Power Value (dBm)	Correction Factor (dB)	EIRP (dBm)	Limit (dBm)	Margin (dB)
1	1857.50	-18.2	21.7	1.1	22.8	33.0	-10.2
Antenna Polarity & Test Distance: Vertical at 3 M							
No.	Freq. (MHz)	Reading (dBm)	S.G Power Value (dBm)	Correction Factor (dB)	EIRP (dBm)	Limit (dBm)	Margin (dB)
1	1857.50	-11.9	26.8	1.1	27.9	33.0	-5.1

MODE		TX channel 18900					
Antenna Polarity & Test Distance: Horizontal at 3 M							
No.	Freq. (MHz)	Reading (dBm)	S.G Power Value (dBm)	Correction Factor (dB)	EIRP (dBm)	Limit (dBm)	Margin (dB)
1	1880.00	-16.5	23.6	1.1	24.7	33.0	-8.3
Antenna Polarity & Test Distance: Vertical at 3 M							
No.	Freq. (MHz)	Reading (dBm)	S.G Power Value (dBm)	Correction Factor (dB)	EIRP (dBm)	Limit (dBm)	Margin (dB)
1	1880.00	-11.8	26.7	1.1	27.8	33.0	-5.2

MODE		TX channel 19125					
Antenna Polarity & Test Distance: Horizontal at 3 M							
No.	Freq. (MHz)	Reading (dBm)	S.G Power Value (dBm)	Correction Factor (dB)	EIRP (dBm)	Limit (dBm)	Margin (dB)
1	1902.50	-16.9	23.5	1.1	24.6	33.0	-8.4
Antenna Polarity & Test Distance: Vertical at 3 M							
No.	Freq. (MHz)	Reading (dBm)	S.G Power Value (dBm)	Correction Factor (dB)	EIRP (dBm)	Limit (dBm)	Margin (dB)
1	1902.50	-10.1	28.3	1.1	29.4	33.0	-3.6

Note: EIRP (dBm) = S.G Power Value (dBm) + Correction Factor (dB).

LTE Band 2, Channel Bandwidth: 20MHz

MODE		TX channel 18700					
Antenna Polarity & Test Distance: Horizontal at 3 M							
No.	Freq. (MHz)	Reading (dBm)	S.G Power Value (dBm)	Correction Factor (dB)	EIRP (dBm)	Limit (dBm)	Margin (dB)
1	1860.00	-18.3	21.6	1.1	22.7	33.0	-10.3
Antenna Polarity & Test Distance: Vertical at 3 M							
No.	Freq. (MHz)	Reading (dBm)	S.G Power Value (dBm)	Correction Factor (dB)	EIRP (dBm)	Limit (dBm)	Margin (dB)
1	1860.00	-11.7	26.9	1.1	28.0	33.0	-5.0

MODE		TX channel 18900					
Antenna Polarity & Test Distance: Horizontal at 3 M							
No.	Freq. (MHz)	Reading (dBm)	S.G Power Value (dBm)	Correction Factor (dB)	EIRP (dBm)	Limit (dBm)	Margin (dB)
1	1880.00	-16.3	23.8	1.1	24.9	33.0	-8.1
Antenna Polarity & Test Distance: Vertical at 3 M							
No.	Freq. (MHz)	Reading (dBm)	S.G Power Value (dBm)	Correction Factor (dB)	EIRP (dBm)	Limit (dBm)	Margin (dB)
1	1880.00	-11.6	26.9	1.1	28.0	33.0	-5.0

MODE		TX channel 19100					
Antenna Polarity & Test Distance: Horizontal at 3 M							
No.	Freq. (MHz)	Reading (dBm)	S.G Power Value (dBm)	Correction Factor (dB)	EIRP (dBm)	Limit (dBm)	Margin (dB)
1	1900.00	-18.1	22.3	1.1	23.4	33.0	-9.6
Antenna Polarity & Test Distance: Vertical at 3 M							
No.	Freq. (MHz)	Reading (dBm)	S.G Power Value (dBm)	Correction Factor (dB)	EIRP (dBm)	Limit (dBm)	Margin (dB)
1	1900.00	-10.1	28.2	1.1	29.3	33.0	-3.7

Note: EIRP (dBm) = S.G Power Value (dBm) + Correction Factor (dB).

4.2 Modulation Characteristics Measurement

4.2.1 Limits of Modulation Characteristics

N/A

4.2.2 Test Procedure

Connect the EUT to Communication Simulator via the antenna connector, The frequency band is set as EUT supported Modulation and Channels, the EUT output is matched with 50 ohm load, the waveform quality and constellation of the EUT was tested.

4.2.3 Test Setup



4.2.4 Test Results

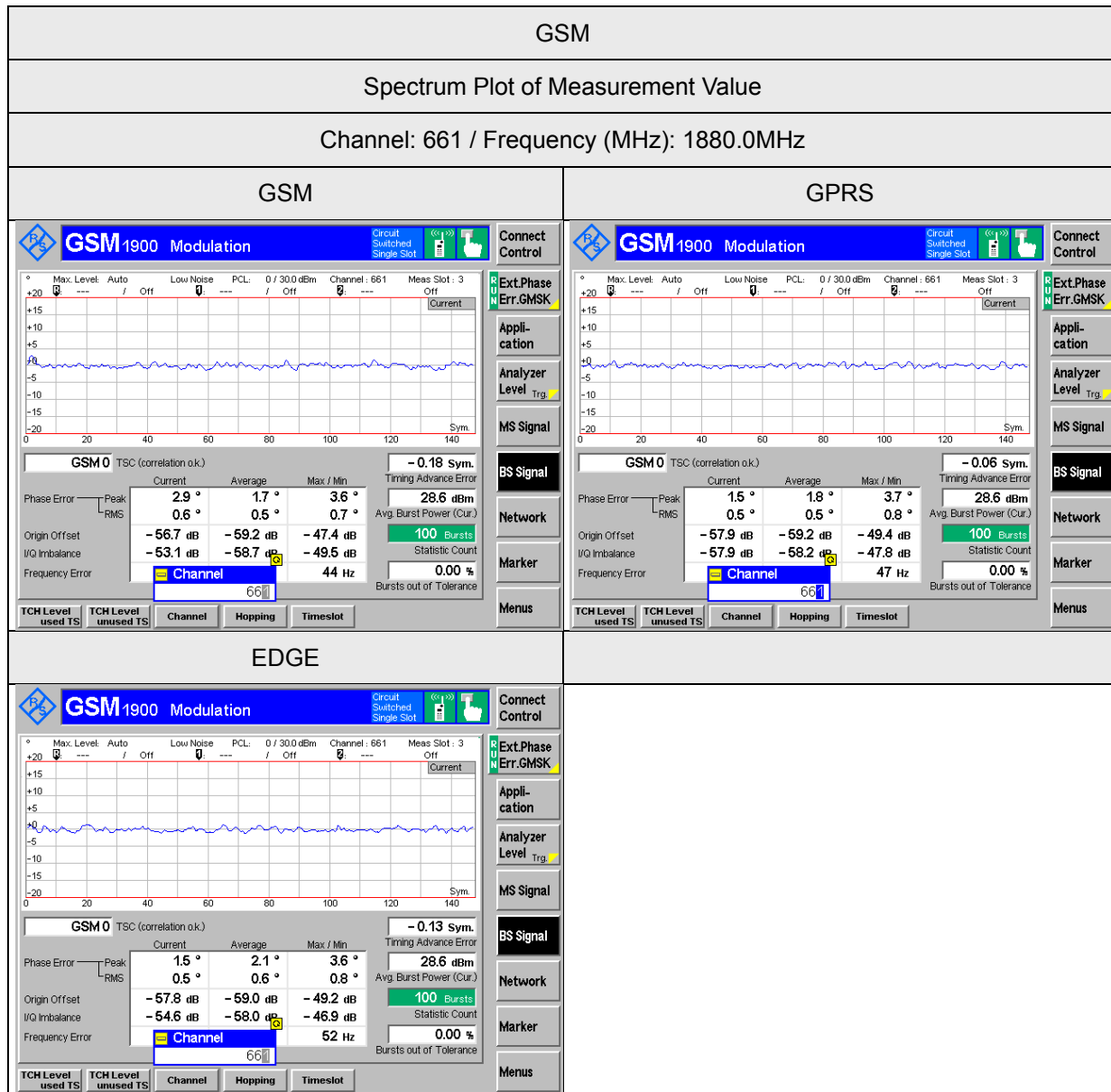

WCDMA Band 2

Spectrum Plot of Measurement Value

Channel: 9400 / Frequency (MHz): 1880.0MHz

WCDMA

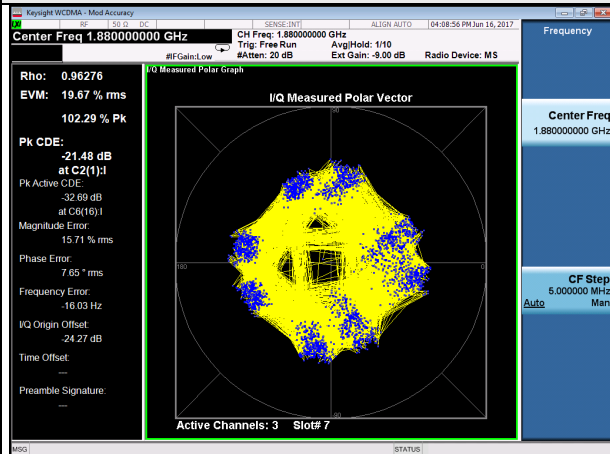

HSDPA

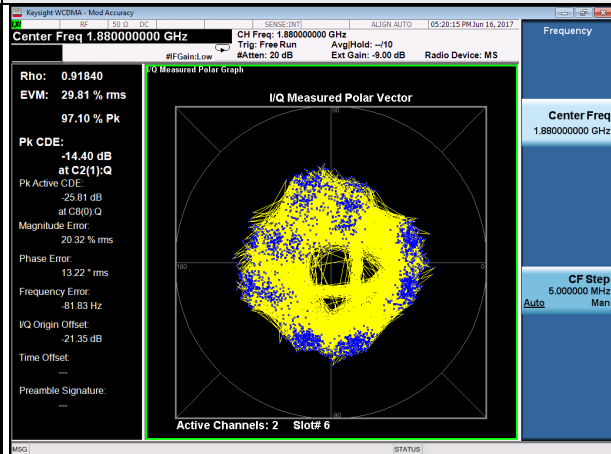

HSUPA

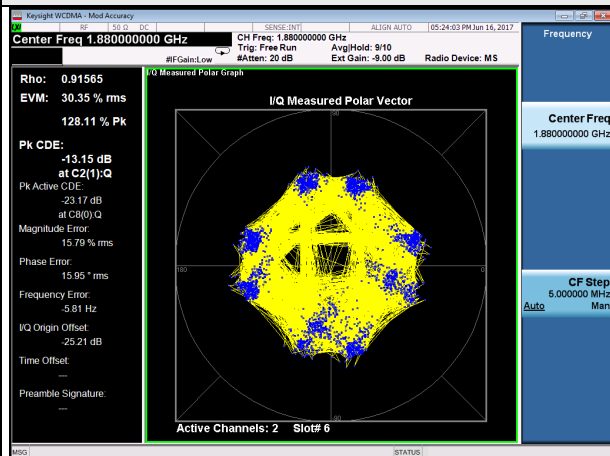

LTE Band 2

Spectrum Plot of Measurement Value

Channel: 18900 / Frequency (MHz): 1880.0MHz

Channel Bandwidth: 20MHz / QPSK

Channel Bandwidth: 20MHz / 16QAM

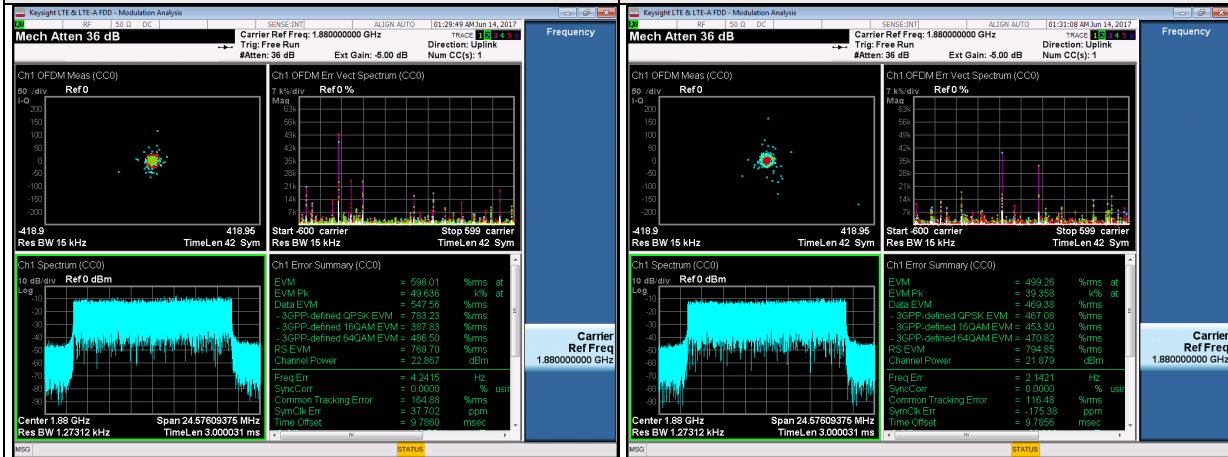

4.3 Frequency Stability Measurement

4.3.1 Limits of Frequency Stability Measurement

1.5 ppm is for base and fixed station. 2.5 ppm is for mobile station.

4.3.2 Test Procedure

- Device is placed at the oven room. The oven room could control the temperatures and humidity. Power warm up is at least 15 min and power applied should perform before recording frequency error.
- EUT is connected the external power supply to control the DC input power. The test voltage range is from minimum to maximum working voltage. Each step shall be record the frequency error rate.
- The temperature range step is 10 degrees in this test items. All temperature levels shall be hold the ± 0.5 °C during the measurement testing. The each temperature step shall be at least 0.5 hours, consider the EUT could be test under the stability condition.

NOTE: The frequency error was recorded frequency error from the communication simulator.

4.3.3 Test Setup

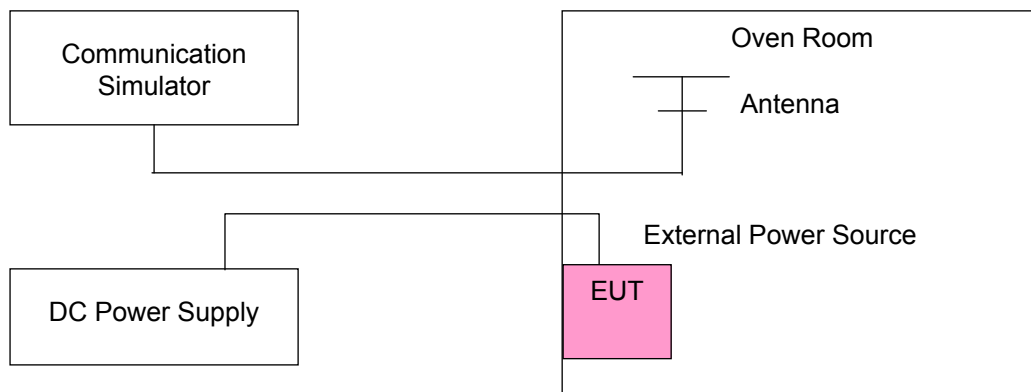

4.3.4 Test Results

Frequency Error vs. Voltage

Voltage (Volts)	Frequency Error (ppm)			Limit (ppm)
	GSM	WCDMA Band 2	LTE Band 2	
4.3	-0.004	-0.004	-0.003	2.5
3.8	-0.004	-0.003	-0.003	2.5
3.6	-0.004	-0.004	-0.003	2.5

Note: The applicant defined the normal working voltage is from 3.8Vdc to 4.3Vdc.

Frequency Error vs. Temperature.

Temp. (°C)	Frequency Error (ppm)			Limit (ppm)
	GSM	WCDMA Band 2	LTE Band 2	
50	-0.005	-0.004	-0.004	2.5
40	-0.005	-0.004	-0.003	2.5
30	-0.004	-0.003	-0.003	2.5
20	-0.004	-0.003	-0.003	2.5
10	-0.004	-0.004	-0.003	2.5
0	-0.005	-0.004	-0.004	2.5
-10	-0.006	-0.007	-0.006	2.5
-20	-0.006	-0.006	-0.006	2.5

4.4 Occupied Bandwidth Measurement

4.4.1 Test Procedure

The EUT makes a call to the communication simulator. All measurements were done at low, middle and high operational frequency range. The communication simulator station system controlled a EUT to export maximum output power under transmission mode and specific channel frequency. Use OBW measurement function of Spectrum analyzer to measure 99 % occupied bandwidth.

4.4.2 Test Setup

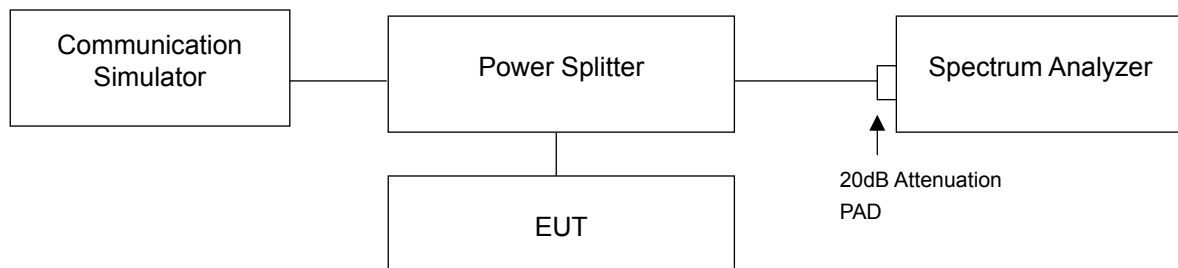

4.4.3 Test Result

Channel	Frequency (MHz)	99% Occupied Bandwidth (kHz)		
		GSM	GPRS	EDGE
512	1850.2	250	250	250
661	1880.0	260	260	250
810	1909.8	255	255	260

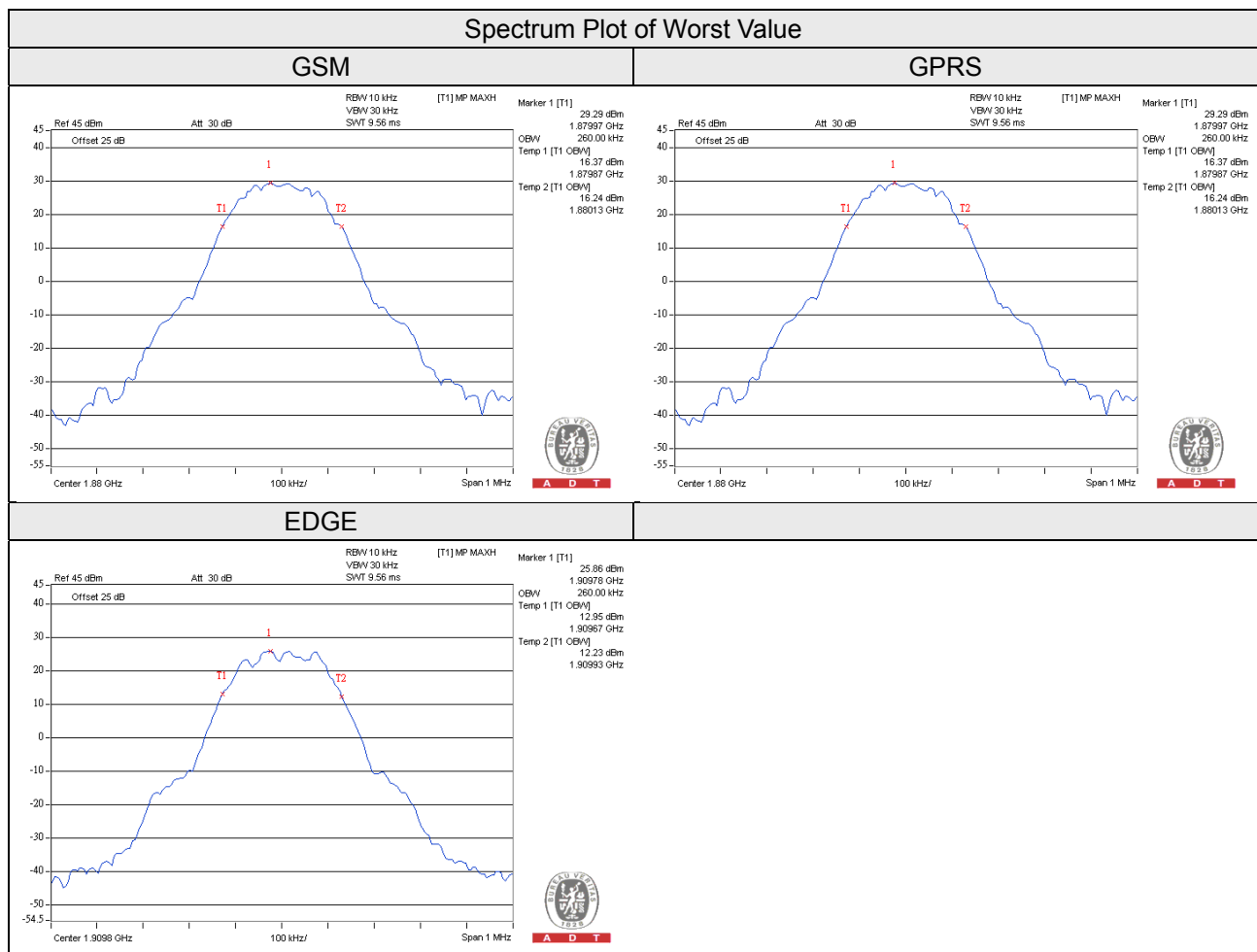

Channel	Frequency (MHz)	99% Occupied Bandwidth (MHz)		
		WCDMA	HSDPA	HSUPA
9262	1852.4	4.15	4.15	4.15
9400	1880.0	4.17	4.18	4.18
9538	1907.6	4.17	4.17	4.18

Spectrum Plot of Worst Value

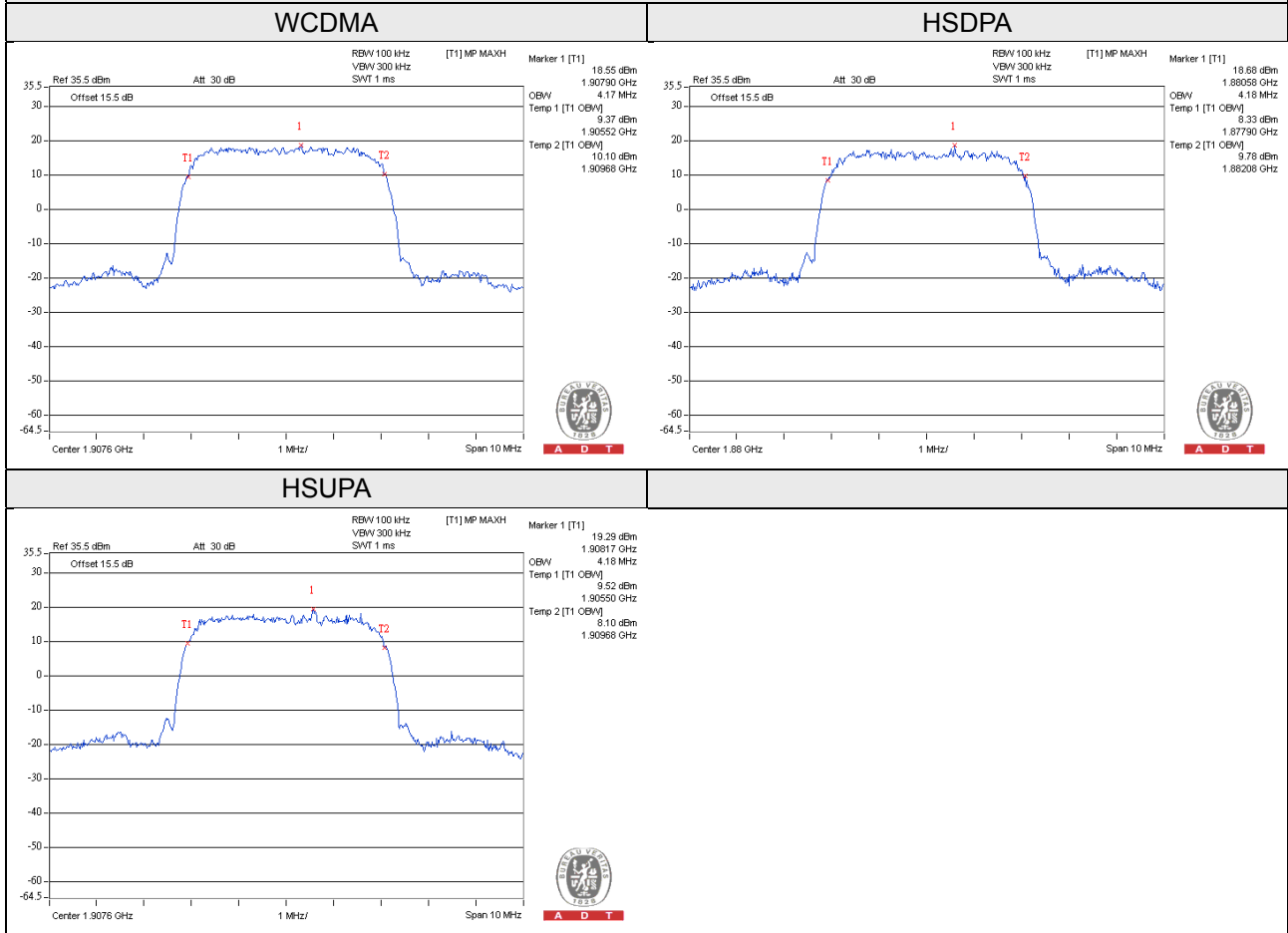

26dB Bandwidth

Channel	Frequency (MHz)	26dBc Bandwidth (kHz)		
		GSM	GPRS	EDGE
512	1850.2	316.01	317.75	312.48
661	1880.0	314.21	313.12	310.73
810	1909.8	316.30	308.88	313.28

Spectrum Plot of Worst Value

GSM

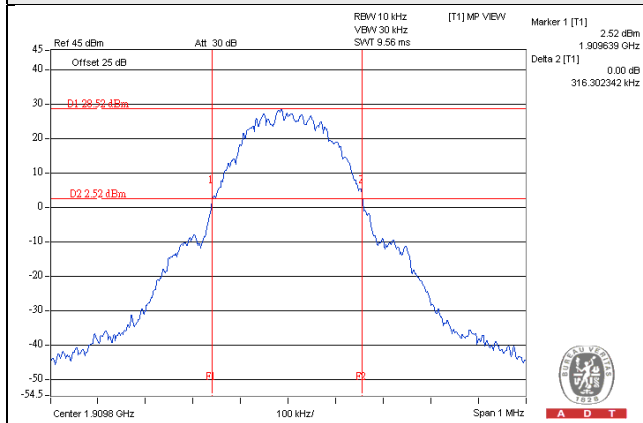

GPRS

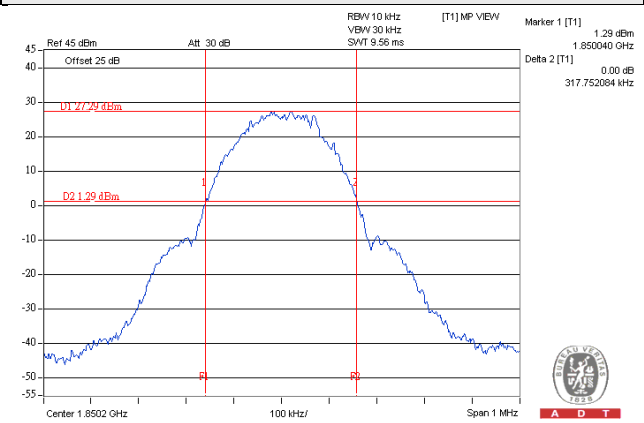

EDGE

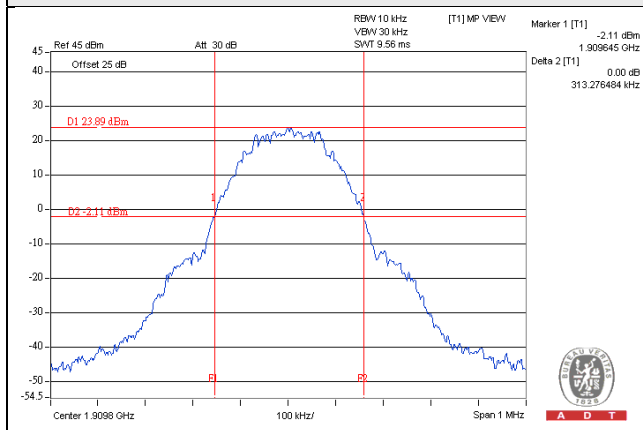

Channel	Frequency (MHz)	26dBc Bandwidth (MHz)		
		WCDMA	HSDPA	HSUPA
9262	1852.4	4.69	4.68	4.66
9400	1880.0	4.69	4.65	4.64
9538	1907.6	4.69	4.66	4.65

Spectrum Plot of Worst Value

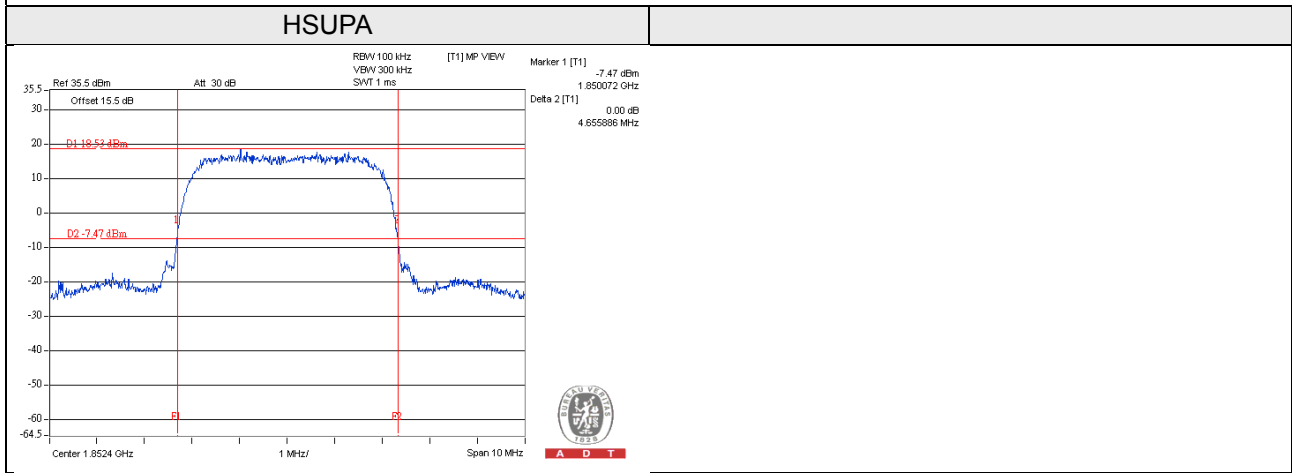
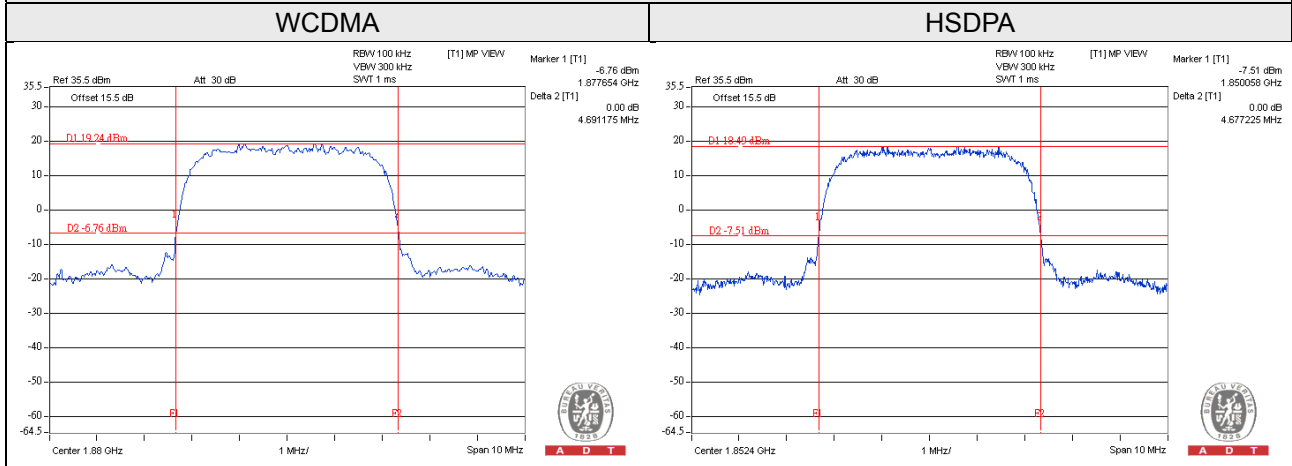

LTE Band 2, Channel Bandwidth 1.4MHz			
Channel	Frequency (MHz)	26dBc Bandwidth (MHz)	
		QPSK	16QAM
18607	1850.7	1.484	1.481
18900	1880.0	1.481	1.485
19193	1909.3	1.481	1.482

LTE Band 2, Channel Bandwidth 3MHz			
Channel	Frequency (MHz)	26dBc Bandwidth (MHz)	
		QPSK	16QAM
18615	1851.5	3.040	3.042
18900	1880.0	3.026	3.032
19185	1908.5	3.026	3.034

LTE Band 2, Channel Bandwidth 5MHz			
Channel	Frequency (MHz)	26dBc Bandwidth (MHz)	
		QPSK	16QAM
18625	1852.5	5.051	4.999
18900	1880.0	5.065	5.042
19175	1907.5	5.037	5.059

LTE Band 2, Channel Bandwidth 10MHz			
Channel	Frequency (MHz)	26dBc Bandwidth (MHz)	
		QPSK	16QAM
18650	1855.0	9.958	9.829
18900	1880.0	9.956	9.846
19150	1905.0	9.931	9.858

LTE Band 2, Channel Bandwidth 15MHz			
Channel	Frequency (MHz)	26dBc Bandwidth (MHz)	
		QPSK	16QAM
18675	1857.5	14.589	14.603
18900	1880.0	14.648	14.769
19125	1902.5	14.626	15.106

LTE Band 2, Channel Bandwidth 20MHz			
Channel	Frequency (MHz)	26dBc Bandwidth (MHz)	
		QPSK	16QAM
18700	1860.0	19.604	19.464
18900	1880.0	19.666	19.693
19100	1900.0	19.707	19.729

Spectrum Plot of Worst Value

1.4MHz / 16QAM

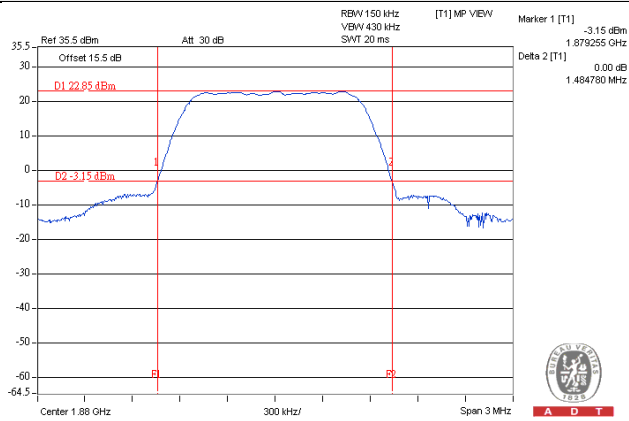

3MHz / 16QAM

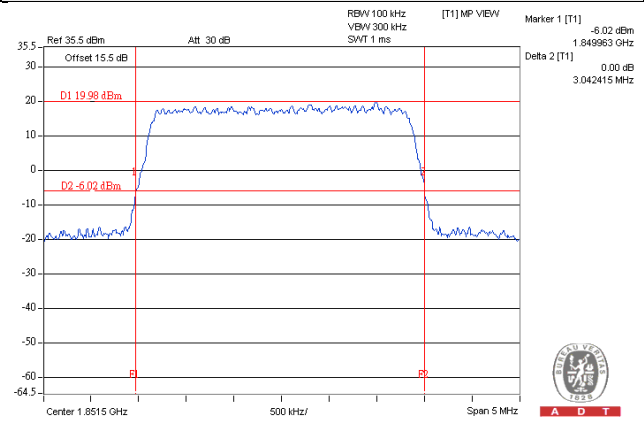

5MHz / QPSK

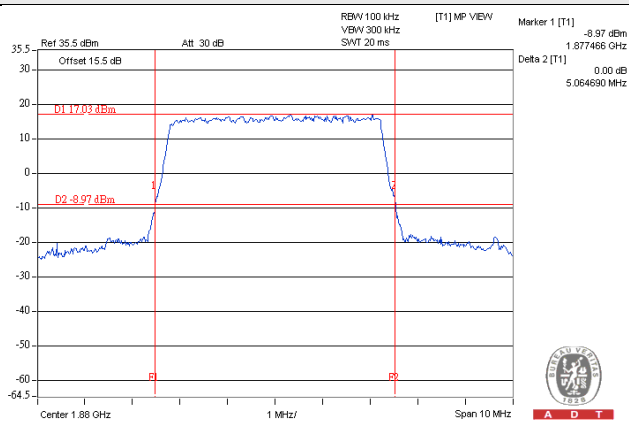

10MHz / QPSK

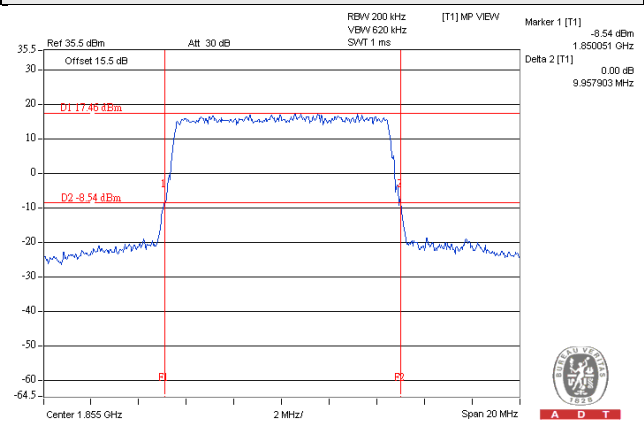

15MHz / 16QAM

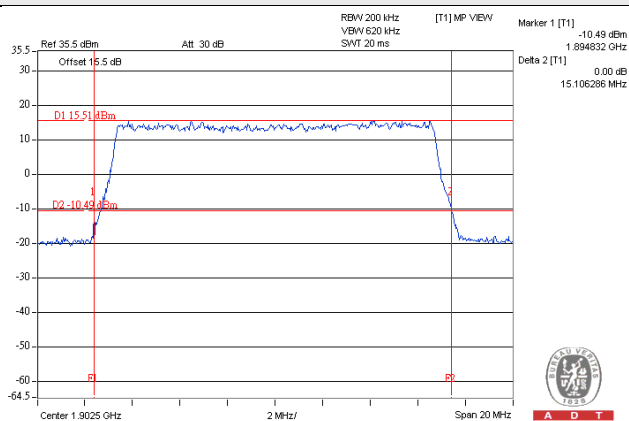

20MHz / 16QAM

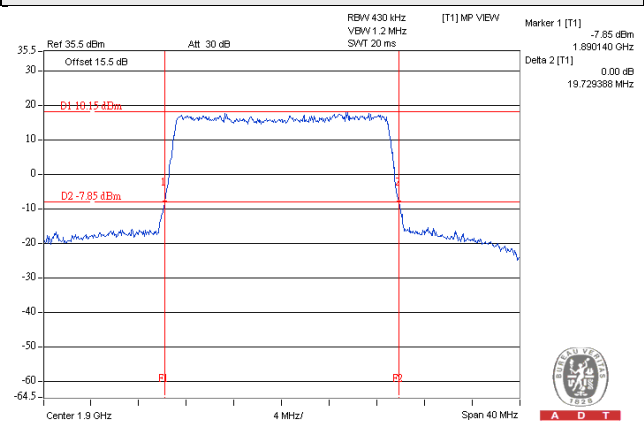

Occupied Bandwidth

LTE Band 2, Channel Bandwidth 1.4MHz			
Channel	Frequency (MHz)	99% Occupied Bandwidth (MHz)	
		QPSK	16QAM
18607	1850.7	1.09	1.09
18900	1880.0	1.09	1.09
19193	1909.3	1.09	1.08

LTE Band 2, Channel Bandwidth 3MHz			
Channel	Frequency (MHz)	99% Occupied Bandwidth (MHz)	
		QPSK	16QAM
18615	1851.5	2.68	2.68
18900	1880.0	2.68	2.68
19185	1908.5	2.68	2.68

LTE Band 2, Channel Bandwidth 5MHz			
Channel	Frequency (MHz)	99% Occupied Bandwidth (MHz)	
		QPSK	16QAM
18625	1852.5	4.48	4.48
18900	1880.0	4.47	4.48
19175	1907.5	4.47	4.48

LTE Band 2, Channel Bandwidth 10MHz			
Channel	Frequency (MHz)	99% Occupied Bandwidth (MHz)	
		QPSK	16QAM
18650	1855.0	8.93	8.93
18900	1880.0	8.93	8.93
19150	1905.0	8.93	8.93

LTE Band 2, Channel Bandwidth 15MHz			
Channel	Frequency (MHz)	99% Occupied Bandwidth (MHz)	
		QPSK	16QAM
18675	1857.5	13.47	13.43
18900	1880.0	13.43	13.43
19125	1902.5	13.43	13.47

LTE Band 2, Channel Bandwidth 20MHz			
Channel	Frequency (MHz)	99% Occupied Bandwidth (MHz)	
		QPSK	16QAM
18700	1860.0	18.00	18.00
18900	1880.0	18.00	18.00
19100	1900.0	18.00	18.07

Spectrum Plot of Worst Value

1.4MHz / QPSK

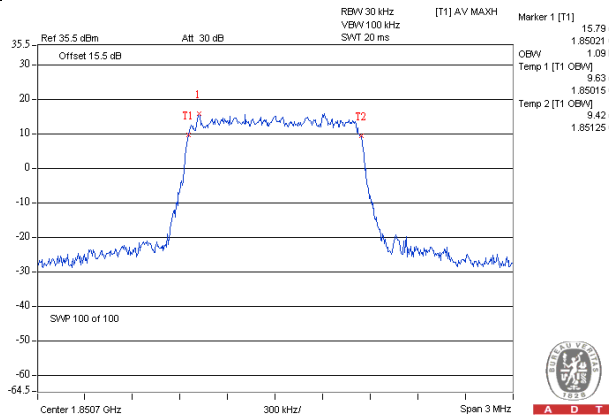

3MHz / QPSK

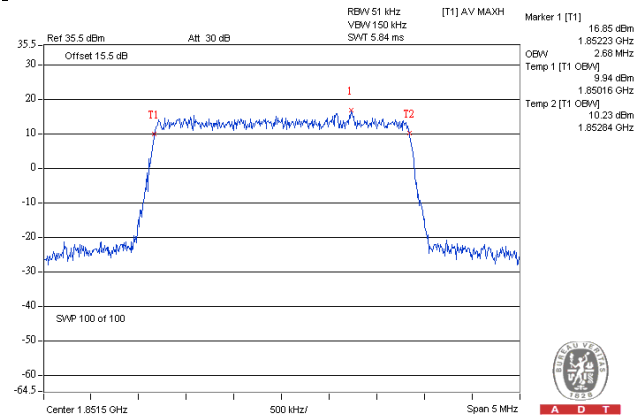

5MHz / QPSK

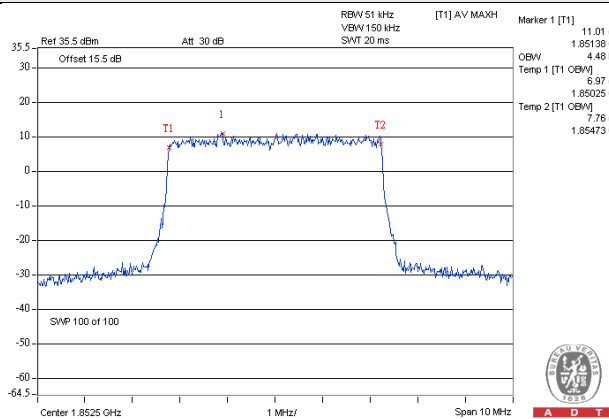

10MHz / QPSK

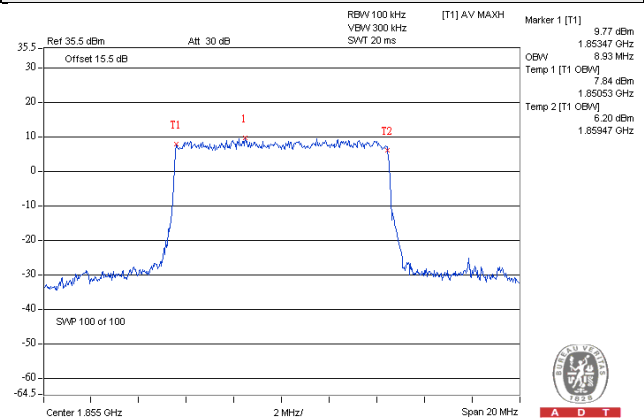

15MHz / QPSK

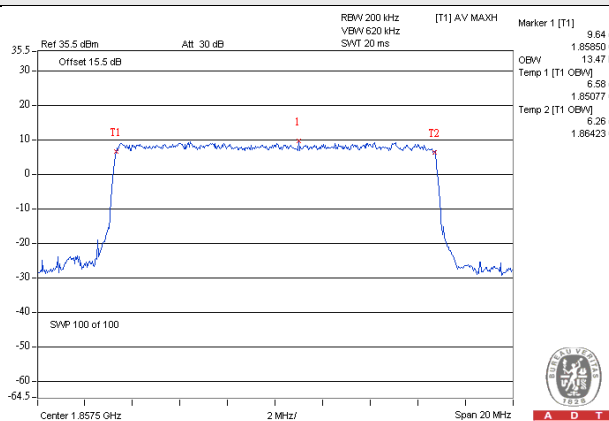

20MHz / 16QAM

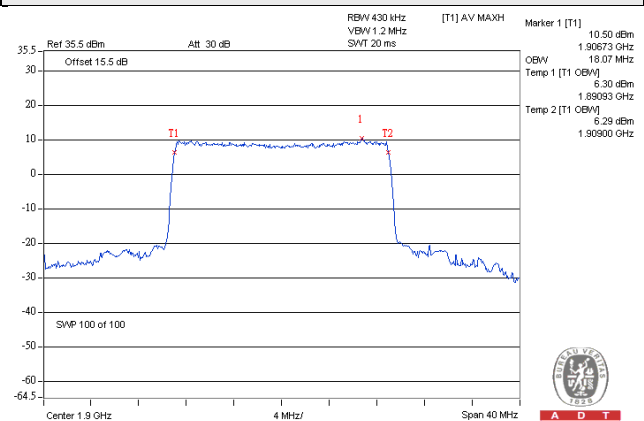

4.5 Band Edge Measurement

4.5.1 Limits of Band Edge Measurement

Power of any emission outside of the authorized operating frequency ranges must be attenuated below the transmitting power (P) by a factor of at least $43 + 10 \log(P)$ dB. In the 1 MHz bands immediately outside and adjacent to the frequency block a resolution bandwidth of at least one percent of the emission bandwidth of the fundamental emission of the transmitter may be employed.

4.5.2 Test Setup

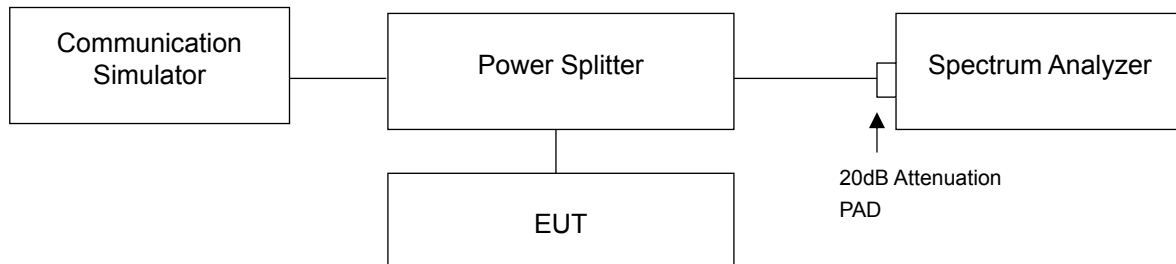

4.5.3 Test Procedures

- a. All measurements were done at low and high operational frequency range.
- b. The center frequency of spectrum is the band edge frequency and span is 1.5MHz. RB of the spectrum is 3kHz and VB of the spectrum is 10kHz (GSM / GPRS / EDGE).
- c. The center frequency of spectrum is the band edge frequency and span is 1.5MHz. RB of the spectrum is 100kHz and VB of the spectrum is 300kHz (WCDMA / HSDPA / HSUPA).
- d. The center frequency of spectrum is the band edge frequency and span is 1.5MHz. RB of the spectrum is 30kHz and VB of the spectrum is 100kHz (LTE Channel Bandwidth 1.4MHz and 3MHz).
- e. The center frequency of spectrum is the band edge frequency and span is 1.5MHz. RB of the spectrum is 51kHz and VB of the spectrum is 150kHz (LTE Channel Bandwidth 5MHz).
- f. The center frequency of spectrum is the band edge frequency and span is 1.5MHz. RB of the spectrum is 100kHz and VB of the spectrum is 300kHz (LTE Channel Bandwidth 10MHz).
- g. The center frequency of spectrum is the band edge frequency and span is 1MHz. RB of the spectrum is 200kHz and VB of the spectrum is 620kHz (LTE Channel Bandwidth 15MHz).
- h. The center frequency of spectrum is the band edge frequency and span is 1MHz. RB of the spectrum is 430kHz and VB of the spectrum is 1200kHz (LTE Channel Bandwidth 20MHz).
- i. Record the max trace plot into the test report.

4.5.4 Test Results

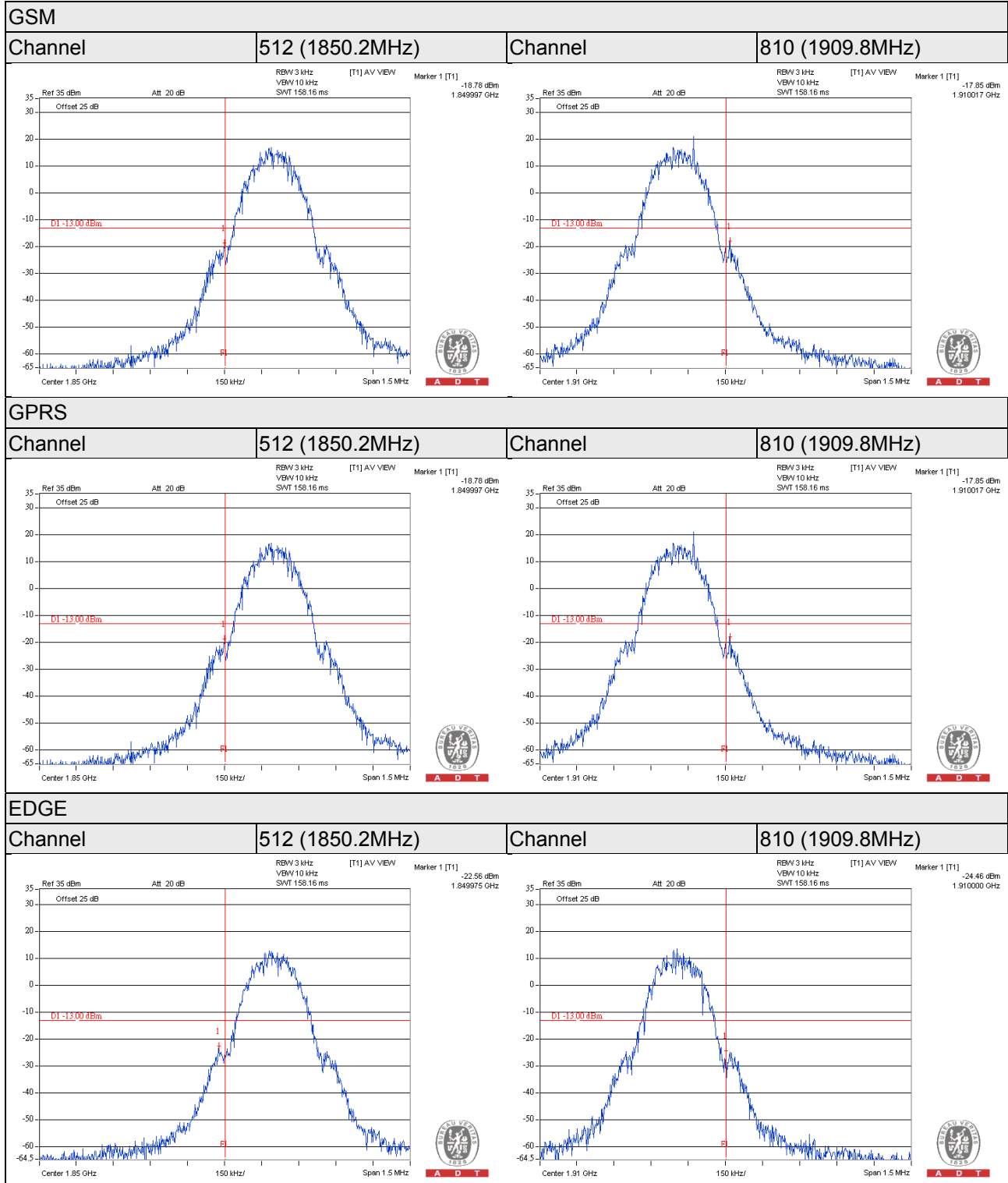

WCDMA

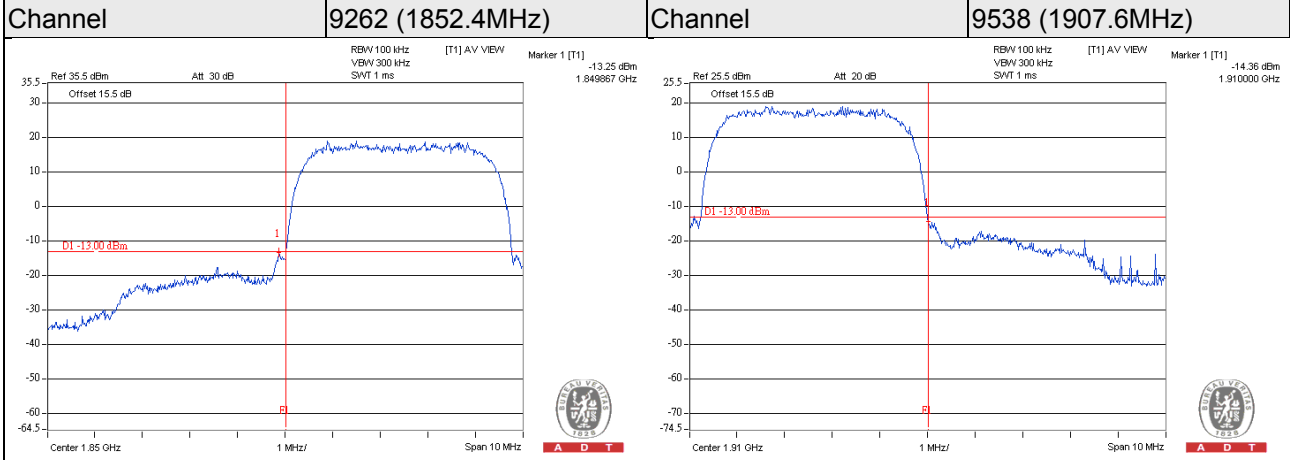

HSDPA

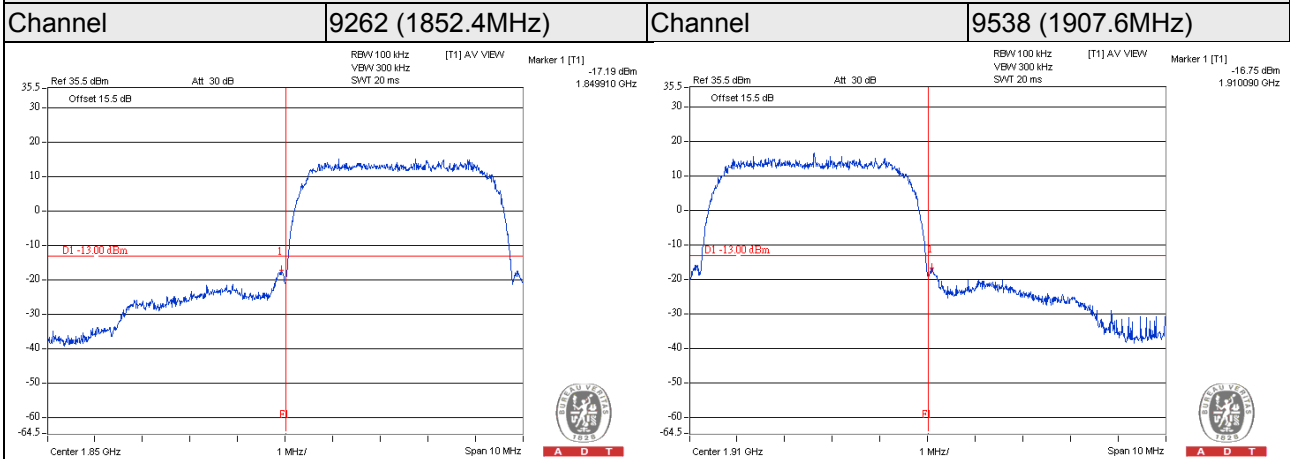

HSUPA

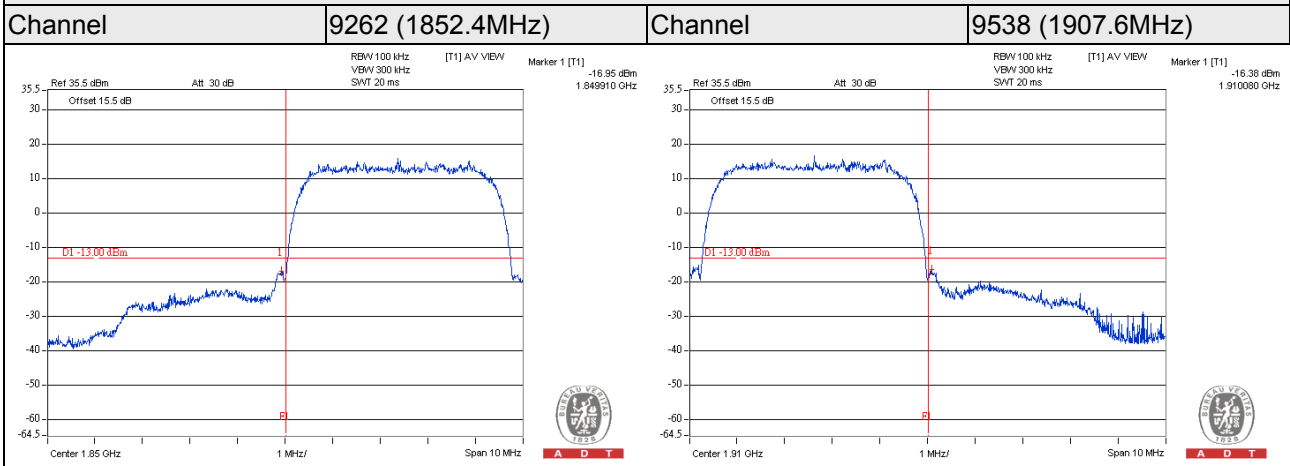

LTE Band 2, Channel Bandwidth 1.4MHz

Channel 18607 (1850.70MHz)	QPSK	1 RB / 0 RB Offset	Channel 19193 (1909.30MHz)	QPSK	1 RB / 5 RB Offset
---------------------------------------	-------------	---------------------------	---------------------------------------	-------------	---------------------------

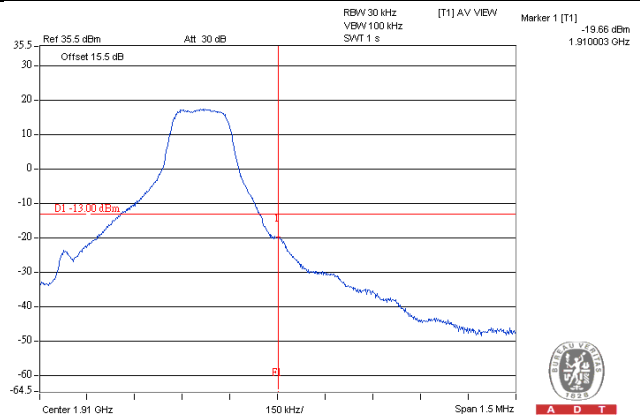
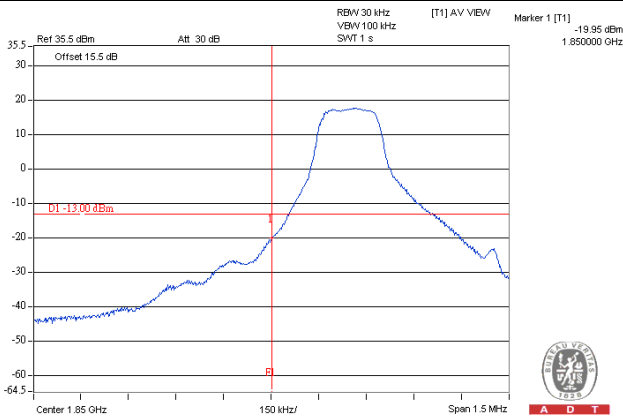

Channel 18607 (1850.70MHz)	QPSK	6 RB / 0 RB Offset	Channel 19193 (1909.30MHz)	QPSK	6 RB / 0 RB Offset
---------------------------------------	-------------	---------------------------	---------------------------------------	-------------	---------------------------

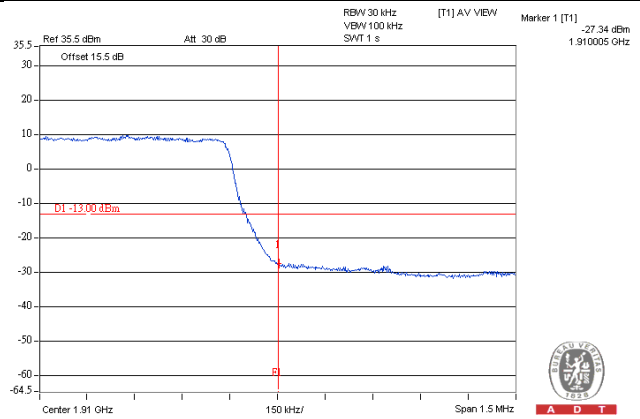
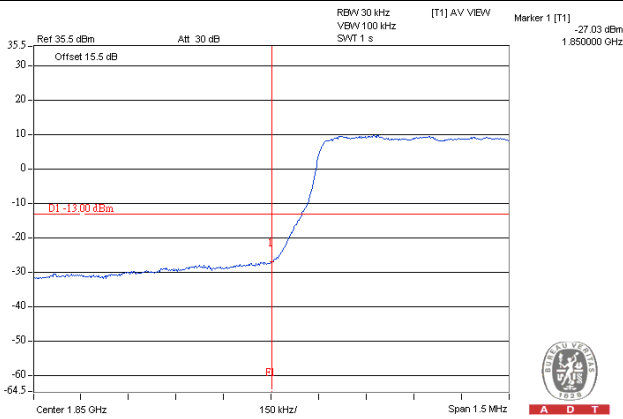

LTE Band 2, Channel Bandwidth 3MHz

Channel 18615 (1851.50MHz)	QPSK	1 RB / 0 RB Offset	Channel 19185 (1908.50MHz)	QPSK	1 RB / 14 RB Offset
---------------------------------------	-------------	---------------------------	---------------------------------------	-------------	----------------------------

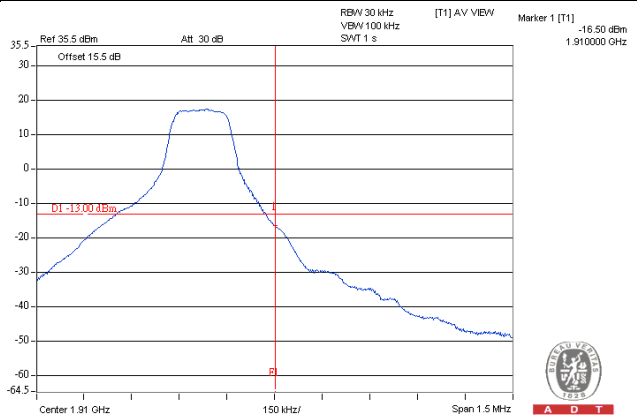
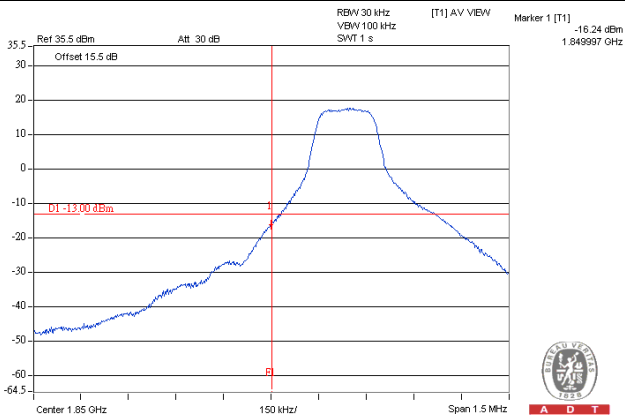

Channel 18615 (1851.50MHz)	QPSK	15 RB / 0 RB Offset	Channel 19185 (1908.50MHz)	QPSK	15 RB / 0 RB Offset
---------------------------------------	-------------	----------------------------	---------------------------------------	-------------	----------------------------

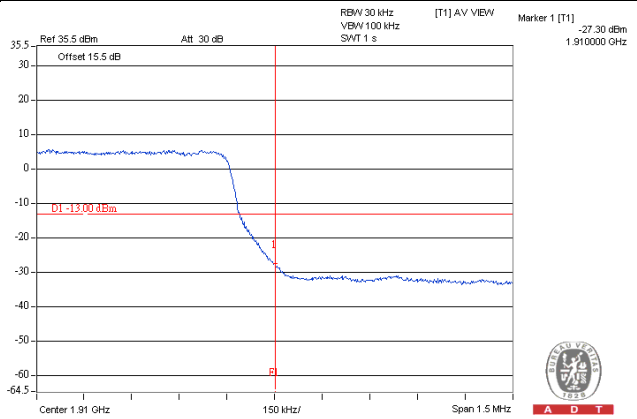
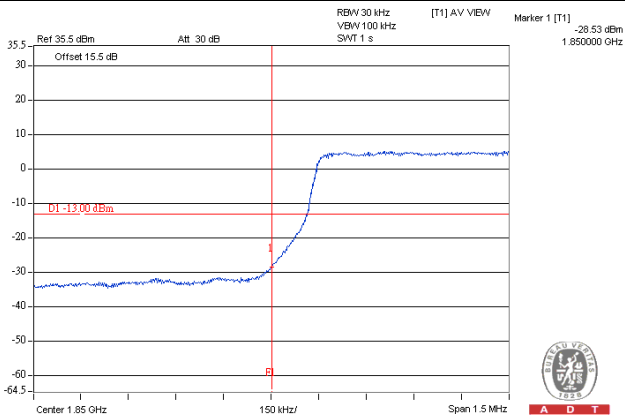

LTE Band 2, Channel Bandwidth 5MHz

Channel 18625 (1852.50MHz)	QPSK	1 RB / 0 RB Offset	Channel 19175 (1907.50MHz)	QPSK	1 RB / 24 RB Offset
---------------------------------------	-------------	---------------------------	---------------------------------------	-------------	----------------------------

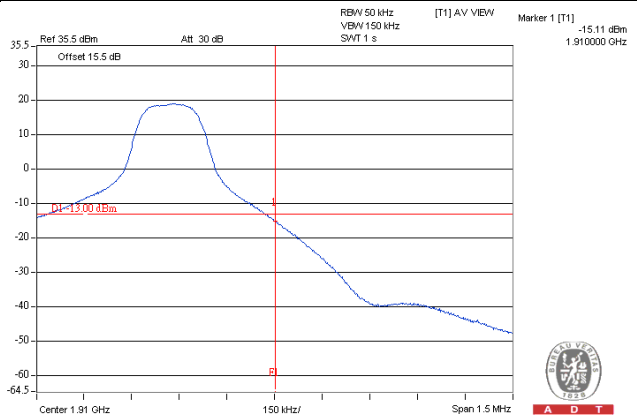
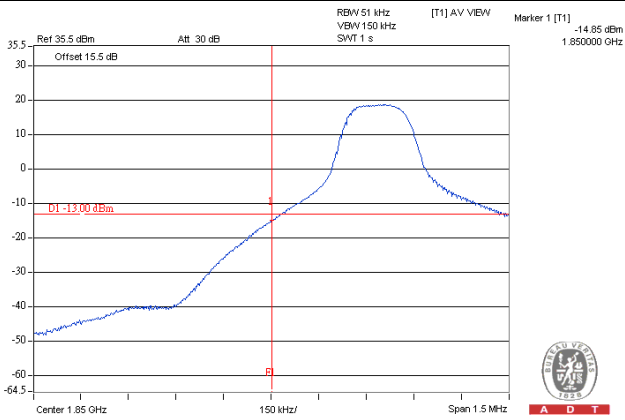

Channel 18625 (1852.50MHz)	QPSK	25 RB / 0 RB Offset	Channel 19175 (1907.50MHz)	QPSK	25 RB / 0 RB Offset
---------------------------------------	-------------	----------------------------	---------------------------------------	-------------	----------------------------

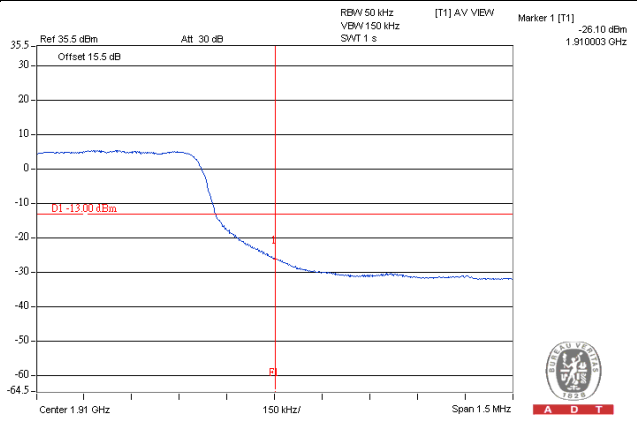
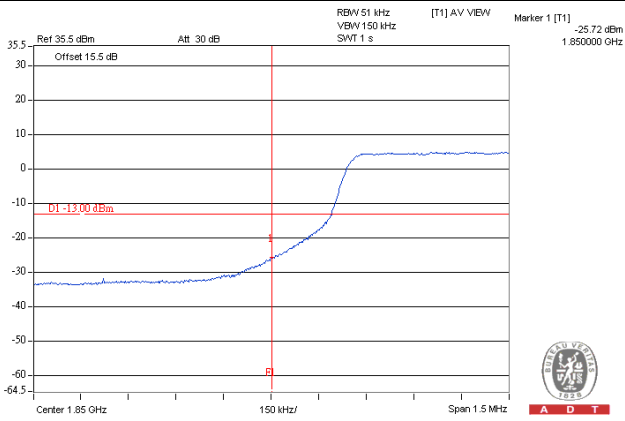

LTE Band 2, Channel Bandwidth 10MHz

Channel 18650 (1855.00MHz)	QPSK	1 RB / 0 RB Offset	Channel 19150 (1905.00MHz)	QPSK	1 RB / 49 RB Offset
---------------------------------------	-------------	---------------------------	---------------------------------------	-------------	----------------------------

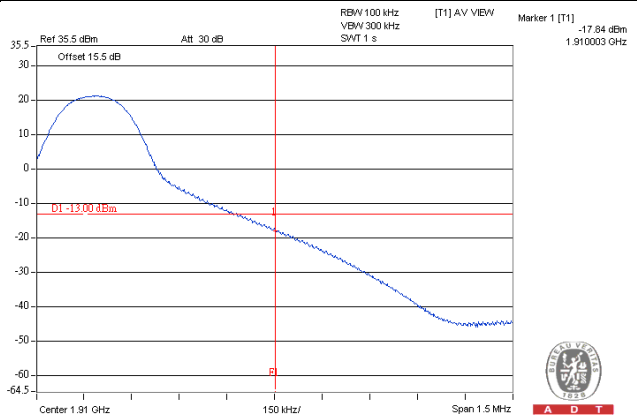
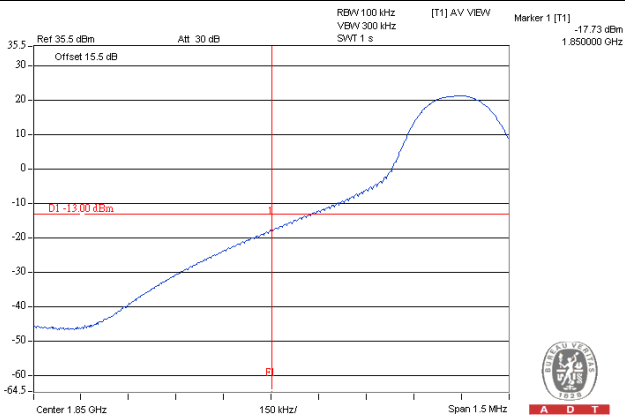

Channel 18650 (1855.00MHz)	QPSK	50 RB / 0 RB Offset	Channel 19150 (1905.00MHz)	QPSK	50 RB / 0 RB Offset
---------------------------------------	-------------	----------------------------	---------------------------------------	-------------	----------------------------

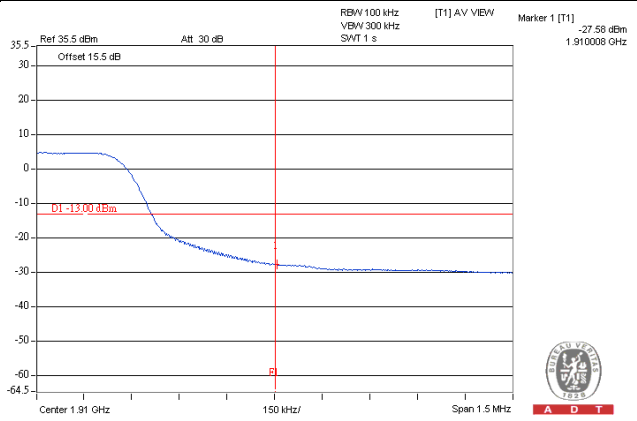
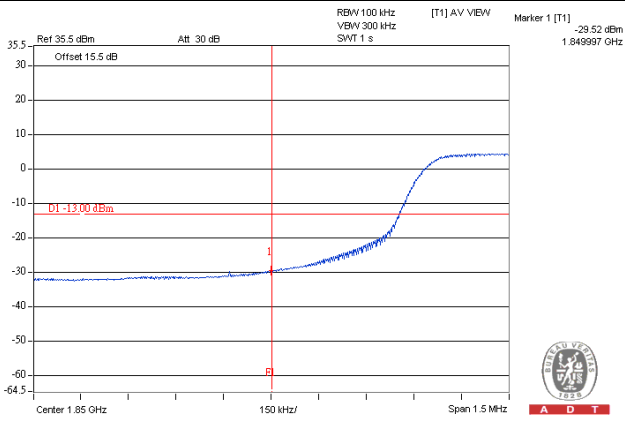

LTE Band 2, Channel Bandwidth 15MHz

Channel 18675 (1857.50MHz)	QPSK	1 RB / 0 RB Offset	Channel 19125 (1902.50MHz)	QPSK	1 RB / 74 RB Offset
---------------------------------------	-------------	---------------------------	---------------------------------------	-------------	----------------------------

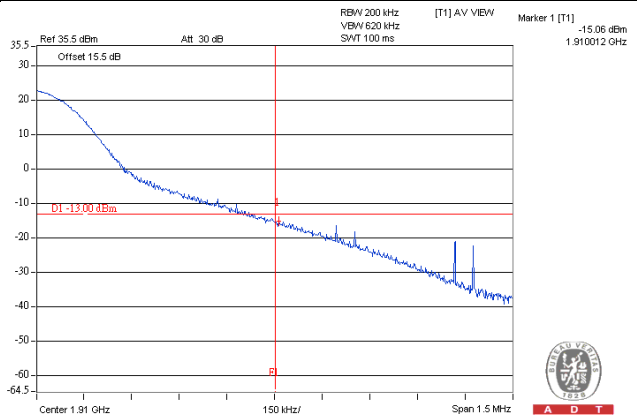
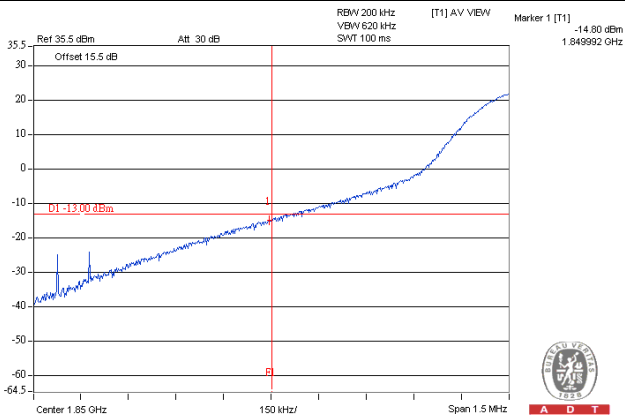

Channel 18675 (1857.50MHz)	QPSK	75 RB / 0 RB Offset	Channel 19125 (1902.50MHz)	QPSK	75 RB / 0 RB Offset
---------------------------------------	-------------	----------------------------	---------------------------------------	-------------	----------------------------

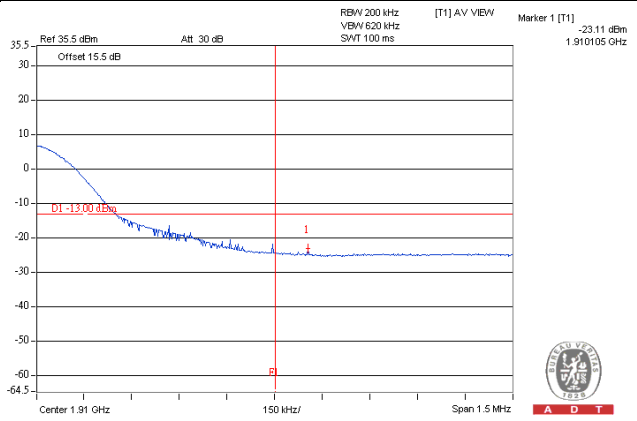
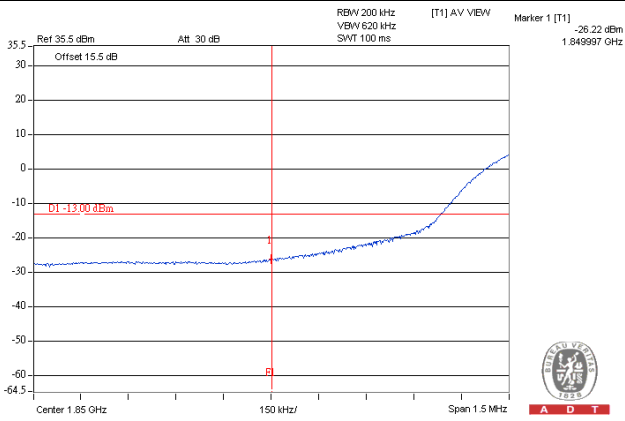

LTE Band 2, Channel Bandwidth 20MHz

Channel 18700 (1860.00MHz)	QPSK	1 RB / 0 RB Offset	Channel 19100 (1900.00 MHz)	QPSK	1 RB / 99 RB Offset
---------------------------------------	-------------	---------------------------	--	-------------	----------------------------

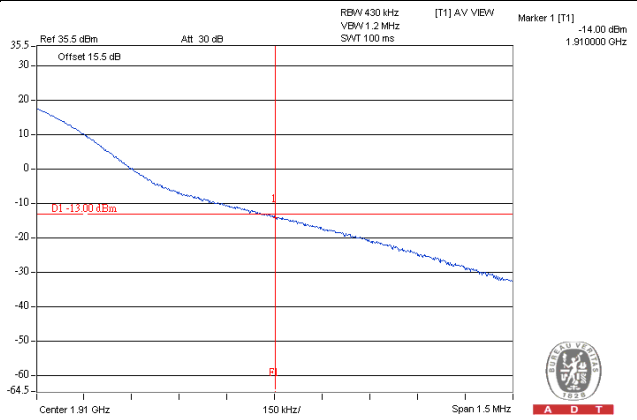
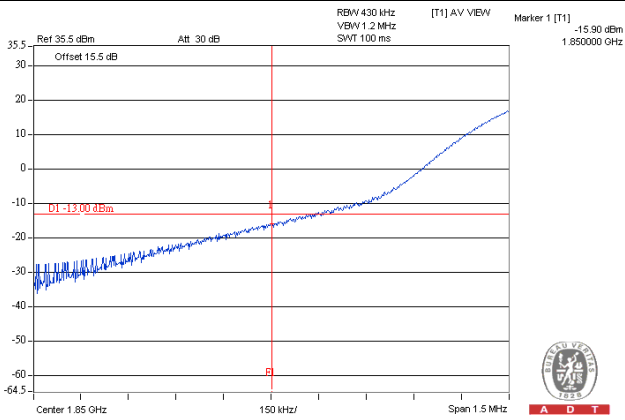

Channel 18700 (1860.00MHz)	QPSK	100 RB / 0 RB Offset	Channel 19100 (1900.00 MHz)	QPSK	100 RB / 0 RB Offset
---------------------------------------	-------------	-----------------------------	--	-------------	-----------------------------

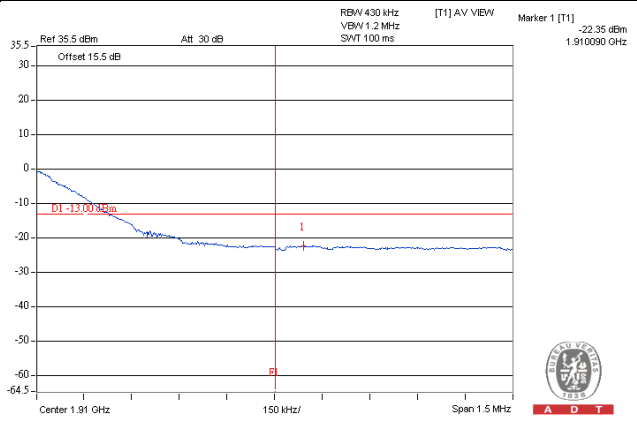
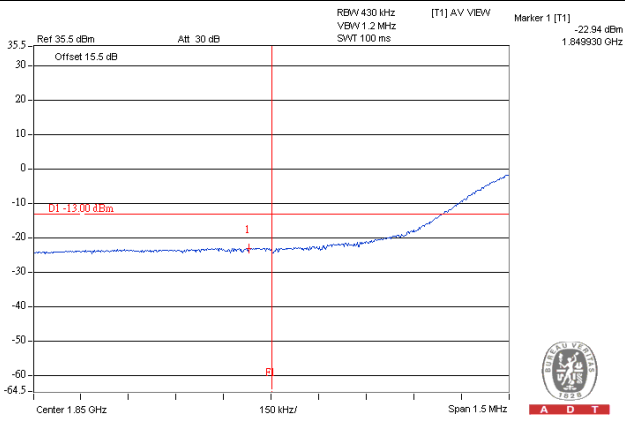

4.6 Peak to Average Ratio

4.6.1 Limits of Peak to Average Ratio Measurement

In measuring transmissions in this band using an average power technique, the peak to-average ratio (PAR) of the transmission may not exceed 13 dB

4.6.2 Test Setup

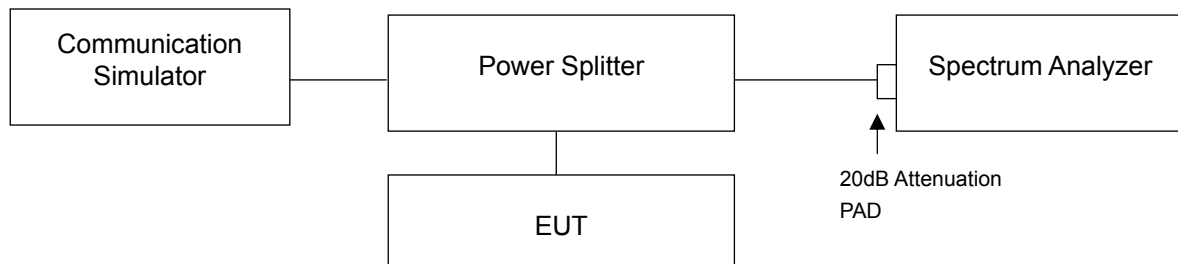

4.6.3 Test Procedures

- Set resolution/measurement bandwidth \geq signal's occupied bandwidth;
- Set the number of counts to a value that stabilizes the measured CCDF curve;
- Record the maximum PAPR level associated with a probability of 0.1%.

4.6.4 Test Results

Channel	Frequency (MHz)	Peak To Average Ratio (dB)		
		GSM	GPRS	EDGE
512	1850.2	5.55	2.83	3.37
661	1880.0	4.97	2.60	4.85
810	1909.8	4.96	3.02	3.25



Channel	Frequency (MHz)	Peak To Average Ratio (dB)		
		WCDMA	HSDPA	HSUPA
9262	1852.4	3.21	3.21	3.21
9400	1880.0	3.33	3.31	3.31
9538	1907.6	3.20	3.19	3.20

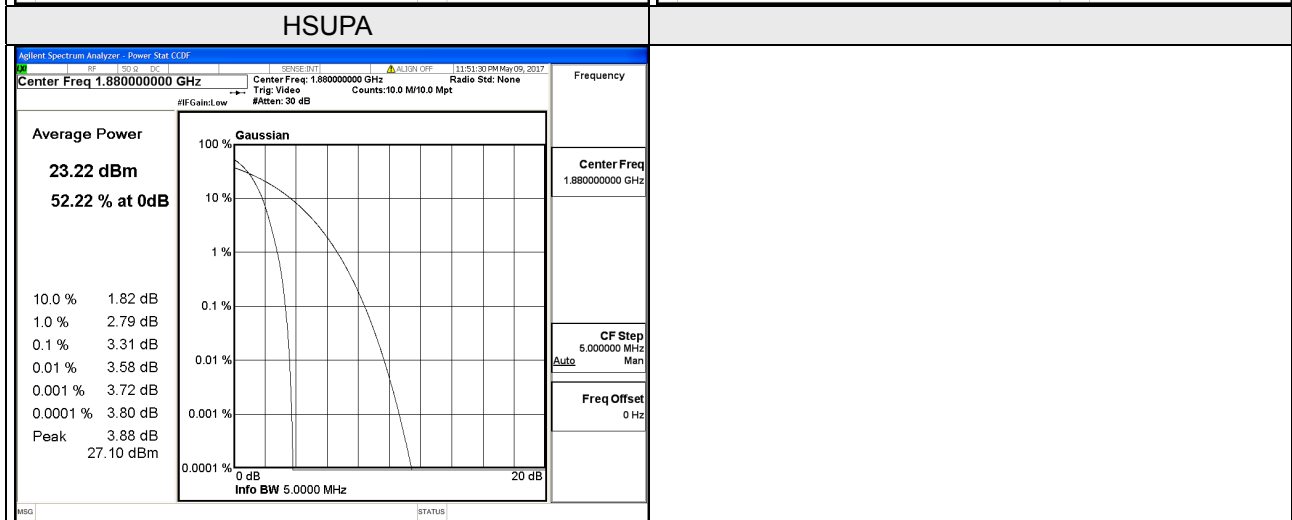
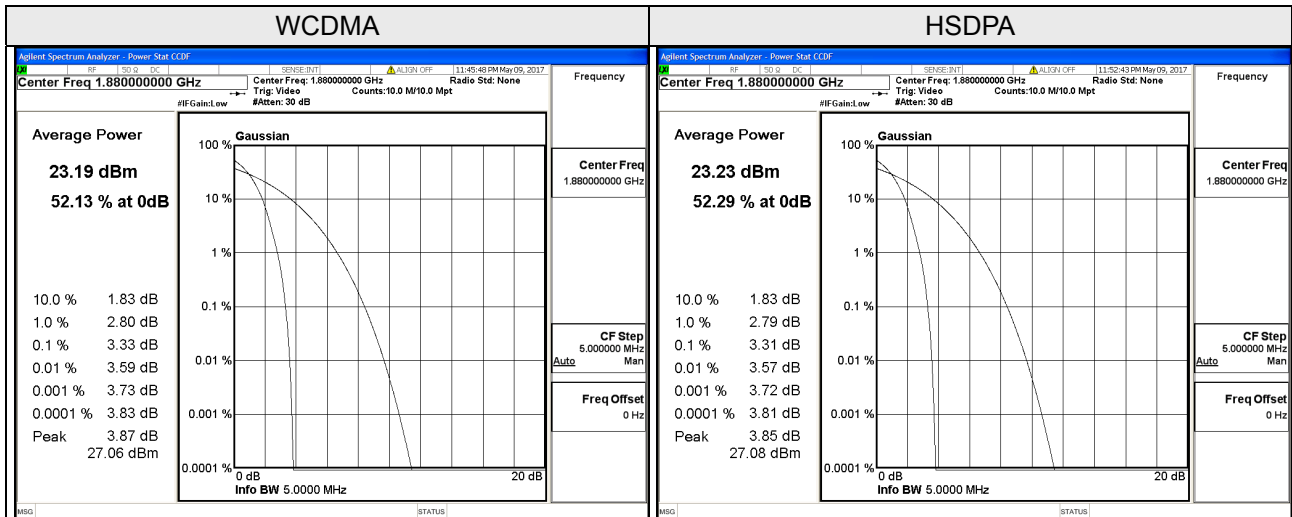

LTE Band 2, Channel Bandwidth 1.4MHz			
Channel	Frequency (MHz)	Peak To Average Ratio (dB)	
		QPSK	16QAM
18607	1850.7	5.23	5.95
18900	1880.0	5.70	6.44
19193	1909.3	5.25	6.01

LTE Band 2, Channel Bandwidth 3MHz			
Channel	Frequency (MHz)	Peak To Average Ratio (dB)	
		QPSK	16QAM
18615	1851.5	5.39	6.18
18900	1880.0	5.79	6.57
19185	1908.5	5.42	6.26

LTE Band 2, Channel Bandwidth 5MHz			
Channel	Frequency (MHz)	Peak To Average Ratio (dB)	
		QPSK	16QAM
18625	1852.5	5.57	6.22
18900	1880.0	5.79	6.47
19175	1907.5	5.69	6.30

LTE Band 2, Channel Bandwidth 10MHz			
Channel	Frequency (MHz)	Peak To Average Ratio (dB)	
		QPSK	16QAM
18650	1855.0	5.67	6.32
18900	1880.0	5.80	6.46
19150	1905.0	5.79	6.39

LTE Band 2, Channel Bandwidth 15MHz			
Channel	Frequency (MHz)	Peak To Average Ratio (dB)	
		QPSK	16QAM
18675	1857.5	5.67	6.36
18900	1880.0	5.77	6.46
19125	1902.5	5.79	6.36

LTE Band 2, Channel Bandwidth 20MHz			
Channel	Frequency (MHz)	Peak To Average Ratio (dB)	
		QPSK	16QAM
18700	1860.0	5.70	6.44
18900	1880.0	5.77	6.51
19100	1900.0	5.79	6.45

Spectrum Plot Of Worst Value

1.4MHz / 16QAM

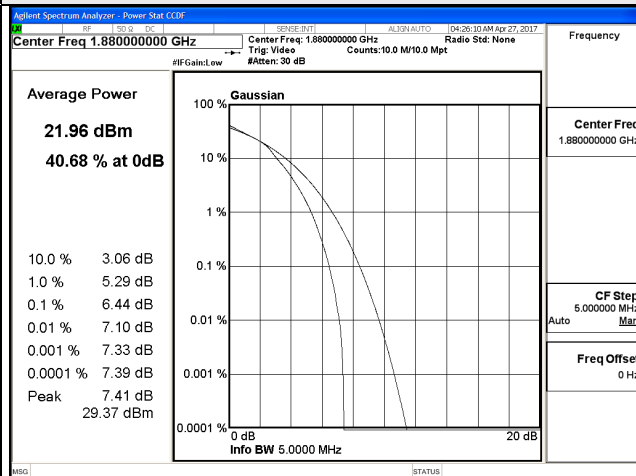

3MHz / 16QAM

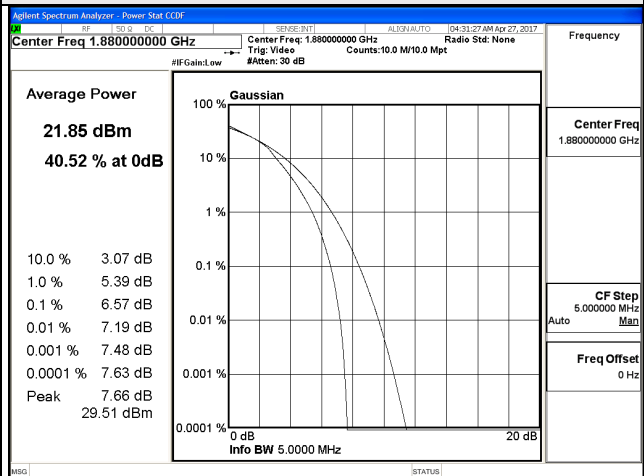

5MHz / 16QAM

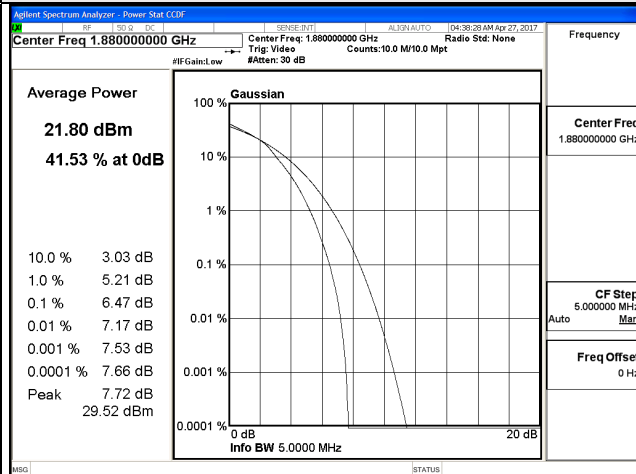

10MHz / 16QAM

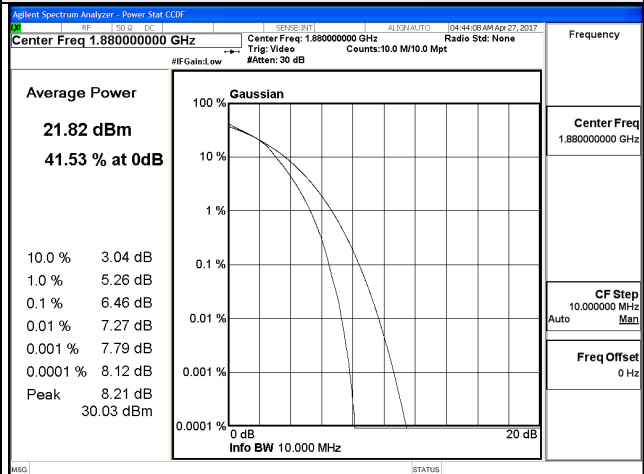

15MHz / 16QAM

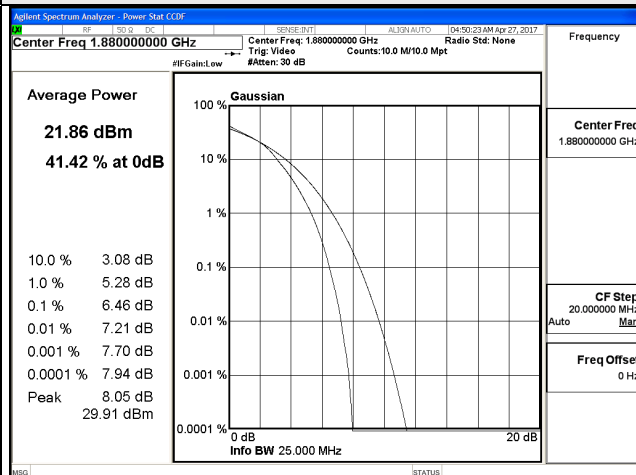

20MHz / 16QAM

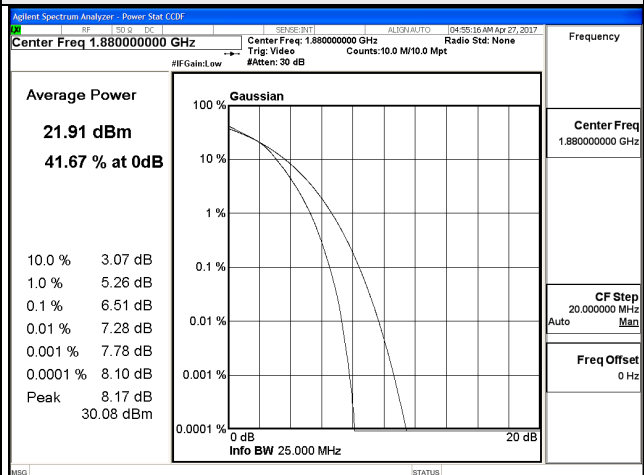

4.7 Conducted Spurious Emissions

4.7.1 Limits of Conducted Spurious Emissions Measurement

The power of any emission outside of the authorized operating frequency ranges must be attenuated below the transmitting power (P) by a factor of at least $43 + 10 \log(P)$ dB. The emission limit equal to -13dBm .

4.7.2 Test Setup

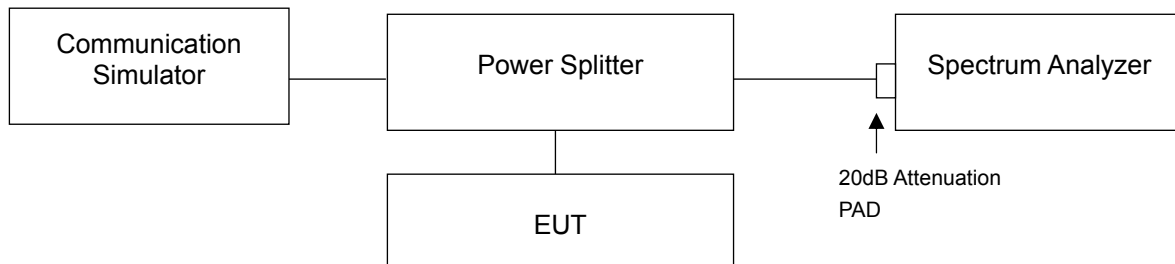

4.7.3 Test Procedure

- The EUT makes a phone call to the communication simulator. All measurements were done at low, middle and high operational frequency range.
- Measuring frequency range is from 9 kHz to 20GHz. 20dB attenuation pad is connected with spectrum. RBW=1MHz and VBW=3MHz is used for conducted emission measurement.

4.7.4 Test Results

GSM

Channel 512 (1850.2MHz)

Frequency Range : 9kHz~3GHz

Frequency Range : 3GHz~10GHz

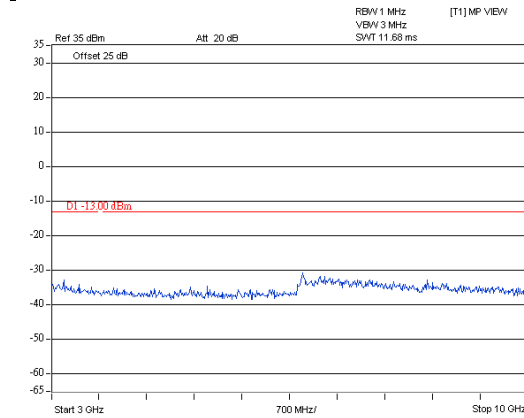
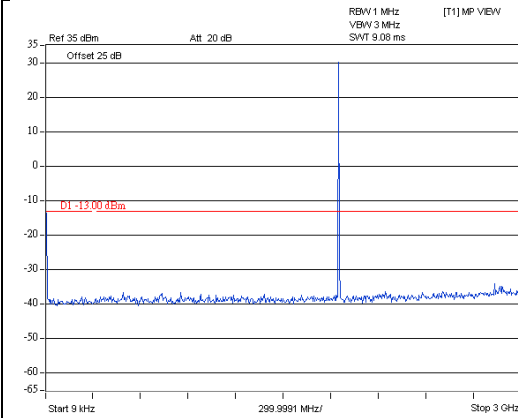

Frequency Range : 10GHz~20GHz

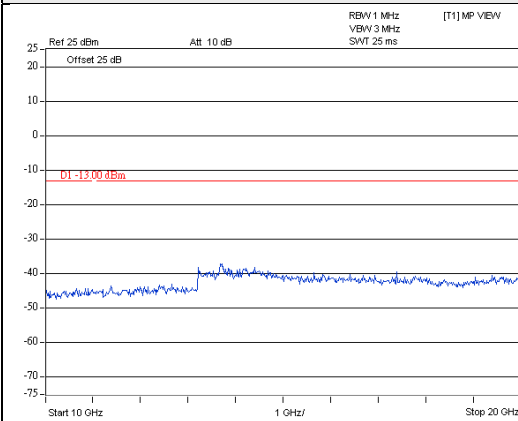

GSM

Channel 661 (1880.0MHz)

Frequency Range : 9kHz~3GHz

Frequency Range : 3GHz~10GHz

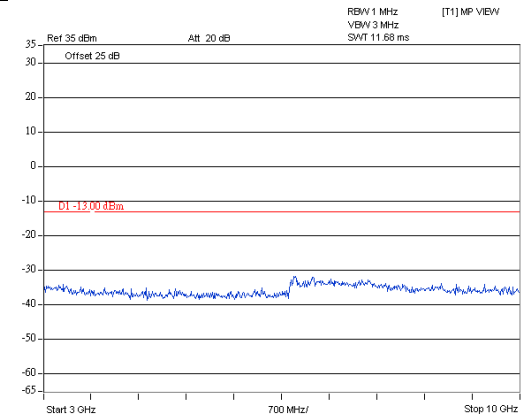
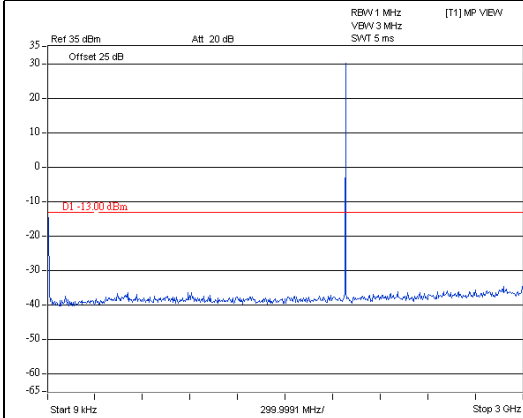

Frequency Range : 10GHz~20GHz

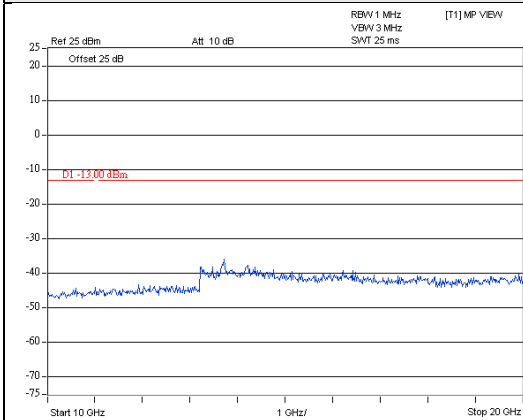

GSM

Channel 810 (1909.8MHz)

Frequency Range : 9kHz~3GHz

Frequency Range : 3GHz~10GHz

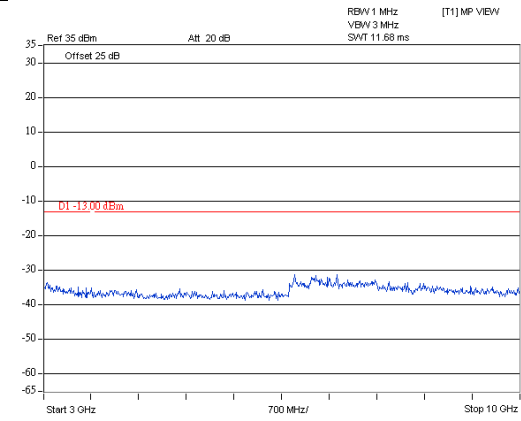
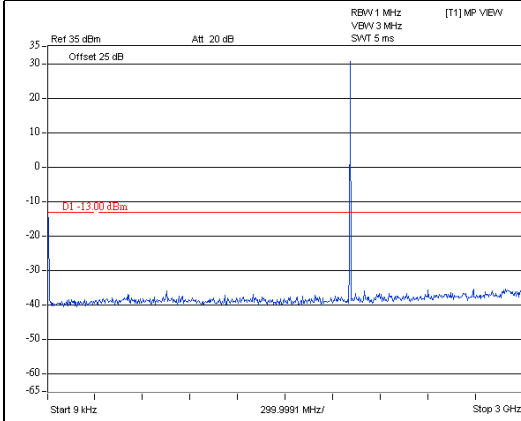

Frequency Range : 10GHz~20GHz

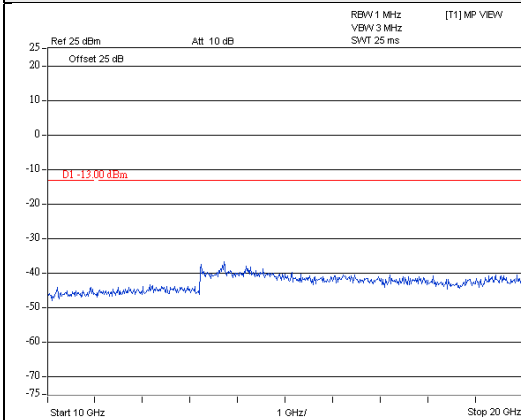

GPRS

Channel 512 (1850.2MHz)

Frequency Range : 9kHz~3GHz

Frequency Range : 3GHz~10GHz

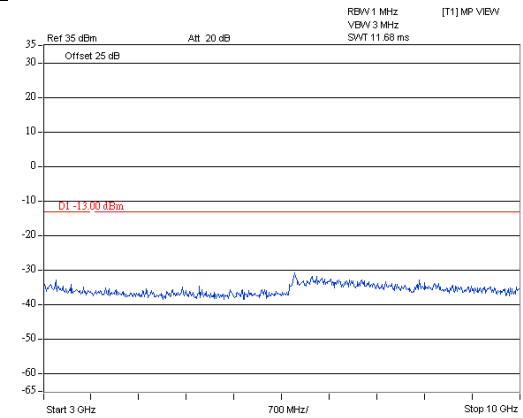
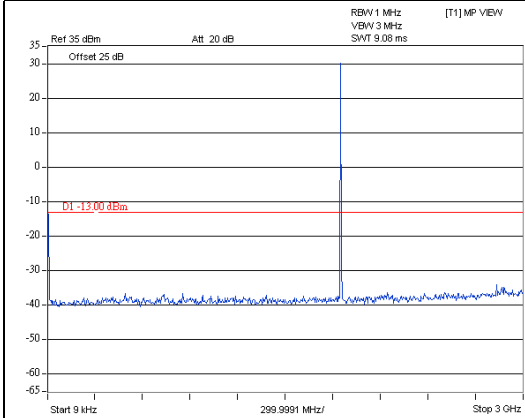

Frequency Range : 10GHz~20GHz

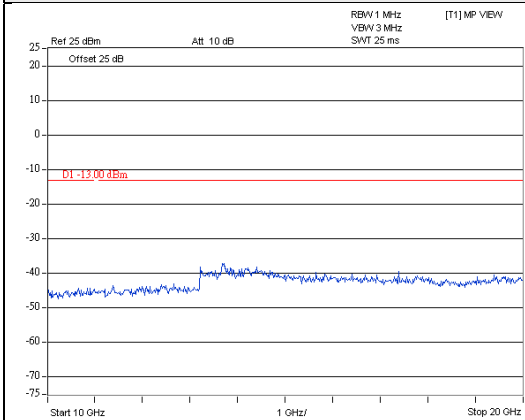

GPRS

Channel 661 (1880.0MHz)

Frequency Range : 9kHz~3GHz

Frequency Range : 3GHz~10GHz

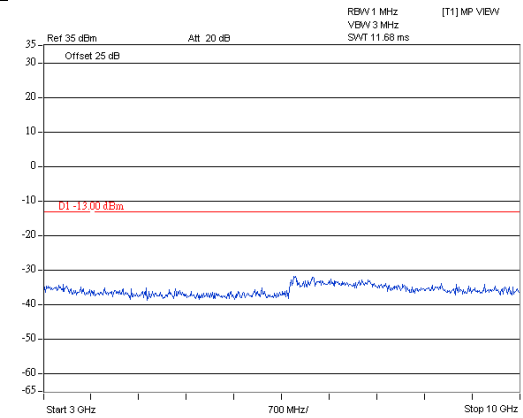
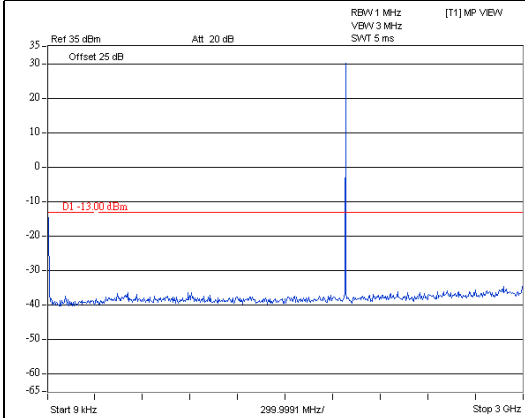

Frequency Range : 10GHz~20GHz

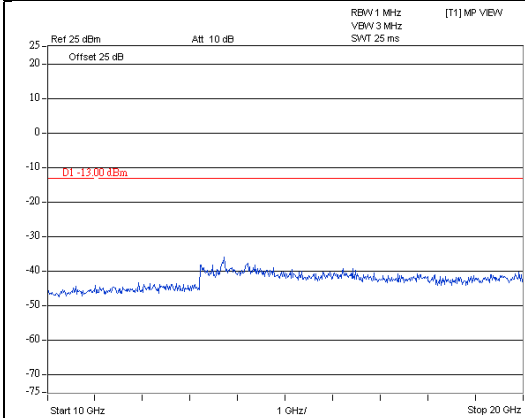

GPRS

Channel 810 (1909.8MHz)

Frequency Range : 9kHz~3GHz

Frequency Range : 3GHz~10GHz

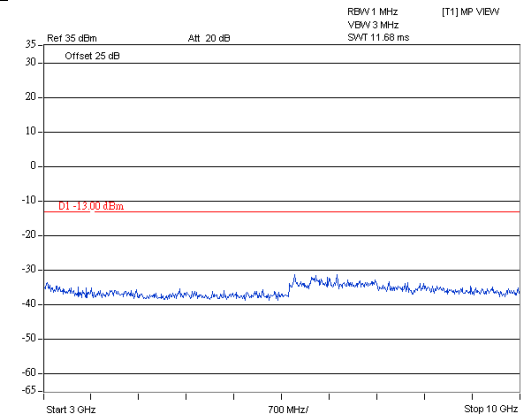
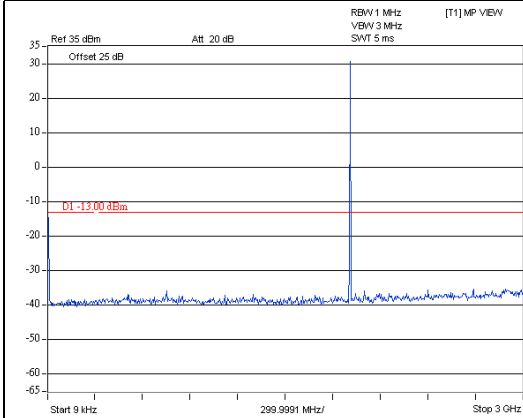

Frequency Range : 10GHz~20GHz

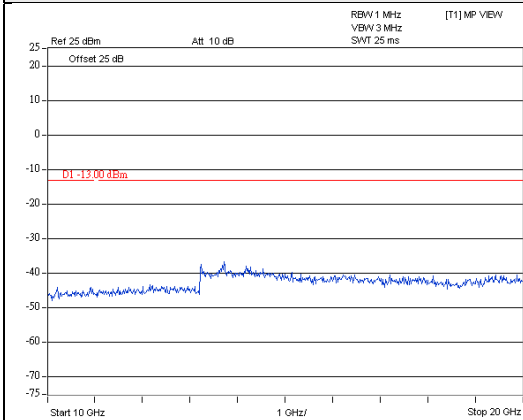

EDGE

Channel 512 (1850.2MHz)

Frequency Range : 9kHz~3GHz

Frequency Range : 3GHz~10GHz

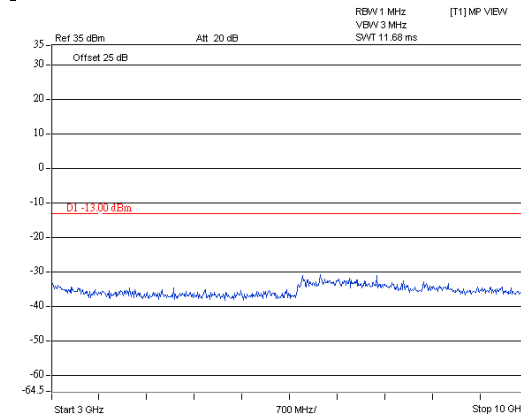
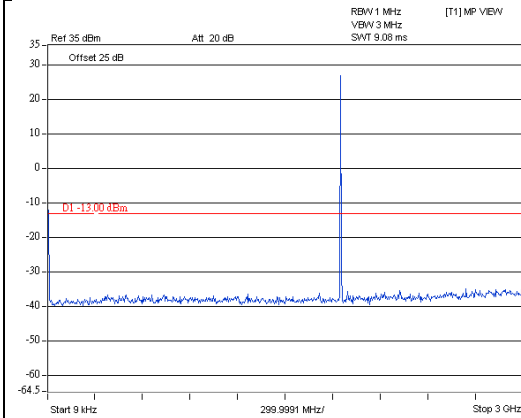

Frequency Range : 10GHz~20GHz

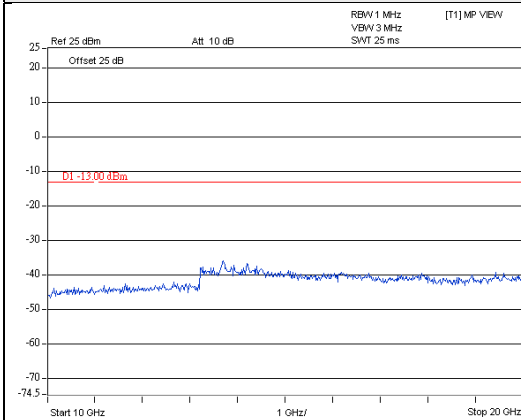

EDGE

Channel 661 (1880.0MHz)

Frequency Range : 9kHz~3GHz

Frequency Range : 3GHz~10GHz

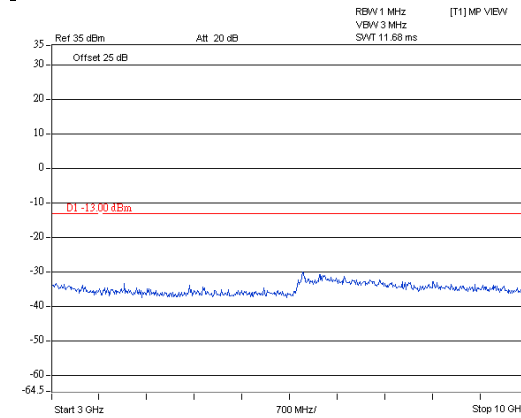
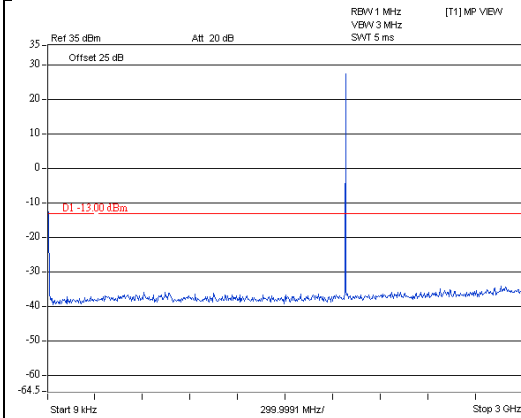

Frequency Range : 10GHz~20GHz

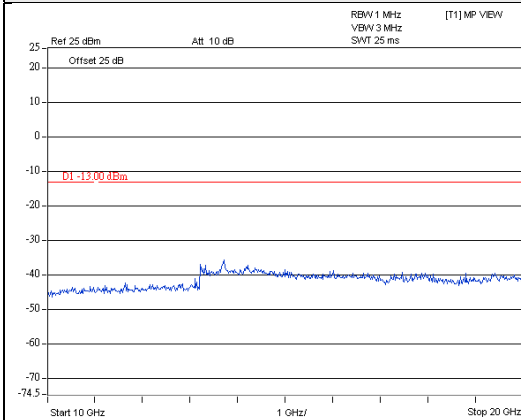

EDGE

Channel 810 (1909.8MHz)

Frequency Range : 9kHz~3GHz

Frequency Range : 3GHz~10GHz

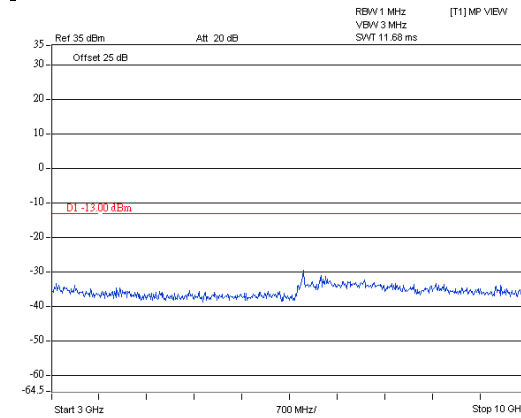
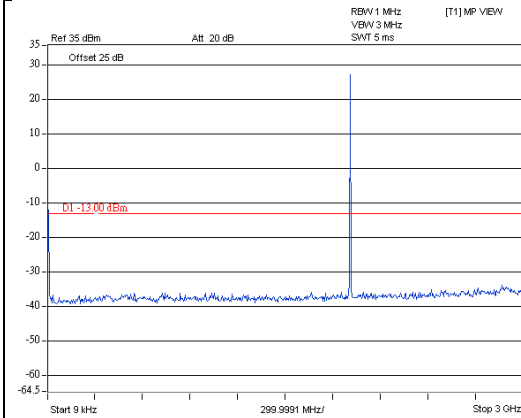

Frequency Range : 10GHz~20GHz

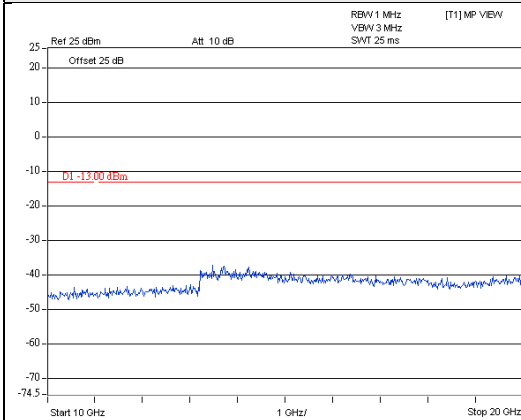

WCDMA

Channel 9262 (1852.4MHz)

Frequency Range : 9kHz~3GHz

Frequency Range : 3GHz~10GHz

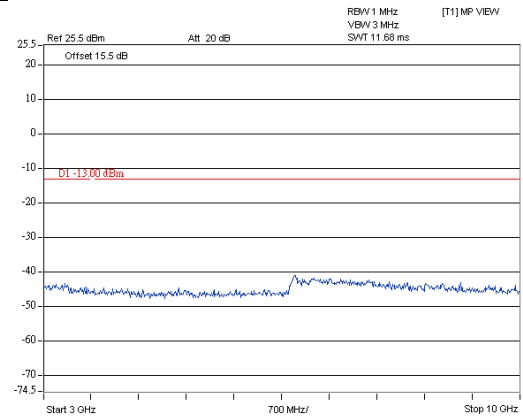
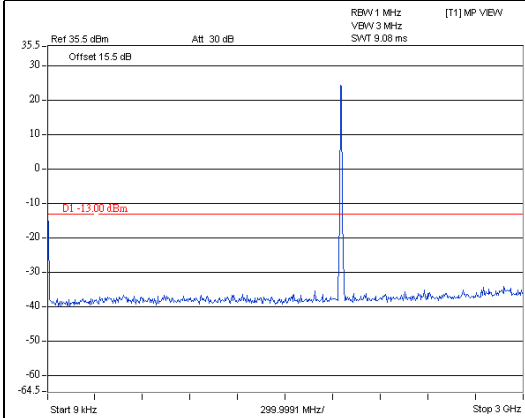

Frequency Range : 10GHz~20GHz

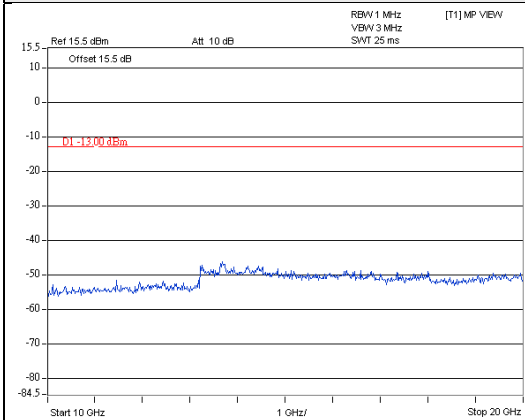

WCDMA

Channel 9400 (1880.0MHz)

Frequency Range : 9kHz~3GHz

Frequency Range : 3GHz~10GHz

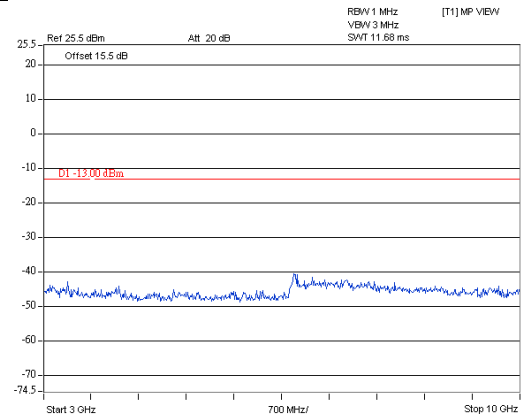
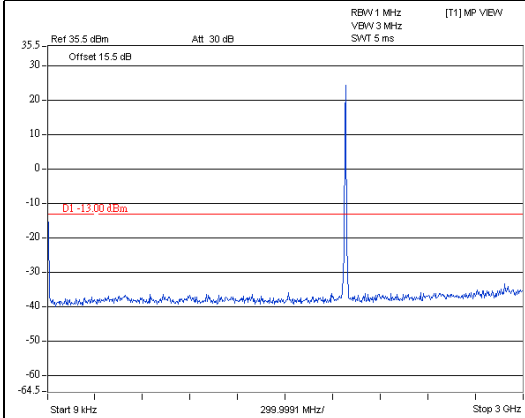

Frequency Range : 10GHz~20GHz

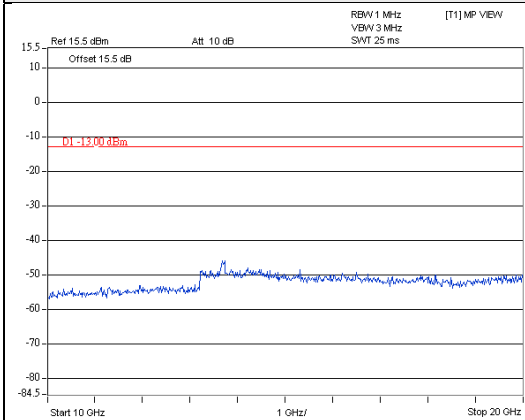

WCDMA

Channel 9538 (1907.6MHz)

Frequency Range : 9kHz~3GHz

Frequency Range : 3GHz~10GHz

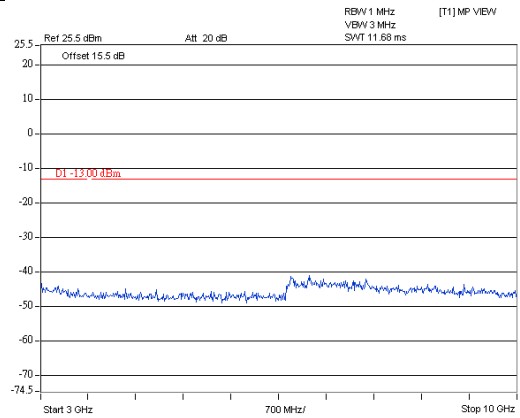
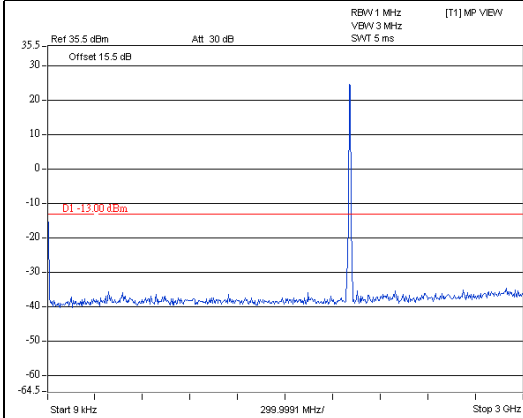

Frequency Range : 10GHz~20GHz

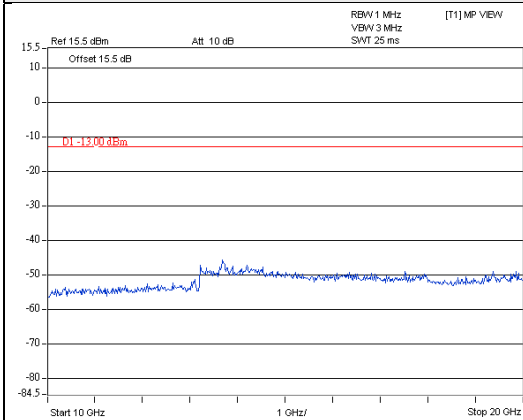

HSDPA

Channel 9262 (1852.4MHz)

Frequency Range : 9kHz~3GHz

Frequency Range : 3GHz~10GHz

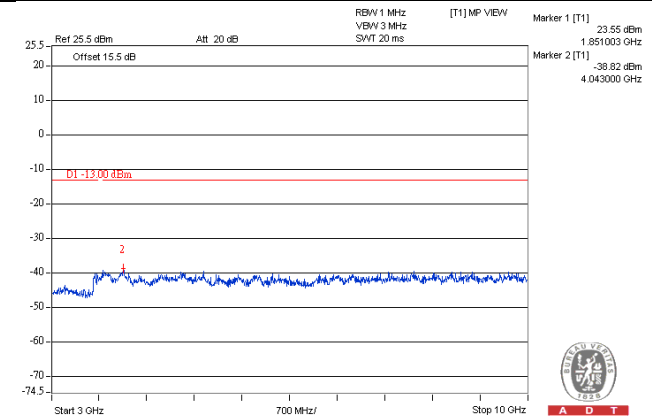
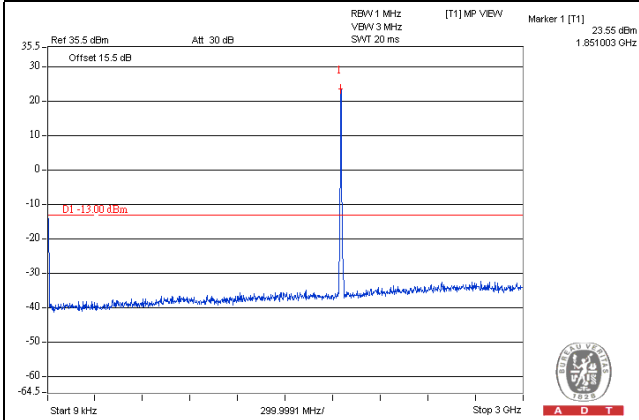

Frequency Range : 10GHz~20GHz

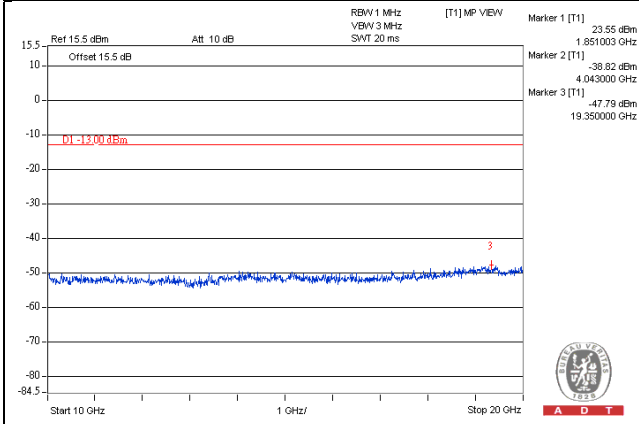

HSDPA

Channel 9400 (1880.0MHz)

Frequency Range : 9kHz~3GHz

Frequency Range : 3GHz~10GHz

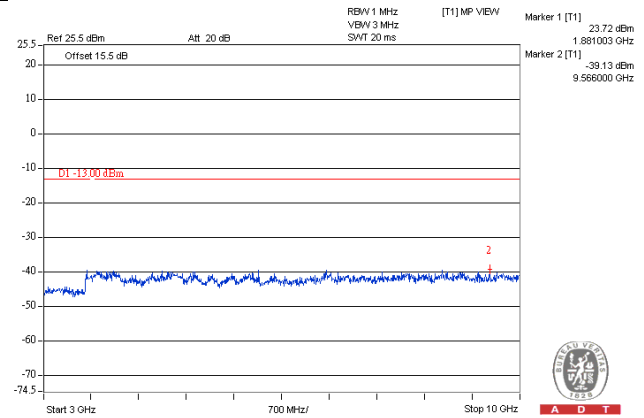
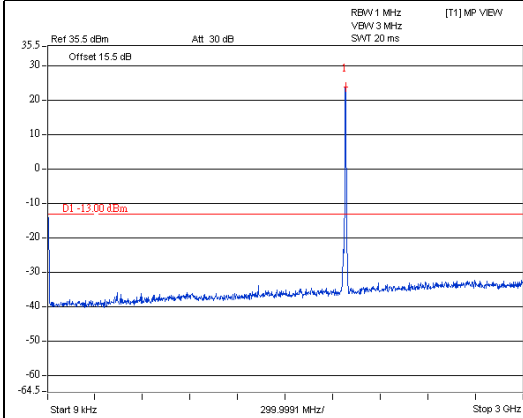

Frequency Range : 10GHz~20GHz

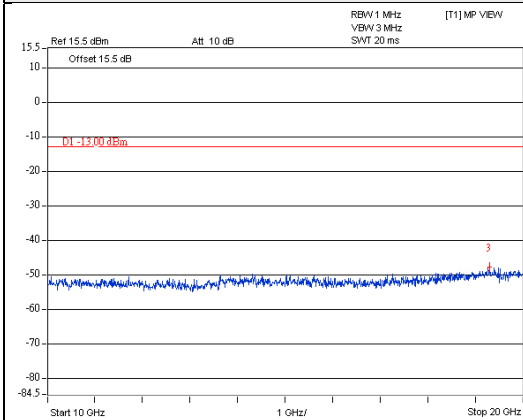

Marker 2 [T1] -39.13 dBm 9.566000 GHz

Marker 3 [T1] -47.67 dBm 19.320000 GHz

HSDPA

Channel 9538 (1907.6MHz)

Frequency Range : 9kHz~3GHz

Frequency Range : 3GHz~10GHz

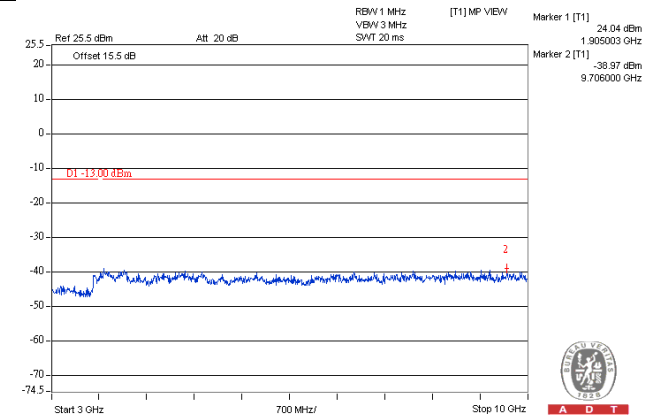
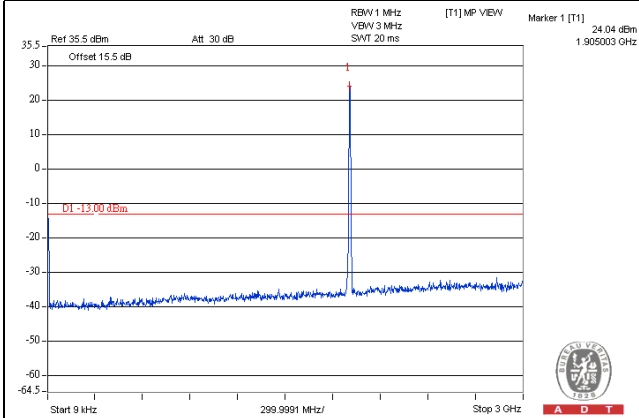

Frequency Range : 10GHz~20GHz

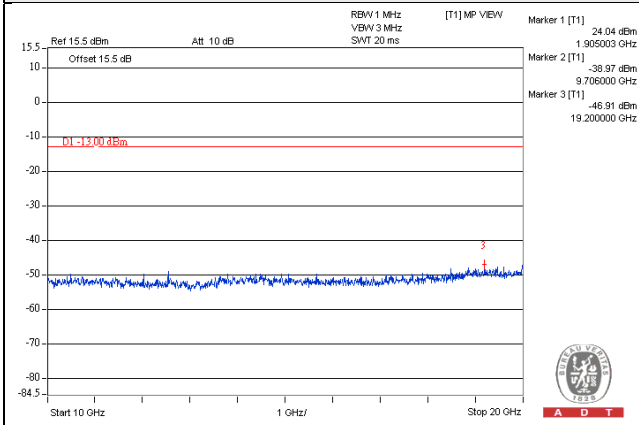

HSUPA

Channel 9262 (1852.4MHz)

Frequency Range : 9kHz~3GHz

Frequency Range : 3GHz~10GHz

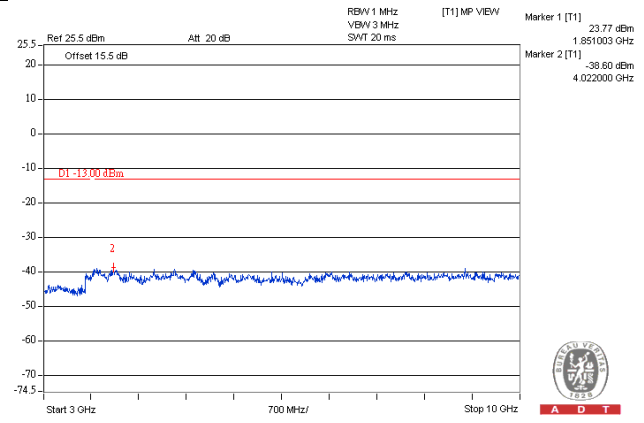
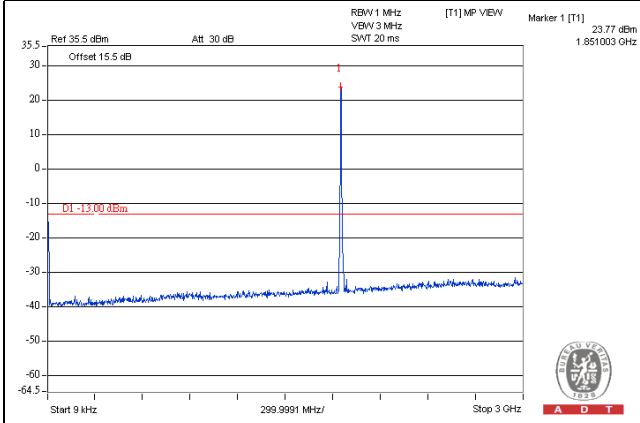

Frequency Range : 10GHz~20GHz

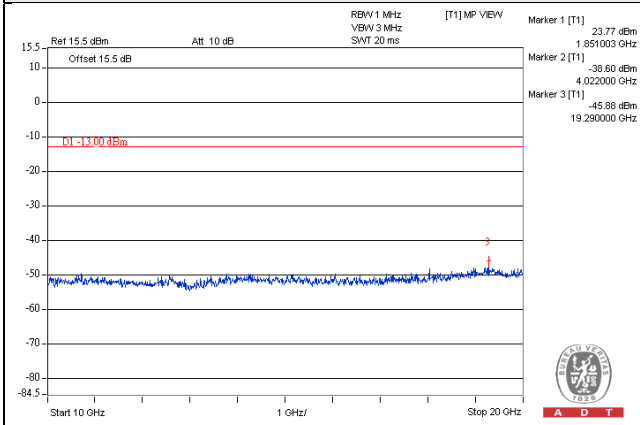

HSUPA

Channel 9400 (1880.0MHz)

Frequency Range : 9kHz~3GHz

Frequency Range : 3GHz~10GHz

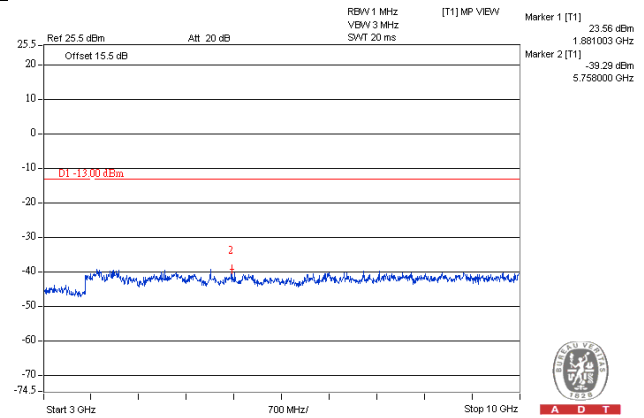
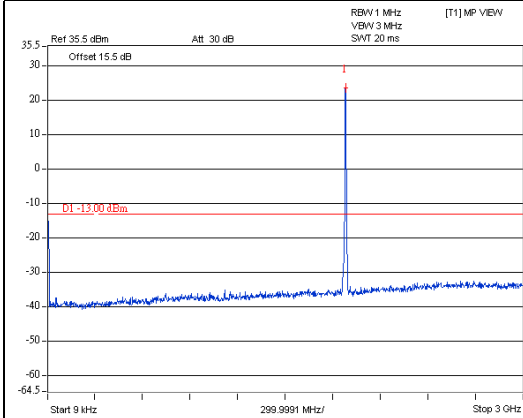

Frequency Range : 10GHz~20GHz

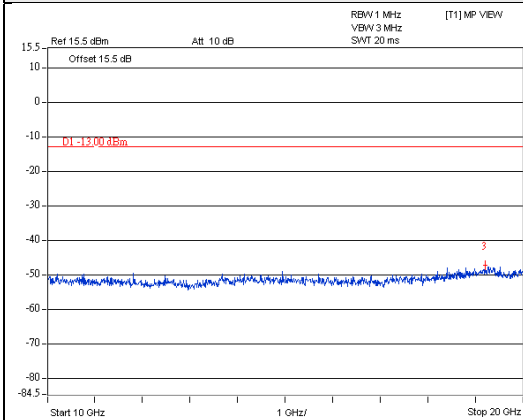

Marker 1 [T1]
23.56 dBm
1.881003 GHz

Marker 2 [T1]
-39.29 dBm
5.758000 GHz

Marker 3 [T1]
-47.11 dBm
19.210000 GHz

HSUPA

Channel 9538 (1907.6MHz)

Frequency Range : 9kHz~3GHz

Frequency Range : 3GHz~10GHz

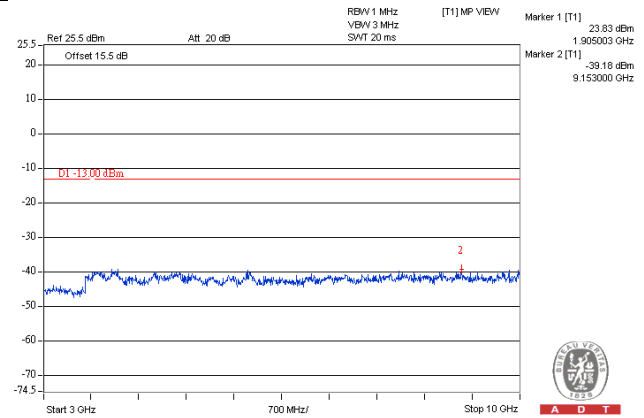
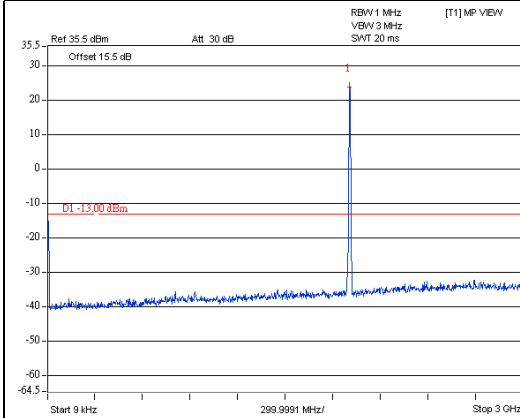

Frequency Range : 10GHz~20GHz

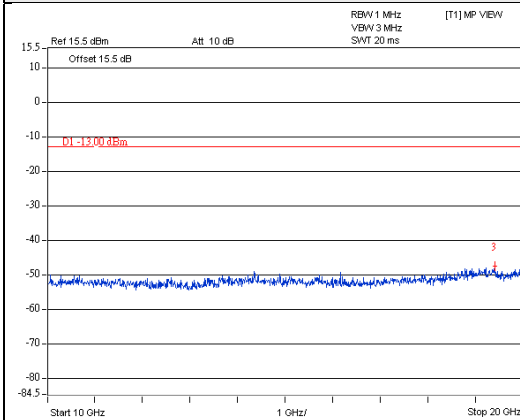

LTE Band 2, Channel Bandwidth 1.4MHz

Channel 18607 (1850.70MHz)

Frequency Range : 9kHz~3GHz

Frequency Range : 3GHz~10GHz

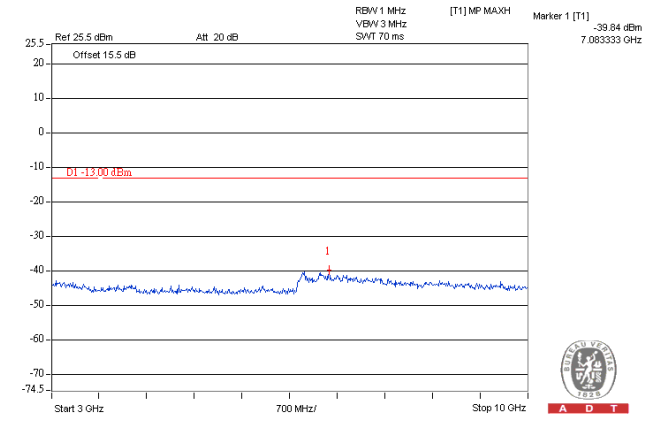
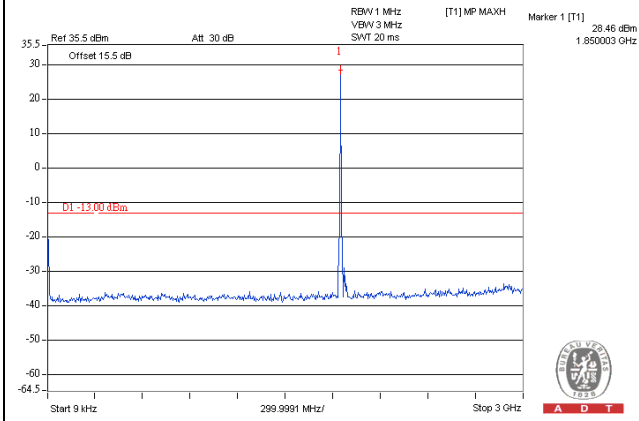

Frequency Range : 10GHz~20GHz

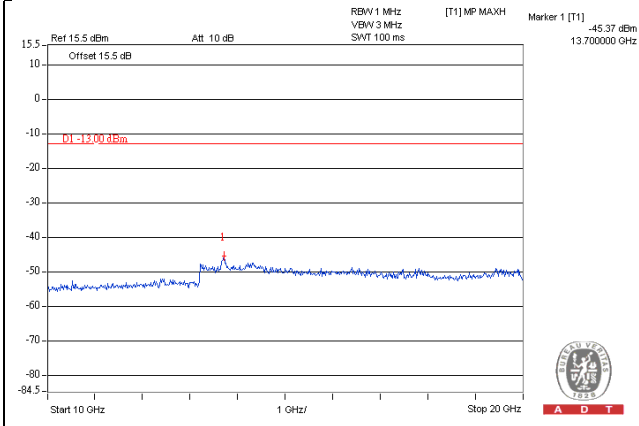

LTE Band 2, Channel Bandwidth 1.4MHz

Channel 18900 (1880.00MHz)

Frequency Range : 9kHz~3GHz

Frequency Range : 3GHz~10GHz

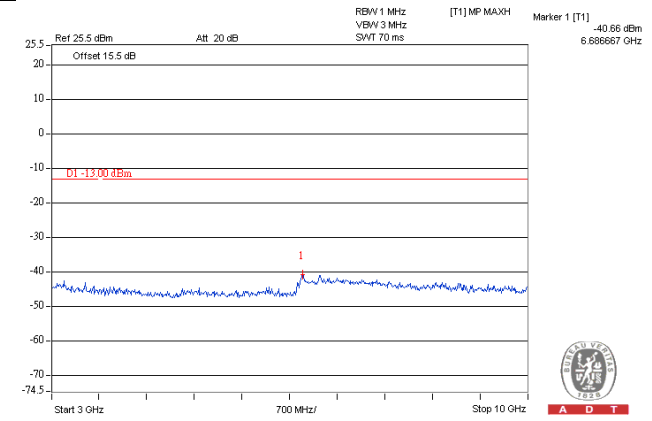
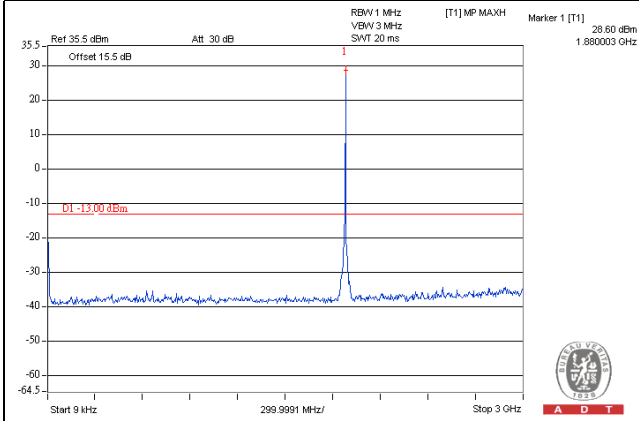

Frequency Range : 10GHz~20GHz

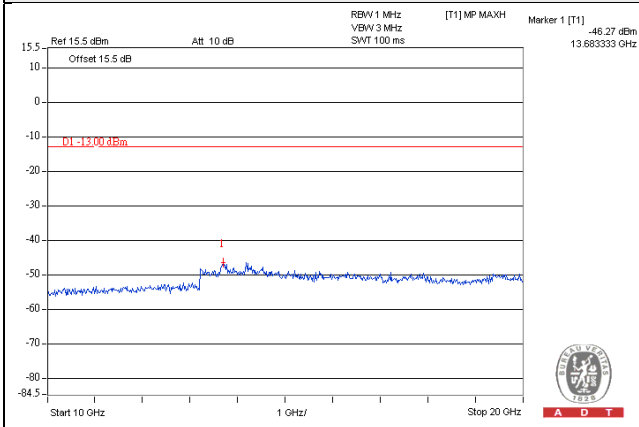

LTE Band 2, Channel Bandwidth 1.4MHz

Channel 19193 (1909.30MHz)

Frequency Range : 9kHz~3GHz

Frequency Range : 3GHz~10GHz

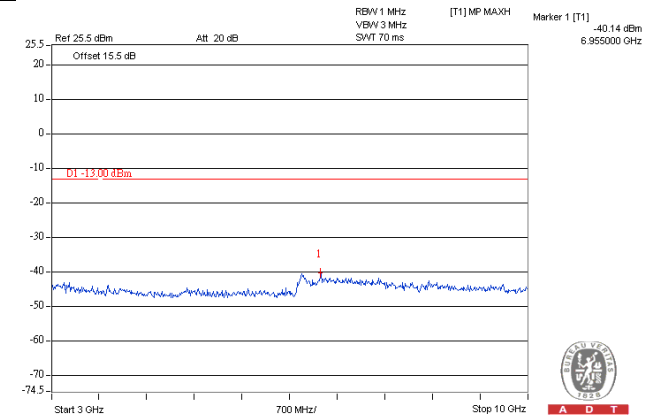
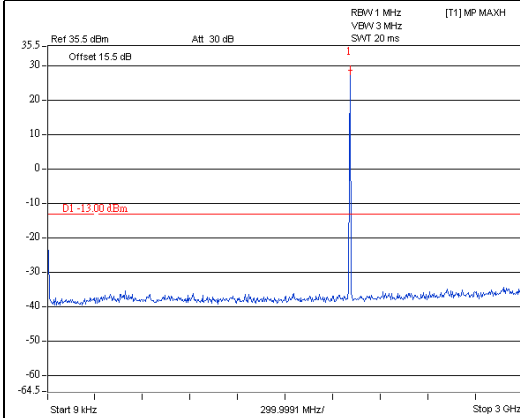

Frequency Range : 10GHz~20GHz

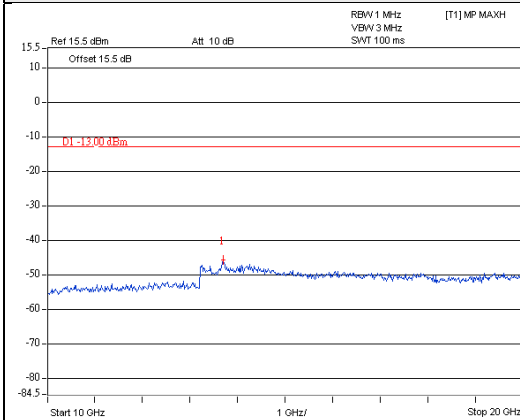

LTE Band 2, Channel Bandwidth 3MHz

Channel 18615 (1851.50MHz)

Frequency Range : 9kHz~3GHz

Frequency Range : 3GHz~10GHz

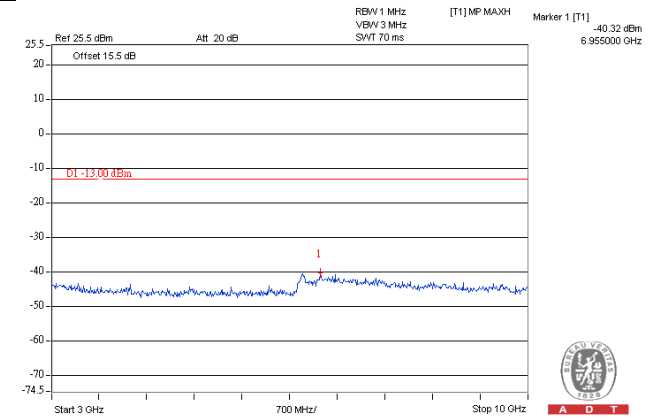
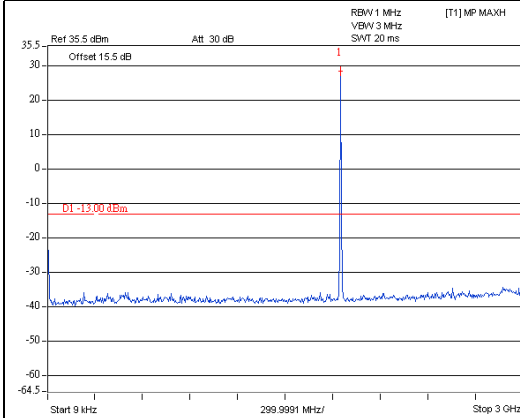

Frequency Range : 10GHz~20GHz

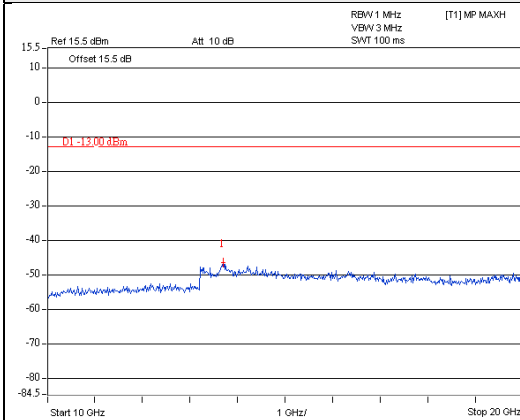

LTE Band 2, Channel Bandwidth 3MHz

Channel 18900 (1880.00MHz)

Frequency Range : 9kHz~3GHz

Frequency Range : 3GHz~10GHz

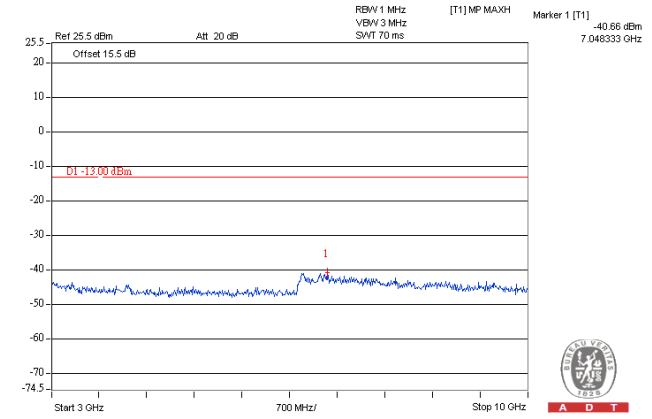
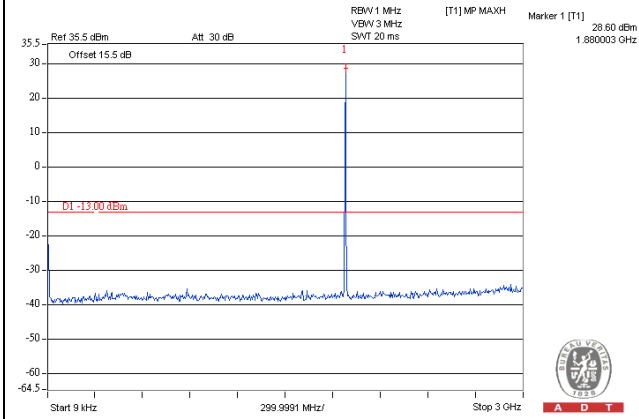

Frequency Range : 10GHz~20GHz

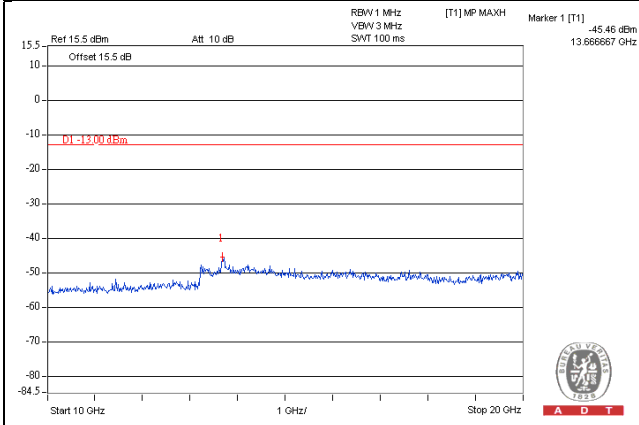

LTE Band 2, Channel Bandwidth 3MHz

Channel 19185 (1908.50MHz)

Frequency Range : 9kHz~3GHz

Frequency Range : 3GHz~10GHz

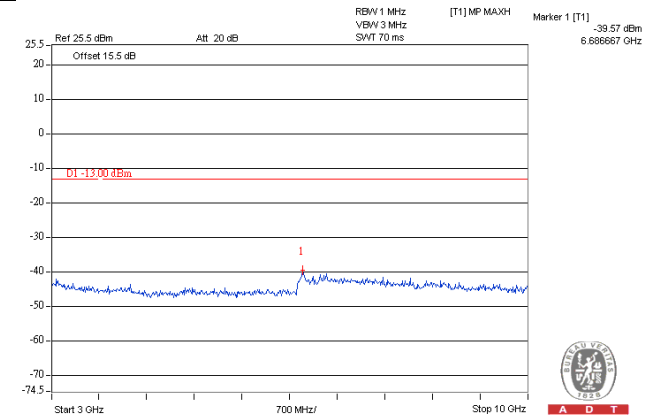
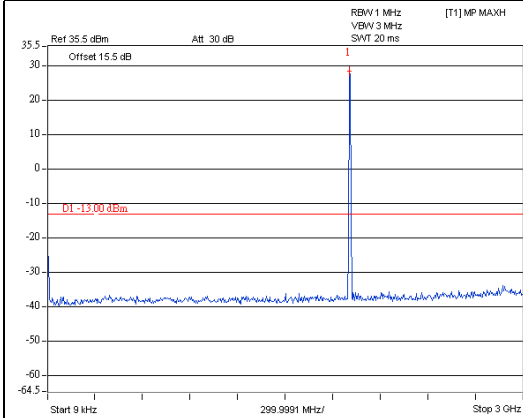

Frequency Range : 10GHz~20GHz

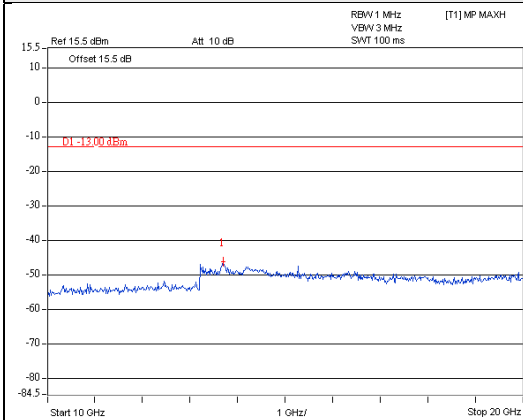

LTE Band 2, Channel Bandwidth 5MHz

Channel 18625 (1852.50MHz)

Frequency Range : 9kHz~3GHz

Frequency Range : 3GHz~10GHz

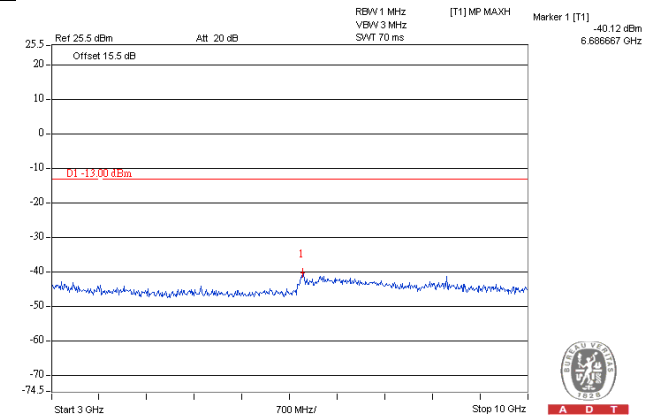
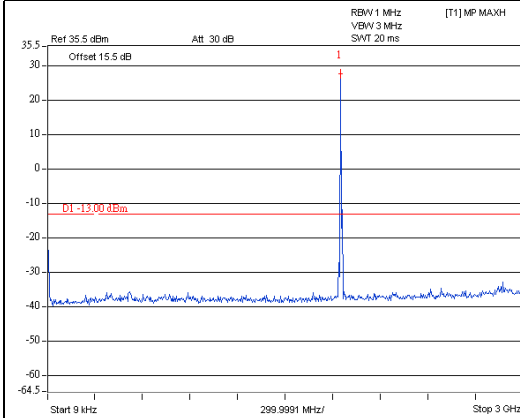

Frequency Range : 10GHz~20GHz

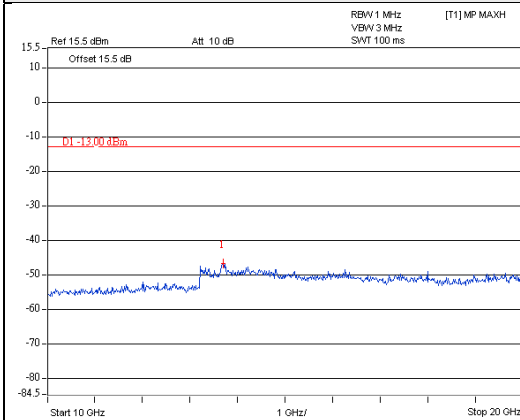

LTE Band 2, Channel Bandwidth 5MHz

Channel 18900 (1880.00MHz)

Frequency Range : 9kHz~3GHz

Frequency Range : 3GHz~10GHz

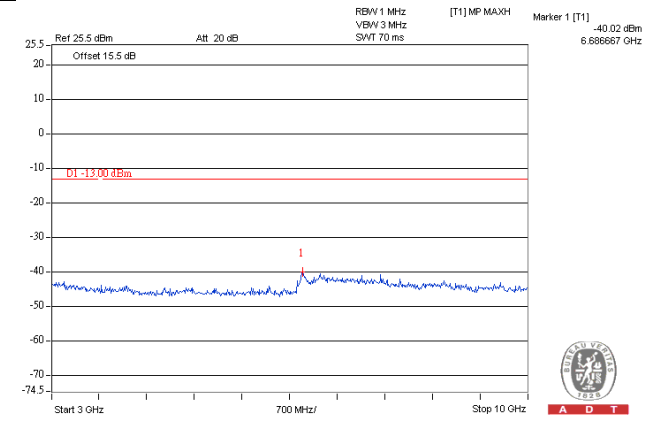
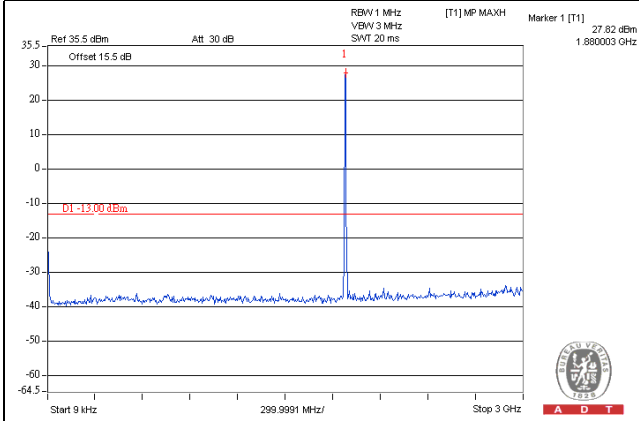

Frequency Range : 10GHz~20GHz

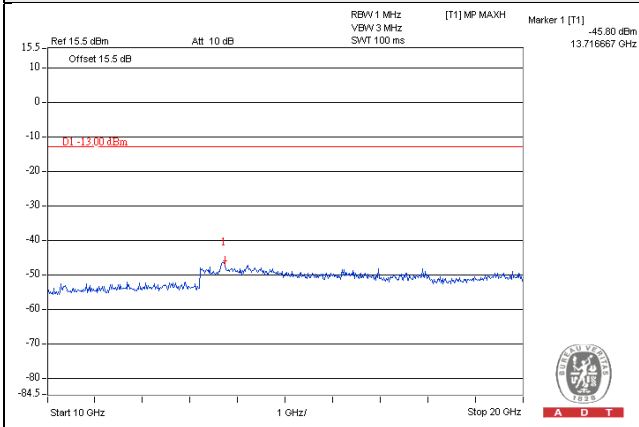

LTE Band 2, Channel Bandwidth 5MHz

Channel 19175 (1907.50MHz)

Frequency Range : 9kHz~3GHz

Frequency Range : 3GHz~10GHz

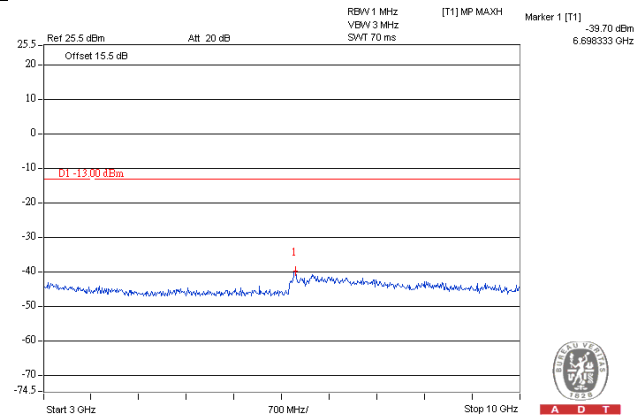
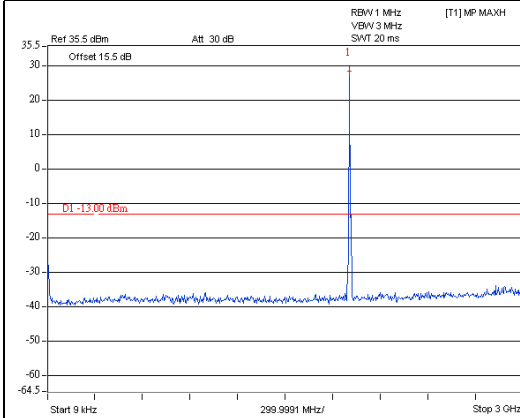

Frequency Range : 10GHz~20GHz

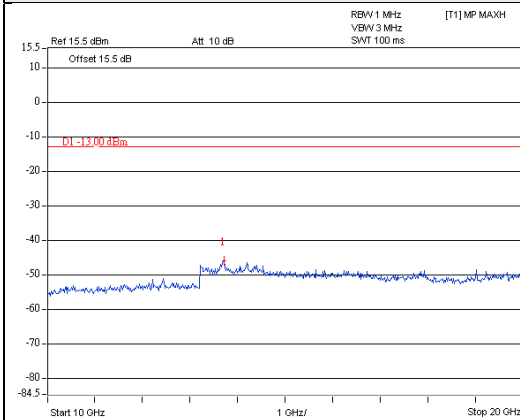

LTE Band 2, Channel Bandwidth 10MHz

Channel 18650 (1855.00MHz)

Frequency Range : 9kHz~3GHz

Frequency Range : 3GHz~10GHz

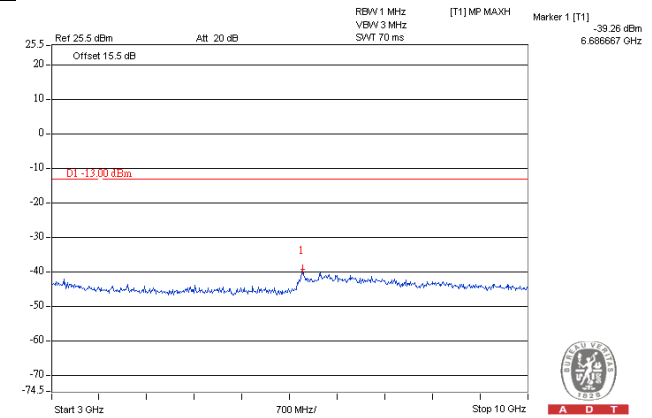
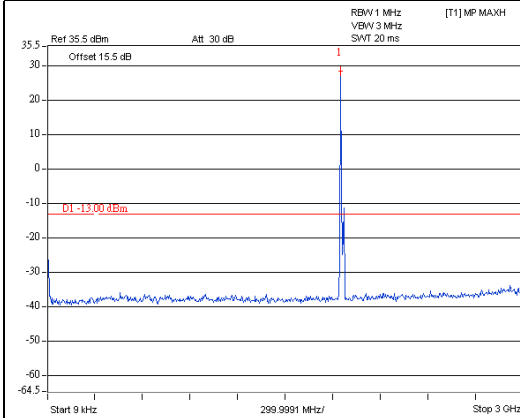

Frequency Range : 10GHz~20GHz

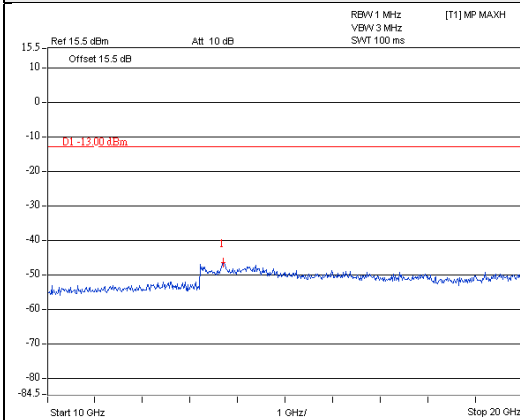

LTE Band 2, Channel Bandwidth 10MHz

Channel 18900 (1880.00MHz)

Frequency Range : 9kHz~3GHz

Frequency Range : 3GHz~10GHz

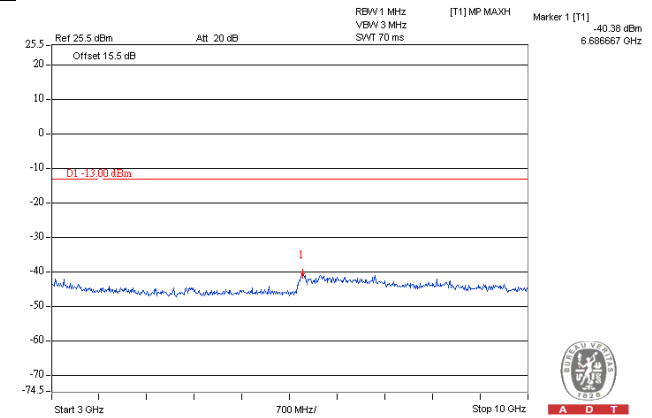
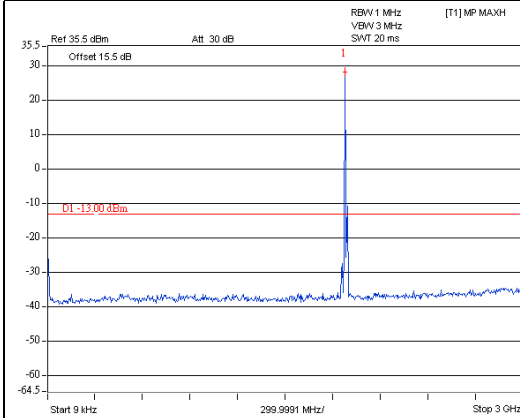

Frequency Range : 10GHz~20GHz

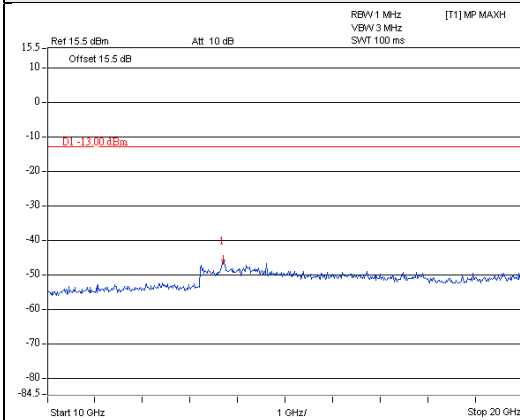

LTE Band 2, Channel Bandwidth 10MHz

Channel 19150 (1905.00MHz)

Frequency Range : 9kHz~3GHz

Frequency Range : 3GHz~10GHz

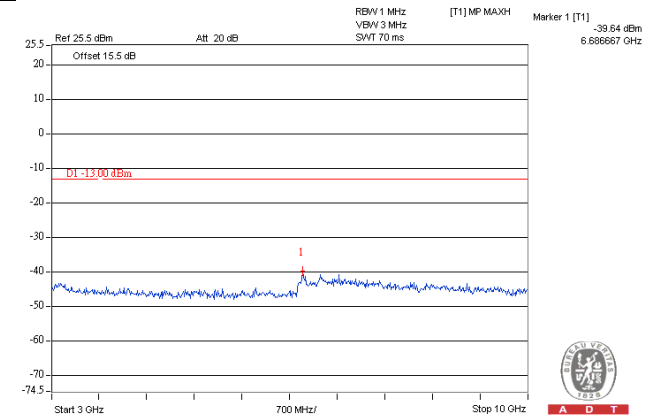
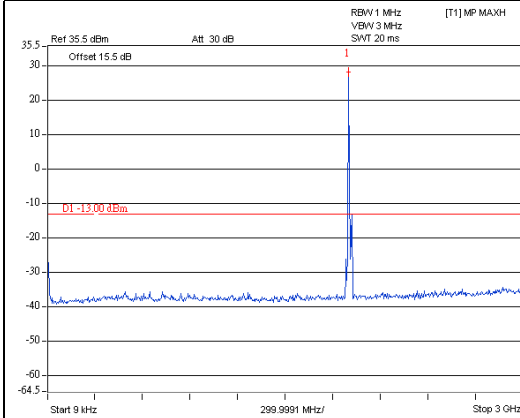

Frequency Range : 10GHz~20GHz

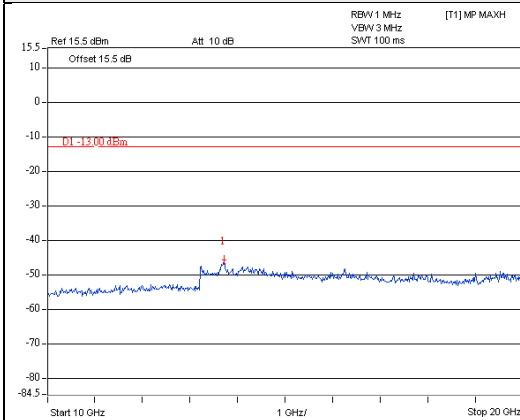

LTE Band 2, Channel Bandwidth 15MHz

Channel 18675 (1857.50MHz)

Frequency Range : 9kHz~3GHz

Frequency Range : 3GHz~10GHz

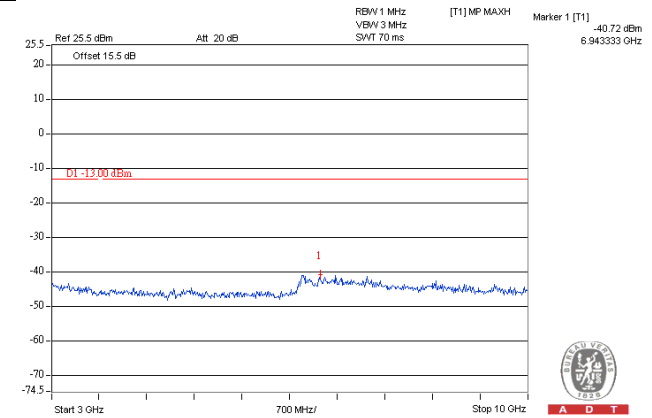
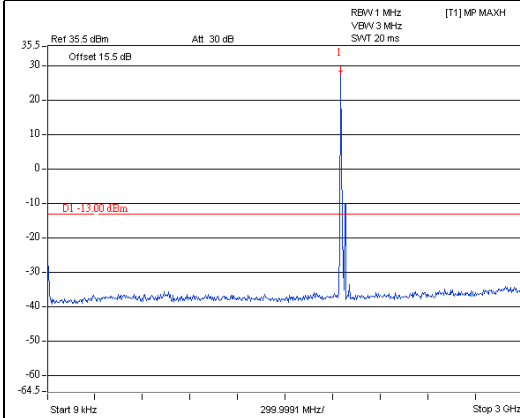

Frequency Range : 10GHz~20GHz

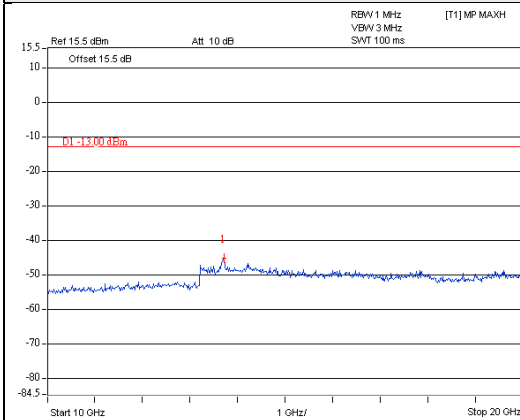

LTE Band 2, Channel Bandwidth 15MHz

Channel 18900 (1880.00MHz)

Frequency Range : 9kHz~3GHz

Frequency Range : 3GHz~10GHz

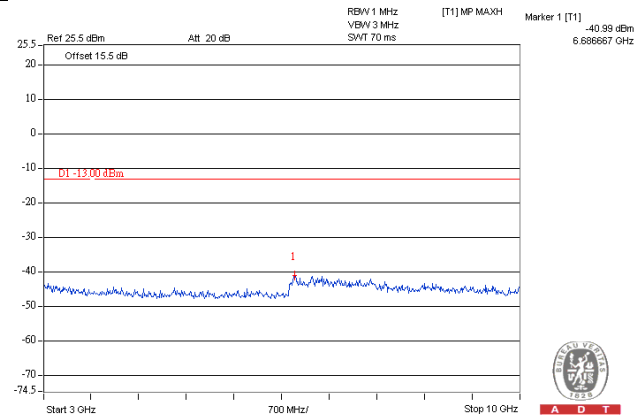
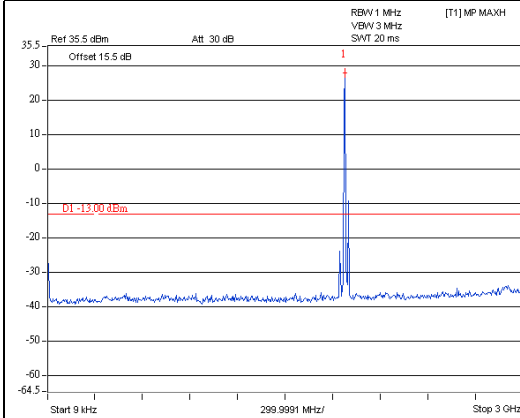

Frequency Range : 10GHz~20GHz

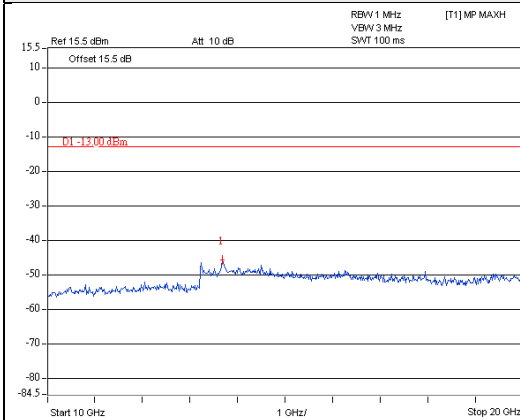

LTE Band 2, Channel Bandwidth 15MHz

Channel 19125 (1902.50MHz)

Frequency Range : 9kHz~3GHz

Frequency Range : 3GHz~10GHz

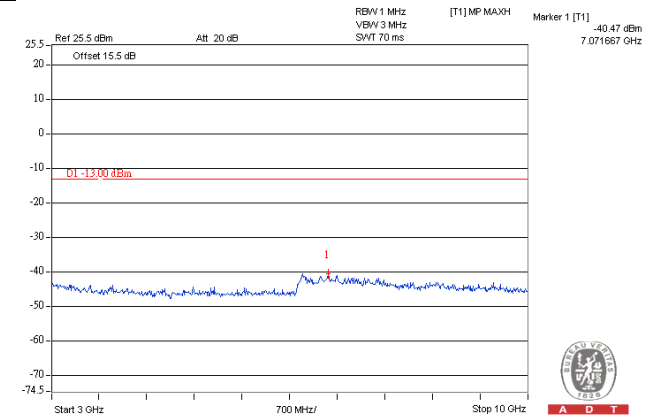
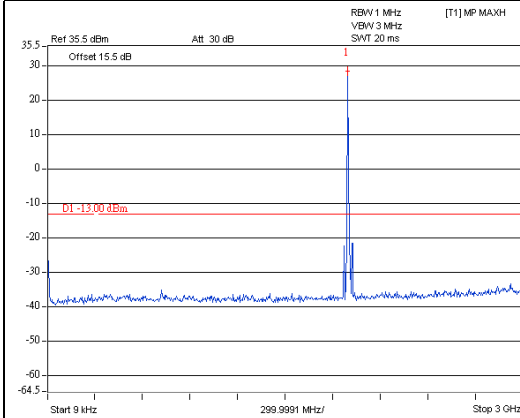

Frequency Range : 10GHz~20GHz

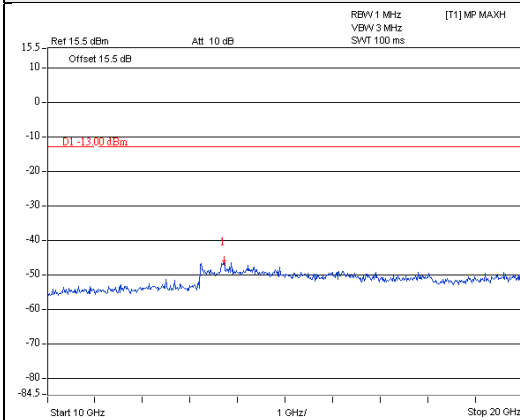

LTE Band 2, Channel Bandwidth 20MHz

Channel 18700 (1860.00MHz)

Frequency Range : 9kHz~3GHz

Frequency Range : 3GHz~10GHz

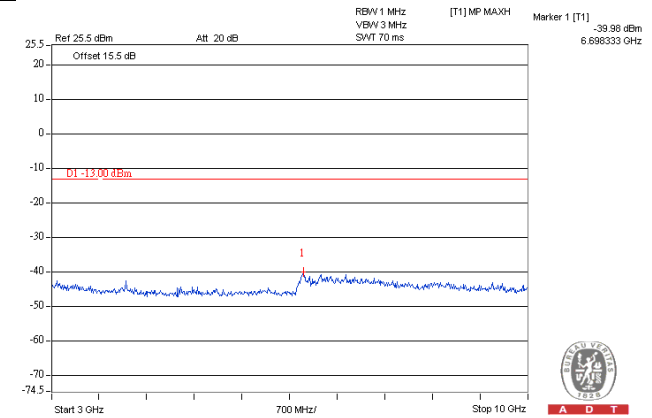
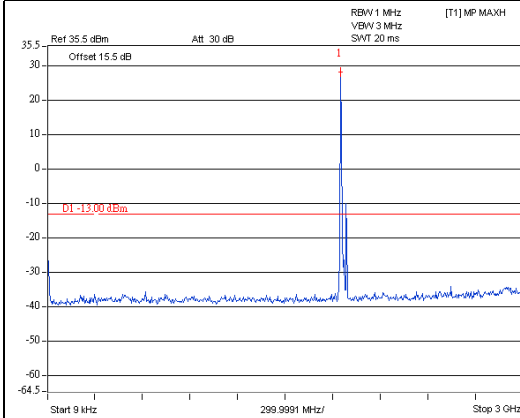

Frequency Range : 10GHz~20GHz

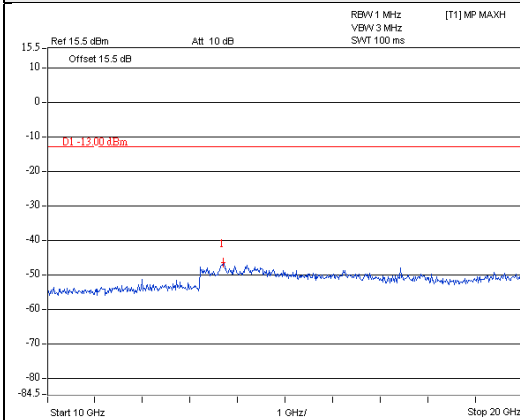

LTE Band 2, Channel Bandwidth 20MHz

Channel 18900 (1880.00MHz)

Frequency Range : 9kHz~3GHz

Frequency Range : 3GHz~10GHz

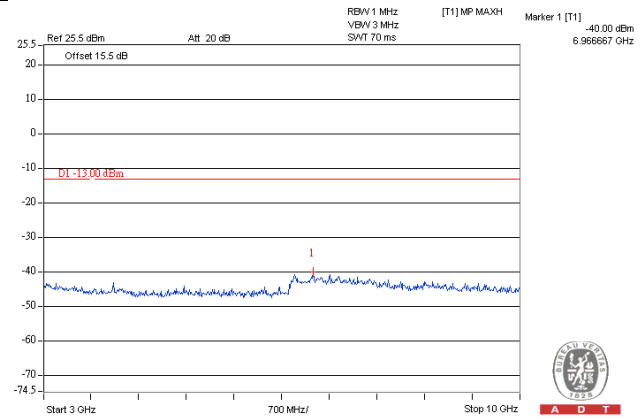
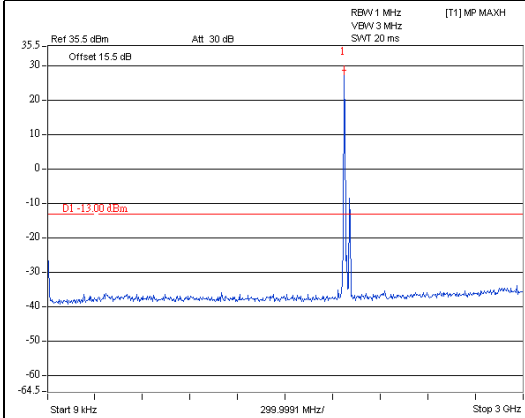

Frequency Range : 10GHz~20GHz

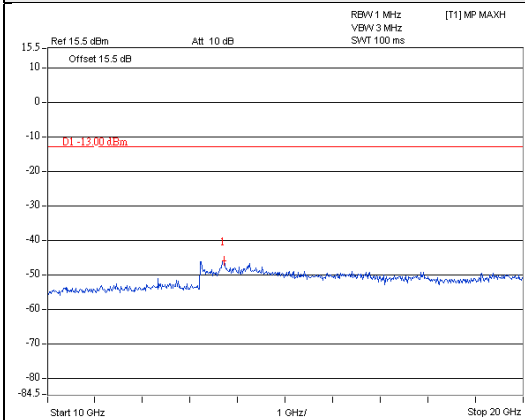

LTE Band 2, Channel Bandwidth 20MHz

Channel 19100 (1900.00MHz)

Frequency Range : 9kHz~3GHz

Frequency Range : 3GHz~10GHz

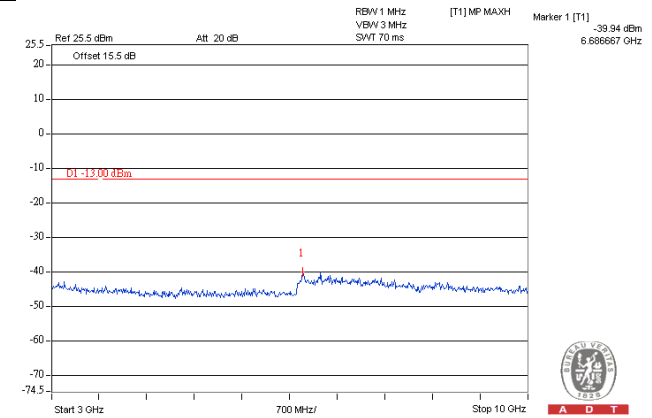
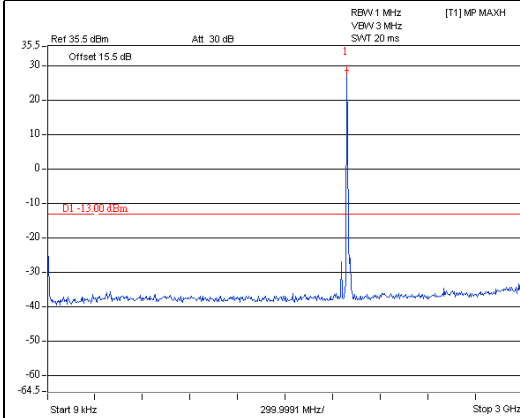

Frequency Range : 10GHz~20GHz

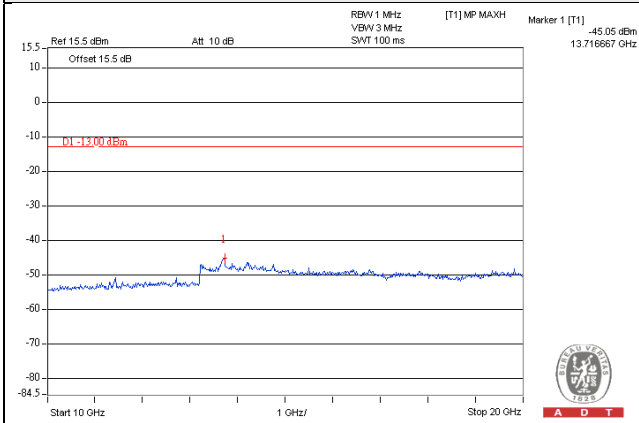

4.8 Radiated Emission Measurement

4.8.1 Limits of Radiated Emission Measurement

The power of any emission outside of the authorized operating frequency ranges must be attenuated below the transmitting power (P) by a factor of at least $43 + 10 \log(P)$ dB. The emission limit equal to -13dBm .

4.8.2 Test Procedure

- a. Substitution method is used for E.I.R.P measurement. In the semi-anechoic chamber, EUT placed on the 0.8m height of Turn Table, rotated the table around 360 degrees to search the maximum radiation power and receiver antenna shall be rotated vertical and horizontal polarization and moved height from 1m to 4m to find the maximum polar radiated power. The "Read Value" is the spectrum reading the maximum power value.
- b. The substitution horn antenna is substituted for EUT at the same position and signals generator export the CW signal to the substitution antenna via a TX cable. Rotated the Turn Table and moved receiving antenna to find the maximum radiation power. Adjust output power level of S.G to get a Value of spectrum reading equal to "Read Value" of step a. Record the power level of S.G
- c. $\text{EIRP} = \text{Output power level of S.G} - \text{TX cable loss} + \text{Antenna gain of substitution horn}$.
- d. E.R.P power can be calculated form E.I.R.P power by subtracting the gain of dipole, $\text{E.R.P power} = \text{E.I.R.P power} - 2.15\text{dBi}$.

NOTE: The resolution bandwidth and video bandwidth of test receiver/spectrum analyzer is 1MHz/3MHz.

4.8.3 Deviation from Test Standard

No deviation.

4.8.4 Test Setup

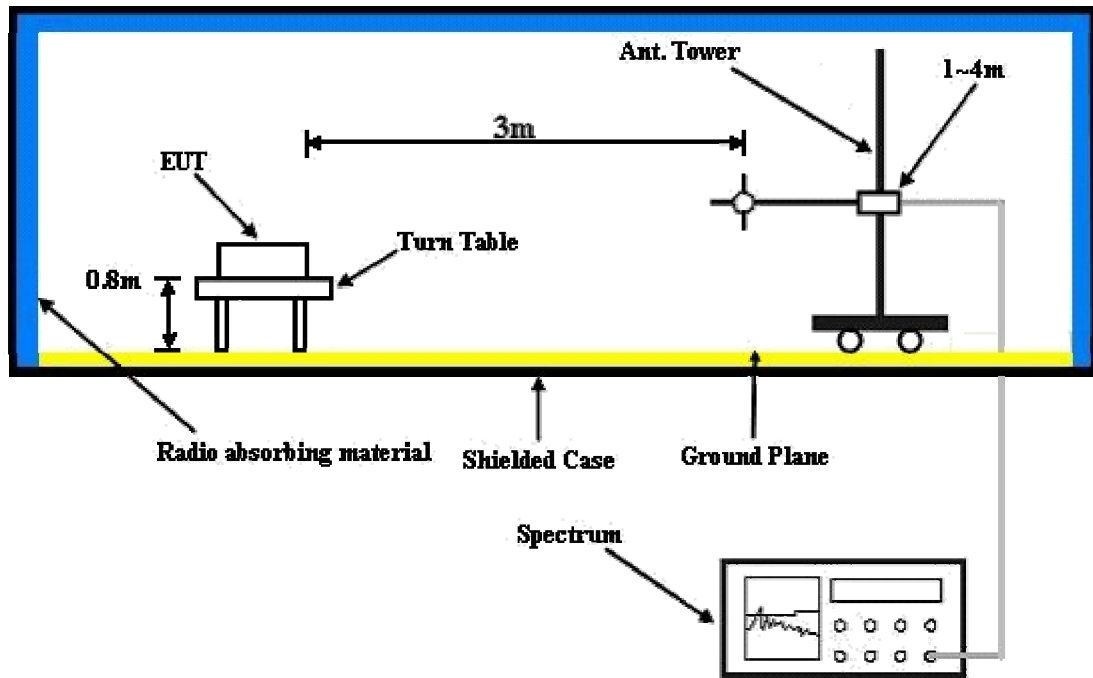

For the actual test configuration, please refer to the attached file (Test Setup Photo).

4.8.5 Test Results

Below 1GHz
GSM Mode

Mode	TX channel 512 (1850.2MHz)	Frequency Range	Below 1000 MHz
Environmental Conditions	19deg. C, 66%RH	Input Power	120Vac, 60Hz
Tested By	Jones Chang		

Antenna Polarity & Test Distance: Horizontal at 3 M							
No.	Freq. (MHz)	Reading (dBm)	S.G Power Value (dBm)	Correction Factor (dB)	EIRP (dBm)	Limit (dBm)	Margin (dB)
1	31.94	-55.9	-43.7	-11.9	-55.6	-13.0	-42.6
2	146.40	-50.9	-57.5	-0.2	-57.7	-13.0	-44.7
3	216.24	-49.5	-65.6	5.4	-60.2	-13.0	-47.2
4	414.12	-60.5	-68.0	5.2	-62.8	-13.0	-49.8
5	544.10	-59.2	-65.5	4.7	-60.8	-13.0	-47.8
6	621.70	-60.4	-64.9	4.6	-60.3	-13.0	-47.3
Antenna Polarity & Test Distance: Vertical at 3 M							
No.	Freq. (MHz)	Reading (dBm)	S.G Power Value (dBm)	Correction Factor (dB)	EIRP (dBm)	Limit (dBm)	Margin (dB)
1	53.28	-47.2	-47.7	-8.5	-56.2	-13.0	-43.2
2	134.76	-45.8	-52.1	-0.3	-52.4	-13.0	-39.4
3	187.14	-51.4	-60.3	3.8	-56.5	-13.0	-43.5
4	266.68	-59.9	-65.7	5.3	-60.4	-13.0	-47.4
5	635.28	-61.5	-62.2	4.7	-57.5	-13.0	-44.5
6	982.54	-62.5	-57.9	3.9	-54.0	-13.0	-41.0

Remarks:

1. Output Power (dBm) = S.G Value (dBm) + Correction Factor (dB).
2. Correction Factor (dB) = Substitution Antenna Gain (dB) + Cable Loss (dB).

WCDMA Mode

Mode	TX channel 9262 (1852.4MHz)	Frequency Range	Below 1000 MHz
Environmental Conditions	19deg. C, 66%RH	Input Power	120Vac, 60Hz
Tested By	James Yang		

Antenna Polarity & Test Distance: Horizontal at 3 M

No.	Freq. (MHz)	Reading (dBm)	S.G Power Value (dBm)	Correction Factor (dB)	EIRP (dBm)	Limit (dBm)	Margin (dB)
1	121.18	-46.1	-56.4	0.1	-56.3	-13.0	-43.3
2	220.12	-47.5	-63.5	5.4	-58.1	-13.0	-45.1
3	398.60	-62.0	-69.7	5.2	-64.5	-13.0	-51.5
4	536.34	-57.0	-63.4	4.7	-58.7	-13.0	-45.7
5	644.98	-64.2	-68.5	4.8	-63.7	-13.0	-50.7
6	883.60	-69.2	-67.4	3.9	-63.5	-13.0	-50.5

Antenna Polarity & Test Distance: Vertical at 3 M

No.	Freq. (MHz)	Reading (dBm)	S.G Power Value (dBm)	Correction Factor (dB)	EIRP (dBm)	Limit (dBm)	Margin (dB)
1	53.28	-46.2	-46.8	-8.5	-55.3	-13.0	-42.3
2	115.36	-35.6	-45.5	0.3	-45.2	-13.0	-32.2
3	249.22	-58.0	-64.5	5.4	-59.1	-13.0	-46.1
4	551.86	-61.1	-66.3	4.7	-61.6	-13.0	-48.6
5	703.18	-66.5	-67.3	5.2	-62.1	-13.0	-49.1
6	831.22	-67.7	-65.5	4.0	-61.5	-13.0	-48.5

Remarks:

1. Output Power (dBm) = S.G Value (dBm) + Correction Factor (dB).
2. Correction Factor (dB) = Substitution Antenna Gain (dB) + Cable Loss (dB).

LTE Band 2, Channel Bandwidth: 1.4MHz

Mode	TX channel 18607 (1850.70MHz)	Frequency Range	Below 1000 MHz
Environmental Conditions	20deg. C, 66%RH	Input Power	120Vac, 60Hz
Tested By	Jones Chang		

Antenna Polarity & Test Distance: Horizontal at 3 M

No.	Freq. (MHz)	Reading (dBm)	S.G Power Value (dBm)	Correction Factor (dB)	EIRP (dBm)	Limit (dBm)	Margin (dB)
1	140.58	-45.1	-47.7	-0.3	-48.0	-13.0	-35.0
2	297.72	-60.4	-64.6	5.1	-59.5	-13.0	-46.5
3	406.36	-62.9	-68.6	5.2	-63.4	-13.0	-50.4
4	534.40	-58.6	-62.1	4.7	-57.4	-13.0	-44.4
5	802.12	-71.6	-67.5	4.0	-63.5	-13.0	-50.5
6	899.12	-62.4	-57.5	3.9	-53.6	-13.0	-40.6

Antenna Polarity & Test Distance: Vertical at 3 M

No.	Freq. (MHz)	Reading (dBm)	S.G Power Value (dBm)	Correction Factor (dB)	EIRP (dBm)	Limit (dBm)	Margin (dB)
1	140.58	-32.0	-37.4	-0.3	-37.7	-13.0	-24.7
2	297.72	-47.7	-55.1	5.1	-50.0	-13.0	-37.0
3	363.68	-55.2	-62.8	5.2	-57.6	-13.0	-44.6
4	429.64	-57.6	-62.9	5.2	-57.7	-13.0	-44.7
5	802.12	-65.5	-63.1	4.0	-59.1	-13.0	-46.1
6	957.32	-68.2	-63.0	3.9	-59.1	-13.0	-46.1

Remarks:

1. Output Power (dBm) = S.G Value (dBm) + Correction Factor (dB).
2. Correction Factor (dB) = Substitution Antenna Gain (dB) + Cable Loss (dB).

LTE Band 2, Channel Bandwidth: 3MHz

Mode	TX channel 18615 (1851.50MHz)	Frequency Range	Below 1000 MHz
Environmental Conditions	20deg. C, 66%RH	Input Power	120Vac, 60Hz
Tested By	Jones Chang		

Antenna Polarity & Test Distance: Horizontal at 3 M

No.	Freq. (MHz)	Reading (dBm)	S.G Power Value (dBm)	Correction Factor (dB)	EIRP (dBm)	Limit (dBm)	Margin (dB)
1	140.58	-49.4	-52.0	-0.3	-52.3	-13.0	-39.3
2	192.96	-53.2	-60.5	4.6	-55.9	-13.0	-42.9
3	297.72	-60.9	-65.1	5.1	-60.0	-13.0	-47.0
4	404.42	-63.0	-68.6	5.2	-63.4	-13.0	-50.4
5	534.40	-58.8	-62.3	4.7	-57.6	-13.0	-44.6
6	957.32	-72.1	-66.2	3.9	-62.3	-13.0	-49.3

Antenna Polarity & Test Distance: Vertical at 3 M

No.	Freq. (MHz)	Reading (dBm)	S.G Power Value (dBm)	Correction Factor (dB)	EIRP (dBm)	Limit (dBm)	Margin (dB)
1	140.58	-35.8	-41.2	-0.3	-41.5	-13.0	-28.5
2	297.72	-48.1	-55.5	5.1	-50.4	-13.0	-37.4
3	363.68	-55.8	-63.4	5.2	-58.2	-13.0	-45.2
4	429.64	-57.6	-62.9	5.2	-57.7	-13.0	-44.7
5	534.40	-60.9	-65.1	4.7	-60.4	-13.0	-47.4
6	802.12	-63.7	-61.3	4.0	-57.3	-13.0	-44.3

Remarks:

1. Output Power (dBm) = S.G Value (dBm) + Correction Factor (dB).
2. Correction Factor (dB) = Substitution Antenna Gain (dB) + Cable Loss (dB).

LTE Band 2, Channel Bandwidth: 5MHz

Mode	TX channel 18625 (1852.50MHz)	Frequency Range	Below 1000 MHz
Environmental Conditions	20deg. C, 66%RH	Input Power	120Vac, 60Hz
Tested By	Jones Chang		

Antenna Polarity & Test Distance: Horizontal at 3 M

No.	Freq. (MHz)	Reading (dBm)	S.G Power Value (dBm)	Correction Factor (dB)	EIRP (dBm)	Limit (dBm)	Margin (dB)
1	39.70	-49.2	-47.6	-10.9	-58.5	-13.0	-45.5
2	140.58	-50.8	-53.4	-0.3	-53.7	-13.0	-40.7
3	297.72	-62.0	-66.2	5.1	-61.1	-13.0	-48.1
4	542.16	-59.8	-63.0	4.7	-58.3	-13.0	-45.3
5	802.12	-71.9	-67.8	4.0	-63.8	-13.0	-50.8
6	957.32	-72.2	-66.3	3.9	-62.4	-13.0	-49.4

Antenna Polarity & Test Distance: Vertical at 3 M

No.	Freq. (MHz)	Reading (dBm)	S.G Power Value (dBm)	Correction Factor (dB)	EIRP (dBm)	Limit (dBm)	Margin (dB)
1	140.58	-36.8	-42.2	-0.3	-42.5	-13.0	-29.5
2	297.72	-48.5	-55.9	5.1	-50.8	-13.0	-37.8
3	363.68	-56.8	-64.4	5.2	-59.2	-13.0	-46.2
4	429.64	-58.2	-63.5	5.2	-58.3	-13.0	-45.3
5	802.12	-65.2	-62.8	4.0	-58.8	-13.0	-45.8
6	959.26	-69.4	-64.1	3.9	-60.2	-13.0	-47.2

Remarks:

1. Output Power (dBm) = S.G Value (dBm) + Correction Factor (dB).
2. Correction Factor (dB) = Substitution Antenna Gain (dB) + Cable Loss (dB).

LTE Band 2, Channel Bandwidth: 10MHz

Mode	TX channel 18650 (1855.00MHz)	Frequency Range	Below 1000 MHz
Environmental Conditions	20deg. C, 66%RH	Input Power	120Vac, 60Hz
Tested By	Jones Chang		

Antenna Polarity & Test Distance: Horizontal at 3 M

No.	Freq. (MHz)	Reading (dBm)	S.G Power Value (dBm)	Correction Factor (dB)	EIRP (dBm)	Limit (dBm)	Margin (dB)
1	140.58	-51.7	-54.3	-0.3	-54.6	-13.0	-41.6
2	192.96	-54.1	-61.4	4.6	-56.8	-13.0	-43.8
3	297.72	-62.6	-66.8	5.1	-61.7	-13.0	-48.7
4	534.40	-59.2	-62.7	4.7	-58.0	-13.0	-45.0
5	683.78	-70.7	-69.8	5.1	-64.7	-13.0	-51.7
6	858.38	-72.2	-67.9	3.9	-64.0	-13.0	-51.0

Antenna Polarity & Test Distance: Vertical at 3 M

No.	Freq. (MHz)	Reading (dBm)	S.G Power Value (dBm)	Correction Factor (dB)	EIRP (dBm)	Limit (dBm)	Margin (dB)
1	140.58	-39.6	-45.0	-0.3	-45.3	-13.0	-32.3
2	297.72	-48.8	-56.2	5.1	-51.1	-13.0	-38.1
3	363.68	-55.6	-63.2	5.2	-58.0	-13.0	-45.0
4	429.64	-58.7	-64.0	5.2	-58.8	-13.0	-45.8
5	544.10	-61.7	-65.8	4.7	-61.1	-13.0	-48.1
6	800.18	-65.6	-63.2	4.0	-59.2	-13.0	-46.2

Remarks:

1. Output Power (dBm) = S.G Value (dBm) + Correction Factor (dB).
2. Correction Factor (dB) = Substitution Antenna Gain (dB) + Cable Loss (dB).

LTE Band 2, Channel Bandwidth: 15MHz

Mode	TX channel 18675 (1857.50MHz)	Frequency Range	Below 1000 MHz
Environmental Conditions	20deg. C, 66%RH	Input Power	120Vac, 60Hz
Tested By	Jones Chang		

Antenna Polarity & Test Distance: Horizontal at 3 M

No.	Freq. (MHz)	Reading (dBm)	S.G Power Value (dBm)	Correction Factor (dB)	EIRP (dBm)	Limit (dBm)	Margin (dB)
1	138.64	-53.0	-55.9	-0.3	-56.2	-13.0	-43.2
2	192.96	-54.1	-61.4	4.6	-56.8	-13.0	-43.8
3	297.72	-62.5	-66.7	5.1	-61.6	-13.0	-48.6
4	528.58	-59.5	-63.0	4.7	-58.3	-13.0	-45.3
5	800.18	-72.4	-68.3	4.0	-64.3	-13.0	-51.3
6	957.32	-70.3	-64.4	3.9	-60.5	-13.0	-47.5

Antenna Polarity & Test Distance: Vertical at 3 M

No.	Freq. (MHz)	Reading (dBm)	S.G Power Value (dBm)	Correction Factor (dB)	EIRP (dBm)	Limit (dBm)	Margin (dB)
1	55.22	-50.8	-44.2	-8.7	-52.9	-13.0	-39.9
2	140.58	-43.3	-48.7	-0.3	-49.0	-13.0	-36.0
3	297.72	-49.1	-56.5	5.1	-51.4	-13.0	-38.4
4	363.68	-56.0	-63.6	5.2	-58.4	-13.0	-45.4
5	429.64	-58.7	-64.0	5.2	-58.8	-13.0	-45.8
6	802.12	-64.7	-62.3	4.0	-58.3	-13.0	-45.3

Remarks:

1. Output Power (dBm) = S.G Value (dBm) + Correction Factor (dB).
2. Correction Factor (dB) = Substitution Antenna Gain (dB) + Cable Loss (dB).

LTE Band 2, Channel Bandwidth: 20MHz

Mode	TX channel 18700 (1860.00MHz)	Frequency Range	Below 1000 MHz
Environmental Conditions	20deg. C, 66%RH	Input Power	120Vac, 60Hz
Tested By	Jones Chang		

Antenna Polarity & Test Distance: Horizontal at 3 M

No.	Freq. (MHz)	Reading (dBm)	S.G Power Value (dBm)	Correction Factor (dB)	EIRP (dBm)	Limit (dBm)	Margin (dB)
1	111.48	-51.2	-59.3	0.4	-58.9	-13.0	-45.9
2	196.84	-55.5	-62.7	5.1	-57.6	-13.0	-44.6
3	297.72	-63.2	-67.4	5.1	-62.3	-13.0	-49.3
4	532.46	-59.5	-63.0	4.7	-58.3	-13.0	-45.3
5	800.18	-72.3	-68.2	4.0	-64.2	-13.0	-51.2
6	957.32	-71.5	-65.6	3.9	-61.7	-13.0	-48.7

Antenna Polarity & Test Distance: Vertical at 3 M

No.	Freq. (MHz)	Reading (dBm)	S.G Power Value (dBm)	Correction Factor (dB)	EIRP (dBm)	Limit (dBm)	Margin (dB)
1	140.58	-41.5	-46.9	-0.3	-47.2	-13.0	-34.2
2	297.72	-49.2	-56.6	5.1	-51.5	-13.0	-38.5
3	363.68	-56.2	-63.8	5.2	-58.6	-13.0	-45.6
4	429.64	-58.9	-64.2	5.2	-59.0	-13.0	-46.0
5	547.98	-60.9	-64.9	4.7	-60.2	-13.0	-47.2
6	802.12	-65.0	-62.6	4.0	-58.6	-13.0	-45.6

Remarks:

1. Output Power (dBm) = S.G Value (dBm) + Correction Factor (dB).
2. Correction Factor (dB) = Substitution Antenna Gain (dB) + Cable Loss (dB).

Above 1GHz
GSM Mode

Mode	TX channel 512 (1850.2MHz)	Frequency Range	Above 1000MHz
Environmental Conditions	19deg. C, 66%RH	Input Power	120Vac, 60Hz
Tested By	Jones Chang		

Antenna Polarity & Test Distance: Horizontal at 3 M							
No.	Freq. (MHz)	Reading (dBm)	S.G Power Value (dBm)	Correction Factor (dB)	EIRP (dBm)	Limit (dBm)	Margin (dB)
1	3700.4	-55.2	-49.1	7.1	-42.0	-13.0	-29.0
2	5550.6	-50.5	-38.5	6.8	-31.7	-13.0	-18.7
3	7400.8	-56.3	-36.6	4.3	-32.3	-13.0	-19.3
Antenna Polarity & Test Distance: Vertical at 3 M							
No.	Freq. (MHz)	Reading (dBm)	S.G Power Value (dBm)	Correction Factor (dB)	EIRP (dBm)	Limit (dBm)	Margin (dB)
1	3700.4	-54.8	-48.7	7.1	-41.6	-13.0	-28.6
2	5550.6	-44.4	-34.3	6.8	-27.5	-13.0	-14.5
3	7400.8	-57.1	-38.7	4.3	-34.4	-13.0	-21.4

Remarks:

1. Output Power (dBm) = S.G Value (dBm) + Correction Factor (dB).
2. Correction Factor (dB) = Substitution Antenna Gain (dB) + Cable Loss (dB).

Mode	TX channel 661 (1880.0MHz)	Frequency Range	Above 1000MHz
Environmental Conditions	19deg. C, 66%RH	Input Power	120Vac, 60Hz
Tested By	Jones Chang		

Antenna Polarity & Test Distance: Horizontal at 3 M							
No.	Freq. (MHz)	Reading (dBm)	S.G Power Value (dBm)	Correction Factor (dB)	EIRP (dBm)	Limit (dBm)	Margin (dB)
1	3760.0	-56.7	-50.9	7.1	-43.8	-13.0	-30.8
2	5640.0	-50.3	-38.0	6.7	-31.3	-13.0	-18.3
3	7520.0	-57.6	-38.1	4.2	-33.9	-13.0	-20.9
Antenna Polarity & Test Distance: Vertical at 3 M							
No.	Freq. (MHz)	Reading (dBm)	S.G Power Value (dBm)	Correction Factor (dB)	EIRP (dBm)	Limit (dBm)	Margin (dB)
1	3760.0	-56.8	-50.9	7.1	-43.8	-13.0	-30.8
2	5640.0	-41.5	-31.2	6.7	-24.5	-13.0	-11.5
3	7520.0	-57.7	-38.9	4.2	-34.7	-13.0	-21.7

Remarks:

1. Output Power (dBm) = S.G Value (dBm) + Correction Factor (dB).
2. Correction Factor (dB) = Substitution Antenna Gain (dB) + Cable Loss (dB).

Mode	TX channel 810 (1909.8MHz)	Frequency Range	Above 1000MHz
Environmental Conditions	19deg. C, 66%RH	Input Power	120Vac, 60Hz
Tested By	Jones Chang		

Antenna Polarity & Test Distance: Horizontal at 3 M							
No.	Freq. (MHz)	Reading (dBm)	S.G Power Value (dBm)	Correction Factor (dB)	EIRP (dBm)	Limit (dBm)	Margin (dB)
1	3819.6	-55.6	-49.8	7.1	-42.7	-13.0	-29.7
2	5729.4	-51.9	-39.2	6.7	-32.5	-13.0	-19.5
3	7639.2	-55.9	-36.5	4.2	-32.3	-13.0	-19.3
Antenna Polarity & Test Distance: Vertical at 3 M							
No.	Freq. (MHz)	Reading (dBm)	S.G Power Value (dBm)	Correction Factor (dB)	EIRP (dBm)	Limit (dBm)	Margin (dB)
1	3819.6	-55.1	-49.2	7.1	-42.1	-13.0	-29.1
2	5729.4	-48.3	-36.9	6.7	-30.2	-13.0	-17.2
3	7639.2	-56.1	-37.9	4.2	-33.7	-13.0	-20.7

Remarks:

1. Output Power (dBm) = S.G Value (dBm) + Correction Factor (dB).
2. Correction Factor (dB) = Substitution Antenna Gain (dB) + Cable Loss (dB).

WCDMA Mode

Mode	TX channel 9262 (1852.4MHz)	Frequency Range	Above 1000MHz
Environmental Conditions	19deg. C, 66%RH	Input Power	120Vac, 60Hz
Tested By	Jones Chang		

Antenna Polarity & Test Distance: Horizontal at 3 M							
No.	Freq. (MHz)	Reading (dBm)	S.G Power Value (dBm)	Correction Factor (dB)	EIRP (dBm)	Limit (dBm)	Margin (dB)
1	3815.2	-59.7	-53.9	7.1	-46.8	-13.0	-33.8
2	5722.8	-46.6	-33.9	6.7	-27.2	-13.0	-14.2
3	7630.4	-60.2	-40.9	4.2	-36.7	-13.0	-23.7
Antenna Polarity & Test Distance: Vertical at 3 M							
No.	Freq. (MHz)	Reading (dBm)	S.G Power Value (dBm)	Correction Factor (dB)	EIRP (dBm)	Limit (dBm)	Margin (dB)
1	3815.2	-58.7	-52.8	7.1	-45.7	-13.0	-32.7
2	5722.8	-47.8	-36.5	6.7	-29.8	-13.0	-16.8
3	7630.4	-60.5	-42.4	4.2	-38.2	-13.0	-25.2

Remarks:

- Output Power (dBm) = S.G Value (dBm) + Correction Factor (dB).
- Correction Factor (dB) = Substitution Antenna Gain (dB) + Cable Loss (dB).

Mode	TX channel 9400 (1880.0MHz)	Frequency Range	Above 1000MHz
Environmental Conditions	19deg. C, 66%RH	Input Power	120Vac, 60Hz
Tested By	Jones Chang		

Antenna Polarity & Test Distance: Horizontal at 3 M							
No.	Freq. (MHz)	Reading (dBm)	S.G Power Value (dBm)	Correction Factor (dB)	EIRP (dBm)	Limit (dBm)	Margin (dB)
1	3760.0	-59.5	-53.7	7.1	-46.6	-13.0	-33.6
2	5640.0	-59.7	-47.4	6.7	-40.7	-13.0	-27.7
3	7520.0	-60.7	-41.2	4.2	-37.0	-13.0	-24.0
Antenna Polarity & Test Distance: Vertical at 3 M							
No.	Freq. (MHz)	Reading (dBm)	S.G Power Value (dBm)	Correction Factor (dB)	EIRP (dBm)	Limit (dBm)	Margin (dB)
1	3760.0	-58.3	-52.4	7.1	-45.3	-13.0	-32.3
2	5640.0	-50.7	-40.4	6.7	-33.7	-13.0	-20.7
3	7520.0	-59.1	-40.3	4.2	-36.1	-13.0	-23.1

Remarks:

- Output Power (dBm) = S.G Value (dBm) + Correction Factor (dB).
- Correction Factor (dB) = Substitution Antenna Gain (dB) + Cable Loss (dB).

Mode	TX channel 9538 (1907.6MHz)	Frequency Range	Above 1000MHz
Environmental Conditions	19deg. C, 66%RH	Input Power	120Vac, 60Hz
Tested By	Jones Chang		

Antenna Polarity & Test Distance: Horizontal at 3 M							
No.	Freq. (MHz)	Reading (dBm)	S.G Power Value (dBm)	Correction Factor (dB)	EIRP (dBm)	Limit (dBm)	Margin (dB)
1	3815.2	-57.6	-51.8	7.1	-44.7	-13.0	-31.7
2	5722.8	-48.6	-35.9	6.7	-29.2	-13.0	-16.2
3	7630.4	-61.3	-42.0	4.2	-37.8	-13.0	-24.8
Antenna Polarity & Test Distance: Vertical at 3 M							
No.	Freq. (MHz)	Reading (dBm)	S.G Power Value (dBm)	Correction Factor (dB)	EIRP (dBm)	Limit (dBm)	Margin (dB)
1	3815.2	-57.9	-52.0	7.1	-44.9	-13.0	-31.9
2	5722.8	-46.9	-35.6	6.7	-28.9	-13.0	-15.9
3	7630.4	-60.6	-42.5	4.2	-38.3	-13.0	-25.3

Remarks:

1. Output Power (dBm) = S.G Value (dBm) + Correction Factor (dB).
2. Correction Factor (dB) = Substitution Antenna Gain (dB) + Cable Loss (dB).

LTE Band 2, Channel Bandwidth: 1.4MHz

Mode	TX channel 18607 (1850.70MHz)	Frequency Range	Above 1000MHz
Environmental Conditions	20deg. C, 66%RH	Input Power	120Vac, 60Hz
Tested By	James Yang		

Antenna Polarity & Test Distance: Horizontal at 3 M							
No.	Freq. (MHz)	Reading (dBm)	S.G Power Value (dBm)	Correction Factor (dB)	EIRP (dBm)	Limit (dBm)	Margin (dB)
1	3701.4	-56.9	-50.8	7.1	-43.7	-13.0	-30.7
2	5552.1	-43.5	-31.5	6.8	-24.7	-13.0	-11.7
3	7402.8	-49.1	-29.4	4.3	-25.1	-13.0	-12.1
Antenna Polarity & Test Distance: Vertical at 3 M							
No.	Freq. (MHz)	Reading (dBm)	S.G Power Value (dBm)	Correction Factor (dB)	EIRP (dBm)	Limit (dBm)	Margin (dB)
1	3701.4	-53.8	-47.7	7.1	-40.6	-13.0	-27.6
2	5552.1	-45.4	-35.3	6.8	-28.5	-13.0	-15.5
3	7402.8	-53.3	-34.9	4.3	-30.6	-13.0	-17.6

Remarks:

- Output Power (dBm) = S.G Value (dBm) + Correction Factor (dB).
- Correction Factor (dB) = Substitution Antenna Gain (dB) + Cable Loss (dB).

Mode	TX channel 18900 (1880.00MHz)	Frequency Range	Above 1000MHz
Environmental Conditions	20deg. C, 66%RH	Input Power	120Vac, 60Hz
Tested By	James Yang		

Antenna Polarity & Test Distance: Horizontal at 3 M							
No.	Freq. (MHz)	Reading (dBm)	S.G Power Value (dBm)	Correction Factor (dB)	EIRP (dBm)	Limit (dBm)	Margin (dB)
1	3760.0	-56.4	-50.6	7.1	-43.5	-13.0	-30.5
2	5640.0	-45.8	-33.5	6.7	-26.8	-13.0	-13.8
3	7520.0	-52.5	-33.0	4.2	-28.8	-13.0	-15.8
Antenna Polarity & Test Distance: Vertical at 3 M							
No.	Freq. (MHz)	Reading (dBm)	S.G Power Value (dBm)	Correction Factor (dB)	EIRP (dBm)	Limit (dBm)	Margin (dB)
1	3760.0	-54.6	-48.7	7.1	-41.6	-13.0	-28.6
2	5640.0	-46.0	-35.7	6.7	-29.0	-13.0	-16.0
3	7520.0	-55.7	-36.9	4.2	-32.7	-13.0	-19.7

Remarks:

- Output Power (dBm) = S.G Value (dBm) + Correction Factor (dB).
- Correction Factor (dB) = Substitution Antenna Gain (dB) + Cable Loss (dB).

Mode	TX channel 19193 (1909.30MHz)	Frequency Range	Above 1000MHz
Environmental Conditions	20deg. C, 66%RH	Input Power	120Vac, 60Hz
Tested By	James Yang		

Antenna Polarity & Test Distance: Horizontal at 3 M							
No.	Freq. (MHz)	Reading (dBm)	S.G Power Value (dBm)	Correction Factor (dB)	EIRP (dBm)	Limit (dBm)	Margin (dB)
1	3818.6	-55.5	-49.7	7.1	-42.6	-13.0	-29.6
2	5727.9	-44.0	-31.3	6.7	-24.6	-13.0	-11.6
3	7637.2	-54.1	-34.7	4.2	-30.5	-13.0	-17.5
Antenna Polarity & Test Distance: Vertical at 3 M							
No.	Freq. (MHz)	Reading (dBm)	S.G Power Value (dBm)	Correction Factor (dB)	EIRP (dBm)	Limit (dBm)	Margin (dB)
1	3818.6	-51.1	-45.2	7.1	-38.1	-13.0	-25.1
2	5727.9	-44.3	-32.9	6.7	-26.2	-13.0	-13.2
3	7637.2	-58.0	-39.8	4.2	-35.6	-13.0	-22.6

Remarks:

1. Output Power (dBm) = S.G Value (dBm) + Correction Factor (dB).
2. Correction Factor (dB) = Substitution Antenna Gain (dB) + Cable Loss (dB).

LTE Band 2, Channel Bandwidth: 3MHz

Mode	TX channel 18615 (1851.50MHz)	Frequency Range	Above 1000MHz
Environmental Conditions	20deg. C, 66%RH	Input Power	120Vac, 60Hz
Tested By	James Yang		

Antenna Polarity & Test Distance: Horizontal at 3 M							
No.	Freq. (MHz)	Reading (dBm)	S.G Power Value (dBm)	Correction Factor (dB)	EIRP (dBm)	Limit (dBm)	Margin (dB)
1	3703.0	-57.3	-51.2	7.1	-44.1	-13.0	-31.1
2	5554.5	-42.5	-30.5	6.8	-23.7	-13.0	-10.7
3	7406.0	-49.8	-30.1	4.3	-25.8	-13.0	-12.8
Antenna Polarity & Test Distance: Vertical at 3 M							
No.	Freq. (MHz)	Reading (dBm)	S.G Power Value (dBm)	Correction Factor (dB)	EIRP (dBm)	Limit (dBm)	Margin (dB)
1	3703.0	-53.6	-47.5	7.1	-40.4	-13.0	-27.4
2	5554.5	-44.9	-34.8	6.8	-28.0	-13.0	-15.0
3	7406.0	-52.8	-34.4	4.3	-30.1	-13.0	-17.1

Remarks:

1. Output Power (dBm) = S.G Value (dBm) + Correction Factor (dB).
2. Correction Factor (dB) = Substitution Antenna Gain (dB) + Cable Loss (dB).

Mode	TX channel 18900 (1880.00MHz)	Frequency Range	Above 1000MHz
Environmental Conditions	20deg. C, 66%RH	Input Power	120Vac, 60Hz
Tested By	James Yang		

Antenna Polarity & Test Distance: Horizontal at 3 M							
No.	Freq. (MHz)	Reading (dBm)	S.G Power Value (dBm)	Correction Factor (dB)	EIRP (dBm)	Limit (dBm)	Margin (dB)
1	3760.0	-57.0	-51.2	7.1	-44.1	-13.0	-31.1
2	5640.0	-44.6	-32.3	6.7	-25.6	-13.0	-12.6
3	7520.0	-52.3	-32.8	4.2	-28.6	-13.0	-15.6
Antenna Polarity & Test Distance: Vertical at 3 M							
No.	Freq. (MHz)	Reading (dBm)	S.G Power Value (dBm)	Correction Factor (dB)	EIRP (dBm)	Limit (dBm)	Margin (dB)
1	3760.0	-53.9	-48.0	7.1	-40.9	-13.0	-27.9
2	5640.0	-45.1	-34.8	6.7	-28.1	-13.0	-15.1
3	7520.0	-56.4	-37.6	4.2	-33.4	-13.0	-20.4

Remarks:

1. Output Power (dBm) = S.G Value (dBm) + Correction Factor (dB).
2. Correction Factor (dB) = Substitution Antenna Gain (dB) + Cable Loss (dB).

Mode	TX channel 19185 (1908.50MHz)	Frequency Range	Above 1000MHz
Environmental Conditions	20deg. C, 66%RH	Input Power	120Vac, 60Hz
Tested By	James Yang		

Antenna Polarity & Test Distance: Horizontal at 3 M							
No.	Freq. (MHz)	Reading (dBm)	S.G Power Value (dBm)	Correction Factor (dB)	EIRP (dBm)	Limit (dBm)	Margin (dB)
1	3817.0	-55.8	-50.0	7.1	-42.9	-13.0	-29.9
2	5725.5	-44.2	-31.5	6.7	-24.8	-13.0	-11.8
3	7634.0	-59.8	-40.4	4.2	-36.2	-13.0	-23.2
Antenna Polarity & Test Distance: Vertical at 3 M							
No.	Freq. (MHz)	Reading (dBm)	S.G Power Value (dBm)	Correction Factor (dB)	EIRP (dBm)	Limit (dBm)	Margin (dB)
1	3817.0	-50.5	-44.6	7.1	-37.5	-13.0	-24.5
2	5725.5	-44.4	-33.0	6.7	-26.3	-13.0	-13.3
3	7634.0	-58.7	-40.6	4.2	-36.4	-13.0	-23.4

Remarks:

1. Output Power (dBm) = S.G Value (dBm) + Correction Factor (dB).
2. Correction Factor (dB) = Substitution Antenna Gain (dB) + Cable Loss (dB).

LTE Band 2, Channel Bandwidth: 5MHz

Mode	TX channel 18625 (1852.50MHz)	Frequency Range	Above 1000MHz
Environmental Conditions	20deg. C, 66%RH	Input Power	120Vac, 60Hz
Tested By	James Yang		

Antenna Polarity & Test Distance: Horizontal at 3 M							
No.	Freq. (MHz)	Reading (dBm)	S.G Power Value (dBm)	Correction Factor (dB)	EIRP (dBm)	Limit (dBm)	Margin (dB)
1	3705.0	-58.2	-52.1	7.1	-45.0	-13.0	-32.0
2	5557.5	-49.3	-37.3	6.8	-30.5	-13.0	-17.5
Antenna Polarity & Test Distance: Vertical at 3 M							
No.	Freq. (MHz)	Reading (dBm)	S.G Power Value (dBm)	Correction Factor (dB)	EIRP (dBm)	Limit (dBm)	Margin (dB)
1	3705.0	-58.2	-52.1	7.1	-45.0	-13.0	-32.0
2	5557.5	-50.8	-40.8	6.8	-34.0	-13.0	-21.0

Remarks:

1. Output Power (dBm) = S.G Value (dBm) + Correction Factor (dB).
2. Correction Factor (dB) = Substitution Antenna Gain (dB) + Cable Loss (dB).

Mode	TX channel 18900 (1880.00MHz)	Frequency Range	Above 1000MHz
Environmental Conditions	20deg. C, 66%RH	Input Power	120Vac, 60Hz
Tested By	James Yang		

Antenna Polarity & Test Distance: Horizontal at 3 M							
No.	Freq. (MHz)	Reading (dBm)	S.G Power Value (dBm)	Correction Factor (dB)	EIRP (dBm)	Limit (dBm)	Margin (dB)
1	3760.0	-57.7	-51.9	7.1	-44.8	-13.0	-31.8
2	5640.0	-50.6	-38.3	6.7	-31.6	-13.0	-18.6
Antenna Polarity & Test Distance: Vertical at 3 M							
No.	Freq. (MHz)	Reading (dBm)	S.G Power Value (dBm)	Correction Factor (dB)	EIRP (dBm)	Limit (dBm)	Margin (dB)
1	3760.0	-56.7	-50.8	7.1	-43.7	-13.0	-30.7
2	5640.0	-52.0	-41.7	6.7	-35.0	-13.0	-22.0

Remarks:

1. Output Power (dBm) = S.G Value (dBm) + Correction Factor (dB).
2. Correction Factor (dB) = Substitution Antenna Gain (dB) + Cable Loss (dB).

Mode	TX channel 19175 (1907.50MHz)	Frequency Range	Above 1000MHz
Environmental Conditions	20deg. C, 66%RH	Input Power	120Vac, 60Hz
Tested By	James Yang		

Antenna Polarity & Test Distance: Horizontal at 3 M							
No.	Freq. (MHz)	Reading (dBm)	S.G Power Value (dBm)	Correction Factor (dB)	EIRP (dBm)	Limit (dBm)	Margin (dB)
1	3815.0	-58.0	-52.2	7.1	-45.1	-13.0	-32.1
2	5722.5	-49.4	-36.7	6.7	-30.0	-13.0	-17.0
Antenna Polarity & Test Distance: Vertical at 3 M							
No.	Freq. (MHz)	Reading (dBm)	S.G Power Value (dBm)	Correction Factor (dB)	EIRP (dBm)	Limit (dBm)	Margin (dB)
1	3815.0	-54.4	-48.5	7.1	-41.4	-13.0	-28.4
2	5722.5	-49.0	-37.7	6.7	-31.0	-13.0	-18.0

Remarks:

1. Output Power (dBm) = S.G Value (dBm) + Correction Factor (dB).
2. Correction Factor (dB) = Substitution Antenna Gain (dB) + Cable Loss (dB).

LTE Band 2, Channel Bandwidth: 10MHz

Mode	TX channel 18650 (1855.00MHz)	Frequency Range	Above 1000MHz
Environmental Conditions	20deg. C, 66%RH	Input Power	120Vac, 60Hz
Tested By	James Yang		

Antenna Polarity & Test Distance: Horizontal at 3 M							
No.	Freq. (MHz)	Reading (dBm)	S.G Power Value (dBm)	Correction Factor (dB)	EIRP (dBm)	Limit (dBm)	Margin (dB)
1	3710.0	-58.5	-52.4	7.1	-45.3	-13.0	-32.3
2	5565.0	-49.1	-37.1	6.8	-30.3	-13.0	-17.3
Antenna Polarity & Test Distance: Vertical at 3 M							
No.	Freq. (MHz)	Reading (dBm)	S.G Power Value (dBm)	Correction Factor (dB)	EIRP (dBm)	Limit (dBm)	Margin (dB)
1	3710.0	-57.2	-51.1	7.1	-44.0	-13.0	-31.0
2	5565.0	-50.4	-40.4	6.8	-33.6	-13.0	-20.6

Remarks:

1. Output Power (dBm) = S.G Value (dBm) + Correction Factor (dB).
2. Correction Factor (dB) = Substitution Antenna Gain (dB) + Cable Loss (dB).

Mode	TX channel 18900 (1880.00MHz)	Frequency Range	Above 1000MHz
Environmental Conditions	20deg. C, 66%RH	Input Power	120Vac, 60Hz
Tested By	James Yang		

Antenna Polarity & Test Distance: Horizontal at 3 M							
No.	Freq. (MHz)	Reading (dBm)	S.G Power Value (dBm)	Correction Factor (dB)	EIRP (dBm)	Limit (dBm)	Margin (dB)
1	3760.0	-58.5	-52.7	7.1	-45.6	-13.0	-32.6
2	5640.0	-52.1	-39.8	6.7	-33.1	-13.0	-20.1
Antenna Polarity & Test Distance: Vertical at 3 M							
No.	Freq. (MHz)	Reading (dBm)	S.G Power Value (dBm)	Correction Factor (dB)	EIRP (dBm)	Limit (dBm)	Margin (dB)
1	3760.0	-57.8	-51.9	7.1	-44.8	-13.0	-31.8
2	5640.0	-51.4	-41.1	6.7	-34.4	-13.0	-21.4

Remarks:

1. Output Power (dBm) = S.G Value (dBm) + Correction Factor (dB).
2. Correction Factor (dB) = Substitution Antenna Gain (dB) + Cable Loss (dB).

Mode	TX channel 19150 (1905.00MHz)	Frequency Range	Above 1000MHz
Environmental Conditions	20deg. C, 66%RH	Input Power	120Vac, 60Hz
Tested By	James Yang		

Antenna Polarity & Test Distance: Horizontal at 3 M							
No.	Freq. (MHz)	Reading (dBm)	S.G Power Value (dBm)	Correction Factor (dB)	EIRP (dBm)	Limit (dBm)	Margin (dB)
1	3810.0	-58.7	-53.0	7.1	-45.9	-13.0	-32.9
2	5715.0	-49.8	-37.2	6.7	-30.5	-13.0	-17.5
Antenna Polarity & Test Distance: Vertical at 3 M							
No.	Freq. (MHz)	Reading (dBm)	S.G Power Value (dBm)	Correction Factor (dB)	EIRP (dBm)	Limit (dBm)	Margin (dB)
1	3810.0	-56.2	-50.4	7.1	-43.3	-13.0	-30.3
2	5715.0	-51.6	-40.3	6.7	-33.6	-13.0	-20.6

Remarks:

1. Output Power (dBm) = S.G Value (dBm) + Correction Factor (dB).
2. Correction Factor (dB) = Substitution Antenna Gain (dB) + Cable Loss (dB).

LTE Band 2, Channel Bandwidth: 15MHz

Mode	TX channel 18675 (1857.50MHz)	Frequency Range	Above 1000MHz
Environmental Conditions	20deg. C, 66%RH	Input Power	120Vac, 60Hz
Tested By	James Yang		

Antenna Polarity & Test Distance: Horizontal at 3 M							
No.	Freq. (MHz)	Reading (dBm)	S.G Power Value (dBm)	Correction Factor (dB)	EIRP (dBm)	Limit (dBm)	Margin (dB)
1	3715.0	-57.3	-51.3	7.1	-44.2	-13.0	-31.2
2	5572.5	-43.3	-31.3	6.8	-24.5	-13.0	-11.5
3	7430.0	-47.8	-28.1	4.3	-23.8	-13.0	-10.8
Antenna Polarity & Test Distance: Vertical at 3 M							
No.	Freq. (MHz)	Reading (dBm)	S.G Power Value (dBm)	Correction Factor (dB)	EIRP (dBm)	Limit (dBm)	Margin (dB)
1	3715.0	-54.6	-48.5	7.1	-41.4	-13.0	-28.4
2	5572.5	-44.3	-34.4	6.8	-27.6	-13.0	-14.6
3	7430.0	-50.8	-32.3	4.3	-28.0	-13.0	-15.0

Remarks:

1. Output Power (dBm) = S.G Value (dBm) + Correction Factor (dB).
2. Correction Factor (dB) = Substitution Antenna Gain (dB) + Cable Loss (dB).

Mode	TX channel 18900 (1880.00MHz)	Frequency Range	Above 1000MHz
Environmental Conditions	20deg. C, 66%RH	Input Power	120Vac, 60Hz
Tested By	James Yang		

Antenna Polarity & Test Distance: Horizontal at 3 M							
No.	Freq. (MHz)	Reading (dBm)	S.G Power Value (dBm)	Correction Factor (dB)	EIRP (dBm)	Limit (dBm)	Margin (dB)
1	3760.0	-57.7	-51.9	7.1	-44.8	-13.0	-31.8
2	5640.0	-42.1	-29.8	6.7	-23.1	-13.0	-10.1
3	7520.0	-51.9	-32.4	4.2	-28.2	-13.0	-15.2
Antenna Polarity & Test Distance: Vertical at 3 M							
No.	Freq. (MHz)	Reading (dBm)	S.G Power Value (dBm)	Correction Factor (dB)	EIRP (dBm)	Limit (dBm)	Margin (dB)
1	3760.0	-53.5	-47.6	7.1	-40.5	-13.0	-27.5
2	5640.0	-42.6	-32.3	6.7	-25.6	-13.0	-12.6
3	7520.0	-57.1	-38.3	4.2	-34.1	-13.0	-21.1

Remarks:

1. Output Power (dBm) = S.G Value (dBm) + Correction Factor (dB).
2. Correction Factor (dB) = Substitution Antenna Gain (dB) + Cable Loss (dB).

Mode	TX channel 19125 (1902.50MHz)	Frequency Range	Above 1000MHz
Environmental Conditions	20deg. C, 66%RH	Input Power	120Vac, 60Hz
Tested By	James Yang		

Antenna Polarity & Test Distance: Horizontal at 3 M							
No.	Freq. (MHz)	Reading (dBm)	S.G Power Value (dBm)	Correction Factor (dB)	EIRP (dBm)	Limit (dBm)	Margin (dB)
1	3805.0	-55.5	-49.8	7.1	-42.7	-13.0	-29.7
2	5707.5	-42.8	-30.2	6.7	-23.5	-13.0	-10.5
3	7610.0	-55.1	-35.8	4.2	-31.6	-13.0	-18.6
Antenna Polarity & Test Distance: Vertical at 3 M							
No.	Freq. (MHz)	Reading (dBm)	S.G Power Value (dBm)	Correction Factor (dB)	EIRP (dBm)	Limit (dBm)	Margin (dB)
1	3805.0	-51.7	-45.9	7.1	-38.8	-13.0	-25.8
2	5707.5	-43.8	-32.6	6.7	-25.9	-13.0	-12.9
3	7610.0	-58.6	-40.7	4.2	-36.5	-13.0	-23.5

Remarks:

1. Output Power (dBm) = S.G Value (dBm) + Correction Factor (dB).
2. Correction Factor (dB) = Substitution Antenna Gain (dB) + Cable Loss (dB).

LTE Band 2, Channel Bandwidth: 20MHz

Mode	TX channel 18700 (1860.00MHz)	Frequency Range	Above 1000MHz
Environmental Conditions	19deg. C, 66%RH	Input Power	120Vac, 60Hz
Tested By	Chris Lin		

Antenna Polarity & Test Distance: Horizontal at 3 M							
No.	Freq. (MHz)	Reading (dBm)	S.G Power Value (dBm)	Correction Factor (dB)	EIRP (dBm)	Limit (dBm)	Margin (dB)
1	3800.0	-54.0	-47.1	7.1	-40.0	-13.0	-27.0
2	5700.0	-47.7	-34.7	6.7	-28.0	-13.0	-15.0
3	7600.0	-60.0	-39.7	4.2	-35.5	-13.0	-22.5
Antenna Polarity & Test Distance: Vertical at 3 M							
No.	Freq. (MHz)	Reading (dBm)	S.G Power Value (dBm)	Correction Factor (dB)	EIRP (dBm)	Limit (dBm)	Margin (dB)
1	3800.0	-57.5	-49.8	7.1	-42.7	-13.0	-29.7
2	5700.0	-46.7	-35.6	6.7	-28.9	-13.0	-15.9
3	7600.0	-60.5	-40.5	4.2	-36.3	-13.0	-23.3

Remarks:

1. Output Power (dBm) = S.G Value (dBm) + Correction Factor (dB).
2. Correction Factor (dB) = Substitution Antenna Gain (dB) + Cable Loss (dB).

Mode	TX channel 18900 (1880.00MHz)	Frequency Range	Above 1000MHz
Environmental Conditions	19deg. C, 66%RH	Input Power	120Vac, 60Hz
Tested By	Chris Lin		

Antenna Polarity & Test Distance: Horizontal at 3 M							
No.	Freq. (MHz)	Reading (dBm)	S.G Power Value (dBm)	Correction Factor (dB)	EIRP (dBm)	Limit (dBm)	Margin (dB)
1	3760.0	-61.9	-55.4	7.1	-48.3	-13.0	-35.3
2	5640.0	-47.5	-35.2	6.7	-28.5	-13.0	-15.5
3	7520.0	-60.4	-39.9	4.2	-35.7	-13.0	-22.7
Antenna Polarity & Test Distance: Vertical at 3 M							
No.	Freq. (MHz)	Reading (dBm)	S.G Power Value (dBm)	Correction Factor (dB)	EIRP (dBm)	Limit (dBm)	Margin (dB)
1	3760.0	-56.9	-49.5	7.1	-42.4	-13.0	-29.4
2	5640.0	-47.1	-35.7	6.7	-29.0	-13.0	-16.0
3	7520.0	-60.5	-40.3	4.2	-36.1	-13.0	-23.1

Remarks:

1. Output Power (dBm) = S.G Value (dBm) + Correction Factor (dB).
2. Correction Factor (dB) = Substitution Antenna Gain (dB) + Cable Loss (dB).

Mode	TX channel 19100 (1900.00MHz)	Frequency Range	Above 1000MHz
Environmental Conditions	19deg. C, 66%RH	Input Power	120Vac, 60Hz
Tested By	Chris Lin		

Antenna Polarity & Test Distance: Horizontal at 3 M							
No.	Freq. (MHz)	Reading (dBm)	S.G Power Value (dBm)	Correction Factor (dB)	EIRP (dBm)	Limit (dBm)	Margin (dB)
1	3760.0	-61.9	-55.4	7.1	-48.3	-13.0	-35.3
2	5640.0	-47.5	-35.2	6.7	-28.5	-13.0	-15.5
3	7520.0	-60.4	-39.9	4.2	-35.7	-13.0	-22.7
Antenna Polarity & Test Distance: Vertical at 3 M							
No.	Freq. (MHz)	Reading (dBm)	S.G Power Value (dBm)	Correction Factor (dB)	EIRP (dBm)	Limit (dBm)	Margin (dB)
1	3720.0	-58.4	-51.2	7.1	-44.1	-13.0	-31.1
2	5580.0	-47.5	-36.1	6.8	-29.3	-13.0	-16.3
3	7440.0	-59.1	-39.3	4.3	-35.0	-13.0	-22.0

Remarks:

1. Output Power (dBm) = S.G Value (dBm) + Correction Factor (dB).
2. Correction Factor (dB) = Substitution Antenna Gain (dB) + Cable Loss (dB).

5 Pictures of Test Arrangements

Please refer to the attached file (Test Setup Photo).

Appendix – Information on the Testing Laboratories

We, Bureau Veritas Consumer Products Services (H.K.) Ltd., Taoyuan Branch, were founded in 1988 to provide our best service in EMC, Radio, Telecom and Safety consultation. Our laboratories are accredited and approved according to ISO/IEC 17025.

If you have any comments, please feel free to contact us at the following:

Linko EMC/RF Lab

Tel: 886-2-26052180

Fax: 886-2-26051924

Hsin Chu EMC/RF/Telecom Lab

Tel: 886-3-6668565

Fax: 886-3-6668323

Hwa Ya EMC/RF/Safety Lab

Tel: 886-3-3183232

Fax: 886-3-3270892

Email: service.adt@tw.bureauveritas.com

Web Site: www.bureauveritas-adt.com

The address and road map of all our labs can be found in our web site also.

--- END ---