

Test Report

Product Name : Mobile Computer
Model No. : RS36
FCC ID : Q3N-RS36
IC : 5121A-RS36

Applicant (for FCC) : CipherLab Co., Ltd.
Applicant (for IC) : CIPHERLAB CO. LTD.
Address : 12F, 333, Dunhua S.Rd., Sec.2, Taipei, Taiwan

Date of Receipt : 2022/10/13
Issued Date : 2023/03/28
Report No. : 22A0299R-RFUSV22S-A
Report Version : V1.0



The test results relate only to the samples tested.
The test results shown in the test report are traceable to the national/international standard through the calibration report of the equipment and evaluated measurement uncertainty herein.
This report must not be used to claim product endorsement by TAF or any agency of the government.
The test report shall not be reproduced without the written approval of DEKRA Testing and Certification Co., Ltd.
Measurement uncertainties evaluated for each testing system and associated connections are given here to provide the system information for reference. Compliance determinations do not take into account measurement uncertainties for each testing system, but are based on the results of the compliance measurement.

Test Report



Product Name : Mobile Computer
Applicant (for FCC) : CipherLab Co., Ltd.
Applicant (for IC) : CIPHERLAB CO. LTD.
Address : 12F, 333, Dunhua S.Rd., Sec.2, Taipei, Taiwan
Manufacturer : CIPHERLAB CO. LTD.
Trade Name : CIPHERLAB
Model No. : RS36
EUT Rated Voltage : DC 5V (adapter or host equipment)
DC 3.85V for battery
EUT Test Voltage : DC 3.85V
Measurement Standard : FCC CFR Title 47 Part 22 ; Part 24 ; Part 27
RSS-132 Issue 4, RSS-133 Issue 6+A1, RSS-139 Issue 4
Measurement Reference : FCC CFR Title 47 Part 2, TIA/EIA 603-E 2016,
KDB 971168 D01V03R01, ANSI C63.26 2015,
RSS-GEN Issue 5+A2
Test Result : Complied

Documented By :

Ida Tung

(Project Specialist / Ida Tung)

Tested By :

Daniel Wu

(Engineer / Daniel Wu)

Approved By :

Tim Sung

(Manager / Tim Sung)

TABLE OF CONTENTS

1.	General Information	5
1.1.	EUT Description.....	5
1.2.	Antenna List.....	6
1.3.	Operational Description	7
1.4.	Configuration of tested System.....	8
1.5.	EUT Setup Procedures.....	8
1.6.	Test Facility	9
2.	Technical Test.....	10
2.1.	Summary of test result.....	10
2.2.	List of test Equipment	12
2.3.	Measurement Uncertainty.....	13
3.	Conducted Output Power Measurement.....	14
3.1.	Test Specification	14
3.2.	Test Setup.....	14
3.3.	Limits	14
3.4.	Test Procedure.....	14
3.5.	Test Result of Maximum Power Output and ERP/EIRP Power	15
4.	Occupied Bandwidth	20
4.1.	Test Specification	20
4.2.	Test Setup.....	20
4.3.	Test Procedure.....	20
4.4.	Test Result of Occupied Bandwidth	21
5.	Spurious Emission At Antenna Terminals (+/-1MHz)	27
5.1.	Test Specification	27
5.2.	Setup	27
5.3.	Limits	27
5.4.	Test Procedure.....	27
5.5.	Test Result of Spurious Emission At Antenna Terminals (+/-1MHz).....	28
6.	Spurious Emission.....	31
6.1.	Test Specification	31
6.2.	Test Setup.....	31
6.3.	Limits	32
6.4.	Test Procedure.....	32
6.5.	Test Result of Spurious Emission	33
7.	Frequency Stability Under Temperature & Voltage Variations	55
7.1.	Test Specification	55
7.2.	Test Setup.....	55
7.3.	Limits	55
7.4.	Test Procedure.....	55
7.5.	Test Result of Frequency Stability Under Temperature Variations	56
8.	Peak to Average Ratio	61
8.1.	Test Specification	61
8.2.	Test Setup.....	61
8.3.	Limits	61
8.4.	Test Procedure.....	61
8.5.	Test Result of Peak to Average Ratio	62

Appendix 1: EUT Test Photographs

Appendix 2: Product Photos - Please refer to the file: 22A0299R-Product Photos

Revision History

Report No.	Version	Description	Issued Date
22A0299R-RFUSV22S-A	V1.0	Initial issue of report.	2023/03/28

1. General Information

1.1. EUT Description

Product Name	Mobile Computer
Model No.	RS36
Trade Name	CIPHERLAB
IMEI No.	35226598
FCC ID	Q3N-RS36
IC	5121A-RS36
TX Frequency	GSM 850: 824.2 MHz ~ 848.8 MHz GSM 1900: 1850.2 MHz ~ 1909.8MHz WCDMA Band 2: 1852.4 MHz ~ 1907.6 MHz WCDMA Band 4: 1712.4 MHz ~ 1752.6 MHz WCDMA Band 5: 826.4 MHz ~ 846.6 MHz
RX Frequency	GSM 850: 869.2 MHz ~ 893.8 MHz GSM 1900: 1930.2 MHz ~ 1989.8 MHz WCDMA Band 2: 1932.4 MHz ~ 1987.6 MHz WCDMA Band 4: 2112.4 MHz ~ 2152.6 MHz WCDMA Band 5: 871.4 MHz ~ 891.6 MHz
Function	GSM / GPRS / EDGE / WCDMA / HSDPA / HSUPA
Type of Modulation	GMSK / 8PSK / QPSK
Power Cable (Optional)	Trade Name: CIPHERLAB, M/N: RS35 SNAP ON, Non-shielded, 1.5m
Adapter #1 (Optional)	Trade Name: Sunny, M/N: SYS1561-1005 Input: AC 100-240V~, 1.0A MAX, 50-60Hz Output: +5.0V=2.0A
Adapter #2 (Optional)	Trade Name: CWT, M/N: 2AEA010BC3D Input: AC 100-240V~ 50/60Hz 0.35A Output: 5.0V=2.0A 10.0W

Supported Unit	
Type C Cable	Trade Name: SUNCA, M/N: 1Q11512211-XJ, Shielded, 1m

1.2. Antenna List

No.	Manufacturer	Part No.	Antenna Type	Peak Gain
1	Auden	KZWLSLSVS0001 (LTE Main, TX/RX)	PIFA	0.5 dBi for GSM850 2.5 dBi for GSM1900 2.5 dBi for WCDMA Band 2 3.1 dBi for WCDMA Band 4 0.5 dBi for WCDMA Band 5
2	Auden	KZWLSLSVS0001 (LTE Aux, TX/RX)	PIFA	-4.5 dBi for GSM850 -2.0 dBi for GSM1900 -2.0 dBi for WCDMA Band 2 -2.9 dBi for WCDMA Band 4 -4.5 dBi for WCDMA Band 5

Note: The above EUT information is declared by the manufacturer

1.3. Operational Description

The EUT provide all functions described as above. The EUT is tested with maximum rated TX power via the Base Station simulator. DEKRA has verified the construction and function in typical operation. All the test modes were carried out with the EUT in normal operation, which was shown in this test report and defined as:

Test Mode	Mode 1: GSM 850 Mode 2: GSM 1900 Mode 3: WCDMA Band 2 Mode 4: WCDMA Band 4 Mode 5: WCDMA Band 5
-----------	---

Note:

1. Regards to the frequency band operation; the lowest, middle and highest frequency of channel were selected to perform the test, and then shown on this report.
2. This device was tested under all bandwidths, RB configurations and modulations. The worst case was found in VOICE mode for GSM, and RMC mode for WCDMA, and show the worst case in the test report.
3. Determining compliance shall be based on the results of the compliance measurement, not taking into account measurement instrumentation uncertainty.
4. The EUT was performed at X axis, Y axis and Z axis position for radiated spurious emission tests. The worst case was found at X axis for GSM and Z axis for WCDMA, so the measurement will follow this same test configuration

1.4. Configuration of tested System

(a) Configuration of Radiated measurement

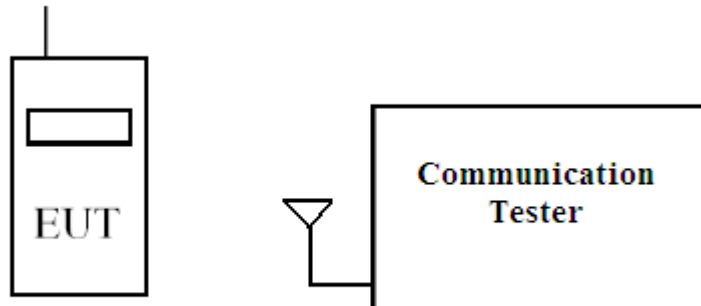

(b) Configuration of Conducted measurement

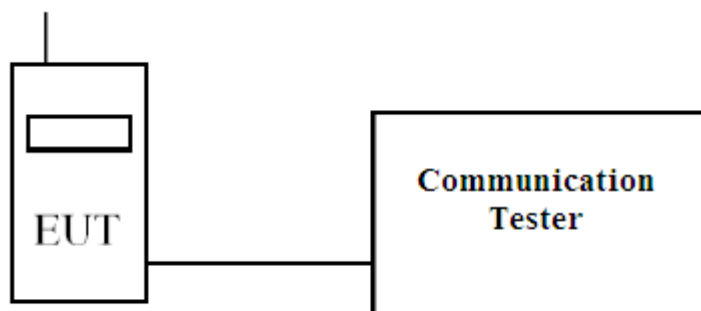

1.5. EUT Setup Procedures

- (1) Setup the EUT and simulators as shown on 1.4
- (2) Turn on the power of all equipment.
- (3) The EUT was set to communicate with Base Station simulator.
- (4) Repeat the above procedure (3).

1.6. Test Facility

Ambient conditions in the laboratory:

Performed Item	Items	Actual	Test Date
Radiated Emission	Temperature (°C)	25.3 °C	2022/12/06 ~ 2022/12/16
	Humidity (%RH)	69.9 %	
Conductive	Temperature (°C)	24.2 °C	
	Humidity (%RH)	50.0 %	

USA : **FCC Registration Number: TW0033**
Canada : **CAB Identifier Number: TW3023 / Company Number: 26930**

Site Description : Accredited by TAF
Accredited Number: 3023

Test Laboratory : DEKRA Testing and Certification Co., Ltd
Address : No. 5-22, Ruishukeng Linkou District, New Taipei City, 24451, Taiwan
Performed : No. 26, Huaya 1st Rd., Guishan Dist., Taoyuan City 333411, Taiwan,
Location : R.O.C.
Phone number : +886-3-275-7255
Fax number : +886-3-327-8031
Email address : info.tw@dekra.com
Website : <http://www.dekra.com.tw>

2. Technical Test

2.1. Summary of test result

Test Item	FCC Reference section	FCC Limit	Result
Conducted Output Power	§2.1046	<7 Watts for §22.913(a) <2 Watts for §24.232(c) <1 Watts for §27.50(d)	Pass
	§22.913(a)		
	§24.232(c)		
	§27.50(d)		
Occupied Bandwidth	§2.1049	Within the frequency range	Pass
	§22.863		
	§24.238(b)		
	§27.53(h)		
Spurious Emission at Antenna Terminals	§2.1051	<-13dBm	Pass
	§22.917(a)		
	§24.238(a)		
	§27.53(h)		
Conducted Emission	§2.1051	<-13dBm	Pass
	§22.917(a)		
	§24.238(a)		
	§27.53(h)		
Field Strength of Spurious Radiation	§2.1053	<-13dBm	Pass
	§22.917(a)		
	§24.238(a)		
	§27.53(h)		
Frequency Stability for Temperature & Voltage	§2.1055	<±2.5 ppm for §22.355 Within the frequency range for §24.235, §27.54	Pass
	§22.355		
	§24.235		
	§27.54		
Peak to Average Ratio	§22.913 (d)	<13dB	Pass
	§24.232 (d)		
	§27.50 (d)		

Test Item	IC Reference section	IC Limit	Result
Conducted Output Power	RSS GEN §6.12	<11.5 Watts for RSS 132 §5.4 <2 Watts for RSS 133 §6.4 <1 Watts for RSS 139 §6.5	Pass
	RSS 132 §5.4		
	RSS 133 §6.4		
	RSS 139 §6.5		
Occupied Bandwidth	RSS GEN §6.7	Within the frequency range	Pass
	RSS 132 §5.3		
	RSS 133 §6.3		
	RSS 139 §6.4		
Spurious Emission at Antenna Terminals	RSS GEN §6.13	<-13dBm	Pass
	RSS 132 §5.5		
	RSS 133 §6.5		
	RSS 139 §6.6		
Conducted Emission	RSS GEN §6.13	<-13dBm	Pass
	RSS 132 §5.5		
	RSS 133 §6.5		
	RSS 139 §6.6		
Field Strength of Spurious Radiation	RSS GEN §6.13	<-13dBm	Pass
	RSS 132 §5.5		
	RSS 133 §6.5		
	RSS 139 §6.6		
Frequency Stability for Temperature & Voltage	RSS GEN §6.11	<±2.5 ppm for RSS 132 §5.3, RSS 133 §6.3 Within the frequency range for RSS 139 §6.4	Pass
	RSS 132 §5.3		
	RSS 133 §6.3		
	RSS 139 §6.4		
Peak to Average Ratio	RSS 132 §5.4	<13dB	Pass
	RSS 133 §6.4		
	RSS 139 §6.5		

2.2. List of test Equipment

Conducted / HY-SR03

Instrument Description	Manufacturer	Model No.	Serial No.	Last Calibration	Next Calibration
Spectrum Analyzer	Agilent	N9010A	MY51440132	2022/01/07	2023/01/06
Standard Temperature & Humidity Chamber	K SON	THS-D4T-100	A0606	2022/08/23	2023/08/22
DC Power Supply	Keysight	E36234A	MY59001234	2022/10/31	2023/10/30
Universal Radio communication tester	R&S	CMU200	113574	2022/06/06	2023/06/05

Radiated / HY-CB03

Instrument Description	Manufacturer	Model No.	Serial No.	Last Calibration	Next Calibration
Bi-Log Antenna	SCHWARZBECK	VULB9168	9168-675	2021/08/11	2023/08/10
Horn Antenna	Com-Power	AH-840	101100	2021/10/04	2023/10/03
Horn Antenna	RF SPIN	DRH18-E	210508A18ES	2022/06/08	2023/06/07
Pre-Amplifier	SGH	0301	20211007-10	2022/02/22	2023/02/21
Pre-Amplifier	SGH	PRAMP118	20200701	2022/07/28	2023/07/27
Pre-Amplifier	EMCI	EMC05820SE	980310	2022/07/28	2023/07/27
Pre-Amplifier	EMCI	EMC184045SE	980369		
Coaxial Cable	EMCI	EMC102-KM-K M-600	1160314	2022/05/12	2023/05/11
Coaxial Cable	EMCI	EMC102-KM-K M-7000	170242		
Spectrum Analyzer	R&S	FSV3044	101114	2022/02/11	2023/02/10
Coaxial Cable	SGH	SGH18	2021005-1		
Coaxial Cable	SGH	SGH18	202108-4	2022/3/18	2023/03/17
Coaxial Cable	SGH	HA800	GD20110223-1		
Coaxial Cable	SGH	HA800	GD20110222-3		
Universal Radio communication tester	R&S	CMU200	113574	2022/06/06	2023/06/05

2.3. Measurement Uncertainty

Uncertainties have been calculated according to the DEKRA internal document with the emissions test results be included in the report. The measurement uncertainties given below are based on a 95 % confidence level based on a coverage factor (k=2).

Test Item	Uncertainty
Conducted Output Power	± 1.52 dB
Occupied Bandwidth	± 5.32 Hz
Peak to Average Ratio	± 1.52 dB
Conducted Band Edge	± 1.52 dB
Conducted Spurious Emissions	± 1.52 dB
Radiated Spurious Emissions	± 4.05 dB below 1 GHz ± 4.10 dB above 1 GHz
Frequency Stability	± 220.92 Hz

3. Conducted Output Power Measurement

3.1. Test Specification

According to Part 2.1046, 22.913, 24.232, 27.50, RSS-GEN, RSS-132, RSS-133, RSS-139.

3.2. Test Setup

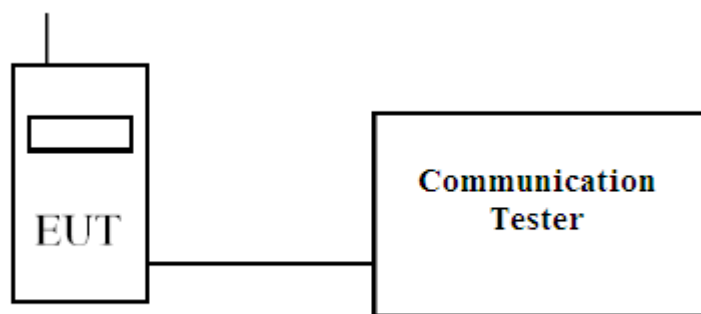

3.3. Limits

Band	Limit
850	ERP < 7 W
1900	EIRP < 2 W
AWS(1700)	EIRP < 1 W

3.4. Test Procedure

The EUT is tested with maximum rated TX power via the Base Station simulator, and the output power was measured at the antenna terminals of the EUT.

3.5. Test Result of Maximum Power Output and ERP/EIRP Power

$$\text{EIRP} = \text{PT} + \text{GT} - \text{LC} = \text{ERP} + 2.15 \text{ dB}, \text{ERP} = \text{EIRP} - 2.15 \text{ dB}$$

PT = transmitter output power in dBm

GT = gain of the transmitting antenna in dBi

LC = signal attenuation in the connecting cable between the transmitter and antenna in dB

GSM 850						
Test Mode	Frequency (MHz)	Conducted Power (dBm)	Antenna Gain (dBi)	ERP (dBm)	ERP (W)	ERP Limit (W)
Voice	824.2	32.77	0.5	31.120	1.294	7
	836.6	32.79	0.5	31.140	1.300	7
	848.8	32.75	0.5	31.100	1.288	7
GPRS 850 (↑)	824.2	32.75	0.5	31.100	1.288	7
	836.6	32.78	0.5	31.130	1.297	7
	848.8	32.65	0.5	31.000	1.259	7
GPRS 850 (↑↑)	824.2	31.01	0.5	29.360	0.863	7
	836.6	31.21	0.5	29.560	0.904	7
	848.8	31.02	0.5	29.370	0.865	7
GPRS 850 (↑↑↑)	824.2	29.66	0.5	28.010	0.632	7
	836.6	29.85	0.5	28.200	0.661	7
	848.8	29.84	0.5	28.190	0.659	7
GPRS 850 (↑↑↑↑)	824.2	29.59	0.5	27.940	0.622	7
	836.6	29.61	0.5	27.960	0.625	7
	848.8	29.55	0.5	27.900	0.617	7
EGPRS 850 (↑)	824.2	25.17	0.5	23.520	0.225	7
	836.6	25.58	0.5	23.930	0.247	7
	848.8	25.39	0.5	23.740	0.237	7
EGPRS 850 (↑↑)	824.2	22.64	0.5	20.990	0.126	7
	836.6	23.23	0.5	21.580	0.144	7
	848.8	23.01	0.5	21.360	0.137	7
EGPRS 850 (↑↑↑)	824.2	19.94	0.5	18.290	0.067	7
	836.6	20.59	0.5	18.940	0.078	7
	848.8	20.27	0.5	18.620	0.073	7
EGPRS 850 (↑↑↑↑)	824.2	18.17	0.5	16.520	0.045	7
	836.6	18.73	0.5	17.080	0.051	7
	848.8	18.51	0.5	16.860	0.049	7

GSM 1900						
Test Mode	Frequency (MHz)	Conducted Power (dBm)	Antenna Gain (dBi)	EIRP (dBm)	EIRP (W)	EIRP Limit (W)
Voice	1850.2	30.47	2.5	32.970	1.982	2
	1880.0	30.50	2.5	33.000	1.995	2
	1909.8	30.32	2.5	32.820	1.914	2
GPRS 1900 (↑)	1850.2	30.41	2.5	32.910	1.954	2
	1880.0	30.45	2.5	32.950	1.972	2
	1909.8	30.15	2.5	32.650	1.841	2
GPRS 1900 (↑↑)	1850.2	29.77	2.5	32.270	1.687	2
	1880.0	29.84	2.5	32.340	1.714	2
	1909.8	29.78	2.5	32.280	1.690	2
GPRS 1900 (↑↑↑)	1850.2	28.23	2.5	30.730	1.183	2
	1880.0	28.32	2.5	30.820	1.208	2
	1909.8	28.21	2.5	30.710	1.178	2
GPRS 1900 (↑↑↑↑)	1850.2	27.37	2.5	29.870	0.971	2
	1880.0	27.38	2.5	29.880	0.973	2
	1909.8	27.17	2.5	29.670	0.927	2
EGPRS 1900 (↑)	1850.2	23.94	2.5	26.440	0.441	2
	1880.0	23.95	2.5	26.450	0.442	2
	1909.8	23.82	2.5	26.320	0.429	2
EGPRS 1900 (↑↑)	1850.2	23.90	2.5	26.400	0.437	2
	1880.0	23.91	2.5	26.410	0.438	2
	1909.8	23.78	2.5	26.280	0.425	2
EGPRS 1900 (↑↑↑)	1850.2	22.05	2.5	24.550	0.285	2
	1880.0	22.10	2.5	24.600	0.288	2
	1909.8	22.04	2.5	24.540	0.284	2
EGPRS 1900 (↑↑↑↑)	1850.2	20.61	2.5	23.110	0.205	2
	1880.0	20.63	2.5	23.130	0.206	2
	1909.8	20.14	2.5	22.640	0.184	2

WCDMA Band 2						
Test Mode	Frequency (MHz)	Conducted Power (dBm)	Antenna Gain (dBi)	EIRP (dBm)	EIRP (W)	EIRP Limit (W)
Voice	1852.4	22.31	2.5	24.810	0.303	2
	1880	22.52	2.5	25.020	0.318	2
	1907.6	22.41	2.5	24.910	0.310	2
RMC	1852.4	22.37	2.5	24.870	0.307	2
	1880	22.65	2.5	25.150	0.327	2
	1907.6	22.46	2.5	24.960	0.313	2
HSUPA Subtest 1	1852.4	20.22	2.5	22.720	0.187	2
	1880	20.76	2.5	23.260	0.212	2
	1907.6	20.25	2.5	22.750	0.188	2
HSUPA Subtest 2	1852.4	20.05	2.5	22.550	0.180	2
	1880	20.56	2.5	23.060	0.202	2
	1907.6	20.31	2.5	22.810	0.191	2
HSUPA Subtest 3	1852.4	20.28	2.5	22.780	0.190	2
	1880	20.45	2.5	22.950	0.197	2
	1907.6	20.34	2.5	22.840	0.192	2
HSUPA Subtest 4	1852.4	19.96	2.5	22.460	0.176	2
	1880	20.69	2.5	23.190	0.208	2
	1907.6	20.31	2.5	22.810	0.191	2
HSUPA Subtest 5	1852.4	20.21	2.5	22.710	0.187	2
	1880	20.52	2.5	23.020	0.200	2
	1907.6	20.30	2.5	22.800	0.191	2
HSDPA Subtest 1	1852.4	20.59	2.5	23.090	0.204	2
	1880	21.22	2.5	23.720	0.236	2
	1907.6	20.90	2.5	23.400	0.219	2
HSDPA Subtest 2	1852.4	20.60	2.5	23.100	0.204	2
	1880	21.05	2.5	23.550	0.226	2
	1907.6	20.89	2.5	23.390	0.218	2
HSDPA Subtest 3	1852.4	20.61	2.5	23.110	0.205	2
	1880	21.05	2.5	23.550	0.226	2
	1907.6	20.89	2.5	23.390	0.218	2
HSDPA Subtest 4	1852.4	20.66	2.5	23.160	0.207	2
	1880	21.04	2.5	23.540	0.226	2
	1907.6	20.83	2.5	23.330	0.215	2

WCDMA Band 4						
Test Mode	Frequency (MHz)	Conducted Power (dBm)	Antenna Gain (dBi)	EIRP (dBm)	EIRP (W)	EIRP Limit (W)
Voice	1712.4	18.44	3.1	21.540	0.143	1
	1732.6	18.77	3.1	21.870	0.154	1
	1752.6	18.61	3.1	21.710	0.148	1
RMC	1712.4	18.54	3.1	21.640	0.146	1
	1732.6	18.83	3.1	21.930	0.156	1
	1752.6	18.72	3.1	21.820	0.152	1
HSUPA Subtest 1	1712.4	17.93	3.1	21.030	0.127	1
	1732.6	18.30	3.1	21.400	0.138	1
	1752.6	18.05	3.1	21.153	0.130	1
HSUPA Subtest 2	1712.4	17.73	3.1	20.830	0.121	1
	1732.6	18.18	3.1	21.280	0.134	1
	1752.6	18.04	3.1	21.140	0.130	1
HSUPA Subtest 3	1712.4	17.86	3.1	20.960	0.125	1
	1732.6	18.40	3.1	21.500	0.141	1
	1752.6	17.99	3.1	21.090	0.129	1
HSUPA Subtest 4	1712.4	17.77	3.1	20.870	0.122	1
	1732.6	18.22	3.1	21.320	0.136	1
	1752.6	18.10	3.1	21.200	0.132	1
HSUPA Subtest 5	1712.4	17.87	3.1	20.970	0.125	1
	1732.6	18.30	3.1	21.400	0.138	1
	1752.6	18.08	3.1	21.180	0.131	1
HSDPA Subtest 1	1712.4	18.19	3.1	21.290	0.135	1
	1732.6	18.62	3.1	21.720	0.149	1
	1752.6	18.50	3.1	21.600	0.145	1
HSDPA Subtest 2	1712.4	18.20	3.1	21.300	0.135	1
	1732.6	18.52	3.1	21.620	0.145	1
	1752.6	18.40	3.1	21.500	0.141	1
HSDPA Subtest 3	1712.4	18.21	3.1	21.310	0.135	1
	1732.6	18.51	3.1	21.610	0.145	1
	1752.6	18.39	3.1	21.490	0.141	1
HSDPA Subtest 4	1712.4	18.25	3.1	21.350	0.136	1
	1732.6	18.54	3.1	21.640	0.146	1
	1752.6	18.42	3.1	21.520	0.142	1

WCDMA Band 5						
Test Mode	Frequency (MHz)	Conducted Power (dBm)	Antenna Gain (dBi)	ERP (dBm)	ERP (W)	ERP Limit (W)
Voice	826.4	22.57	0.5	20.920	0.124	7
	836.6	22.63	0.5	20.980	0.125	7
	846.6	22.58	0.5	20.930	0.124	7
RMC	826.4	23.03	0.5	21.380	0.137	7
	836.6	23.12	0.5	21.470	0.140	7
	846.6	23.01	0.5	21.360	0.137	7
HSUPA Subtest 1	826.4	21.01	0.5	19.360	0.086	7
	836.6	21.14	0.5	19.490	0.089	7
	846.6	20.99	0.5	19.340	0.086	7
HSUPA Subtest 2	826.4	20.83	0.5	19.180	0.083	7
	836.6	21.12	0.5	19.470	0.089	7
	846.6	20.93	0.5	19.280	0.085	7
HSUPA Subtest 3	826.4	20.90	0.5	19.250	0.084	7
	836.6	21.02	0.5	19.371	0.087	7
	846.6	21.02	0.5	19.370	0.086	7
HSUPA Subtest 4	826.4	20.87	0.5	19.220	0.084	7
	836.6	20.99	0.5	19.340	0.086	7
	846.6	20.94	0.5	19.290	0.085	7
HSUPA Subtest 5	826.4	20.64	0.5	18.990	0.079	7
	836.6	21.09	0.5	19.440	0.088	7
	846.6	20.75	0.5	19.100	0.081	7
HSDPA Subtest 1	826.4	21.54	0.5	19.890	0.097	7
	836.6	21.60	0.5	19.950	0.099	7
	846.6	21.55	0.5	19.900	0.098	7
HSDPA Subtest 2	826.4	21.50	0.5	19.850	0.097	7
	836.6	21.61	0.5	19.960	0.099	7
	846.6	21.56	0.5	19.910	0.098	7
HSDPA Subtest 3	826.4	21.48	0.5	19.830	0.096	7
	836.6	21.61	0.5	19.960	0.099	7
	846.6	21.55	0.5	19.900	0.098	7
HSDPA Subtest 4	826.4	21.48	0.5	19.830	0.096	7
	836.6	21.64	0.5	19.990	0.100	7
	846.6	21.43	0.5	19.780	0.095	7

4. Occupied Bandwidth

4.1. Test Specification

According to Part 2.1049, 22.863, 24.238, 27.53, RSS-GEN, RSS-132, RSS-133, RSS-139.

4.2. Test Setup

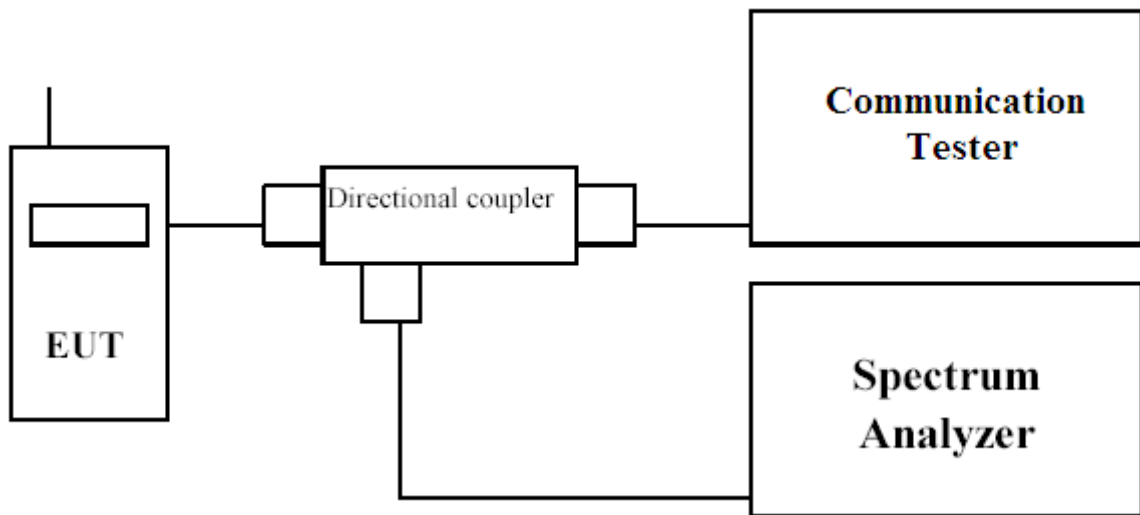

4.3. Test Procedure

The EUT is tested with maximum rated TX power via the Base Station simulator, and the occupied bandwidth was measured at the antenna terminals of the EUT. The Resolution BW of the analyzer is set to 1 % of the emission bandwidth. The EUT's occupied bandwidth is measured as the width of the signal between two points, one below the carrier center frequency and one above the carrier frequency, outside of which all emissions are attenuated at least 26 dB below the transmitter power. The plots below show the resultant display from the Spectrum Analyser.

4.4. Test Result of Occupied Bandwidth

GSM 850				
BW	Channel	Frequency (MHz)	99% Occupied Bandwidth (kHz)	26 dB bandwidth (kHz)
VOICE	128	824.2	245.48	316.4
VOICE	189	836.4	244.04	318.0
VOICE	251	848.8	243.77	308.7
EGPRS	128	824.2	243.26	312.5
EGPRS	189	836.4	245.17	308.9
EGPRS	251	848.8	244.02	316.1

GSM 1900				
BW	Channel	Frequency (MHz)	99% Occupied Bandwidth (kHz)	26 dB bandwidth (kHz)
VOICE	512	1850.2	243.08	316.4
VOICE	661	1880	246.46	313.4
VOICE	810	1909.8	242.02	309.3
EGPRS	512	1850.2	243.61	305.7
EGPRS	661	1880	241.92	314.0
EGPRS	810	1909.8	242.67	308.5

WCDMA Band2				
BW	Channel	Frequency (MHz)	99% Occupied Bandwidth (MHz)	26 dB bandwidth (MHz)
RMC	9262	1852.4	4.1107	4.698
RMC	9400	1880	4.1104	4.686
RMC	9538	1907.6	4.1118	4.679

WCDMA Band4				
BW	Channel	Frequency (MHz)	99% Occupied Bandwidth (MHz)	26 dB bandwidth (MHz)
RMC	1312	1712.4	4.1105	4.693
RMC	1413	1732.6	4.1101	4.690
RMC	1513	1752.6	4.1120	4.702

WCDMA Band5				
BW	Channel	Frequency (MHz)	99% Occupied Bandwidth (MHz)	26 dB bandwidth (MHz)
RMC	4132	826.4	4.1116	4.703
RMC	4183	836.6	4.1169	4.693
RMC	4233	846.6	4.1183	4.698

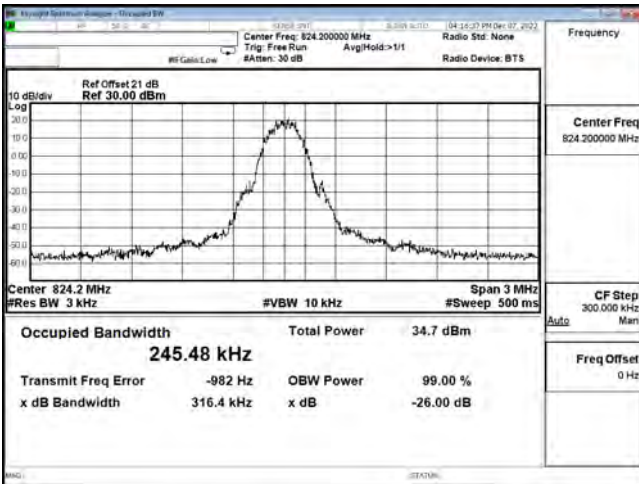

OCC 2G850 CH128 VOICE

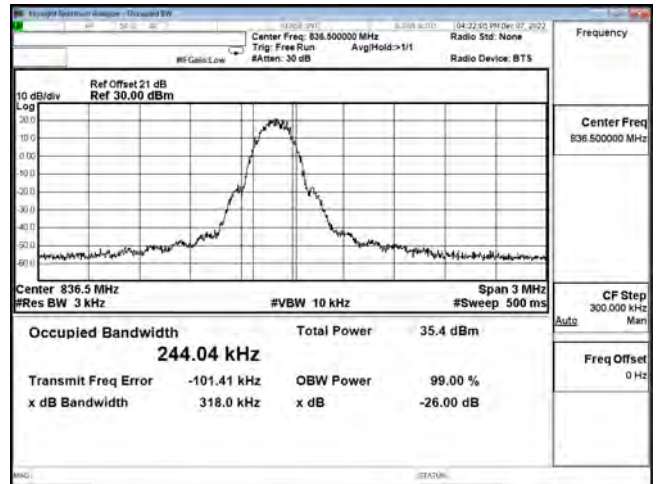

OCC 2G850 CH189 VOICE

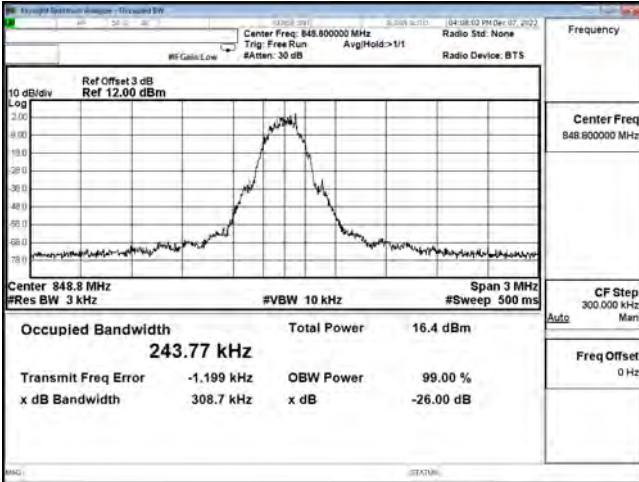

OCC 2G850 CH251 VOICE

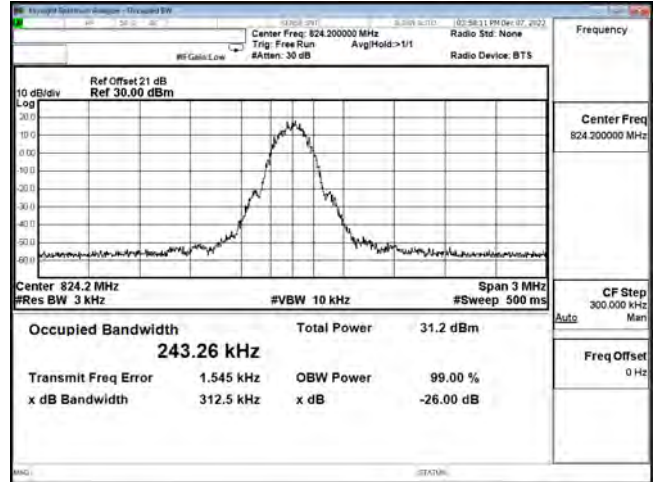

OCC 2G850 CH128 EGPRS

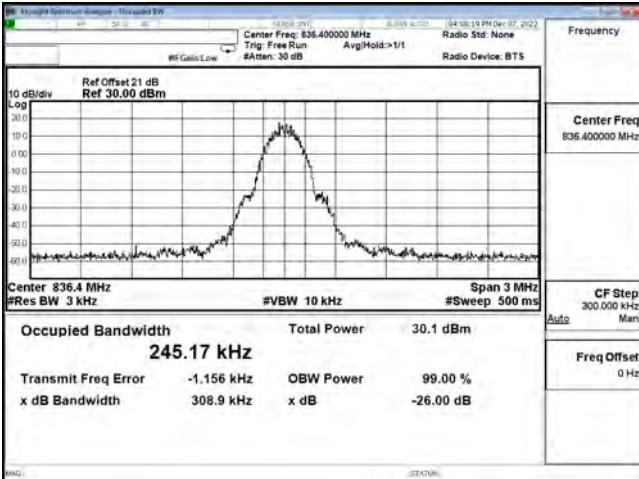

OCC 2G850 CH189 EGPRS

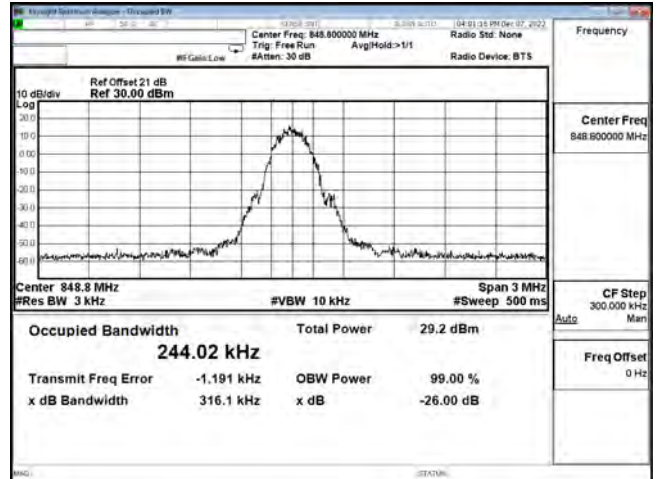

OCC 2G850 CH251 EGPRS

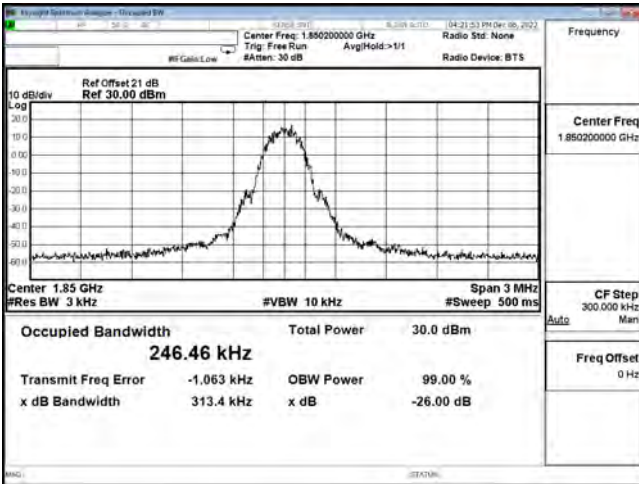

OCC 2G1900 CH512 VOICE

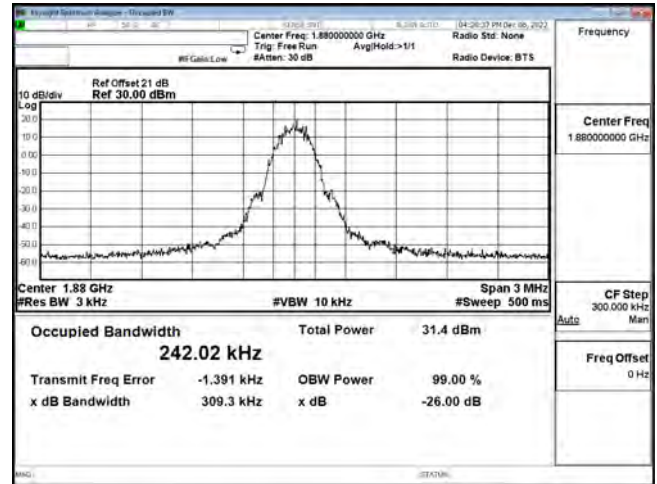

OCC 2G1900 CH661 VOICE

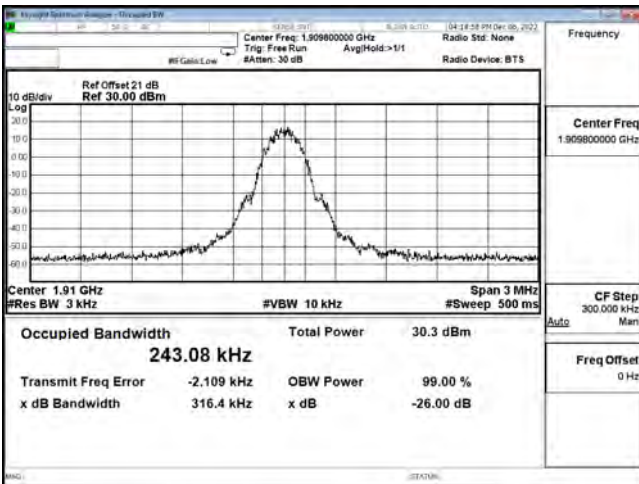

OCC 2G1900 CH810 VOICE

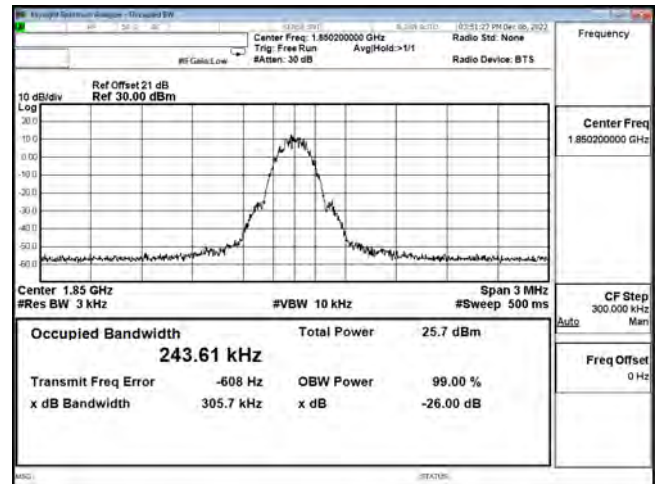

OCC 2G1900 CH512 EGPRS

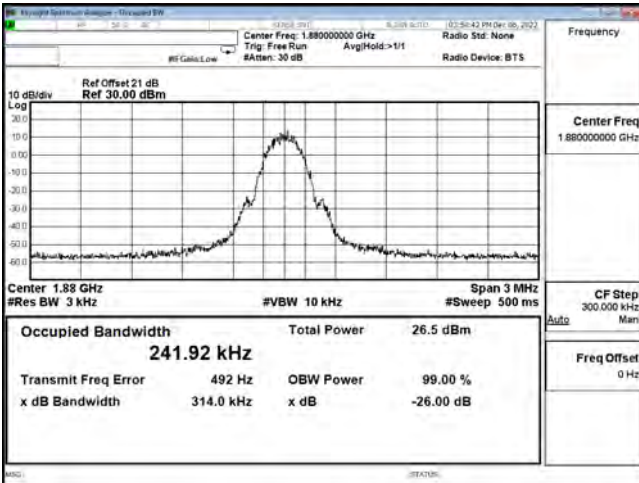

OCC 2G1900 CH661 EGPRS

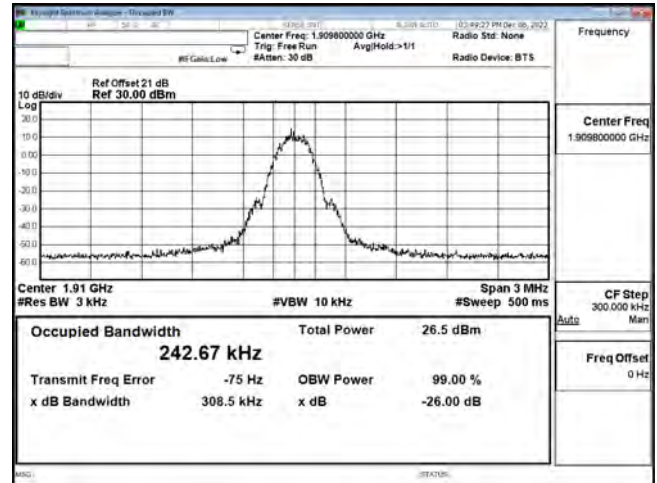

OCC 2G1900 CH810 EGPRS

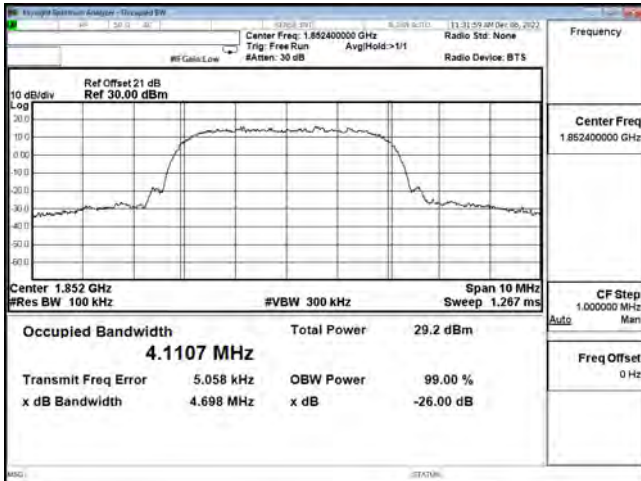

OCC B2 CH9262 RMC

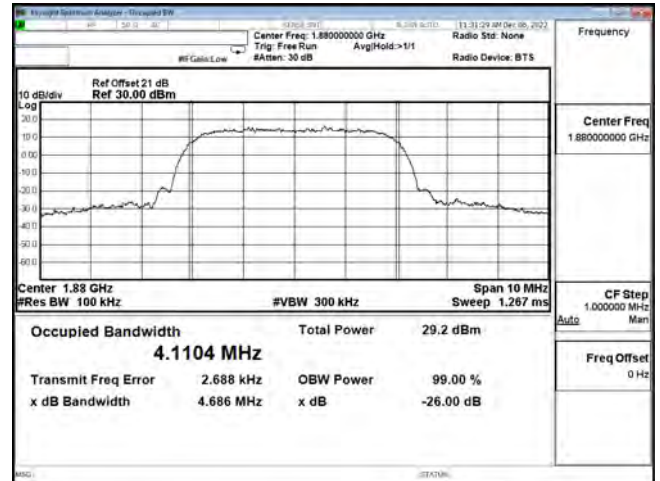

OCC B2 CH9400 RMC

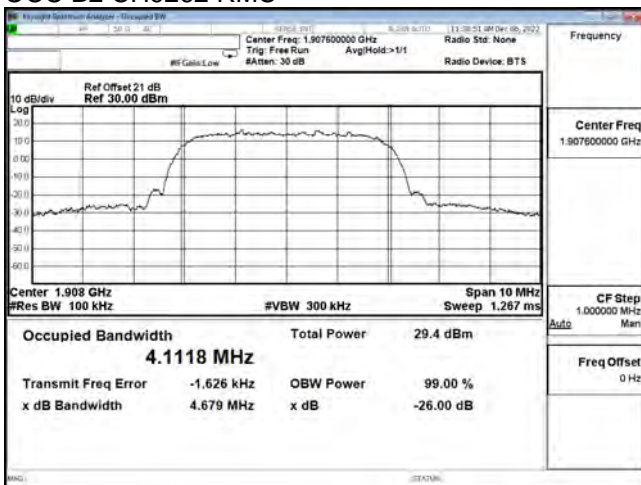

OCC B2 CH9538 RMC

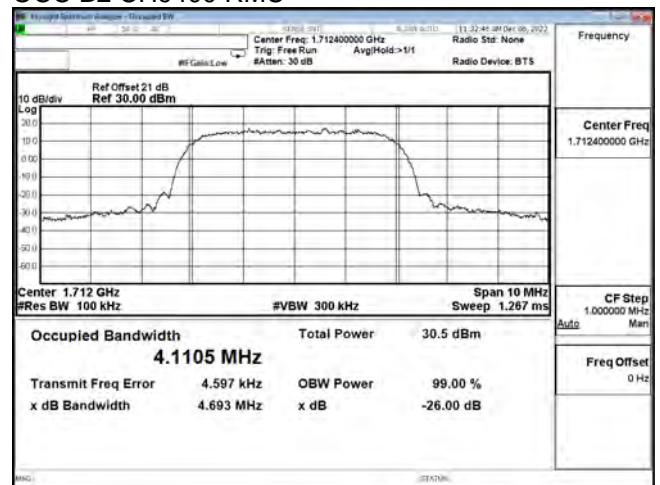

OCC B4 CH1312 RMC

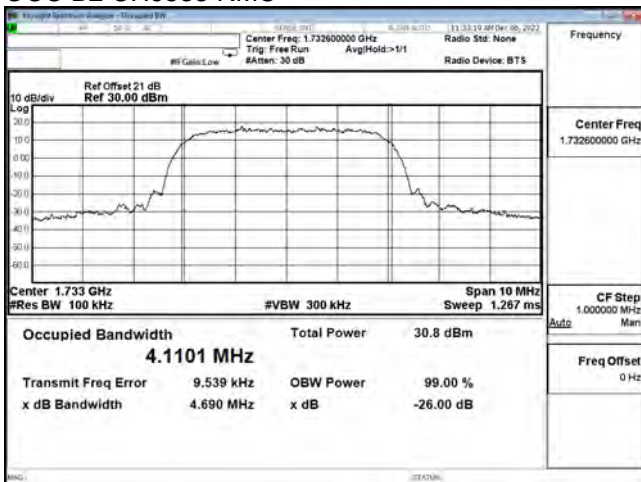

OCC B4 CH1413 RMC

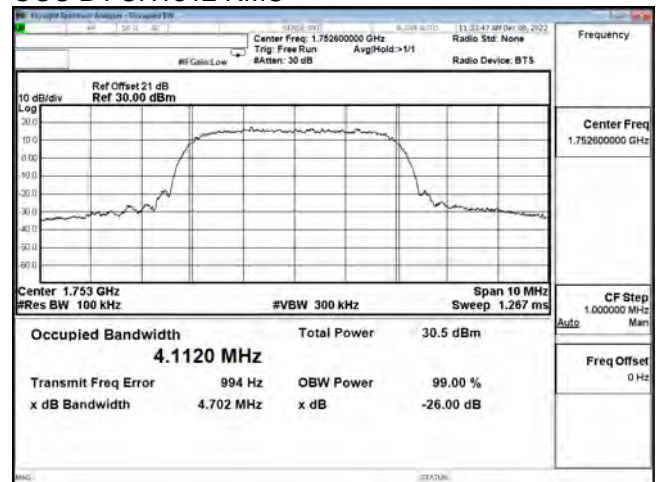

OCC B4 CH1513 RMC

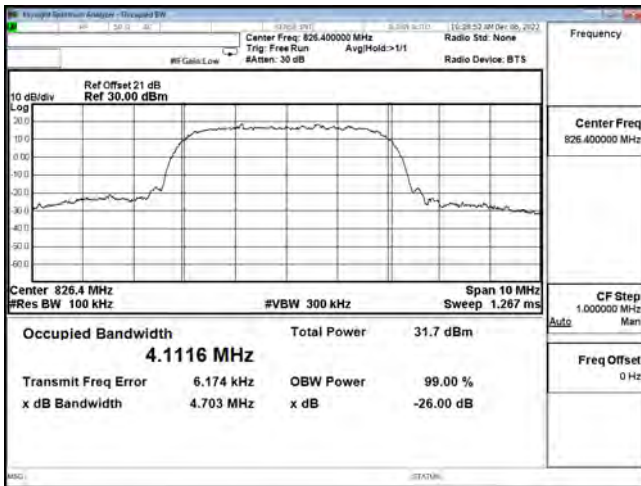

OCC B5 CH4132 RMC

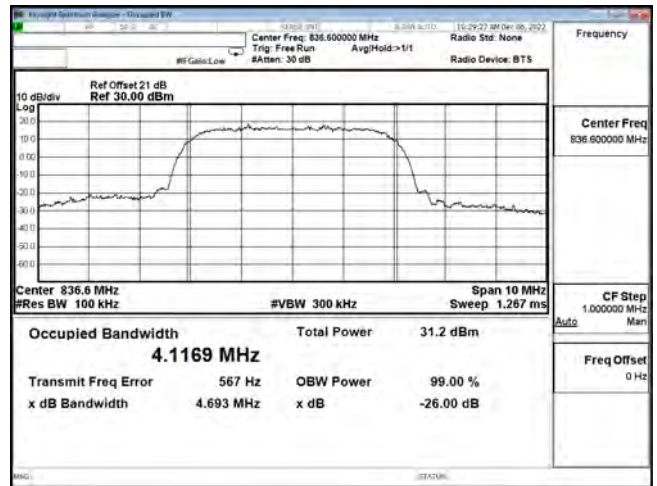

OCC B5 CH4183 RMC

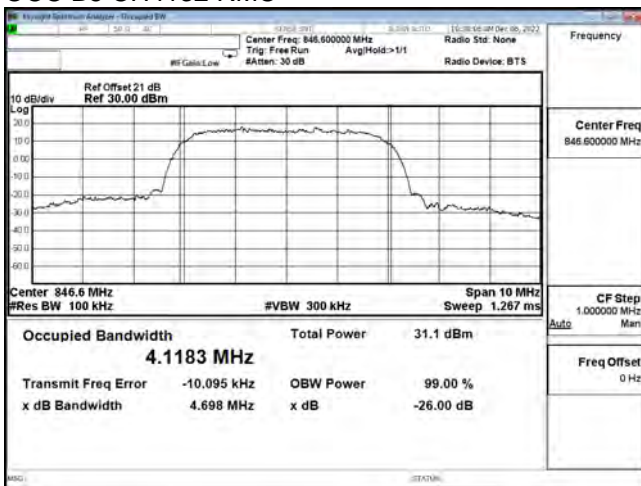

OCC B5 CH4233 RMC

5. Spurious Emission At Antenna Terminals (+/-1MHz)

5.1. Test Specification

According to Part 2.1051, 22.917, 24.238, 27.53, RSS-GEN, RSS-132, RSS-133, RSS-139.

5.2. Setup

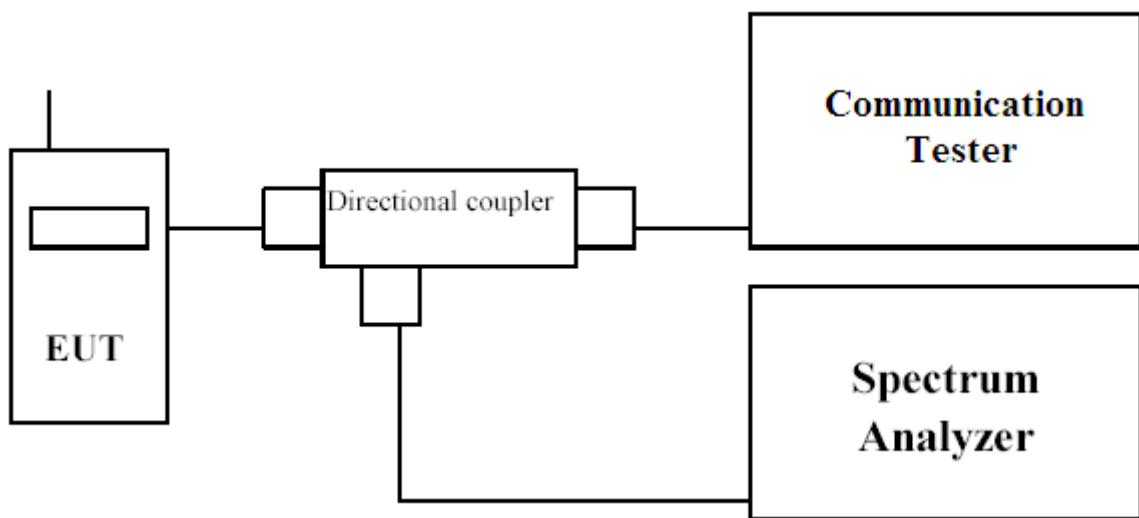

5.3. Limits

The power of any emission outside of the authorized operating frequency ranges must be attenuated below the transmitting power (P) by a factor of at least $43 + 10 \log(P)$ dB.

5.4. Test Procedure

In accordance with Part 22.917, 24.238, 27.53, at least 1% of the emission bandwidth was used for the resolution and video bandwidths up to 1MHz away from the Block Edge. At greater than 1MHz, the resolution and video bandwidth were set $3 \times \text{RBW}$. The reference power and path losses of all channels used for testing in each frequency block were measured.

5.5. Test Result of Spurious Emission At Antenna Terminals (+/-1MHz)

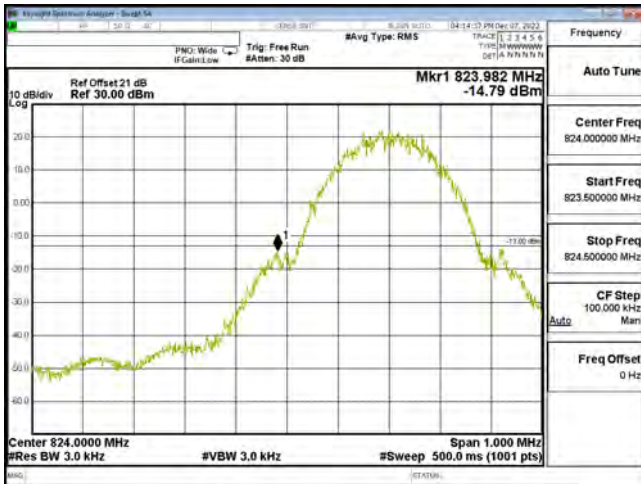

Bandedge 2G850 CH128 VOICE

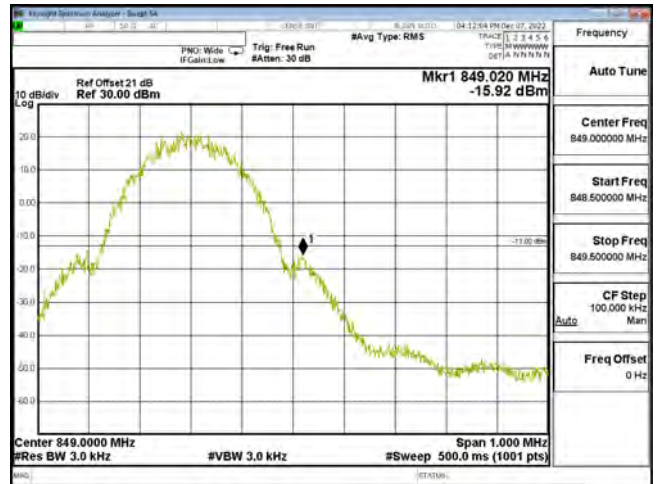

Bandedge 2G850 CH251 VOICE

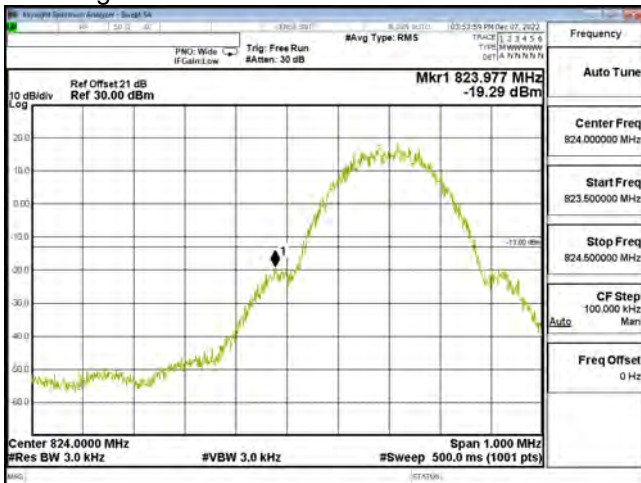

Bandedge 2G850 CH128 EGPRS

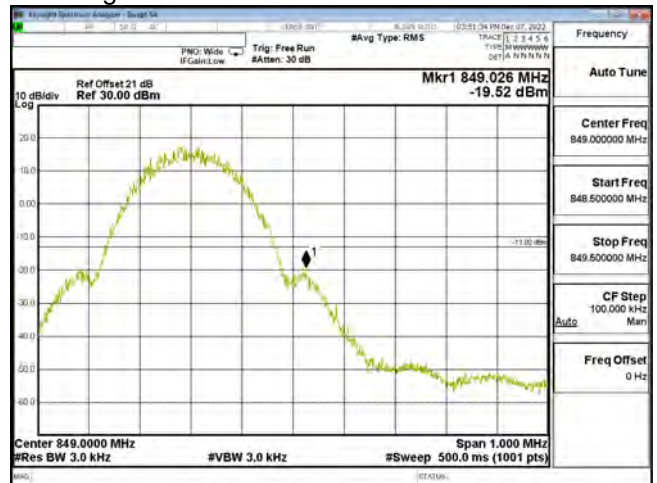

Bandedge 2G850 CH251 EGPRS

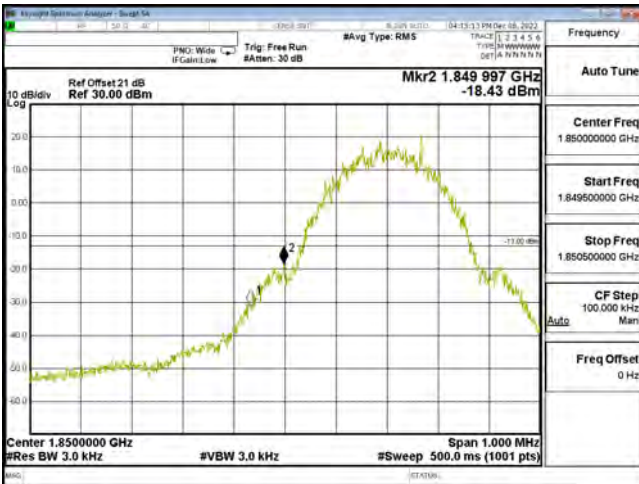

Bandedge 2G1900 CH512 VOICE

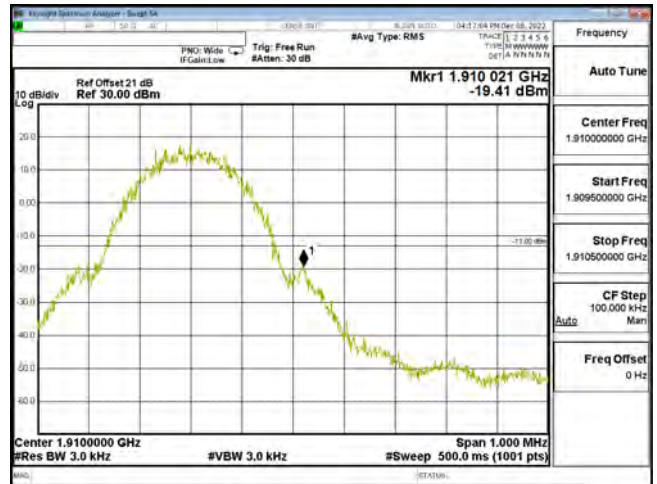

Bandedge 2G1900 CH810 VOICE

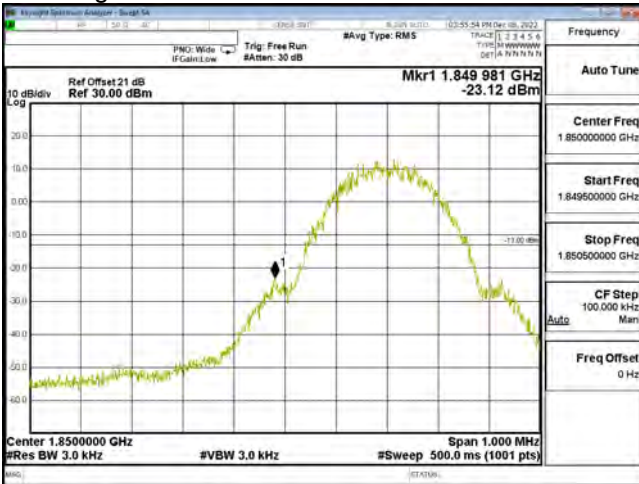

Bandedge 2G1900 CH512 EGPRS

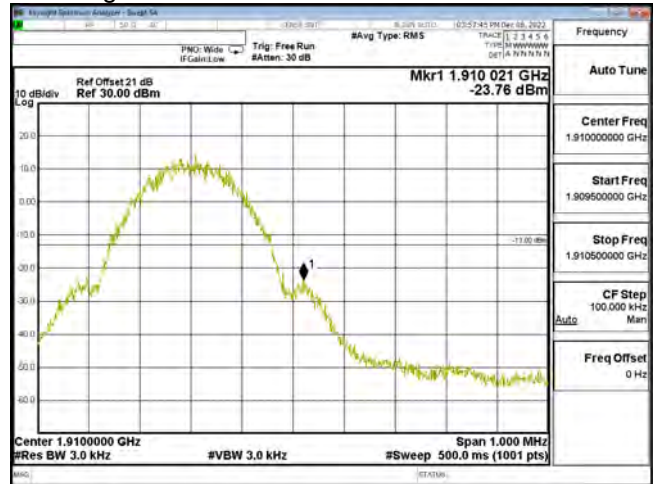

Bandedge 2G1900 CH810 EGPRS

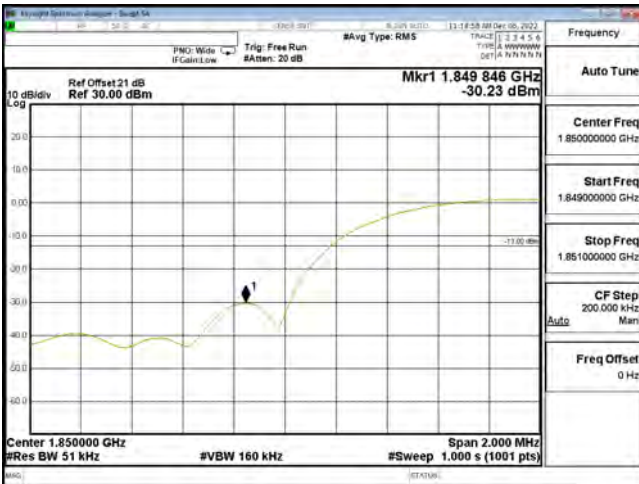

Bandedge B2 CH9262 RMC



Bandedge B2 CH9538 RMC



Bandedge B4 CH1312 RMC



Bandedge B4 CH1513 RMC

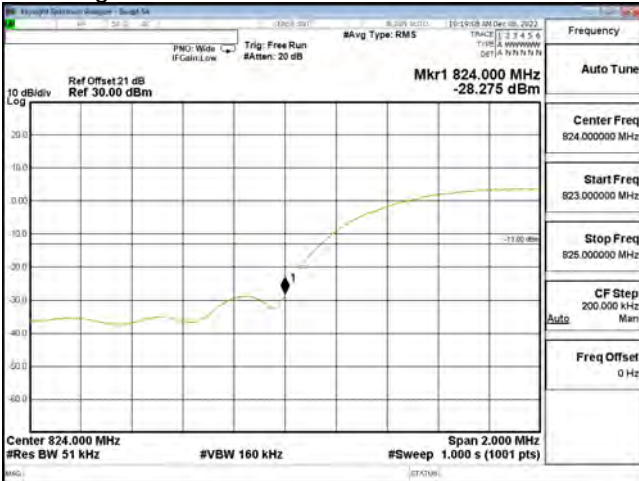

Bandedge B5 CH4132 RMC



Bandedge B5 CH4233 RMC

6. Spurious Emission

6.1. Test Specification

According to Part 2.1051, 2.1053, 22.917, 24.238, 27.53, RSS-GEN, RSS-132, RSS-133, RSS-139.

6.2. Test Setup

Spurious emissions at antenna terminals

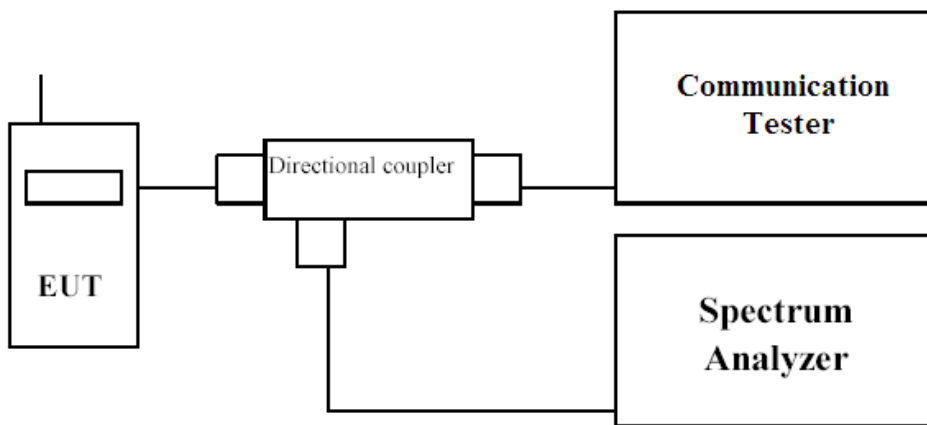

Field strength of spurious radiation

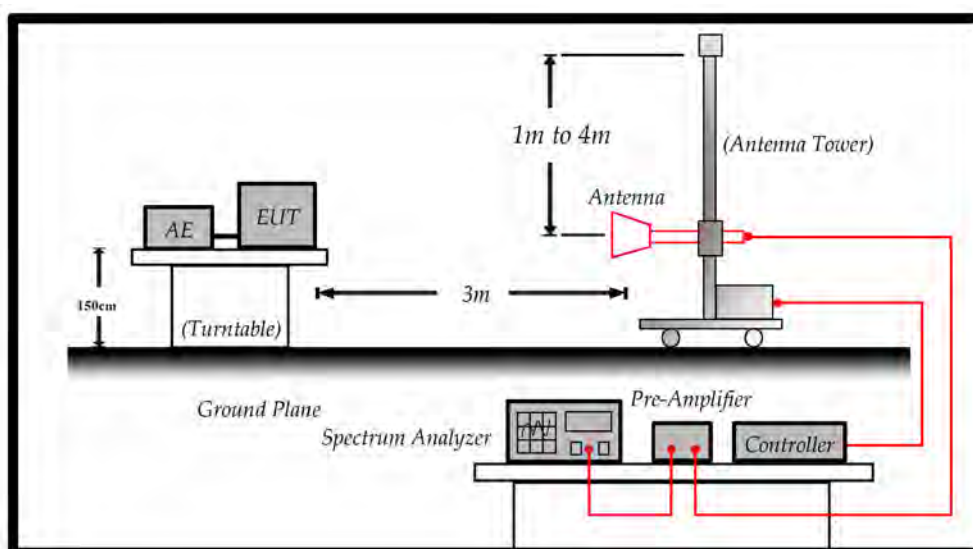

6.3. Limits

Limit	<-13dBm
--------------	-------------------

$43 + 10\text{Log}(P)$ down on the carrier where P is the power in Watts.

6.4. Test Procedure

In accordance with Part 2.1051/2.1053, the spurious emissions from the EUT were measured. The transmitter output power was attenuated using a combination of filters and attenuators and the frequency spectrum investigated from 30MHz to 20GHz. The EUT was set to transmit on full power. The resolution and video bandwidth was set to 1MHz and 3 x RBW. In accordance with Part 22.917 & 24.238, 27.53. The spectrum analyzer detector was set to Max Hold. In addition, measurements were made up to the 10th harmonic of the fundamental. The device was then replaced with a substitution antenna, which input signal was adjusted until the received level matched that of the previously detected emission.

The EUT is placed on a turn table which is 1.5 meter above ground. The turn table can rotate 360 degrees to determine the position of the maximum emission level. The EUT was positioned such that the distance from antenna to the EUT was 3 meters.

The antenna can move up and down between 1 meter and 4 meters to find out the maximum emission level.

Both horizontal and vertical polarization of the antenna are set on measurement. In order to find the maximum emission, all of the interface cables must be manipulated according to TIA/EIA 603-E on radiated measurement.

6.5. Test Result of Spurious Emission

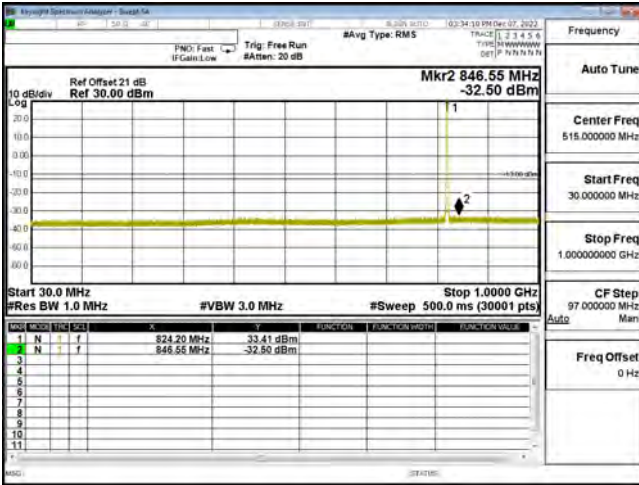

CSE 2G850 CH128 VOICE 30M-1G

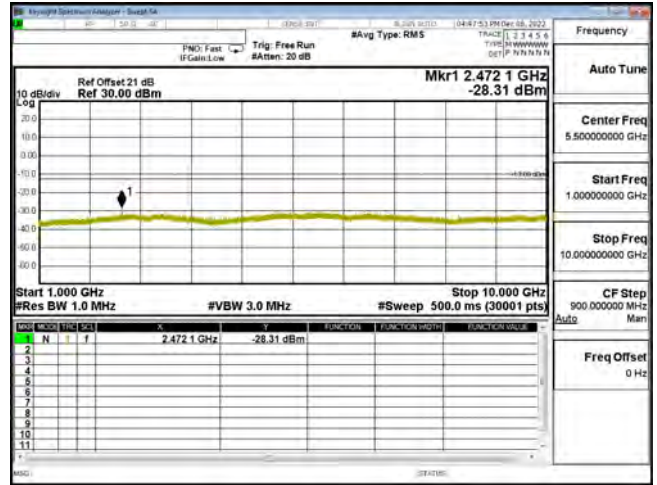

CSE 2G850 CH128 VOICE 1G-10G



CSE 2G850 CH128 EGPRS 30M-1G

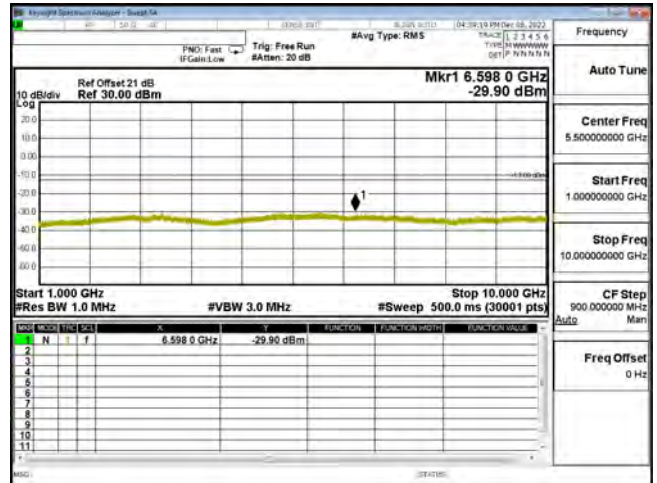

CSE 2G850 CH128 EGPRS 1G-10G



CSE 2G850 CH189 VOICE 30M-1G



CSE 2G850 CH189 VOICE 1G-10G

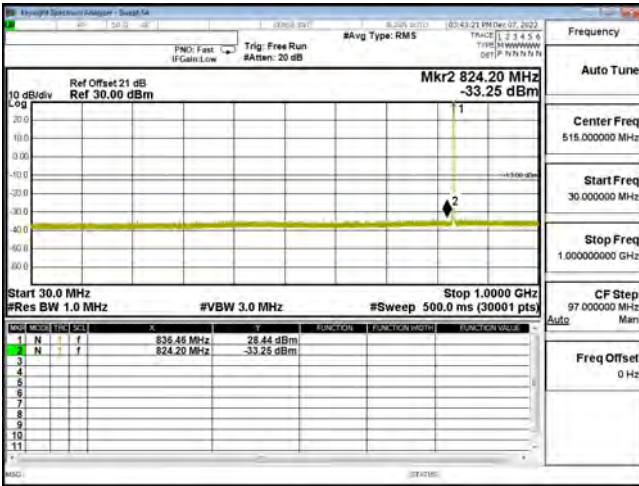

CSE 2G850 CH189 EGPRS 30M-1G

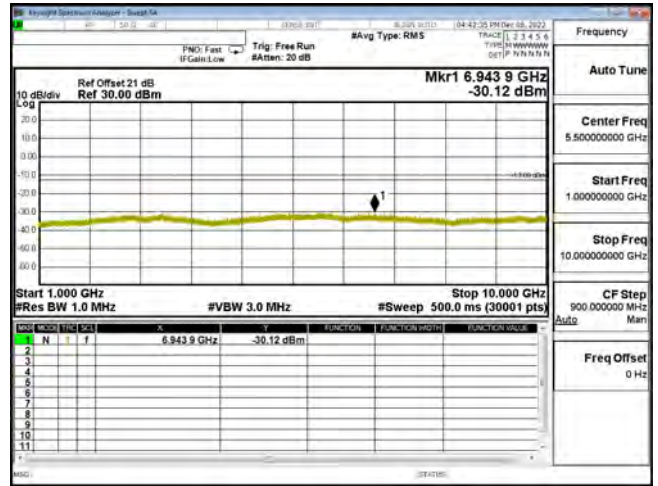

CSE 2G850 CH189 EGPRS 1G-10G

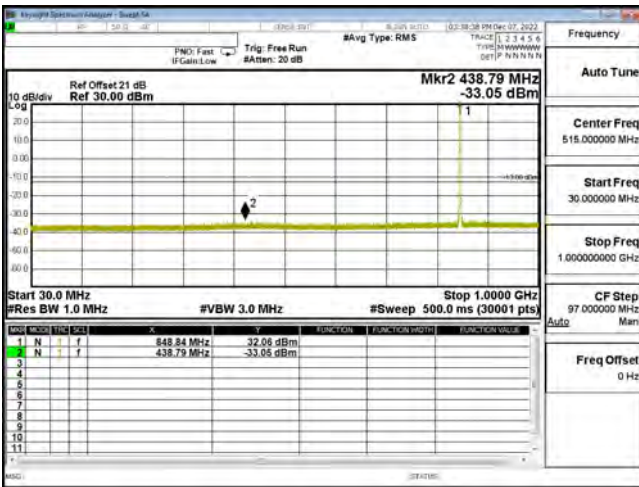

CSE 2G850 CH251 VOICE 30M-1G

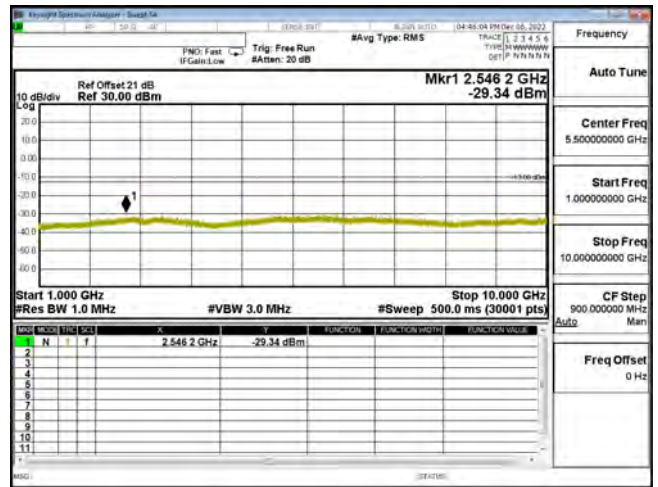

CSE 2G850 CH251 VOICE 1G-10G



CSE 2G850 CH251 EGPRS 30M-1G

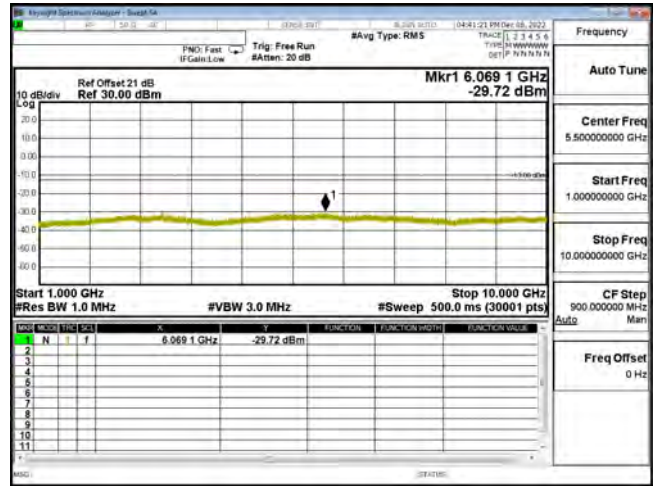

CSE 2G850 CH251 EGPRS 1G-10G

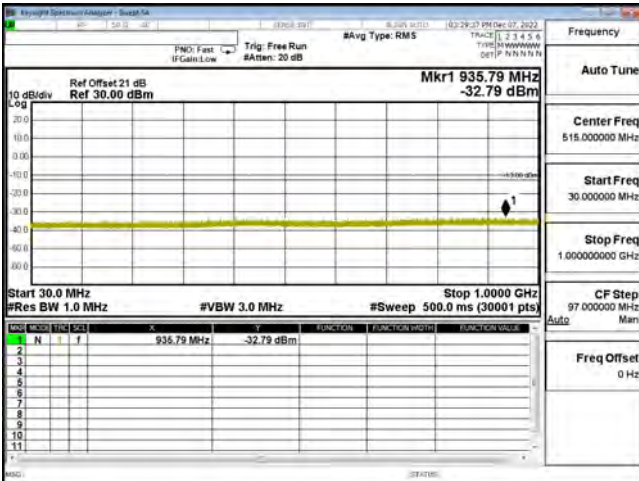

CSE 2G1900 CH512 VOICE 30M-1G



CSE 2G1900 CH512 VOICE 1G-20G

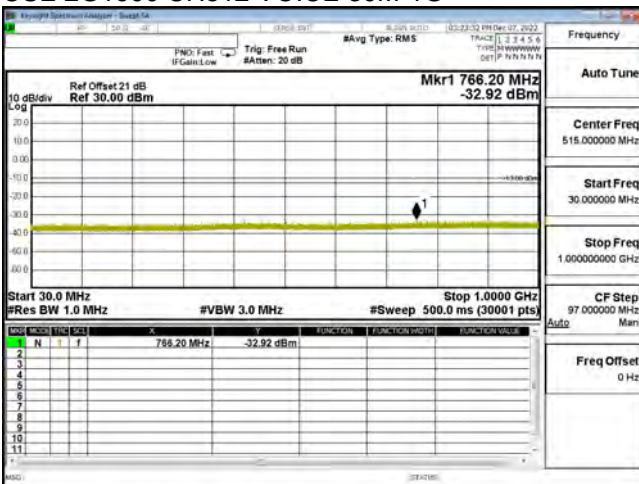

CSE 2G1900 CH512 EGPRS 30M-1G

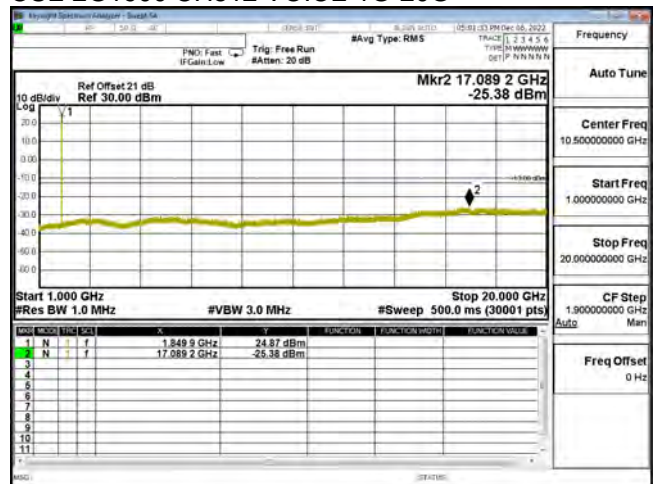

CSE 2G1900 CH512 EGPRS 1G-20G



CSE 2G1900 CH661 VOICE 30M-1G

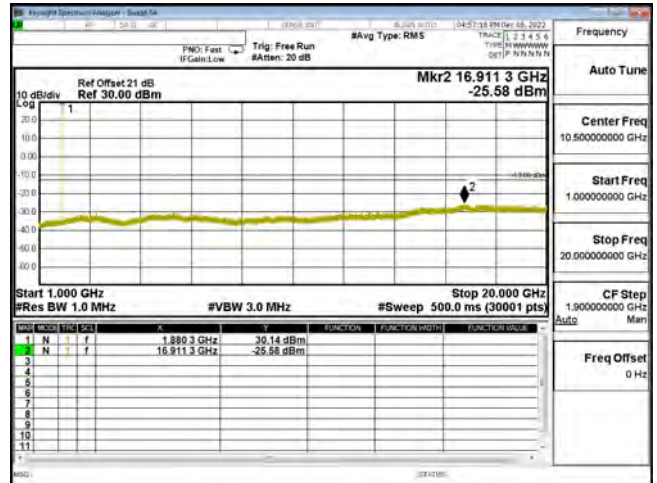

CSE 2G1900 CH661 VOICE 1G-20G

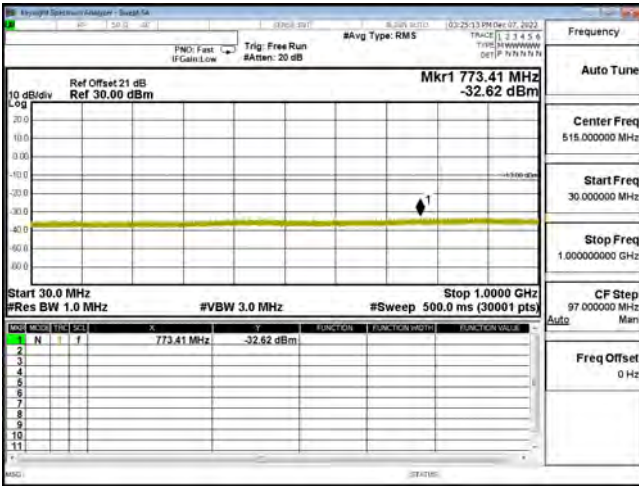

CSE 2G1900 CH661 EGPRS 30M-1G

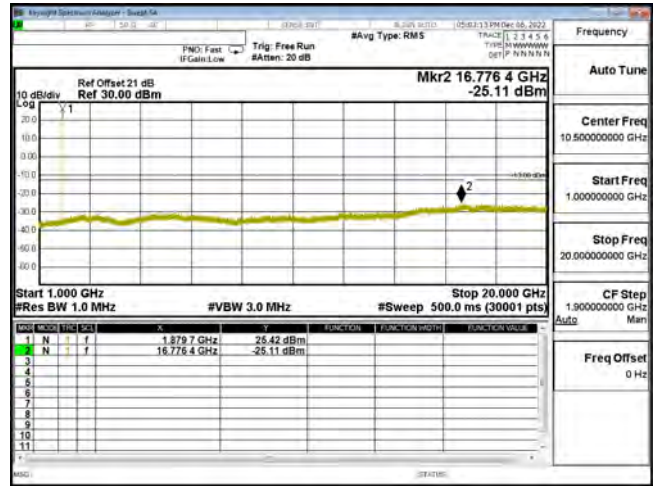

CSE 2G1900 CH661 EGPRS 1G-20G

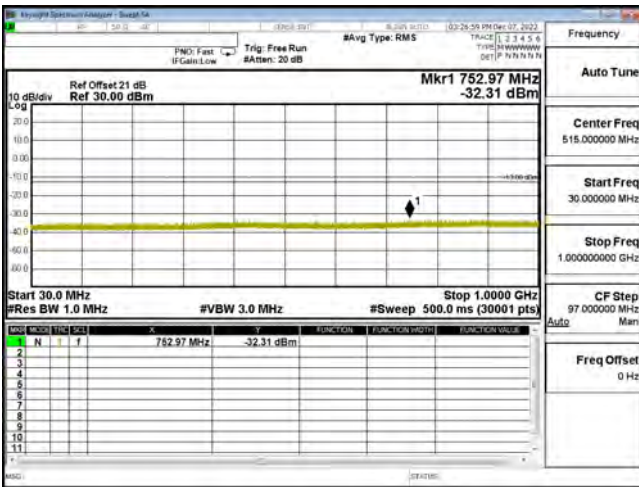

CSE 2G1900 CH810 VOICE 30M-1G



CSE 2G1900 CH810 VOICE 1G-20G

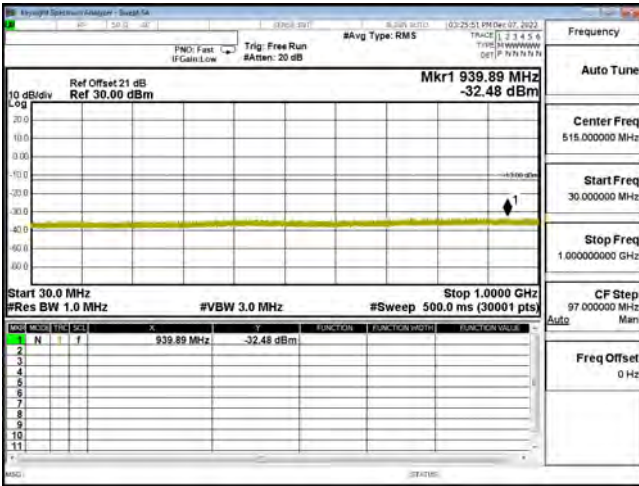

CSE 2G1900 CH810 EGPRS 30M-1G

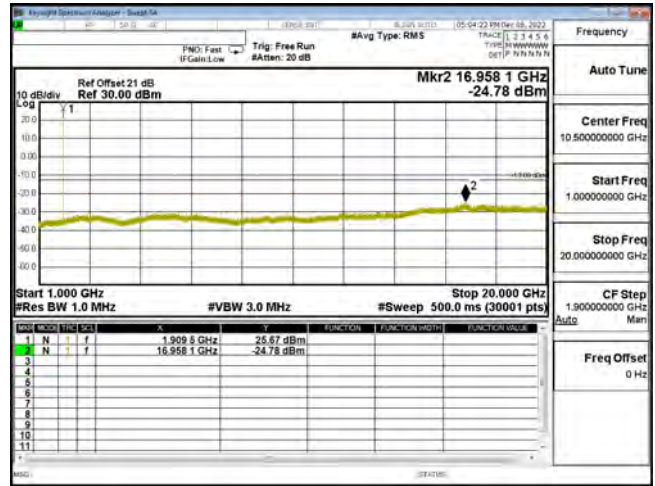

CSE 2G1900 CH810 EGPRS 1G-20G



CSE B2 CH9262 RMC 30M-1G

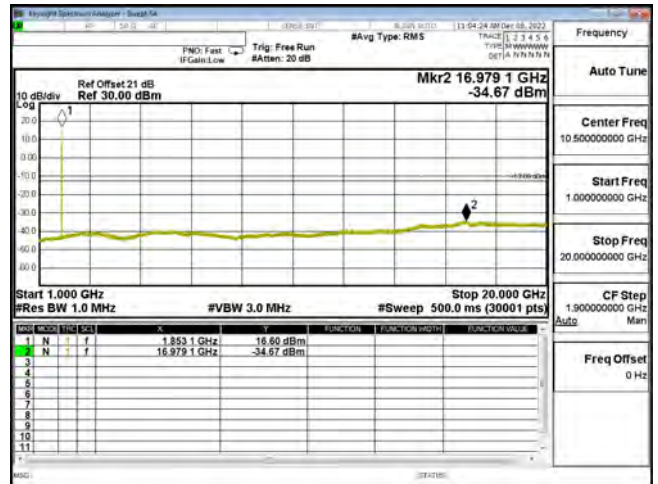

CSE B2 CH9262 RMC 1G-20G

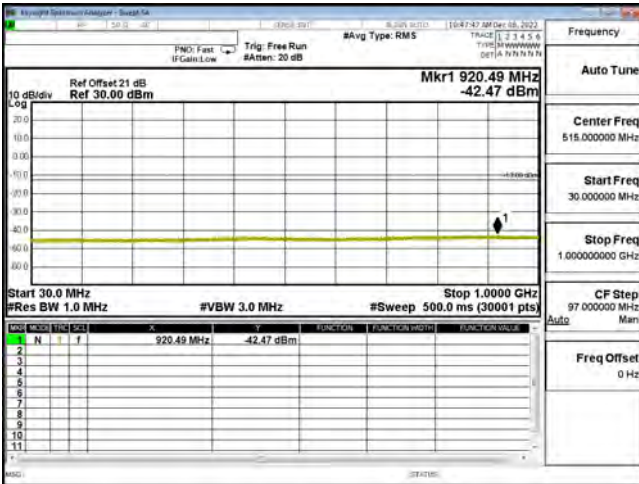

CSE B2 CH9400 RMC 30M-1G

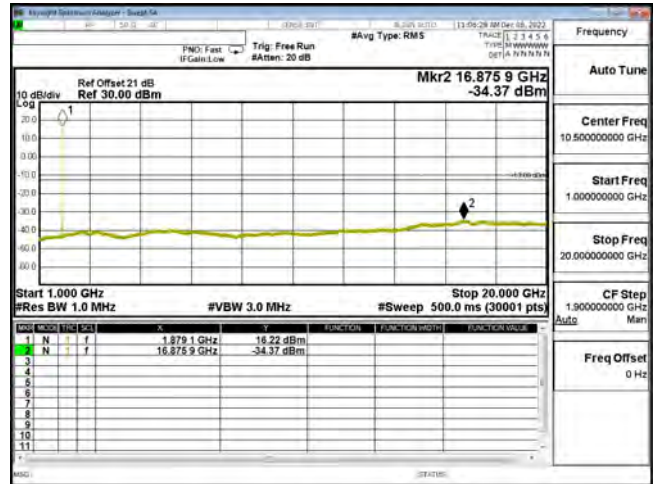

CSE B2 CH9400 RMC 1G-20G

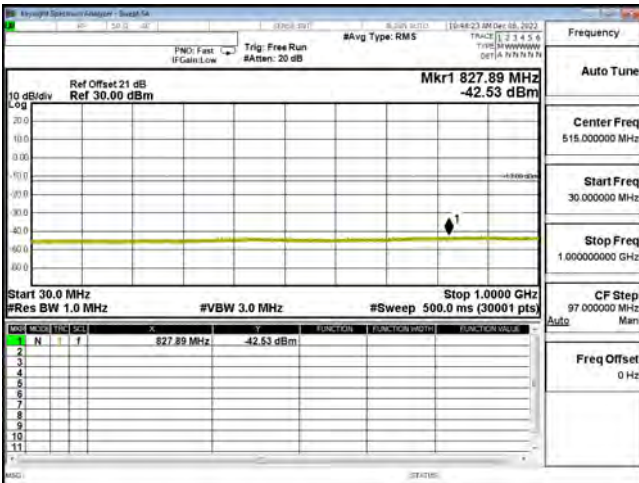

CSE B2 CH9538 RMC 30M-1G

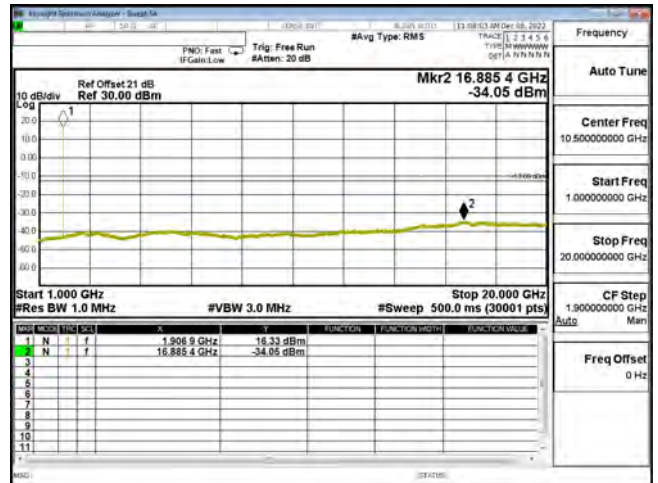

CSE B2 CH9538 RMC 1G-20G

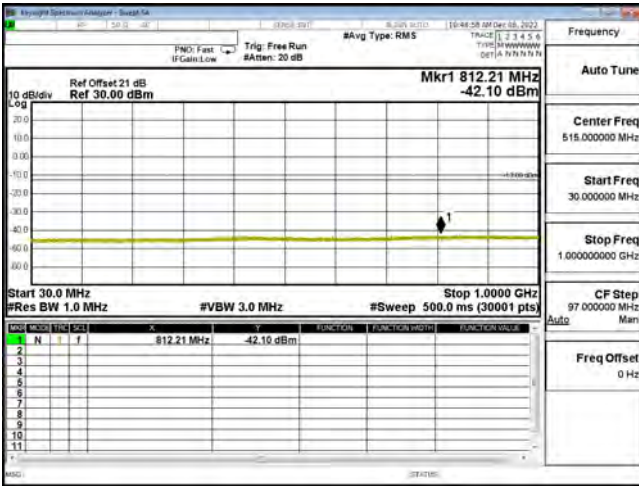

CSE B4 CH1312 RMC 30M-1G

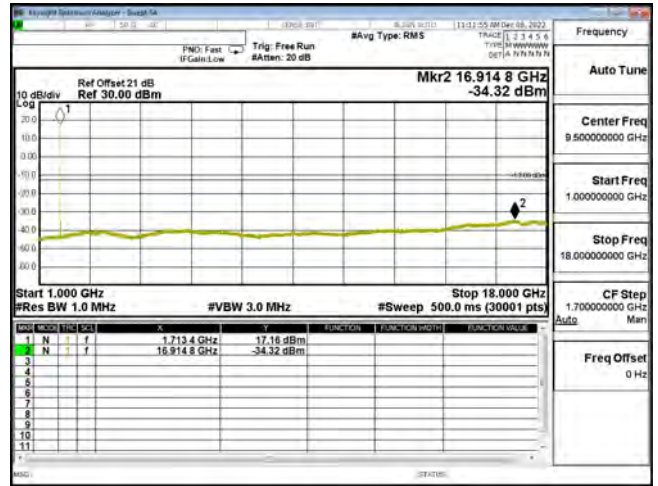

CSE B4 CH1312 RMC 1G-18G

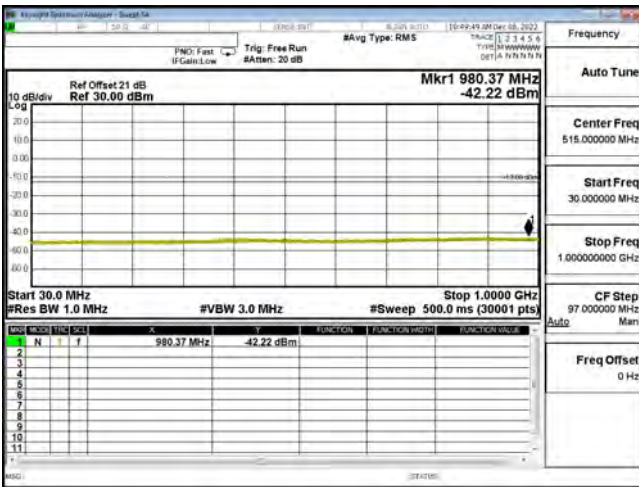

CSE B4 CH1413 RMC 30M-1G

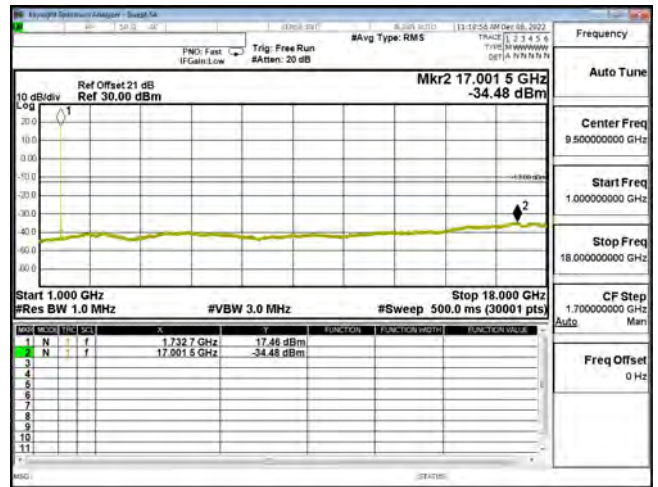

CSE B4 CH1413 RMC 1G-18G

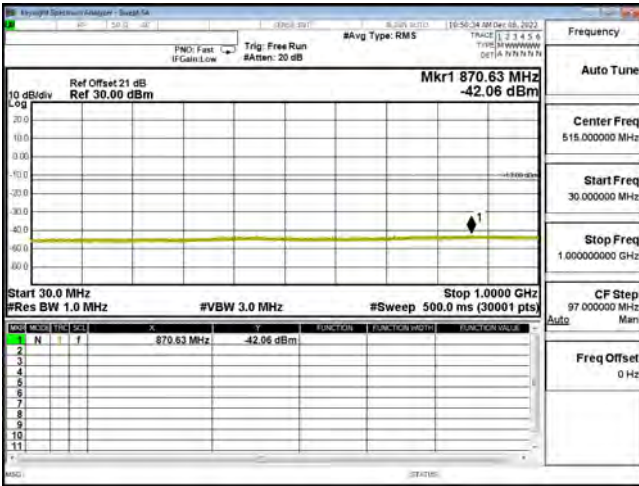

CSE B4 CH1513 RMC 30M-1G

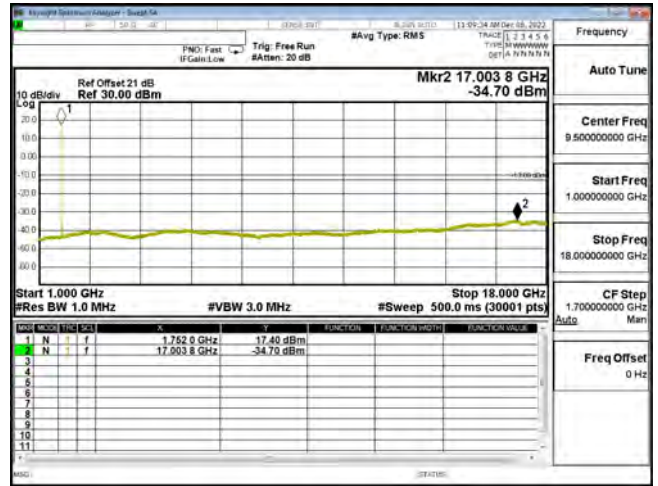

CSE B4 CH1513 RMC 1G-18G

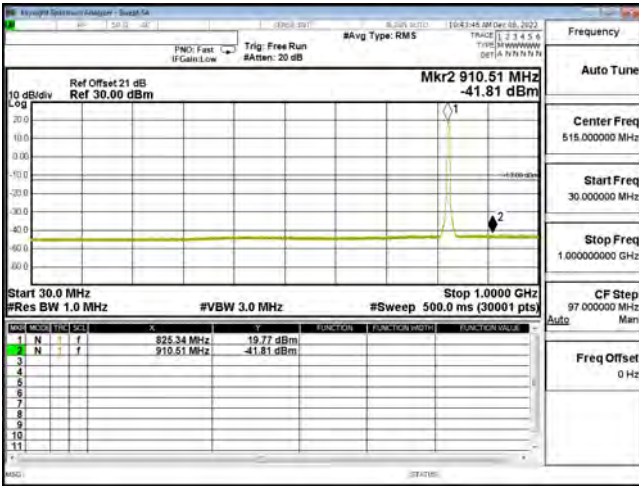

CSE B5 CH4132 RMC 30M-1G



CSE B5 CH4132 RMC 1G-10G



CSE B5 CH4183 RMC 30M-1G

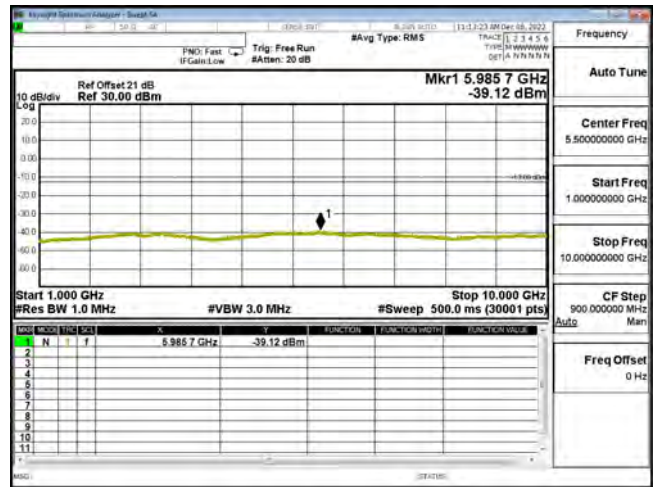

CSE B5 CH4183 RMC 1G-10G

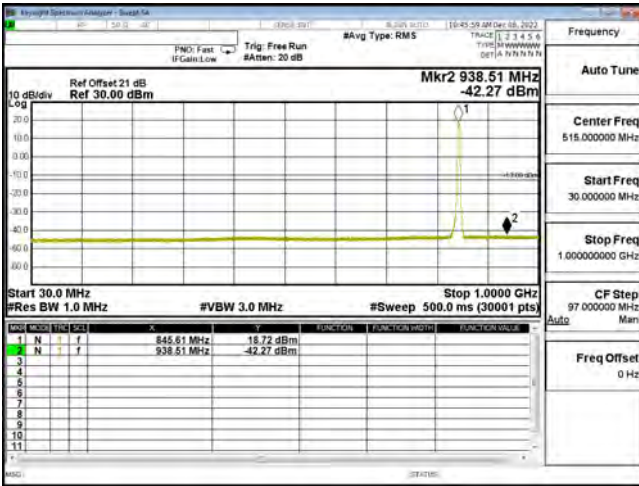

CSE B5 CH4233 RMC 30M-1G

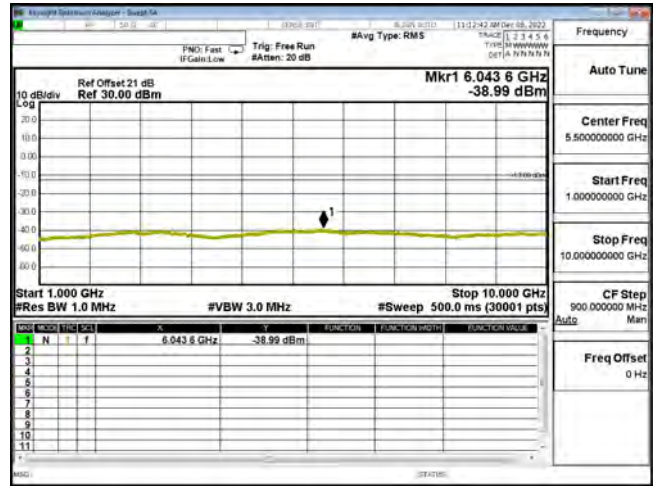

CSE B5 CH4233 RMC 1G-10G

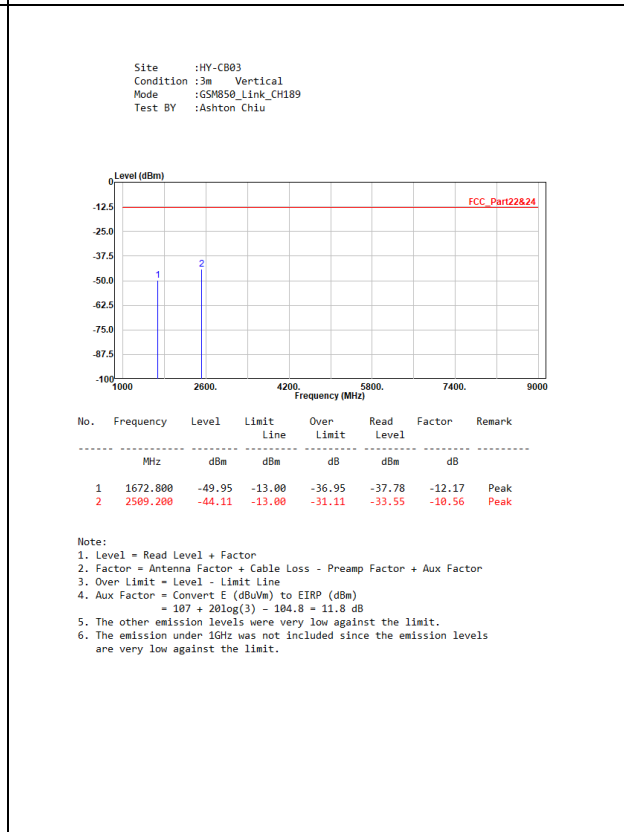
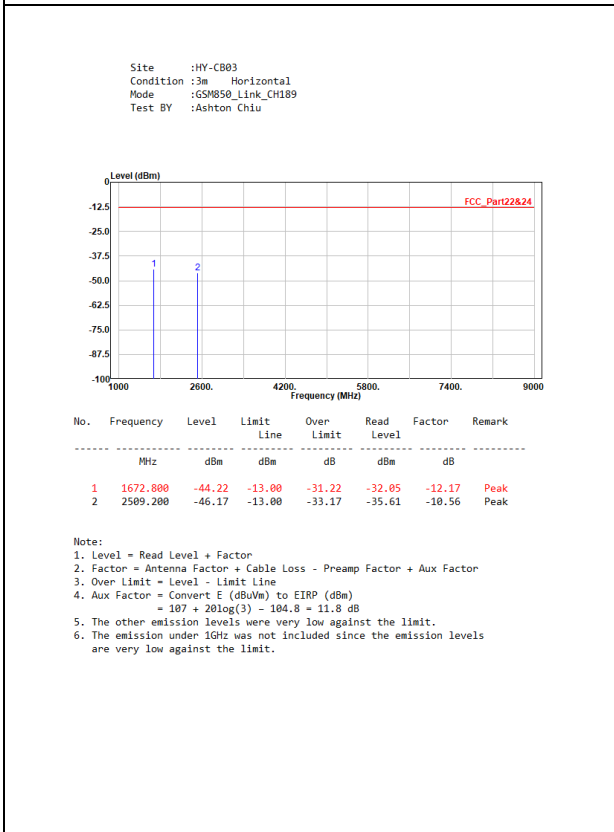
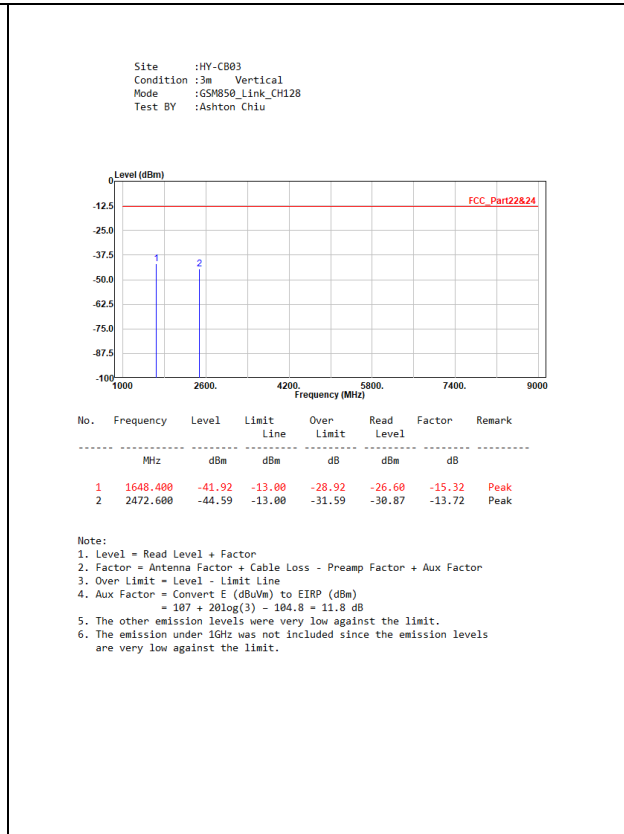
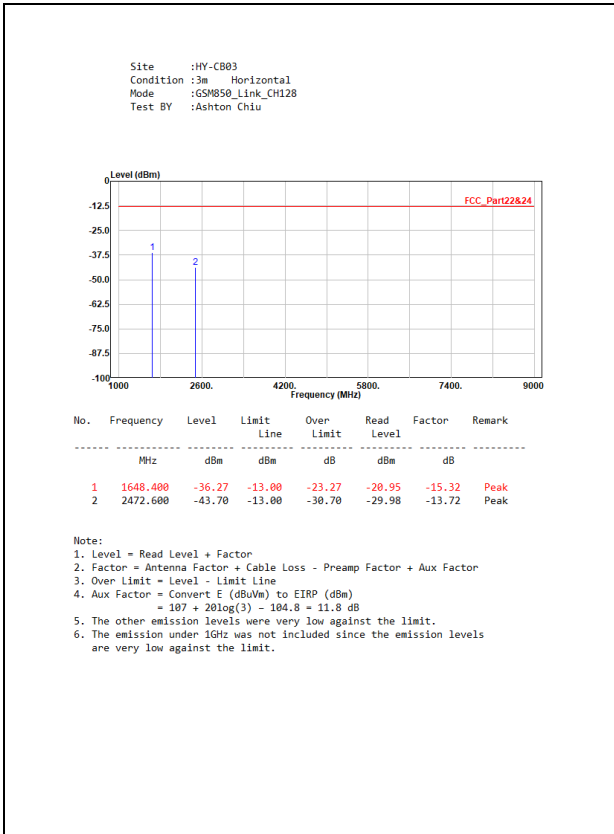

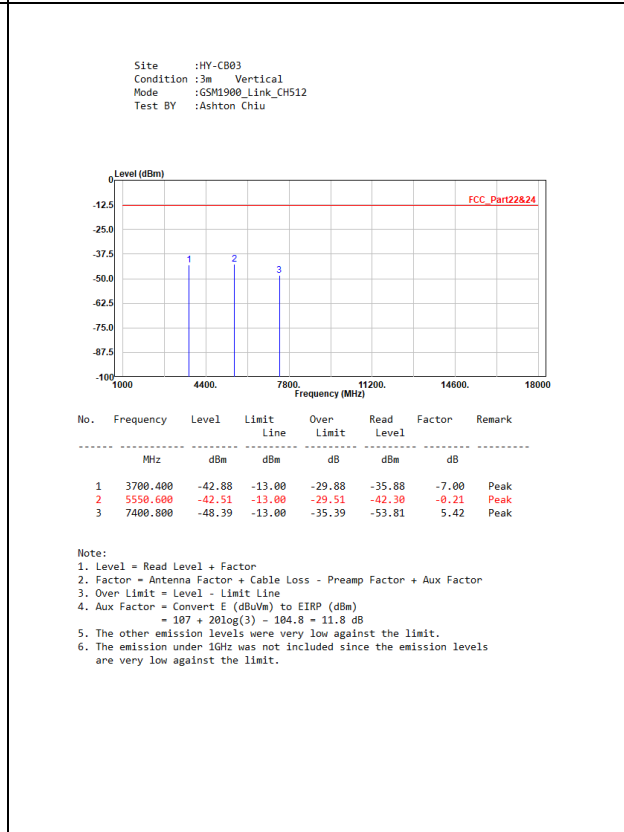
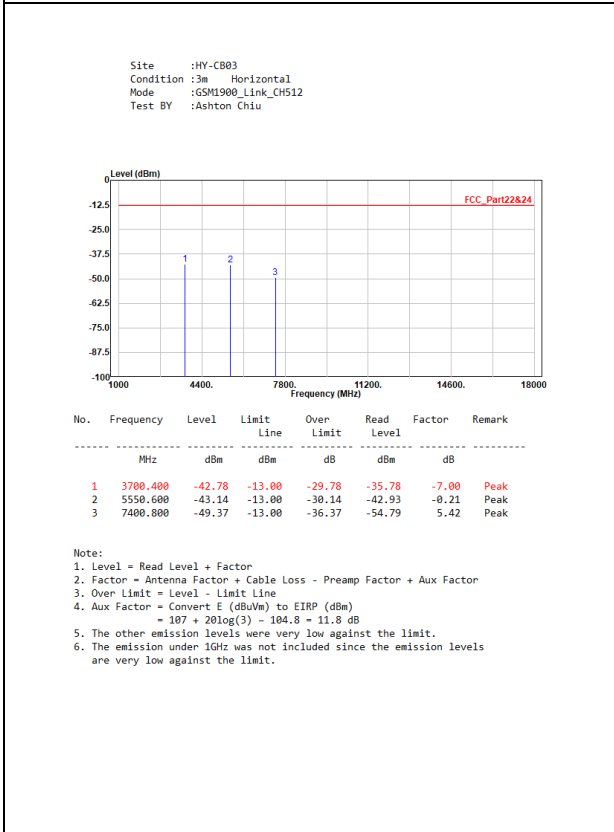
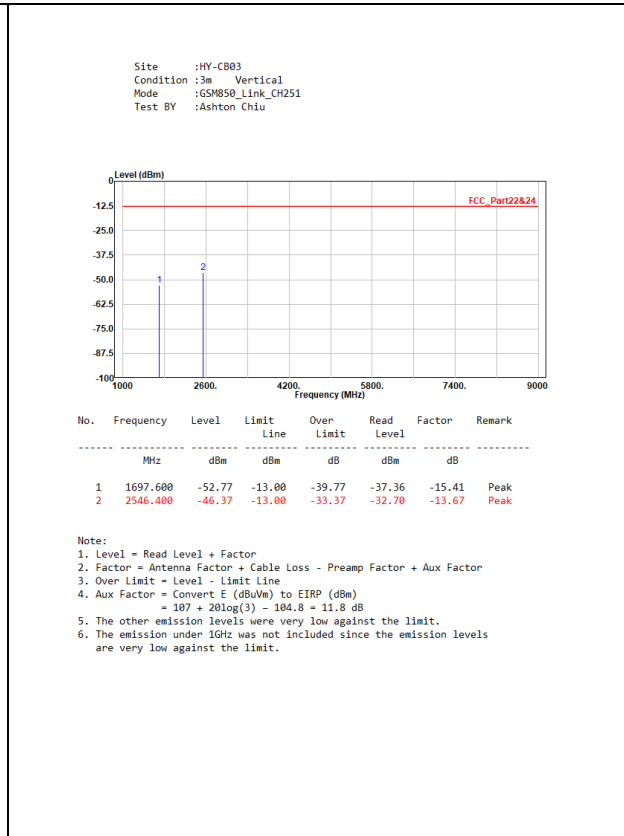
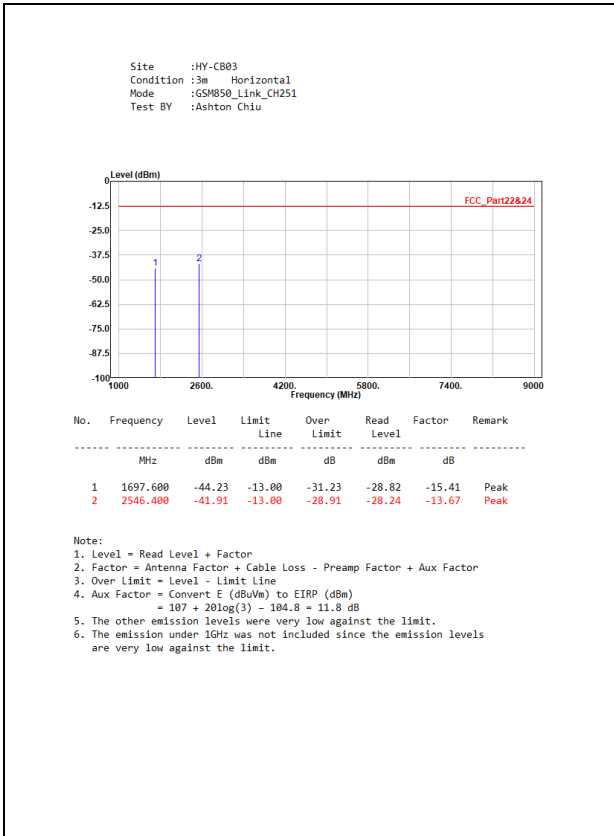

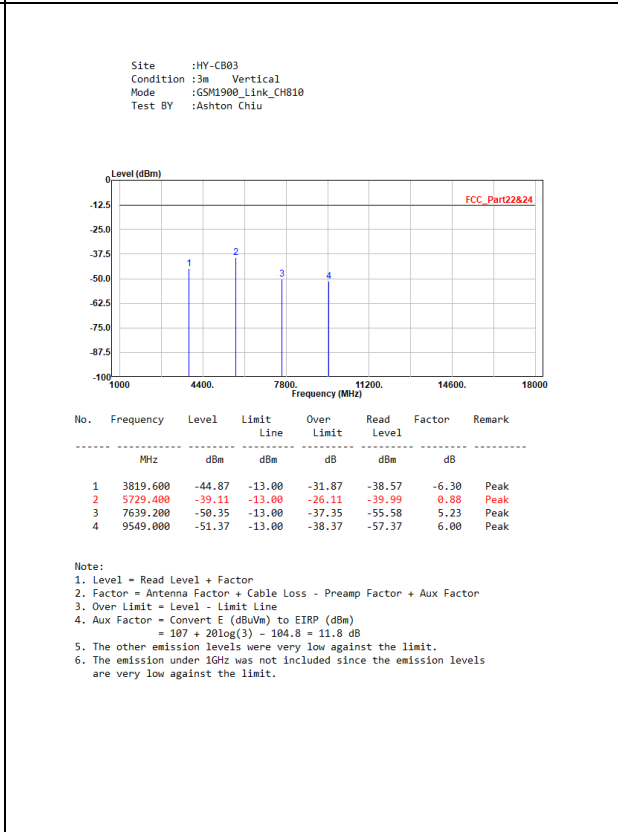
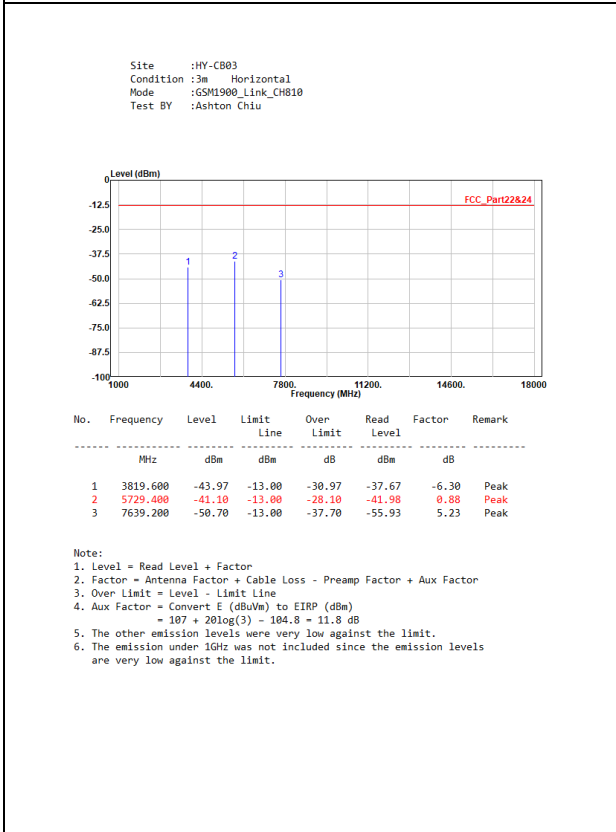
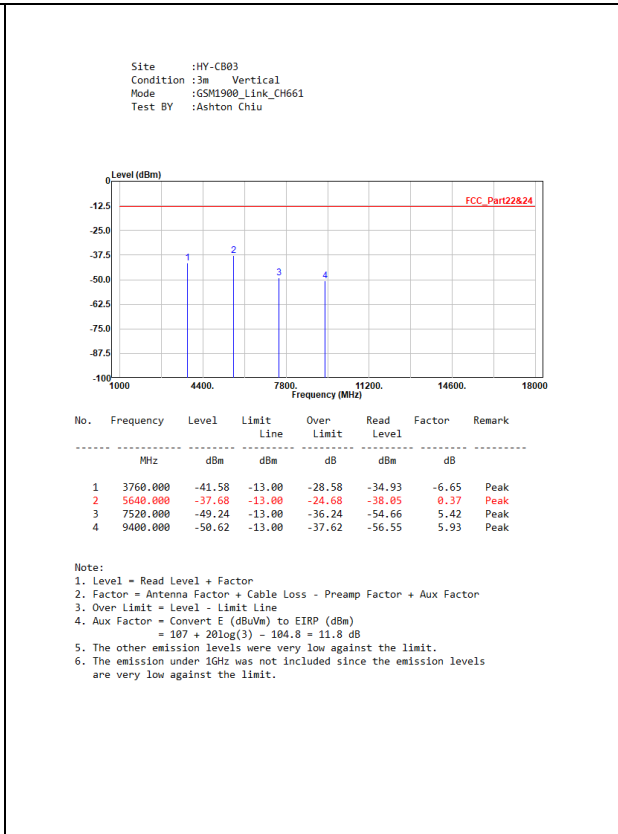
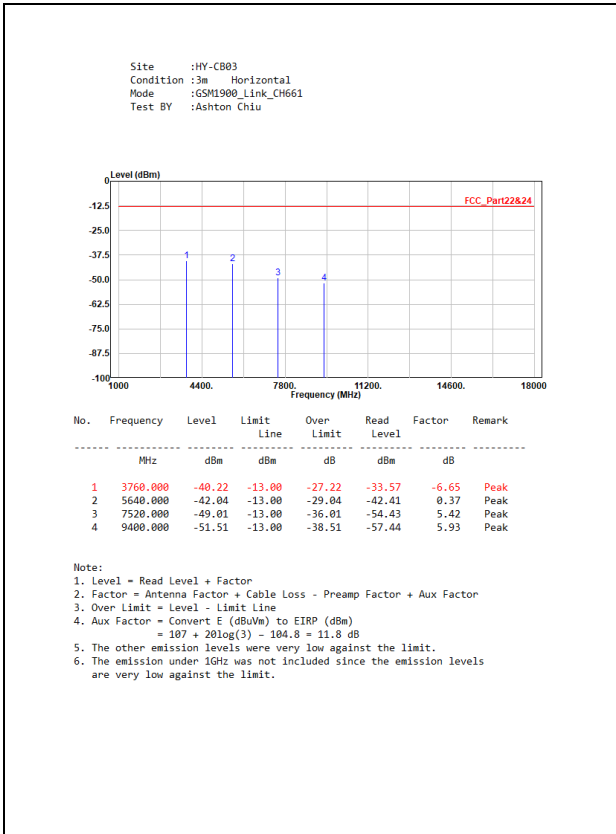

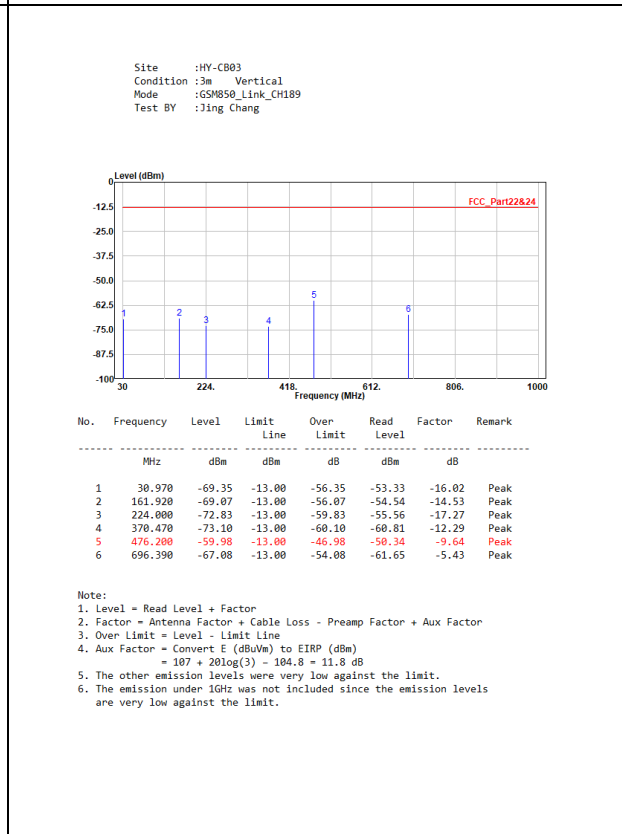
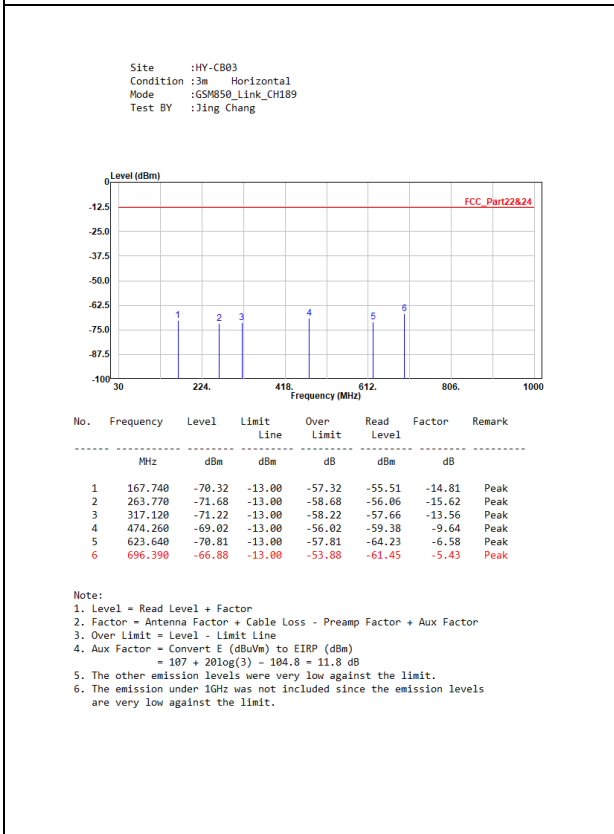
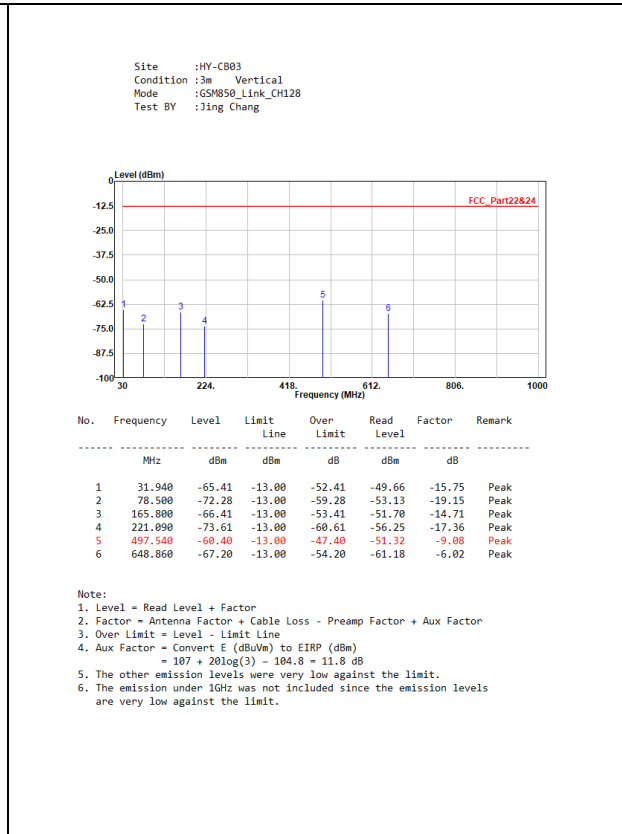
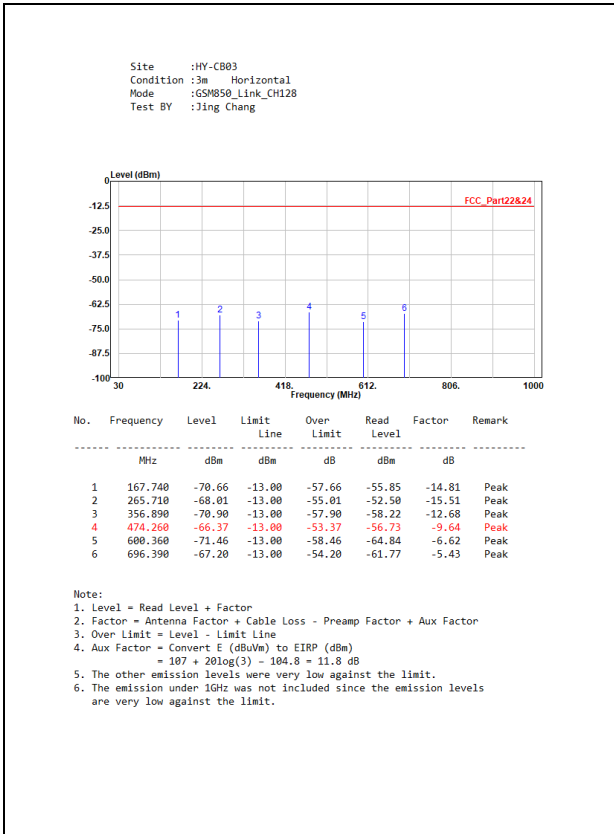

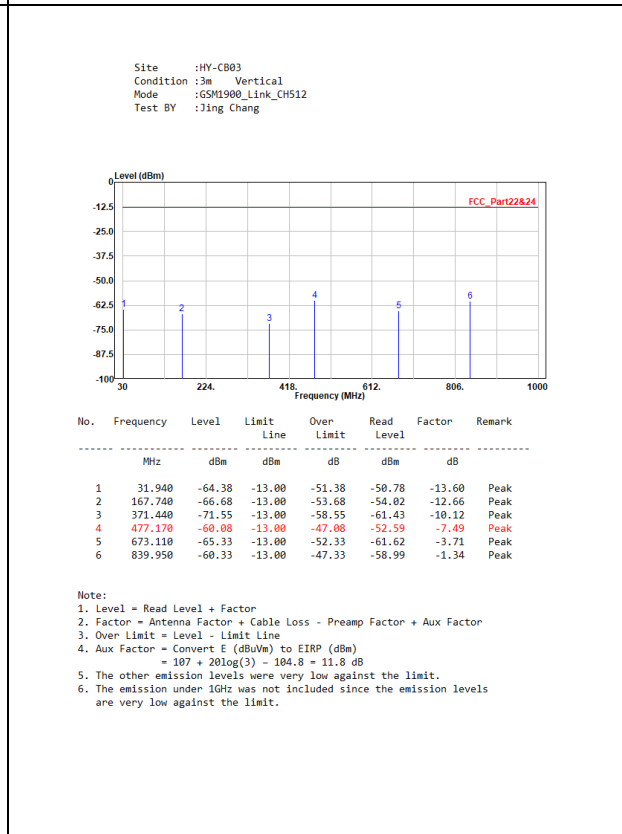
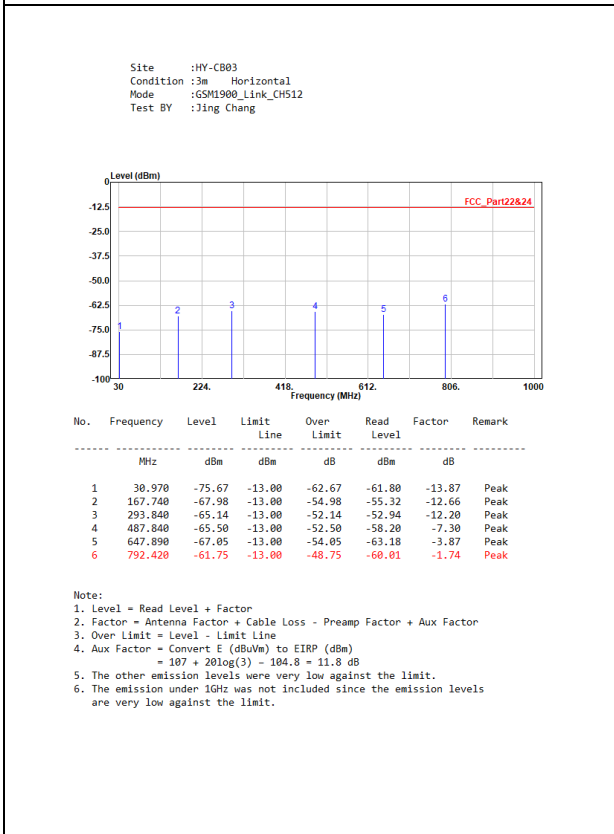
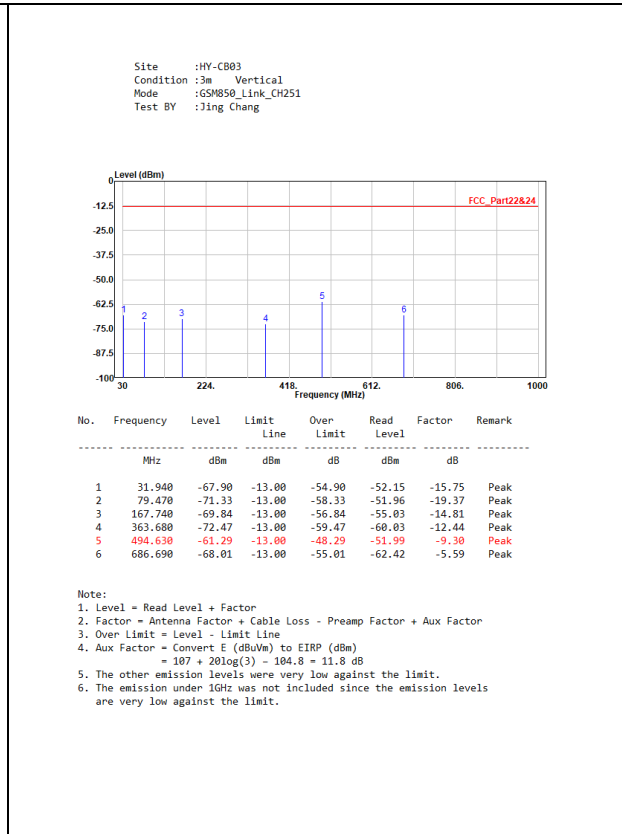
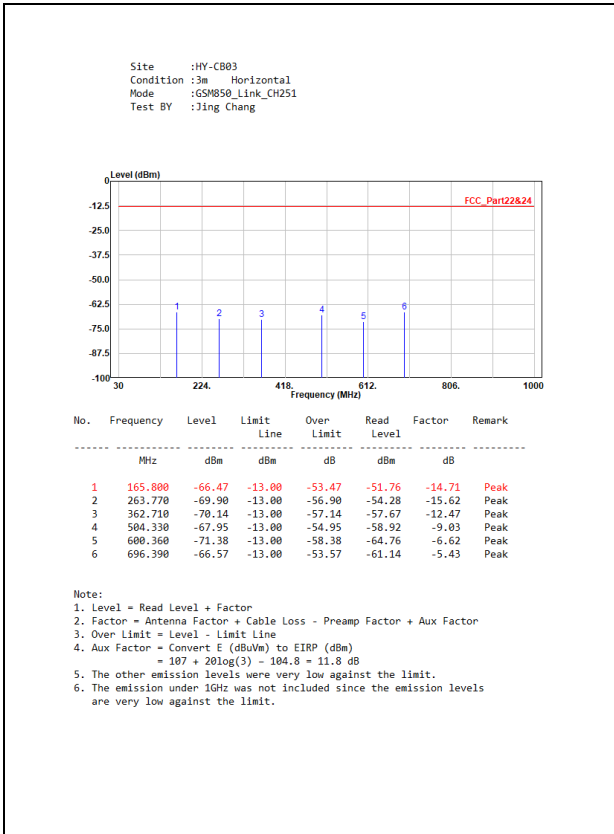

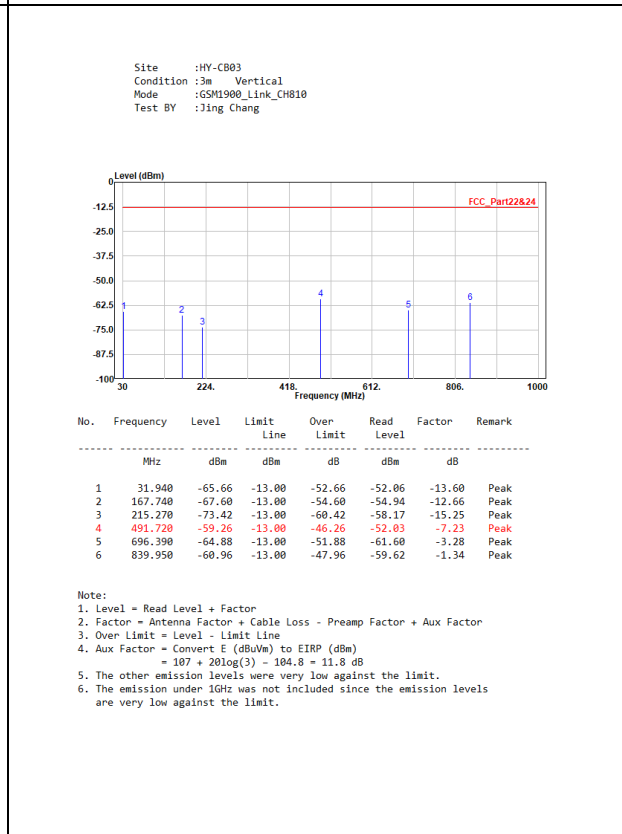
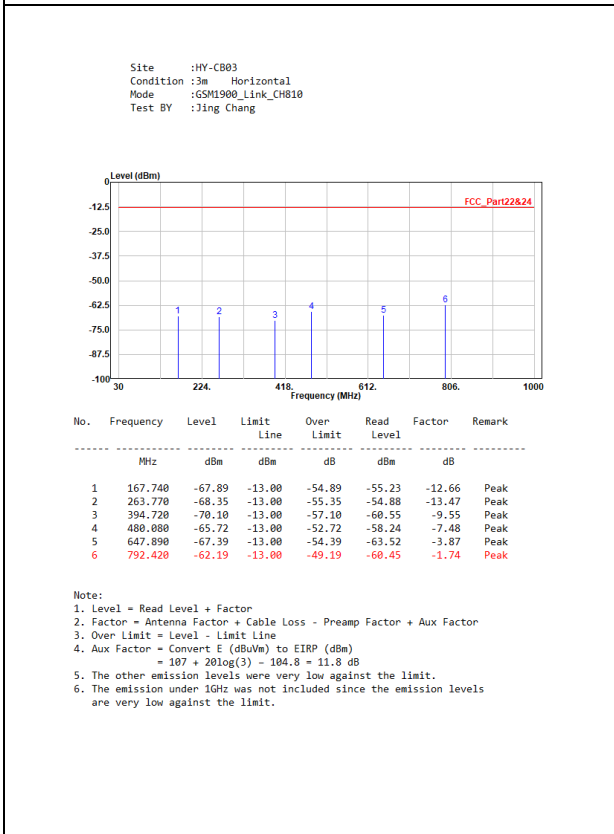
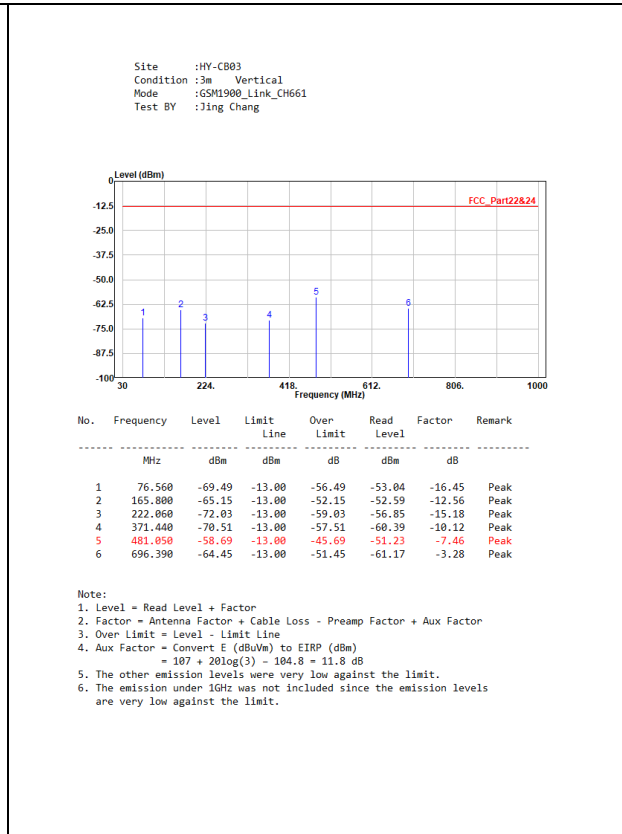
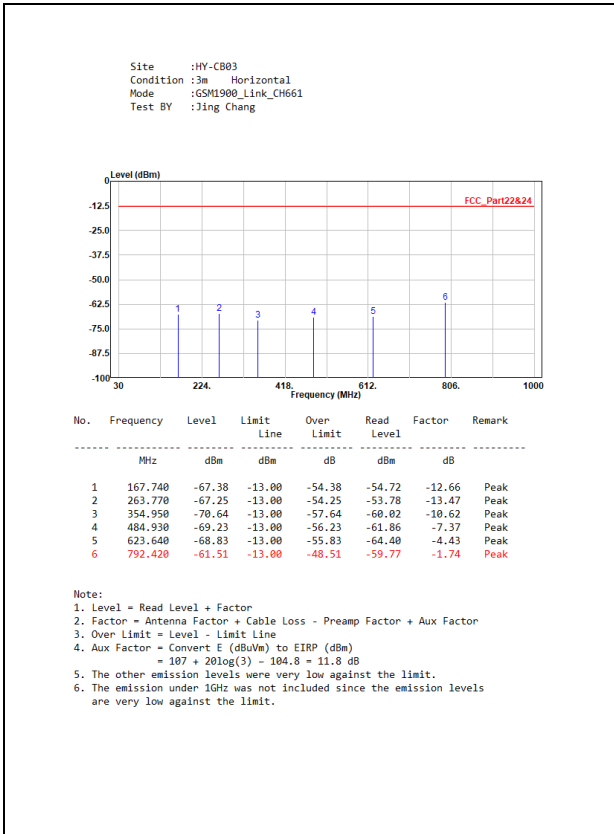

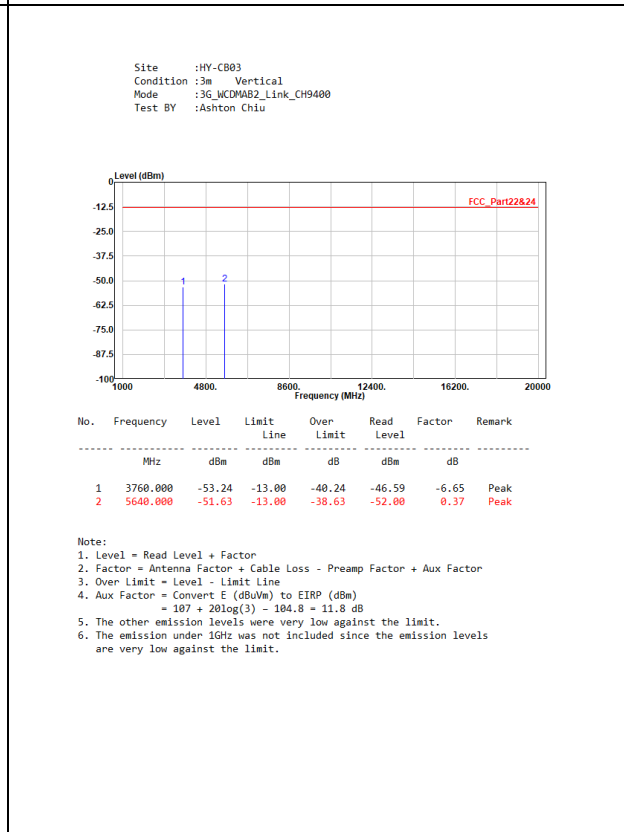
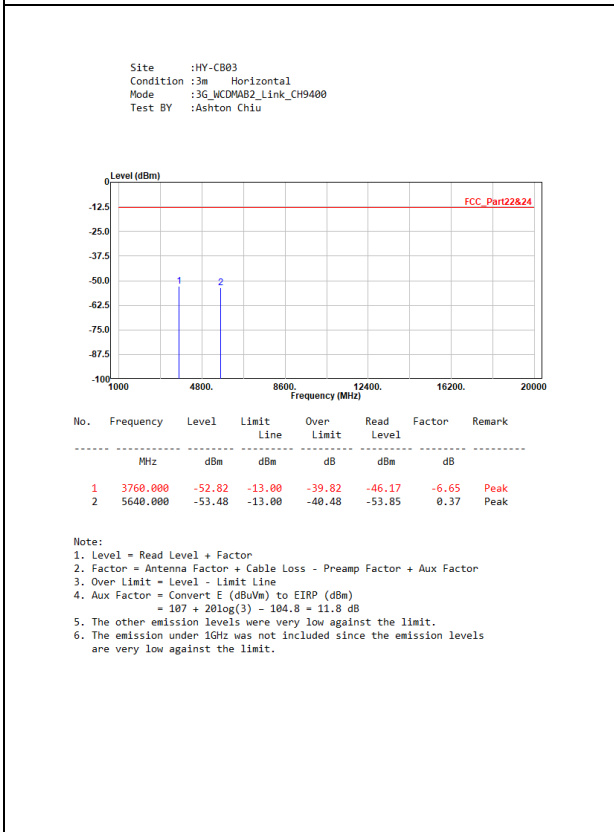
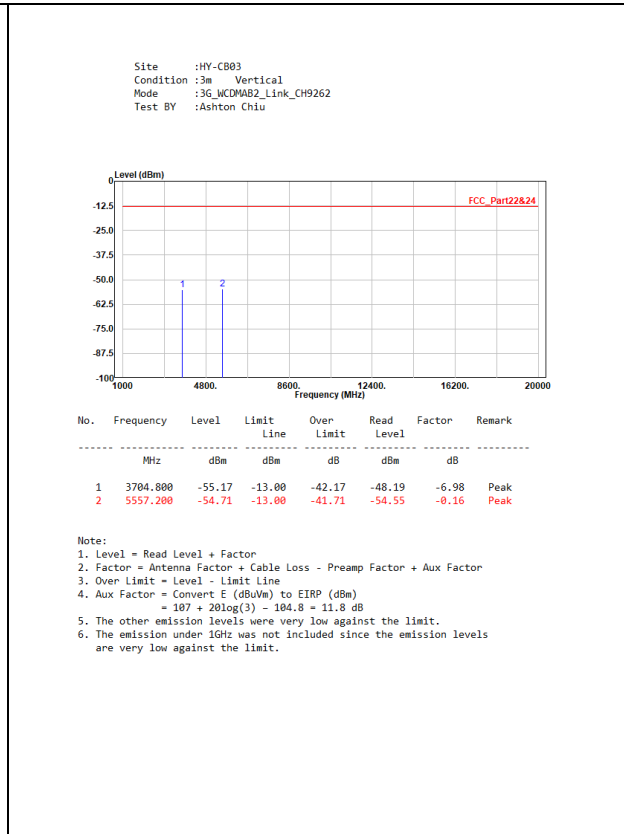
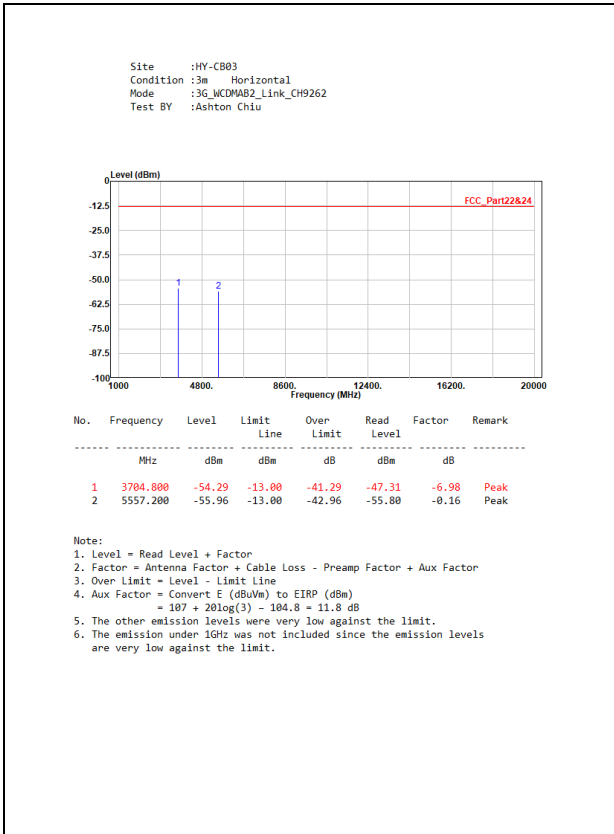

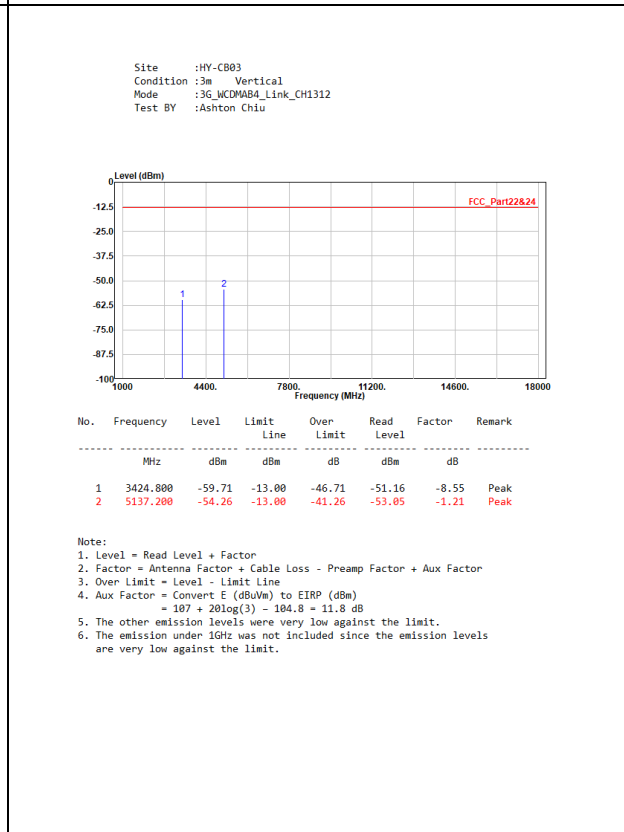
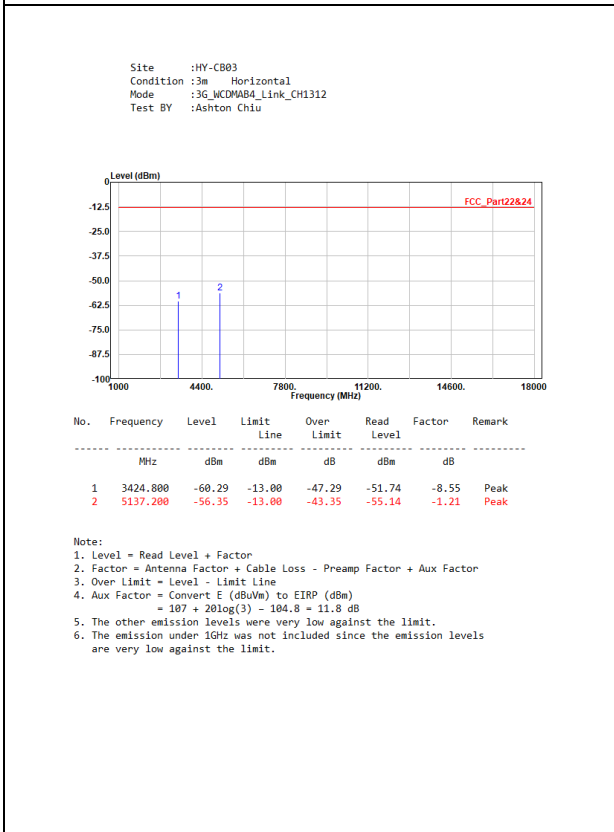
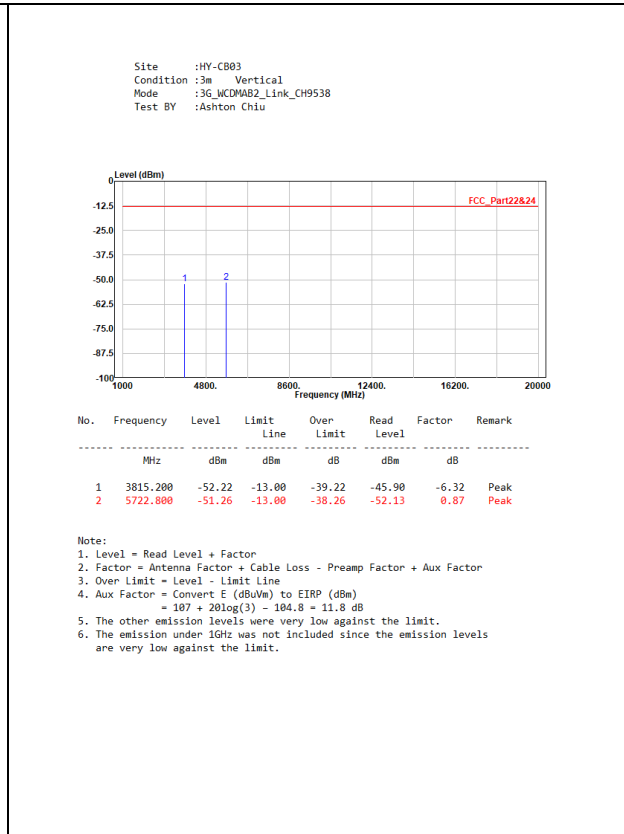
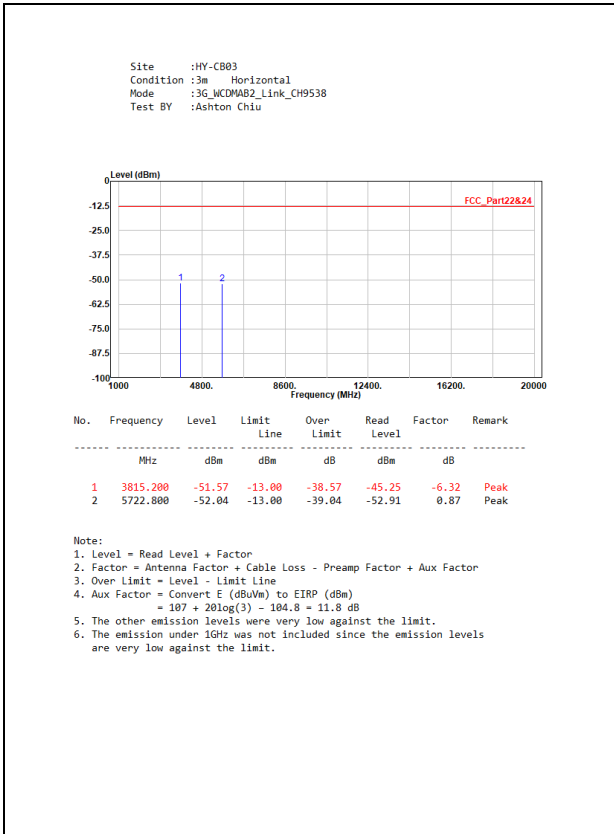

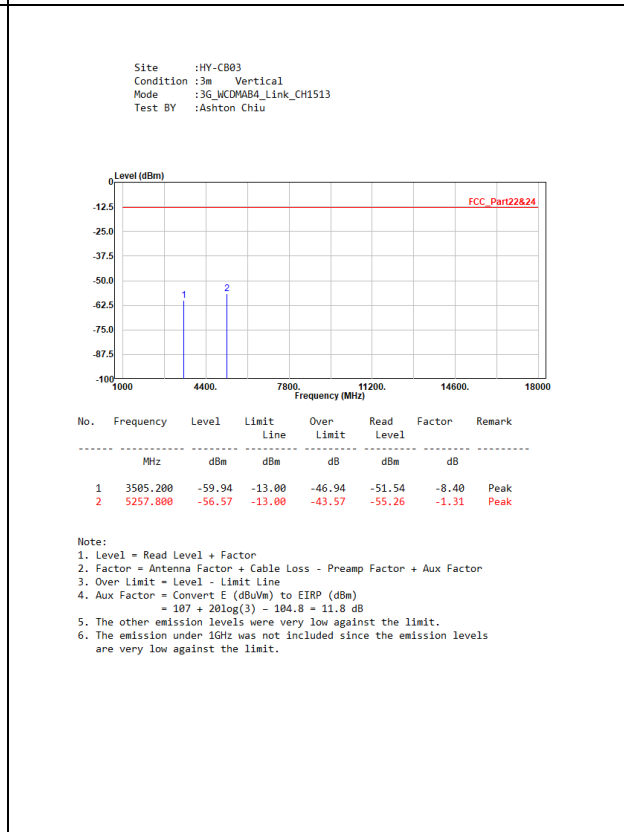
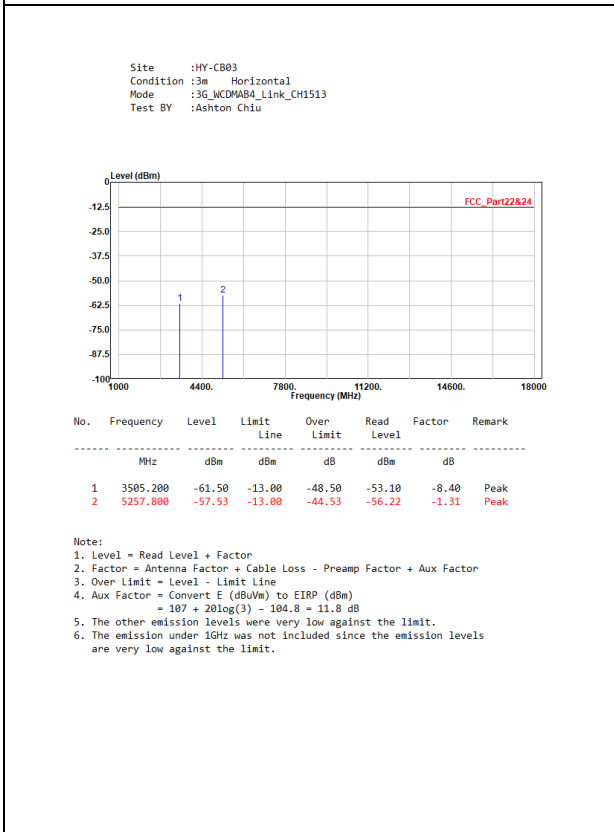
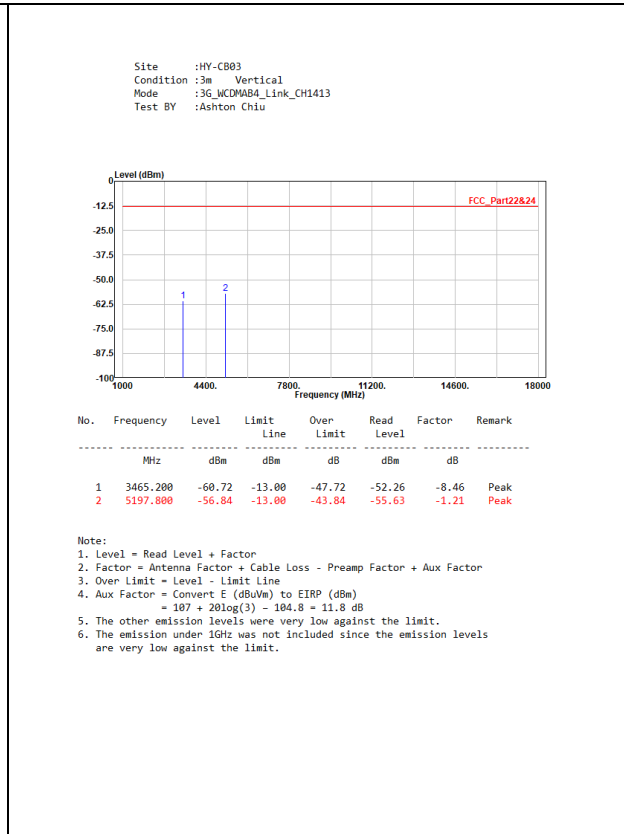
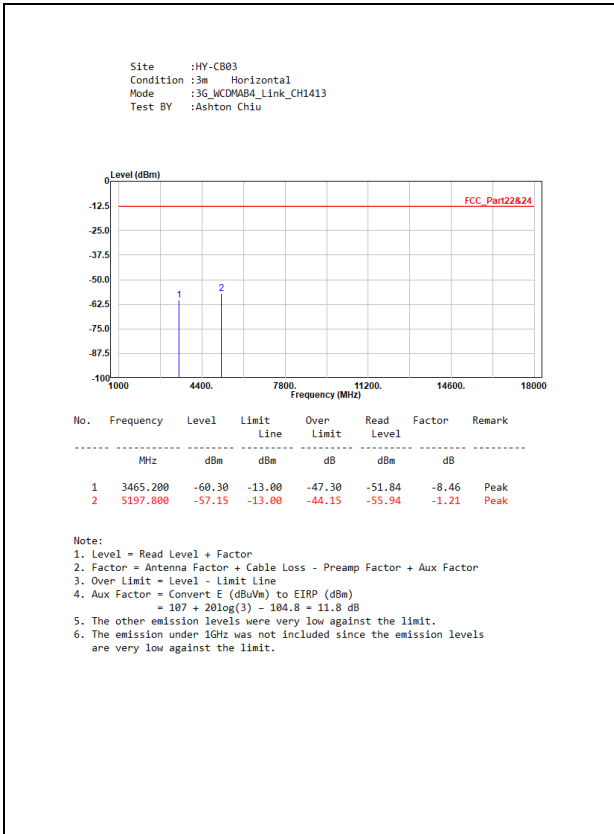

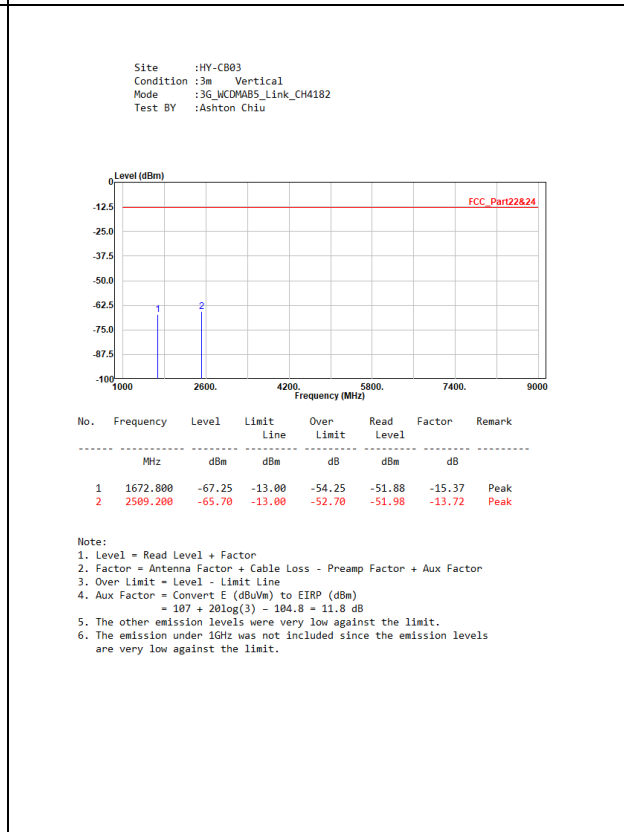
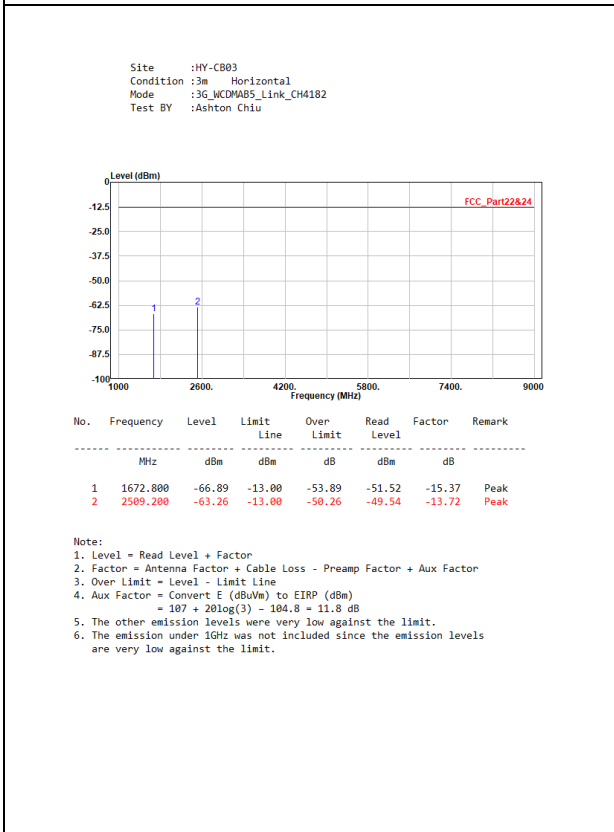
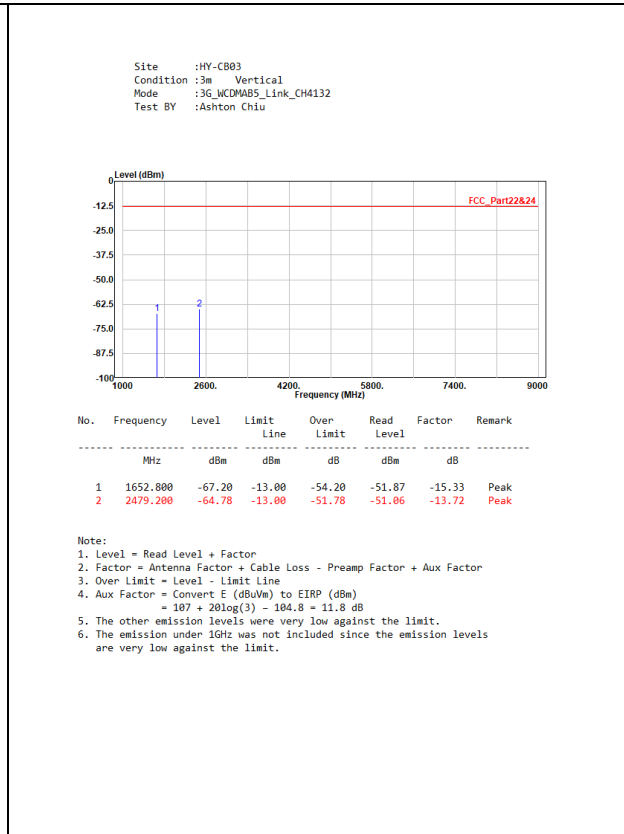
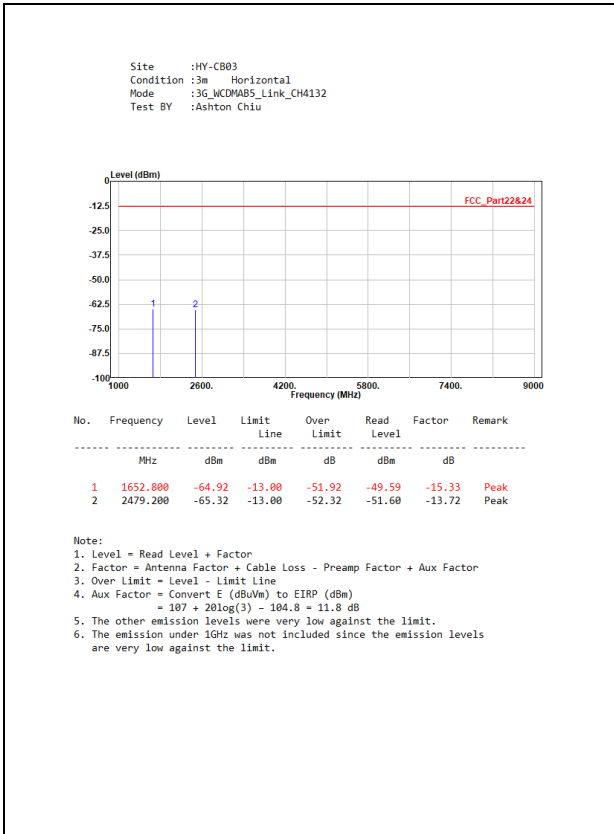

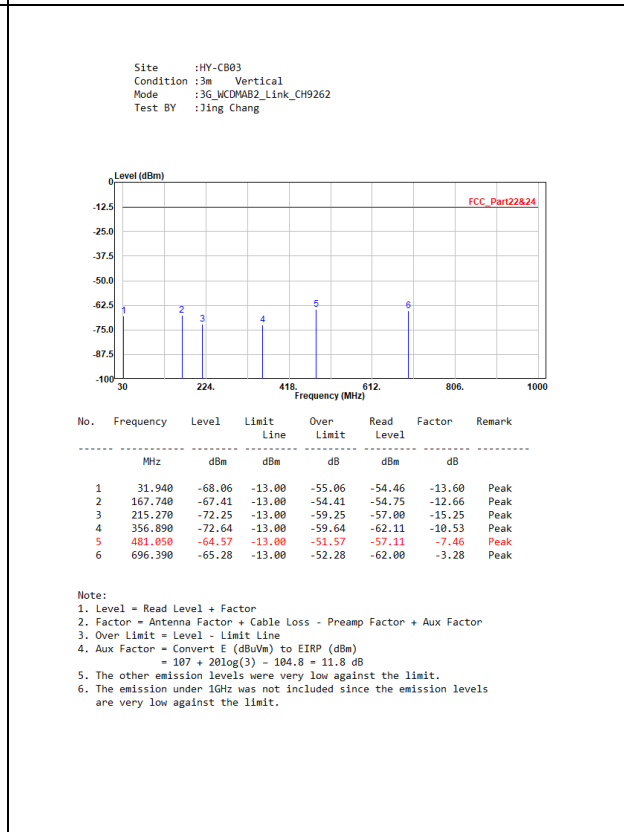
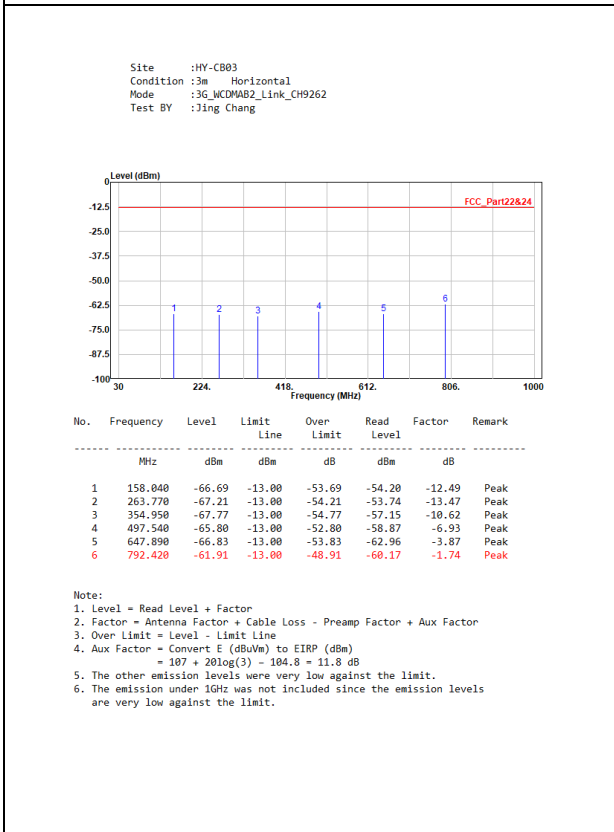
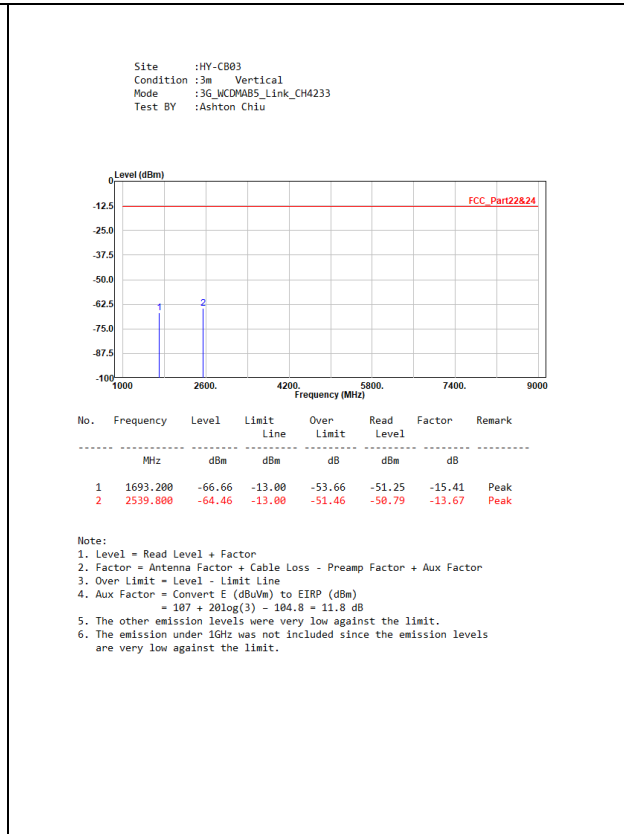
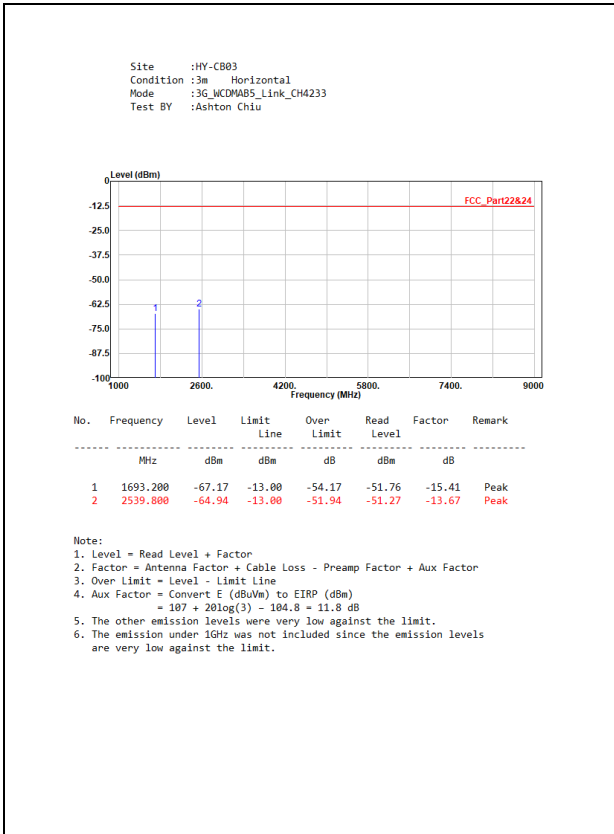

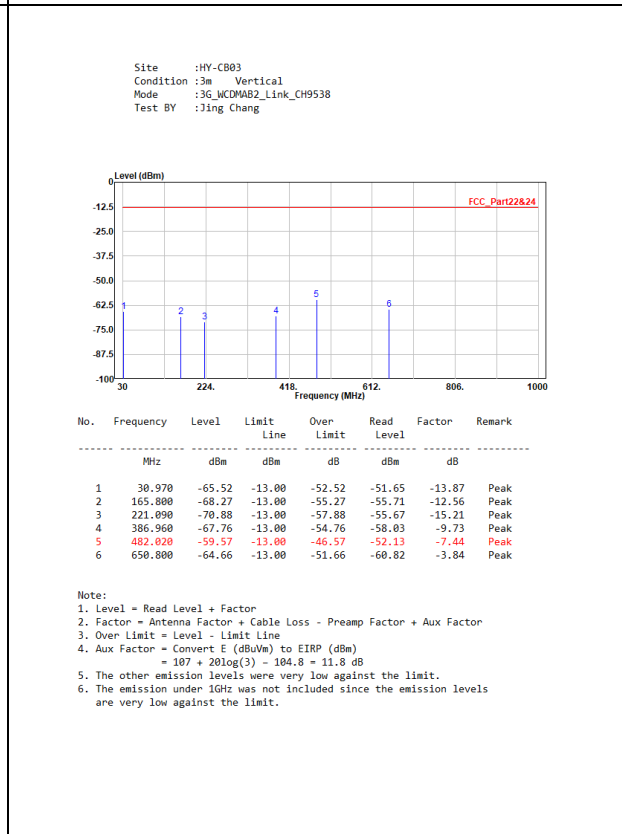
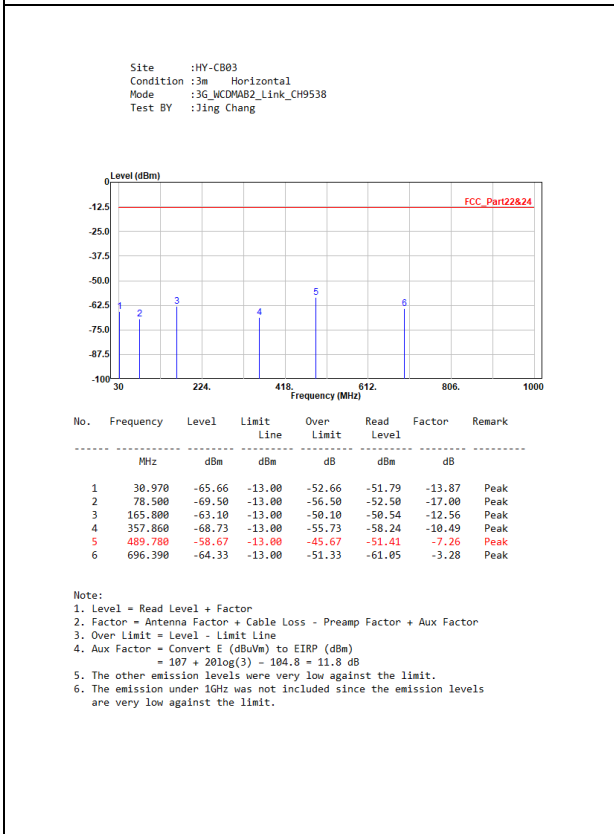
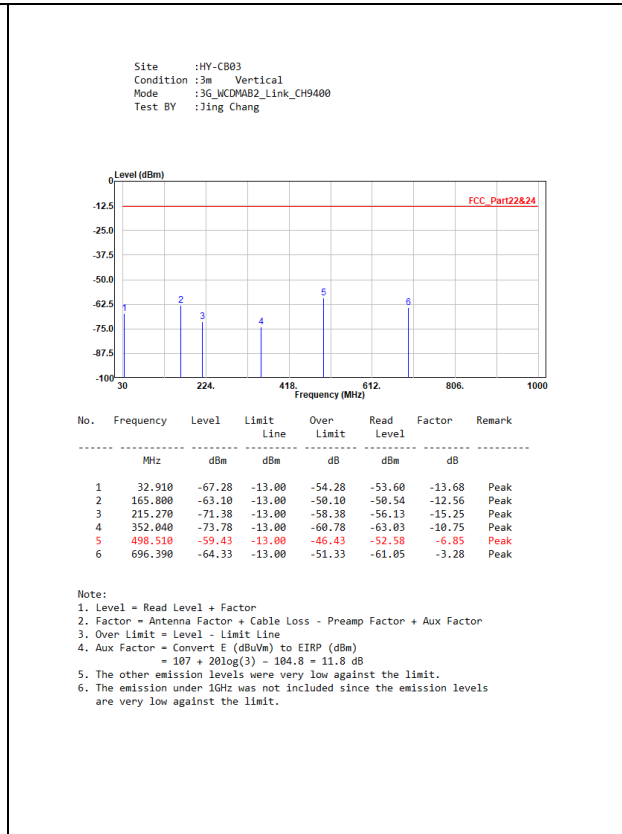
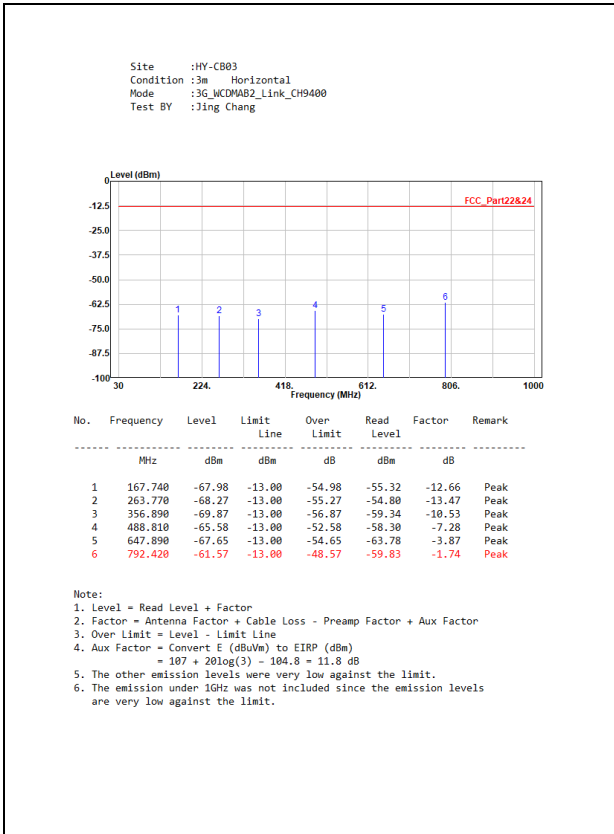

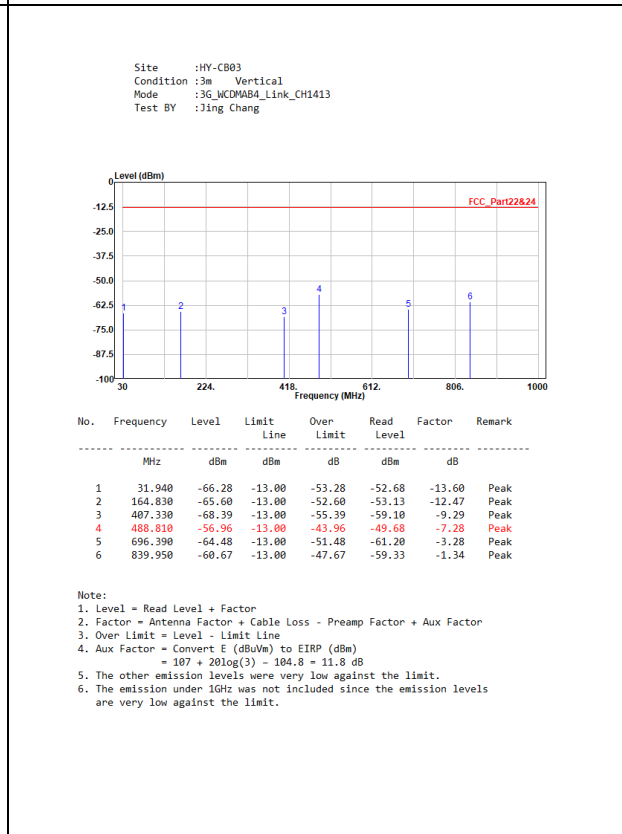
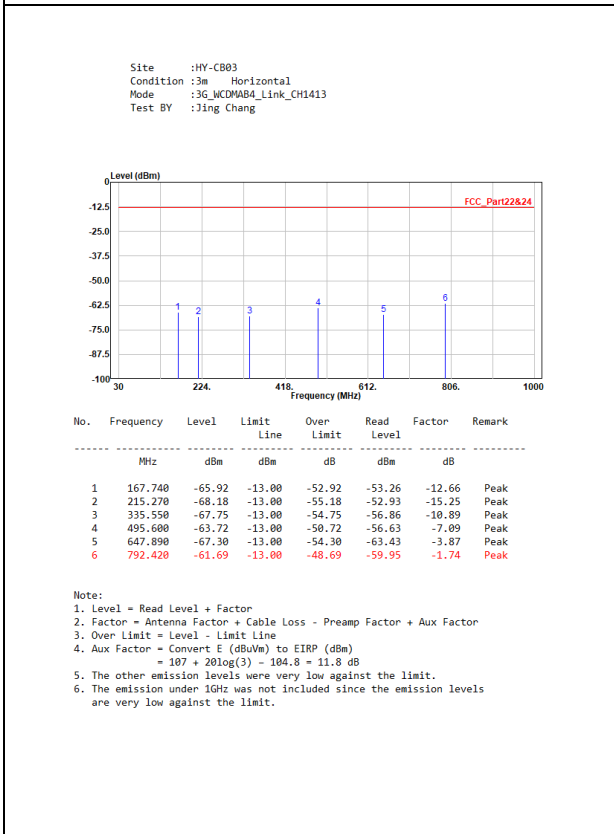
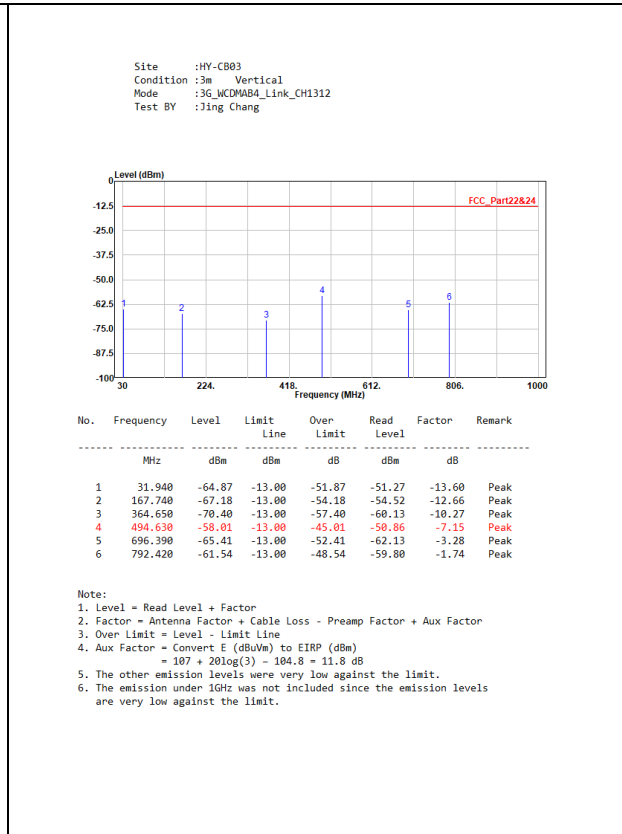
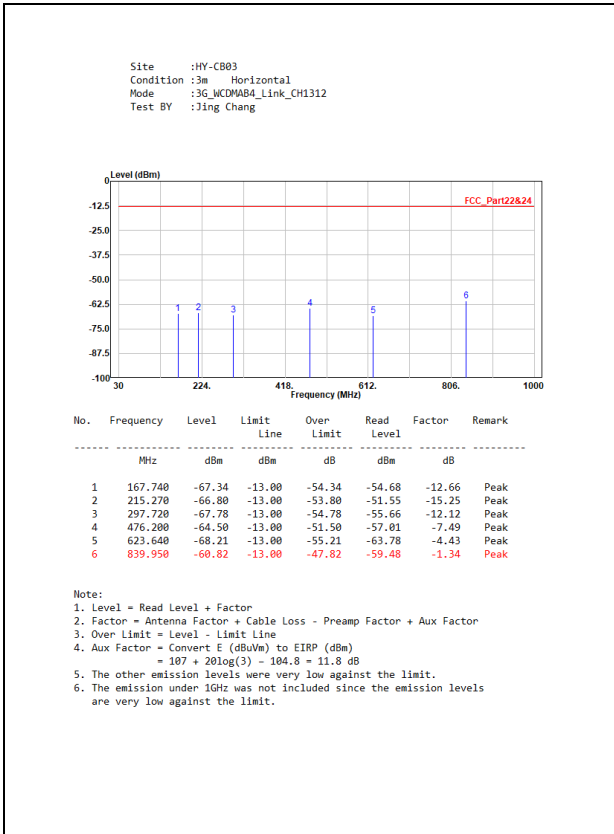

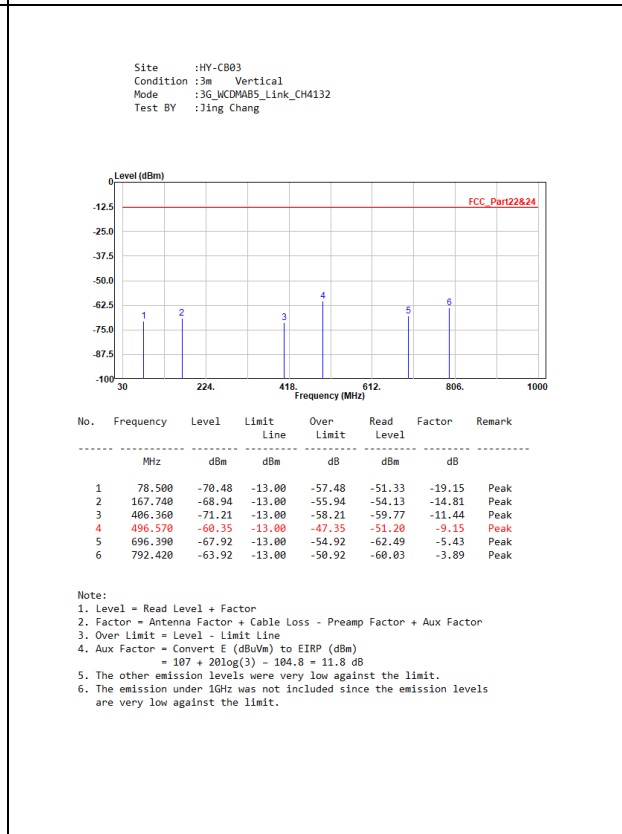
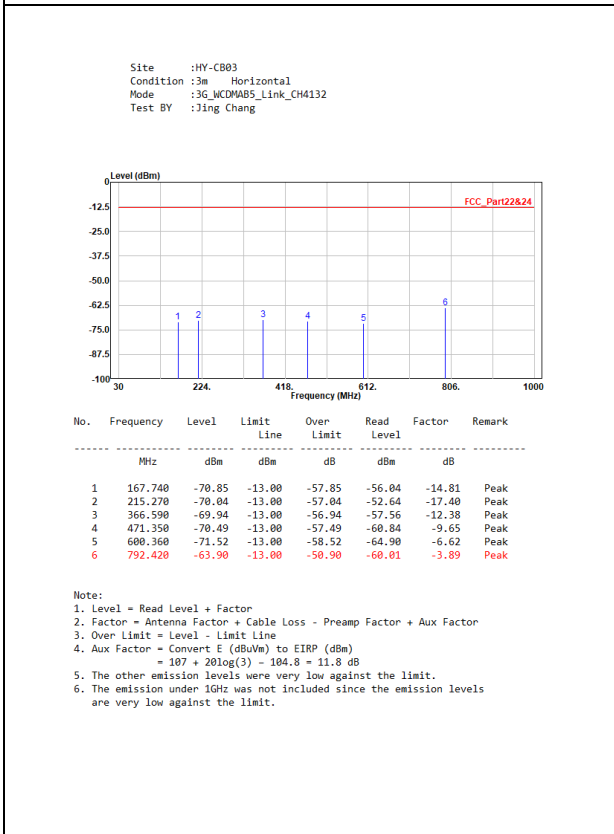
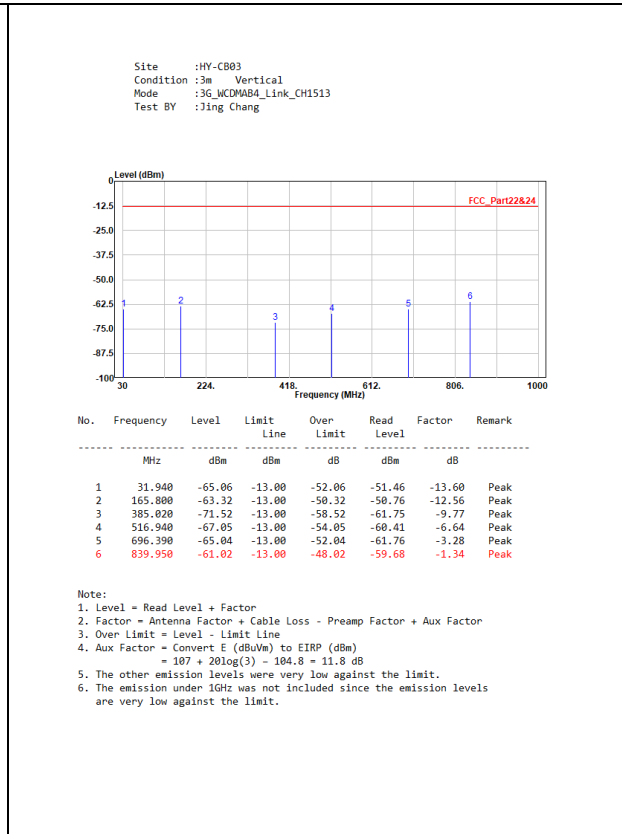
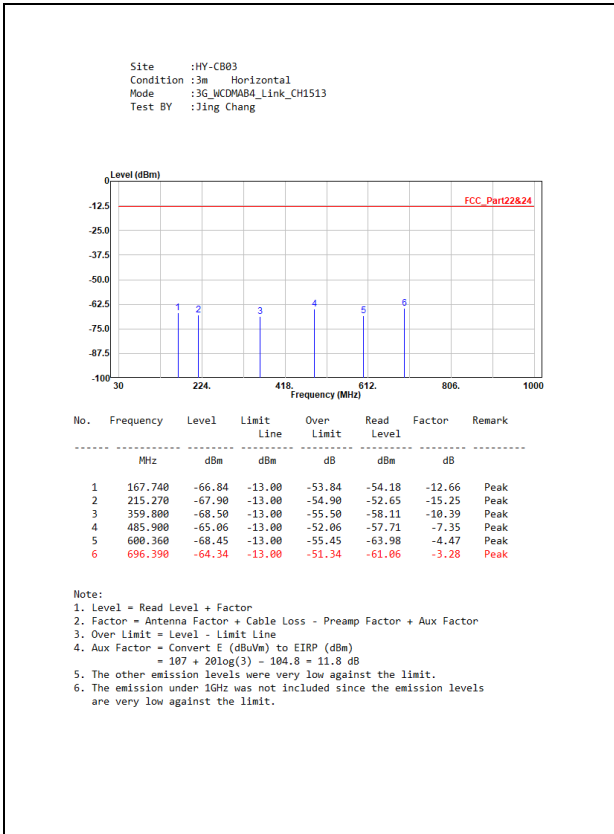

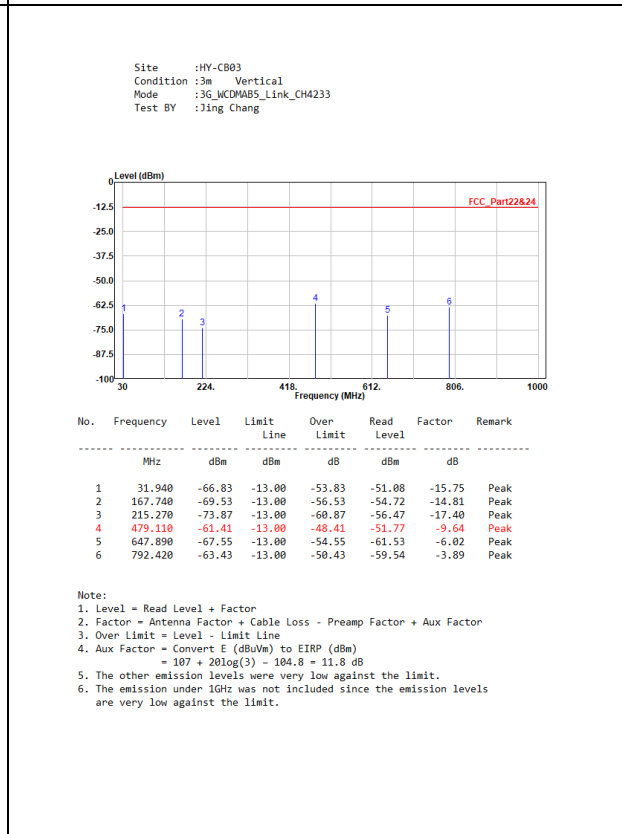
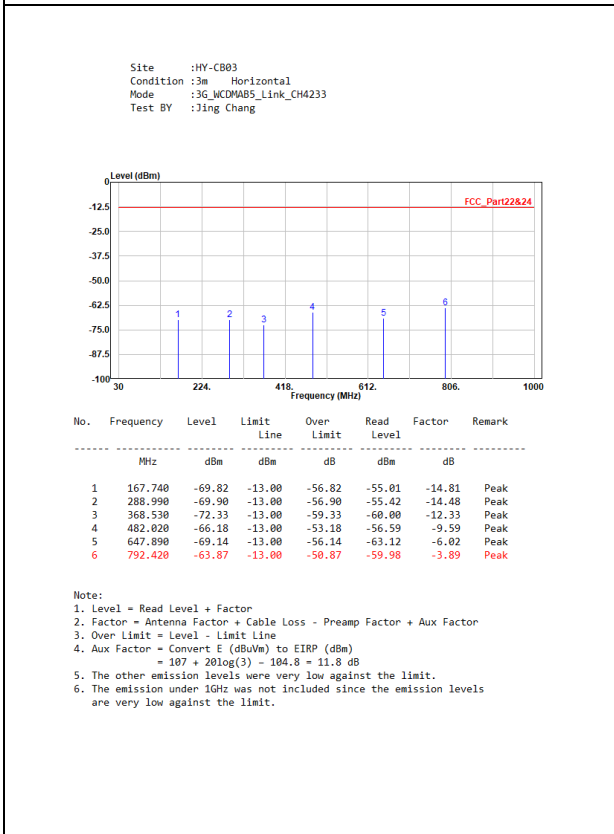
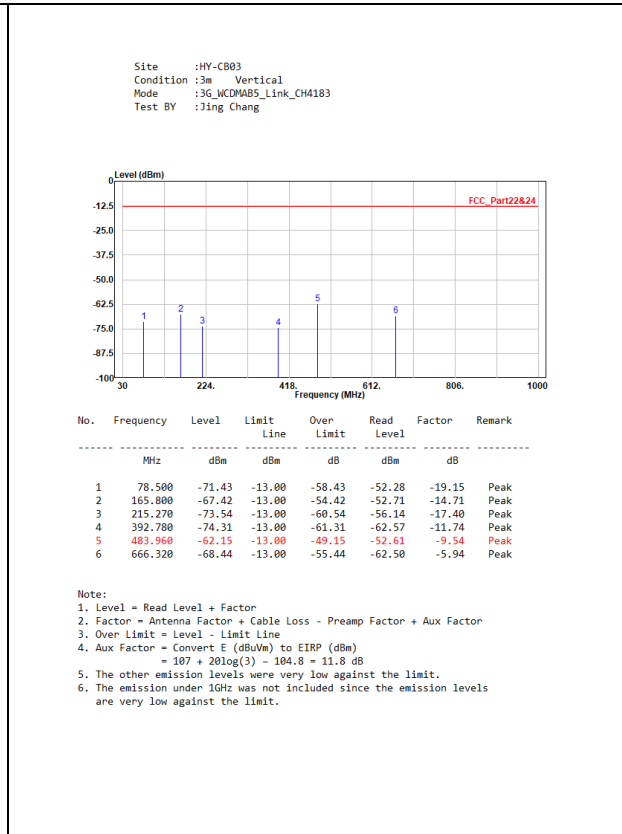
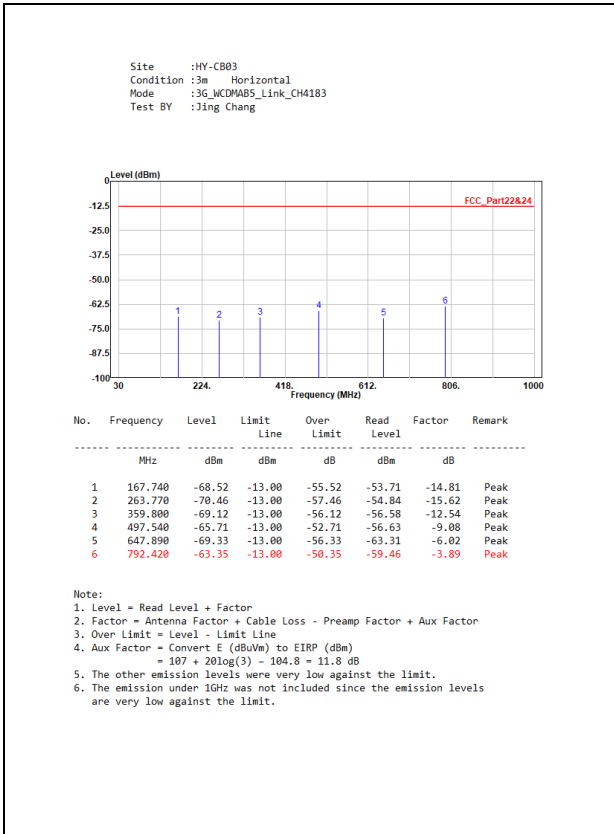

7. Frequency Stability Under Temperature & Voltage Variations

7.1. Test Specification

According to Part 2.1055, 22.355, 24.235, 27.54, RSS-GEN, RSS-132, RSS-133, RSS-139.

7.2. Test Setup

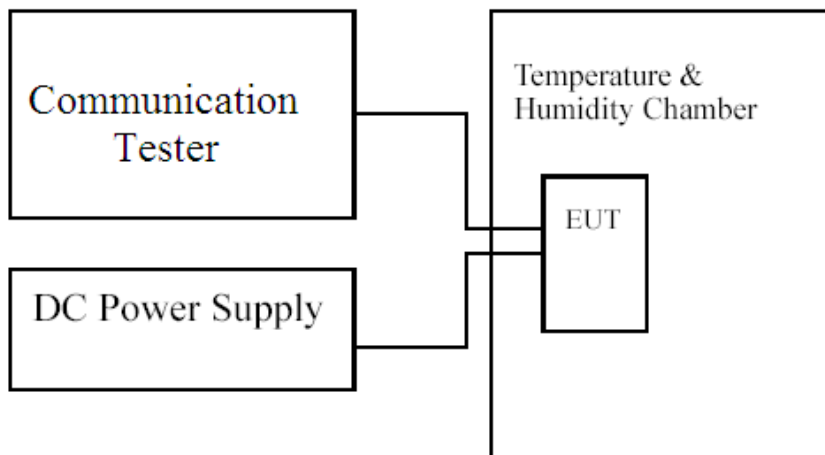

7.3. Limits

Limit	$< \pm 2.5$ ppm
-------	-----------------

7.4. Test Procedure

The frequency stability of transmitter is measured by:

- Temperature: The temperature is varied from -30 °C to 50 °C in 10 °C increment using a standard temperature & Humidity chamber.
- Primary Supply Voltage: The primary supply voltage is varied 85 % to 115 % of the nominal value for non-hand-carried equipment. For hand-carried, battery-powered equipment, primary supply voltage is reduced to the battery operating endpoint which shall be specified by the manufacturer.

The EUT was connected via the base station simulator. Universal Radio Communication Tester, was used to measure The Frequency Error. The maximum result of measurements was recorded.

7.5. Test Result of Frequency Stability Under Temperature Variations

GSM 850

Temperature Variations

Temperature Interval(°C)	Test Channel	Deviation (kHz)		Limit (kHz)
		VOICE	EGPRS	
-30	Low	0.008	0.015	±2.09
-20	Low	0.009	0.015	±2.09
-10	Low	0.009	0.015	±2.09
0	Low	-0.010	0.014	±2.09
10	Low	0.008	0.016	±2.09
20	Low	0.012	0.016	±2.09
30	Low	0.011	0.017	±2.09
40	Low	-0.011	0.016	±2.09
50	Low	-0.010	0.018	±2.09
-30	High	-0.007	0.014	±2.09
-20	High	-0.007	0.015	±2.09
-10	High	-0.009	0.014	±2.09
0	High	0.008	0.015	±2.09
10	High	0.009	0.014	±2.09
20	High	0.009	0.014	±2.09
30	High	-0.008	0.015	±2.09
40	High	0.007	0.017	±2.09
50	High	0.009	0.016	±2.09

Voltage Variations

DC Voltage (V)	Test Channel	Deviation (kHz)		Limit (kHz)
		VOICE	EGPRS	
4.40	Low	0.008	0.017	±2.09
3.85	Low	0.012	0.016	±2.09
3.60	Low	0.011	0.015	±2.09
4.40	High	-0.009	0.016	±2.09
3.85	High	0.009	0.014	±2.09
3.60	High	0.009	0.015	±2.09

GSM 1900

Temperature Variations

Temperature Interval(°C)	Test Channel	Deviation (kHz)		Limit (kHz)
		VOICE	EGPRS	
-30	Low	-0.023	-0.02	±4.77
-20	Low	-0.021	-0.018	±4.77
-10	Low	-0.022	-0.019	±4.77
0	Low	-0.023	-0.017	±4.77
10	Low	-0.02	-0.015	±4.77
20	Low	-0.022	-0.013	±4.77
30	Low	-0.021	-0.014	±4.77
40	Low	-0.021	-0.015	±4.77
50	Low	-0.022	-0.013	±4.77
-30	High	-0.022	-0.023	±4.77
-20	High	-0.023	-0.025	±4.77
-10	High	-0.021	-0.024	±4.77
0	High	-0.019	-0.021	±4.77
10	High	-0.02	-0.022	±4.77
20	High	-0.02	-0.021	±4.77
30	High	-0.023	-0.02	±4.77
40	High	-0.025	-0.02	±4.77
50	High	-0.024	-0.019	±4.77

Voltage Variations

DC Voltage (V)	Test Channel	Deviation (kHz)		Limit (kHz)
		VOICE	EGPRS	
4.40	Low	-0.023	-0.016	±4.77
3.85	Low	-0.022	-0.013	±4.77
3.60	Low	-0.018	-0.014	±4.77
4.40	High	-0.025	-0.019	±4.77
3.85	High	-0.02	-0.021	±4.77
3.60	High	-0.027	-0.021	±4.77

WCDMA Band 2

Temperature Variations

Temperature Interval(°C)	Test Channel	Deviation (kHz)	Limit (kHz)
		RMC	
-30	Low	0.006	±4.71
-20	Low	0.006	±4.71
-10	Low	-0.006	±4.71
0	Low	-0.005	±4.71
10	Low	-0.006	±4.71
20	Low	0.005	±4.71
30	Low	-0.007	±4.71
40	Low	-0.008	±4.71
50	Low	0.007	±4.71
-30	High	-0.008	±4.71
-20	High	-0.008	±4.71
-10	High	0.007	±4.71
0	High	-0.007	±4.71
10	High	0.008	±4.71
20	High	-0.006	±4.71
30	High	-0.009	±4.71
40	High	0.009	±4.71
50	High	-0.010	±4.71

Voltage Variations

DC Voltage (V)	Test Channel	Deviation (kHz)	Limit (kHz)
		RMC	
4.40	Low	-0.005	±4.71
3.85	Low	0.005	±4.71
3.60	Low	-0.004	±4.71
4.40	High	-0.008	±4.71
3.85	High	-0.006	±4.71
3.60	High	-0.010	±4.71

WCDMA Band 4

Temperature Variations

Temperature Interval(°C)	Test Channel	Deviation (kHz)	Limit (kHz)
		RMC	
-30	Low	0.013	±4.33
-20	Low	0.014	±4.33
-10	Low	-0.013	±4.33
0	Low	-0.012	±4.33
10	Low	0.012	±4.33
20	Low	0.013	±4.33
30	Low	-0.015	±4.33
40	Low	0.018	±4.33
50	Low	0.021	±4.33
-30	High	-0.014	±4.33
-20	High	-0.014	±4.33
-10	High	0.013	±4.33
0	High	-0.014	±4.33
10	High	0.013	±4.33
20	High	-0.012	±4.33
30	High	-0.016	±4.33
40	High	0.020	±4.33
50	High	-0.022	±4.33

Voltage Variations

DC Voltage (V)	Test Channel	Deviation (kHz)	Limit (kHz)
		RMC	
4.40	Low	0.012	±4.33
3.85	Low	0.013	±4.33
3.60	Low	0.014	±4.33
4.40	High	-0.012	±4.33
3.85	High	-0.012	±4.33
3.60	High	-0.013	±4.33

WCDMA Band 5

Temperature Variations

Temperature Interval(°C)	Test Channel	Deviation (kHz)	Limit (kHz)
		RMC	
-30	Low	0.005	±2.09
-20	Low	-0.005	±2.09
-10	Low	0.004	±2.09
0	Low	0.006	±2.09
10	Low	-0.004	±2.09
20	Low	0.004	±2.09
30	Low	0.005	±2.09
40	Low	0.006	±2.09
50	Low	0.006	±2.09
-30	High	-0.005	±2.09
-20	High	0.005	±2.09
-10	High	-0.004	±2.09
0	High	-0.005	±2.09
10	High	-0.005	±2.09
20	High	-0.004	±2.09
30	High	0.005	±2.09
40	High	-0.005	±2.09
50	High	-0.006	±2.09

Voltage Variations

DC Voltage (V)	Test Channel	Deviation (kHz)	Limit (kHz)
		RMC	
4.40	Low	0.005	±2.09
3.85	Low	0.004	±2.09
3.60	Low	0.004	±2.09
4.40	High	-0.004	±2.09
3.85	High	-0.004	±2.09
3.60	High	-0.005	±2.09

8. Peak to Average Ratio

8.1. Test Specification

According to Part 22.913, 24.232, 27.50, RSS-GEN, RSS-132, RSS-133, RSS-139.

8.2. Test Setup

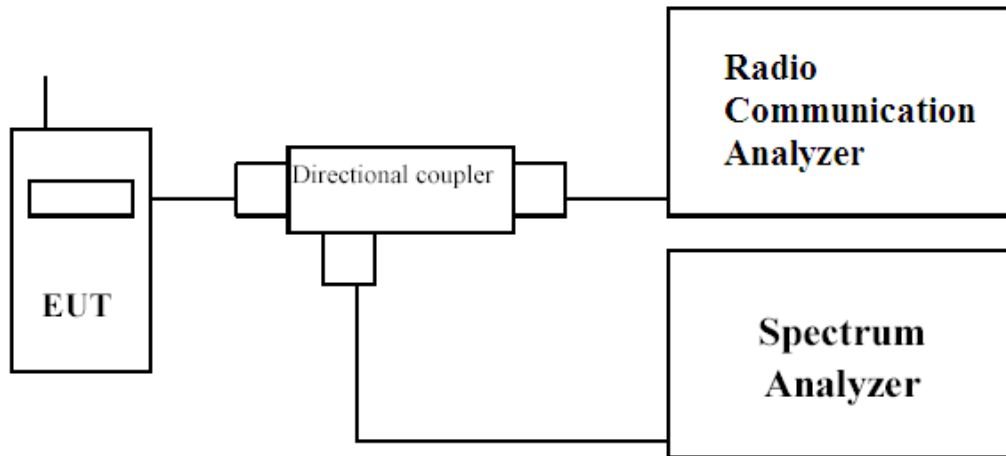

8.3. Limits

The peak-to-average power ratio (PAPR) of the transmitter output power must not exceed 13 dB. The PAPR measurements should be made using either an instrument with complementary cumulative distribution function (CCDF) capabilities to determine that PAPR will not exceed 13 dB for more than 0.1 percent of the time or other Commission approved procedure.

8.4. Test Procedure

- a) Refer to instrument's analyzer instruction manual for details on how to use the power statistics/CCDF function;
- b) Set resolution/measurement bandwidth \geq signal's occupied bandwidth;
- c) Set the number of counts to a value that stabilizes the measured CCDF curve;
- d) Set the measurement interval as follows:
 - 1) for continuous transmissions, set to 1 ms,
 - 2) for burst transmissions, employ an external trigger that is synchronized with the EUT burst timing sequence, or use the internal burst trigger with a trigger level that allows the burst to stabilize and set the measurement interval to a time that is less than or equal to the burst duration.
- e) Record the maximum PAPR level associated with a probability of 0.1 %.

8.5. Test Result of Peak to Average Ratio

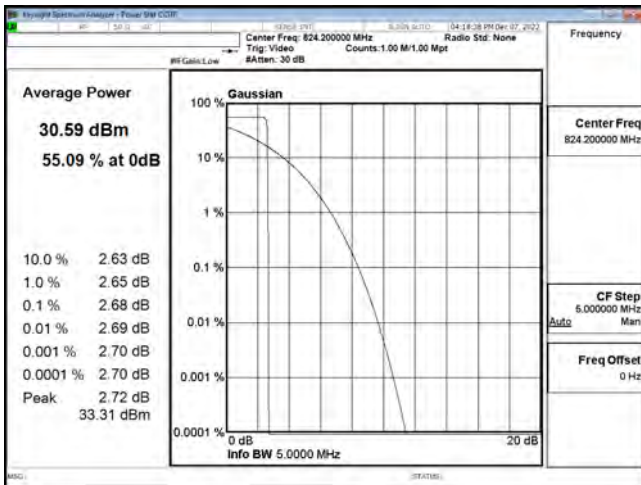

PTAR 2G850 CH128 VOICE

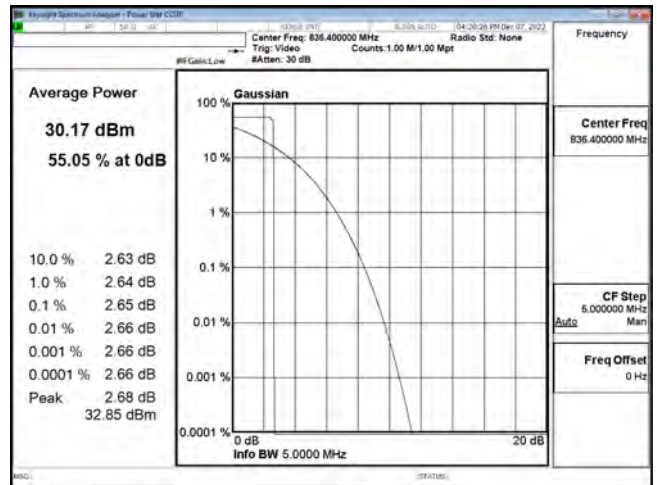

PTAR 2G850 CH189 VOICE

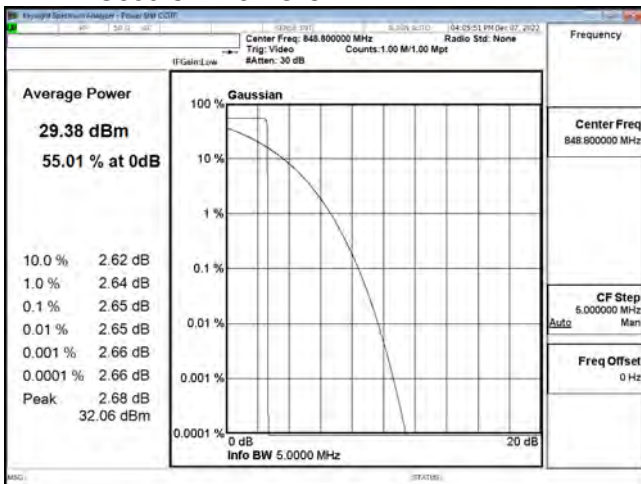

PTAR 2G850 CH251 VOICE

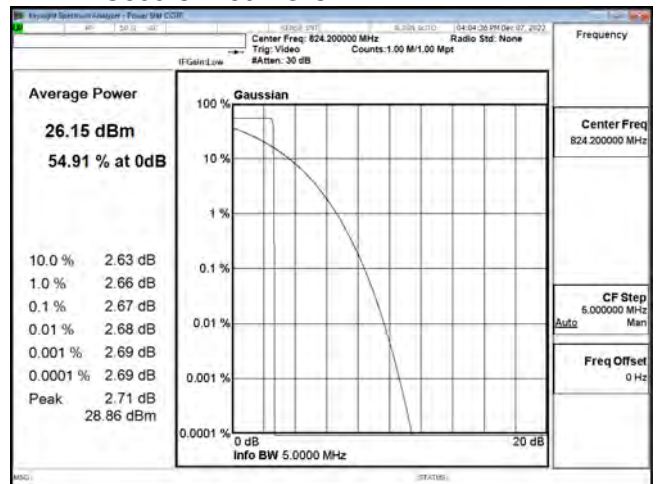

PTAR 2G850 CH128 EGPRS

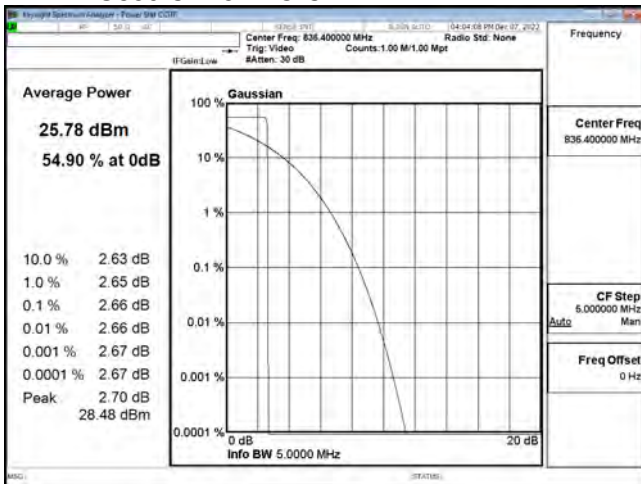

PTAR 2G850 CH189 EGPRS

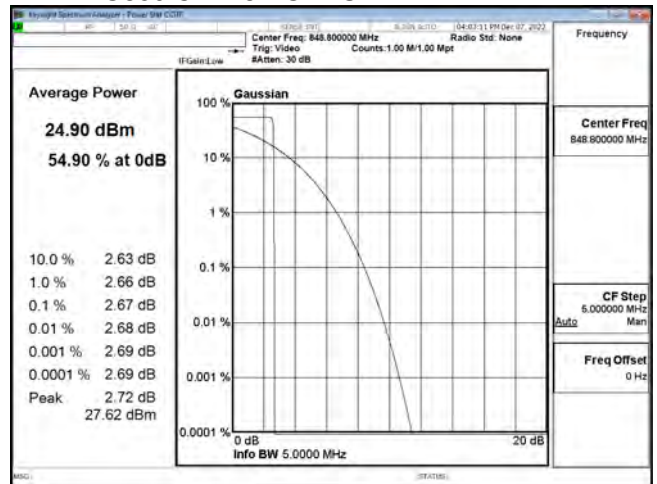

PTAR 2G850 CH251 EGPRS

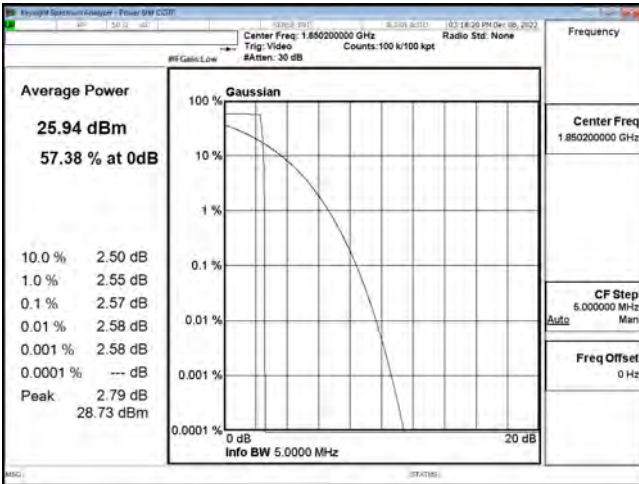

PTAR 2G1900 CH512 VOICE

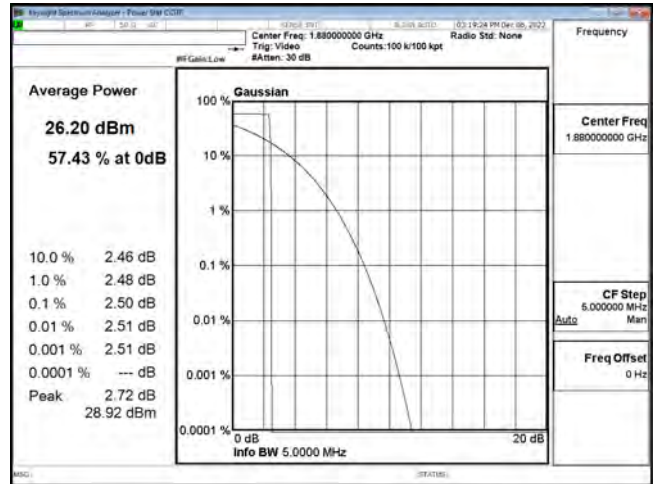

PTAR 2G1900 CH661 VOICE

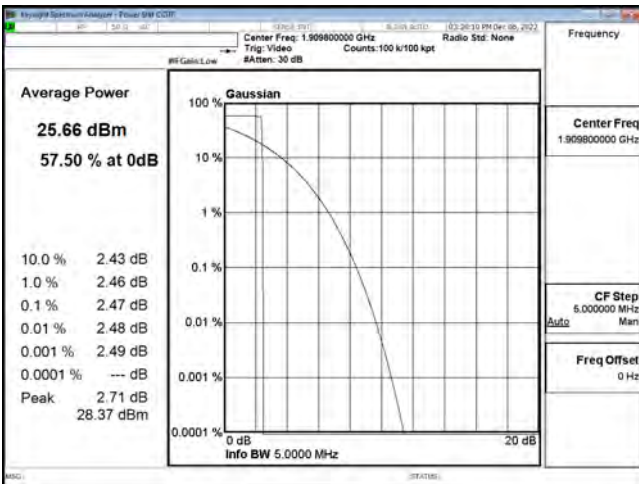

PTAR 2G1900 CH810 VOICE

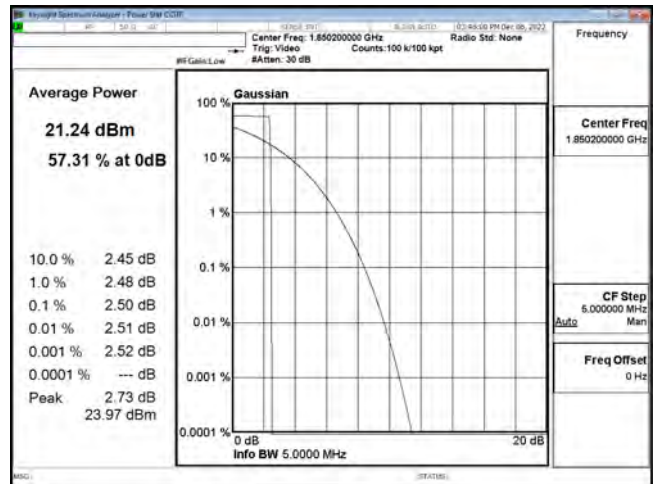

PTAR 2G1900 CH512 EGPRS

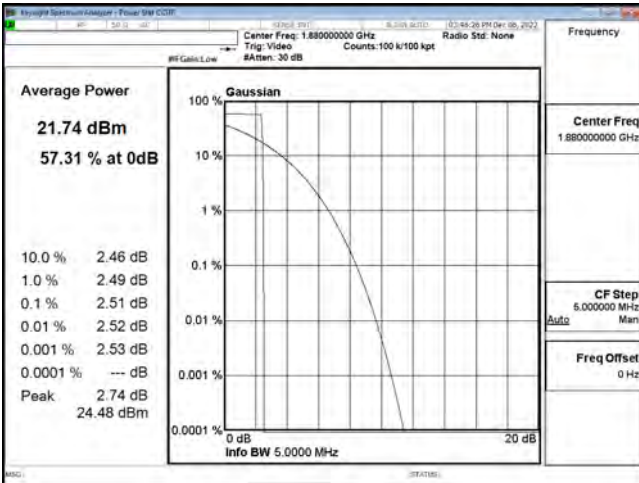

PTAR 2G1900 CH661 EGPRS

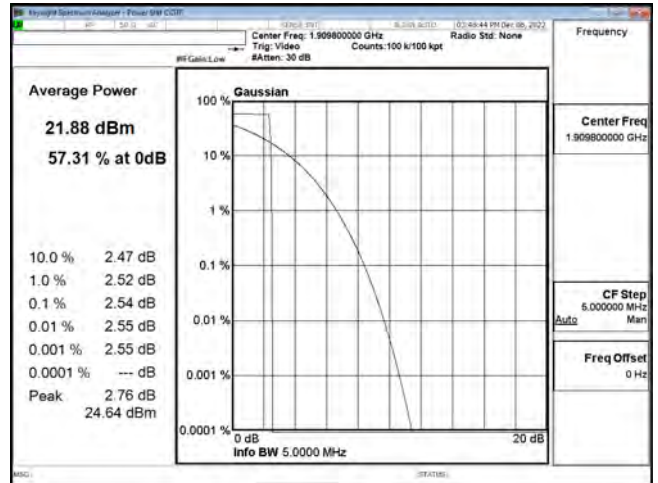

PTAR 2G1900 CH810 EGPRS

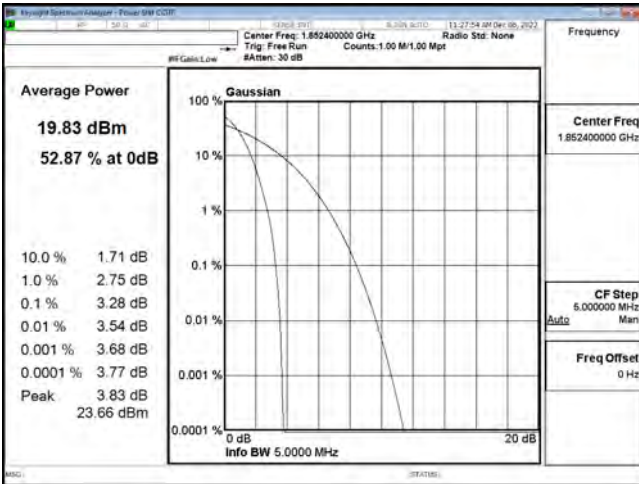

PTAR B2 CH9262 RMC

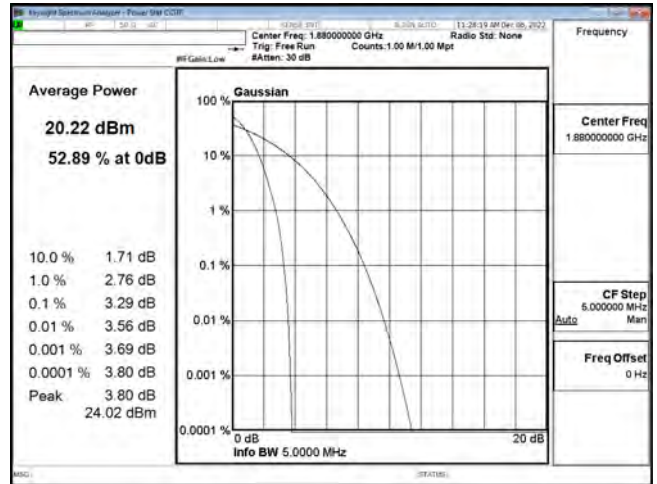

PTAR B2 CH9400 RMC

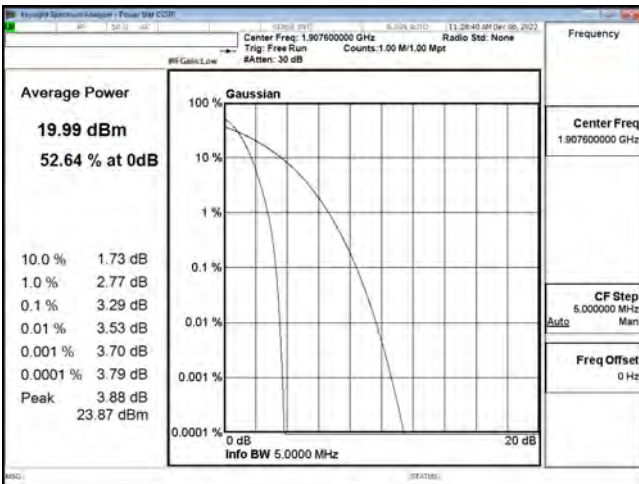

PTAR B2 CH9538 RMC

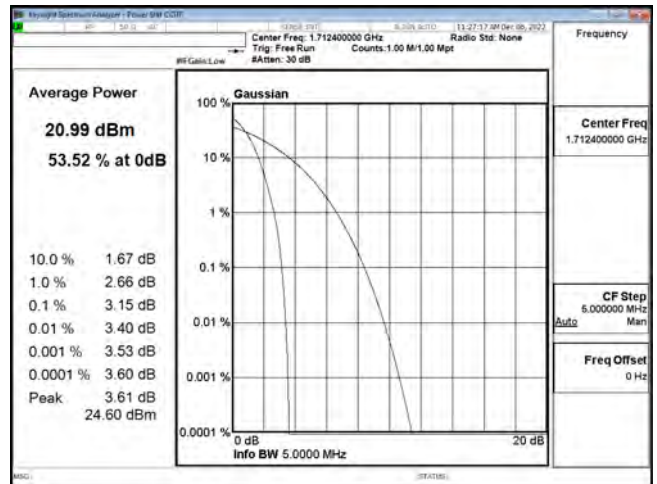

PTAR B4 CH1312 RMC

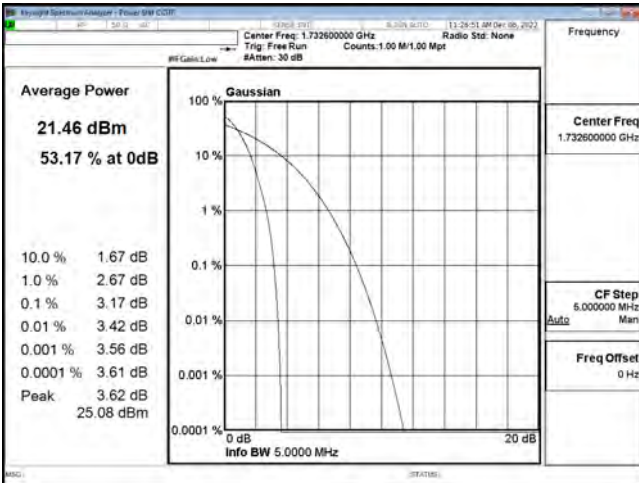

PTAR B4 CH1413 RMC

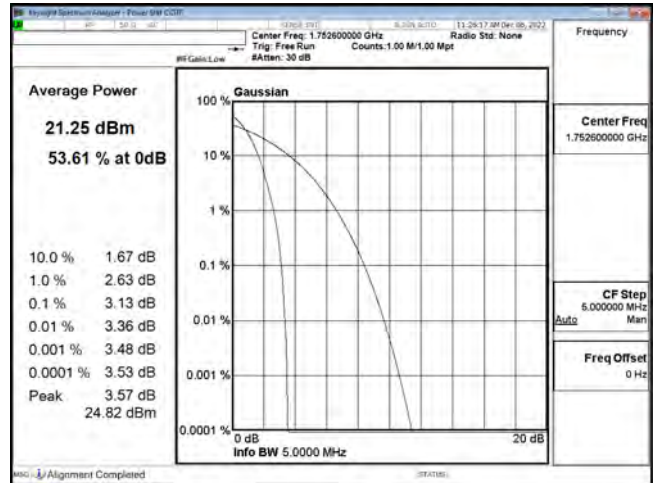

PTAR B4 CH1513 RMC

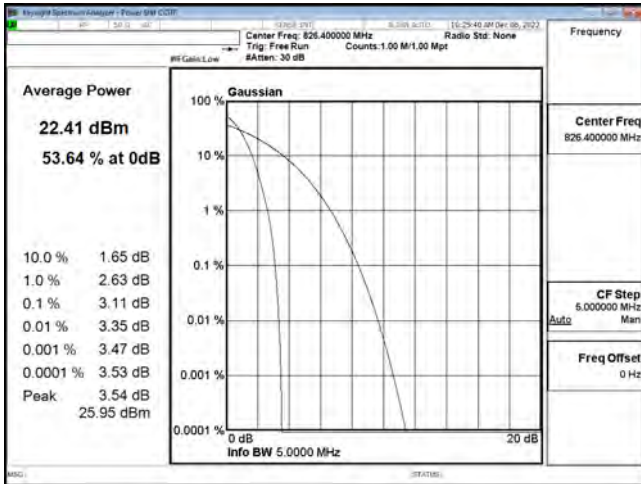

PTAR B5 CH4132 RMC

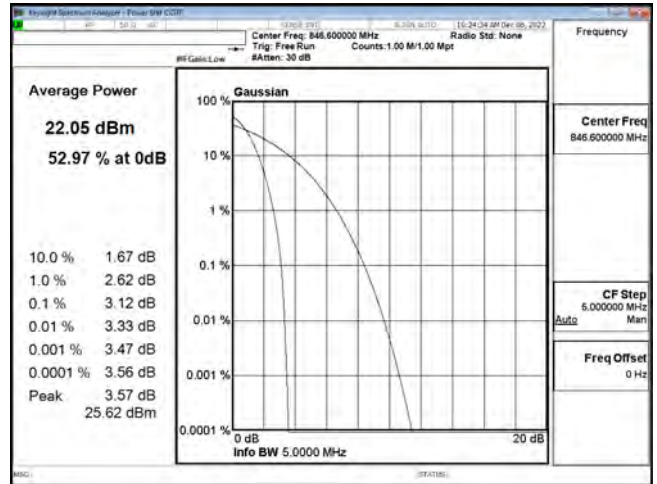

PTAR B5 CH4233 RMC

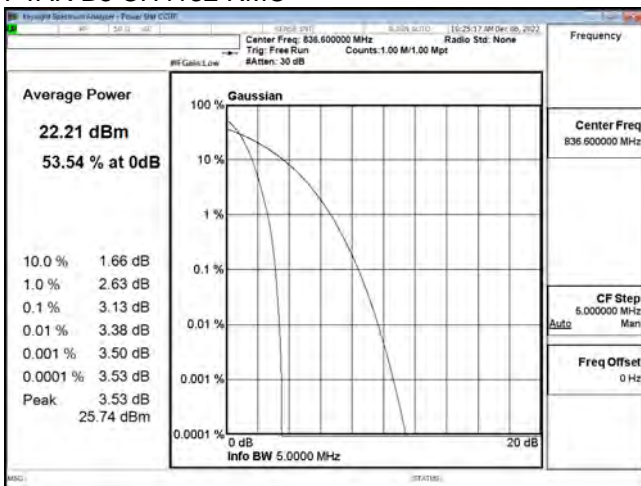

PTAR B5 CH4183 RMC