

Test Report

Product Name : Mobile Computer

Model No. : RS36

FCC ID : Q3N-RS36

Applicant : CipherLab Co., Ltd.

Address : 12F, 333, Dunhua S.Rd., Sec.2, Taipei, Taiwan

Date of Receipt : 2022/10/13

Issued Date : 2023/03/28

Report No. : 22A0299R-RFUSV24S-A

Report Version : V1.0



The test results relate only to the samples tested.

The test results shown in the test report are traceable to the national/international standard through the calibration report of the equipment and evaluated measurement uncertainty herein.

This report must not be used to claim product endorsement by TAF or any agency of the government.

The test report shall not be reproduced without the written approval of DEKRA Testing and Certification Co., Ltd.

Measurement uncertainties evaluated for each testing system and associated connections are given here to provide the system information for reference. Compliance determinations do not take into account measurement uncertainties for each testing system, but are based on the results of the compliance measurement.

Test Report



Product Name : Mobile Computer
Applicant : CipherLab Co., Ltd.
Address : 12F, 333, Dunhua S.Rd., Sec.2, Taipei, Taiwan
Manufacturer : CIPHERLAB CO. LTD.
Trade Name : CIPHERLAB
Model No. : RS36
EUT Rated Voltage : DC 5V (adapter or host equipment)
DC 3.85V for battery
EUT Test Voltage : DC 3.85V
Measurement Standard : FCC CFR Title 47 Part 90
Measurement Reference : FCC CFR Title 47 Part 2
TIA/EIA 603-E 2016
KDB 971168 D01V03R01
ANSI C63.26 2015
Test Result : Complied

Documented By : 
(Project Specialist / Ida Tung)

Tested By : 
(Engineer / Daniel Wu)

Approved By : 
(Manager / Tim Sung)

TABLE OF CONTENTS

1.	General Information	5
1.1.	EUT Description	5
1.2.	Antenna List	5
1.3.	Operational Description.....	6
1.4.	Configuration of tested System	7
1.5.	EUT Setup Procedures	7
1.6.	Test Facility.....	8
2.	Technical Test.....	9
2.1.	Summary of test result	9
2.2.	List of test Equipment.....	10
2.3.	Measurement Uncertainty	11
3.	Conducted Output Power Measurement.....	12
3.1.	Test Specification.....	12
3.2.	Test Setup	12
3.3.	Limits	12
3.4.	Test Procedure	12
3.5.	Test Result of Maximum Power Output	13
3.6.	Maximum Conducted Power and ERP/EIRP Power	16
4.	Occupied Bandwidth.....	17
4.1.	Test Secification	17
4.2.	Test Setup	17
4.3.	Test Procedure	17
4.4.	Test Result of Occupied Bandwidth.....	18
5.	Spurious Emission At Antenna Terminals (+/-1MHz)	24
5.1.	Test Specification.....	24
5.2.	Setup	24
5.3.	Limits	24
5.4.	Test Procedure	24
5.5.	Test Result of Spurious Emission At Antenna Terminals (+/-1MHz)	25
6.	Spurious Emission.....	28
6.1.	Test Specification.....	28
6.2.	Test Setup	28
6.3.	Limits	29
6.4.	Test Procedure	29
6.5.	Test Result of Spurious Emission	30
7.	Frequency Stability Under Temperature & Voltage Variations	35
7.1.	Test Specification.....	35
7.2.	Test Setup	35
7.3.	Limits	35
7.4.	Test Procedure	35
7.5.	Test Result of Frequency Stability Under Temperature Variations.....	35

Appendix 1: EUT Test Photographs

Appendix 2: Product Photos - Please refer to the file: 22A0299R-Product Photos

Revision History

Report No.	Version	Description	Issued Date
22A0299R-RFUSV24S-A	V1.0	Initial issue of report.	2023/03/28

1. General Information

1.1. EUT Description

Product Name	Mobile Computer
Model No.	RS36
Trade Name	CIPHERLAB
IMEI No.	35226598
FCC ID	Q3N-RS36
TX Frequency	LTE Band 26 : 814MHz ~ 824MHz (Part 90)
Rx Frequency	LTE Band 26 : 859MHz ~ 869MHz (Part 90)
Bandwidth	1.4 MHz / 3 MHz / 5 MHz / 10 MHz
Type of Modulation	QPSK / 16QAM / 64QAM
Power Cable (Optional)	Trade Name: CIPHERLAB, M/N: RS35 SNAP ON, Non-shielded, 1.5m
Adapter #1 (Optional)	Trade Name: Sunny, M/N: SYS1561-1005 Input: AC 100-240V~, 1.0A MAX, 50-60Hz Output: +5.0V=2.0A
Adapter #2 (Optional)	Trade Name: CWT, M/N: 2AEA010BC3D Input: AC 100-240V~ 50/60Hz 0.35A Output: 5.0V=2.0A 10.0W

Supported Unit	
Type C Cable	Trade Name: SUNCA, M/N: 1Q11512211-XJ, Shielded, 1m

1.2. Antenna List

No.	Manufacturer	Part No.	Antenna Type	Peak Gain
1	Auden	KZWLSLSVS0001 (LTE Main, TX/RX)	PIFA	-0.1 dBi for Band 26 (Part 90)
2	Auden	KZWLSLSVS0001 (LTE Aux, TX/RX)	PIFA	-5.4 dBi for Band 26 (Part 90)

Note: The above EUT information is declared by the manufacturer

1.3. Operational Description

The EUT provide all functions described as above. The EUT is tested with maximum rated TX power via the Base Station simulator. DEKRA has verified the construction and function in typical operation. All the test modes were carried out with the EUT in normal operation, which was shown in this test report and defined as:

Test Mode	Mode 1: LTE Band 26 (Part 90)
-----------	-------------------------------

Note:

1. Regards to the frequency band operation; the lowest, middle and highest frequency of channel were selected to perform the test, and then shown on this report.
2. This device was tested under all configurations, combinations, bandwidths, RB configurations and modulations, and the worst case was found in QPSK modulation, therefore the “Conducted Band Edge” & “Spurious Emission” test items perform QPSK modulation in this report.
3. Determining compliance shall be based on the results of the compliance measurement, not taking into account measurement instrumentation uncertainty.
4. The EUT was performed at X axis, Y axis and Z axis position for radiated spurious emission tests. The worst case was found at Z axis, so the measurement will follow this same test configuration

1.4. Configuration of tested System

(a) Configuration of Radiated measurement

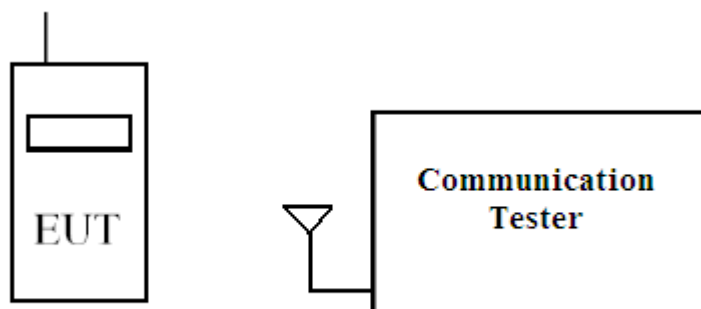

(b) Configuration of Conducted measurement

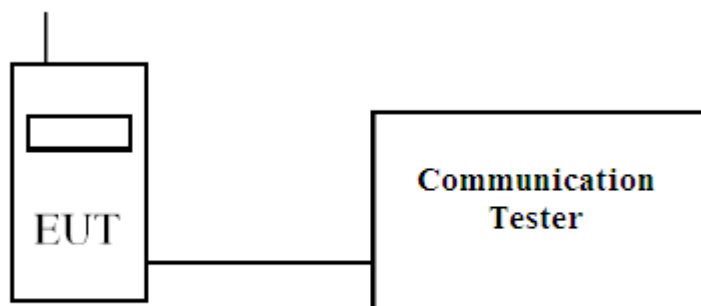

1.5. EUT Setup Procedures

- (1) Setup the EUT and simulators as shown on 1.4.
- (2) Turn on the power of all equipment.
- (3) The EUT was set to communicate with Base Station simulator.
- (4) Repeat the above procedure (3).

1.6. Test Facility

Ambient conditions in the laboratory:

Performed Item	Items	Actual	Test Date
Radiated Emission	Temperature (°C)	25.3 °C	2022/11/29 ~ 2022/12/16
	Humidity (%RH)	69.9 %	
Conductive	Temperature (°C)	24.2 °C	
	Humidity (%RH)	50.0 %	

USA : FCC Registration Number: TW0033

Canada : CAB Identifier Number: TW3023 / Company Number: 26930

Site Description : Accredited by TAF
Accredited Number: 3023

Test Laboratory : DEKRA Testing and Certification Co., Ltd
Address : No. 5-22, Ruishukeng Linkou District, New Taipei City, 24451, Taiwan
Performed : No. 26, Huaya 1st Rd., Guishan Dist., Taoyuan City 333411, Taiwan,
Location : R.O.C.
Phone number : +886-3-275-7255
Fax number : +886-3-327-8031
Email address : info.tw@dekra.com
Website : <http://www.dekra.com.tw>

2. Technical Test

2.1. Summary of test result

Test Item	FCC Reference section	FCC Limit	Result
RF Output Power	§2.1046	<100 Watts	Pass
	§90.635(b)		
Occupied Bandwidth	§2.1049	Within the frequency range	Pass
	§90.209(b)		
Spurious Emission at Antenna Terminals	§2.1051	<-20 dBm for less than 37.5 kHz <-13 dBm for greater than 37.5 kHz	Pass
	§90.691		
Conducted Emission	§2.1051	<-13 dBm	Pass
	§90.691		
Field Strength of Spurious Radiation	§2.1053	<-13 dBm	Pass
	§90.691		
Frequency Stability for Temperature & Voltage	§2.1055	<±2.5 ppm	Pass
	§90.213		
Peak to Average Ratio	N/A	N/A	N/A

2.2. List of test Equipment

Conducted / HY-SR03

Instrument Description	Manufacturer	Model No.	Serial No.	Last Calibration	Next Calibration
Spectrum Analyzer	Agilent	N9010A	MY51440132	2022/01/07	2023/01/06
Standard Temperature & Humidity Chamber	K SON	THS-D4T-100	A0606	2022/08/23	2023/08/22
DC Power Supply	Keysight	E36234A	MY59001234	2022/10/31	2023/10/30
Radio Communication Analyzer	Anritsu	MT8820C	6201465467	2022/08/10	2023/08/09

Radiated / HY-CB03

Instrument Description	Manufacturer	Model No.	Serial No.	Last Calibration	Next Calibration
Bi-Log Antenna	SCHWARZBECK	VULB9168	9168-675	2021/08/11	2023/08/10
Horn Antenna	Com-Power	AH-840	101100	2021/10/04	2023/10/03
Horn Antenna	RF SPIN	DRH18-E	210508A18ES	2022/06/08	2023/06/07
Pre-Amplifier	SGH	0301	20211007-10	2022/02/22	2023/02/21
Pre-Amplifier	SGH	PRAMP118	20200701	2022/07/28	2023/07/27
Pre-Amplifier	EMCI	EMC05820SE	980310	2022/07/28	2023/07/27
Pre-Amplifier	EMCI	EMC184045SE	980369		
Coaxial Cable	EMCI	EMC102-KM-KM-600	1160314	2022/05/12	2023/05/11
Coaxial Cable	EMCI	EMC102-KM-KM-7000	170242		
Spectrum Analyzer	R&S	FSV3044	101114	2022/02/11	2023/02/10
Coaxial Cable	SGH	SGH18	2021005-1		
Coaxial Cable	SGH	SGH18	202108-4	2022/3/18	2023/03/17
Coaxial Cable	SGH	HA800	GD20110223-1		
Coaxial Cable	SGH	HA800	GD20110222-3		
Radio Communication Analyzer	Anritsu	MT8820C	6201465467	2022/08/10	2023/08/09

2.3. Measurement Uncertainty

Uncertainties have been calculated according to the DEKRA internal document with the emissions test results be included in the report. The measurement uncertainties given below are based on a 95 % confidence level based on a coverage factor ($k=2$).

Test Item	Uncertainty
Conducted Output Power	± 1.52 dB
Occupied Bandwidth	± 5.32 Hz
Conducted Band Edge	± 1.52 dB
Conducted Spurious Emissions	± 1.52 dB
Radiated Spurious Emissions	± 4.05 dB below 1 GHz ± 4.10 dB above 1 GHz
Frequency Stability	± 220.92 Hz

3. Conducted Output Power Measurement

3.1. Test Specification

According to FCC Part 2.1046, 90.635

3.2. Test Setup

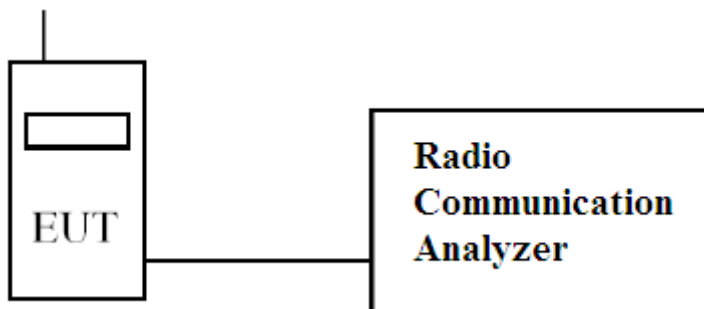

3.3. Limits

Band	Limit
LTE Band 26/850	ERP < 100 W

3.4. Test Procedure

The EUT is tested with maximum rated TX power via the Base Station simulator, and the output power was measured at the antenna terminals of the EUT.

3.5. Test Result of Maximum Power Output

Channel	Modulation	LTE Band 26 (Part 90)					
		RB	RB	Maximum Conducted Output Power			
		No.	Offset	1.4 M	3 M	5 M	10 M
Low	QPSK	1	#0	22.35	23.48	22.56	--
		1	#Mid	22.38	23.63	23.64	--
		1	#Max	22.34	22.58	22.54	--
		50%	#0	22.37	22.30	22.31	--
		50%	#Mid	22.33	22.45	22.40	--
		50%	#Max	22.30	22.37	22.28	--
		100%	--	21.29	22.30	22.39	--
	16QAM	1	#0	22.25	22.77	22.25	--
		1	#Mid	22.29	23.14	23.05	--
		1	#Max	22.29	22.82	21.79	--
		50%	#0	22.09	21.66	21.37	--
		50%	#Mid	22.16	21.71	21.67	--
		50%	#Max	22.10	21.65	21.33	--
		100%	--	21.01	21.55	21.44	--
	64QAM	1	#0	21.96	21.75	21.27	--
		1	#Mid	22.06	22.13	22.06	--
		1	#Max	22.00	21.82	20.84	--
		50%	#0	21.93	20.69	20.45	--
		50%	#Mid	22.00	20.73	20.74	--
		50%	#Max	21.96	20.65	20.42	--
		100%	--	20.69	20.61	20.47	--

Channel	Modulation	LTE Band 26 (Part 90)					
		RB	RB	Maximum Conducted Output Power			
		No.	Offset	1.4 M	3 M	5 M	10 M
Mid	QPSK	1	#0	22.01	22.43	22.63	22.59
		1	#Mid	22.45	23.37	23.34	23.68
		1	#Max	22.22	22.35	22.74	22.68
		50%	#0	22.00	22.26	22.14	22.21
		50%	#Mid	20.52	22.51	22.50	22.41
		50%	#Max	21.90	22.09	22.19	22.16
		100%	--	21.37	22.38	22.16	22.09
	16QAM	1	#0	22.30	22.34	21.88	21.87
		1	#Mid	22.42	22.70	22.65	22.97
		1	#Max	22.37	22.59	22.07	22.01
		50%	#0	22.10	21.47	21.21	21.26
		50%	#Mid	22.40	21.62	21.56	21.45
		50%	#Max	22.37	21.50	21.26	21.20
		100%	--	21.51	21.48	21.21	21.13
	64QAM	1	#0	21.61	21.32	20.92	20.85
		1	#Mid	21.86	21.69	21.64	21.99
		1	#Max	21.82	21.59	21.04	20.94
		50%	#0	21.55	20.48	20.26	20.29
		50%	#Mid	21.85	20.64	20.64	20.50
		50%	#Max	21.83	20.52	20.32	20.26
		100%	--	20.46	20.54	20.24	20.16

Channel	Modulation	LTE Band 26 (Part 90)					
		RB	RB	Maximum Conducted Output Power			
		No.	Offset	1.4 M	3 M	5 M	10 M
High	QPSK	1	#0	22.33	22.72	22.59	--
		1	#Mid	22.48	22.74	22.88	--
		1	#Max	22.17	22.08	22.05	--
		50%	#0	21.42	21.56	21.90	--
		50%	#Mid	21.41	21.44	21.81	--
		50%	#Max	21.33	21.25	21.22	--
		100%	--	21.25	21.40	21.57	--
	16QAM	1	#0	21.64	21.99	21.84	--
		1	#Mid	21.70	22.00	22.23	--
		1	#Max	21.51	21.41	20.93	--
		50%	#0	21.51	20.67	20.97	--
		50%	#Mid	21.54	20.55	20.88	--
		50%	#Max	21.45	20.36	20.29	--
		100%	--	20.38	20.47	20.63	--
	64QAM	1	#0	20.75	21.03	20.90	--
		1	#Mid	20.79	21.05	21.24	--
		1	#Max	20.65	20.45	19.95	--
		50%	#0	20.65	19.72	20.04	--
		50%	#Mid	20.67	19.59	19.98	--
		50%	#Max	20.59	19.37	19.38	--
		100%	--	19.34	19.52	19.67	--

3.6. Maximum Conducted Power and ERP/EIRP Power

$$\text{EIRP} = P_T + G_T - L_C = \text{ERP} + 2.15 \text{ dB}, \text{ERP} = \text{EIRP} - 2.15 \text{ dB}$$

P_T = transmitter output power in dBm

G_T = gain of the transmitting antenna in dBi

L_C = signal attenuation in the connecting cable between the transmitter and antenna in dB

LTE Band	BW	Modulation	Conducted Peak Power (dBm)	Conducted Peak Power (W)	Antenna Gain (dBi)	Maximum ERP/EIRP (W)	Maximum ERP/EIRP Limit (W)
26	1.4 M	QPSK	22.48	0.177	-0.1	0.105	100
		16QAM	22.42	0.175	-0.1	0.104	100
		64QAM	22.06	0.161	-0.1	0.096	100
	3 M	QPSK	23.63	0.231	-0.1	0.137	100
		16QAM	23.14	0.206	-0.1	0.123	100
		64QAM	22.13	0.163	-0.1	0.097	100
	5 M	QPSK	23.64	0.231	-0.1	0.138	100
		16QAM	23.05	0.202	-0.1	0.120	100
		64QAM	22.06	0.161	-0.1	0.096	100
	10 M	QPSK	23.68	0.233	-0.1	0.139	100
		16QAM	22.97	0.198	-0.1	0.118	100
		64QAM	21.99	0.158	-0.1	0.094	100

4. Occupied Bandwidth

4.1. Test Secification

According to FCC Part 2.1049, 90.209

4.2. Test Setup

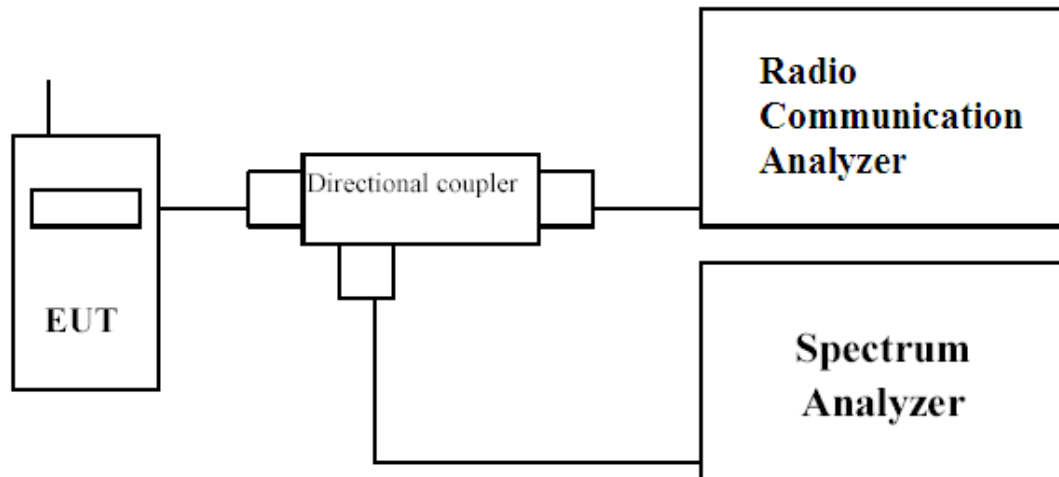

4.3. Test Procedure

The EUT is tested with maximum rated TX power via the Base Station simulator, and the occupied bandwidth was measured at the antenna terminals of the EUT. The Resolution BW of the analyzer is set to 1 %~5 % of the emission bandwidth. The EUT's occupied bandwidth is measured as the width of the signal between two points, one below the carrier center frequency and one above the carrier frequency, outside of which all emissions are attenuated at least 26 dB below the transmitter power. The plots below show the resultant display from the Spectrum Analyser.

4.4. Test Result of Occupied Bandwidth

BW	Channel	Frequency (MHz)	99 % Occupied Bandwidth (MHz)			26 dB bandwidth (MHz)		
			QPSK	16QAM	64QAM	QPSK	16QAM	64QAM
1.4 M	26697	814.7	1.0919	1.0904	1.0963	1.286	1.287	1.281
1.4 M	26740	819	1.0916	1.0891	1.0954	1.281	1.291	1.278
1.4 M	26783	823.3	1.0907	1.0899	1.0945	1.280	1.285	1.282
3 M	26705	815.5	2.7297	2.7146	2.7185	3.058	3.027	3.043
3 M	26740	819	2.7300	2.7179	2.7183	3.058	3.040	3.048
3 M	26775	822.5	2.7335	2.7176	2.7198	3.054	3.036	3.047
5 M	26715	816.5	4.4950	4.5074	4.4873	5.001	5.033	4.971
5 M	26740	819	4.4921	4.5147	4.4892	4.995	5.036	4.978
5 M	26765	821.5	4.4975	4.5163	4.4856	4.975	5.027	4.982
10 M	26740	819	9.0382	9.0366	9.0333	10.03	10.01	9.989

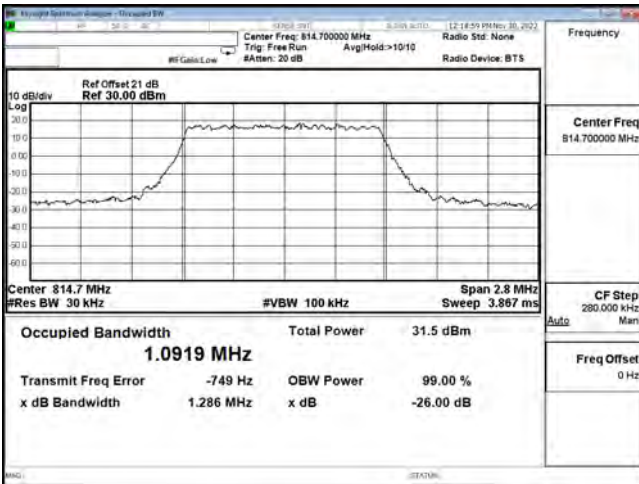

OCC B26 1.4 M CH26697 QPSK

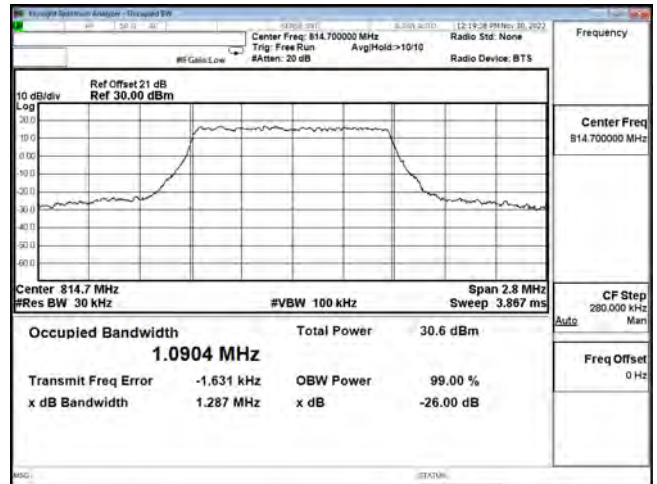

OCC B26 1.4 M CH26697 16QAM

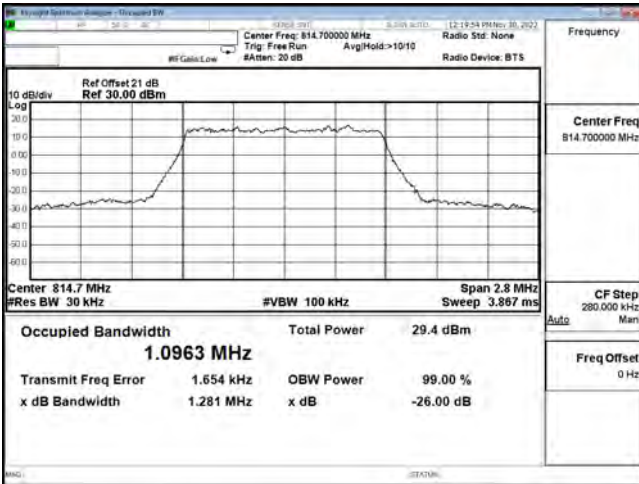

OCC B26 1.4 M CH26697 64QAM

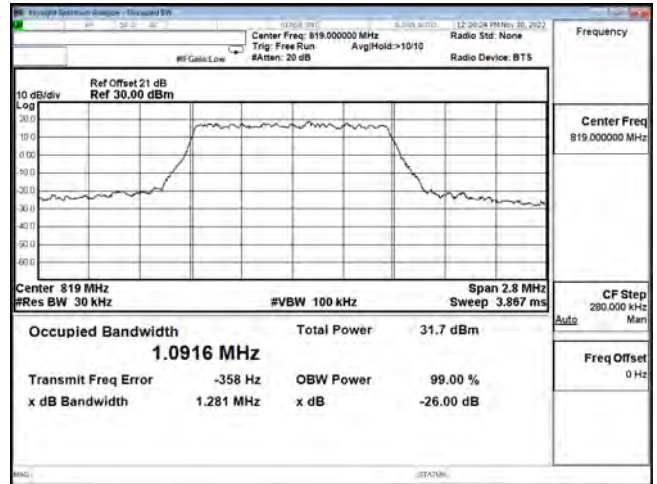

OCC B26 1.4 M CH26740 QPSK

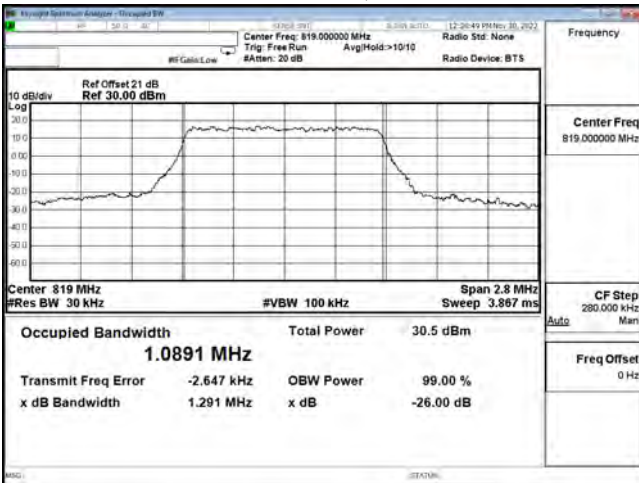

OCC B26 1.4 M CH26740 16QAM

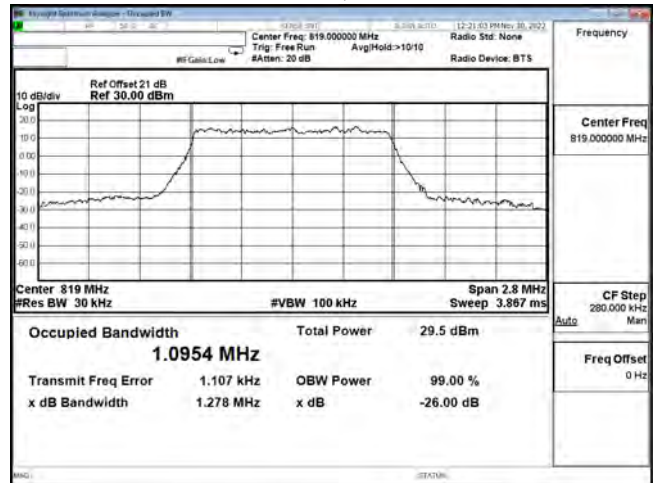

OCC B26 1.4 M CH26740 64QAM

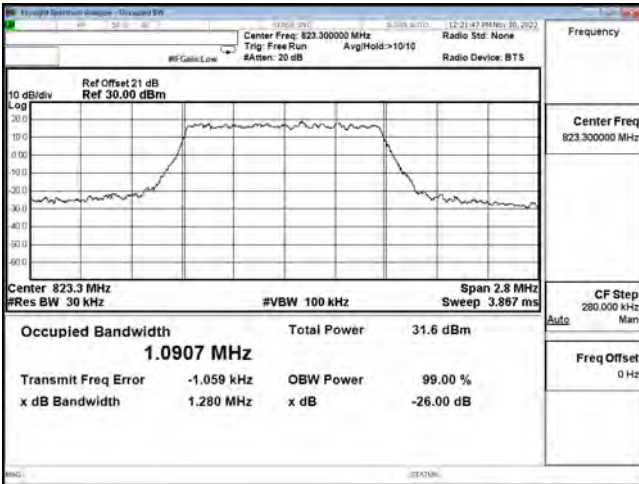

OCC B26 1.4 M CH26783 QPSK

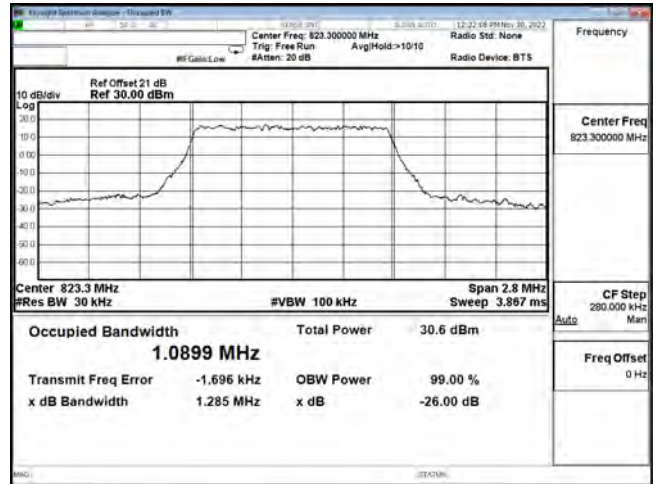

OCC B26 1.4 M CH26783 16QAM

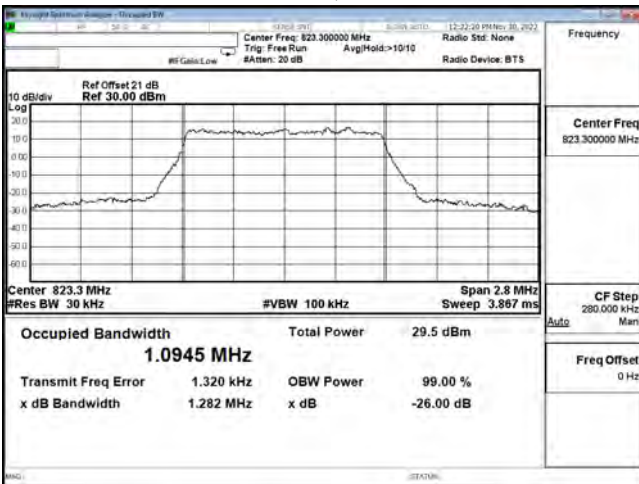

OCC B26 1.4 M CH26783 64QAM

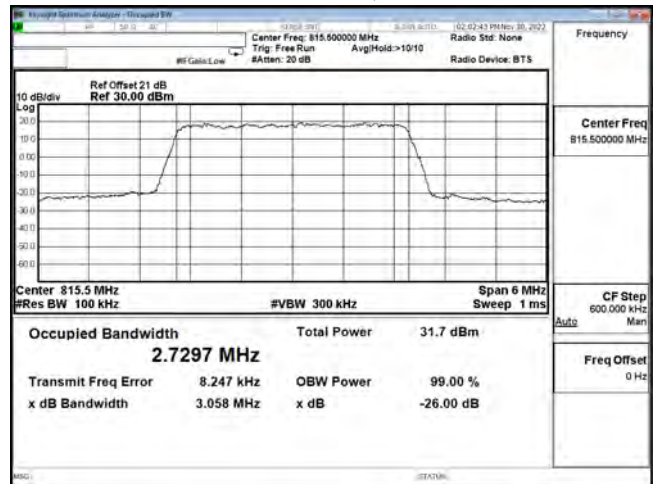

OCC B26 3 M CH26705 QPSK

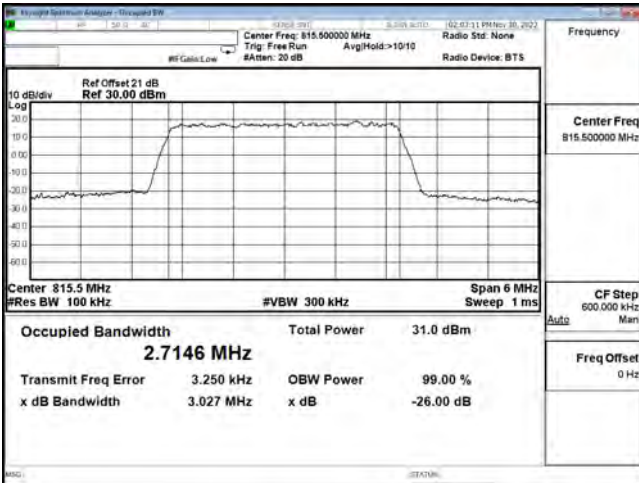

OCC B26 3 M CH26705 16QAM

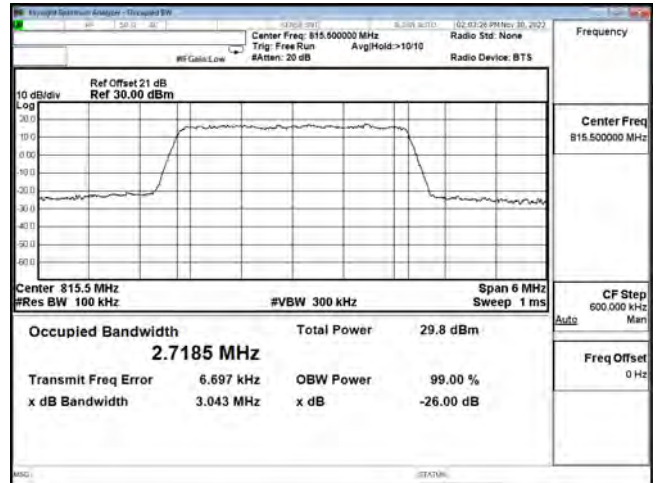

OCC B26 3 M CH26705 64QAM

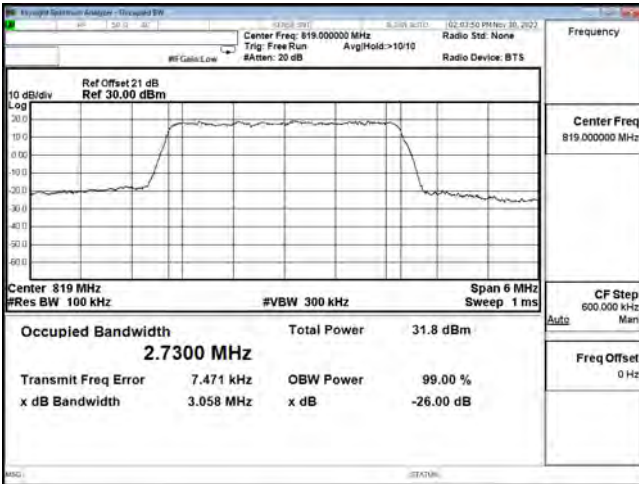

OCC B26 3 M CH26740 QPSK

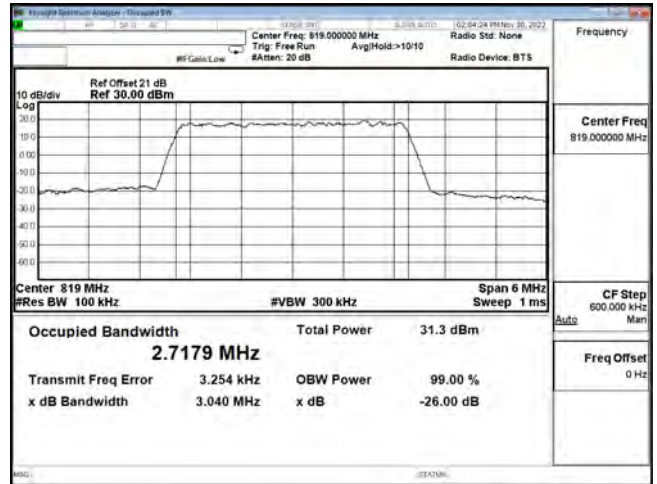

OCC B26 3 M CH26740 16QAM

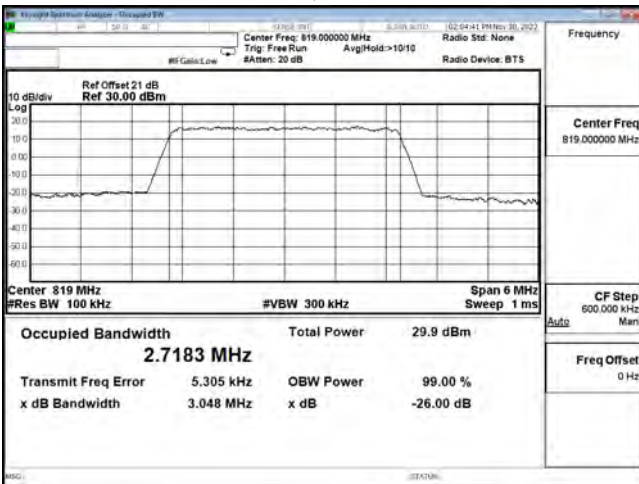

OCC B26 3 M CH26740 64QAM

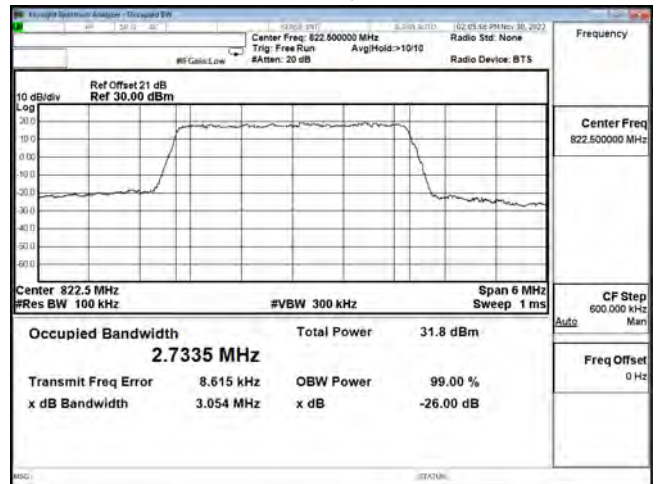

OCC B26 3 M CH26775 QPSK

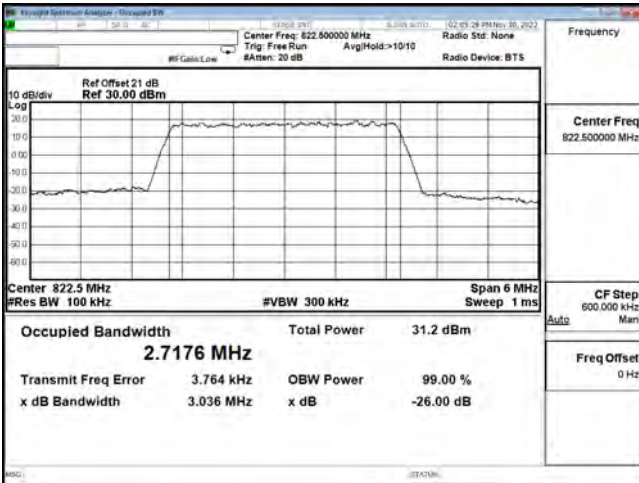

OCC B26 3 M CH26775 16QAM

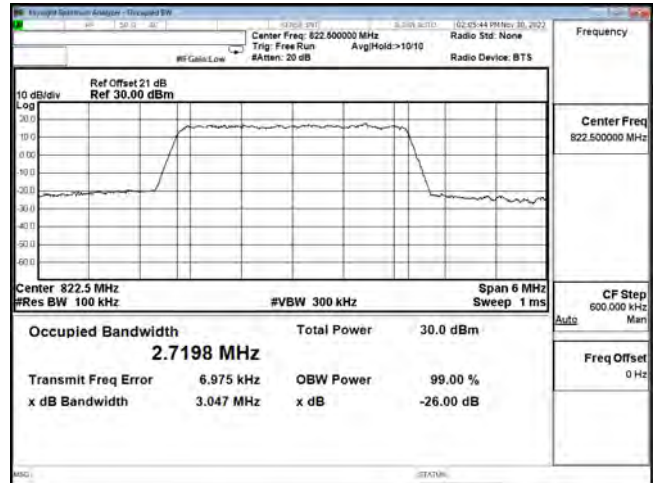

OCC B26 3 M CH26775 64QAM

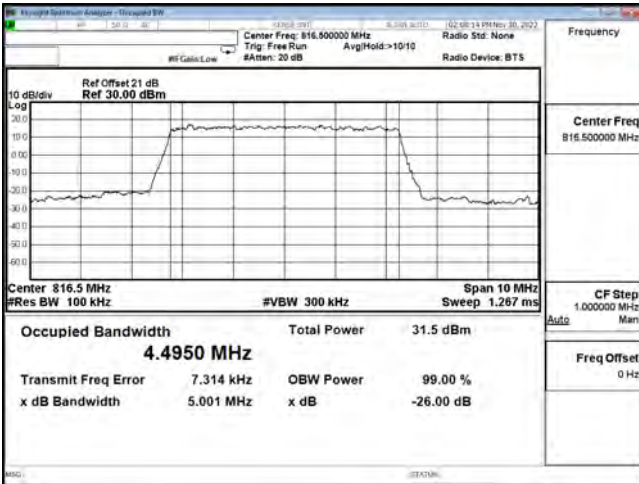

OCC B26 5 M CH26715 QPSK

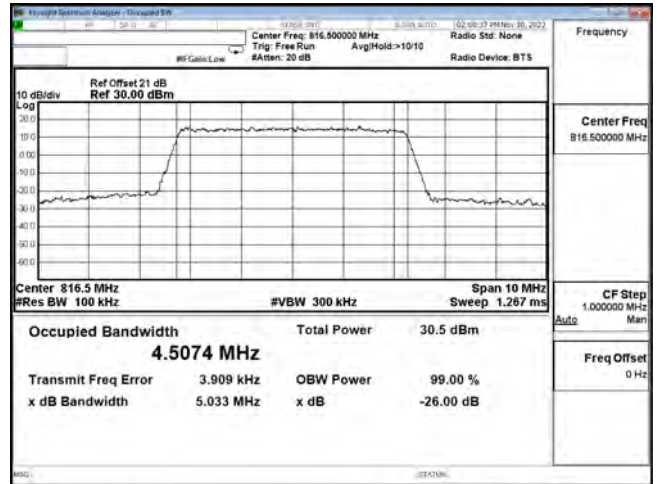

OCC B26 5 M CH26715 16QAM

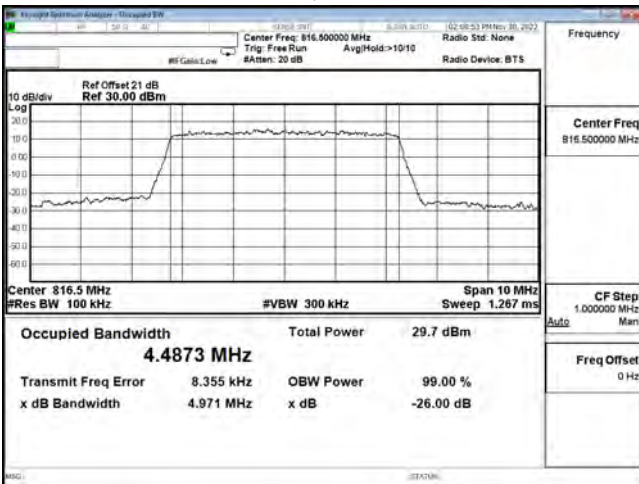

OCC B26 5 M CH26715 64QAM

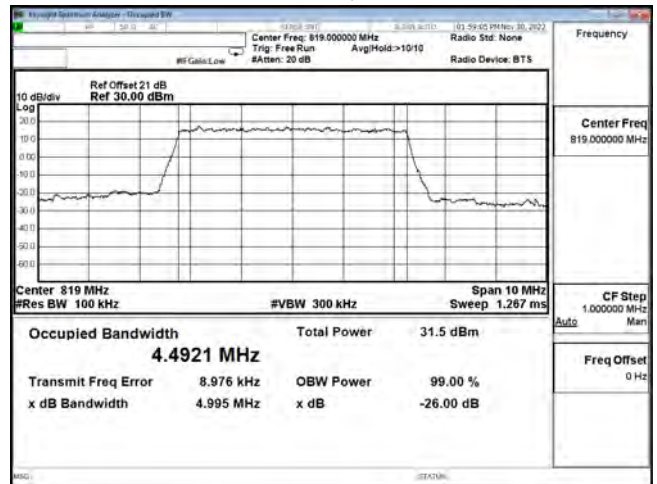

OCC B26 5 M CH26740 QPSK

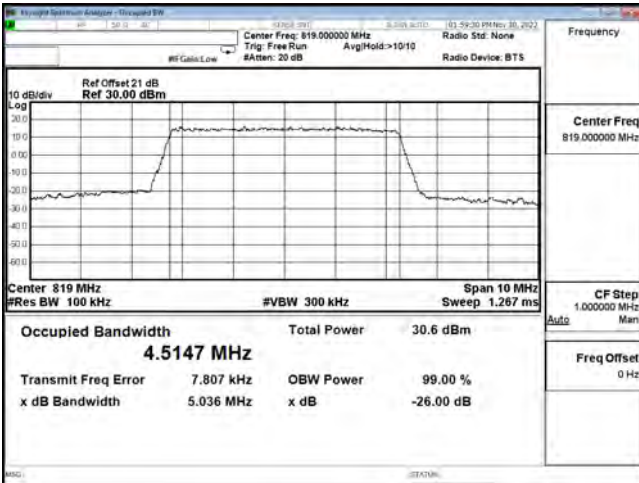

OCC B26 5 M CH26740 16QAM

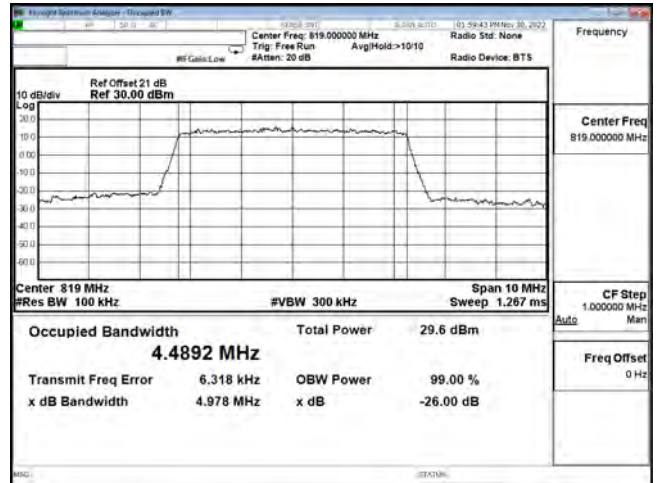

OCC B26 5 M CH26740 64QAM

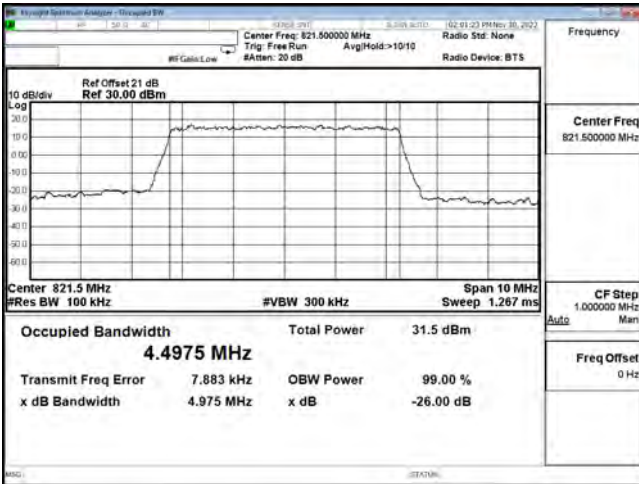

OCC B26 5 M CH26765 QPSK

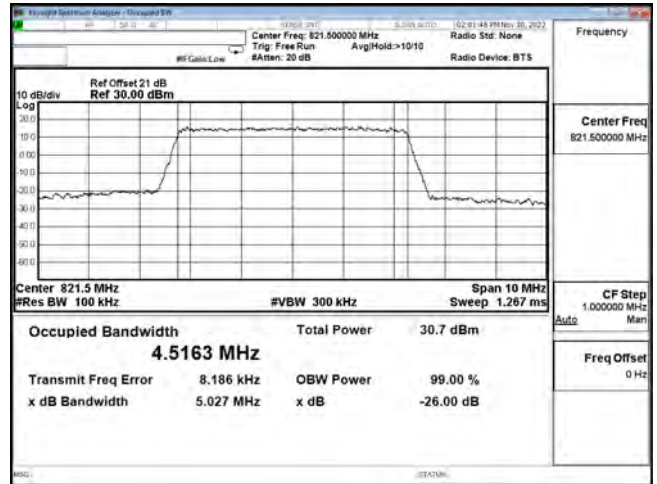

OCC B26 5 M CH26765 16QAM

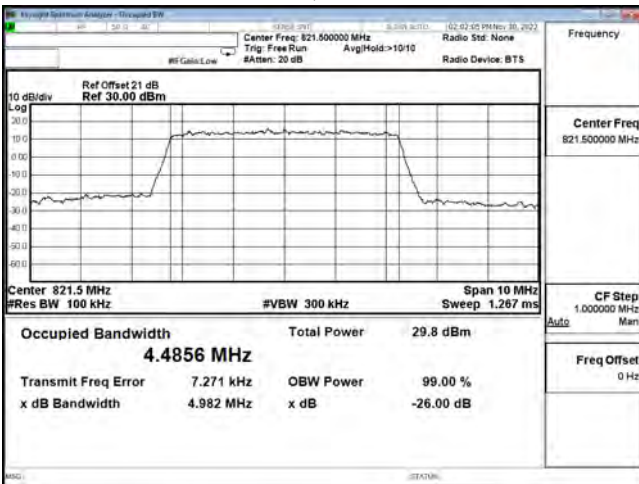

OCC B26 5 M CH26765 64QAM

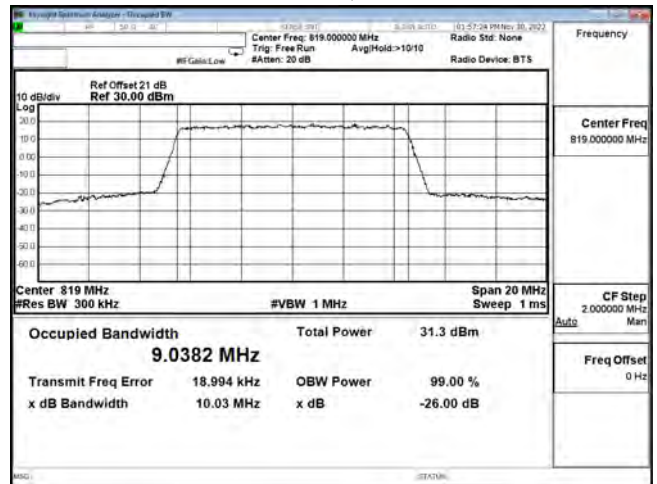

OCC B26 10 M CH26740 QPSK

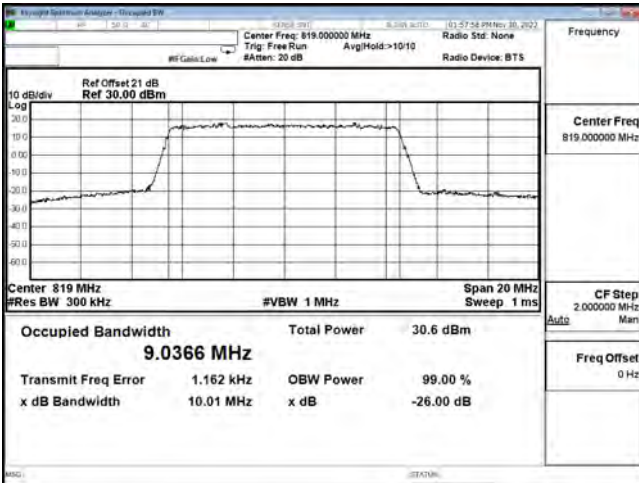

OCC B26 10 M CH26740 16QAM

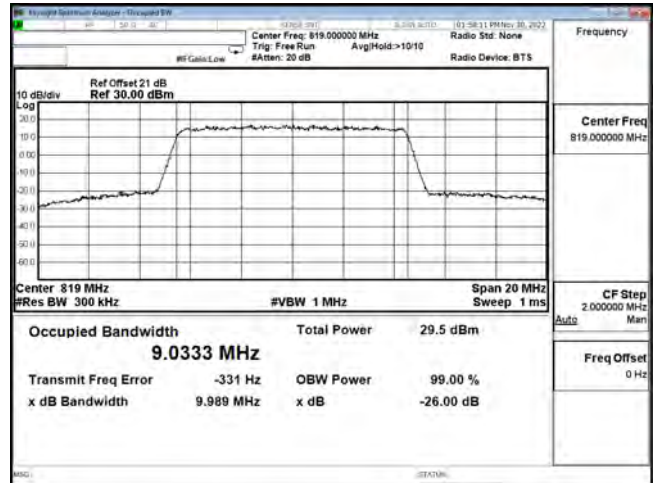

OCC B26 10 M CH26740 64QAM

5. Spurious Emission At Antenna Terminals (+/-1MHz)

5.1. Test Specification

According to Part 2.1051, 90.691

5.2. Setup

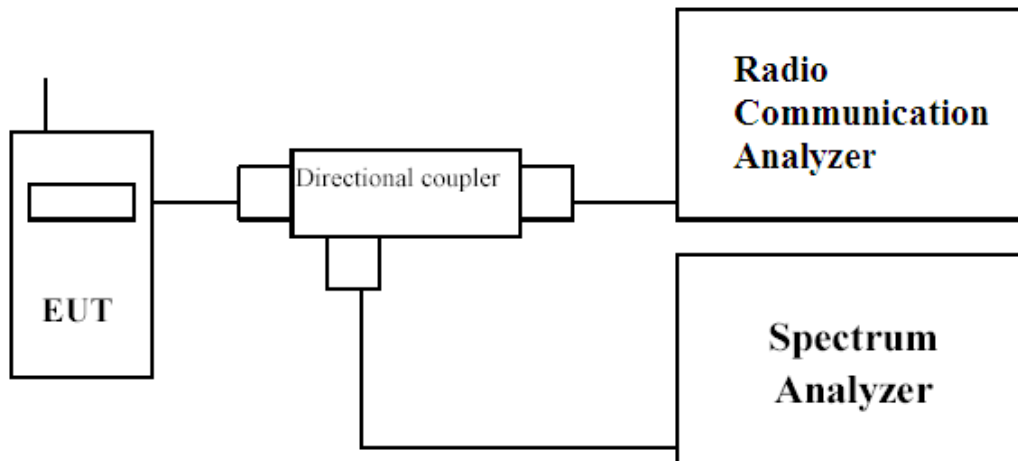

5.3. Limits

- (1) For any frequency removed from the EA licensee's frequency block by up to and including 37.5 kHz, the power of any emission shall be attenuated below the transmitter power (P) in watts by at least $116 \log_{10}(f/6.1)$ decibels or $50 + 10 \log_{10}(P)$ decibels or 80 decibels, whichever is the lesser attenuation, where f is the frequency removed from the center of the outer channel in the block in kilohertz and where f is greater than 12.5 kHz.
- (2) For any frequency removed from the EA licensee's frequency block greater than 37.5 kHz, the power of any emission shall be attenuated below the transmitter power (P) in watts by at least $43 + 10 \log_{10}(P)$ decibels or 80 decibels, whichever is the lesser attenuation, where f is the frequency removed from the center of the outer channel in the block in kilohertz and where f is greater than 37.5 kHz.

5.4. Test Procedure

In accordance with Part 90.691 at least 1 % of the emission bandwidth was used for the resolution and video bandwidths up to 1MHz away from the Block Edge. At greater than 1 MHz, the resolution and video bandwidth were increased to 1 MHz/3 MHz. The reference power and path losses of all channels used for testing in each frequency block were measured.

5.5. Test Result of Spurious Emission At Antenna Terminals (+/-1 MHz)

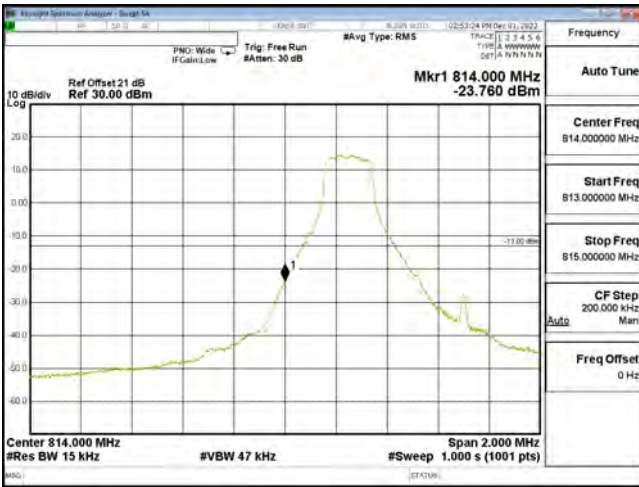

Bandedge B26 1.4 M CH26697 QPSK(1,0)

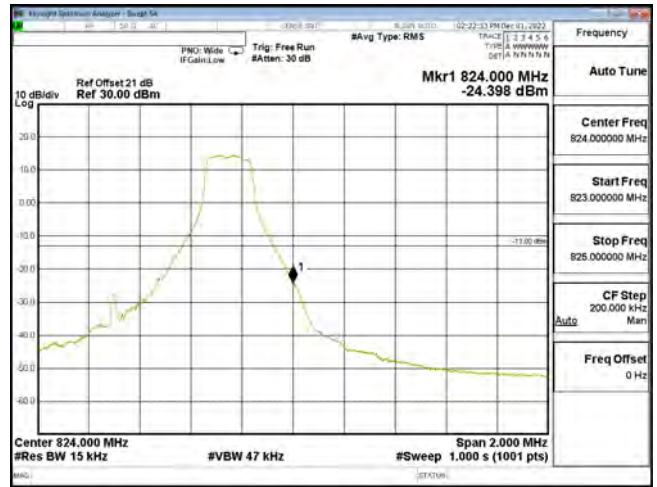

Bandedge B26 1.4 M CH26783 QPSK(1,5)



Bandedge B26 1.4 M CH26697 QPSK(6,0)

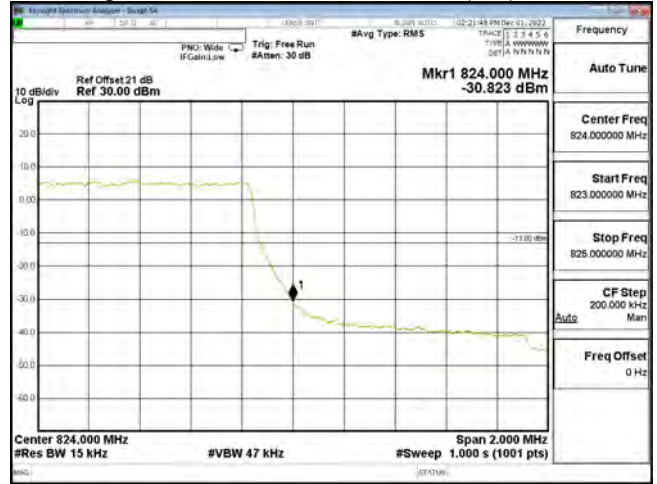

Bandedge B26 1.4 M CH26783 QPSK(6,0)

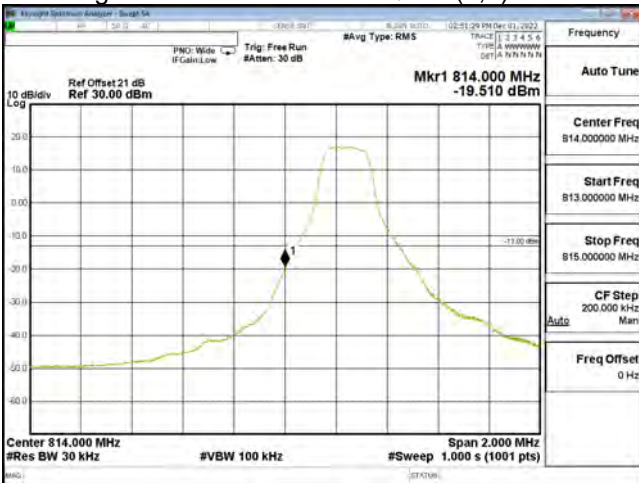

Bandedge B26 3 M CH26705 QPSK(1,0)

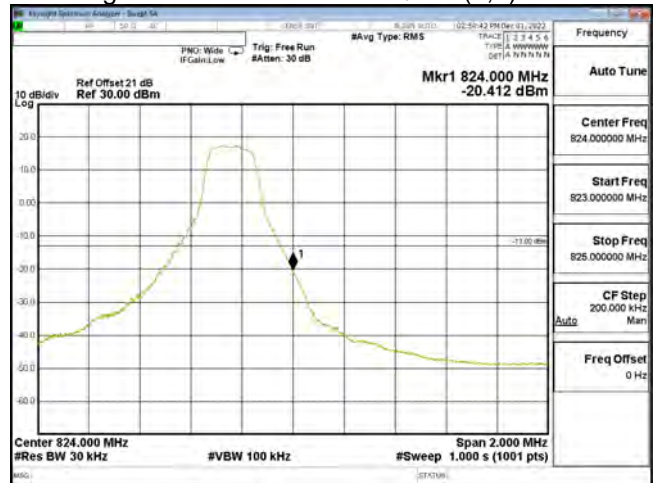

Bandedge B26 3 M CH26775 QPSK(1,14)

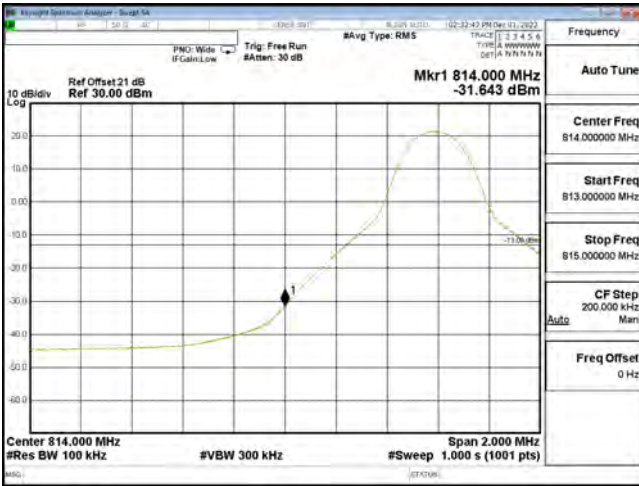

Bandedge B26 10 M CH26740 QPSK(1,0)

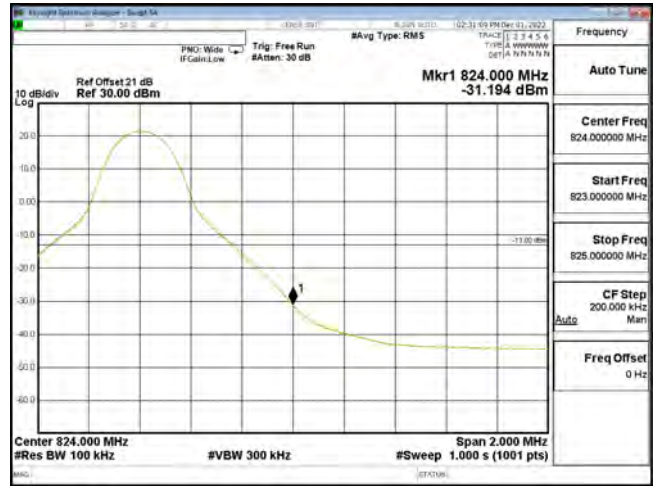

Bandedge B26 10 M CH26740 QPSK(1,49)

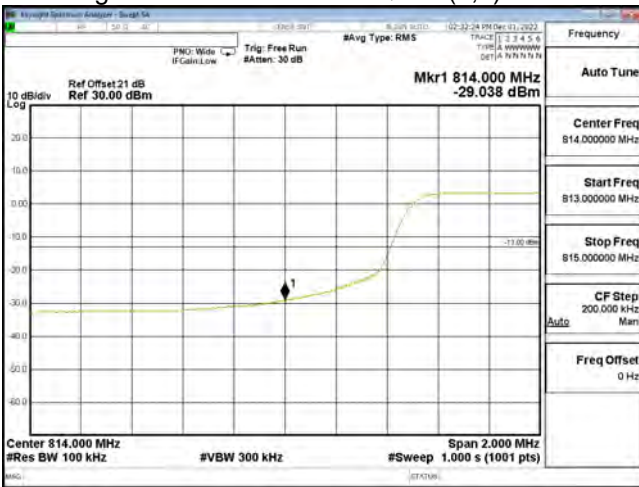

Bandedge B26 10 M CH26740 QPSK(50,0)

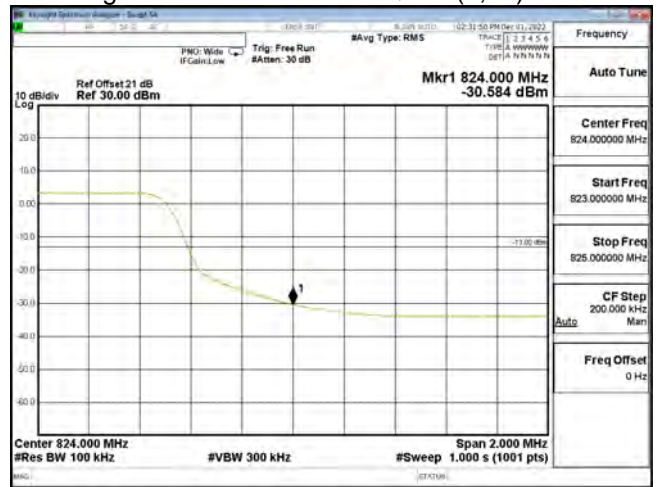

Bandedge B26 10 M CH26740 QPSK(50,0)

6. Spurious Emission

6.1. Test Specification

According to Part 2.1051, 90.691

6.2. Test Setup

Spurious emissions at antenna terminals

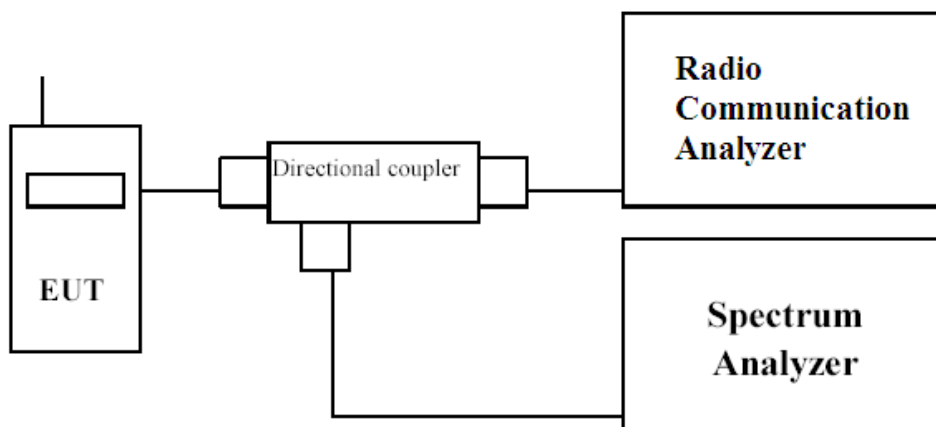

Field strength of spurious radiation

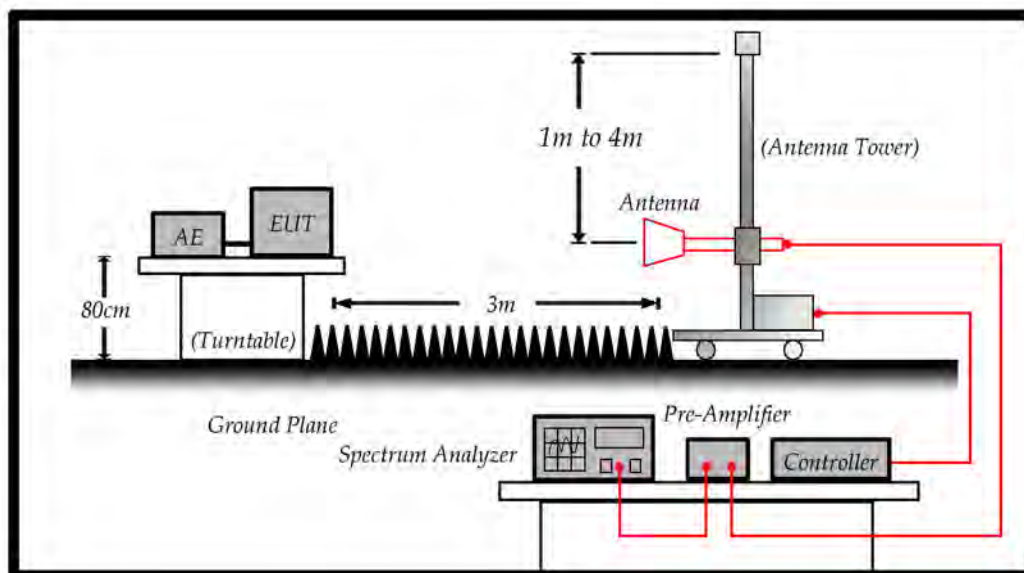

6.3. Limits

Limit	< -13 dBm
--------------	---------------------

$43 + 10\text{Log}(P)$ down on the carrier where P is the power in Watts.

6.4. Test Procedure

In accordance with Part 2.1051, 90.691, the spurious emissions from the antenna terminal were measured. The transmitter output power was attenuated using a combination of filters and attenuators and the frequency spectrum investigated from 30 MHz to 20 GHz. The EUT was set to transmit on full power. The EUT was tested on Low, middle and High channels for both power levels. The resolution and video bandwidth was set to 1 MHz/3 MHz in accordance with Part 2.1051, 90.691. The spectrum analyzer detector was set to Max Hold. In addition, measurements were made up to the 10th harmonic of the fundamental. The device was then replaced with a substitution antenna, which input signal was adjusted until the received level matched that of the previously detected emission.

The EUT is placed on a turn table which is 1.5 meter above ground. The turn table can rotate 360 degrees to determine the position of the maximum emission level. The EUT was positioned such that the distance from antenna to the EUT was 3 meters.

The antenna can move up and down between 1 meter and 4 meters to find out the maximum emission level.

Both horizontal and vertical polarization of the antenna are set on measurement. In order to find the maximum emission, all of the interface cables must be manipulated according to TIA/EIA 603-D on radiated measurement.

6.5. Test Result of Spurious Emission



CSE B26 1.4 M CH26697 QPSK(1,2) 30 M-1 G

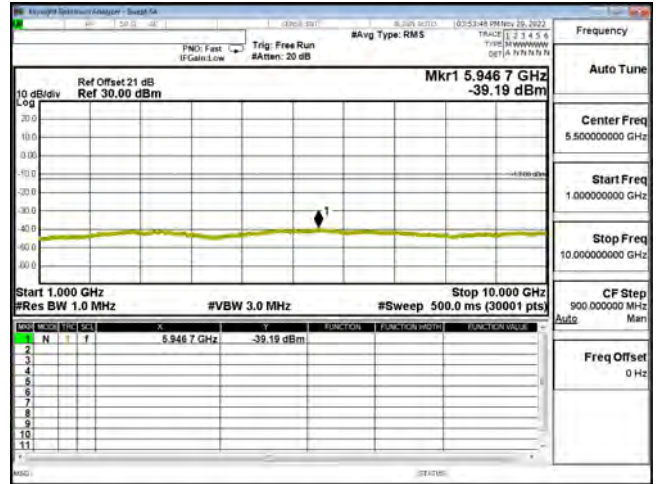

CSE B26 1.4 M CH26697 QPSK(1,2) 1 G-10 G



CSE B26 1.4 M CH26740 QPSK(1,2) 30 M-1 G



CSE B26 1.4 M CH26740 QPSK(1,2) 1 G-10 G

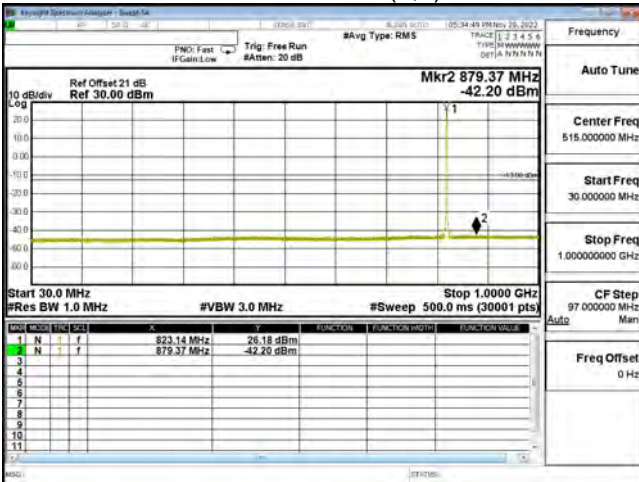

CSE B26 1.4 M CH26783 QPSK(1,2) 30 M-1 G

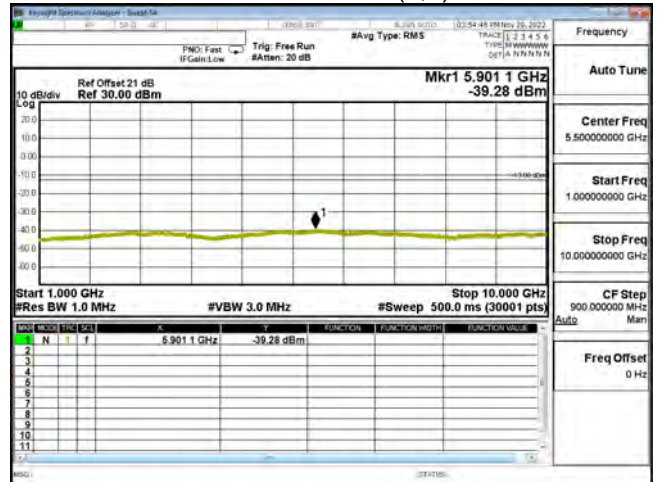

CSE B26 1.4 M CH26783 QPSK(1,2) 1 G-10 G

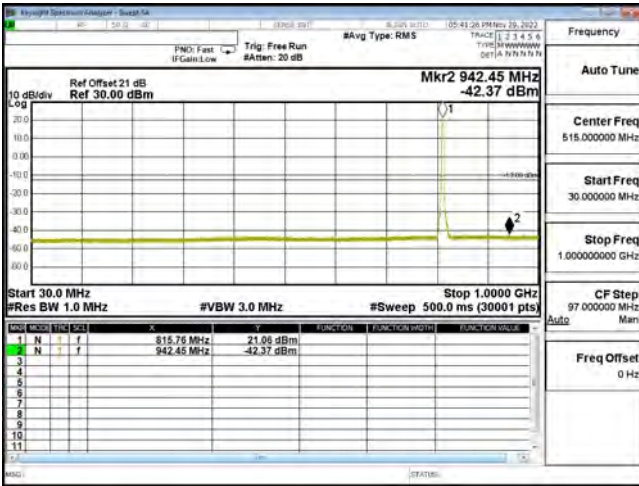

CSE B26 3 M CH26705 QPSK(1,7) 30 M-1 G

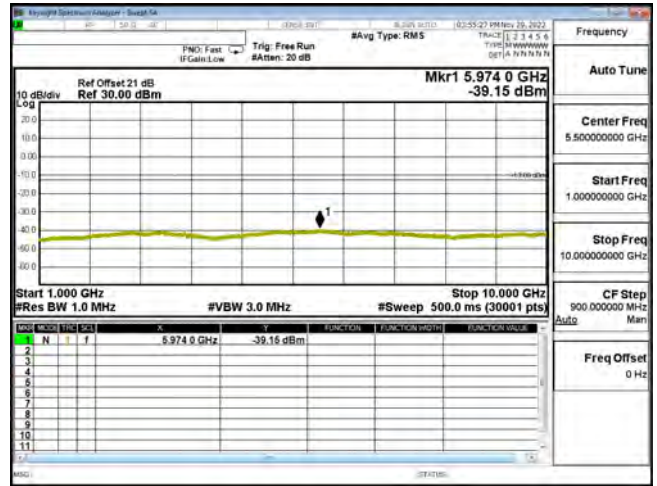

CSE B26 3 M CH26705 QPSK(1,7) 1 G-10 G

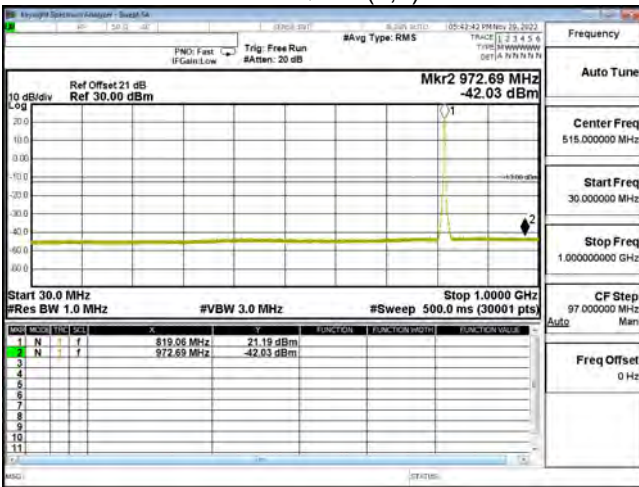

CSE B26 3 M CH26740 QPSK(1,7) 30 M-1 G

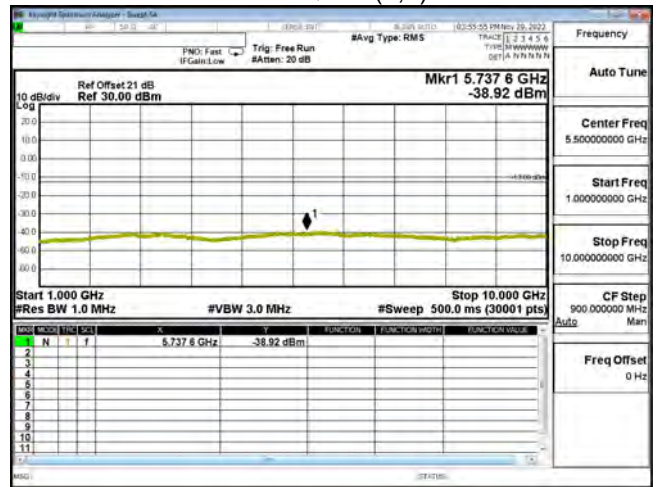

CSE B26 3 M CH26740 QPSK(1,7) 1 G-10 G

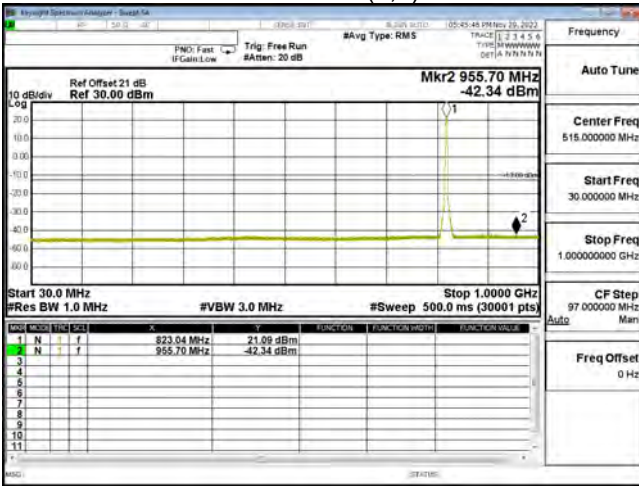

CSE B26 3 M CH26775 QPSK(1,7) 30 M-1 G

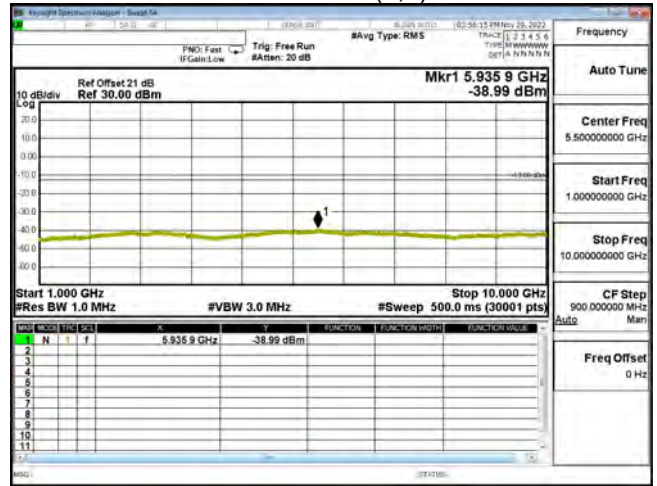

CSE B26 3 M CH26775 QPSK(1,7) 1 G-10 G

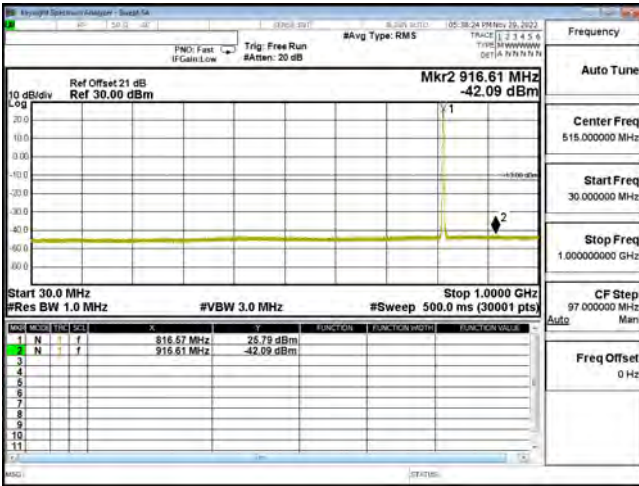

CSE B26 5 M CH26715 QPSK(1,12) 30 M-1 G

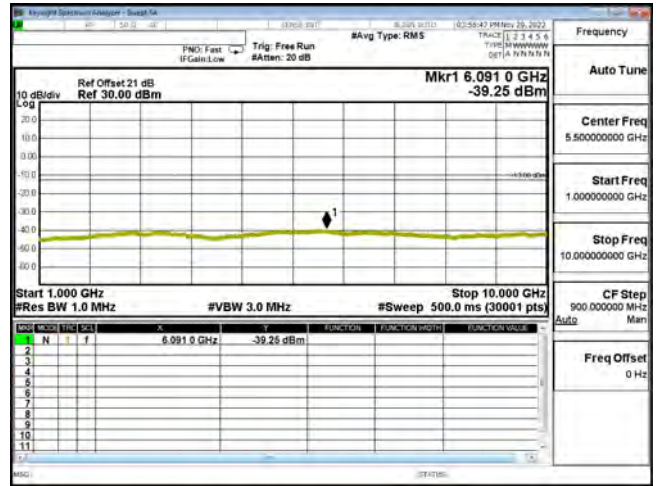

CSE B26 5 M CH26715 QPSK(1,12) 1 G-10 G

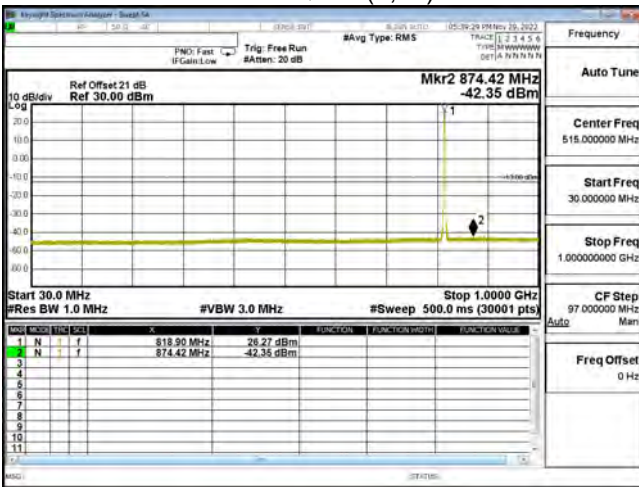

CSE B26 5 M CH26740 QPSK(1,12) 30 M-1 G

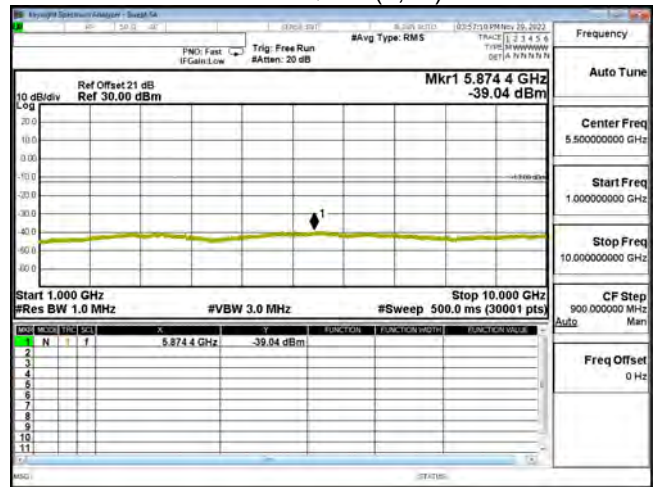

CSE B26 5 M CH26740 QPSK(1,12) 1 G-10 G



CSE B26 5 M CH26765 QPSK(1,12) 30 M-1 G

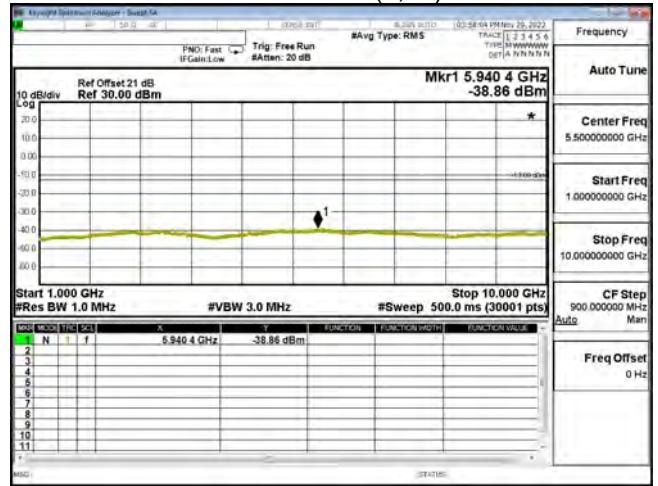

CSE B26 5 M CH26765 QPSK(1,12) 1 G-10 G

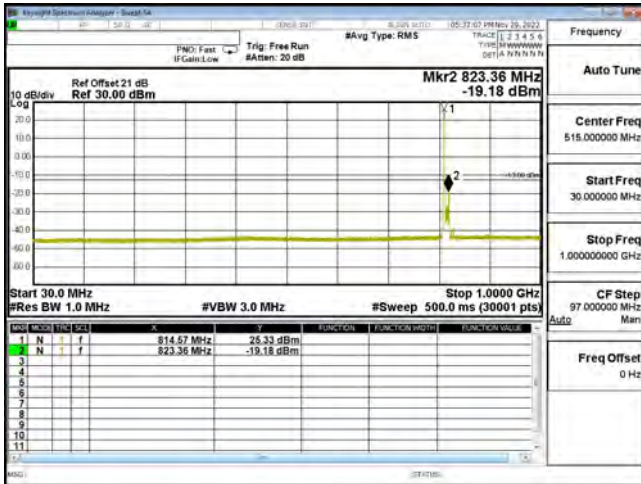

CSE B26 10 M CH26740 QPSK(1,0) 30 M-1 G

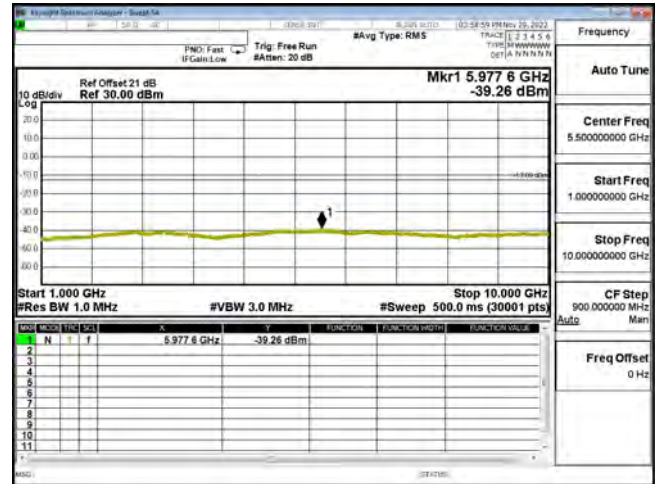

CSE B26 10 M CH2670 QPSK(1,0) 1 G-10 G

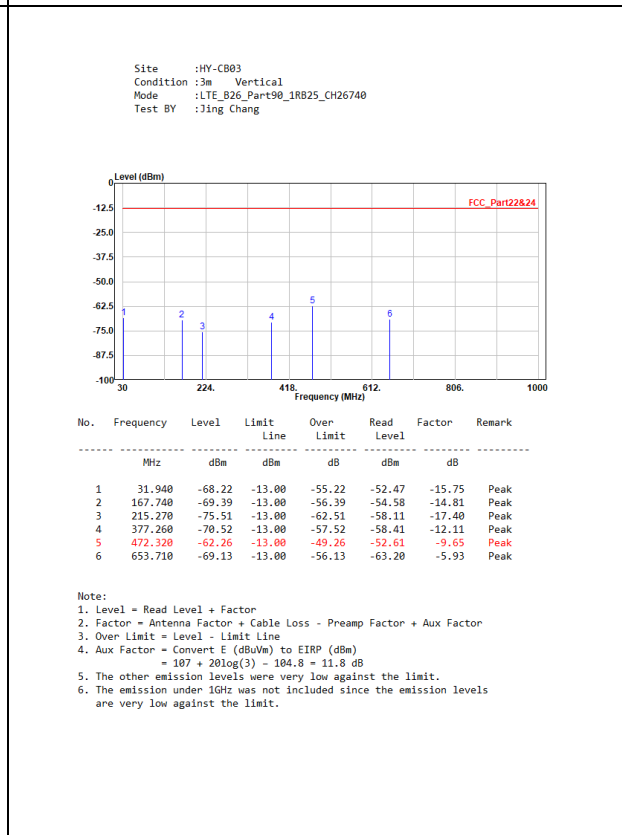
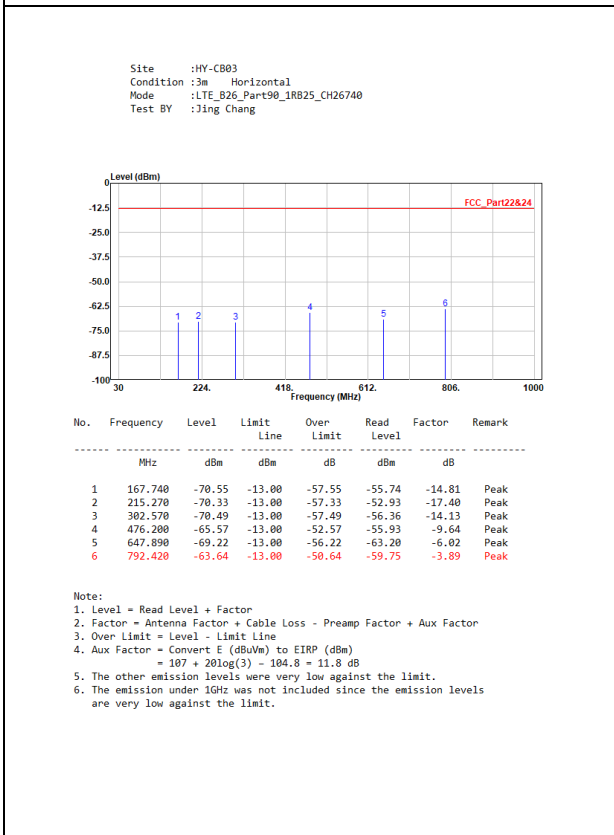
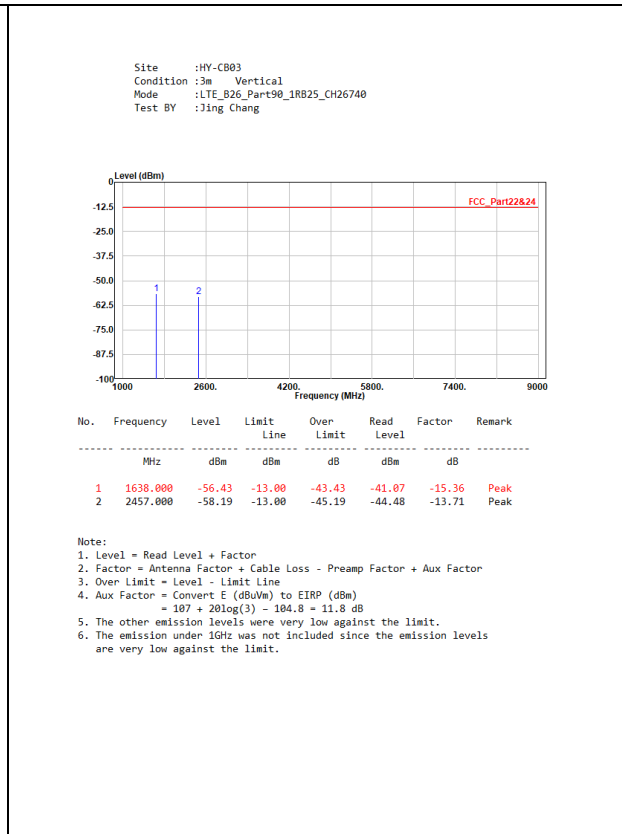
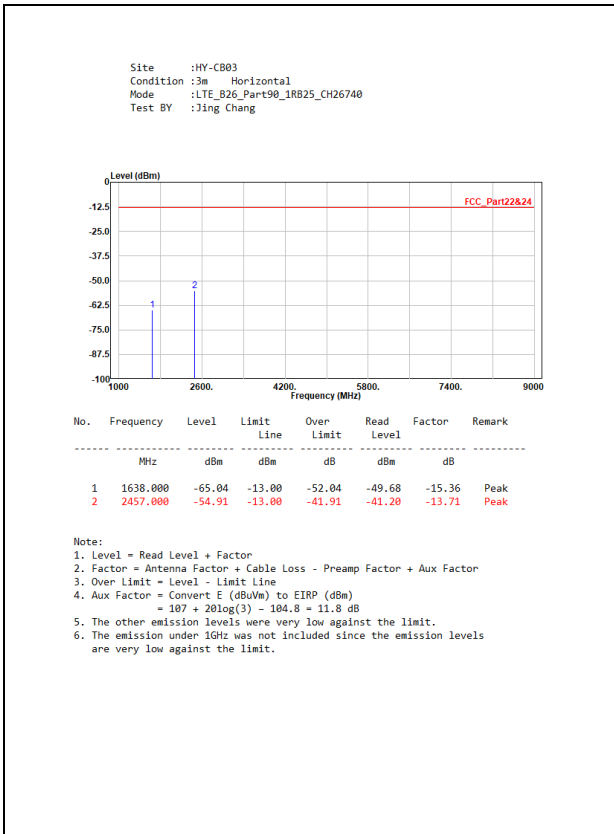

7. Frequency Stability Under Temperature & Voltage Variations

7.1. Test Specification

According to Part 2.1055, 90.213

7.2. Test Setup

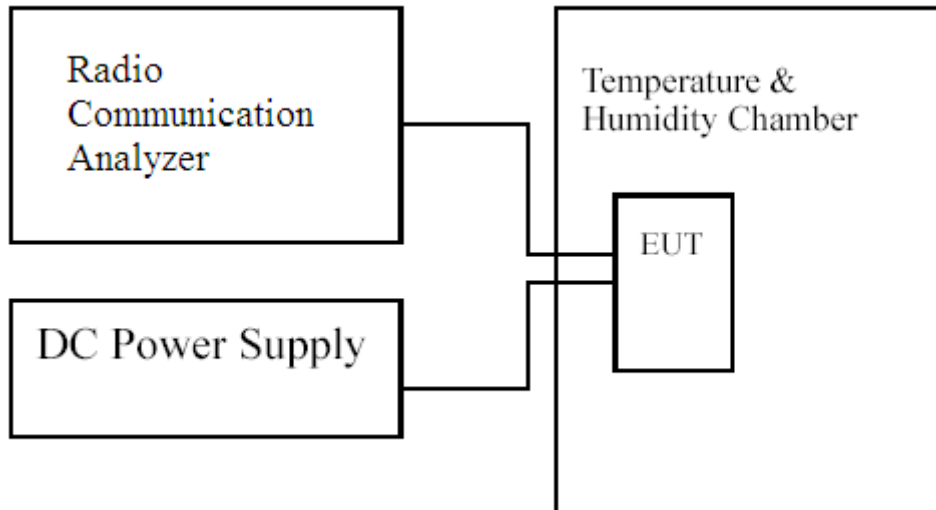

7.3. Limits

Limit	< ± 2.5 ppm
--------------	-----------------------

7.4. Test Procedure

The frequency stability of transmitter is measured by:

- Temperature: The temperature is varied from -30 °C to 50 °C in 10 °C increment using a standard temperature & Humidity chamber.
- Primary Supply Voltage: The primary supply voltage is varied 85 % to 115 % of the nominal value for non-hand-carried equipment. For hand-carried, battery-powered equipment, primary supply voltage is reduced to the battery operating endpoint which shall be specified by the manufacturer.

The EUT was connected via the base station simulator. Universal Radio Communication Tester, was used to measure The Frequency Error. The maximum result of measurements was recorded.

7.5. Test Result of Frequency Stability Under Temperature Variations

Temperature Variations

Temperature Interval(°C)	Test Channel	Deviation (kHz)				Limit (kHz)
		1.4 M	3 M	5 M	10 M	
-30	Low	-0.0056	0.0052	0.0063	--	±2.05
-20	Low	-0.0051	0.0056	0.0069	--	±2.05
-10	Low	-0.0053	0.0068	0.0055	--	±2.05
0	Low	0.0058	0.0078	0.0050	--	±2.05
10	Low	-0.0052	0.0075	0.0054	--	±2.05
20	Low	-0.0048	0.0073	0.0059	--	±2.05
30	Low	-0.0042	0.0066	0,0061	--	±2.05
40	Low	-0.0047	0.0069	0,0052	--	±2.05
50	Low	-0.0045	0.0061	0.0045	--	±2.05
-30	Mid	--	--	--	-0.0033	±2.05
-20	Mid	--	--	--	-0.0034	±2.05
-10	Mid	--	--	--	-0.0038	±2.05
0	Mid	--	--	--	-0.0035	±2.05
10	Mid	--	--	--	-0.0029	±2.05
20	Mid	--	--	--	-0.0027	±2.05
30	Mid	--	--	--	-0.0021	±2.05
40	Mid	--	--	--	-0.0027	±2.05
50	Mid	--	--	--	-0.0024	±2.05
-30	High	-0.0051	0.0059	0.0058	--	±2.05
-20	High	-0.0047	0.0071	0.0051	--	±2.05
-10	High	-0.0044	0.0091	0.0047	--	±2.05
0	High	0.0047	0.0090	0.0041	--	±2.05
10	High	0.0043	0.0078	0,0046	--	±2.05
20	High	0.0036	0.0055	0.0041	--	±2.05
30	High	0.0031	0.0054	0,0048	--	±2.05
40	High	-0.0048	0.0051	0,0050	--	±2.05
50	High	-0.0058	0.0047	0.0046	--	±2.05

Voltage Variations

Temperature Interval(°C)	Test Channel	Deviation (kHz)				Limit (kHz)
		1.4 M	3 M	5 M	10 M	
4.40	Low	-0.0055	0.0062	0.0053	--	±2.05
3.85	Low	-0.0048	0.0073	0.0059	--	±2.05
3.60	Low	-0.0043	0.0060	0.0052	--	±2.05
4.40	Mid	--	--	--	-0.0019	±2.05
3.85	Mid	--	--	--	-0.0027	±2.05
3.60	Mid	--	--	--	-0.0024	±2.05
4.40	High	0.0070	0.0054	0.0043	--	±2.05
3.85	High	0.0036	0.0055	0.0041	--	±2.05
3.60	High	-0.0048	0.0053	0.0053	--	±2.05