

Test Report

Product Name	Mobile Computer
Model No	RS36
FCC ID	Q3N-RS36

Applicant	CipherLab Co., Ltd.
Address	12F, 333, Dunhua S.Rd., Sec.2, Taipei, Taiwan

Date of Receipt	Oct. 13, 2022
Issued Date	Mar. 28, 2023
Report No.	22A0299R-RFUSWL5V01-A
Report Version	V1.0



The test results relate only to the samples tested.

The test results shown in the test report are traceable to the national/international standard through the calibration report of the equipment and evaluated measurement uncertainty herein.

This report must not be used to claim product endorsement by TAF or any agency of the government.

The test report shall not be reproduced without the written approval of DEKRA Testing and Certification Co., Ltd.

Measurement uncertainties evaluated for each testing system and associated connections are given here to provide the system information for reference. Compliance determinations do not take into account measurement uncertainties for each testing system, but are based on the results of the compliance measurement.

Test Report



Product Name	Mobile Computer
Applicant	CipherLab Co., Ltd.
Address	12F, 333, Dunhua S.Rd., Sec.2, Taipei, Taiwan
Manufacturer	CIPHERLAB CO. LTD.
Model No.	RS36
FCC ID	Q3N-RS36
EUT Rated Voltage	AC 100-240V, 50-60Hz (Power by Adapter) or DC 3.85V (Power by Battery)
EUT Test Voltage	AC 120V, 60Hz
Trade Name	CIPHERLAB
Applicable Standard	FCC CFR Title 47 Part 15 Subpart E ANSI C63.4: 2014, ANSI C63.10: 2013 KDB Publication 789033
Test Result	Complied

Documented By

:

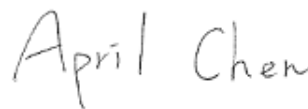

(Senior Project Specialist / April Chen)

Tested By

:

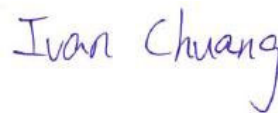

(Senior Engineer / Ivan Chuang)

Approved By

:



(Senior Engineer / Jack Hsu)

TABLE OF CONTENTS

1. General Information.....	6
1.1. EUT Description.....	6
1.2. Tested System Details.....	8
1.3. Configuration of tested System	8
1.4. EUT Exercise Software	8
1.5. Test Facility	9
1.6. List of Test Equipment.....	10
1.7. Uncertainty	11
2. Conducted Emission	12
2.1. Test Setup	12
2.2. Limits.....	12
2.3. Test Procedure	12
2.4. Test Result of Conducted Emission.....	13
3. Maximun conducted output power	14
3.1. Test Setup	14
3.2. Limits.....	15
3.3. Test Procedure	16
3.4. Test Result of Maximum conducted output power.....	17
4. Peak Power Spectral Density	29
4.1. Test Setup	29
4.2. Limits.....	29
4.3. Test Procedure	30
4.4. Test Result of Peak Power Spectral Density.....	31
5. Radiated Emission	39
5.1. Test Setup	39
5.2. Limits.....	40
5.3. Test Procedure	41
5.4. Test Result of Radiated Emission.....	42
6. Band Edge	64
6.1. Test Setup	64
6.2. Limits.....	65
6.3. Test Procedure	66
6.4. Test Result of Band Edge	67

7. Occupied Bandwidth	103
7.1. Test Setup	103
7.2. Limits.....	103
7.3. Test Procedure	103
7.4. Test Result of Occupied Bandwidth	104
8. Duty Cycle	108
8.1. Test Setup	108
8.2. Test Procedure	108
8.3. Test Result of Duty Cycle.....	109

Appendix 1: EUT Test Photographs

Appendix 2: Product Photos-Please refer to the file: 22A0299R-Product Photos

Revision History

Report No.	Version	Description	Issued Date
22A0299R-RFUSWL5V01-A	V1.0	Initial issue of report.	Mar. 28, 2023

1. General Information

1.1. EUT Description

Product Name	Mobile Computer
Trade Name	CIPHERLAB
FCC ID	Q3N-RS36
Model No.	RS36
Frequency Range	802.11a/n/ac-20 MHz: 5180-5320 MHz, 5500-5700 MHz, 5720 MHz, 5745-5825 MHz 802.11n/ac-40 MHz: 5190-5310 MHz, 5510-5670MHz, 5710 MHz, 5755-5795 MHz 802.11ac-80 MHz: 5210-5290 MHz, 5530-5690 MHz, 5775 MHz
Number of Channels	802.11a/n/ac-20 MHz: 25, 802.11n/ac-40 MHz: 12 802.11ac-80 MHz: 6
Data Rate	802.11a: 6 - 54 Mbps 802.11n: up to 150 Mbps 802.11ac: up to 433.3 Mbps
Type of Modulation	802.11a/n/ac: OFDM, BPSK, QPSK, 16QAM, 64QAM, 256QAM
Channel Control	Auto
Power Cable (Optional)	Trade Name: CIPHERLAB, M/N: RS35 SNAP ON, Non-shielded, 1.5m
Adapter #1 (Optional)	Trade Name: Sunny, M/N: SYS1561-1005 Input: AC 100-240V~, 1.0A MAX, 50-60Hz Output: +5.0V=2.0A
Adapter #2 (Optional)	Trade Name: CWT, M/N: 2AEA010BC3D Input: AC 100-240V~ 50/60Hz 0.35A Output: 5.0V=2.0A 10.0W

Antenna List

No.	Manufacturer	Part No.	Antenna Type	Peak Gain
1	auden	BRS36ANT00001	PIFA	1.1 dBi for 5150~5250 MHz 2.1 dBi for 5250~5350 MHz 1.5 dBi for 5470~5725 MHz 1.9 dBi for 5725~5850 MHz

Note: The antenna of EUT is conforming to FCC 15.203.

802.11a/n/ac-20 MHz Center Working Frequency of Each Channel:

Channel	Frequency (MHz)	Channel	Frequency (MHz)	Channel	Frequency (MHz)	Channel	Frequency (MHz)
36	5180	40	5200	44	5220	48	5240
52	5260	56	5280	60	5300	64	5320
100	5500	104	5520	108	5540	112	5560
116	5580	120	5600	124	5620	128	5640
132	5660	136	5680	140	5700	144	5720
149	5745	153	5765	157	5785	161	5805
165	5825	--	--	--	--	--	--

802.11n/ac-40 MHz Center Working Frequency of Each Channel:

Channel	Frequency (MHz)	Channel	Frequency (MHz)	Channel	Frequency (MHz)	Channel	Frequency (MHz)
38	5190	46	5230	54	5270	62	5310
102	5510	110	5550	118	5590	126	5630
134	5670	142	5710	151	5755	159	5795

802.11ac-80 MHz Center Working Frequency of Each Channel:

Channel	Frequency (MHz)	Channel	Frequency (MHz)	Channel	Frequency (MHz)	Channel	Frequency (MHz)
42	5210	58	5290	106	5530	122	5610
138	5690	155	5775	--	--	--	--

Note:

1. This device is an Mobile Computer with built-in WLAN and Bluetooth transceiver, this report for 5GHz WLAN.
2. Regarding to the operation frequency, the lowest, middle and highest frequency are selected to perform the test.
3. Lowest and highest data rates are tested in each mode. Only worst case is shown in the report.
4. These tests were conducted on a sample of the equipment for the purpose of demonstrating compliance of transmitter with Part 15 Subpart E for Unlicensed National Information Infrastructure devices.

Test Mode	Mode 1	Transmit (802.11a) Transmit (802.11ac-20MHz) Transmit (802.11ac-40MHz) Transmit (802.11ac-80MHz)
-----------	--------	---

1.2. Tested System Details

The types for all equipment, plus descriptions of all cables used in the tested system (including inserted cards) are:

Product	Manufacturer	Model No.	Serial No.	Power Cord
1 Adapter	Sunny	SYS1561-1005	N/A	N/A
2 Notebook PC	ASUS	P2438U	H1NXCV11U083025	N/A

Cable Type	Cable Description
A Power Cable	Non-shielded, 1.5m
B Type C Cable	Shielded, 1m

1.3. Configuration of tested System

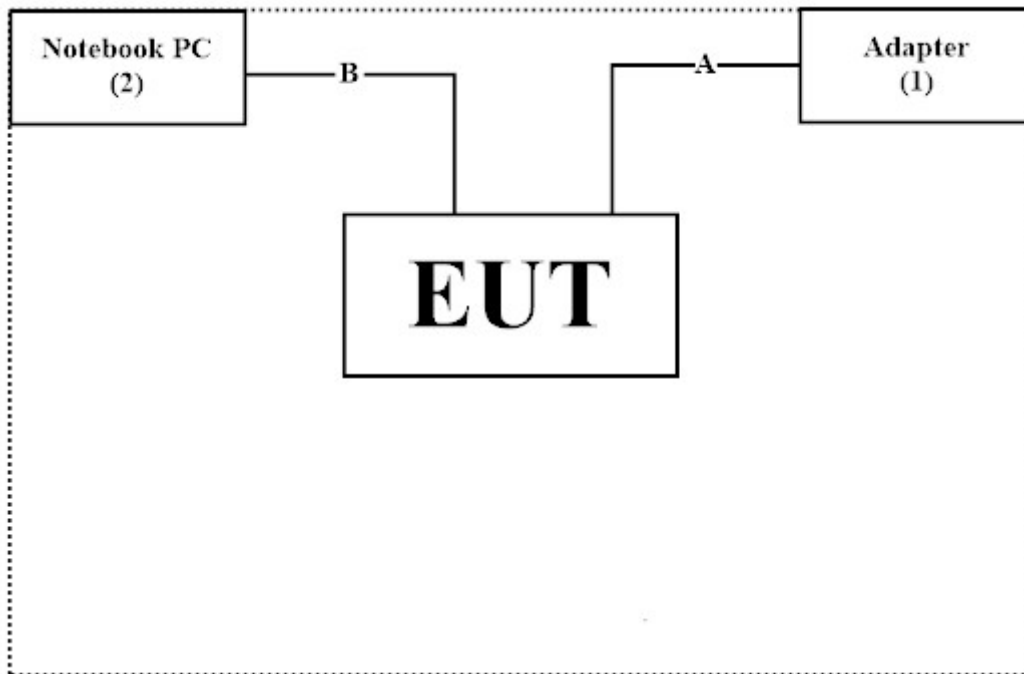

1.4. EUT Exercise Software

1. Setup the EUT as shown in Section 1.4.
2. Execute software ‘QRCT Ver.3.0.271.0’ on the Notebook PC.
3. Configure the test mode, the test channel, and the data rate.
4. Press “OK” to start the continuous Transmit.
5. Verify that the EUT works properly.

1.5. Test Facility

Ambient conditions in the laboratory:

Performed Item	Items	Required	Actual
Conducted Emission	Temperature (°C)	10~40 °C	23.4 °C
	Humidity (%RH)	10~90 %	55.2 %
Radiated Emission	Temperature (°C)	10~40 °C	23.5 °C
	Humidity (%RH)	10~90 %	65.3 %
Conductive	Temperature (°C)	10~40 °C	25.1 °C
	Humidity (%RH)	10~90 %	60.0 %

USA : FCC Registration Number: TW0033
 Canada : CAB Identifier Number: TW3023 / Company Number: 26930

Site Description : Accredited by TAF
 Accredited Number: 3023

Test Laboratory : DEKRA Testing and Certification Co., Ltd
 Address : No. 5-22, Ruishukeng Linkou District, New Taipei City, 24451, Taiwan
 Performed Location : No. 26, Huaya 1st Rd., Guishan Dist., Taoyuan City 333411, Taiwan, R.O.C.
 Phone Number : +886-3-275-7255
 Fax Number : +886-3-327-8031
 Email Address : info.tw@dekra.com
 Website : <http://www.dekra.com.tw>

1.6. List of Test Equipment

For Conduction Measurements /HY-SR01

	Equipment	Manufacturer	Model No.	Serial No.	Cal. Date	Due Date
V	EMI Test Receiver	R&S	ESR7	101601	2022/06/23	2023/06/22
V	Two-Line V-Network	R&S	ENV216	101306	2022/05/23	2023/05/22
V	Two-Line V-Network	R&S	ENV216	101307	2022/07/04	2023/07/03
V	Coaxial Cable	SUHNER	RG400 BNC	RF001	2022/05/24	2023/05/23

Note:

1. All equipments are calibrated every one year.
2. The test instruments marked with “V” are used to measure the final test results.
3. Test Software Version : E3 210616 dekra V9.

For Conducted Measurements /HY-SR02

	Equipment	Manufacturer	Model No.	Serial No.	Cal. Date	Due Date
V	Spectrum Analyzer	R&S	FSV30	103466	2021/12/27	2022/12/26
V	Peak Power Analyzer	KEYSIGHT	8990B	MY51000539	2022/05/27	2023/05/26
V	Power Sensor	KEYSIGHT	N1923A	MY59240002	2022/05/19	2023/05/18
V	Power Sensor	KEYSIGHT	N1923A	MY59240003	2022/05/19	2023/05/18

Note:

1. All equipments are calibrated every one year.
2. The test instruments marked with “V” are used to measure the final test results.
3. Test Software Version : RF Conducted Test Tools R3 V3.0.1.14.

For Radiated Measurements /HY-CB03

	Equipment	Manufacturer	Model No.	Serial No.	Cal. Date	Due Date
	Loop Antenna	AMETEK	HLA6121	56736	2022/05/14	2023/05/13
V	Bi-Log Antenna	SCHWARZBECK	VULB9168	9168-675	2021/08/11	2023/08/10
V	Horn Antenna	RF SPIN	DRH18-E	210508A18ES	2022/06/08	2023/06/07
V	Horn Antenna	Com-Power	AH-840	101100	2021/10/04	2023/10/03
V	Pre-Amplifier	SGH	SGH0301-9	20211007-10	2022/02/22	2023/02/21
V	Pre-Amplifier	SGH	PRAMP118	20200701	2022/07/28	2023/07/27
V	Pre-Amplifier	EMCI	EMC05820SE	980310	2022/07/28	2023/07/27
V	Pre-Amplifier	EMCI	EMC184045SE	980369	2022/05/12	2023/05/11
	Coaxial Cable	EMCI	EMC102-KM-KM-600	1160314		
	Coaxial Cable	EMCI	EMC102-KM-KM-7000	170242		
	Filter	MICRO TRONICS	BRM50702	G251	2022/07/27	2023/07/26
V	Filter	MICRO TRONICS	BRM50716	G188	2022/07/27	2023/07/26
V	EMI Test Receiver	R&S	ESR3	102793	2021/12/15	2022/12/14
V	Spectrum Analyzer	R&S	FSV3044	101113	2022/01/25	2023/02/24
V	Coaxial Cable	SGH	SGH18	2021005-1	2022/03/18	2023/03/17
	Coaxial Cable	SGH	SGH18	202108-4		
	Coaxial Cable	SGH	SGH18	GD20110223-1		
	Coaxial Cable	SGH	HA800	GD20110222-3		

Note:

1. Bi-Log Antenna and Horn Antenna(AH-840) is calibrated every two years, the other equipments are calibrated every one year.
2. The test instruments marked with “V” are used to measure the final test results.
3. Test Software Version : E3 210616 dekra V9.

1.7. Uncertainty

Uncertainties have been calculated according to the DEKRA internal document.

The reported expanded uncertainties are based on a standard uncertainty multiplied by a coverage factor of $k=2$, providing a level of confidence of approximately 95%.

Measurement uncertainties evaluated for each testing system and associated connections are given here to provide the system information for reference. Compliance determinations do not take into account measurement uncertainties for each testing system, but are based on the results of the compliance measurement.

Test item	Uncertainty	
Conducted Emission	±3.42 dB	
Maximun conducted output power	Power Meter ±0.89 dB	Spectrum Analyzer ±2.06 dB
Peak Power Spectral Density	±2.06 dB	
Radiated Emission	Under 1 GHz ±4.05 dB	Above 1 GHz ±3.73 dB
Band Edge	Under 1 GHz ±4.05 dB	Above 1 GHz ±3.73 dB
Occupied Bandwidth	±1544.74 Hz	
Duty Cycle	±2.31msec	

2. Conducted Emission

2.1. Test Setup

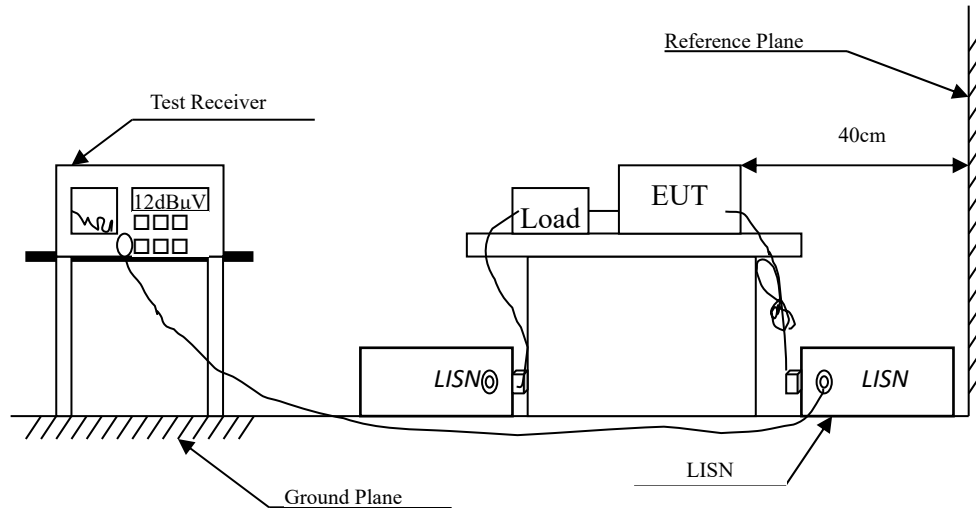

2.2. Limits

FCC Part 15 Subpart C Paragraph 15.207 (dB μ V) Limit		
Frequency MHz	Limits	
	QP	AV
0.15 - 0.50	66-56	56-46
0.50-5.0	56	46
5.0 - 30	60	50

Remarks : In the above table, the tighter limit applies at the band edges.

2.3. Test Procedure

The EUT and simulators are connected to the main power through a line impedance stabilization network (L.I.S.N.). This provides a 50 ohm /50uH coupling impedance for the measuring equipment. The peripheral devices are also connected to the main power through a LISN that provides a 50ohm /50uH coupling impedance with 50ohm termination. (Please refers to the block diagram of the test setup and photographs.)

Both sides of A.C. line are checked for maximum conducted interference. In order to find the maximum emission, the relative positions of equipment and all of the interface cables must be changed according to ANSI C63.4:2014 on conducted measurement.

Conducted emissions were investigated over the frequency range from 0.15 MHz to 30 MHz using a receiver bandwidth of 9 kHz.

2.4. Test Result of Conducted Emission

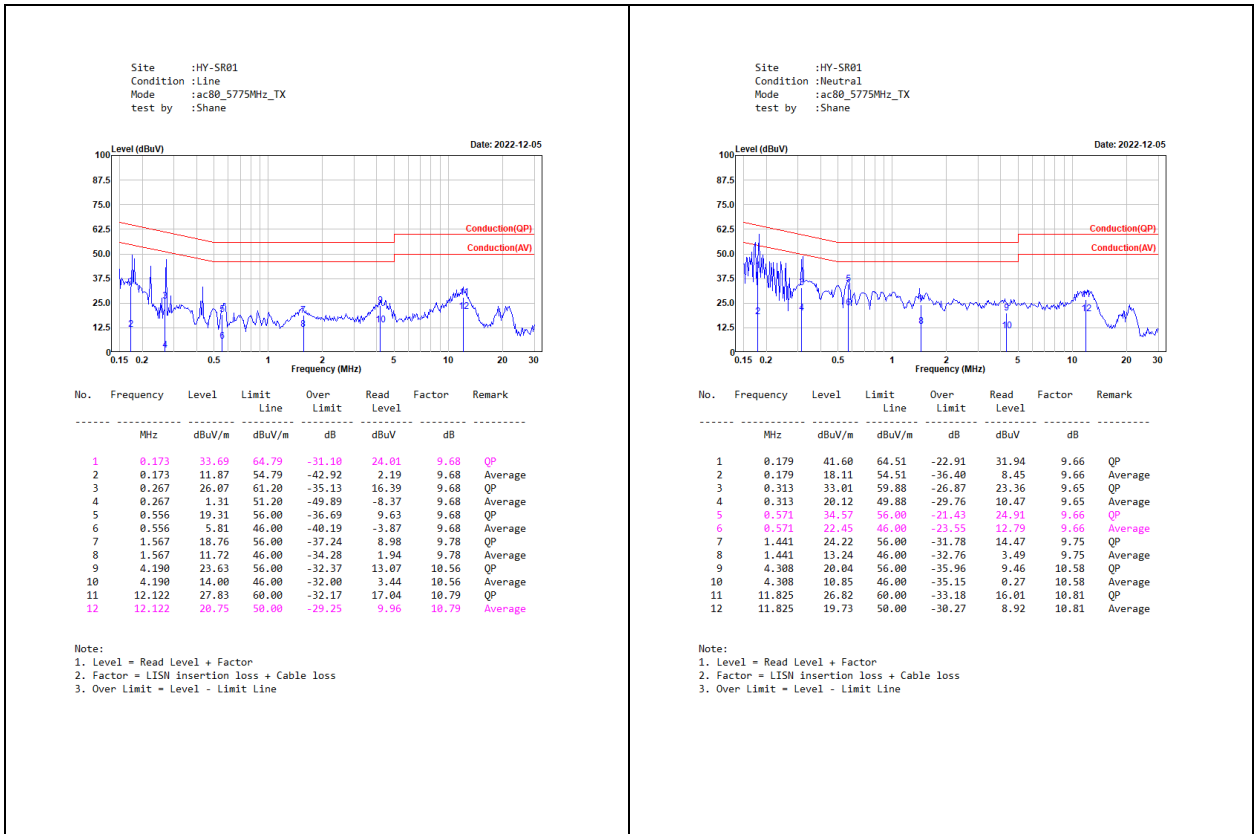

3. Maximun conducted output power

3.1. Test Setup

99% Occupied Bandwidth

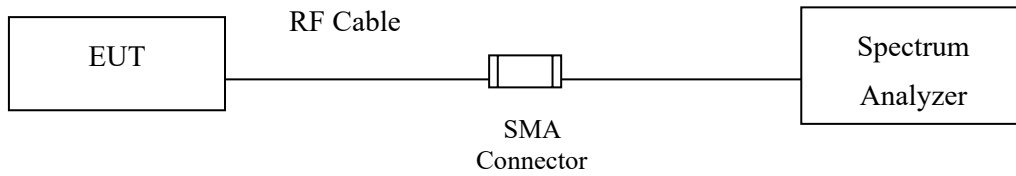

Conduction Power Measurement

Conduction Power Measurement (for 802.11 an)

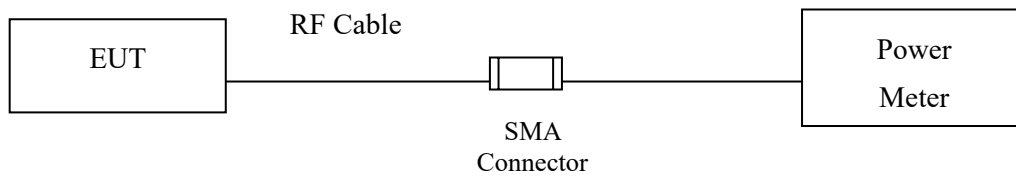

Conduction Power Measurement (for 802.11 ac)

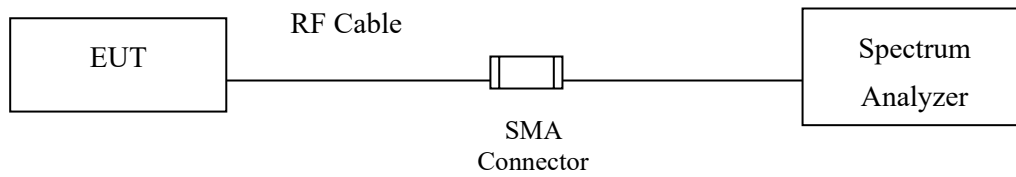

3.2. Limits

For the band 5.15-5.25 GHz,

- (i)** For an outdoor access point operating in the band 5.15-5.25 GHz, the maximum conducted output power over the frequency band of operation shall not exceed 1 W. provided the maximum antenna gain does not exceed 6 dBi. If transmitting antennas of directional gain greater than 6 dBi are used, the maximum conducted output power shall be reduced by the amount in dB that the directional gain of the antenna exceeds 6 dBi. The maximum e.i.r.p. at any elevation angle above 30 degrees as measured from the horizon must not exceed 125 mW (21 dBm).
- (ii)** For an indoor access point operating in the band 5.15-5.25 GHz, the maximum conducted output power over the frequency band of operation shall not exceed 1 W provided the maximum antenna gain does not exceed 6 dBi. In addition. If transmitting antennas of directional gain greater than 6 dBi are used, the maximum conducted output power shall be reduced by the amount in dB that the directional gain of the antenna exceeds 6 dBi.
- (iii)** For fixed point-to-point access points operating in the band 5.15-5.25 GHz, the maximum conducted output power over the frequency band of operation shall not exceed 1 W. Fixed point-to-point U-NII devices may employ antennas with directional gain up to 23 dBi without any corresponding reduction in the maximum conducted output power. For fixed point-to-point transmitters that employ a directional antenna gain greater than 23 dBi, a 1 dB reduction in maximum conducted output power is required for each 1 dB of antenna gain in excess of 23 dBi. Fixed, point-to-point operations exclude the use of point-to-multipoint systems, omnidirectional applications, and multiple collocated transmitters transmitting the same information. The operator of the U-NII device, or if the equipment is professionally installed, the installer, is responsible for ensuring that systems employing high gain directional antennas are used exclusively for fixed, point-to-point operations.
- (iv)** For mobile and portable client devices in the 5.15-5.25 GHz band, the maximum conducted output power over the frequency band of operation shall not exceed 250 mW provided the maximum antenna gain does not exceed 6 dBi. In addition. If transmitting antennas of directional gain greater than 6 dBi are used, the maximum conducted output power shall be reduced by the amount in dB that the directional gain of the antenna exceeds 6 dBi.

For the 5.25-5.35 GHz and 5.47-5.725 GHz bands, the maximum conducted output power over the frequency bands of operation shall not exceed the lesser of 250 mW or $11 \text{ dBm} + 10 \log B$, where B is the 99% emission bandwidth in megahertz. If transmitting antennas of directional gain greater than 6 dBi are used, the maximum conducted output power shall be reduced by the amount in dB that the directional gain of the antenna exceeds 6 dBi.

For the band 5.725-5.85 GHz, the maximum conducted output power over the frequency band of operation shall not exceed 1 W. In addition, if transmitting antennas of directional gain greater than 6 dBi are used, the maximum conducted output power shall be reduced by the amount in dB that the directional gain of the antenna exceeds 6 dBi. However, fixed point-to-point UNII devices operating in this band may employ transmitting antennas with directional gain greater than 6 dBi without any corresponding reduction in transmitter conducted power. Fixed, point-to-point operations exclude the use of point-to-multipoint systems, omnidirectional applications, and multiple collocated transmitters transmitting the same information. The operator of the U-NII device, or if the equipment is professionally installed, the installer, is responsible for ensuring that systems employing high gain directional antennas are used exclusively for fixed, point-to-point operations.

3.3. Test Procedure

As an alternative to FCC KDB-789033, the EUT maximum conducted output power was measured with an average power meter employing a video bandwidth greater than the 6dB BW of the emission under test. Maximum conducted output power was read directly from the meter across all data rates, and across three channels within each sub-band. Special care was used to make sure that the EUT was transmitting in continuous mode. This method exceeds the limitations of FCC KDB-789033, and provides more accurate measurements.

802.11an (BW \leq 40MHz) Maximum conducted output power using KDB 789033 section E)3)b) Method PM-G (Measurement using a gated RF average power meter)

Note: the power meter have a video bandwidth that is greater than or equal to the measurement bandwidth, (Anritsu/ MA2411B video bandwidth: 65MHz)

802.11ac (BW=80MHz) Maximum conducted output power using KDB 789033 section E)2)b) Method SA-1 (trace averaging with the EUT transmitting at full power throughout each sweep).

When transmitted signals consist of two or more non-contiguous spectrum segments (e.g., 80+80 MHz mode) or when a single spectrum segment of a transmission crosses the boundary between two adjacent U-NII bands, KDB 644545 D03 section D) procedure is used for measurements.

3.4. Test Result of Maximum conducted output power

Product : Mobile Computer
 Test Item : Maximum conducted output power
 Test Mode : Transmit (802.11a)
 Test Date : 2022/11/23

Channel No.	Frequency (MHz)	26dB Bandwidth (MHz)	Output Power (dBm)	Duty factor (dB)	Output Power Limit	
					(dBm)	dBm+10log(BW)
36	5180	--	14.36	--	24	--
44	5220	--	14.44	--	24	--
48	5240	--	14.39	--	24	--
52	5260	34.65	14.47	--	24	26.40
60	5300	29.53	14.46	--	24	25.70
64	5320	32.37	14.44	--	24	26.10
100	5500	25.05	14.31	--	24	24.99
116	5580	26.25	14.40	--	24	25.19
140	5700	24.18	14.35	--	24	24.83
144(U-NII-2C)	5720	17.95	13.61	0.10	24	23.54
144(U-NII-3)	5720	--	7.26	0.10	30	--
149	5745	--	14.37	--	30	--
157	5785	--	14.38	--	30	--
165	5825	--	14.37	--	30	--

26dB Occupied Bandwidth:

Channel 144(U-NII-2C)

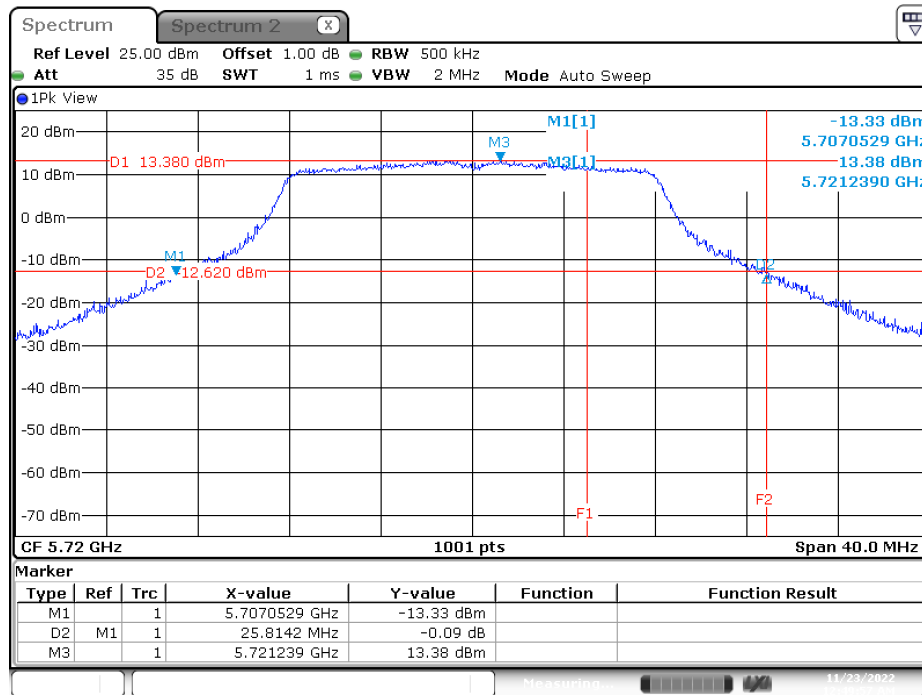

Date: 23.NOV.2022 00:49:57

**Maximum conducted output power:
Channel 144 (U-NII-2C)**

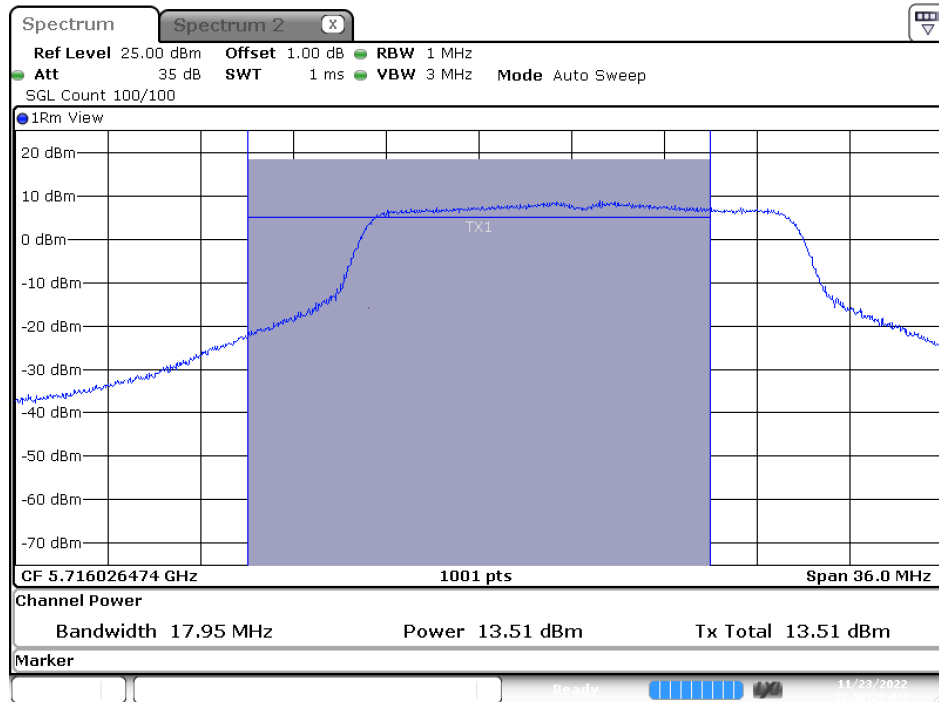

Date: 23.NOV.2022 00:50:29

Channel 144 (U-NII-3)

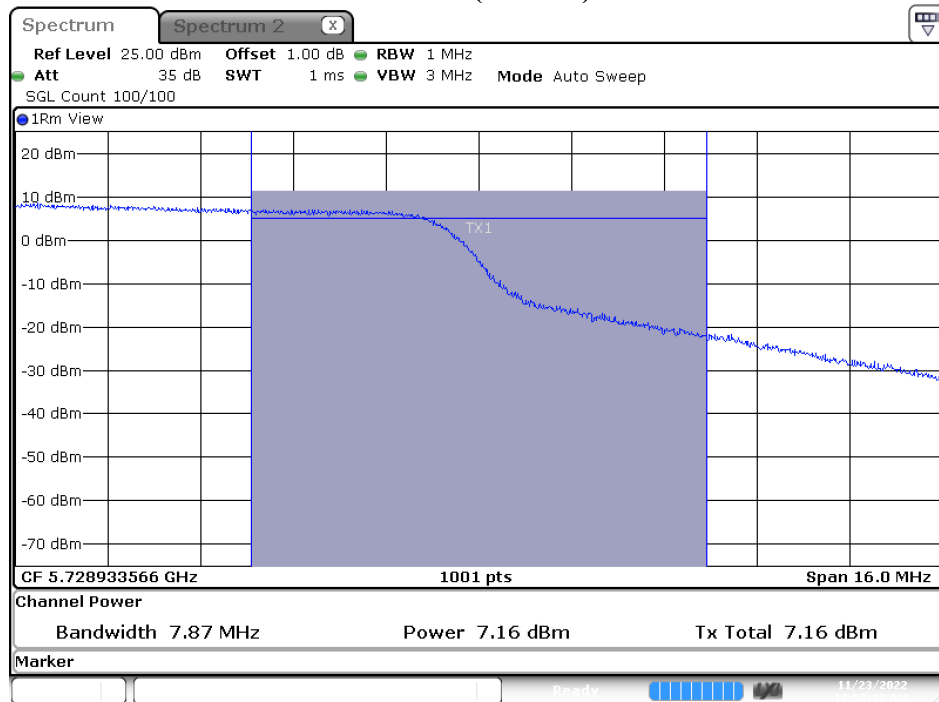

Date: 23.NOV.2022 00:50:31

Product : Mobile Computer
 Test Item : Maximum conducted output power
 Test Mode : Transmit (802.11ac-20MHz)
 Test Date : 2022/11/23

Channel No.	Frequency (MHz)	26dB Bandwidth (MHz)	Output Power (dBm)	Duty factor (dB)	Output Power Limit	
					(dBm)	dBm+10log(BW)
36	5180	--	14.38	--	24	--
44	5220	--	14.46	--	24	--
48	5240	--	14.43	--	24	--
52	5260	35.32	14.47	--	24	26.48
60	5300	28.81	14.43	--	24	25.60
64	5320	26.49	14.38	--	24	25.23
100	5500	26.05	14.35	--	24	25.16
116	5580	27.05	14.41	--	24	25.32
140	5700	25.25	14.32	--	24	25.02
144(U-NII-2C)	5720	18.07	13.53	0.10	24	23.57
144(U-NII-3)	5720	--	7.24	0.10	30	--
149	5745	--	14.36	--	30	--
157	5785	--	14.34	--	30	--
165	5825	--	14.30	--	30	--

26dB Occupied Bandwidth:

Channel 144(U-NII-2C)

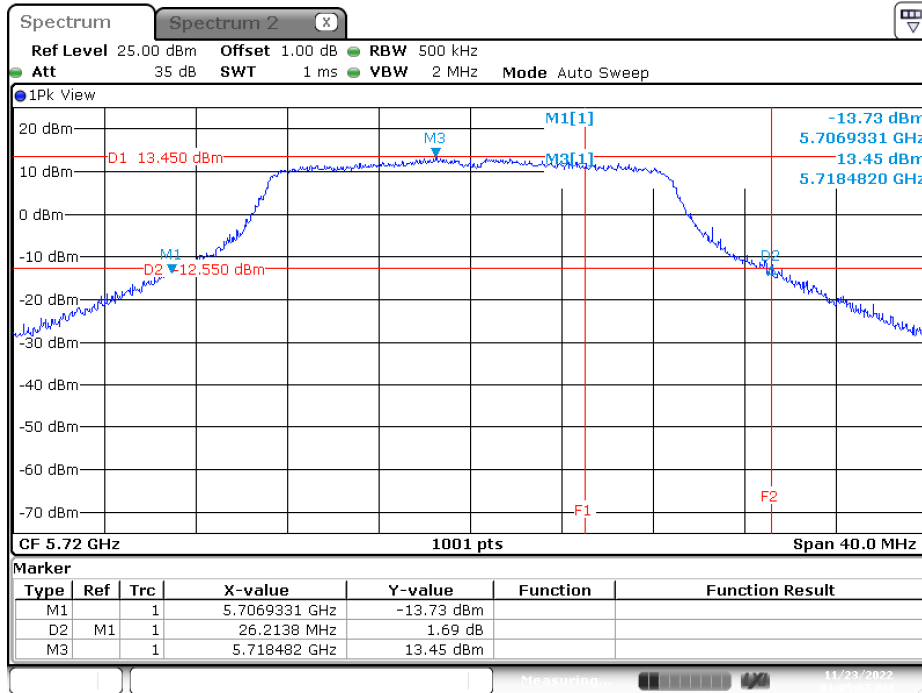

Date: 23.NOV.2022 01:05:07

Maximum conducted output power:

Channel 144 (U-NII-2C)

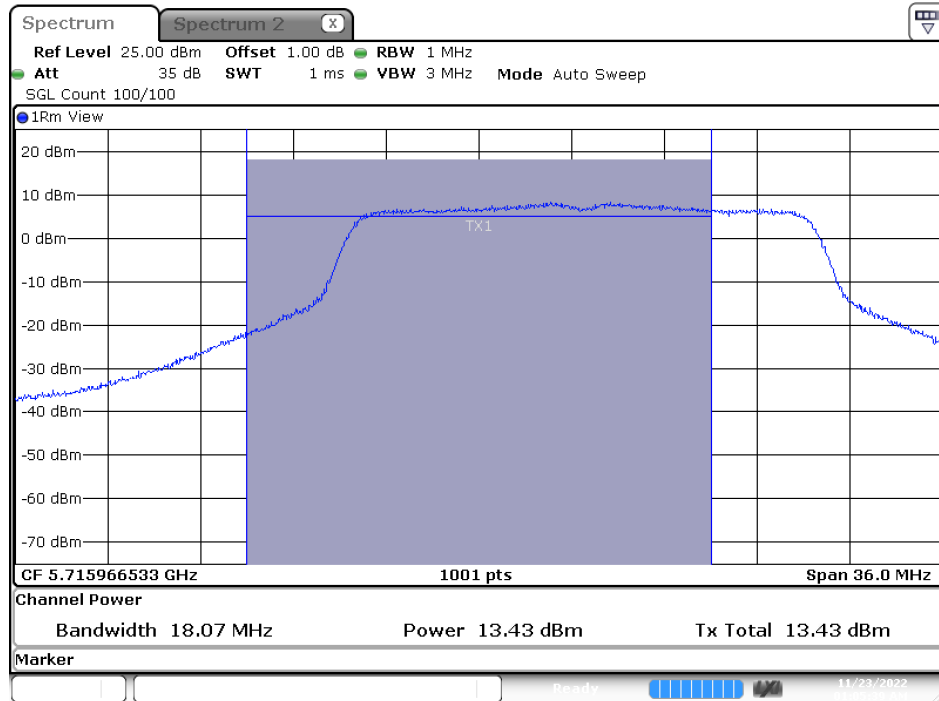

Date: 23.NOV.2022 01:05:39

Channel 144 (U-NII-3)

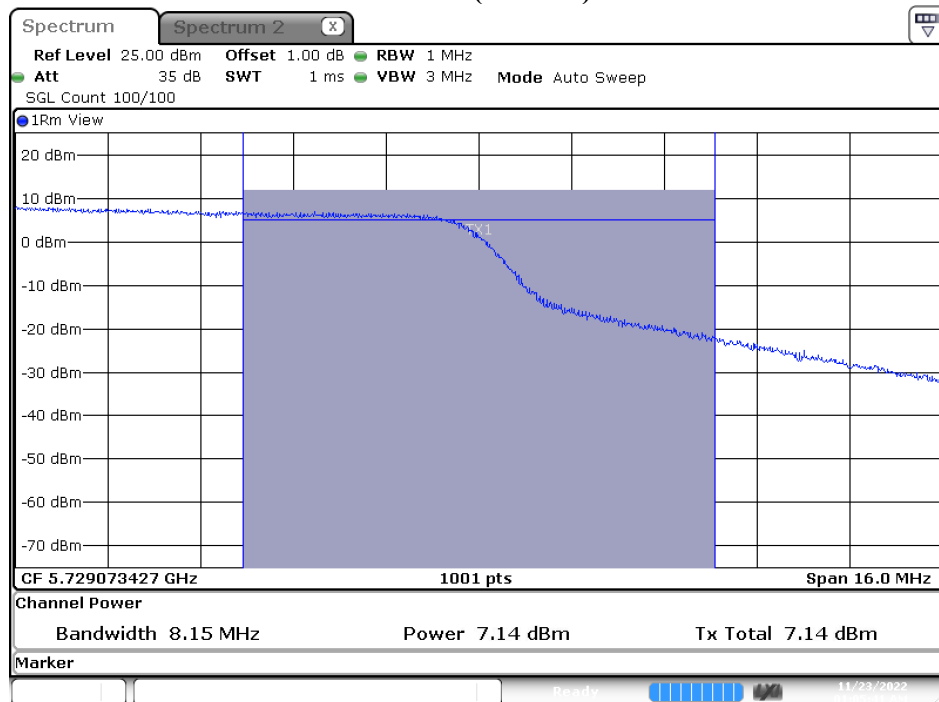

Date: 23.NOV.2022 01:05:42

Product : Mobile Computer
 Test Item : Maximum conducted output power
 Test Mode : Transmit (802.11ac-40MHz)
 Test Date : 2022/11/23

Channel No.	Frequency (MHz)	26dB Bandwidth (MHz)	Output Power (dBm)	Duty factor (dB)	Output Power Limit	
					(dBm)	dBm+10log(BW)
38	5190	--	14.23	--	24	--
46	5230	--	14.19	--	24	--
54	5270	72.65	14.16	--	24	29.61
62	5310	41.48	14.32	--	24	27.18
102	5510	41.96	14.22	--	24	27.23
110	5550	46.43	14.38	--	24	27.67
134	5670	41.64	14.42	--	24	27.19
142(U-NII-2C)	5710	36.34	14.22	0.21	24	26.60
142(U-NII-3)	5710	--	3.55	0.21	30	--
151	5755	--	14.41	--	30	--
159	5795	--	14.25	--	30	--

26dB Occupied Bandwidth:

Channel 142(U-NII-2C)

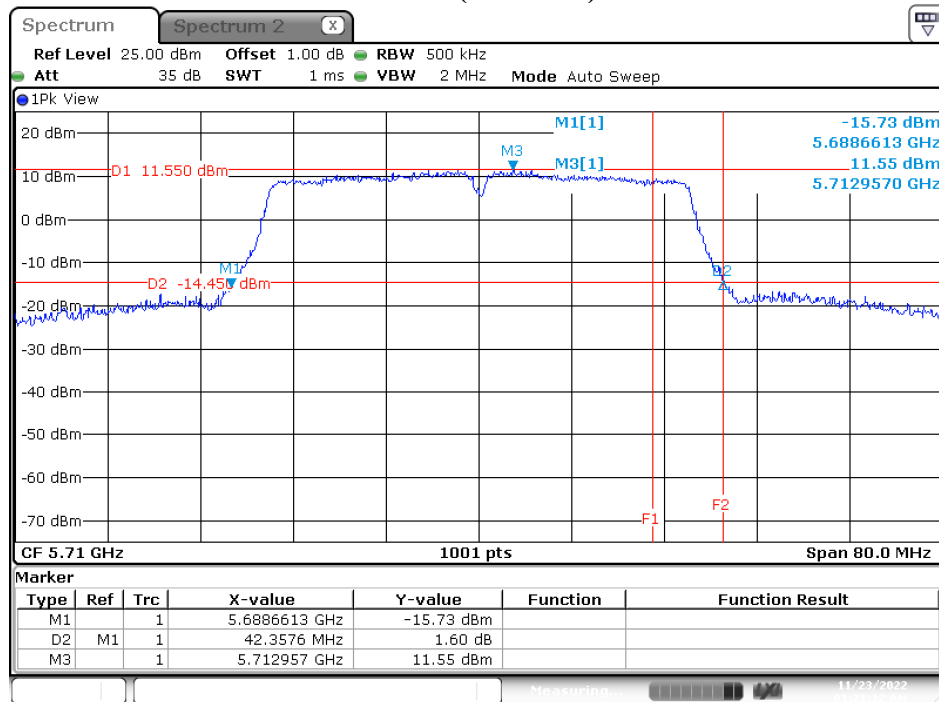

Date: 23.NOV.2022 01:21:13

Maximum conducted output power:

Channel 142 (U-NII-2C)

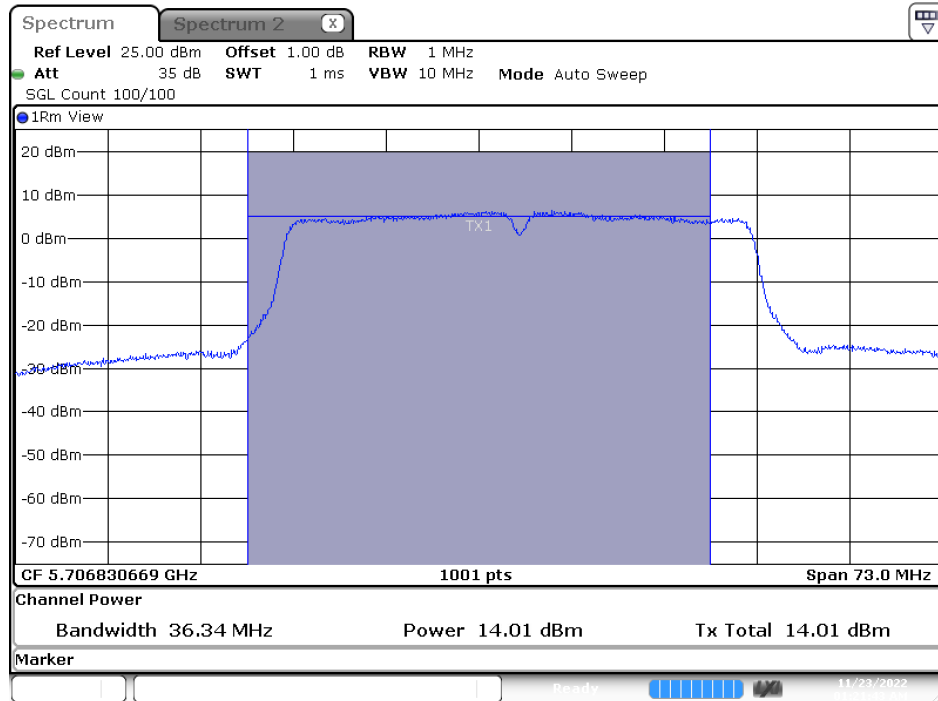

Date: 23.NOV.2022 01:21:44

Channel 142 (U-NII-3)

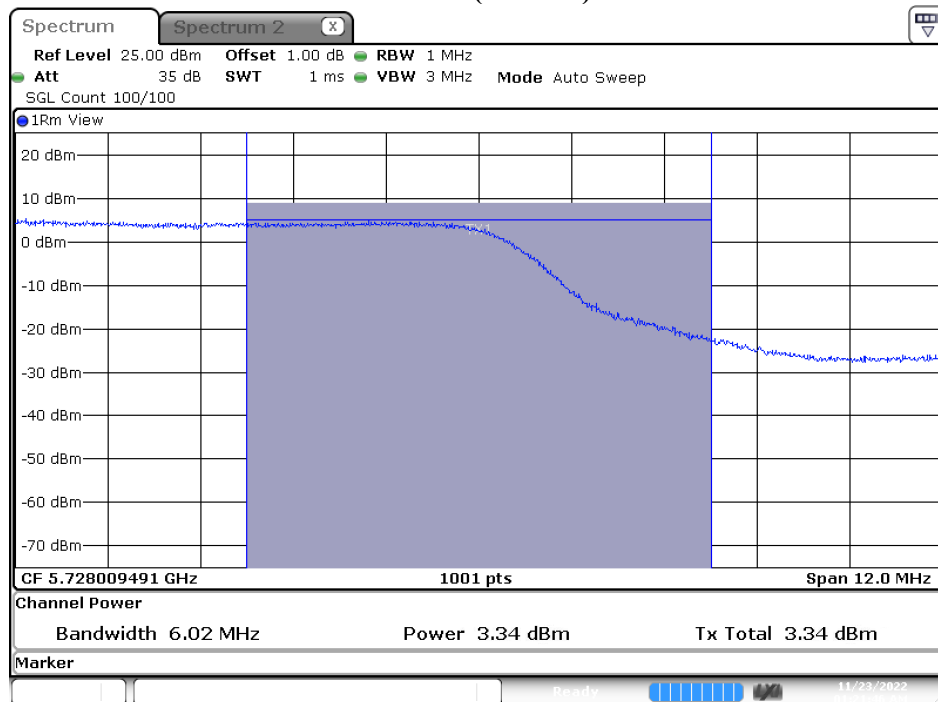

Date: 23.NOV.2022 01:21:47

Product : Mobile Computer
 Test Item : Maximum conducted output power
 Test Mode : Transmit (802.11ac-80MHz)
 Test Date : 2022/11/23

Channel No.	Frequency (MHz)	26dB Bandwidth (MHz)	Output Power (dBm)	Duty factor (dB)	Output Power Limit	
					(dBm)	dBm+10log(BW)
42	5210	--	14.33	--	24	--
58	5290	85.20	14.41	--	24	30.30
106	5530	83.76	14.31	--	24	30.23
122	5610	98.30	14.43	--	24	30.93
138(U-NII-2C)	5690	95.42	14.65	0.35	24	30.80
138(U-NII-3)	5690	--	0.45	0.35	30	--
155	5775	--	14.48	--	30	--

26dB Occupied Bandwidth:

Channel 138(U-NII-2C)

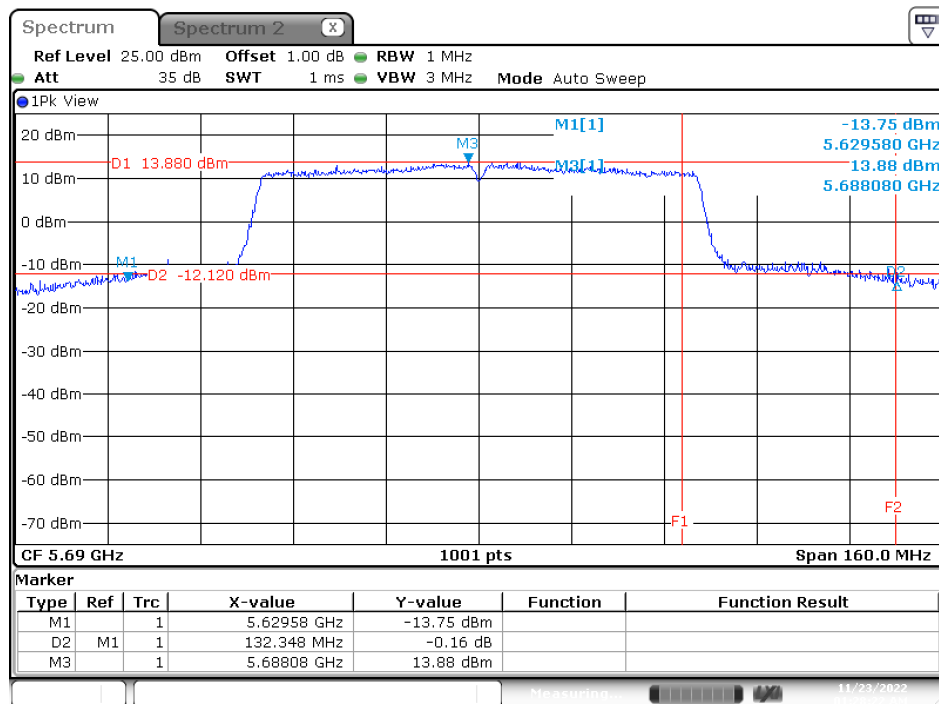

Date: 23.NOV.2022 01:28:22

Maximum conducted output power:

Channel 138 (U-NII-2C)

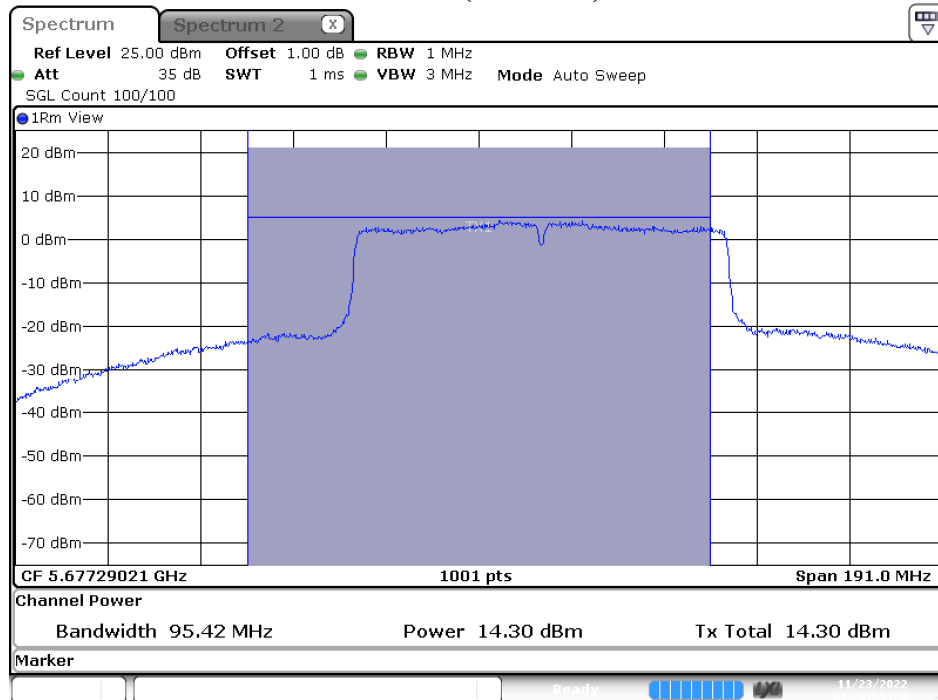

Date: 23.NOV.2022 01:28:54

Channel 138 (U-NII-3)

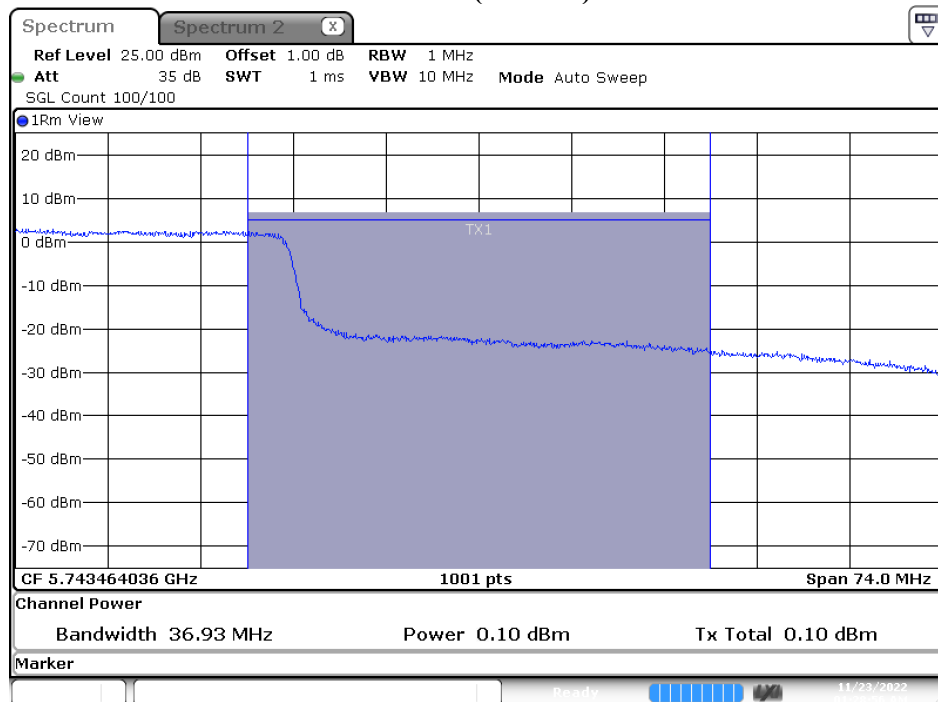

Date: 23.NOV.2022 01:28:57

4. Peak Power Spectral Density

4.1. Test Setup

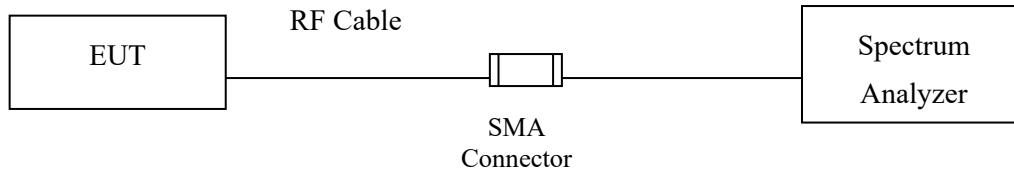

4.2. Limits

For the band 5.15-5.25 GHz,

- (i) For an outdoor access point operating in the band 5.15-5.25 GHz, the maximum power spectral density shall not exceed 17 dBm in any 1 megahertz band. If transmitting antennas of directional gain greater than 6 dBi are used, the maximum power spectral density shall be reduced by the amount in dB that the directional gain of the antenna exceeds 6 dBi.
- (ii) For an indoor access point operating in the band 5.15-5.25 GHz, the maximum power spectral density shall not exceed 17 dBm in any 1 megahertz band. If transmitting antennas of directional gain greater than 6 dBi are used, the maximum power spectral density shall be reduced by the amount in dB that the directional gain of the antenna exceeds 6 dBi.
- (iii) For fixed point-to-point access points operating in the band 5.15-5.25 GHz, the maximum conducted output power over the frequency band of operation shall not exceed 1 W. Fixed point-to-point U-NII devices may employ antennas with directional gain up to 23 dBi without any corresponding reduction in the maximum conducted output power or maximum power spectral density. For fixed point-to-point transmitters that employ a directional antenna gain greater than 23 dBi, a 1 dB reduction in maximum conducted output power and maximum power spectral density is required for each 1 dB of antenna gain in excess of 23 dBi. Fixed, point-to-point operations exclude the use of point-to-multipoint systems, omnidirectional applications, and multiple collocated transmitters transmitting the same information. The operator of the U-NII device, or if the equipment is professionally installed, the installer, is responsible for ensuring that systems employing high gain directional antennas are used exclusively for fixed, point-to-point operations.
- (iv) For mobile and portable client devices in the 5.15-5.25 GHz band, the maximum power spectral density shall not exceed 11 dBm in any 1 megahertz band. If transmitting antennas of directional gain greater than 6 dBi are used, the maximum power spectral density shall be reduced by the amount in dB that the directional gain of the antenna exceeds 6 dBi.+

For the 5.25-5.35 GHz and 5.47-5.725 GHz bands, the maximum power spectral density shall not exceed 11 dBm in any 1 megahertz band. If transmitting antennas of directional gain greater than 6 dBi are used, the maximum power spectral density shall be reduced by the amount in dB that the directional gain of the antenna exceeds 6 dBi.

For the band 5.725-5.85 GHz, the maximum power spectral density shall not exceed 30 dBm in any 500-kHz band. If transmitting antennas of directional gain greater than 6 dBi are used, the maximum power spectral density shall be reduced by the amount in dB that the directional gain of the antenna exceeds 6 dBi. However, fixed point-to-point UNII devices operating in this band may employ transmitting antennas with directional gain greater than 6 dBi without any corresponding reduction in transmitter conducted power. Fixed, point-to-point operations exclude the use of point-to-multipoint systems, omnidirectional applications, and multiple collocated transmitters transmitting the same information. The operator of the U-NII device, or if the equipment is professionally installed, the installer, is responsible for ensuring that systems employing high gain directional antennas are used exclusively for fixed, point-to-point operations.

4.3. Test Procedure

The EUT was setup to ANSI C63.10, 2013; tested to UNII test procedure of FCC KDB-789033 for compliance to FCC 47CFR Subpart E requirements.

The Peak Power Spectral Density using KDB 789033 section F) procedure, Create an average power spectrum for the EUT operating mode being tested by following the instructions in section E)2) for measuring maximum conducted output power using a spectrum analyzer.

SA-1 method is selected to run the test.

For the band 5.725-5.85 GHz, Scale the observed power level to an equivalent value in 500 kHz by adjusting (increase) the measured power by a bandwidth correction factor (BWCF) where $BWCF = 10\log(500 \text{ kHz}/100 \text{ kHz}) = 6.98 \text{ dB}$.

4.4. Test Result of Peak Power Spectral Density

Product : Mobile Computer
 Test Item : Peak Power Spectral Density
 Test Mode : Transmit (802.11a)
 Test Date : 2022/11/23

Channel Number	Frequency (MHz)	Data Rate (Mbps)	PPSD/MHz (dBm)	Duty factor (dB)	Total PPSD/MHz (dBm)	Required Limit (dBm)	Result
36	5180	6	8.50	0.10	8.60	<11	Pass
44	5220	6	8.79	0.10	8.89	<11	Pass
48	5240	6	8.74	0.10	8.84	<11	Pass
52	5260	6	8.91	0.10	9.01	<11	Pass
60	5300	6	8.82	0.10	8.92	<11	Pass
64	5320	6	8.68	0.10	8.78	<11	Pass
100	5500	6	8.57	0.10	8.67	<11	Pass
116	5580	6	9.74	0.10	9.84	<11	Pass
140	5700	6	7.53	0.10	7.63	<11	Pass
144(U-NII-2C)	5720	6	8.36	0.10	8.46	<11	Pass
144(U-NII-3)	5720	6	3.96	0.10	4.06	<30	Pass
149	5745	6	5.85	0.10	5.95	<30	Pass
157	5785	6	6.06	0.10	6.16	<30	Pass
165	5825	6	5.82	0.10	5.92	<30	Pass

Channel 44

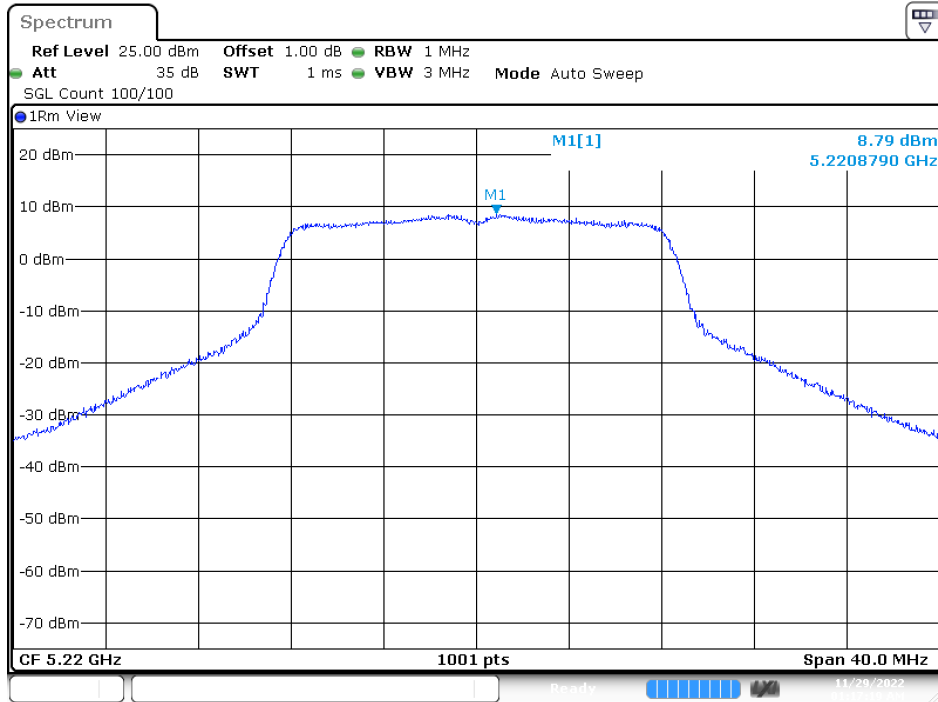

Date: 29.NOV.2022 01:17:19

Channel 157

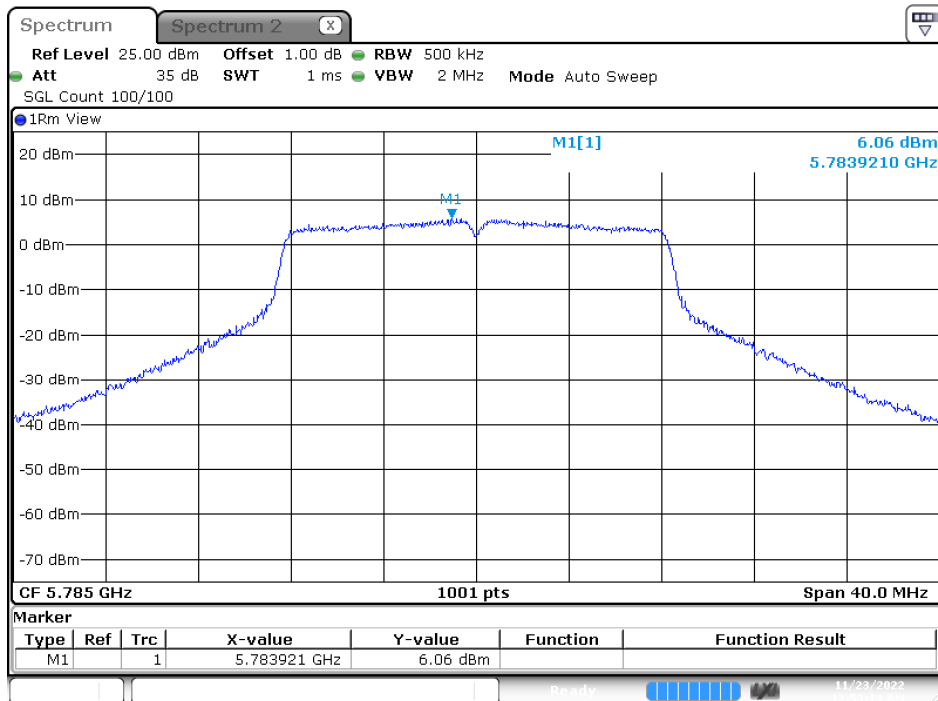

Date: 23.NOV.2022 00:53:14

Product : Mobile Computer
 Test Item : Peak Power Spectral Density
 Test Mode : Transmit (802.11ac-20MHz)
 Test Date : 2022/11/23

Channel Number	Frequency (MHz)	Data Rate (Mbps)	PPSD/MHz (dBm)	Duty factor (dB)	Total PPSD/MHz (dBm)	Required Limit (dBm)	Result
36	5180	HT0	8.20	0.10	8.30	<11	Pass
44	5220	HT0	8.44	0.10	8.54	<11	Pass
48	5240	HT0	8.46	0.10	8.56	<11	Pass
52	5260	HT0	8.57	0.10	8.67	<11	Pass
60	5300	HT0	8.54	0.10	8.64	<11	Pass
64	5320	HT0	8.17	0.10	8.27	<11	Pass
100	5500	HT0	7.66	0.10	7.76	<11	Pass
116	5580	HT0	9.54	0.10	9.64	<11	Pass
140	5700	HT0	7.07	0.10	7.17	<11	Pass
144(U-NII-2C)	5720	HT0	8.39	0.10	8.49	<11	Pass
144(U-NII-3)	5720	HT0	3.96	0.10	4.06	<30	Pass
149	5745	HT0	5.67	0.10	5.77	<30	Pass
157	5785	HT0	5.65	0.10	5.75	<30	Pass
165	5825	HT0	5.48	0.10	5.58	<30	Pass

Channel 52

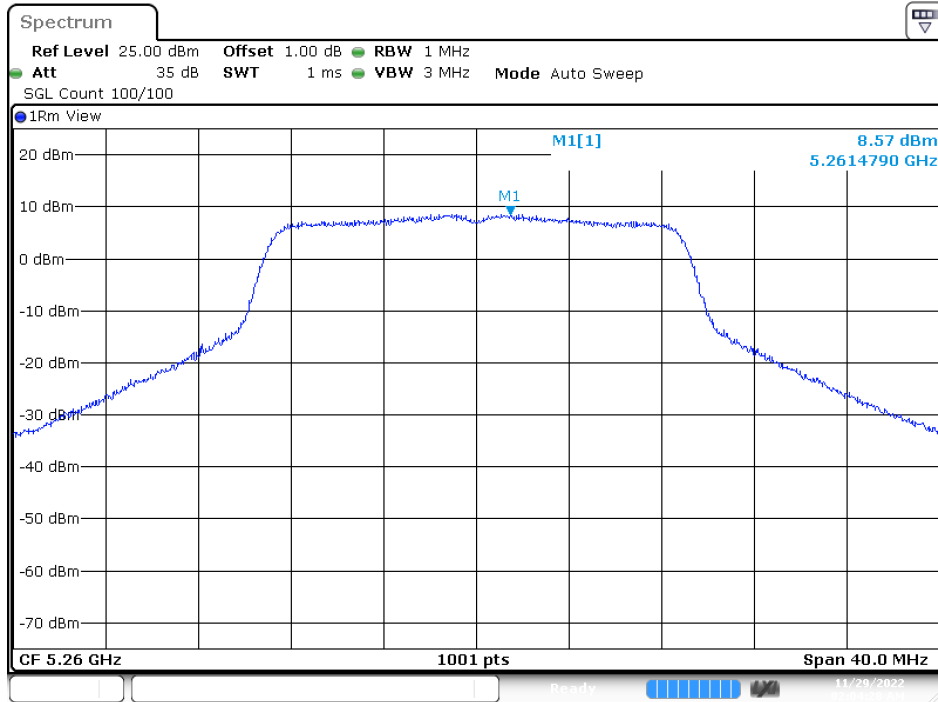

Date: 29.NOV.2022 02:04:28

Channel 149

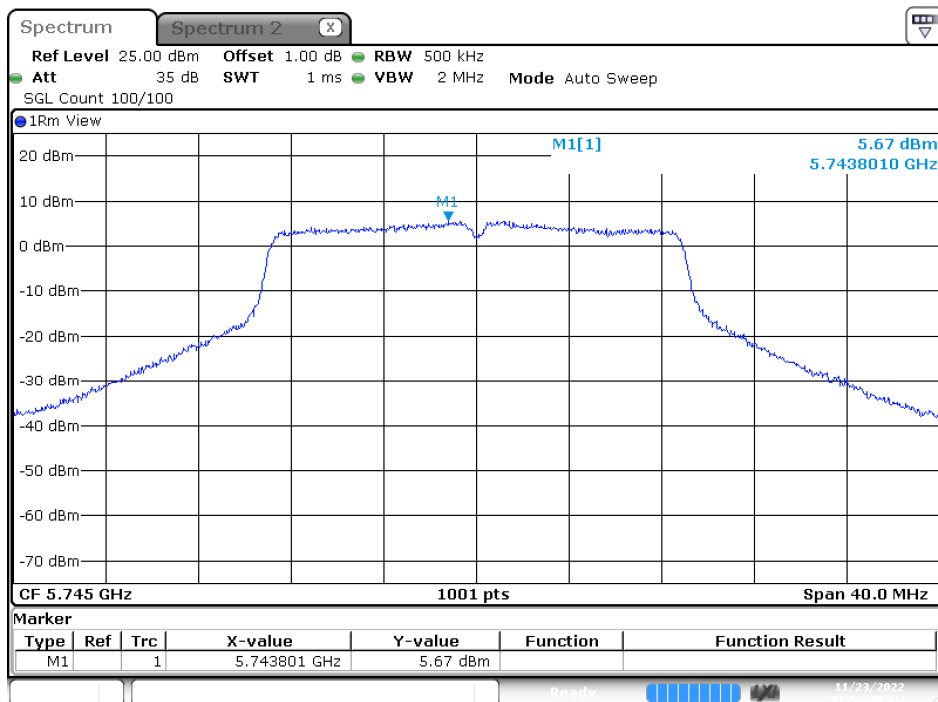

Date: 23.NOV.2022 01:06:49

Product : Mobile Computer
 Test Item : Peak Power Spectral Density
 Test Mode : Transmit (802.11ac-40MHz)
 Test Date : 2022/11/23

Channel Number	Frequency (MHz)	Data Rate (Mbps)	PPSD/MHz (dBm)	Duty factor (dB)	Total PPSD/MHz (dBm)	Required Limit (dBm)	Result
38	5190	HT0	3.46	0.21	3.67	<11	Pass
46	5230	HT0	7.47	0.21	7.68	<11	Pass
54	5270	HT0	5.69	0.21	5.90	<11	Pass
62	5310	HT0	3.16	0.21	3.37	<11	Pass
102	5510	HT0	4.40	0.21	4.61	<11	Pass
110	5550	HT0	7.48	0.21	7.69	<11	Pass
134	5670	HT0	5.23	0.21	5.44	<11	Pass
142(U-NII-2C)	5710	HT0	6.44	0.21	6.65	<11	Pass
142(U-NII-3)	5710	HT0	1.59	0.21	1.80	<30	Pass
151	5755	HT0	3.53	0.21	3.74	<30	Pass
159	5795	HT0	3.67	0.21	3.88	<30	Pass

Channel 110

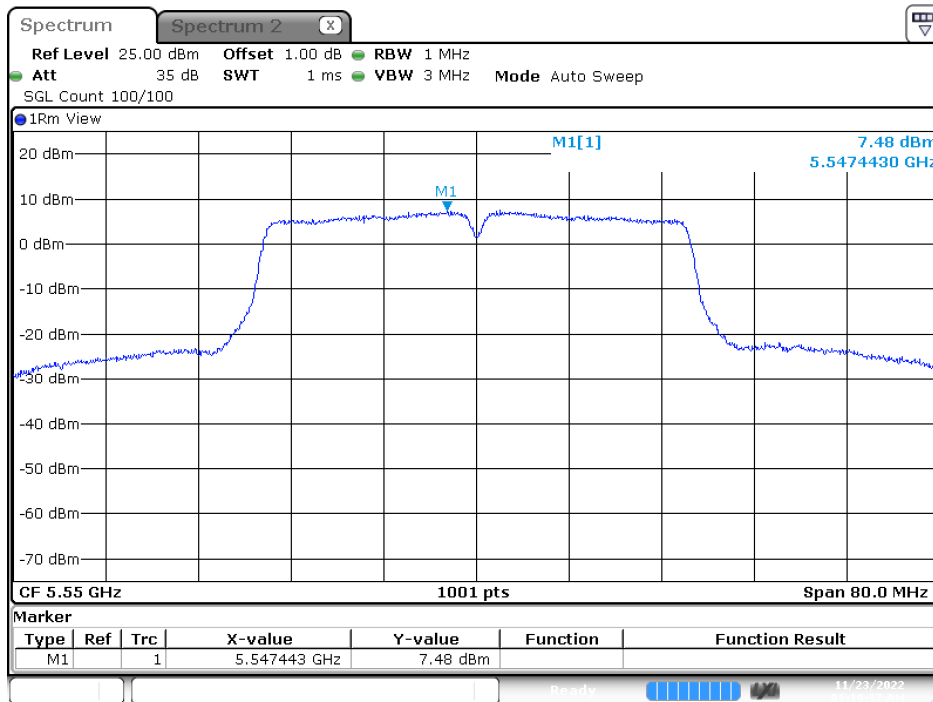

Date: 23.NOV.2022 01:19:37

Channel 159

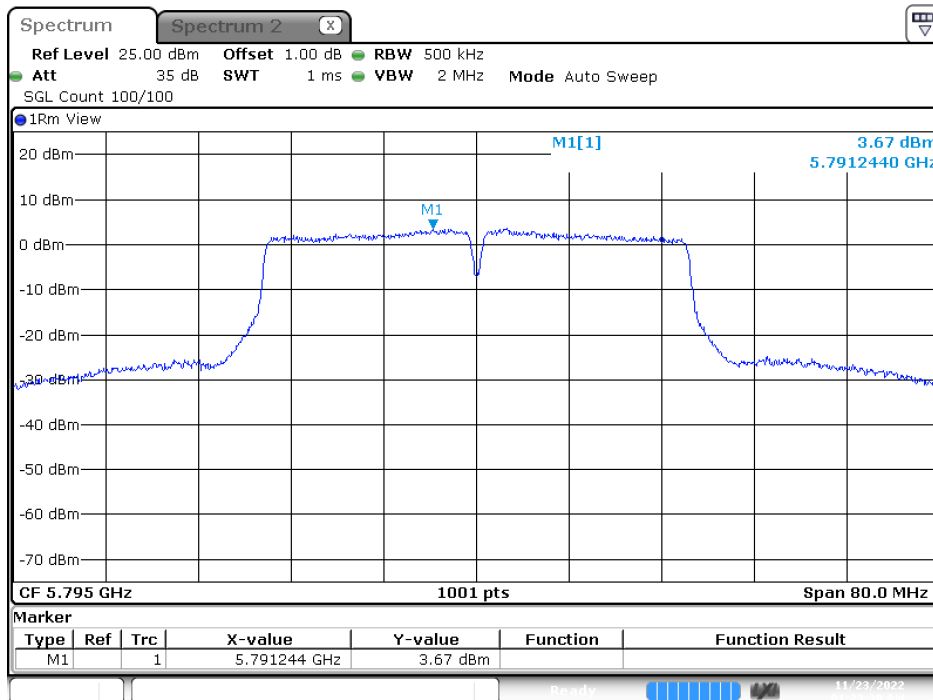

Date: 23.NOV.2022 01:23:39

Product : Mobile Computer
Test Item : Peak Power Spectral Density
Test Mode : Transmit (802.11ac-80MHz)
Test Date : 2022/11/23

Channel Number	Frequency (MHz)	Data Rate (Mbps)	PPSD/MHz (dBm)	Duty factor (dB)	Total PPSD/MHz (dBm)	Required Limit (dBm)	Result
42	5210	VHT0	-1.48	0.35	-1.13	<11	Pass
58	5290	VHT0	-0.92	0.35	-0.57	<11	Pass
106	5530	VHT0	-2.06	0.35	-1.71	<11	Pass
122	5610	VHT0	3.81	0.35	4.16	<11	Pass
138 (U-NII-3)	5690	VHT0	4.33	0.35	4.68	<11	Pass
138 (U-NII-3)	5690	VHT0	-0.91	0.35	-0.56	<30	Pass
155	5775	VHT0	0.63	0.35	0.98	<30	Pass

Channel 122

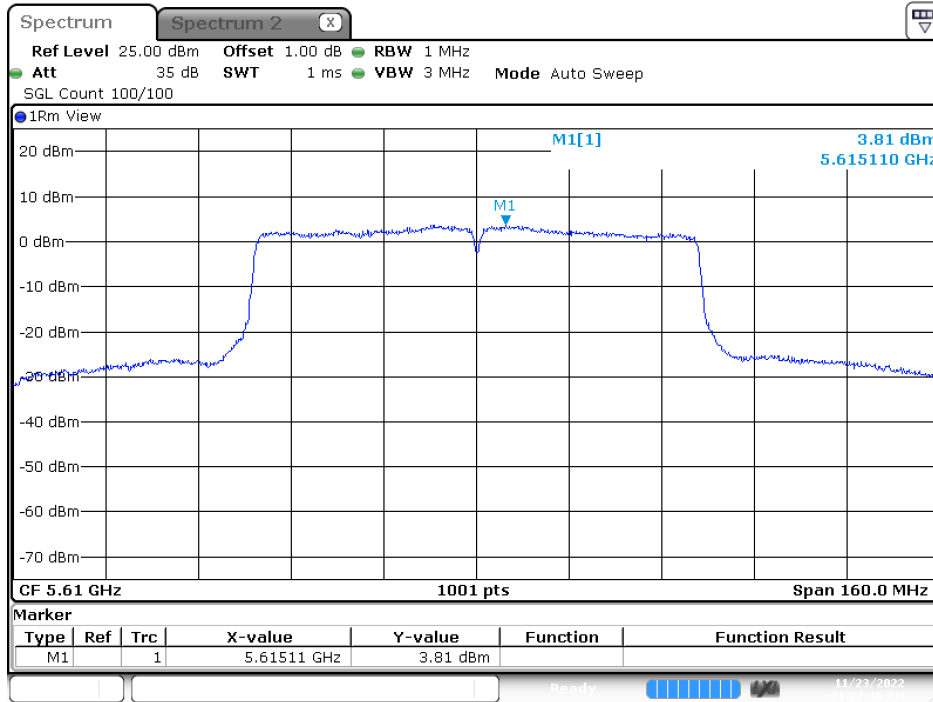

Date: 23.NOV.2022 01:27:46

Channel 155

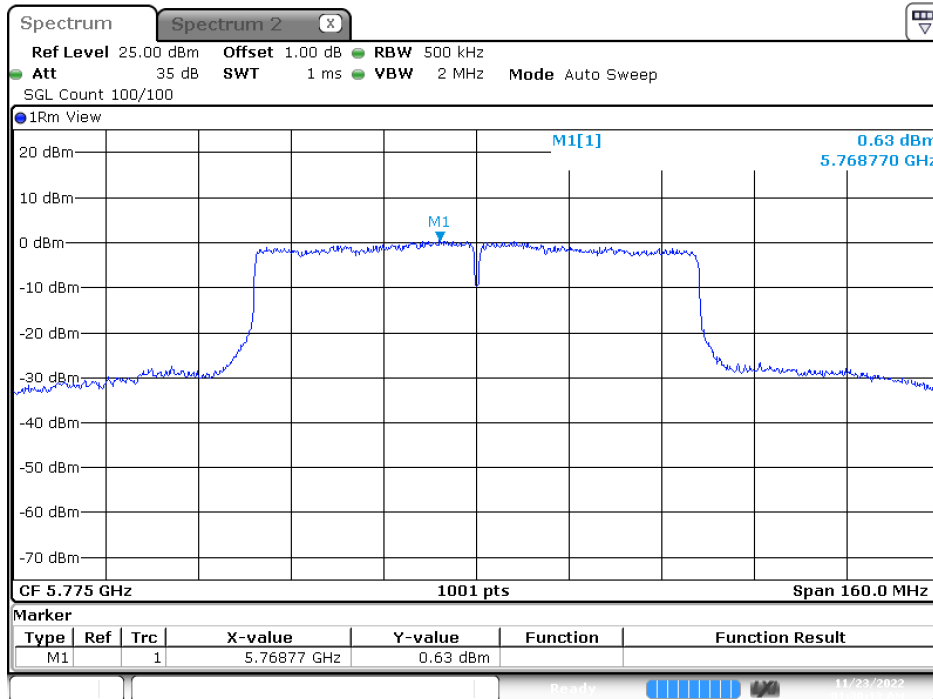

Date: 23.NOV.2022 01:30:13

5. Radiated Emission

5.1. Test Setup

Radiated Emission Under 30 MHz

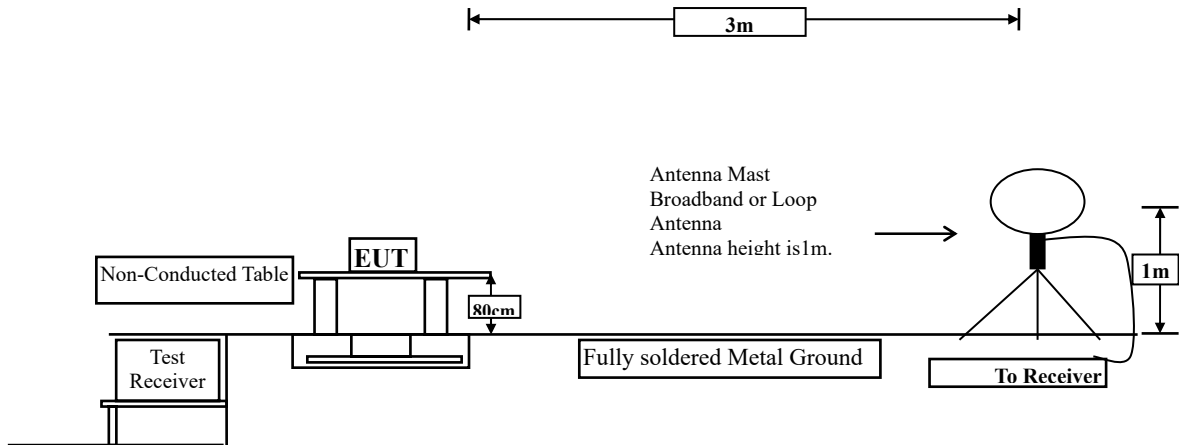

Radiated Emission Below 1 GHz

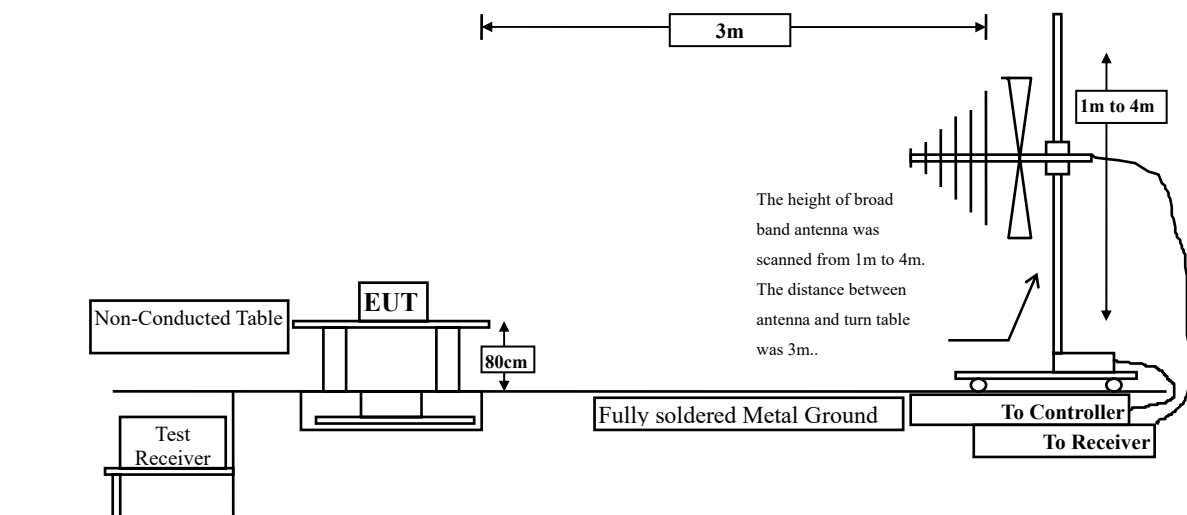

Radiated Emission Above 1 GHz

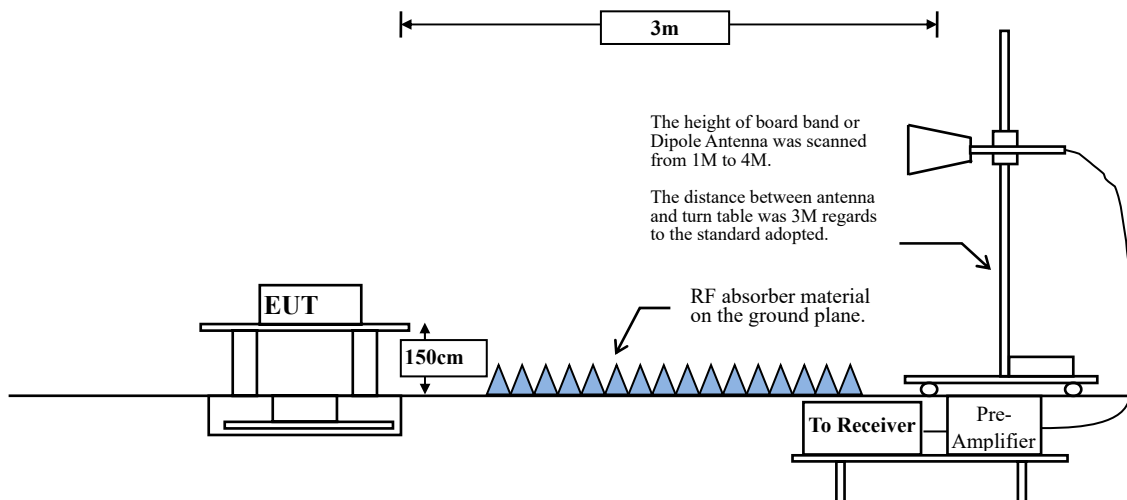

5.2. Limits

Emissions radiated outside of the specified frequency bands, except for harmonics, shall be attenuated by at least 20dB below the level of the fundamental or to the general radiated emission limits in paragraph 15.209, whichever is the lesser attenuation.

FCC Part 15 Subpart C Paragraph 15.209(a) Limits		
Frequency MHz	Field strength (microvolts/meter)	Measurement distance (meter)
0.009-0.490	2400/F(kHz)	300
0.490-1.705	24000/F(kHz)	30
1.705-30	30	30
30-88	100	3
88-216	150	3
216-960	200	3
Above 960	500	3

Remarks: E field strength (dB μ V/m) = 20 log E field strength (uV/m)

- For transmitters operating in the 5.15-5.25 GHz band: All emissions outside of the 5.15-5.35 GHz band shall not exceed an e.i.r.p. of -27 dBm/MHz.
- For transmitters operating in the 5.25-5.35 GHz band: All emissions outside of the 5.15-5.35 GHz band shall not exceed an e.i.r.p. of -27 dBm/MHz.
- For transmitters operating in the 5.47-5.725 GHz band: All emissions outside of the 5.47-5.725 GHz band shall not exceed an e.i.r.p. of -27 dBm/MHz.
- For transmitters operating in the 5.725-5.85 GHz band:
All emissions shall be limited to a level of -27 dBm/MHz at 75 MHz or more above or below the band edge increasing linearly to 10 dBm/MHz at 25 MHz above or below the band edge, and from 25 MHz above or below the band edge increasing linearly to a level of 15.6 dBm/MHz at 5 MHz above or below the band edge, and from 5 MHz above or below the band edge increasing linearly to a level of 27 dBm/MHz at the band edge.
- For transmitters operating within the 5.925-7.125 GHz band: Any emissions outside of the 5.925-7.125 GHz band must not exceed an e.i.r.p. of -27 dBm/MHz.

Based on ANSI C63.10-2013 Section 12.7.3 d) provides the conversion formula between field strength and EIRP, if distance is 3m, -27dBm is equivalent to 68.22dBuV/m.

5.3. Test Procedure

The EUT was setup according to ANSI C63.10, 2013 and tested according to FCC KDB-789033 test procedure for compliance to FCC 47CFR 15. 407 requirements.

Measuring the frequency range below 1 GHz, the EUT is placed on a turn table which is 0.8 meter above ground, when measuring the frequency range above 1 GHz, the EUT is placed on a turn table which is 1.5 meter above ground.

The turn table is rotated 360 degrees to determine the position of the maximum emission level.

The EUT was positioned such that the distance from antenna to the EUT was 3 meters.

The antenna is scanned between 1 meter and 4 meters to find out the maximum emission level. This is repeated for both horizontal and vertical polarization of the antenna. In order to find the maximum emission, all of the interface cables were manipulated according to ANSI C63.10: 2013 on radiated measurement.

The resolution bandwidth below 30 MHz setting on the field strength meter is 9kHz and 30 MHz~1 GHz is 120 kHz and above 1 GHz is 1 MHz.

Radiated emission measurements below 30 MHz are made using Loop Antenna and 30 MHz~1 GHz are made using broadband Bilog antenna and above 1 GHz are made using Horn Antennas.

The measurement is divided into the Preliminary Measurement and the Final Measurement.

The suspected frequencies are searched for in Preliminary Measurement with the measurement antenna kept pointed at the source of the emission both in azimuth and elevation, with the polarization of the antenna oriented for maximum response. The antenna is pointed at an angle towards the source of the emission, and the EUT is rotated in both height and polarization to maximize the measured emission. The emission is kept within the illumination area of the 3 dB bandwidth of the antenna.

The measurement frequency range from 9 kHz - 10th Harmonic of fundamental was investigated.

RBW and VBW Parameter setting:

According to KDB 789033 section II.G.5 Procedure for Unwanted Maximum Emissions Measurements above 1000 MHz.

RBW = 1 MHz.

VBW \geq 3 MHz.

According to KDB 789033 section II.G.6 Procedures for Average Unwanted Emissions Measurements above 1000 MHz.

RBW = 1 MHz.

VBW = 10 Hz, when duty cycle \geq 98 %

VBW \geq 1/T, when duty cycle < 98 %

(T refers to the minimum transmission duration over which the transmitter is on and is transmitting at its maximum power control level for the tested mode of operation.)

5 GHz band	Duty Cycle (%)	T (ms)	1/T (Hz)	VBW (Hz)
802.11 a	97.81	2.0280	493	500
802.11 ac20	97.66	1.8980	527	1000
802.11 ac40	95.33	0.9295	1076	2000
802.11 ac80	92.28	0.4540	2203	3000

Note: Duty Cycle Refer to Section 8

5.4. Test Result of Radiated Emission

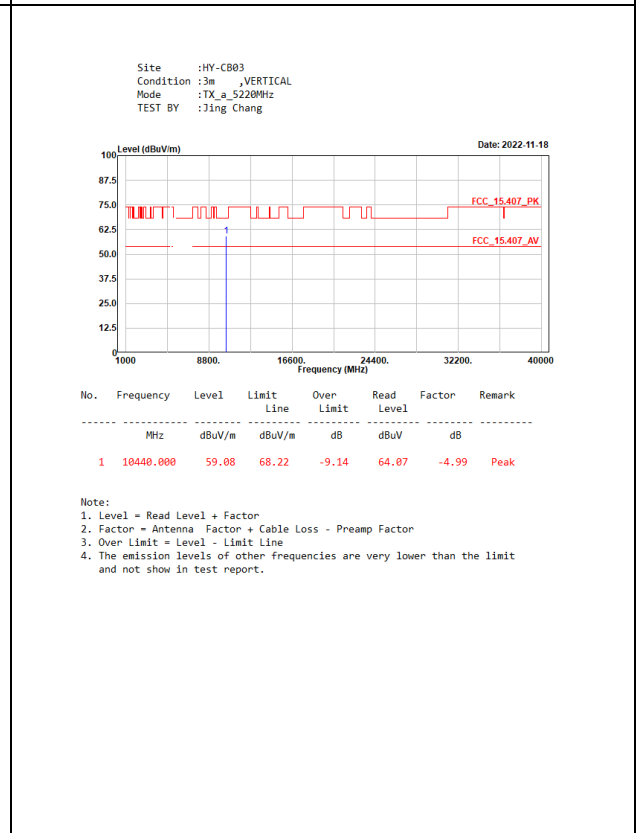
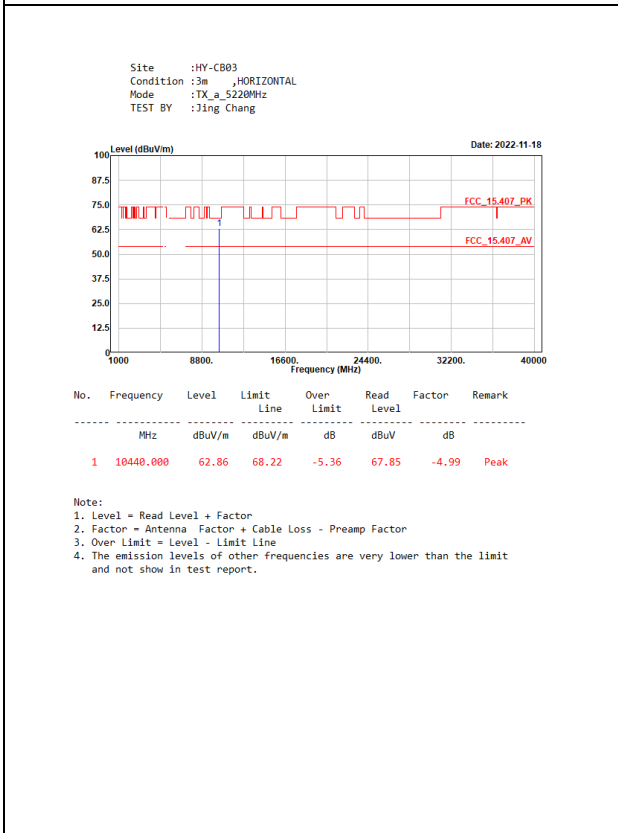
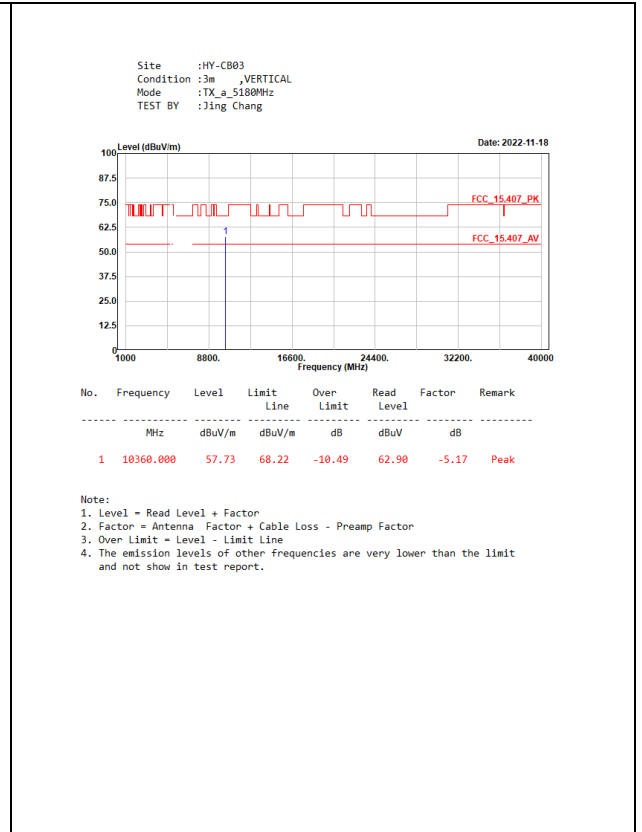
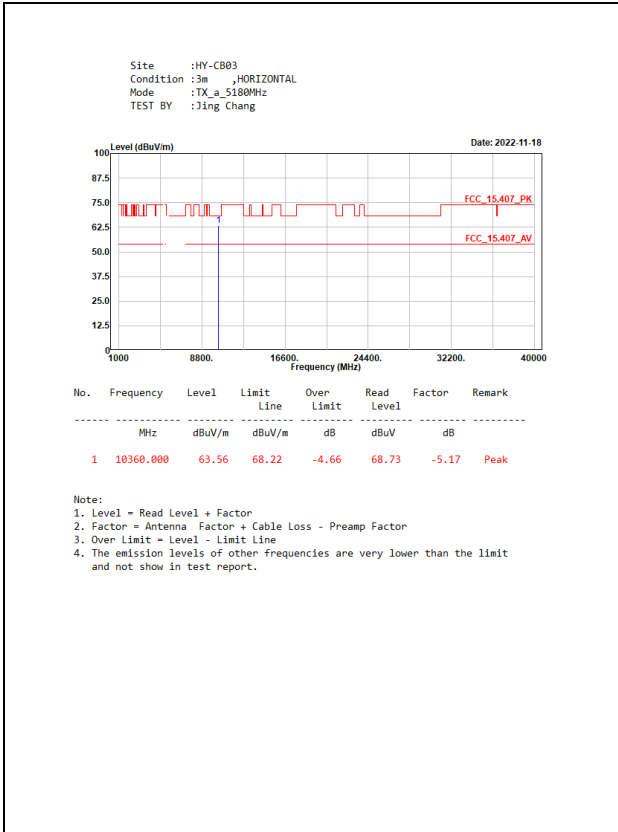

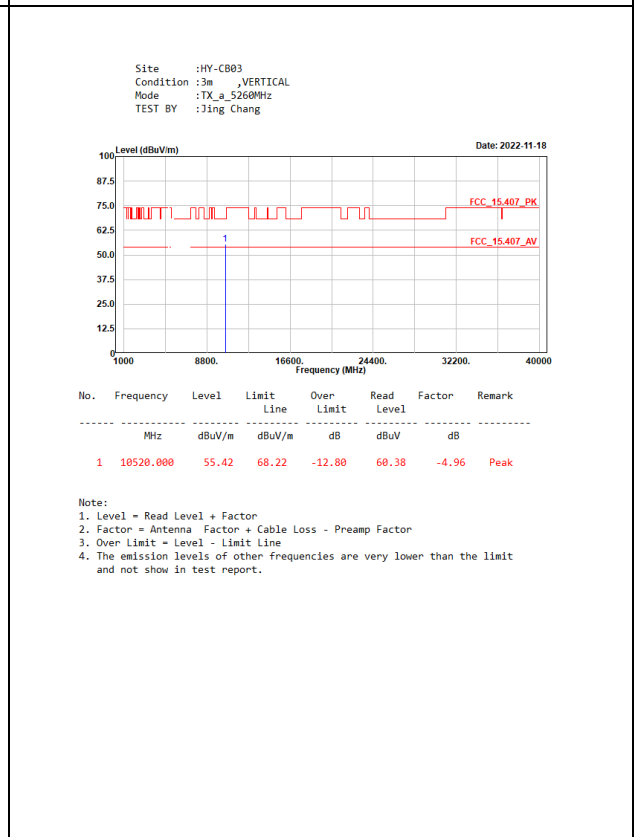
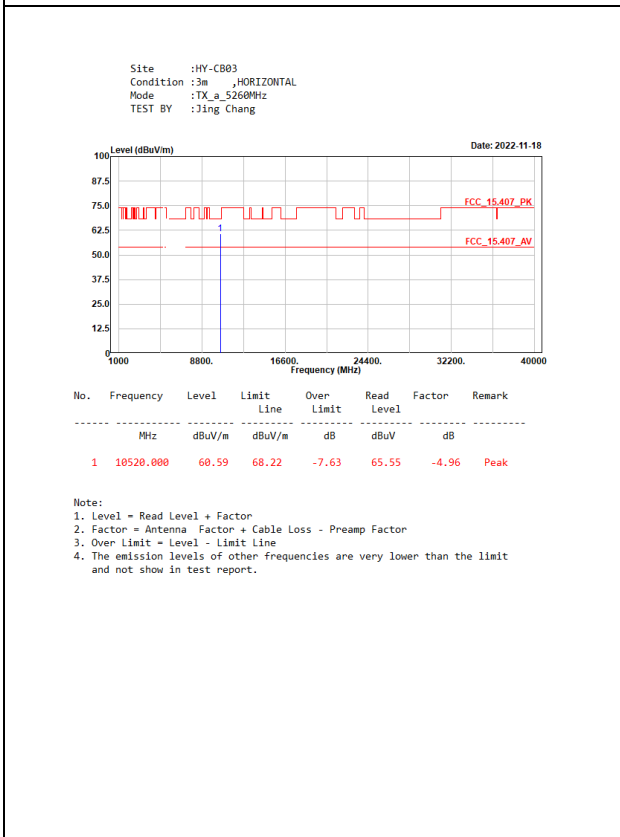
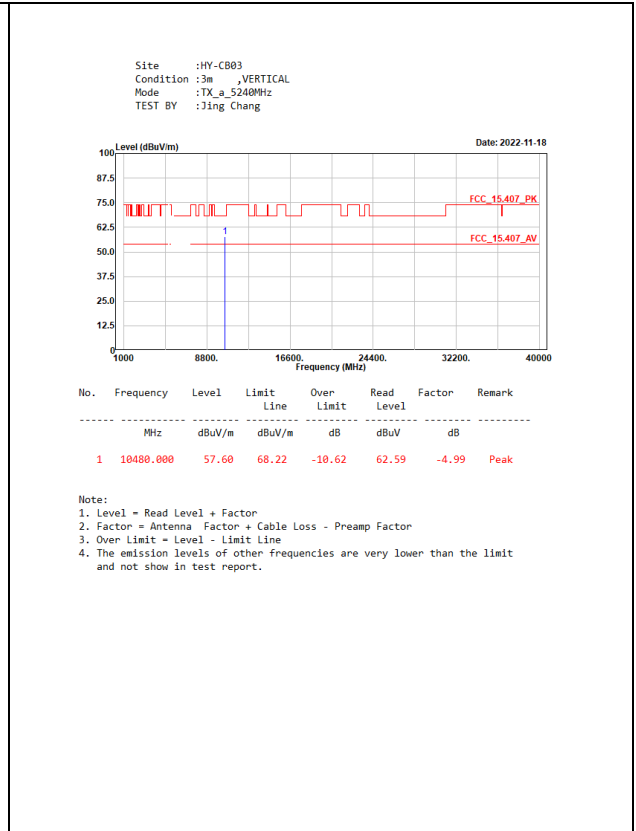
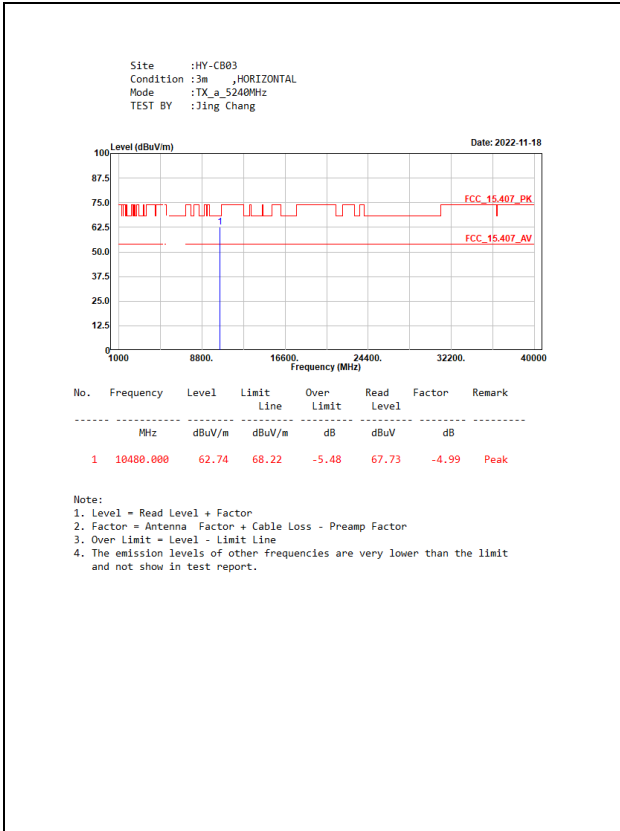

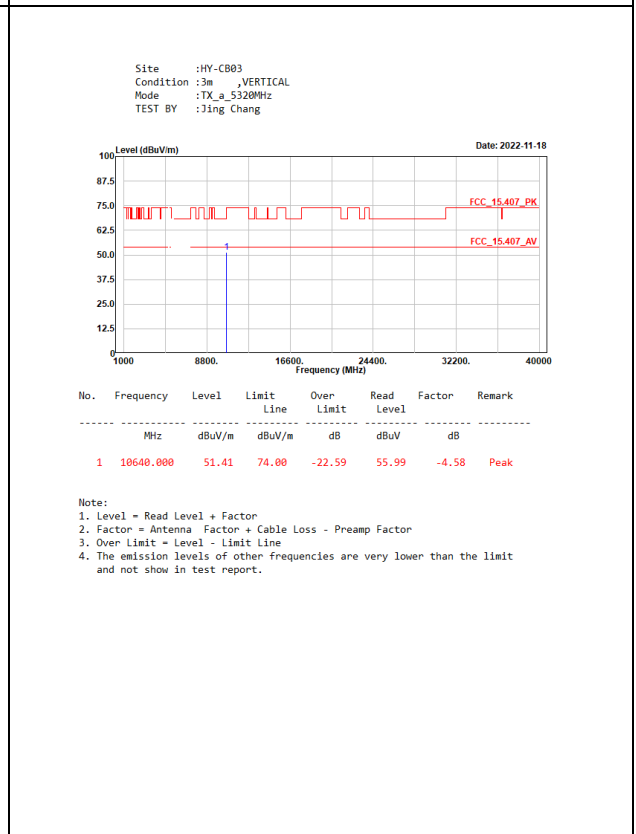
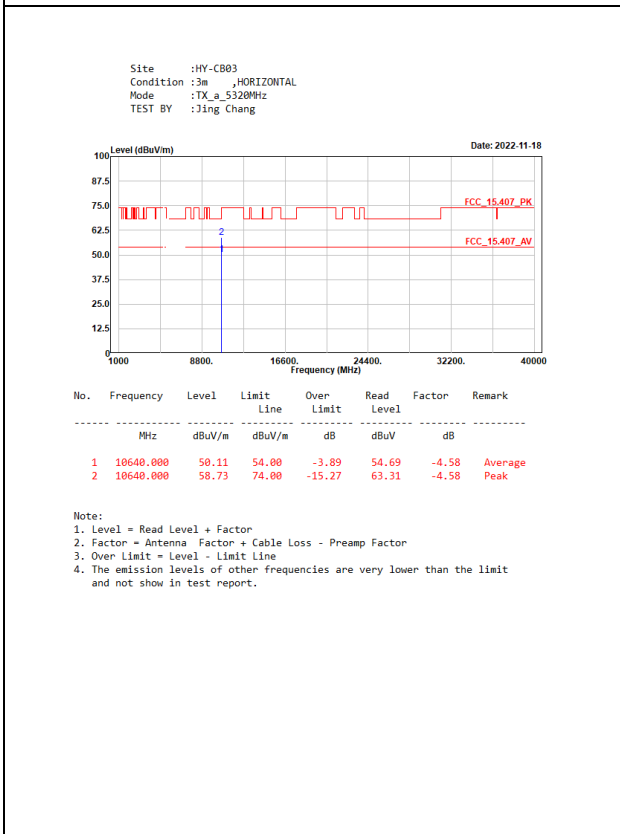
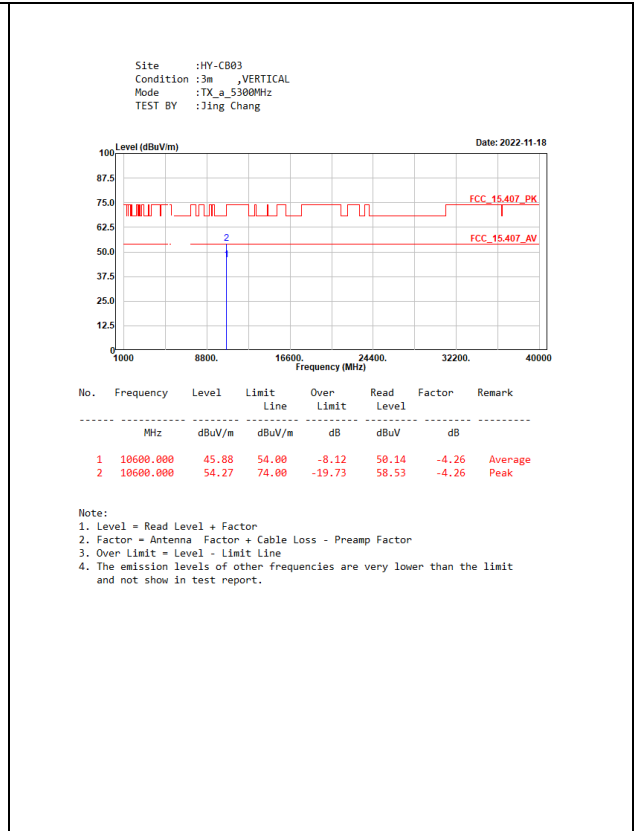
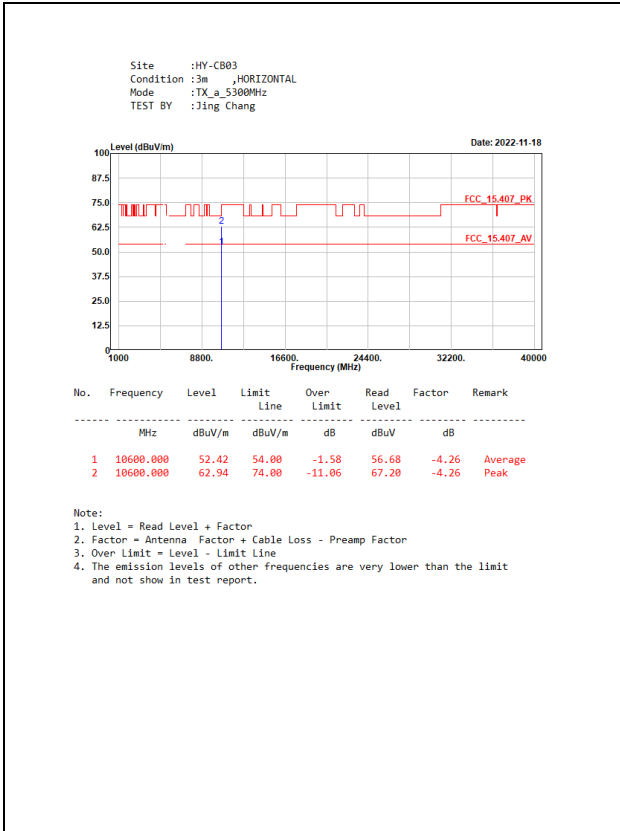

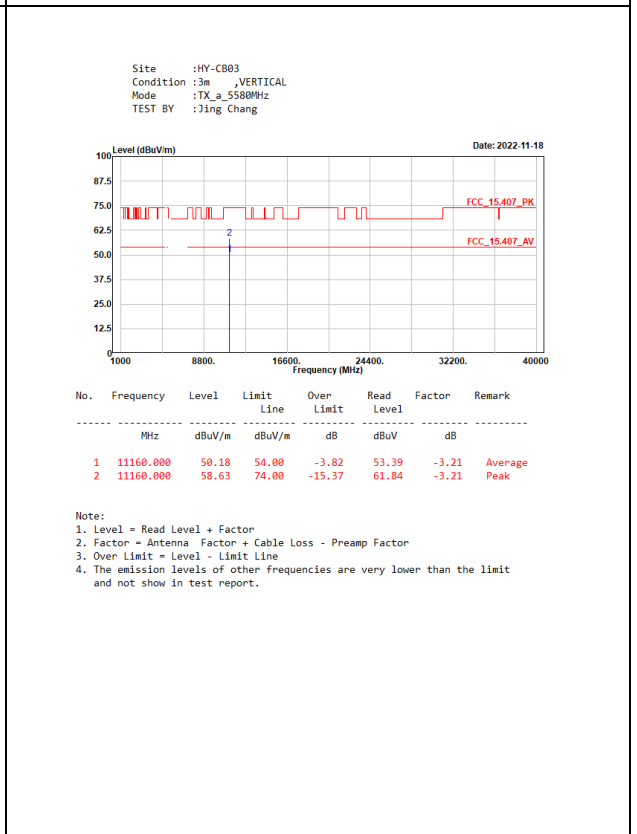
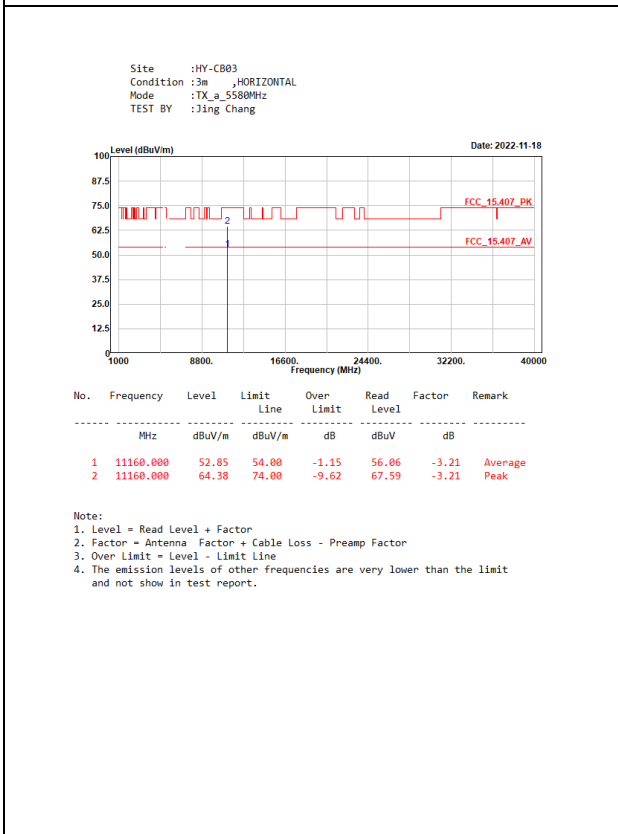
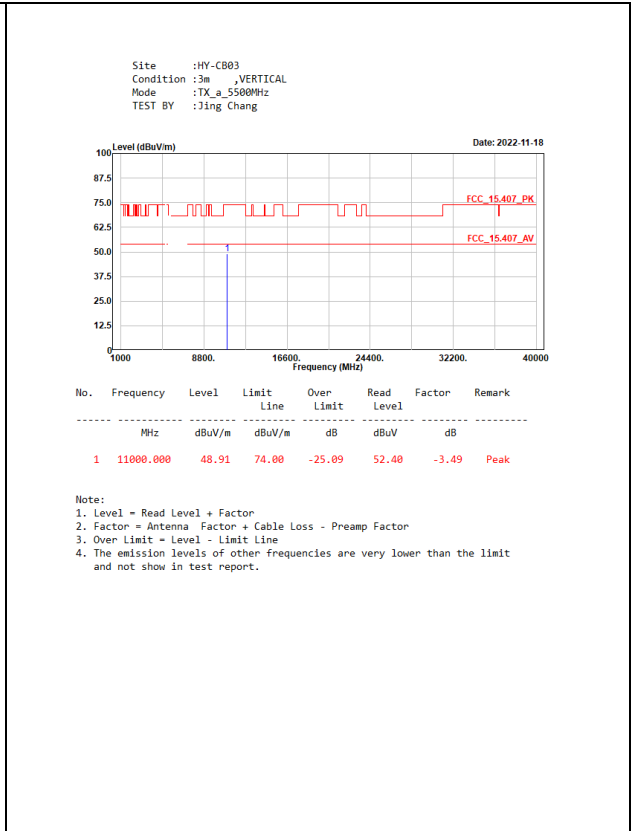
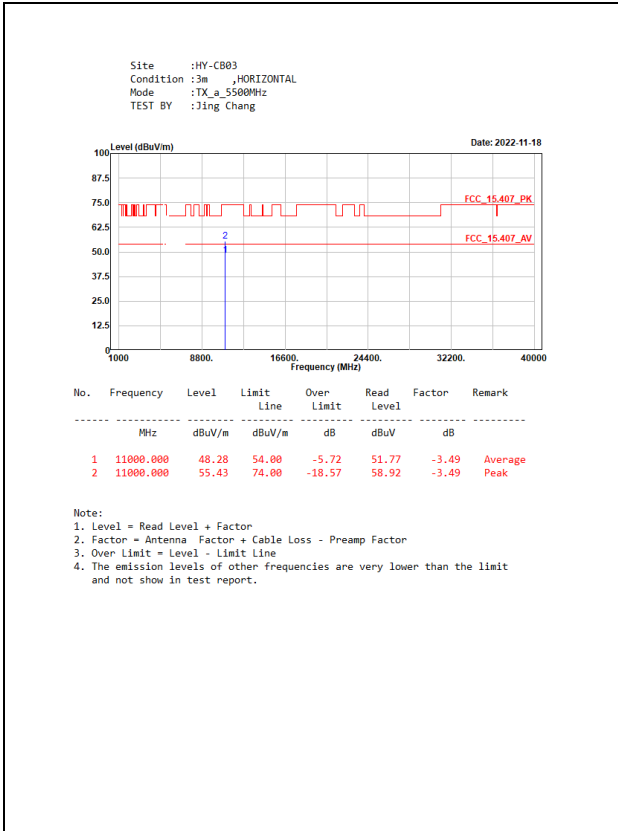

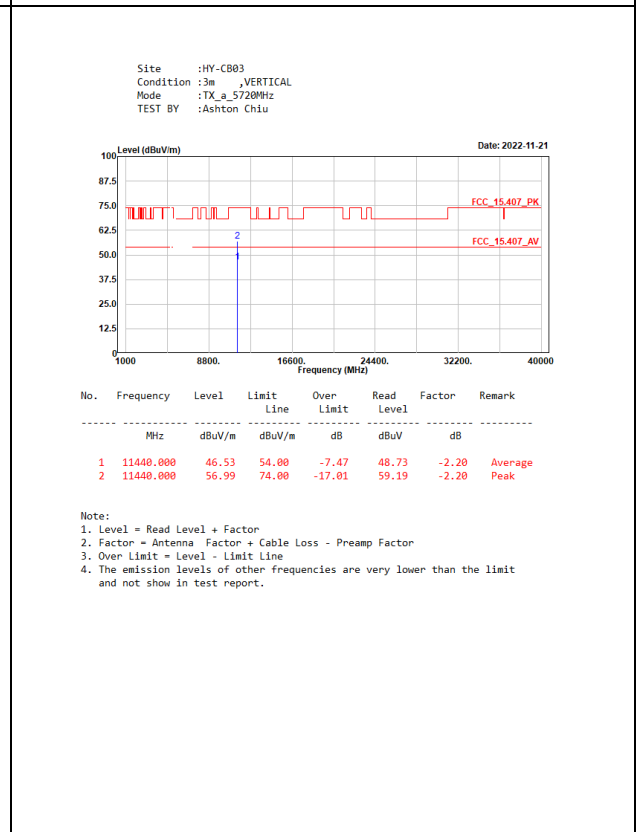
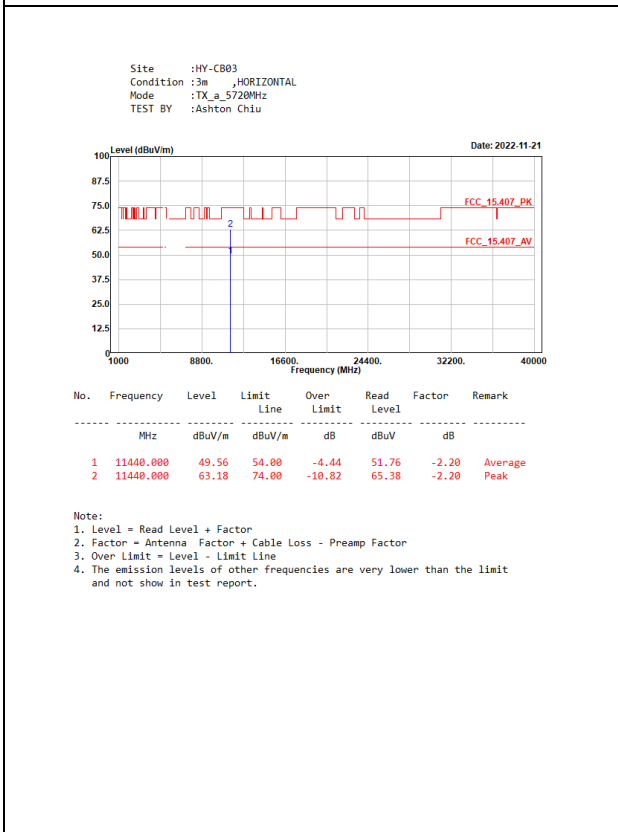
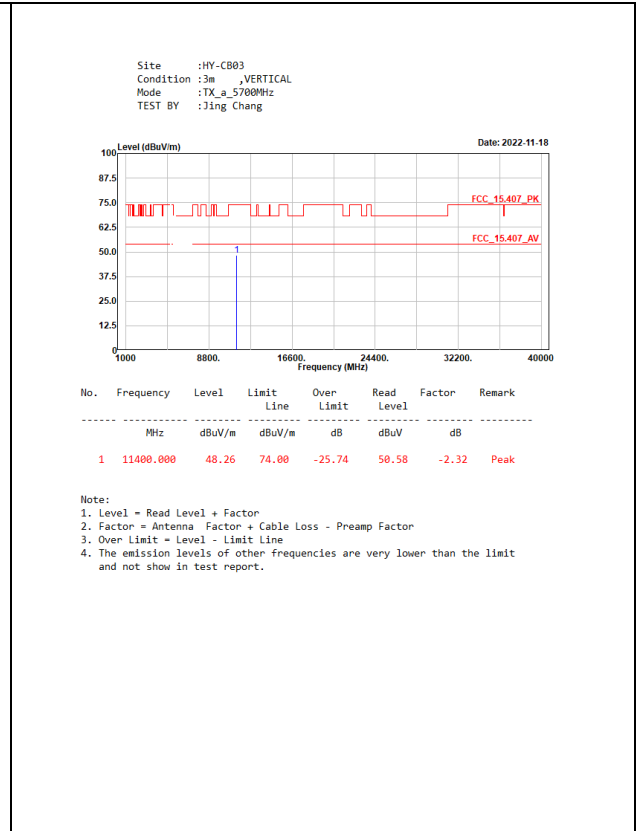
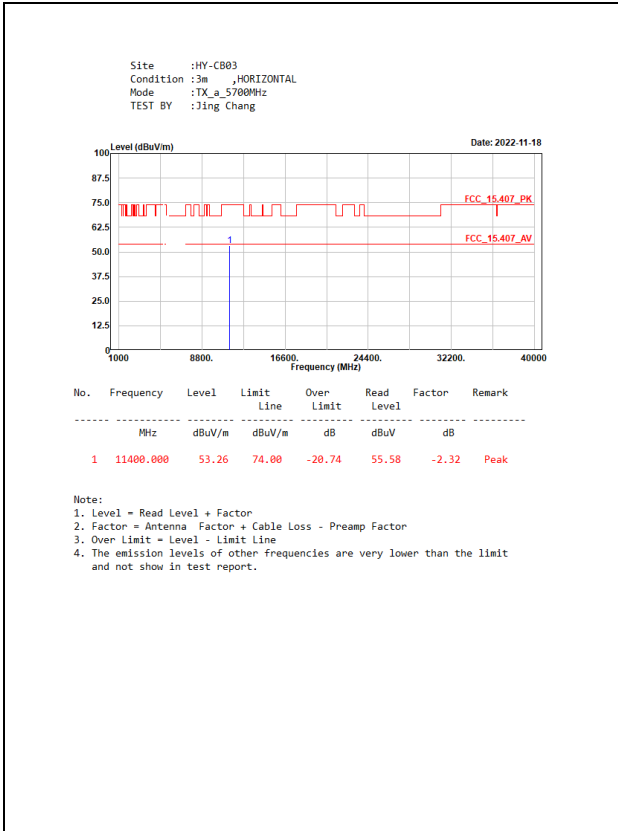

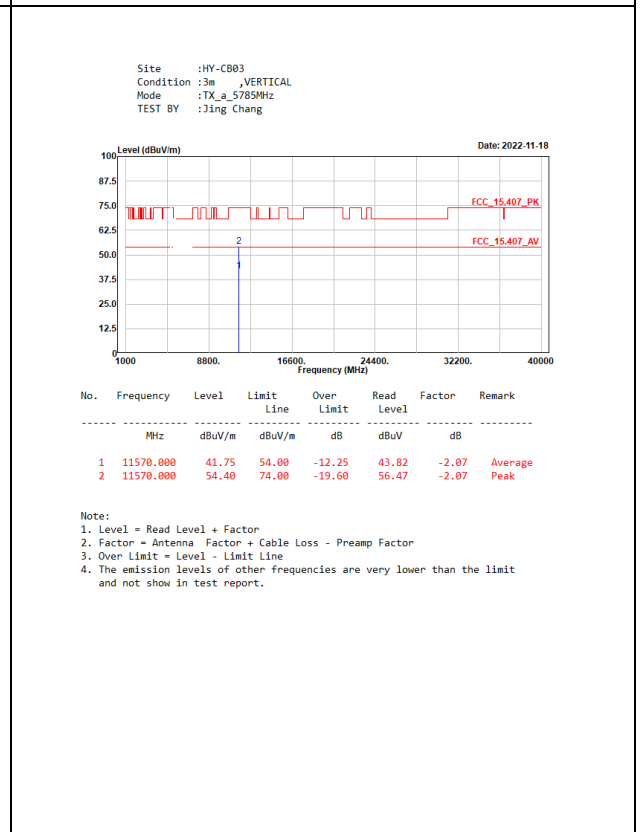
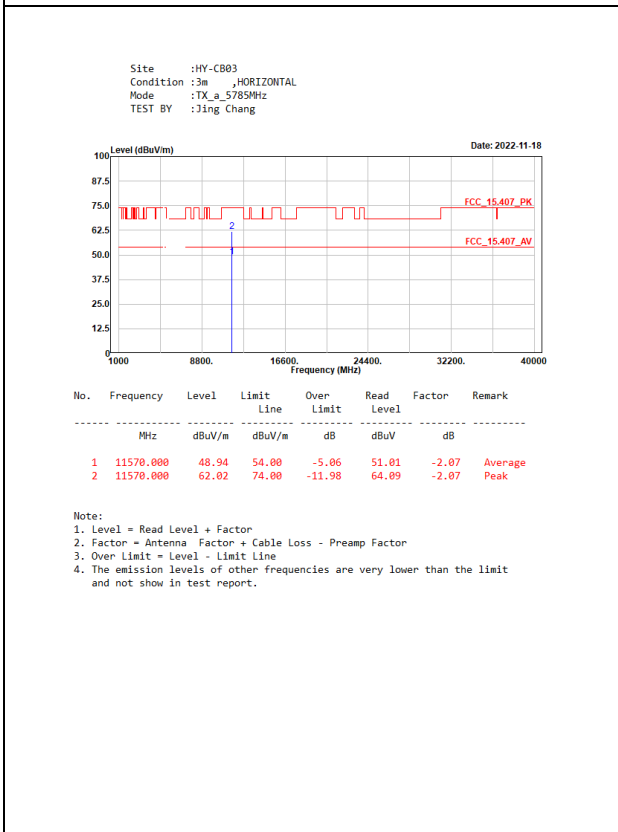
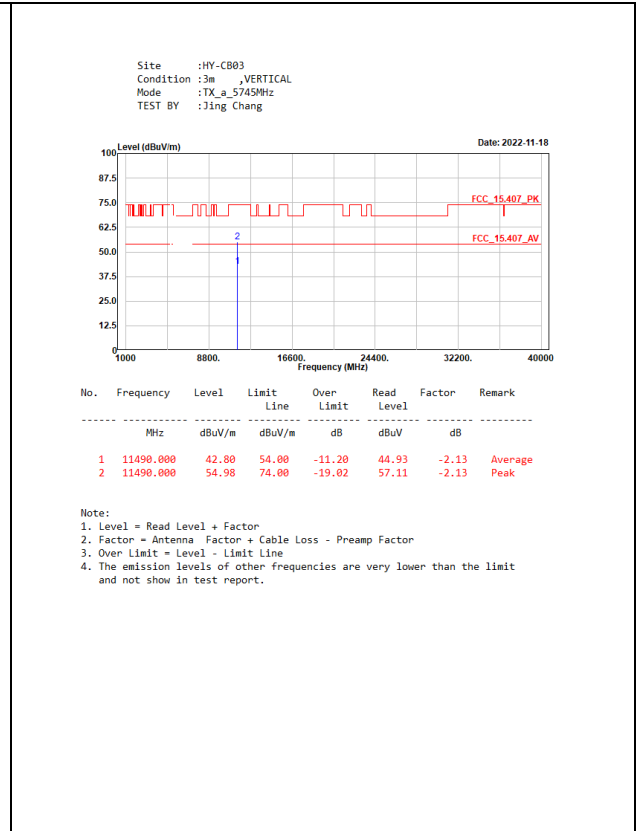
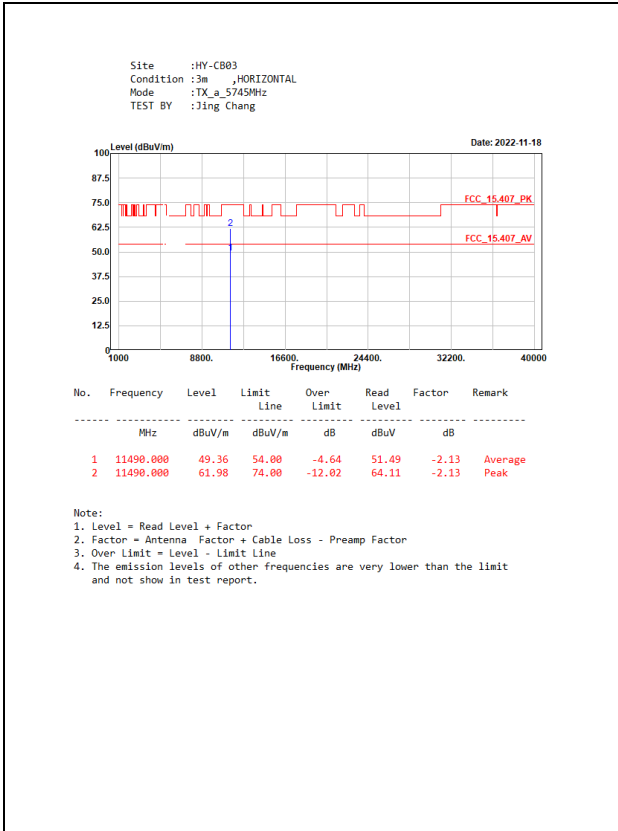

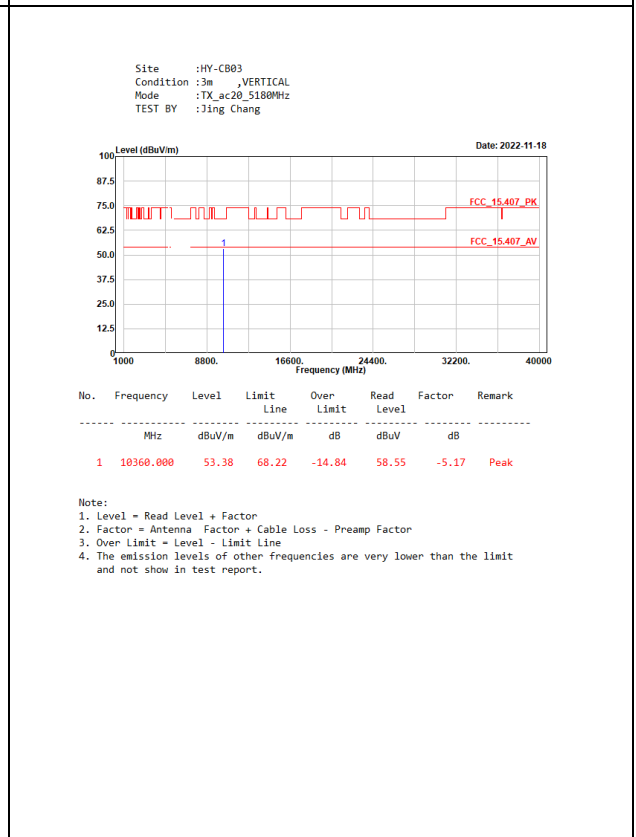
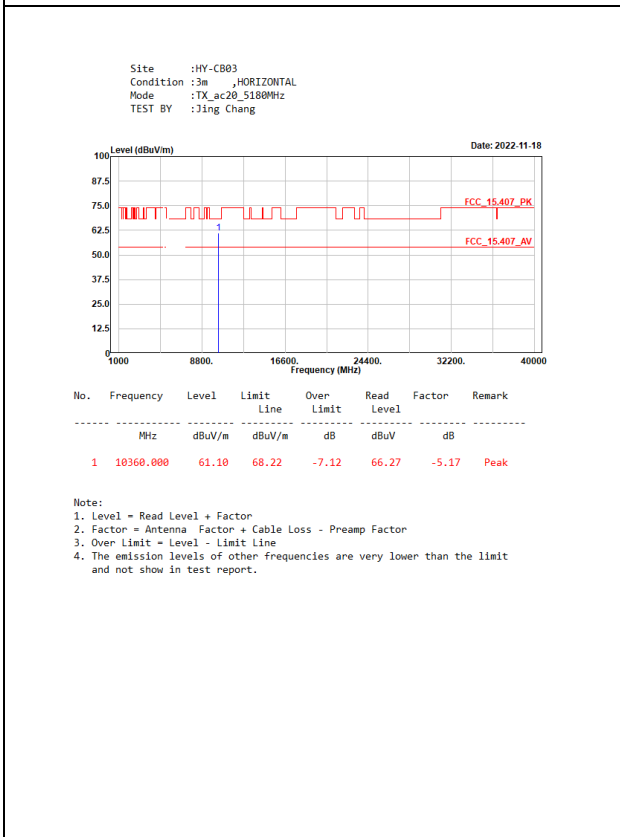
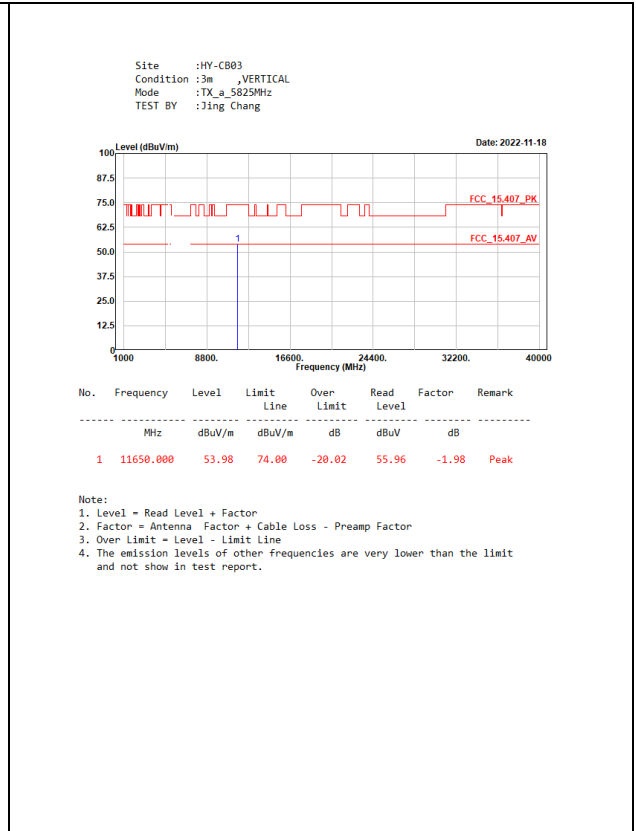
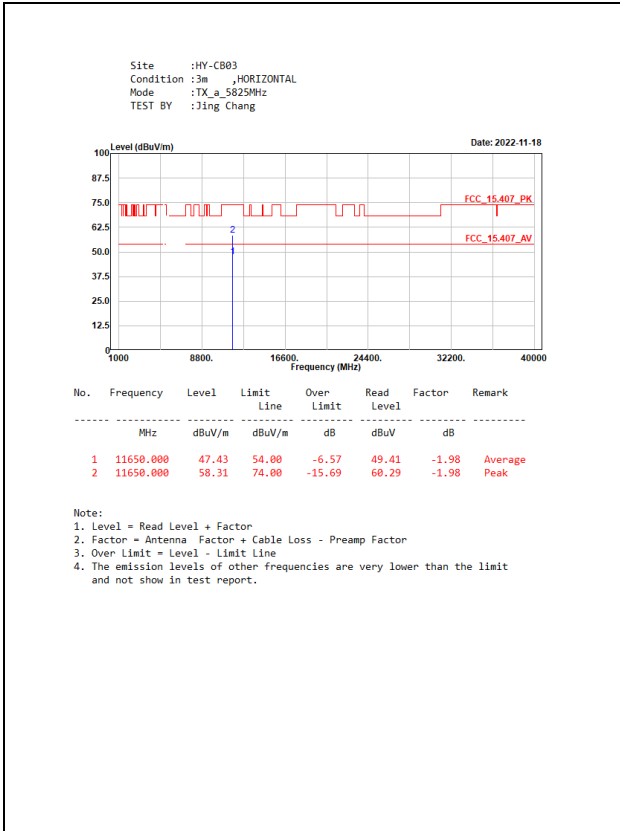

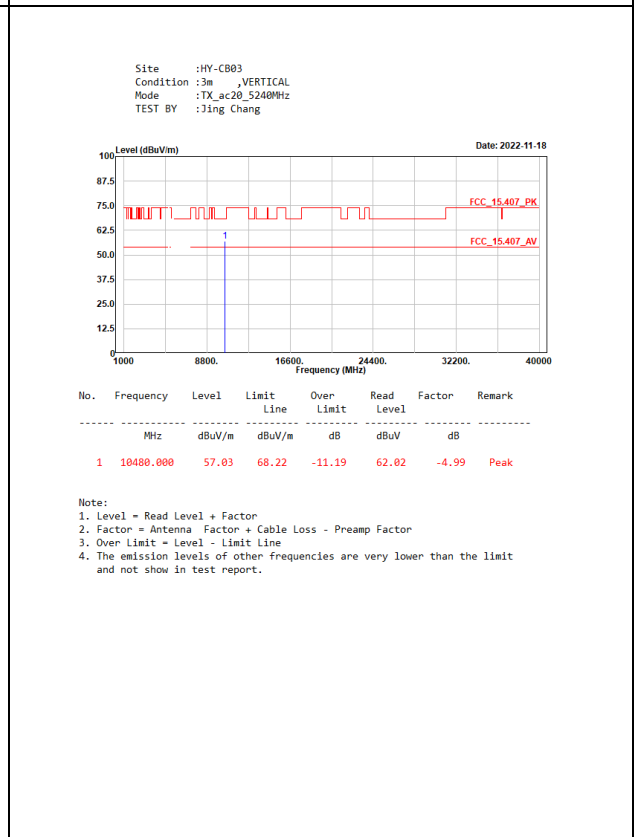
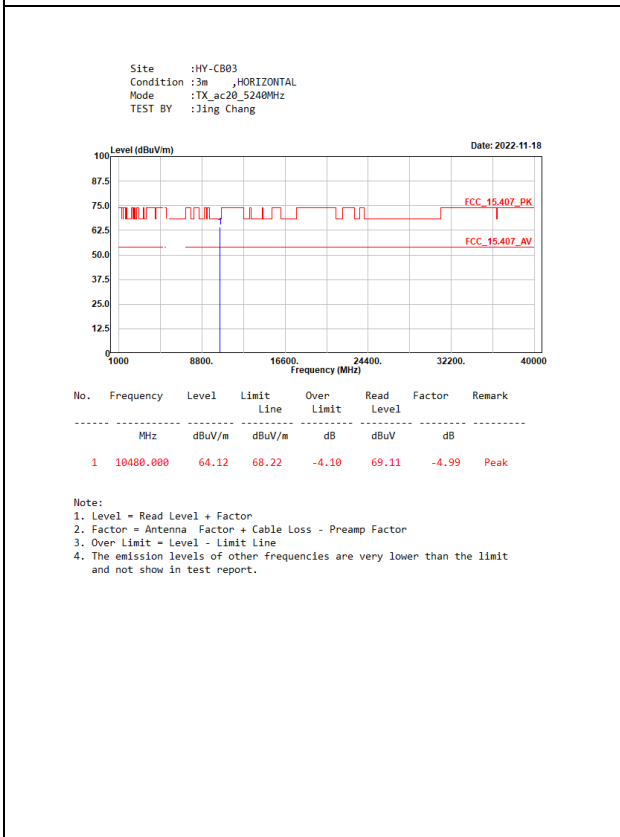
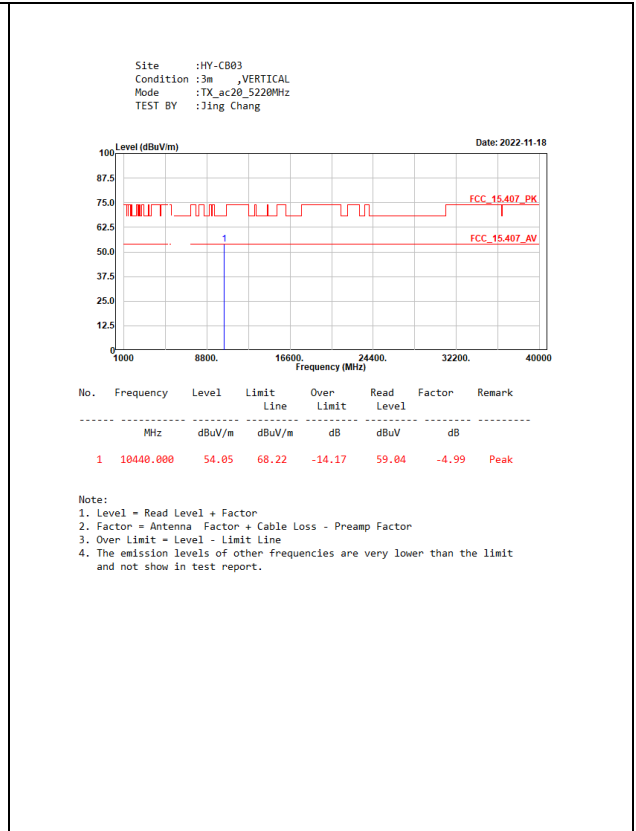
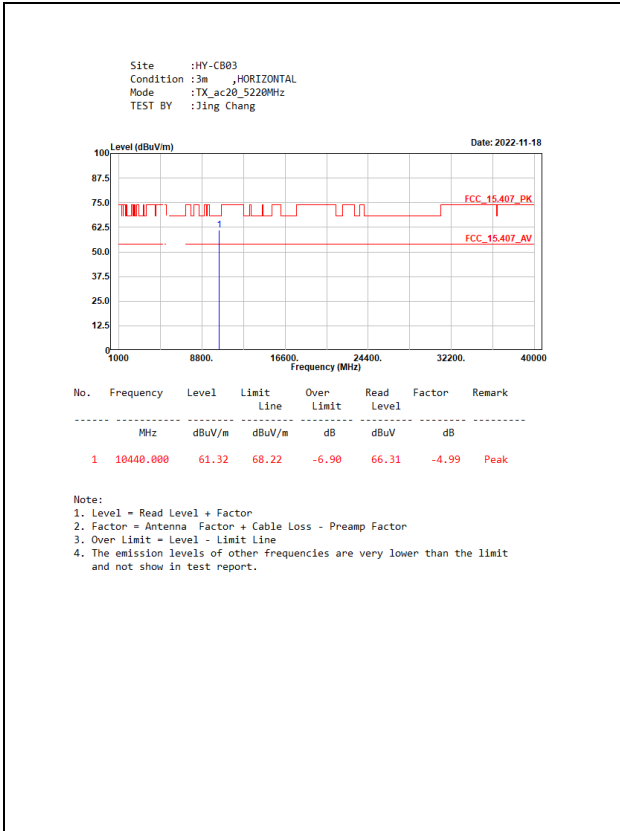

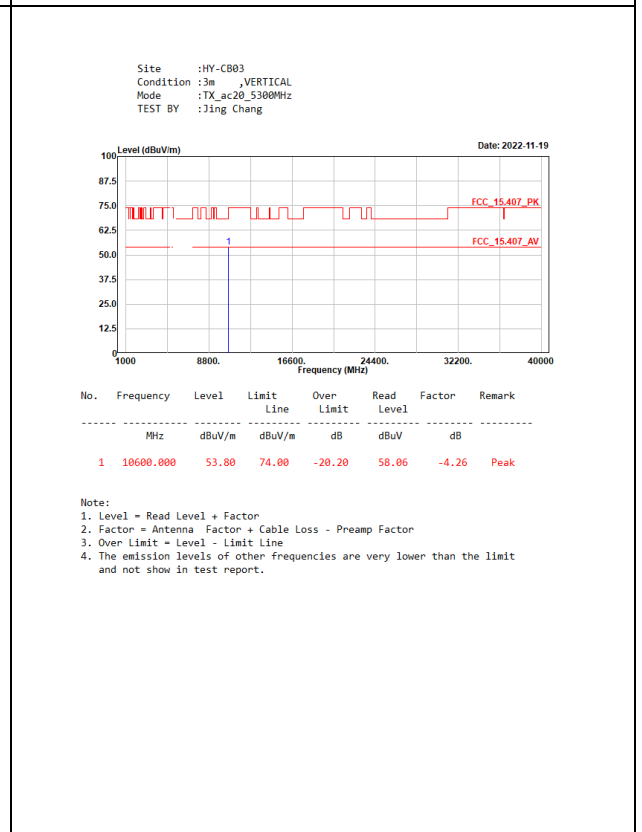
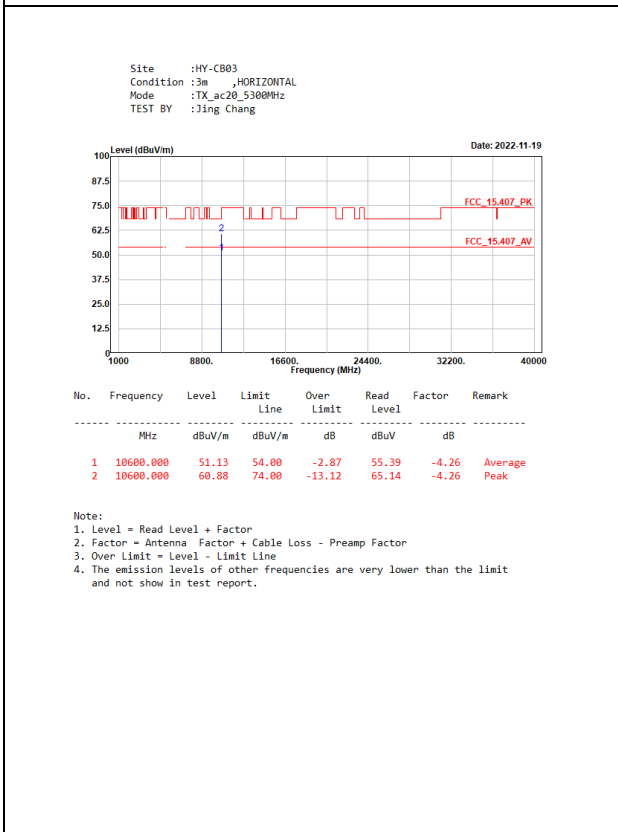
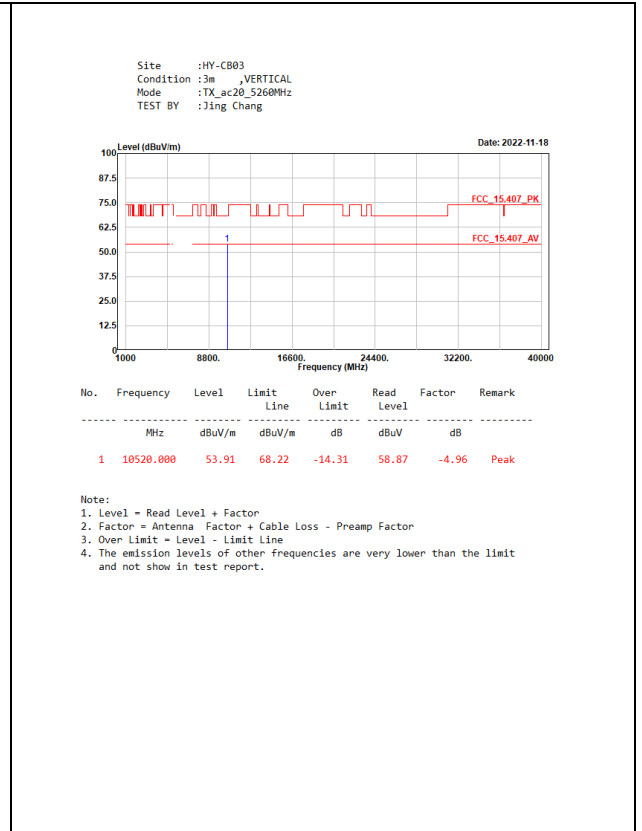
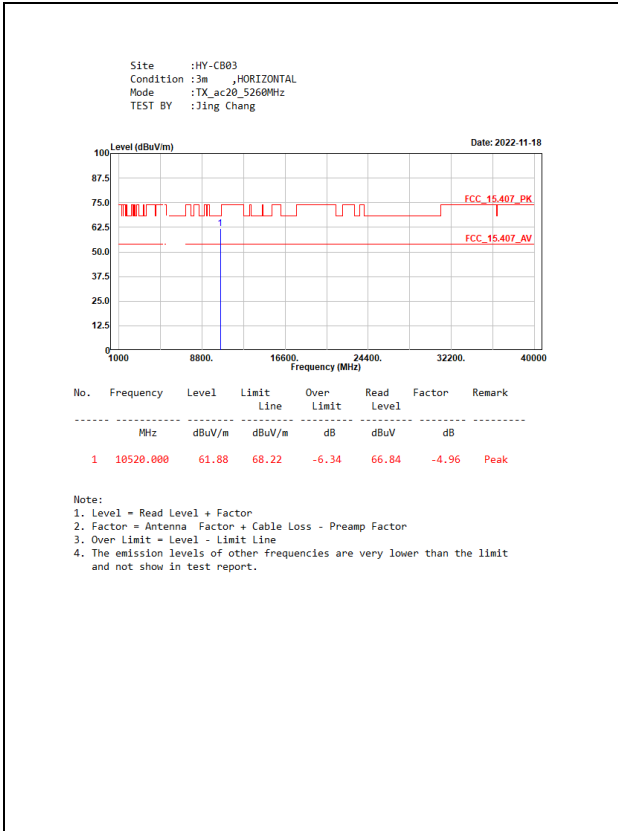

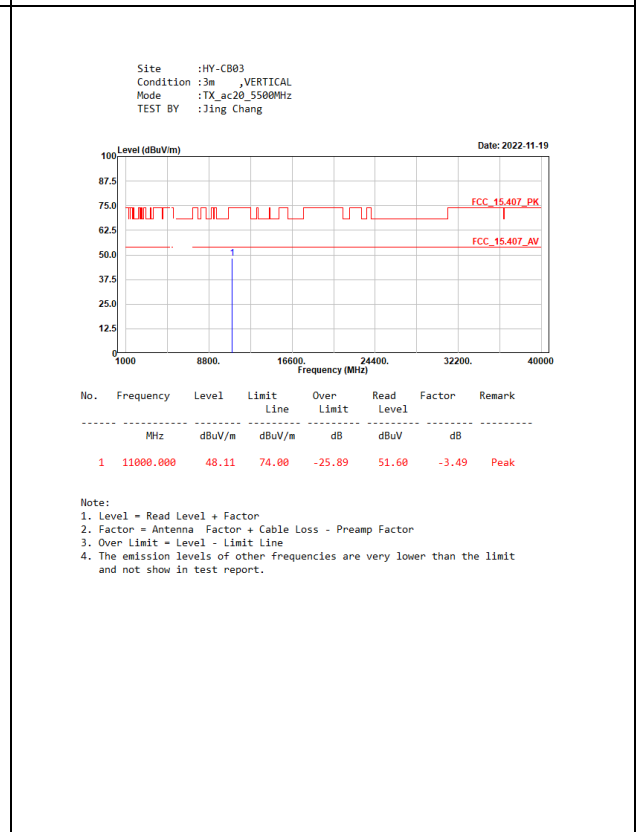
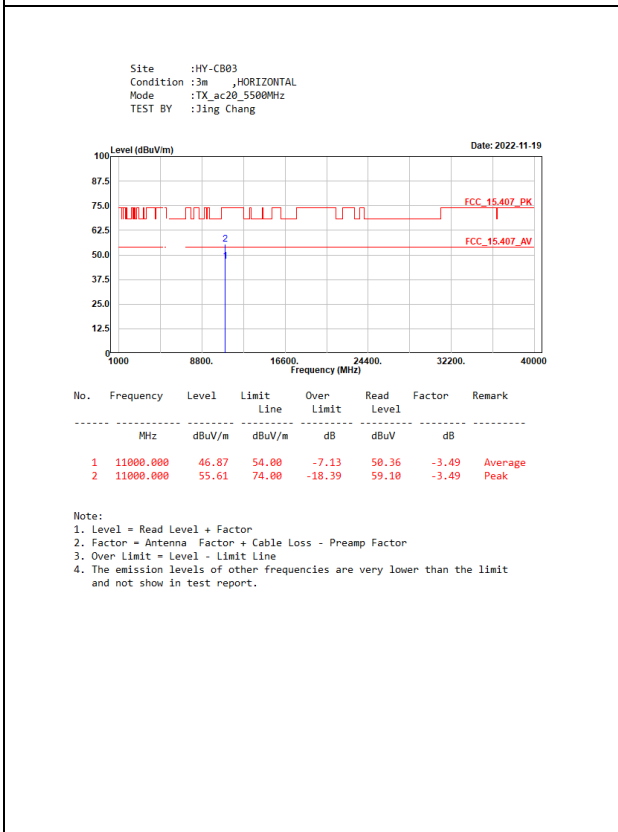
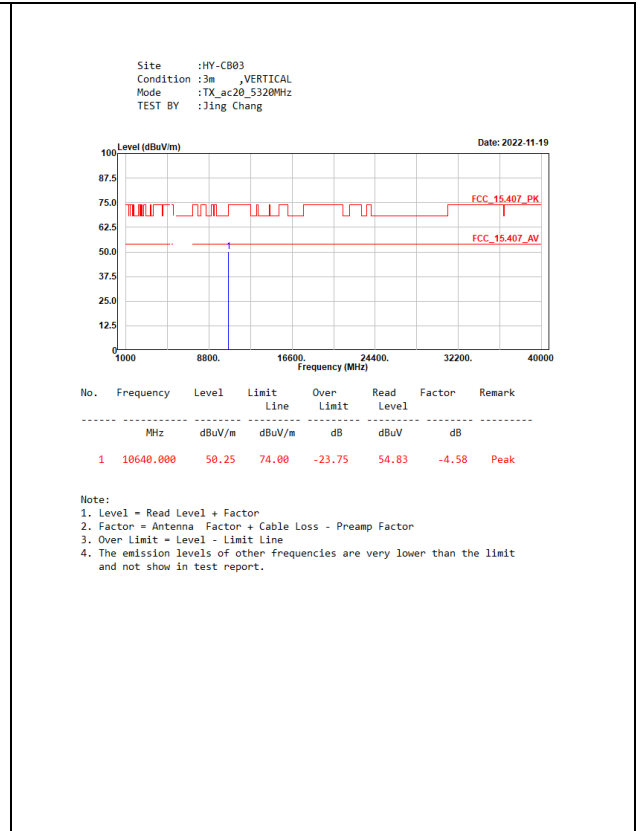
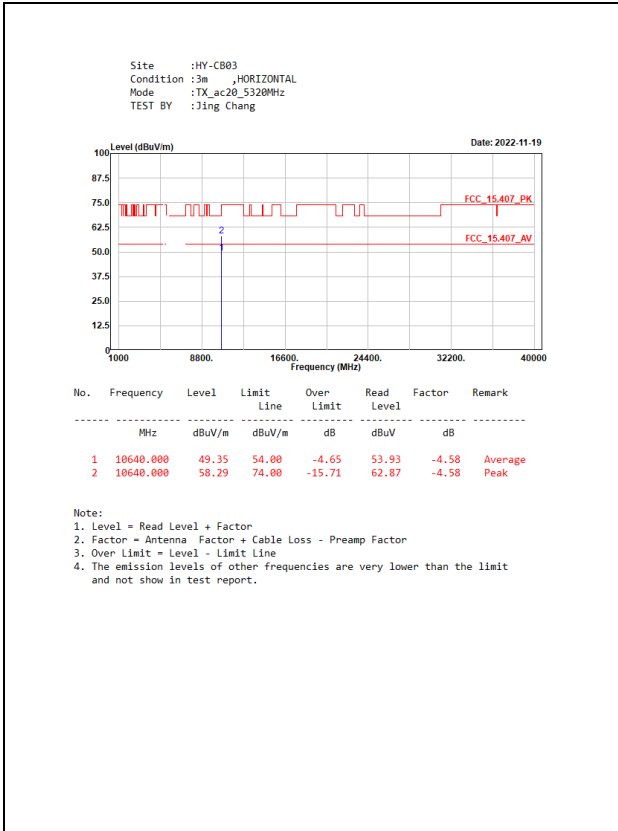

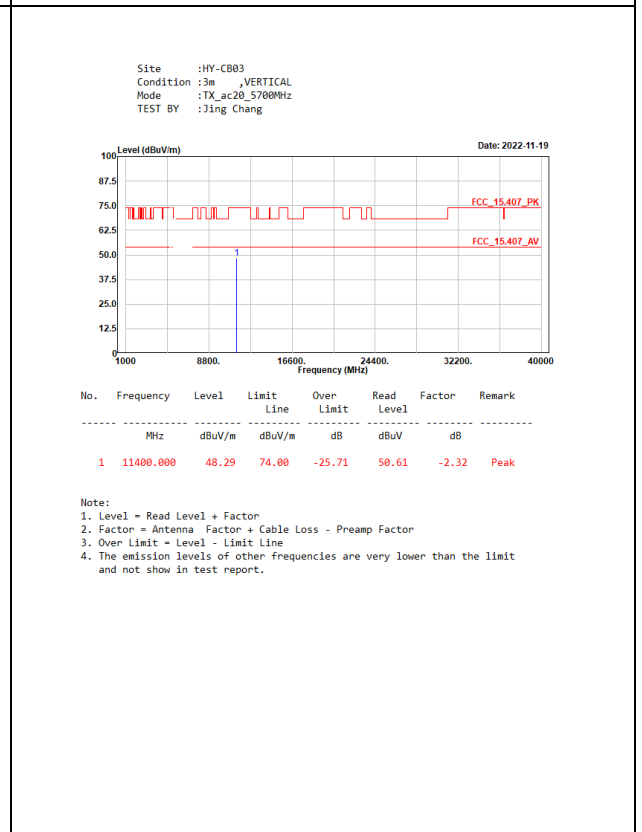
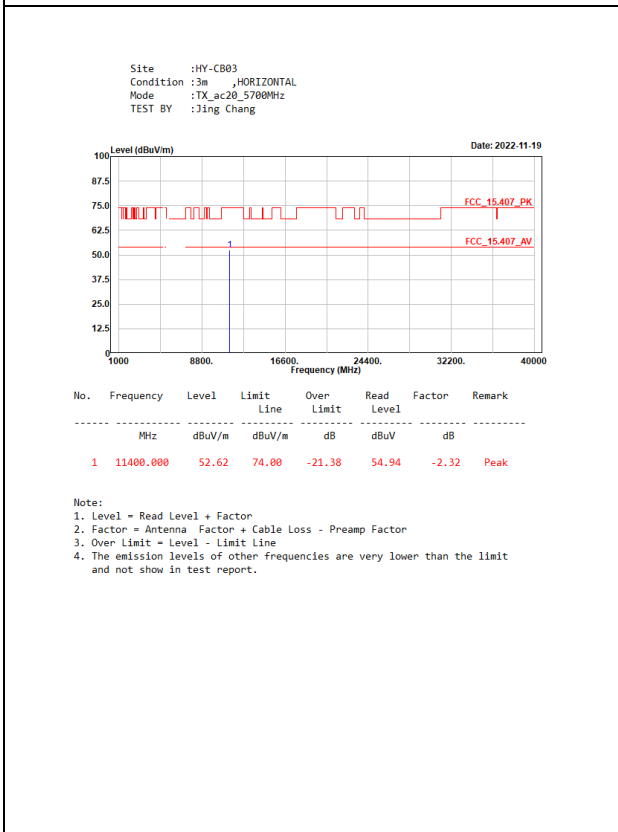
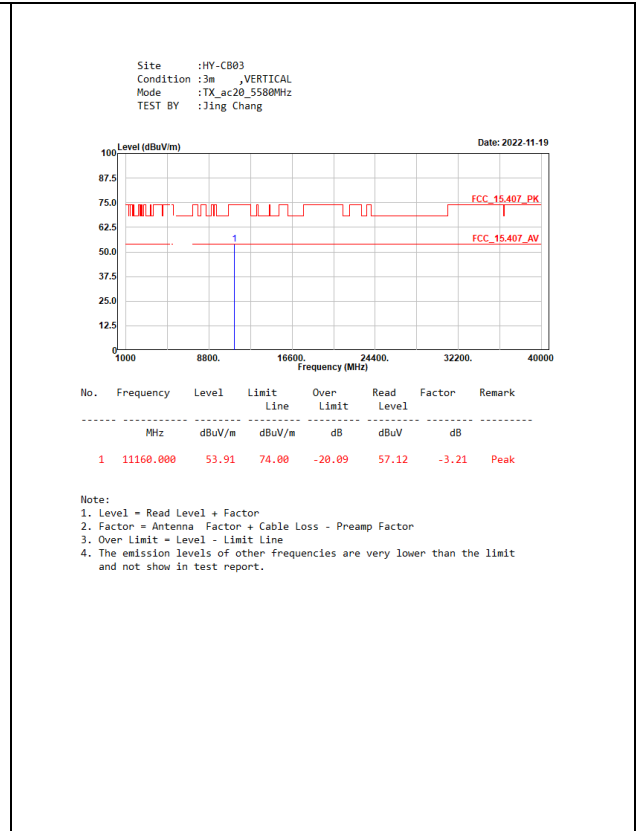
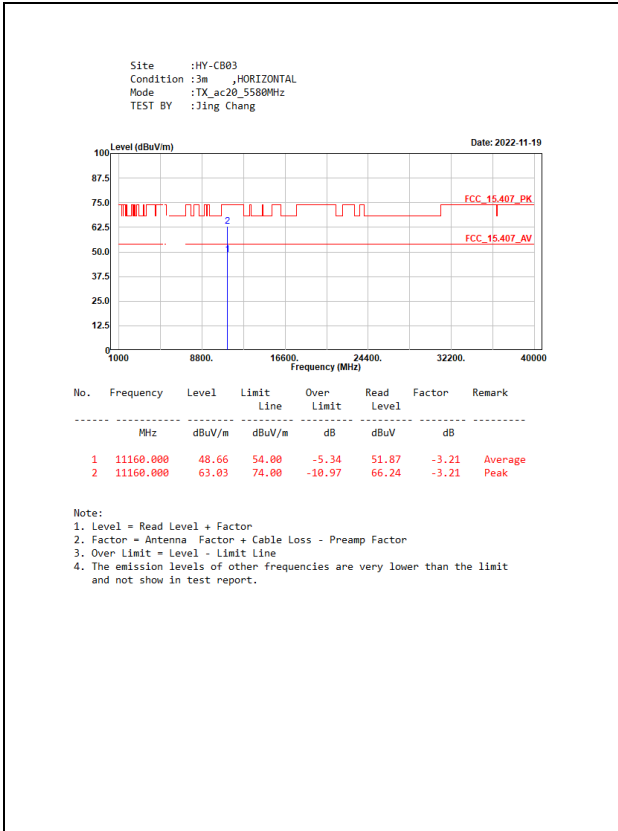

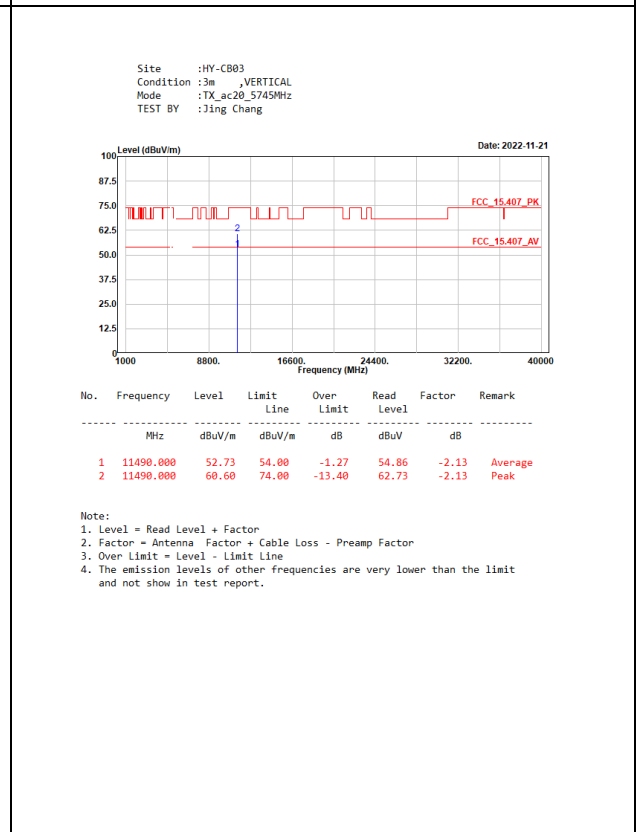
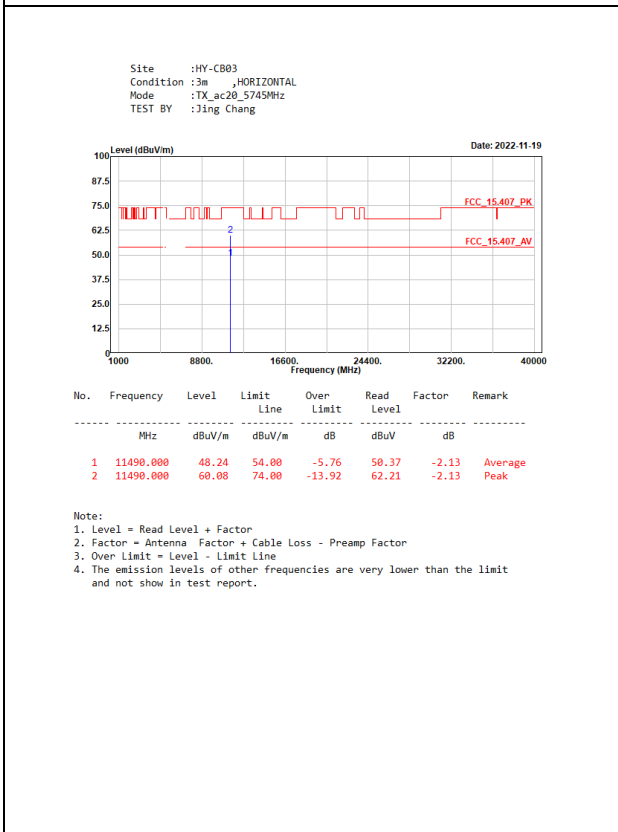
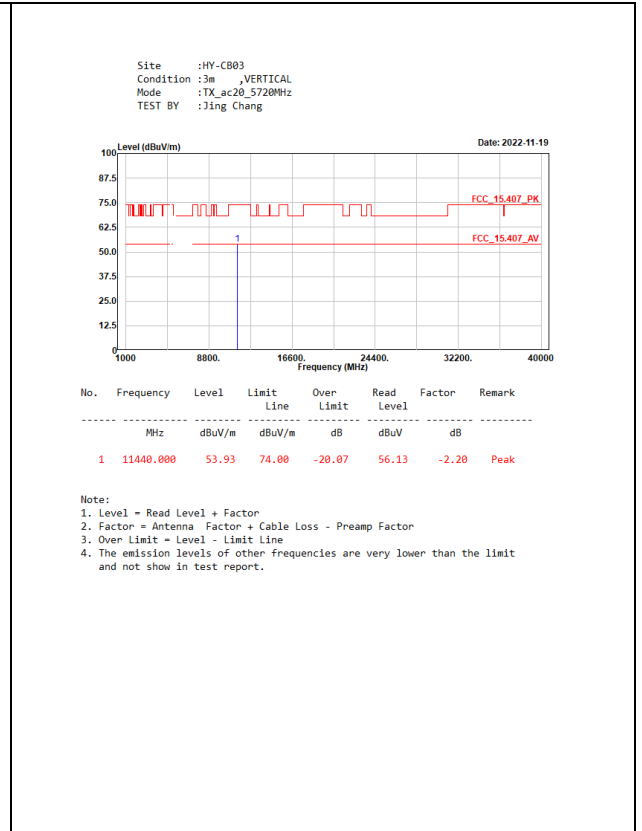
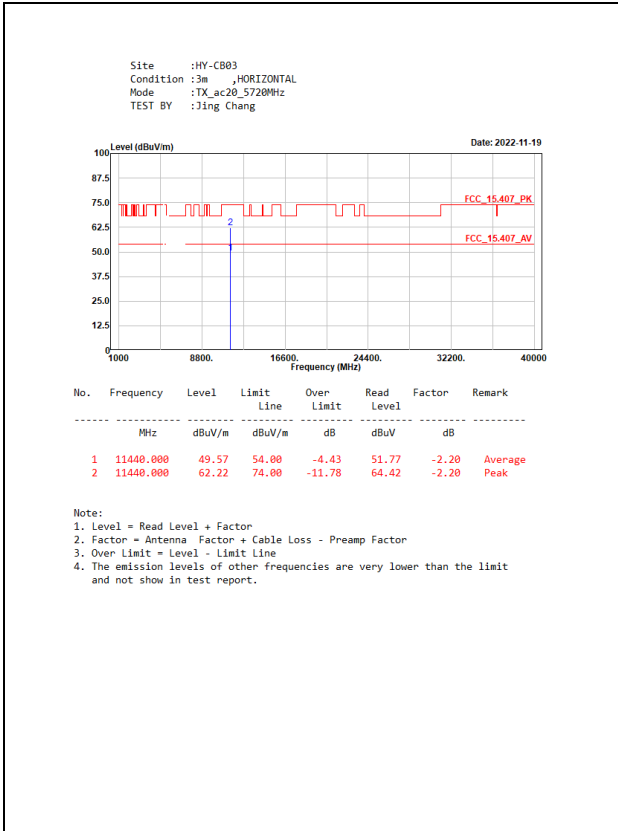

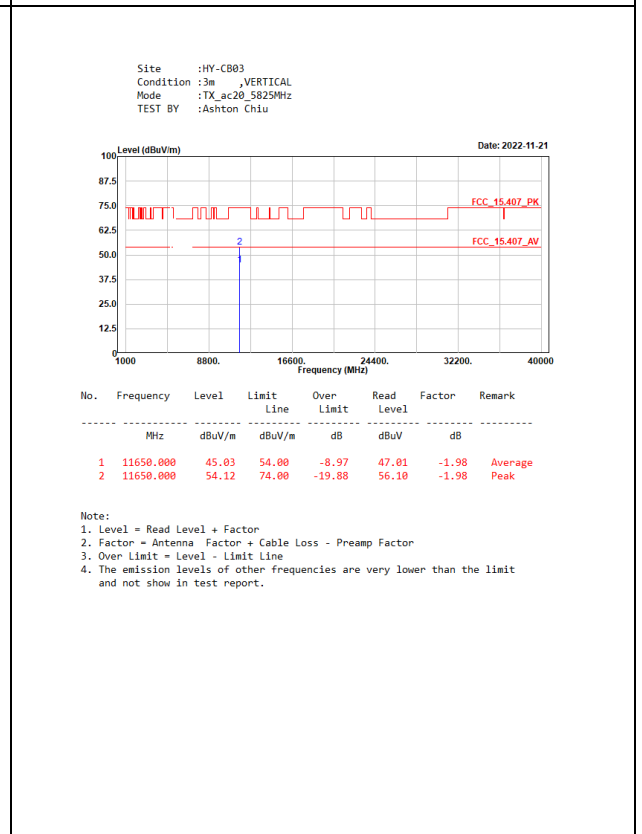
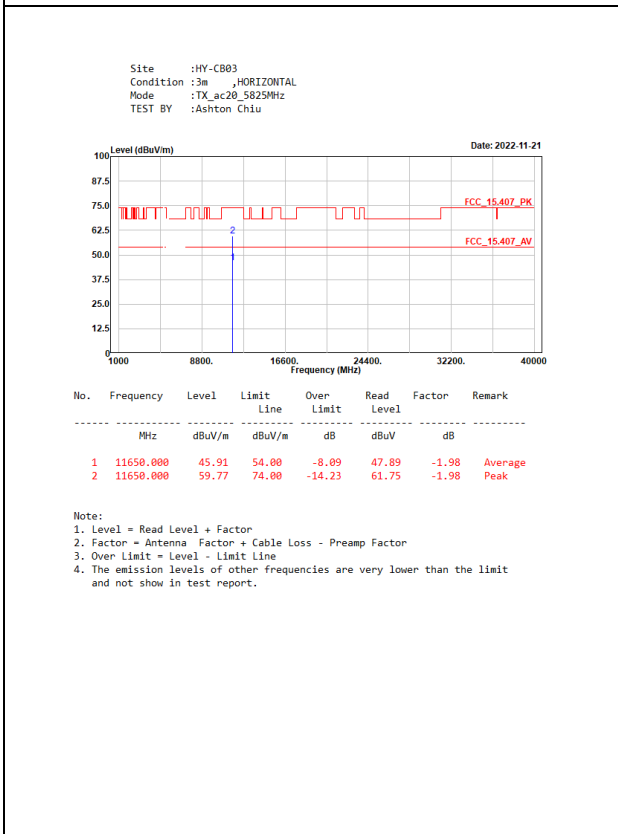
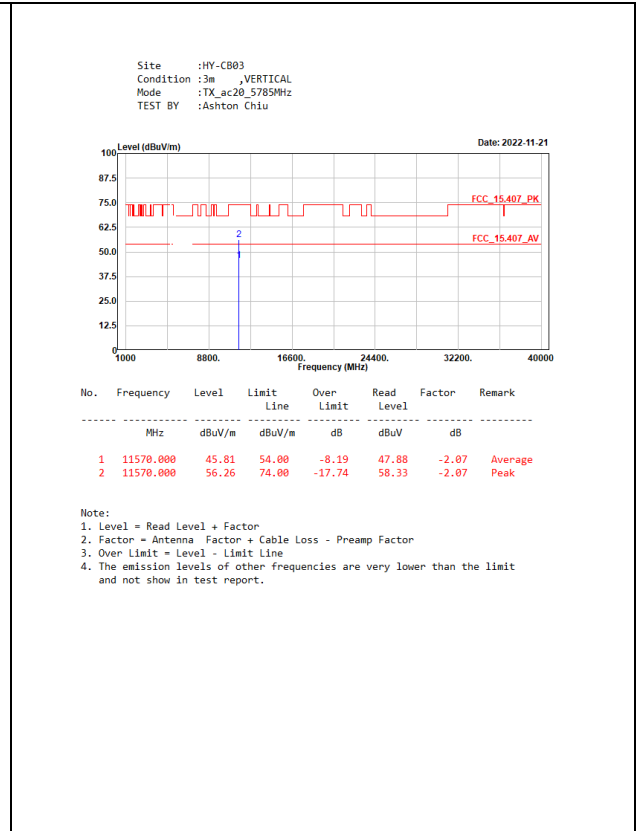
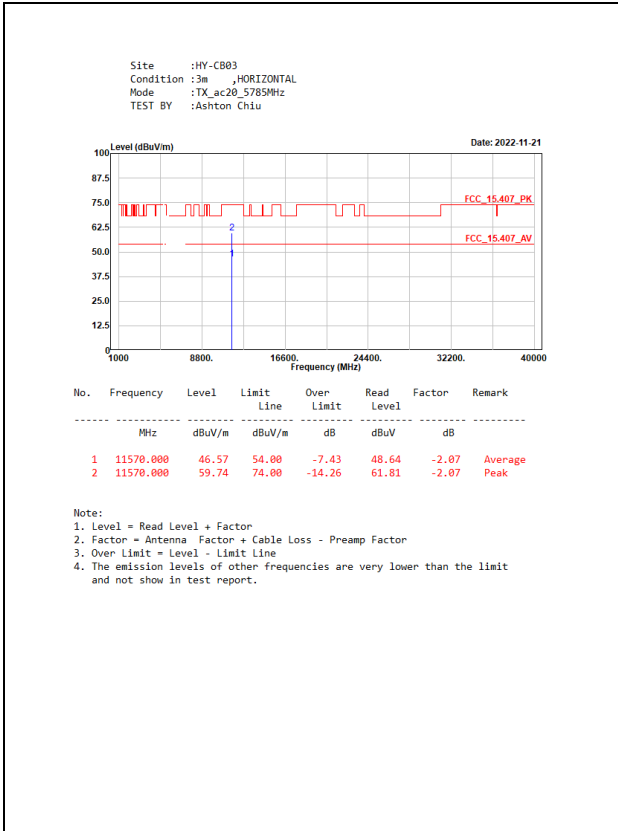

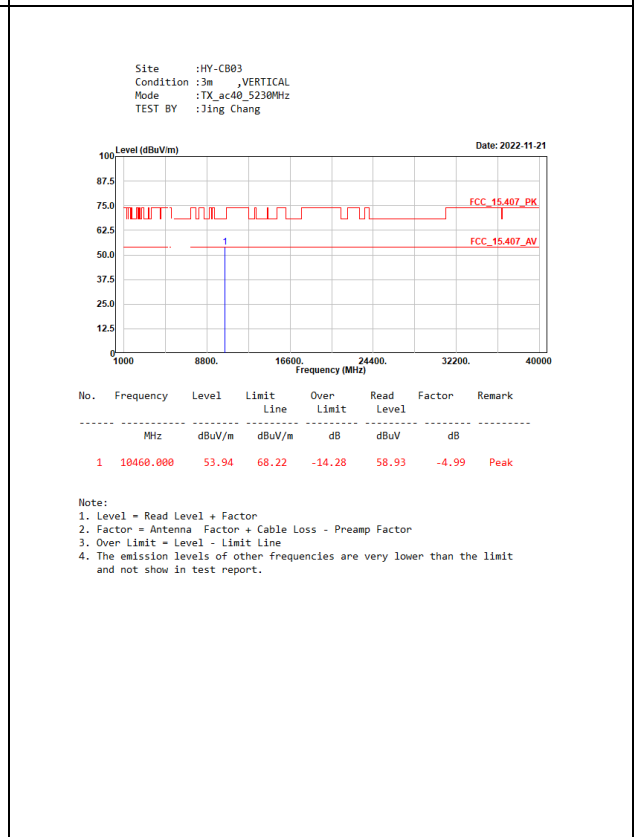
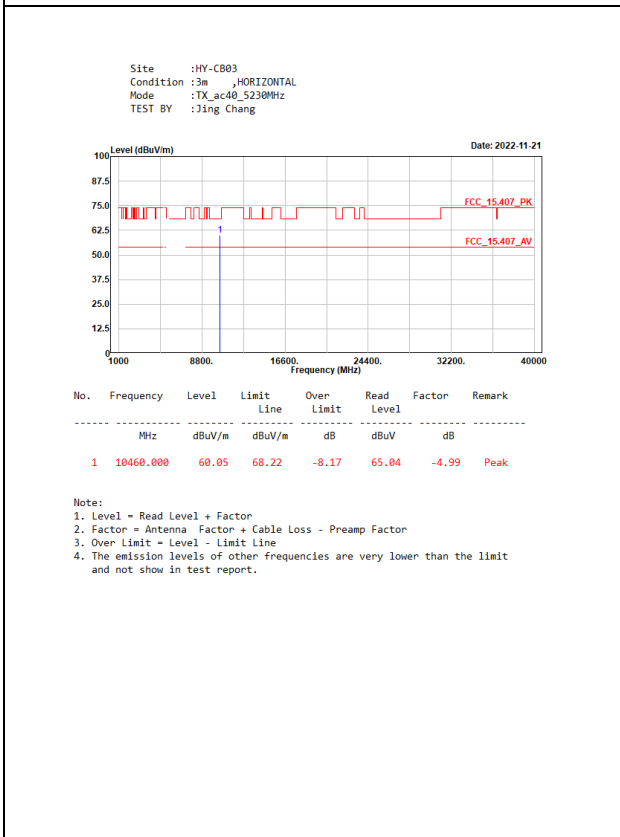
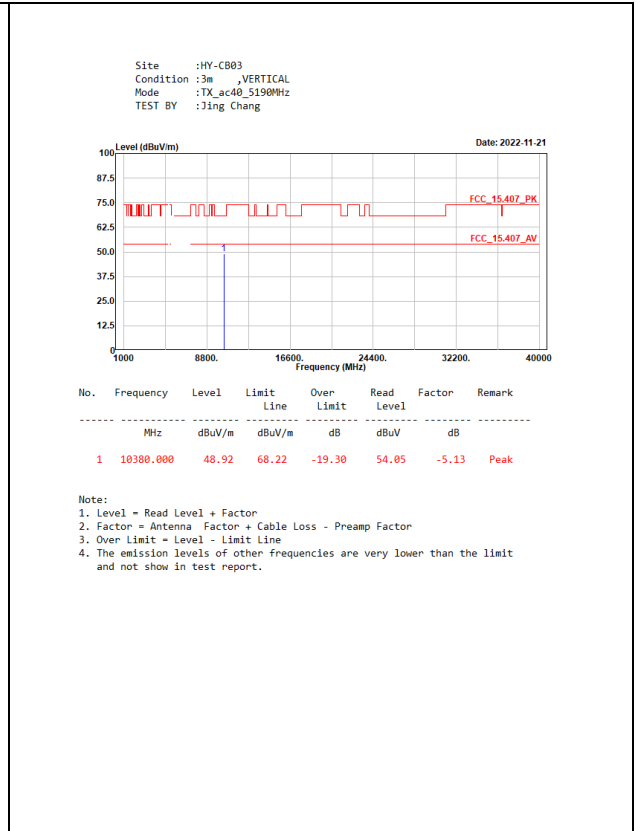
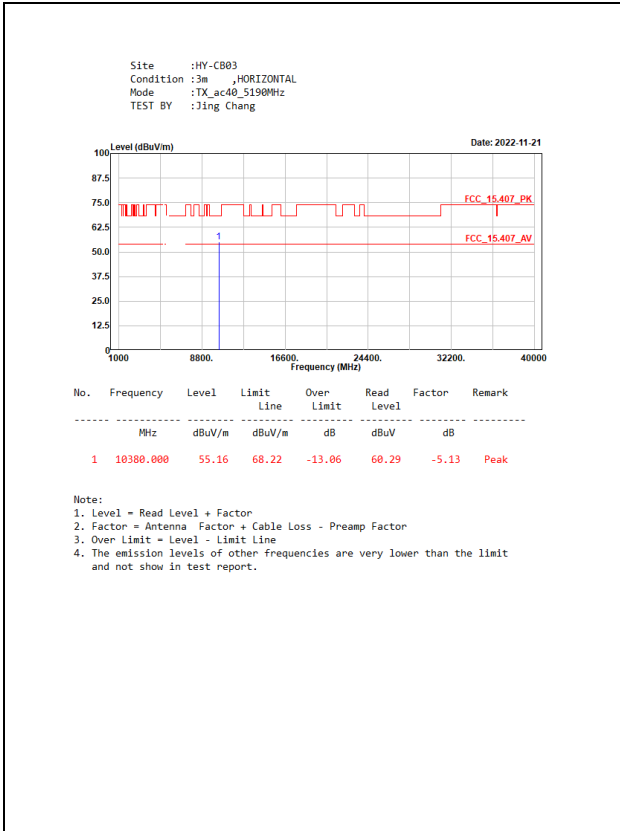

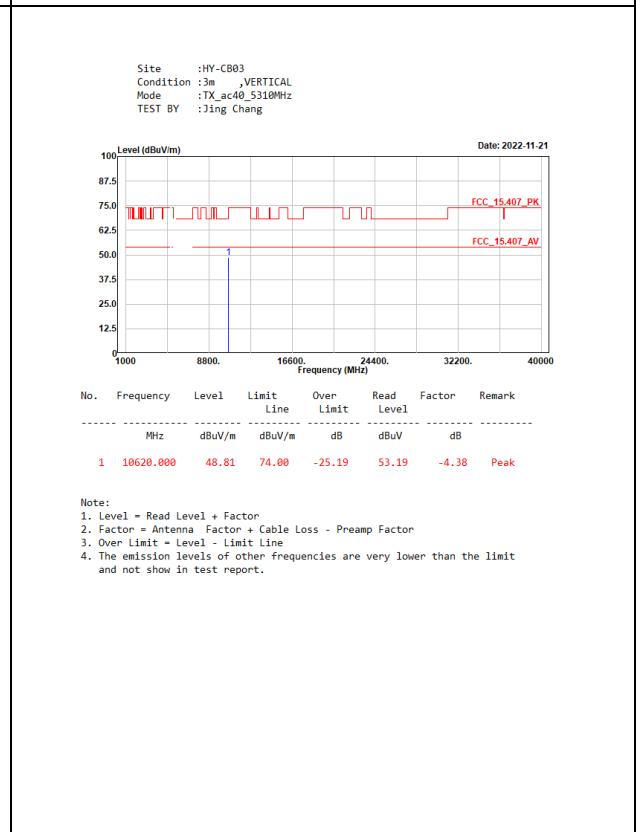
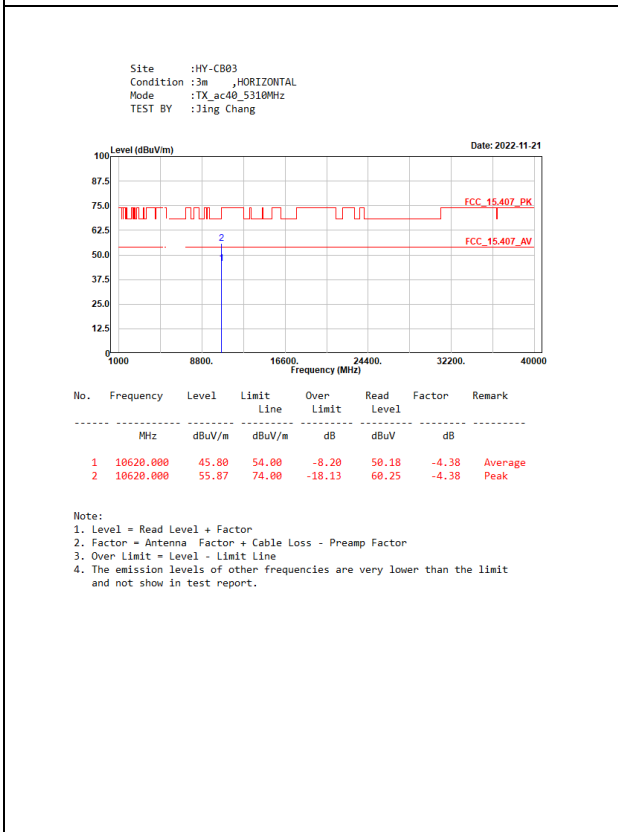
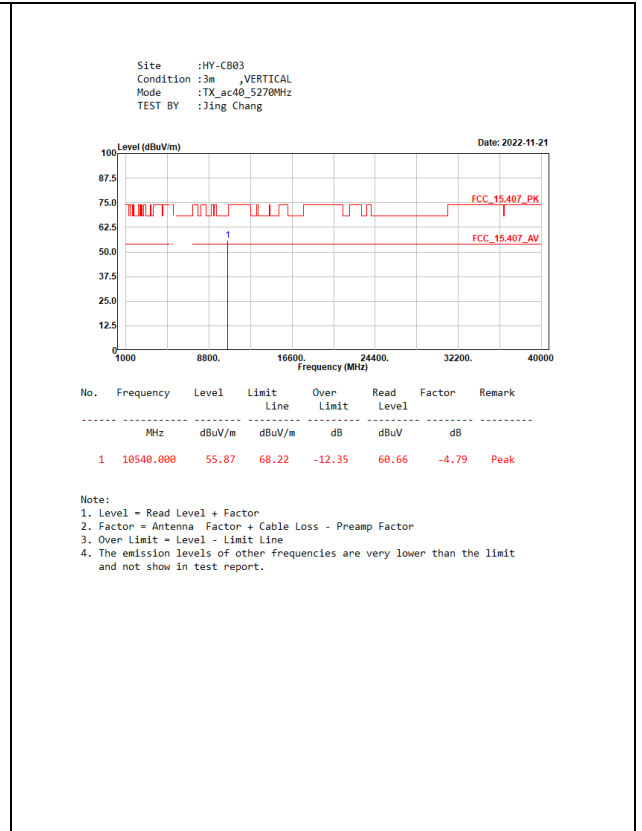
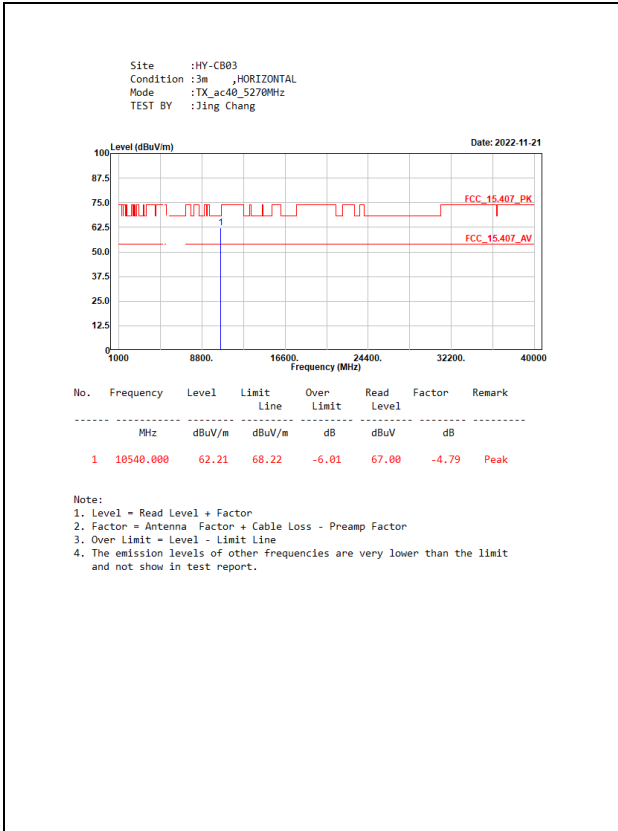

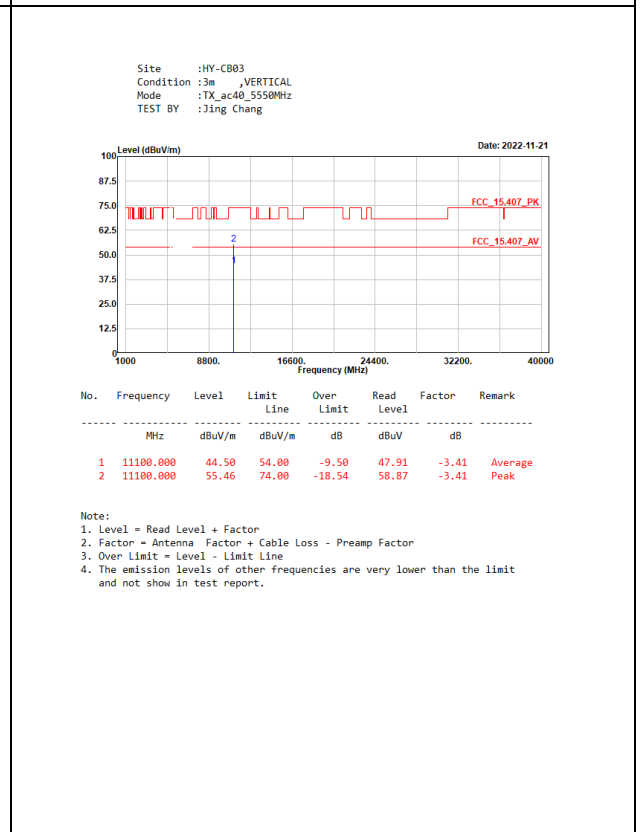
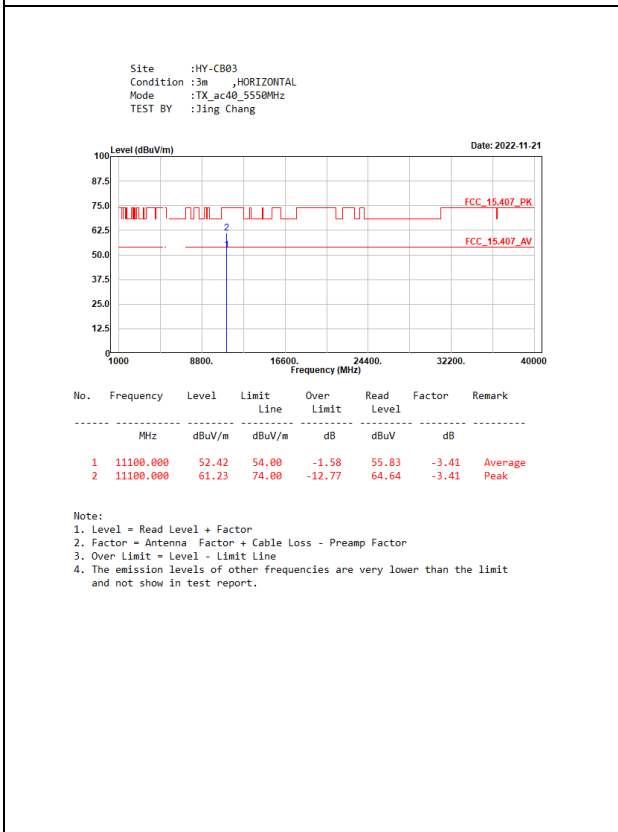
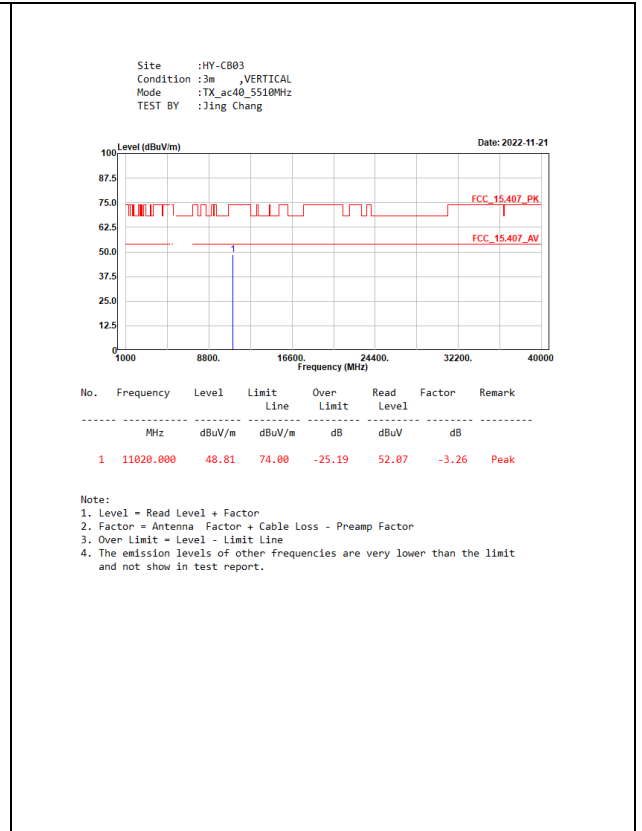
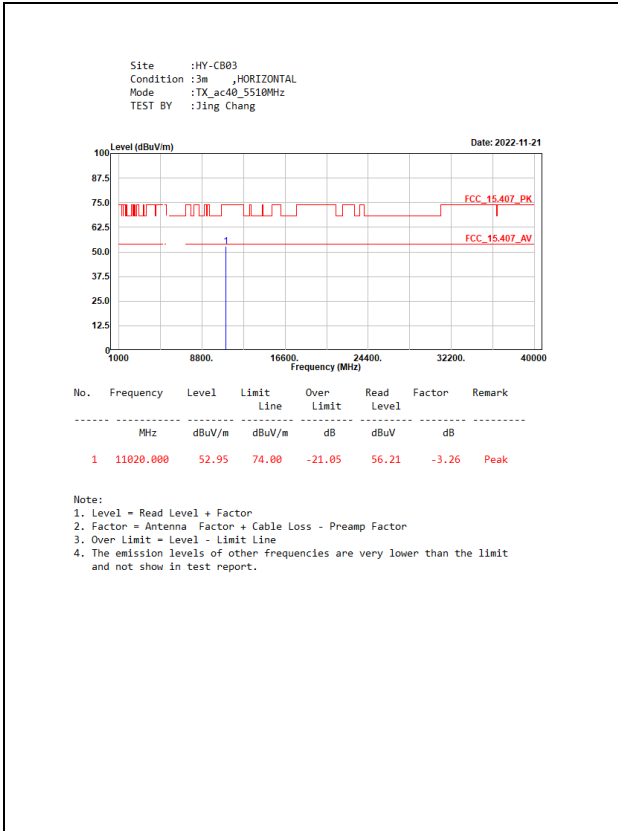

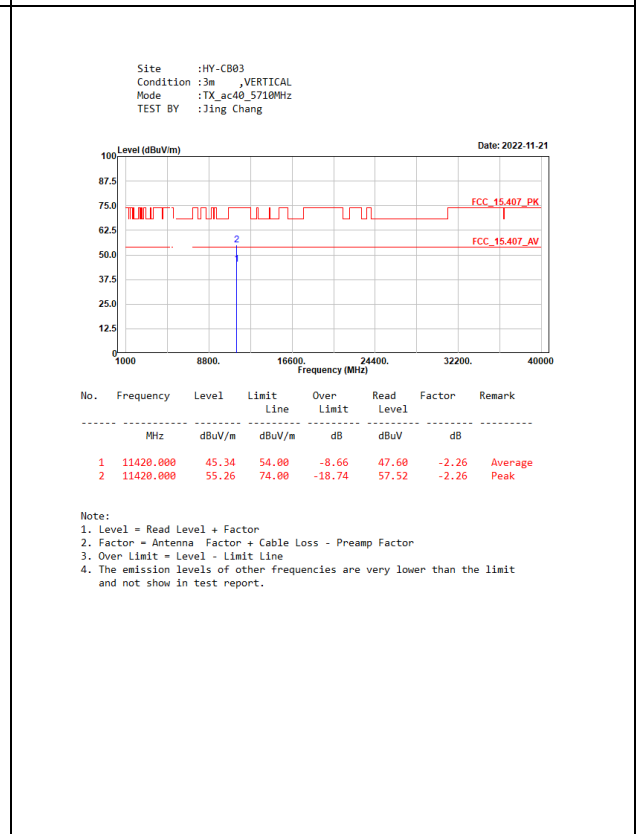
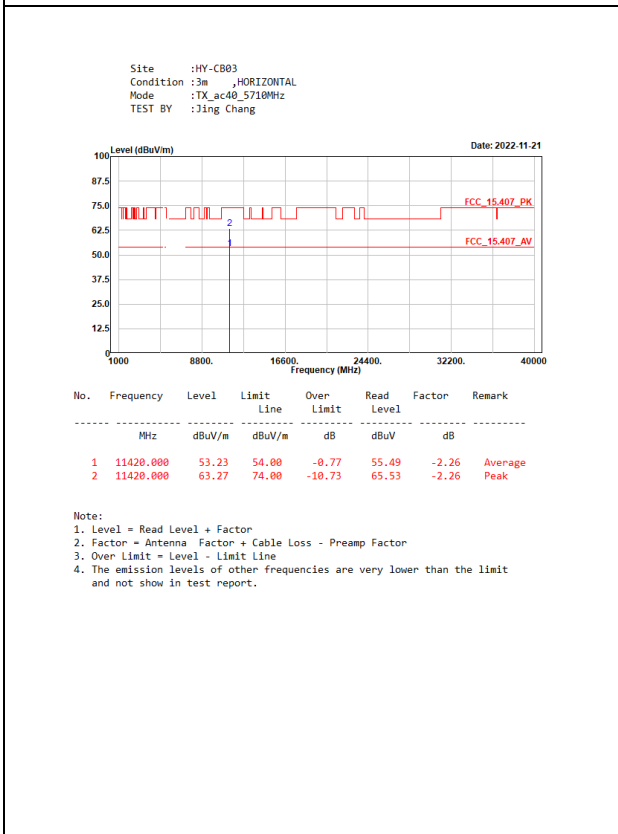
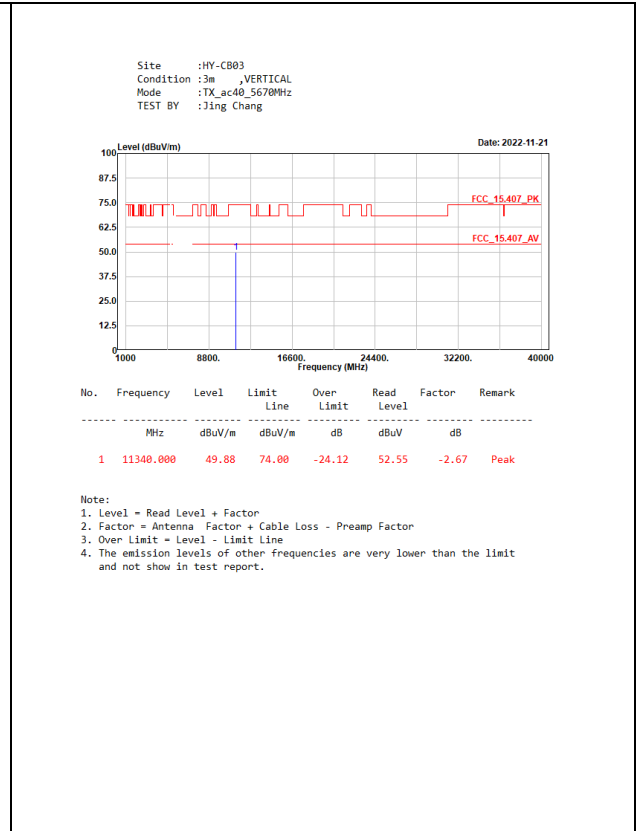
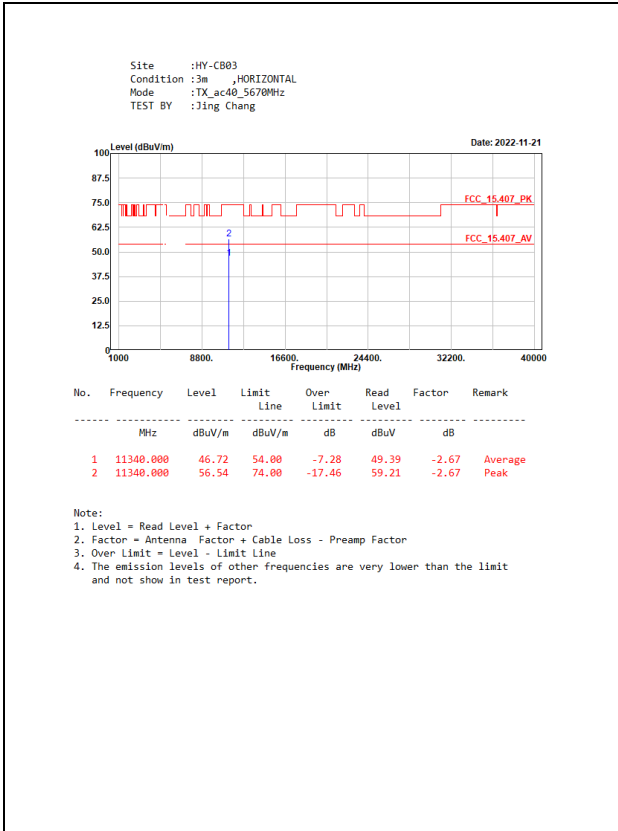

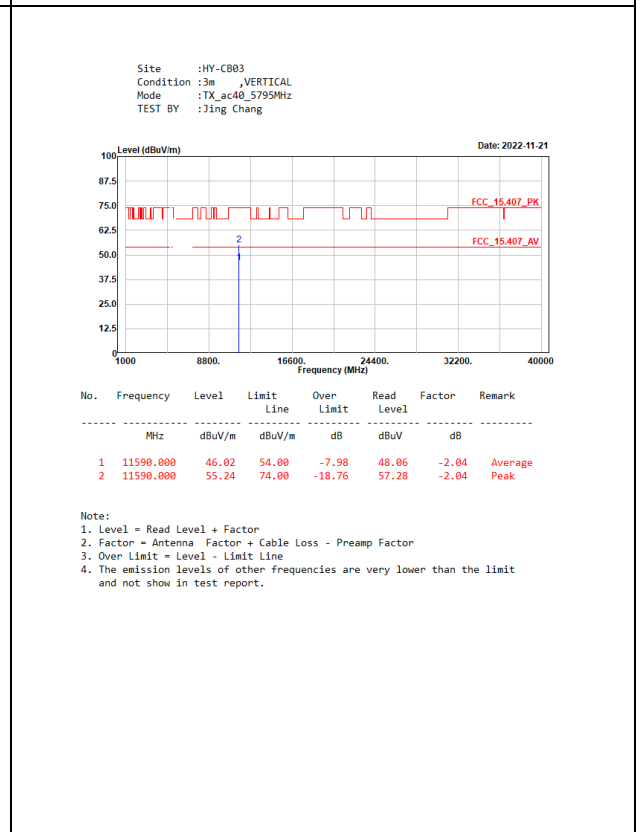
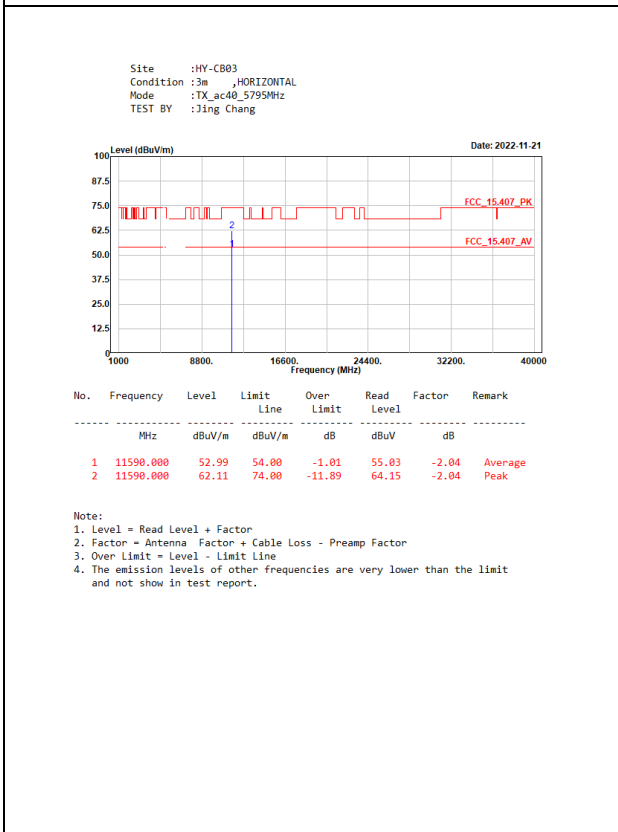
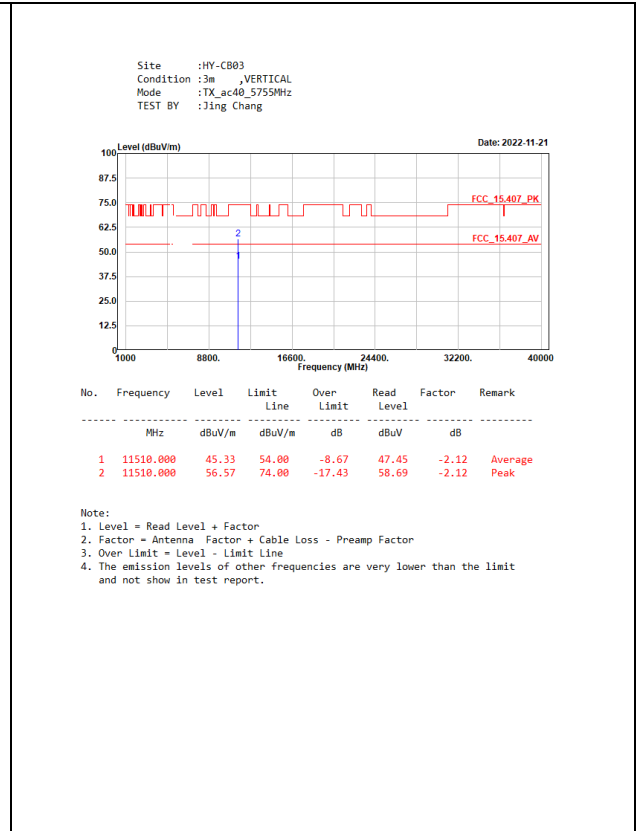
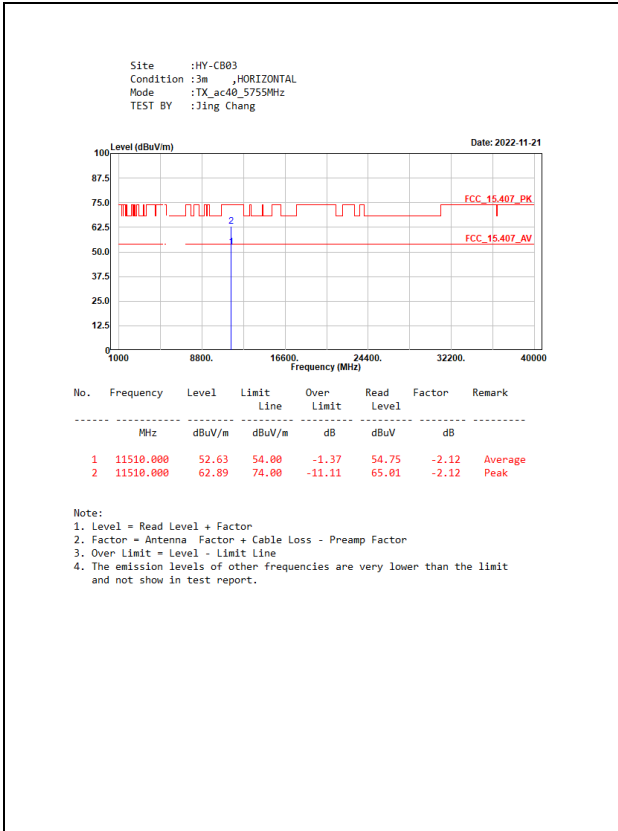

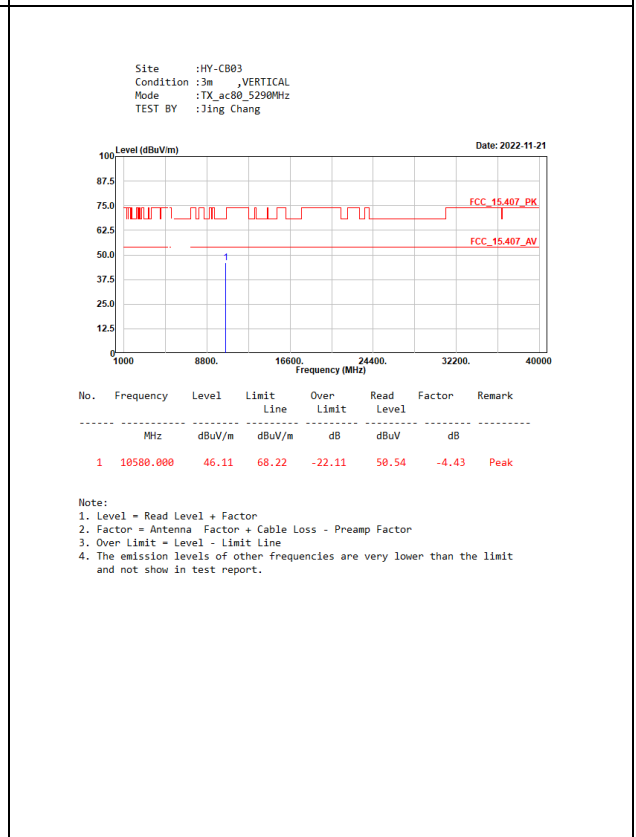
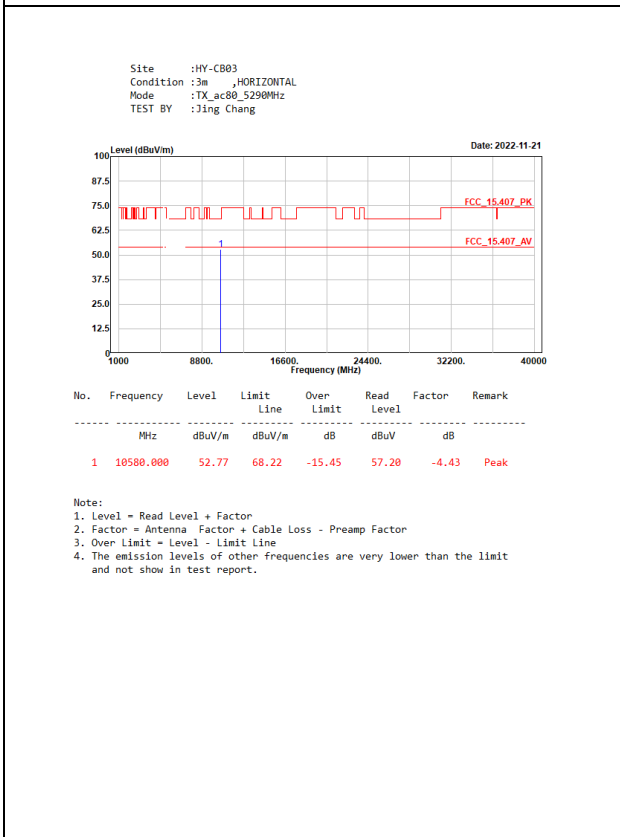
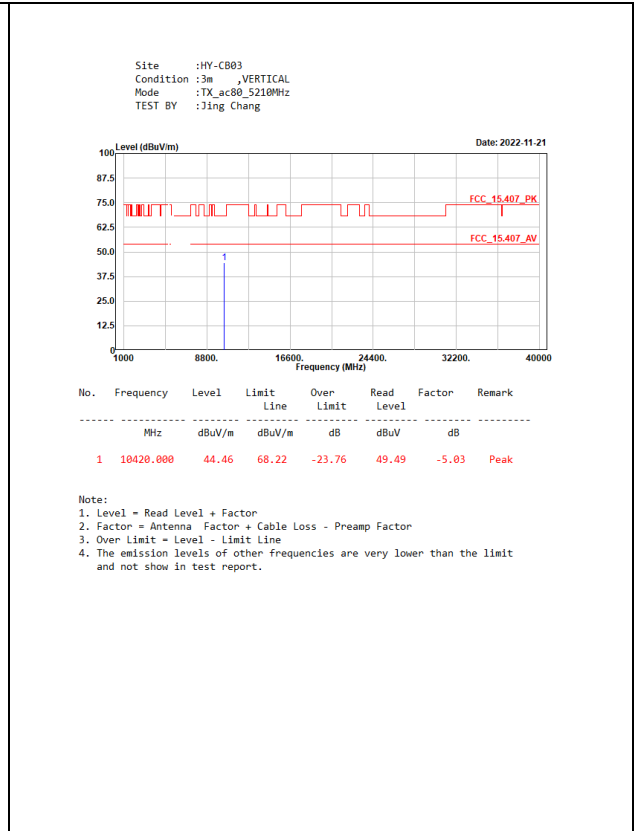
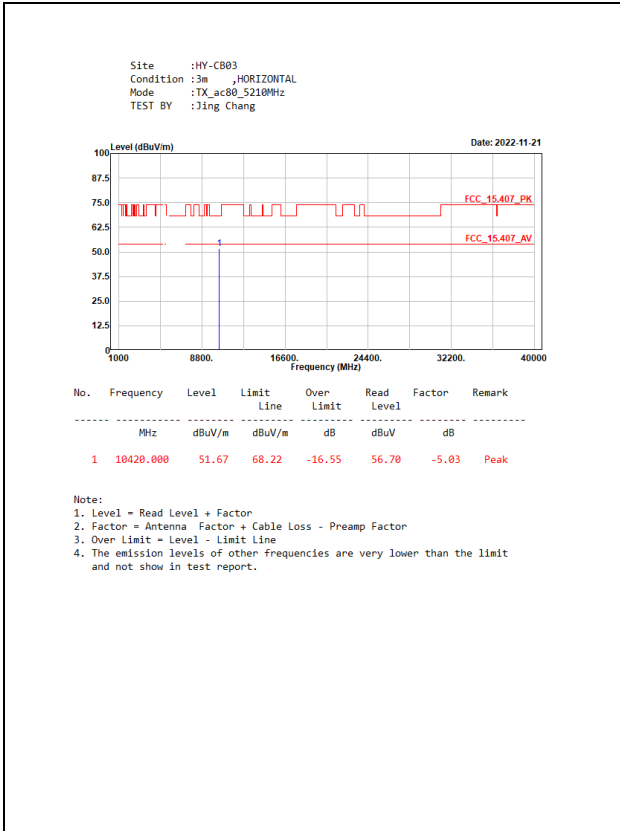

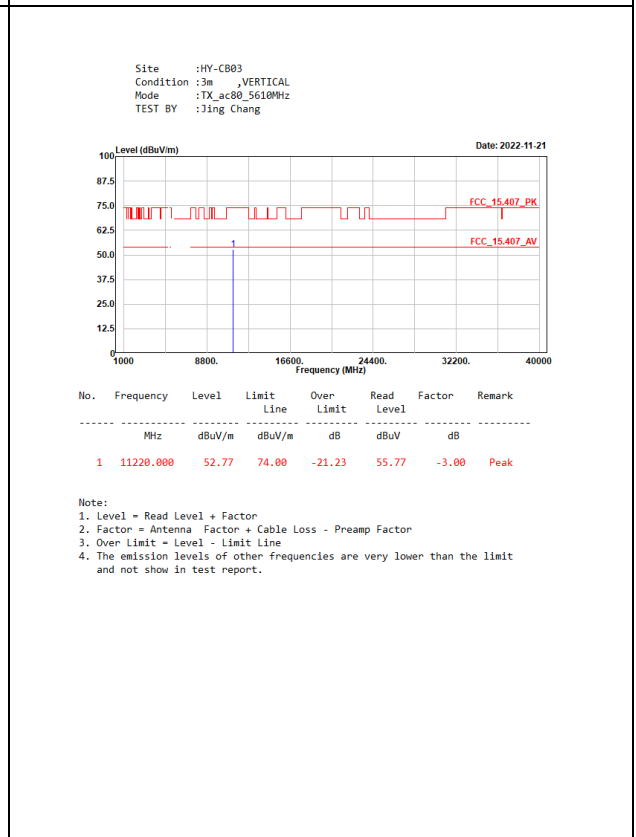
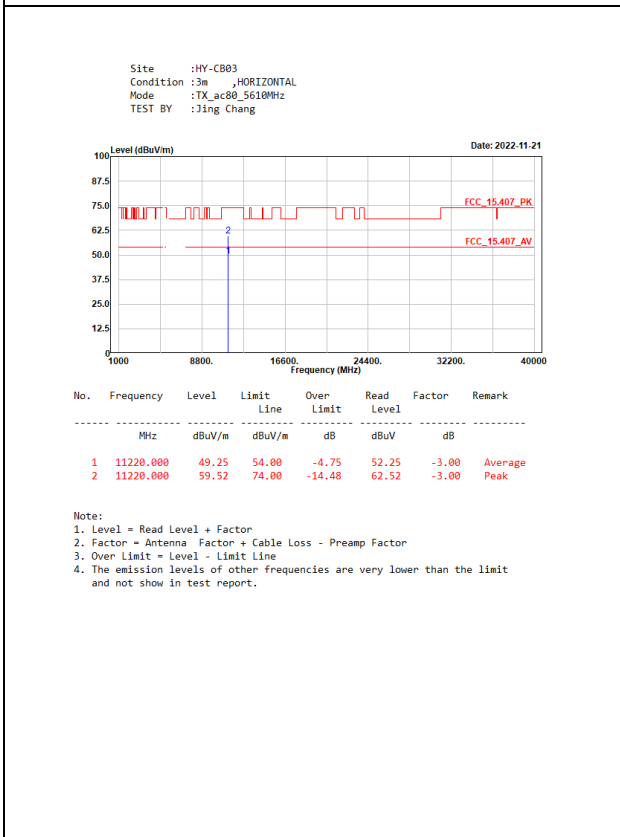
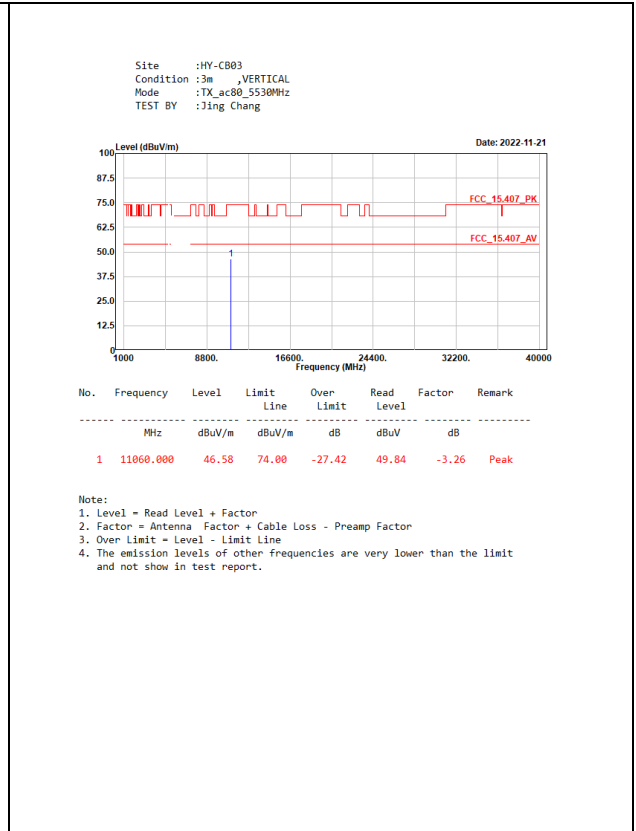
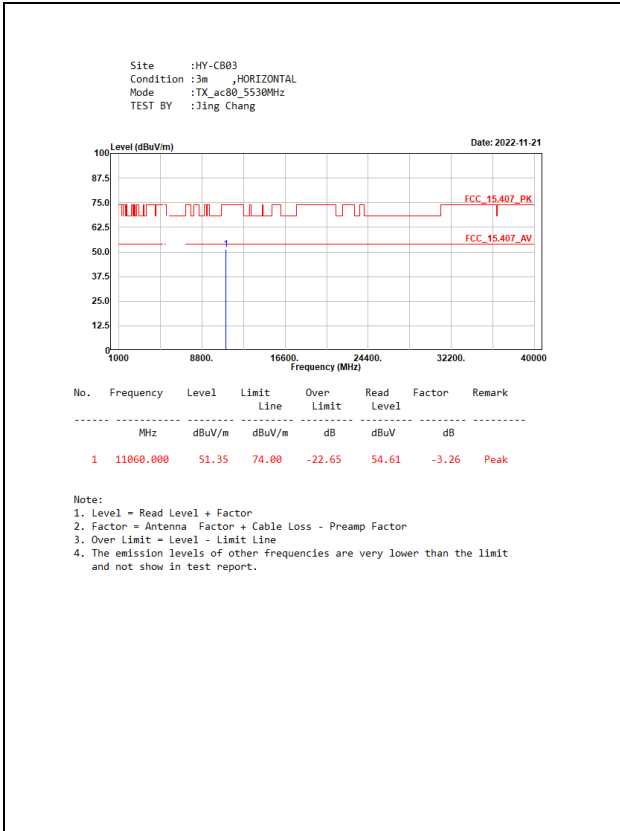

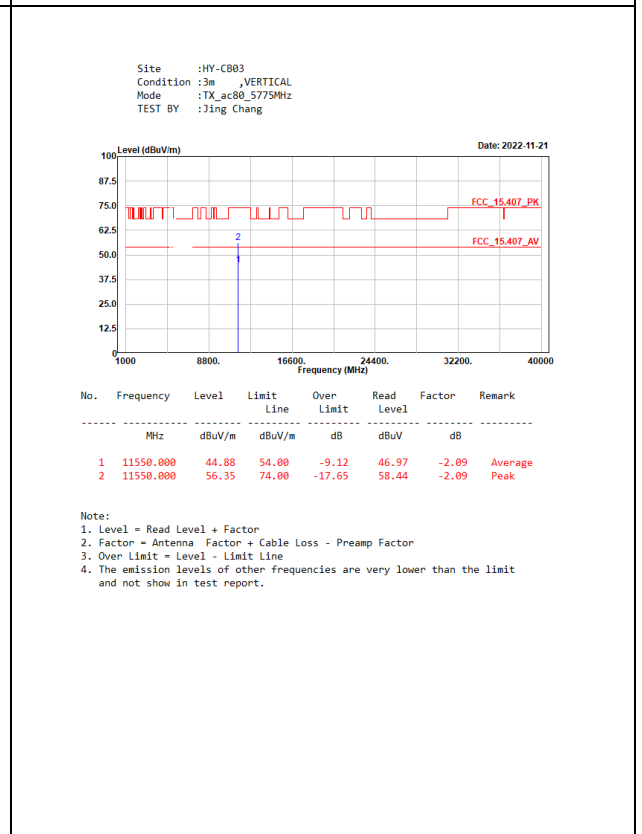
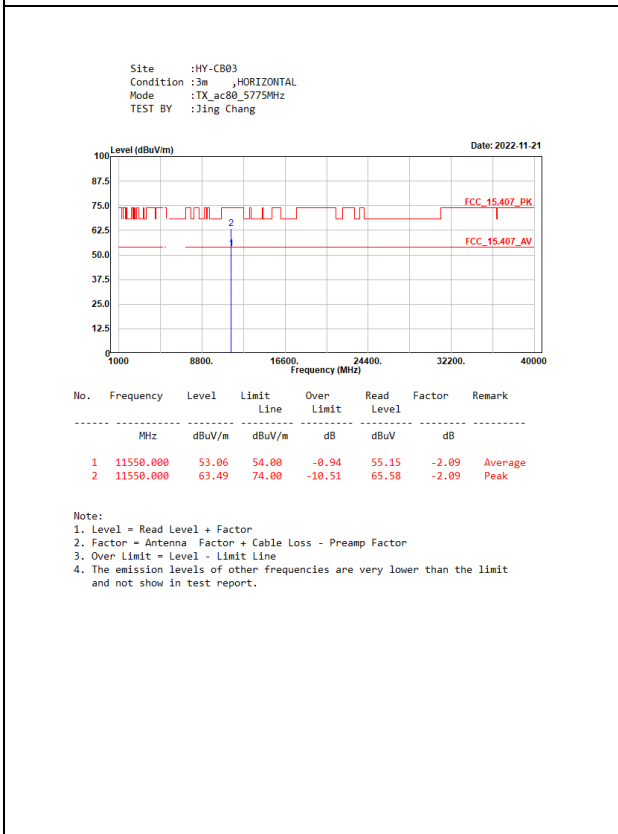
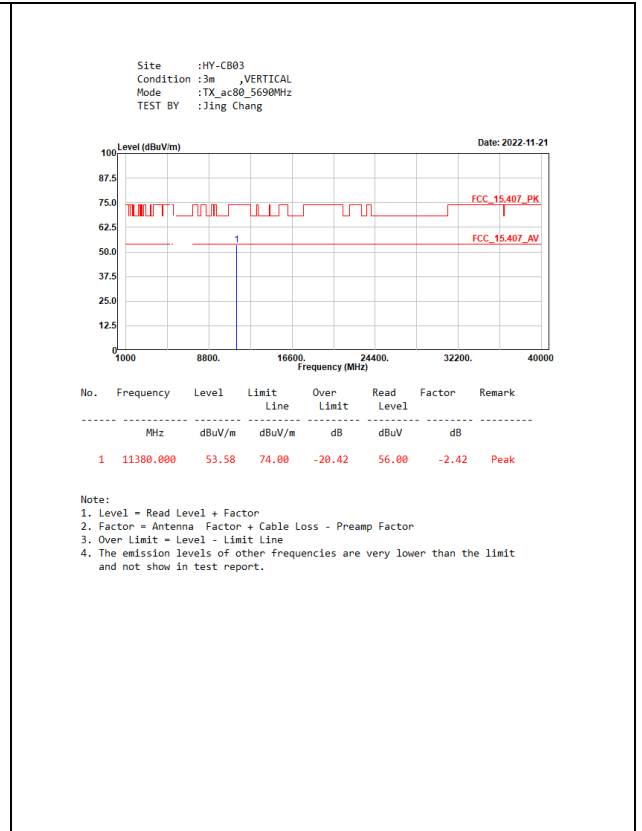
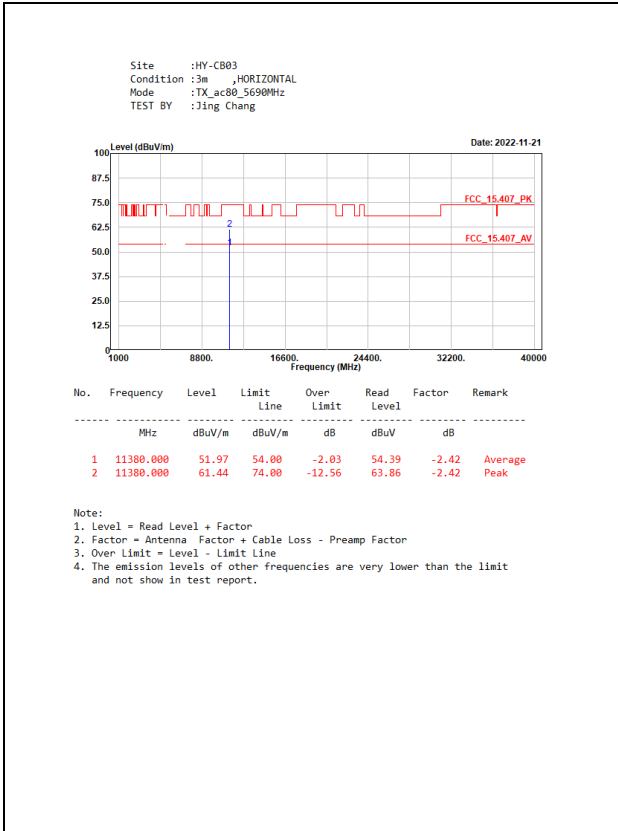

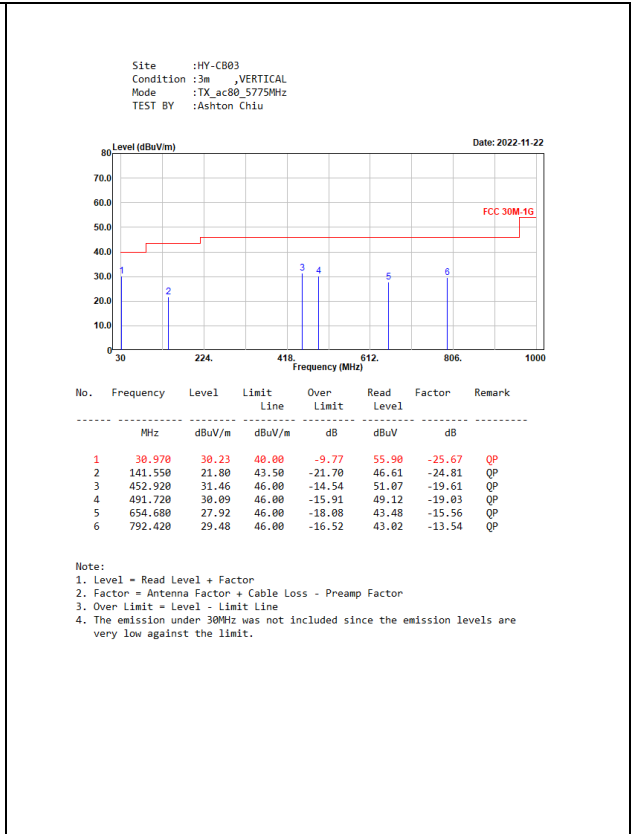
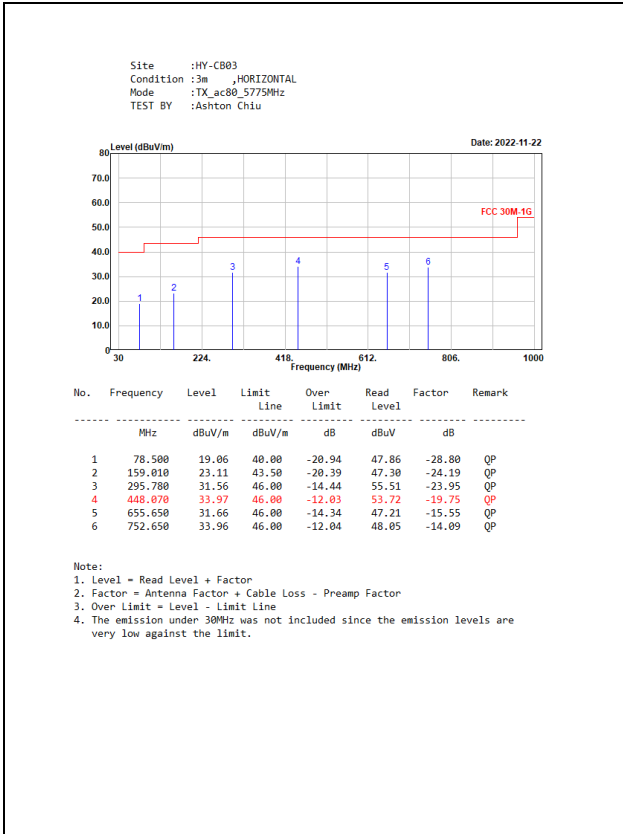

6. Band Edge

6.1. Test Setup

RF Conducted Measurement:

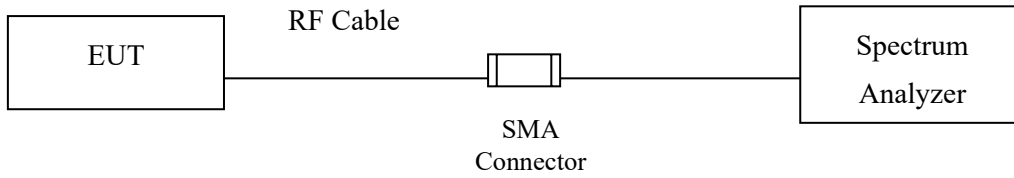

RF Radiated Measurement:

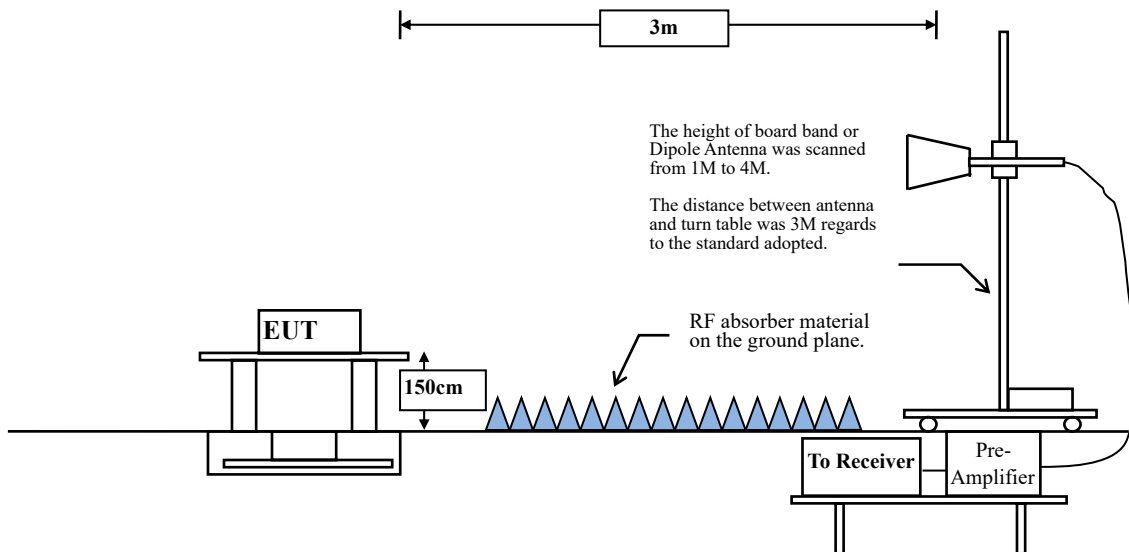

6.2. Limits

The provisions of Section 15.205 of this part apply to intentional radiators operating under this section. Radiated emissions which fall in the restricted bands, as defined in Section 15.205, must also comply with the radiated emission limits specified in Section 15.209:

FCC Part 15 Subpart C Paragraph 15.209 Limits		
Frequency MHz	uV/m @3m	dBµV/m@3m
30-88	100	40
88-216	150	43.5
216-960	200	46
Above 960	500	54

- Remarks :
1. RF Voltage (dBµV) = 20 log RF Voltage (uV)
 2. In the Above Table, the tighter limit applies at the band edges.
 3. Distance refers to the distance in meters between the measuring instrument antenna and the closed point of any part of the device or system.
- For transmitters operating in the 5.15-5.25 GHz band: All emissions outside of the 5.15-5.35 GHz band shall not exceed an e.i.r.p. of -27 dBm/MHz.
 - For transmitters operating in the 5.25-5.35 GHz band: All emissions outside of the 5.15-5.35 GHz band shall not exceed an e.i.r.p. of -27 dBm/MHz.
 - For transmitters operating in the 5.47-5.725 GHz band: All emissions outside of the 5.47-5.725 GHz band shall not exceed an e.i.r.p. of -27 dBm/MHz.
 - For transmitters operating in the 5.725-5.85 GHz band:
All emissions shall be limited to a level of -27 dBm/MHz at 75 MHz or more above or below the band edge increasing linearly to 10 dBm/MHz at 25 MHz above or below the band edge, and from 25 MHz above or below the band edge increasing linearly to a level of 15.6 dBm/MHz at 5 MHz above or below the band edge, and from 5 MHz above or below the band edge increasing linearly to a level of 27 dBm/MHz at the band edge.
 - For transmitters operating within the 5.925-7.125 GHz band: Any emissions outside of the 5.925-7.125 GHz band must not exceed an e.i.r.p. of -27 dBm/MHz.

Based on ANSI C63.10-2013 Section 12.7.3 d) provides the conversion formula between field strength and EIRP, if distance is 3m, -27dBm is equivalent to 68.22dBuV/m.

6.3. Test Procedure

The EUT is placed on a turn table which is 1.5 meter above ground. The turn table can rotate 360 degrees to determine the position of the maximum emission level. The EUT was positioned such that the distance from antenna to the EUT was 3 meters.

The antenna can move up and down between 1 meter and 4 meters to find out the maximum emission level.

Both horizontal and vertical polarization of the antenna are set on measurement. In order to find the maximum emission, all of the interface cables must be manipulated according to ANSI C63.10:2013 on radiated measurement.

The bandwidth below 1 GHz setting on the field strength meter is 120 kHz, above 1 GHz are 1 MHz.

The EUT was setup to ANSI C63.10, 2013; tested to UNII test procedure of FCC KDB-789033 for compliance to FCC 47CFR Subpart E requirements.

RBW and VBW Parameter setting:

According to KDB 789033 section II.G.5 Procedure for Unwanted Maximum Emissions Measurements above 1000 MHz.

RBW = 1 MHz.

VBW \geq 3 MHz.

According to KDB 789033 section II.G.6 Procedures for Average Unwanted Emissions Measurements above 1000 MHz.

RBW = 1 MHz.

VBW = 10 Hz, when duty cycle \geq 98 %

VBW \geq 1/T, when duty cycle < 98 %

(T refers to the minimum transmission duration over which the transmitter is on and is transmitting at its maximum power control level for the tested mode of operation.)

5 GHz band	Duty Cycle (%)	T (ms)	1/T (Hz)	VBW (Hz)
802.11 a	97.81	2.0280	493	500
802.11 ac20	97.66	1.8980	527	1000
802.11 ac40	95.33	0.9295	1076	2000
802.11 ac80	92.28	0.4540	2203	3000

Note: Duty Cycle Refer to Section 8

6.4. Test Result of Band Edge

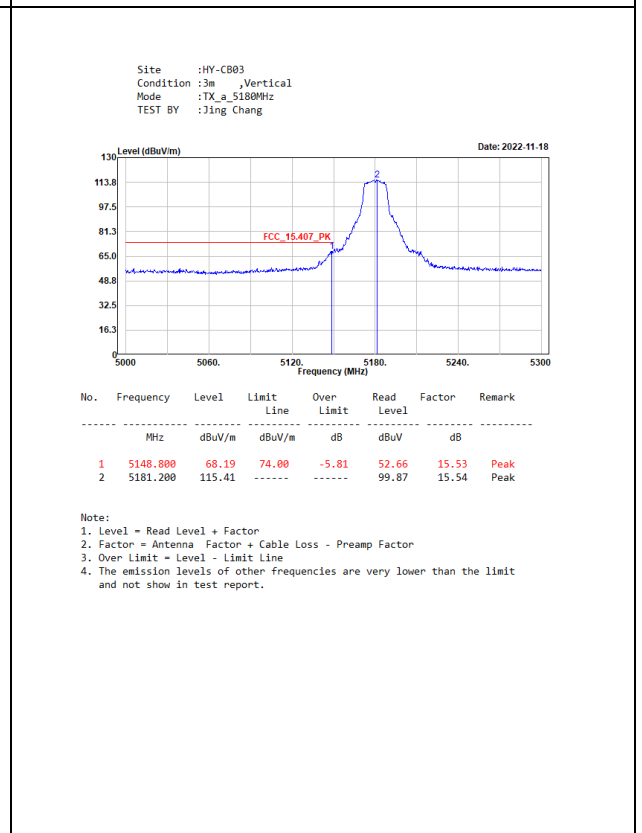
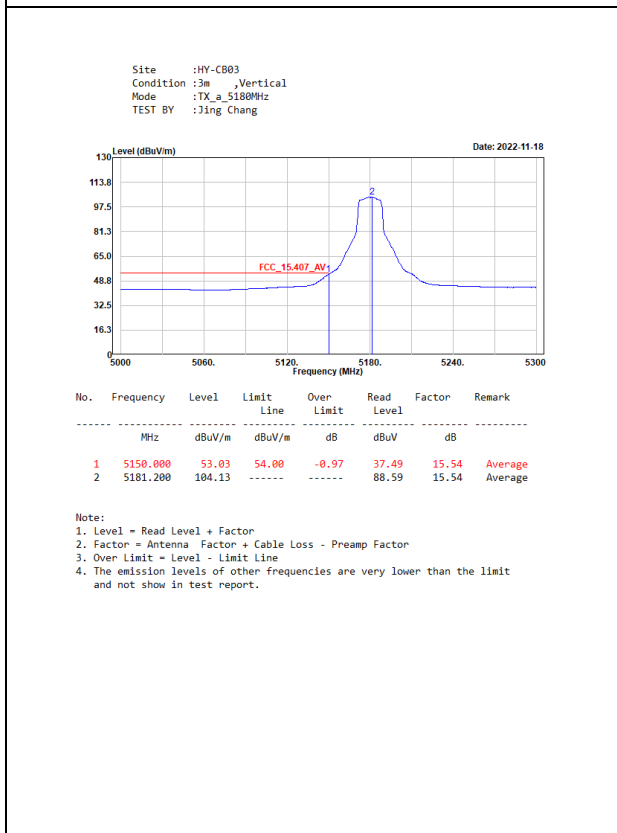
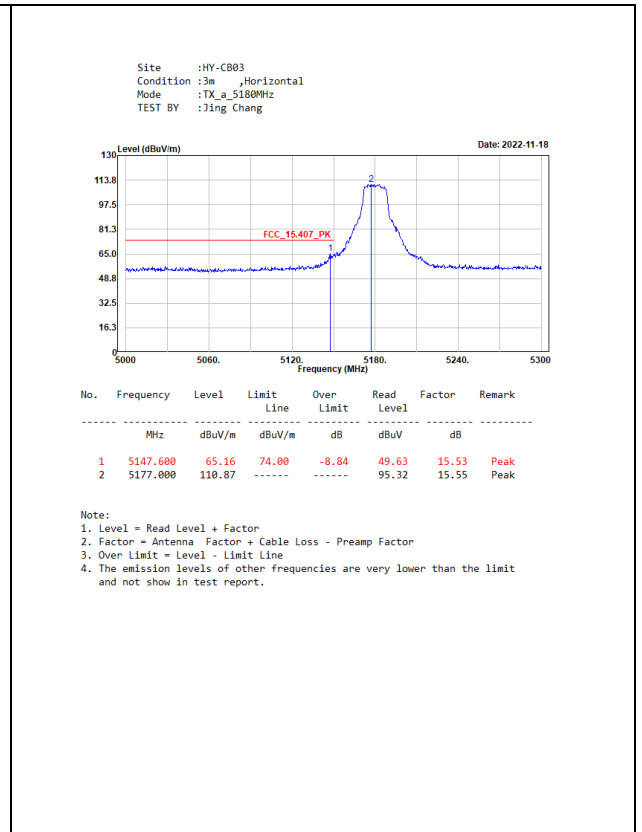
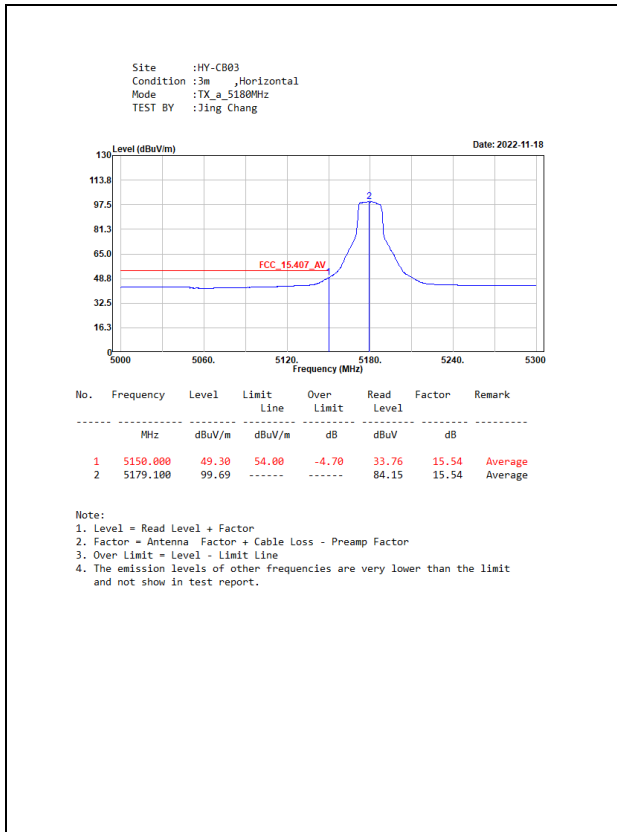

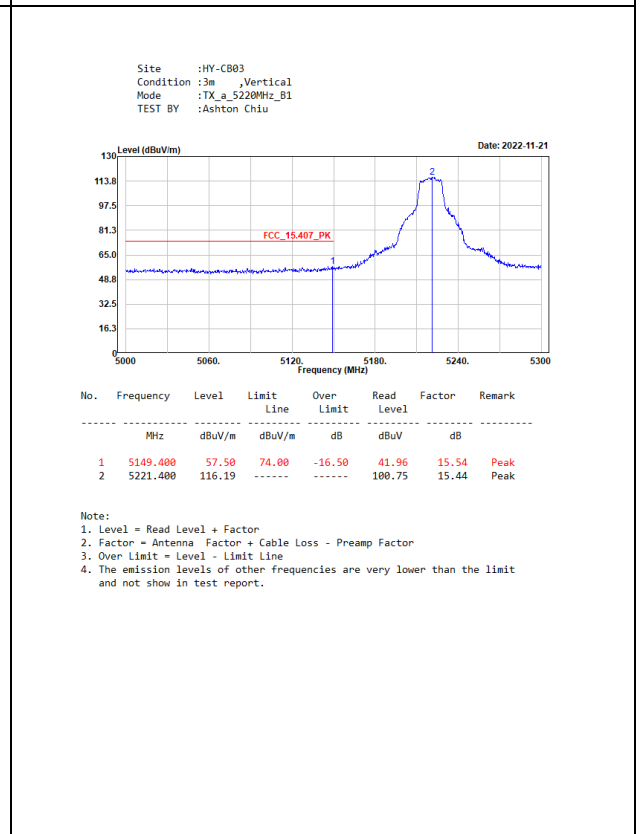
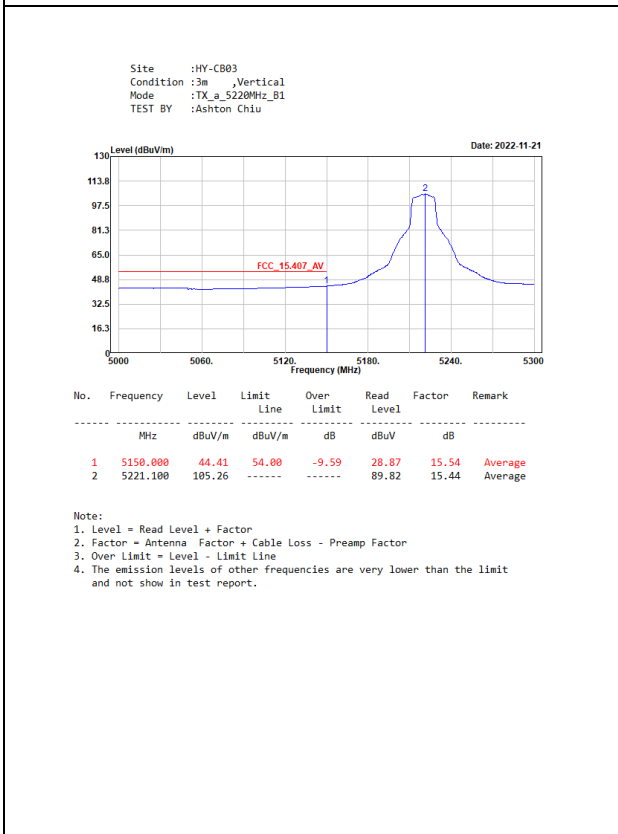
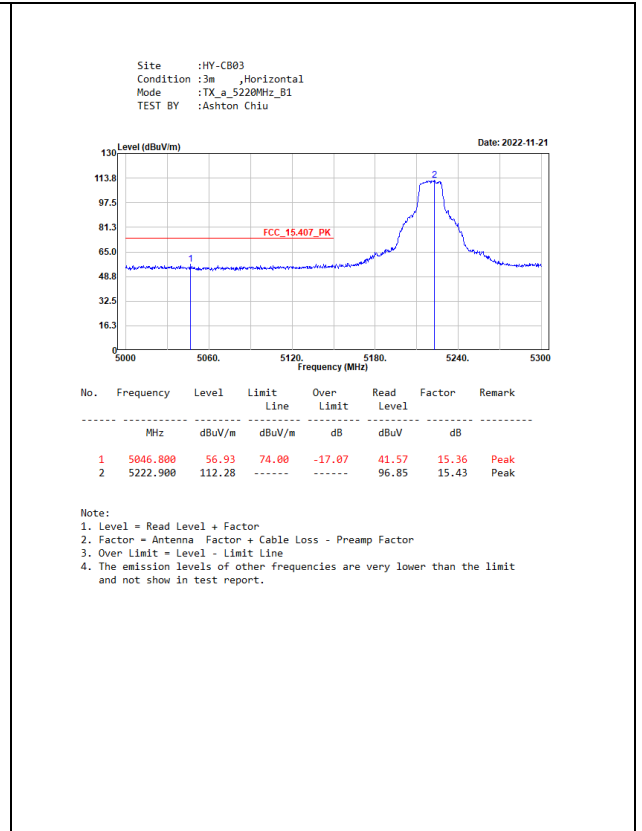
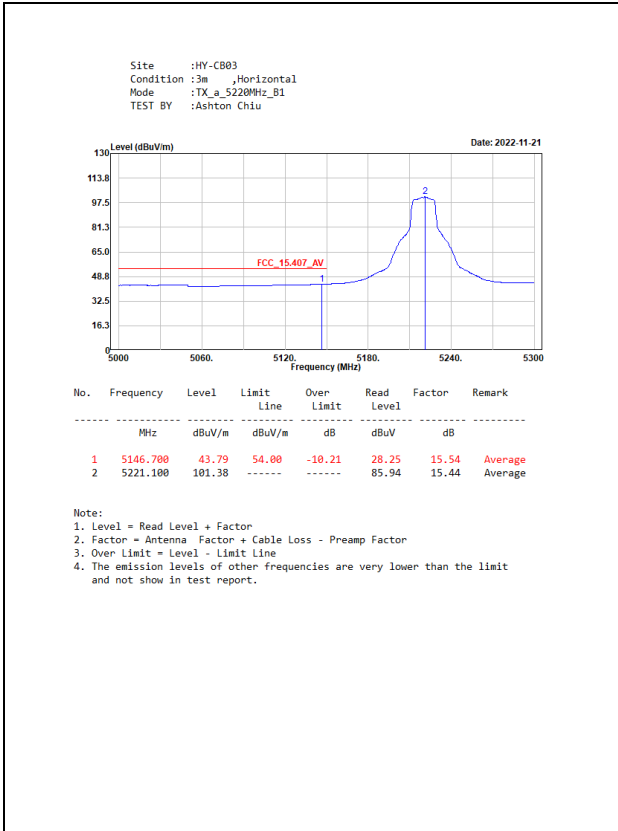

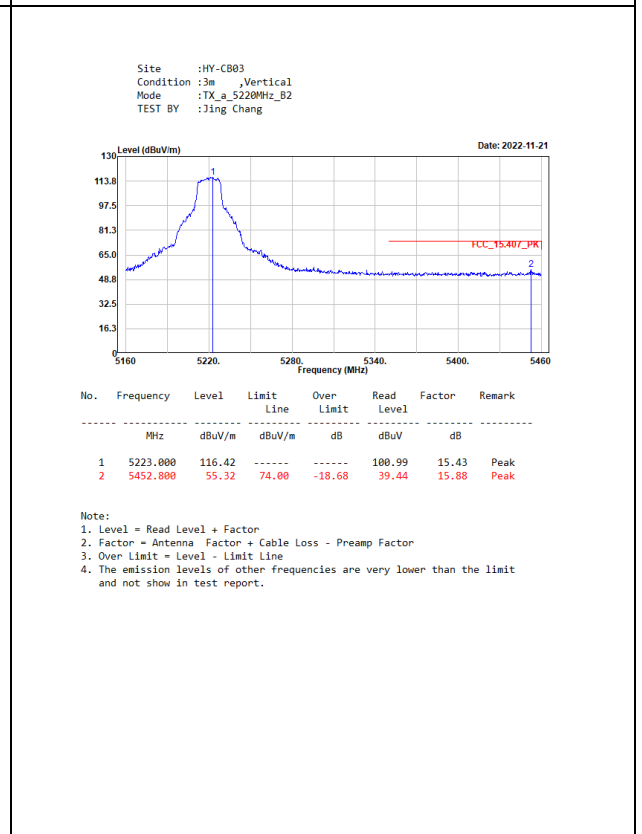
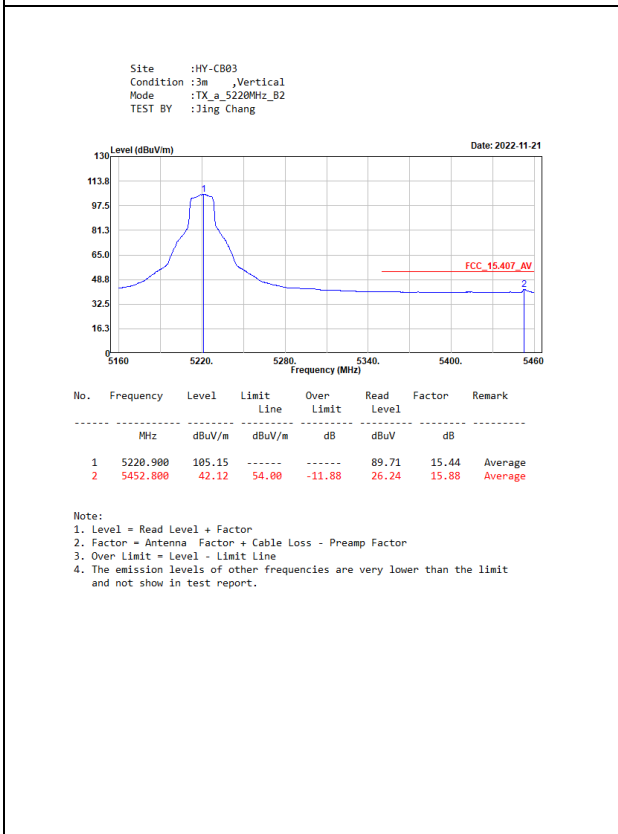
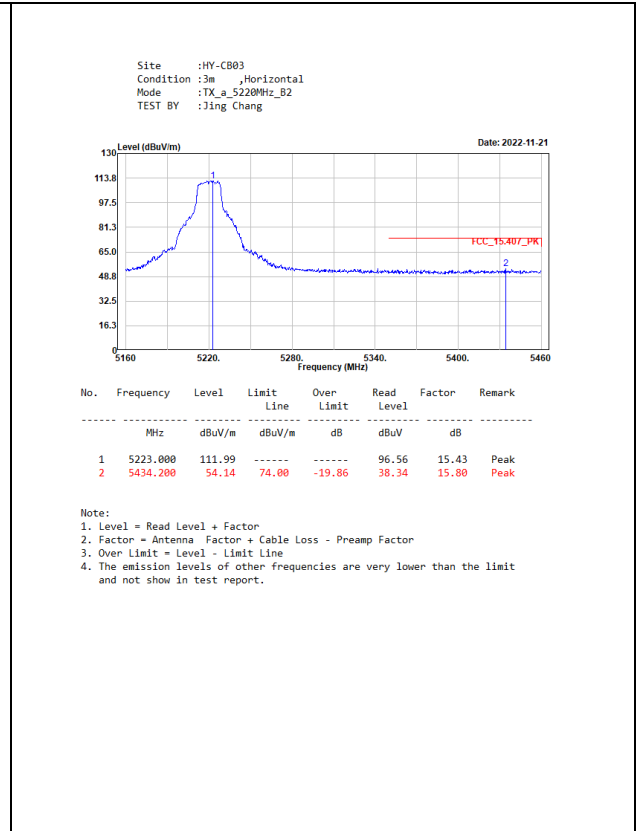
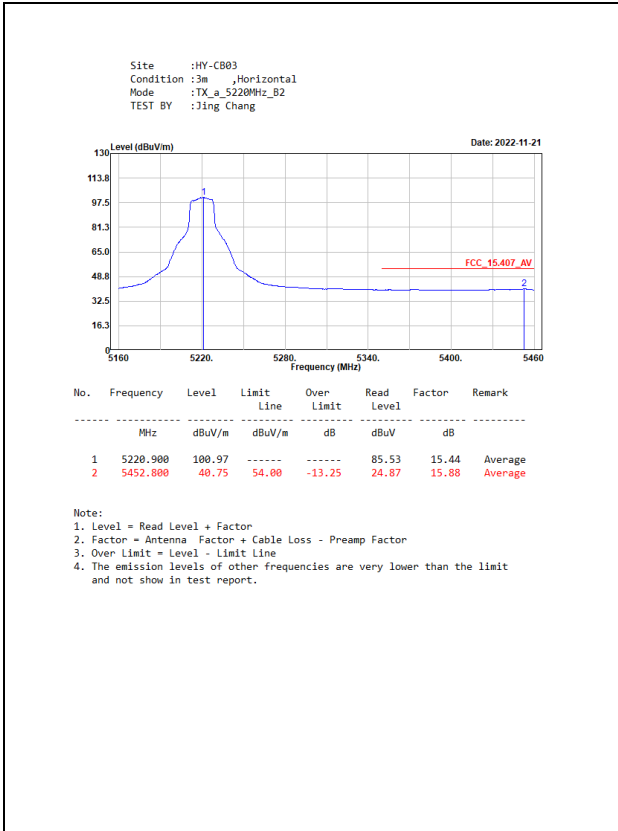

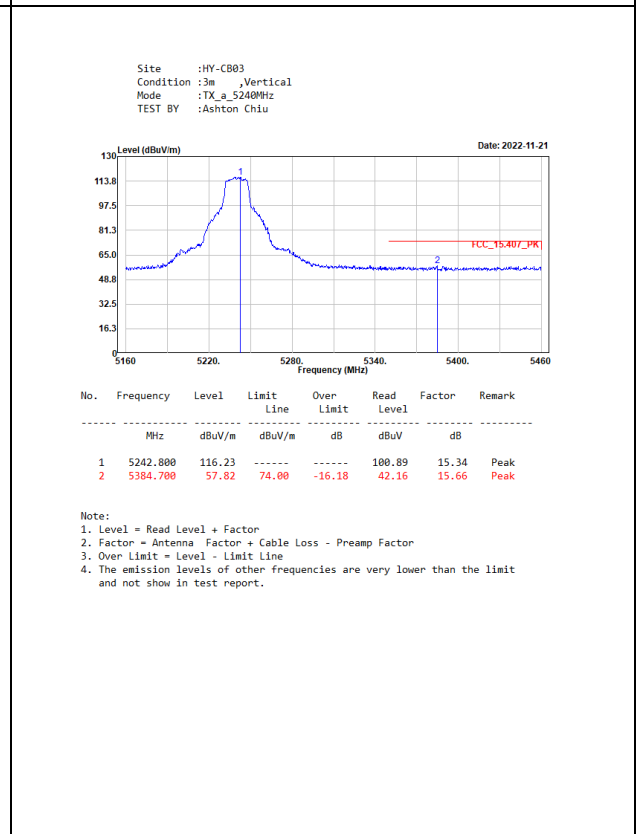
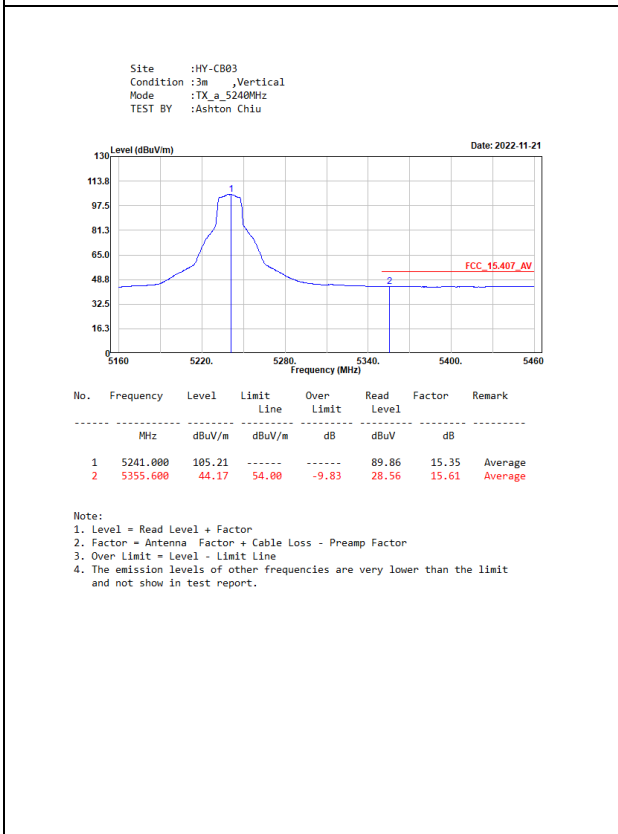
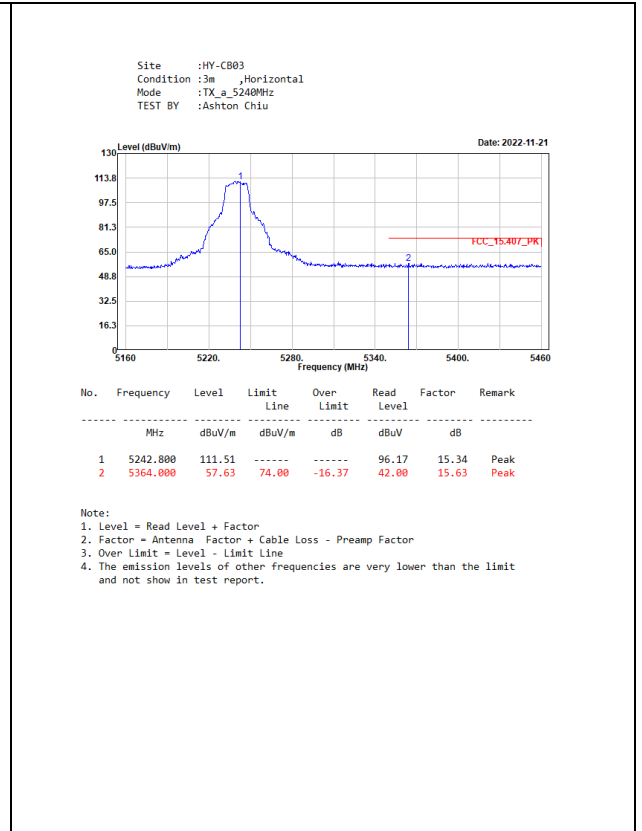
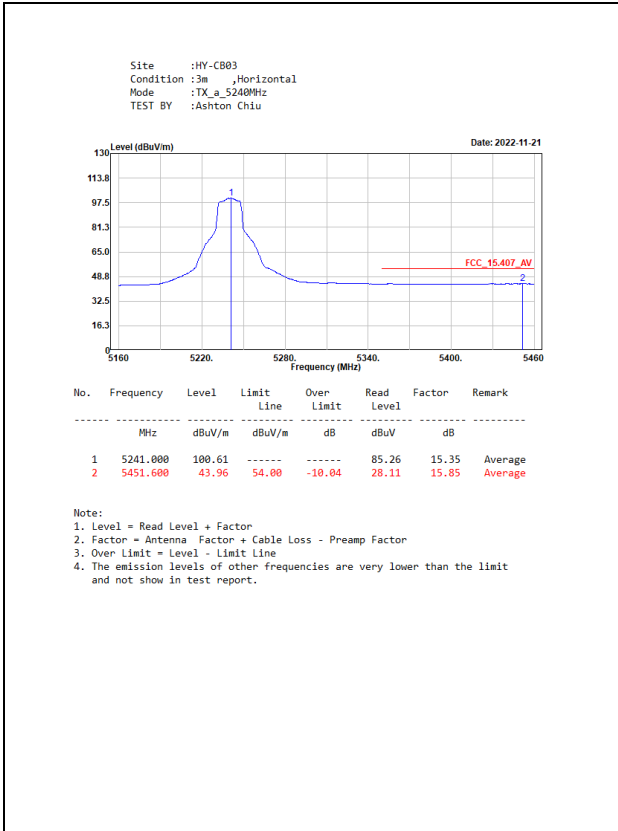

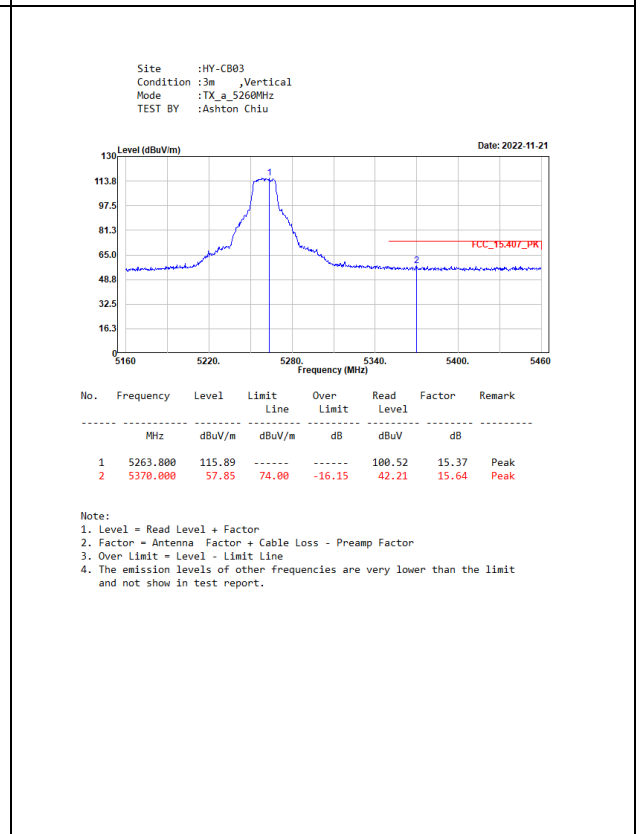
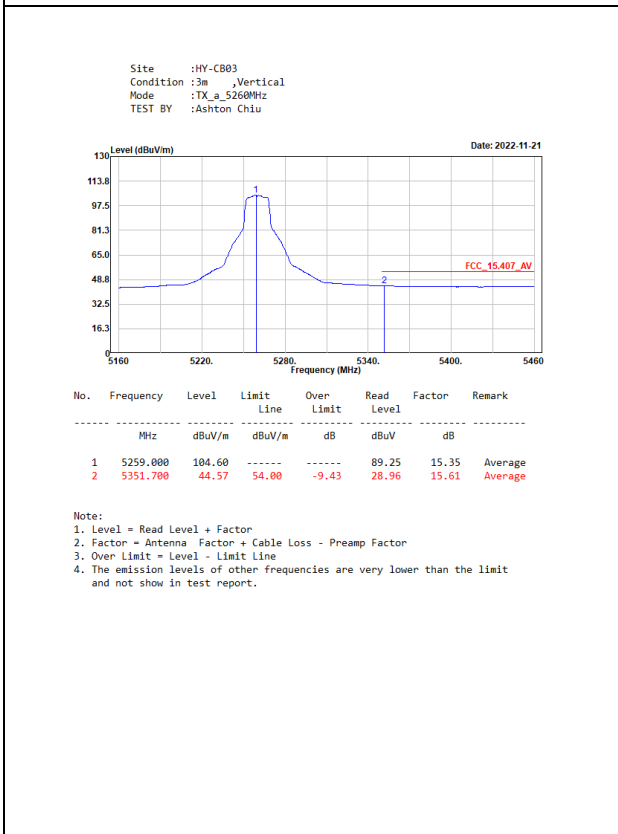
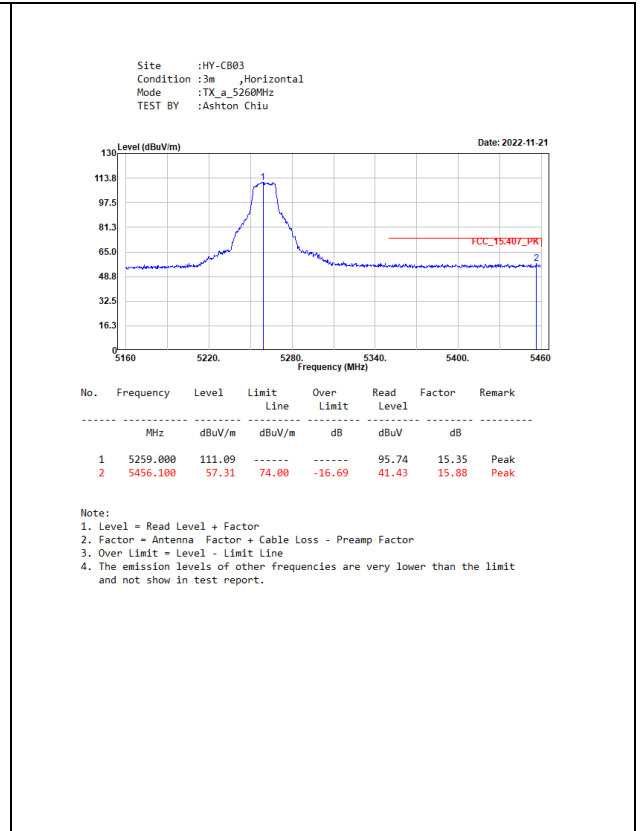
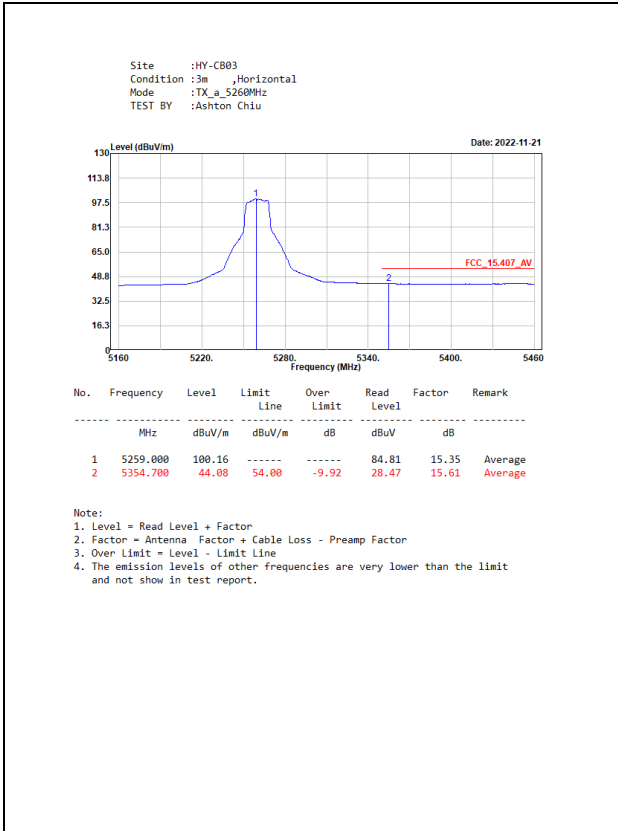

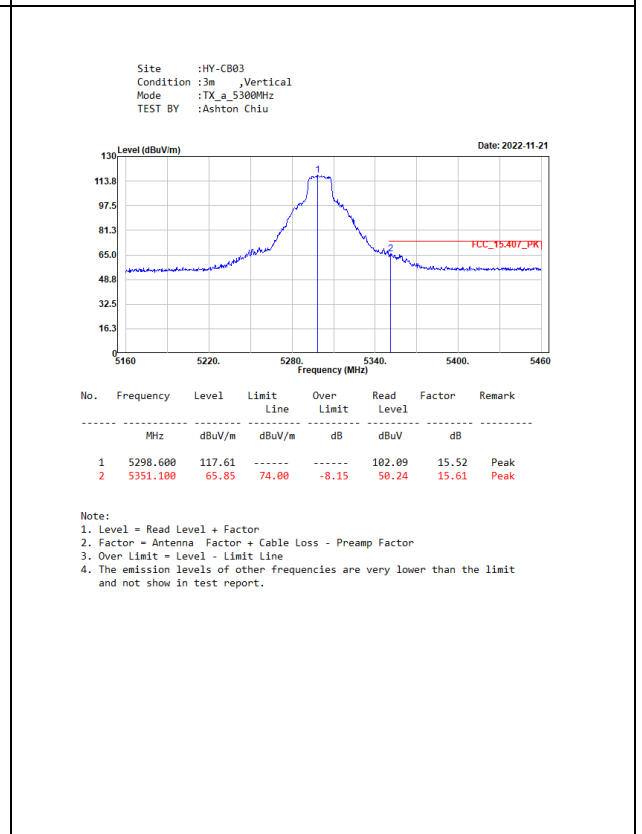
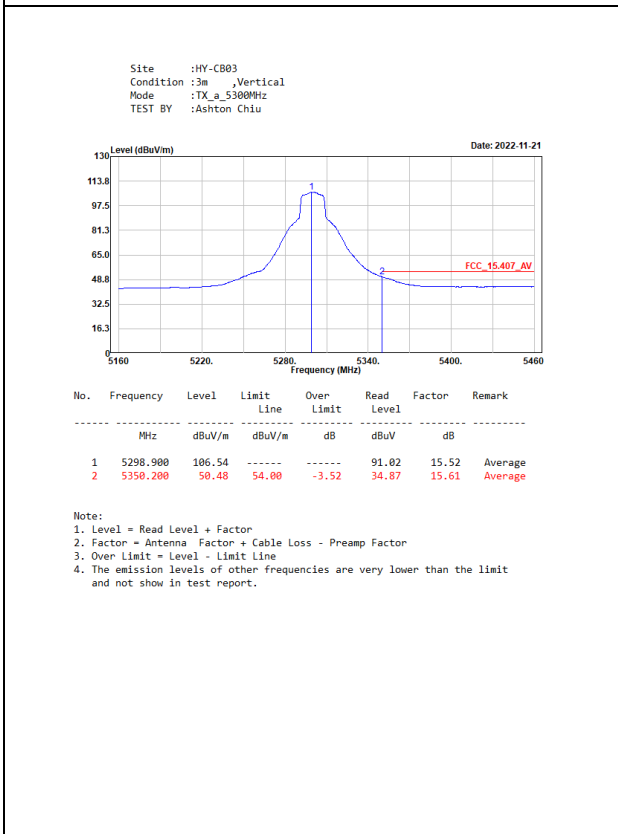
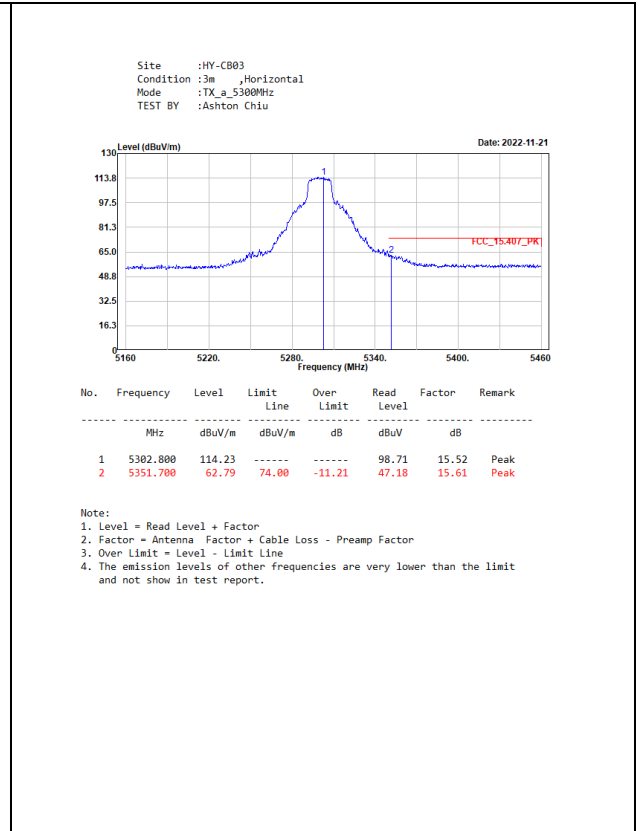
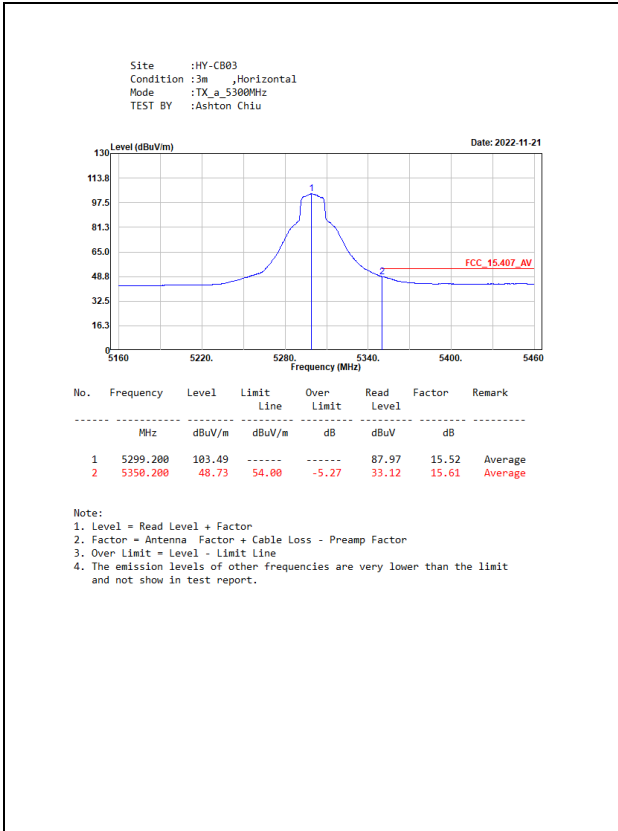

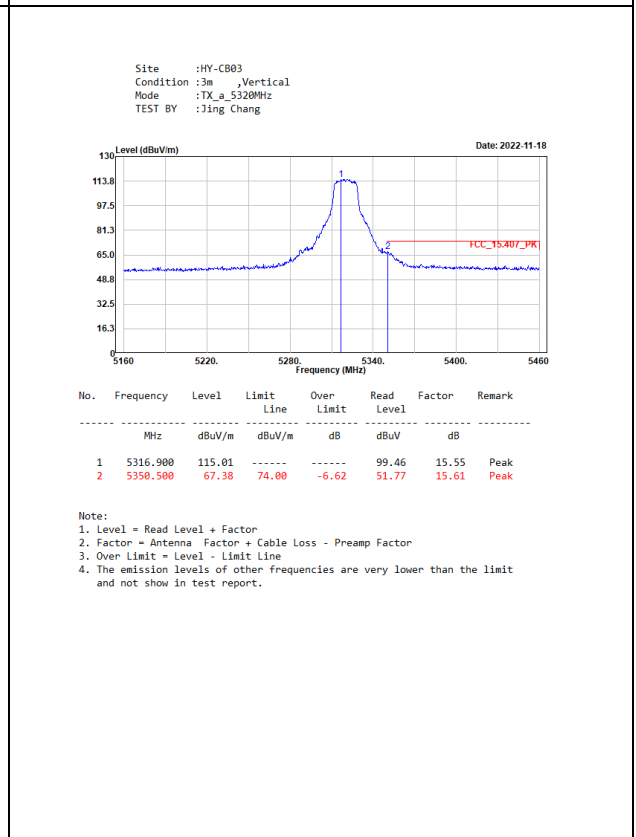
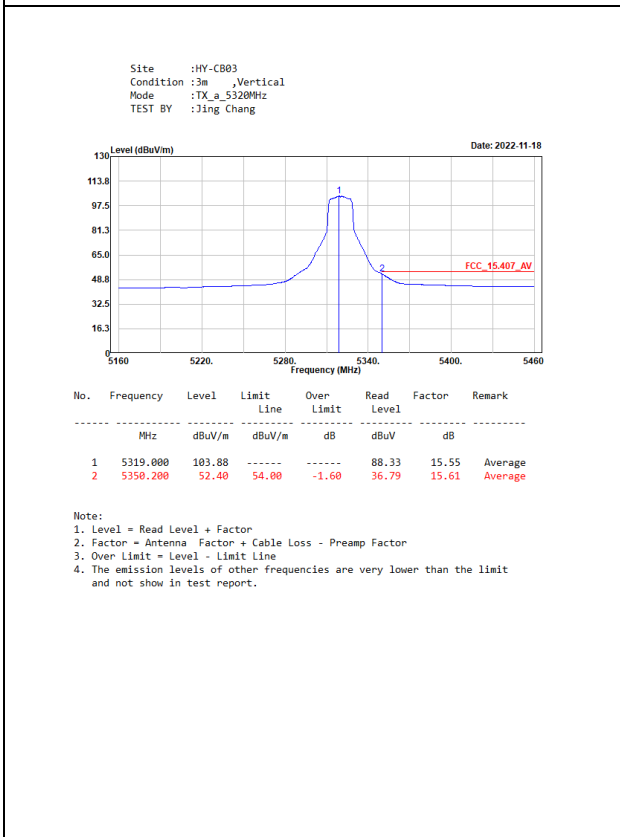
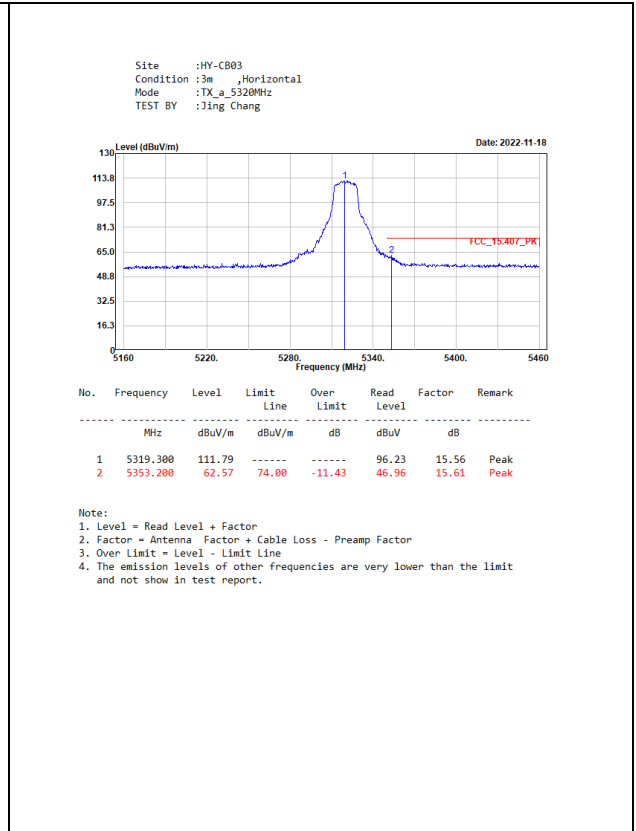
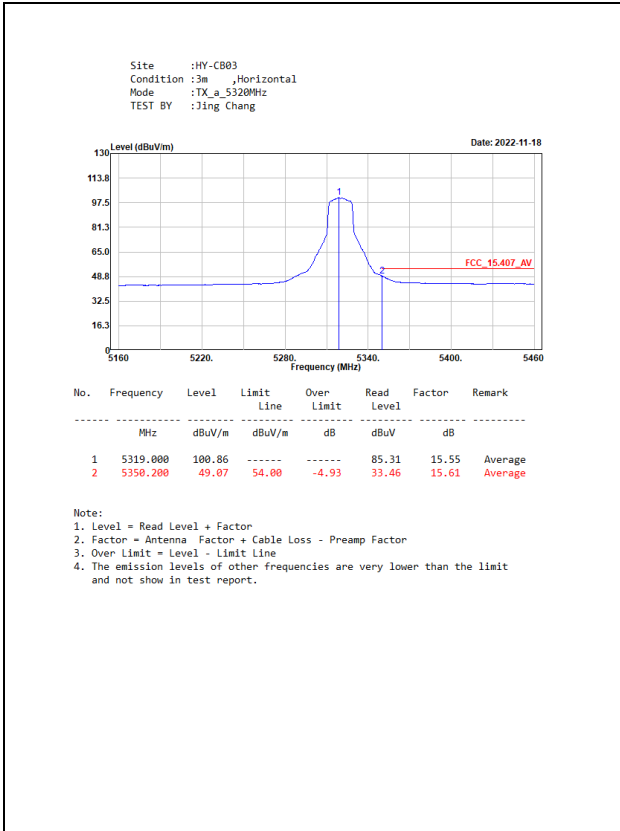

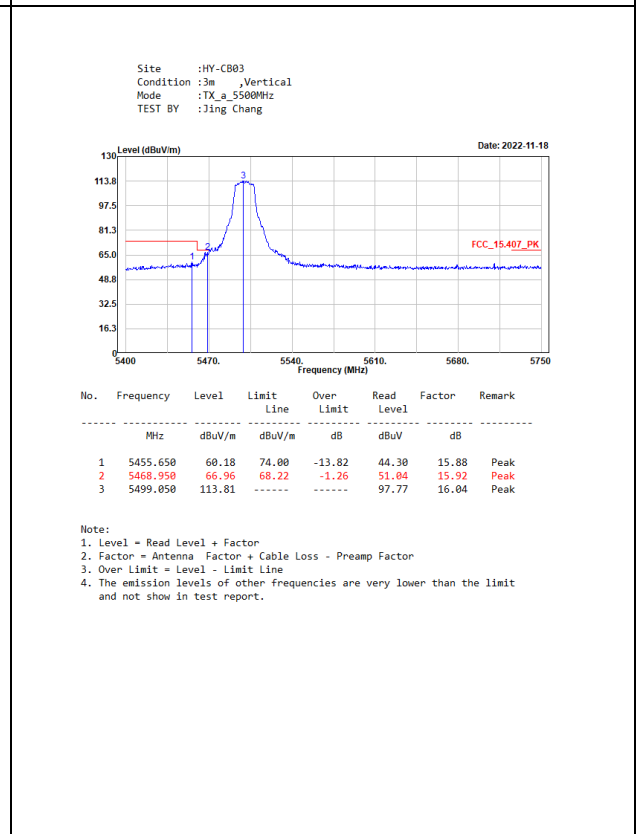
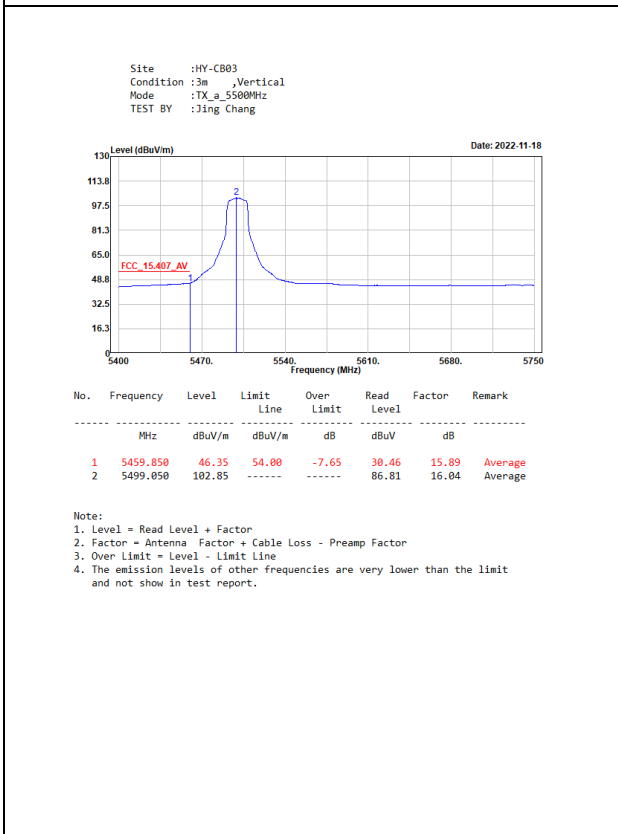
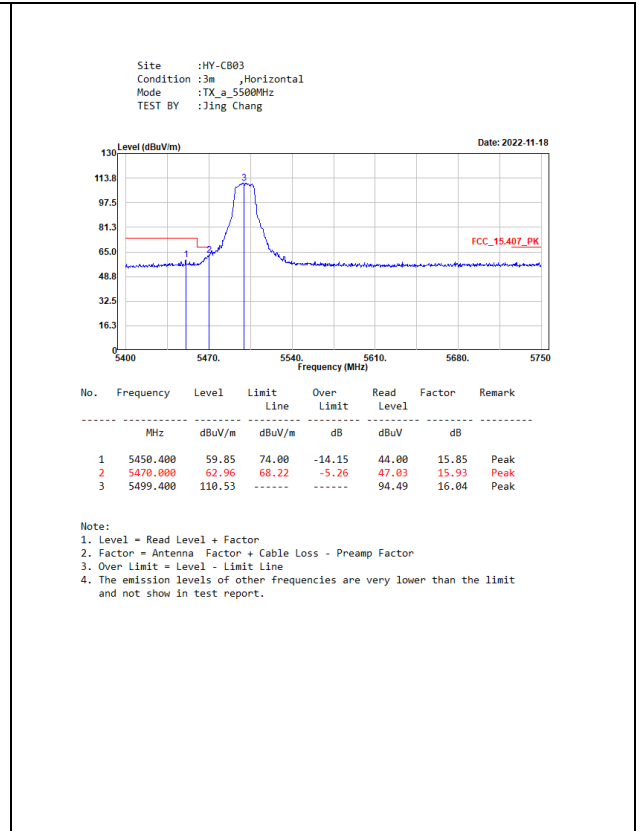
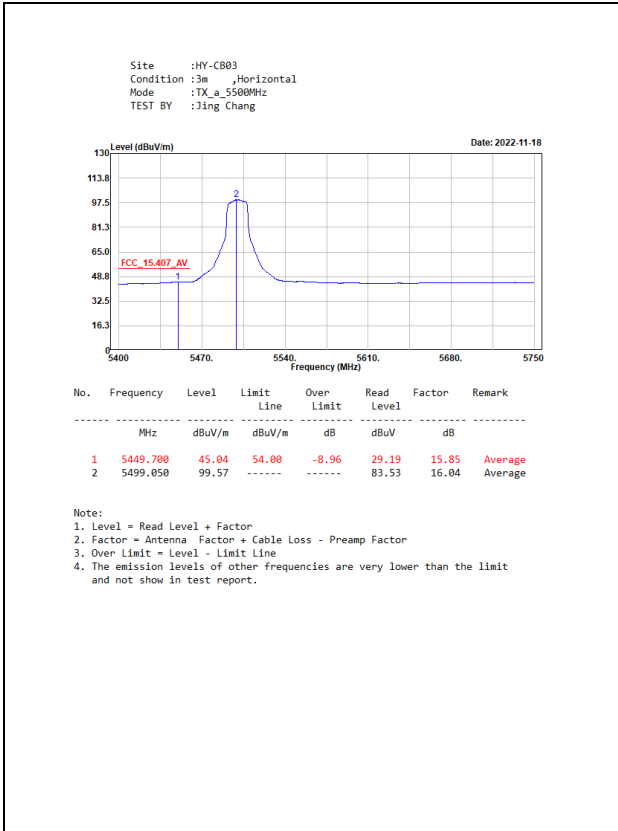

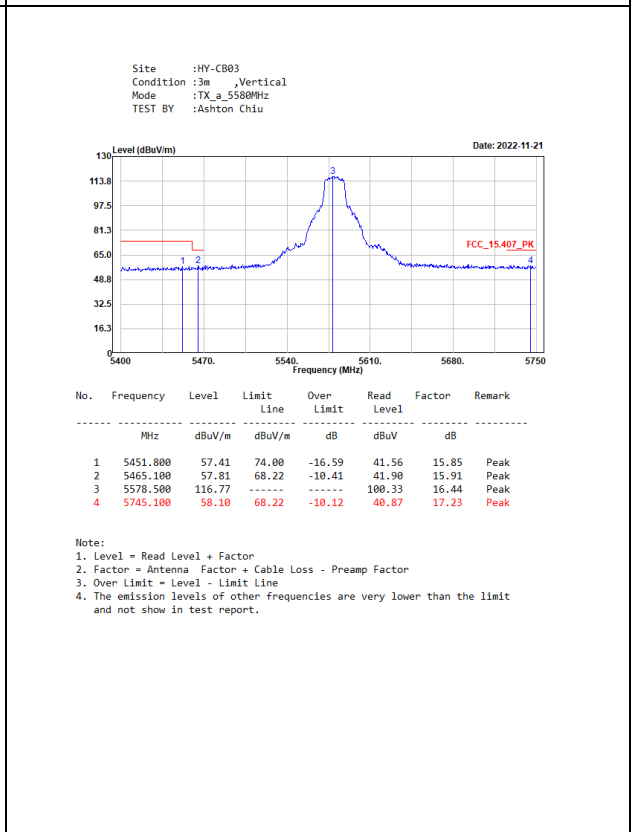
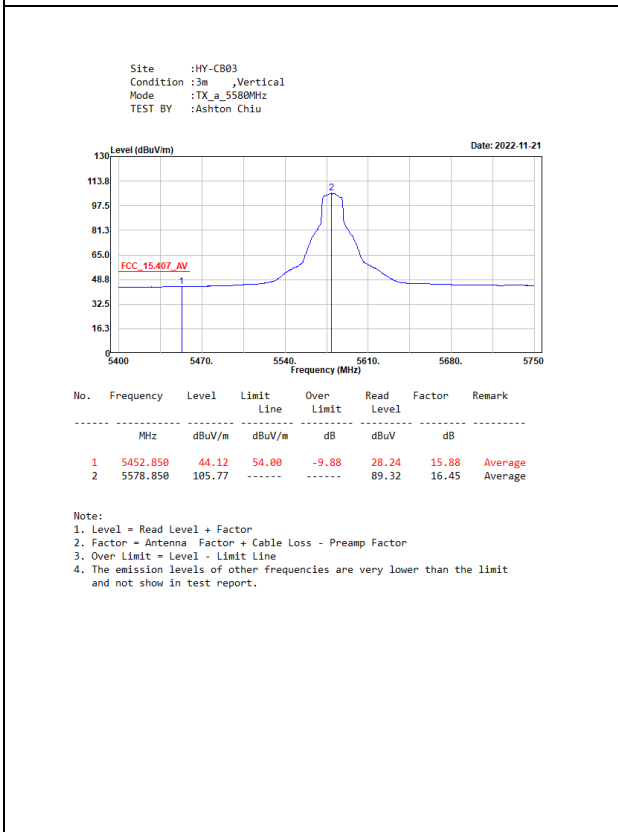
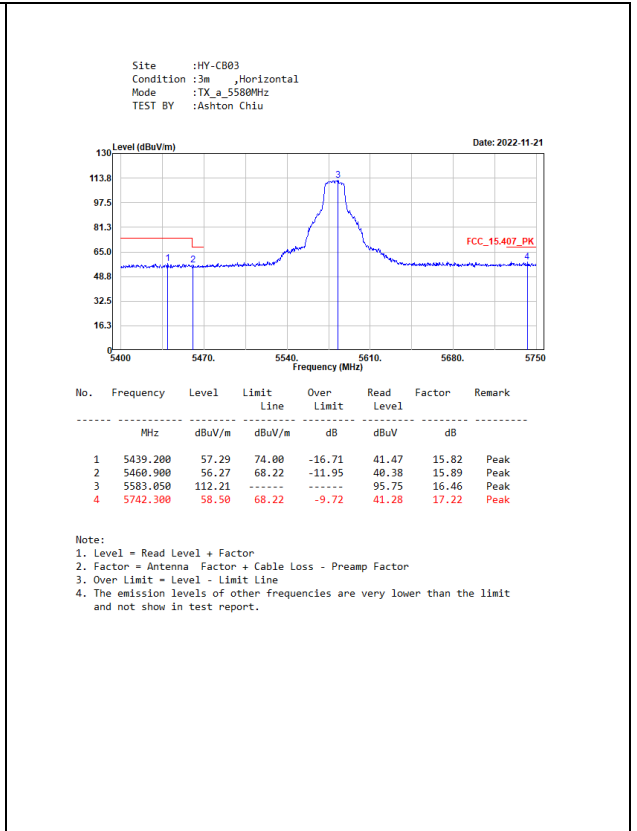
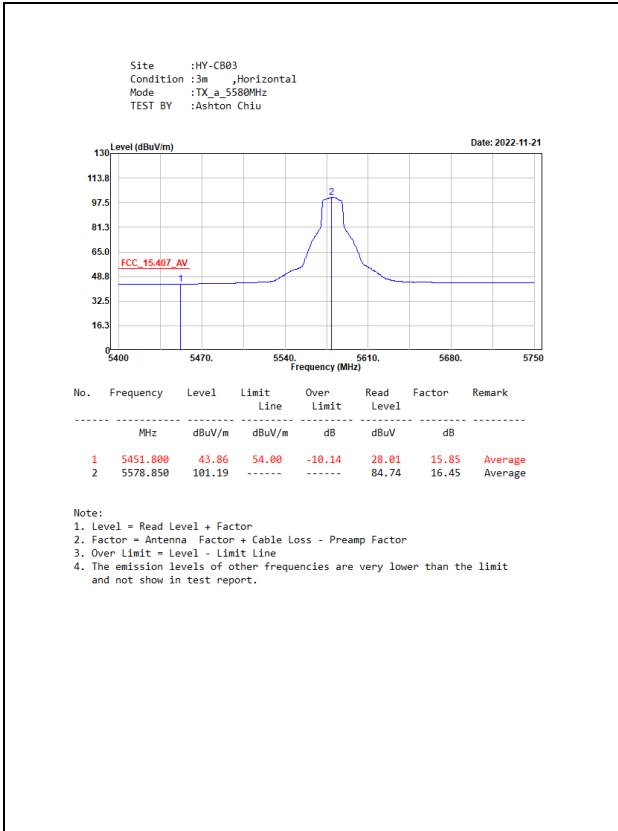

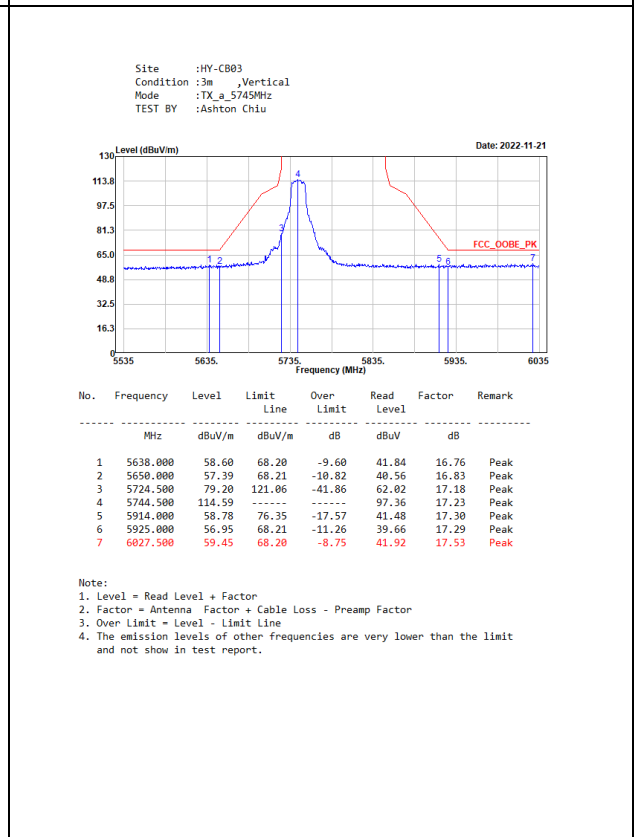
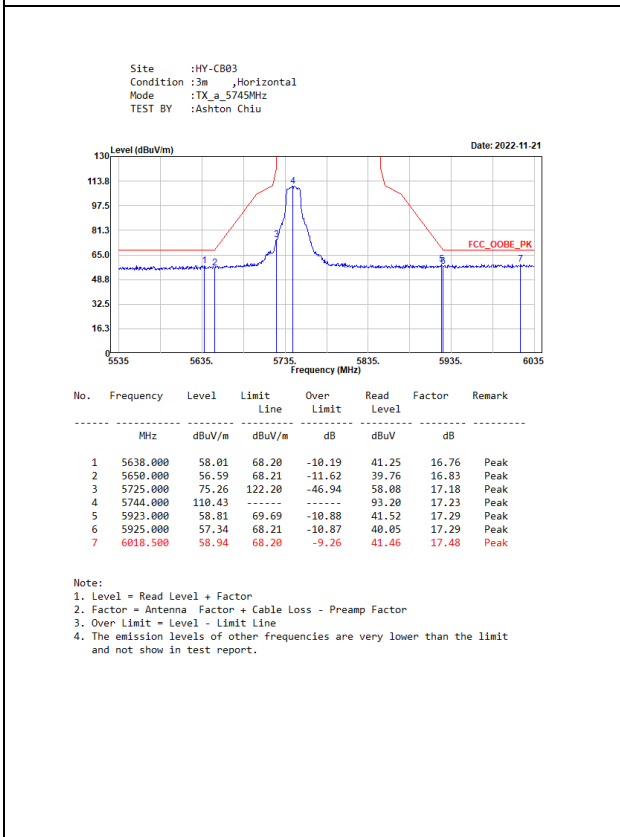
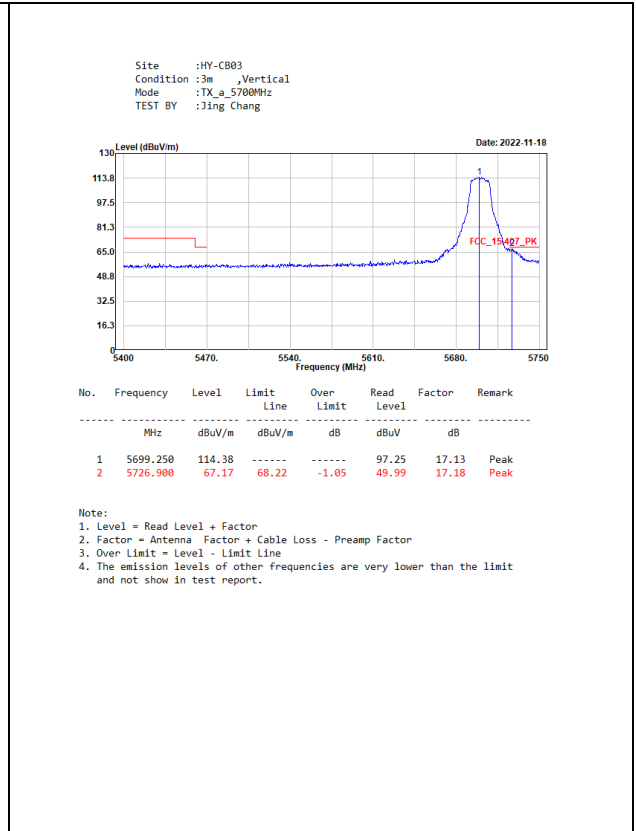
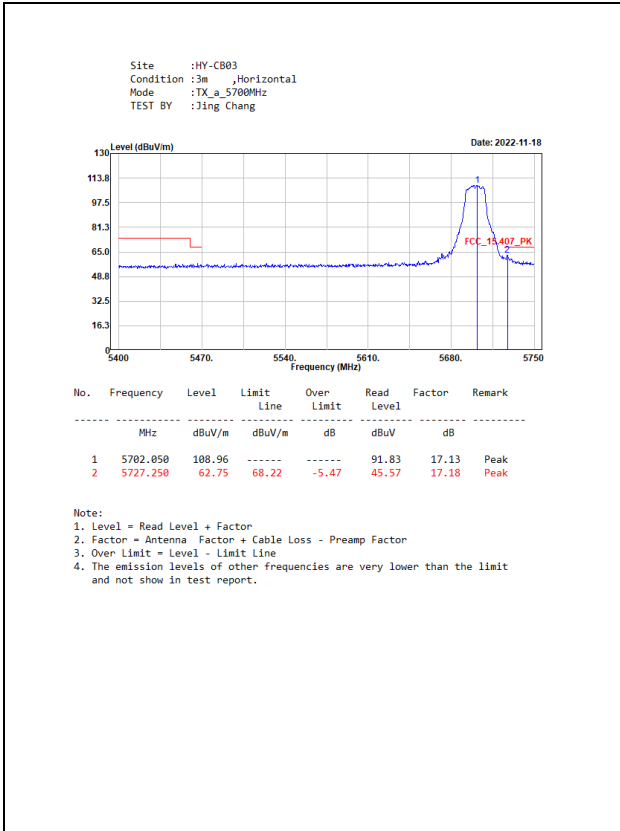

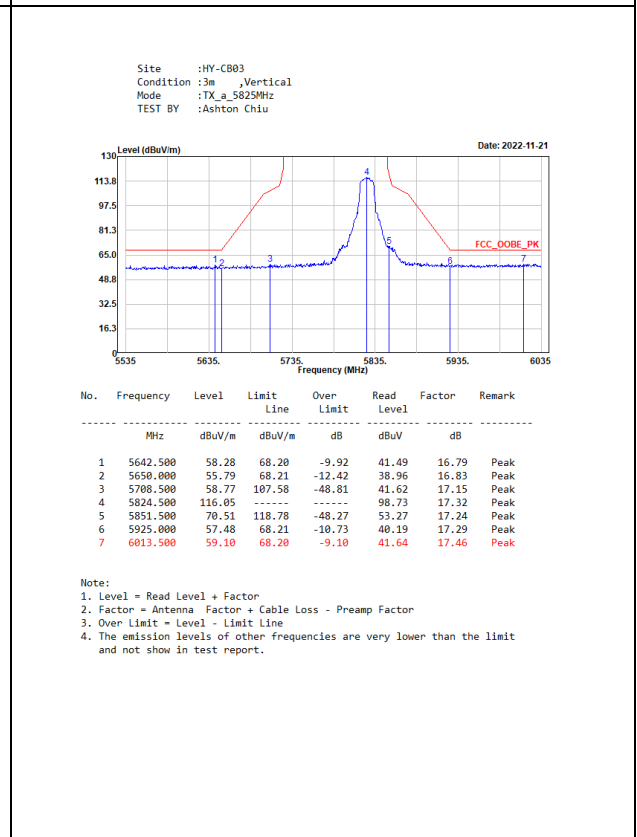
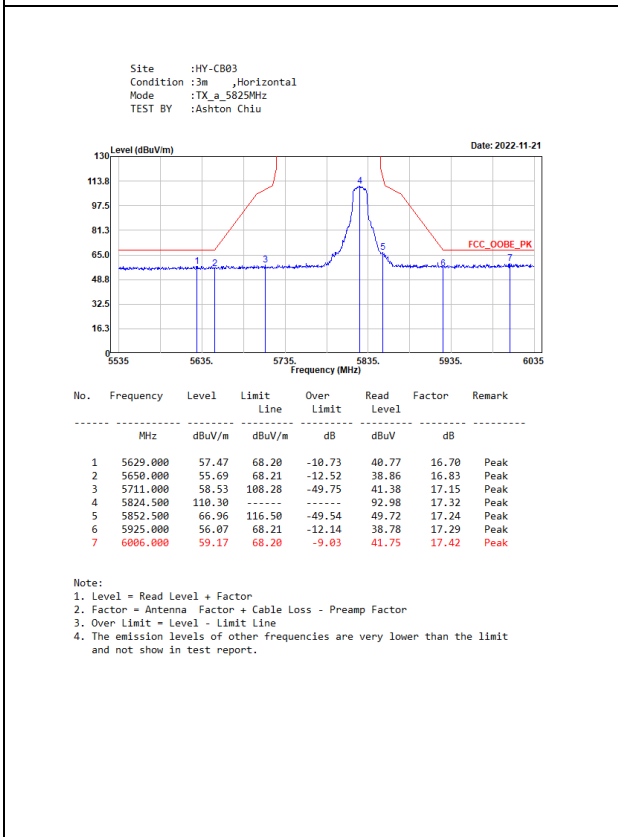
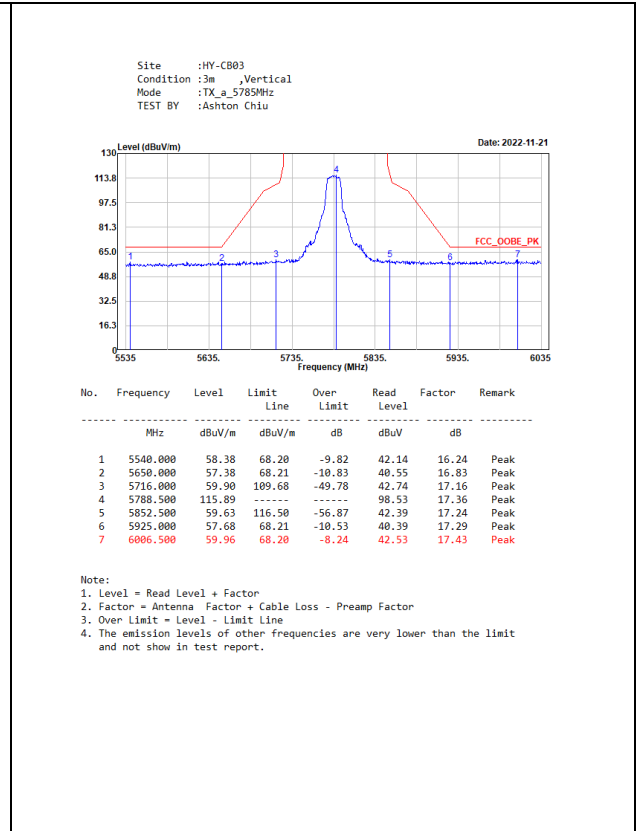
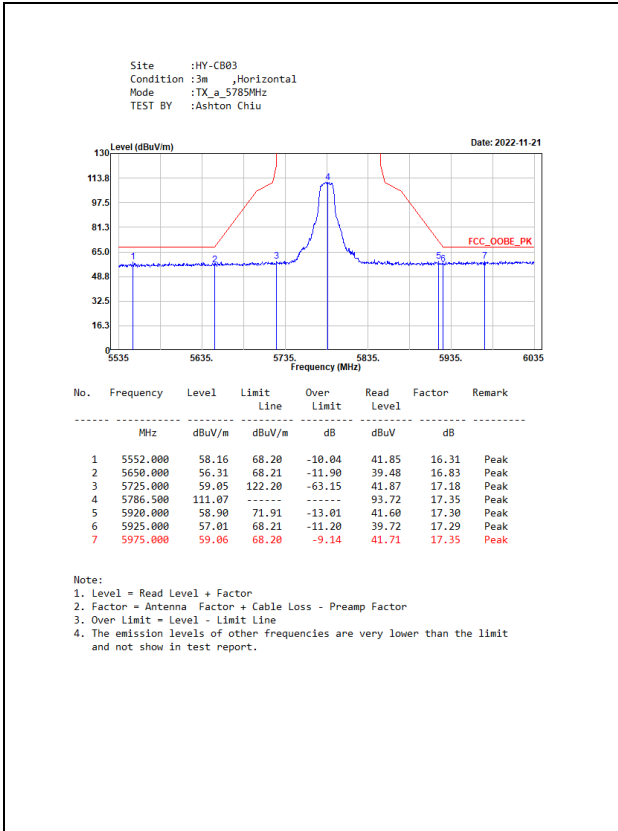

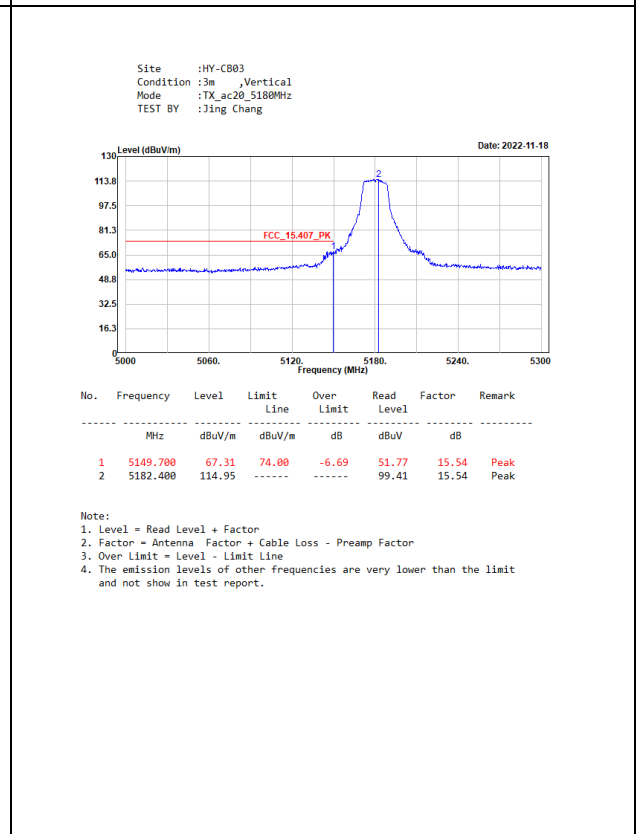
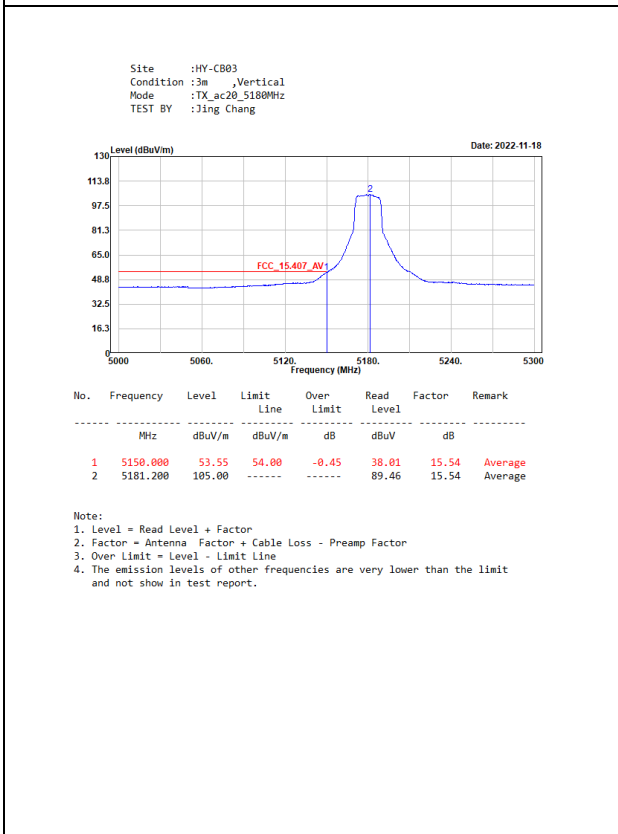
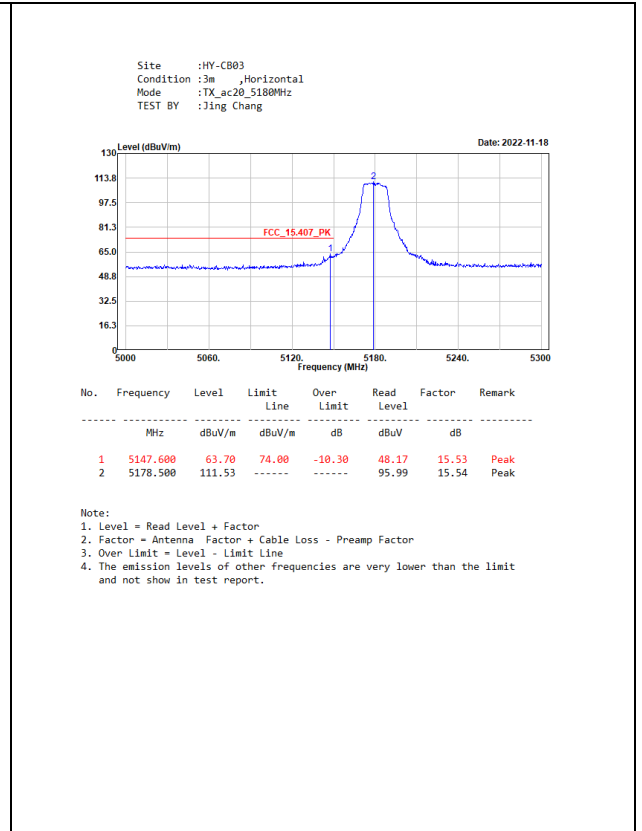
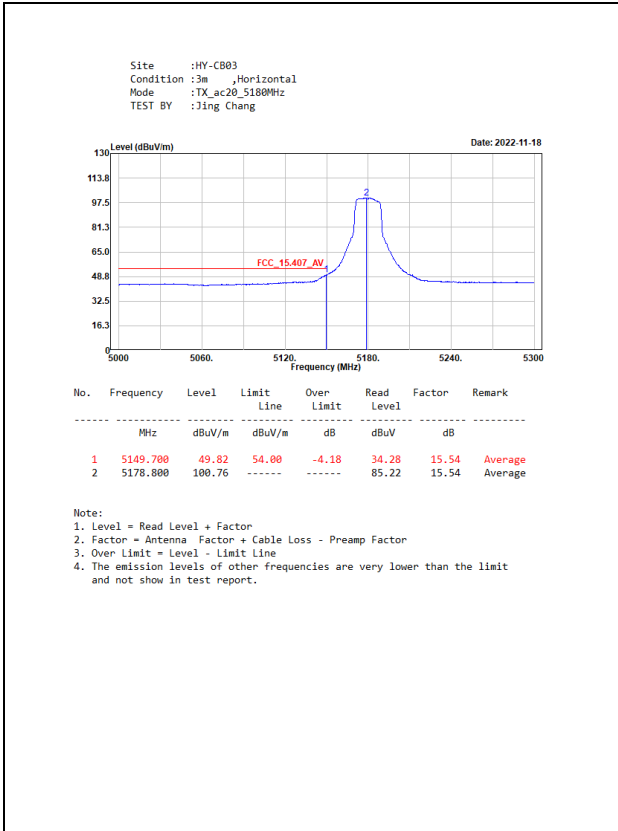

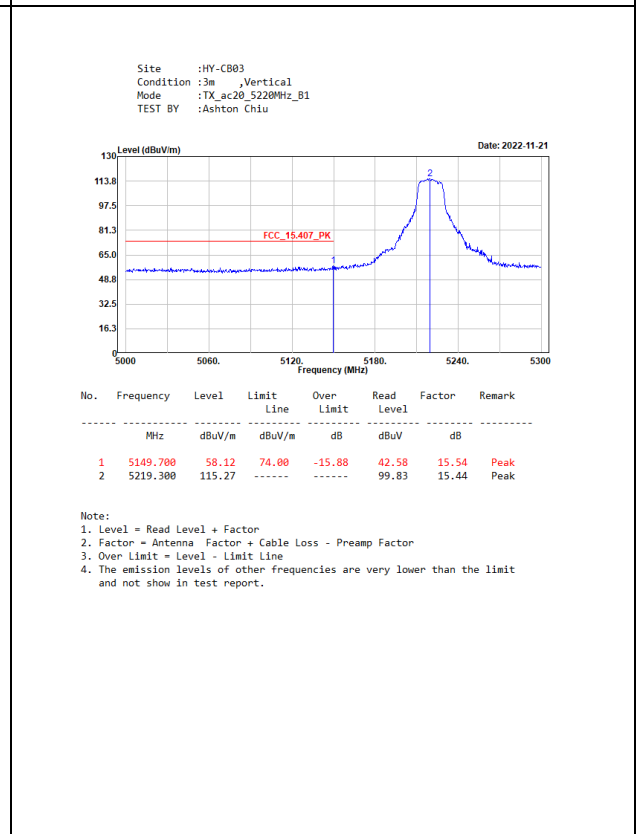
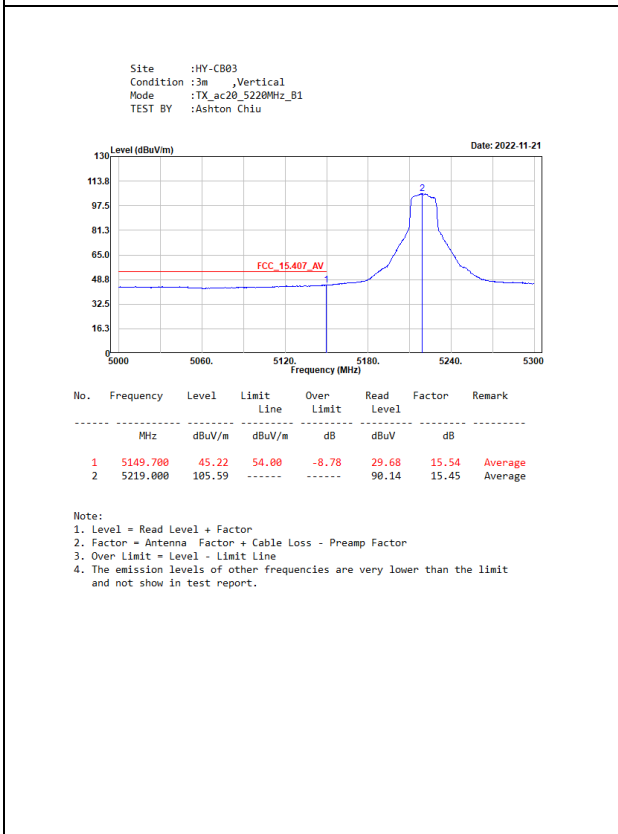
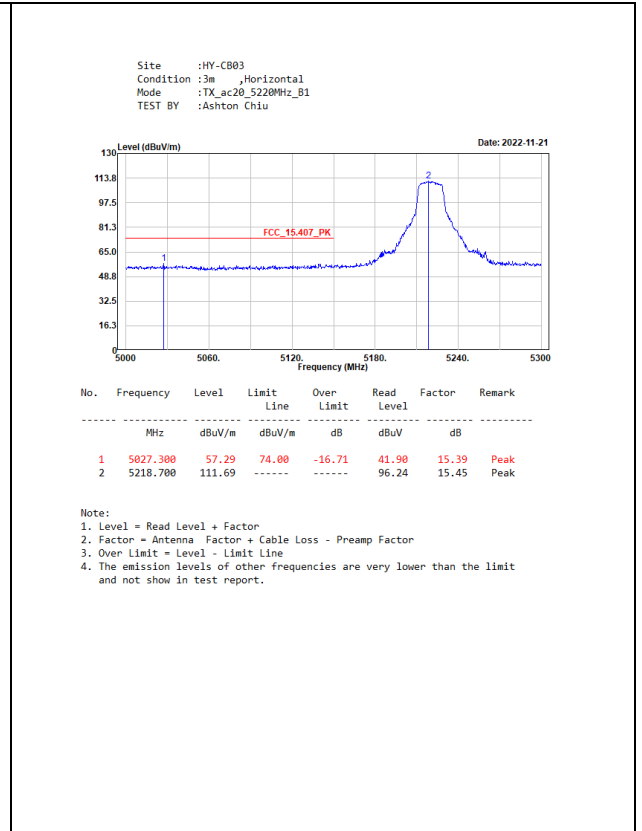
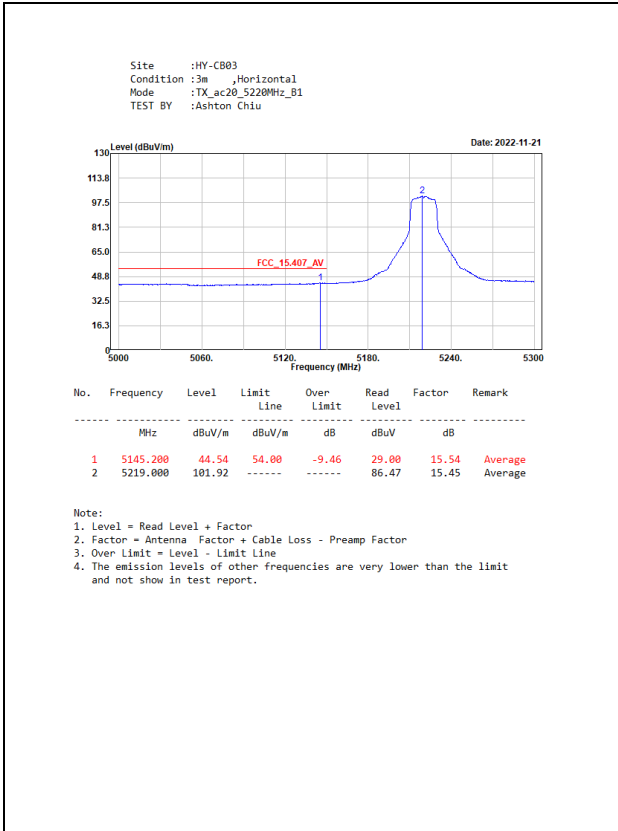

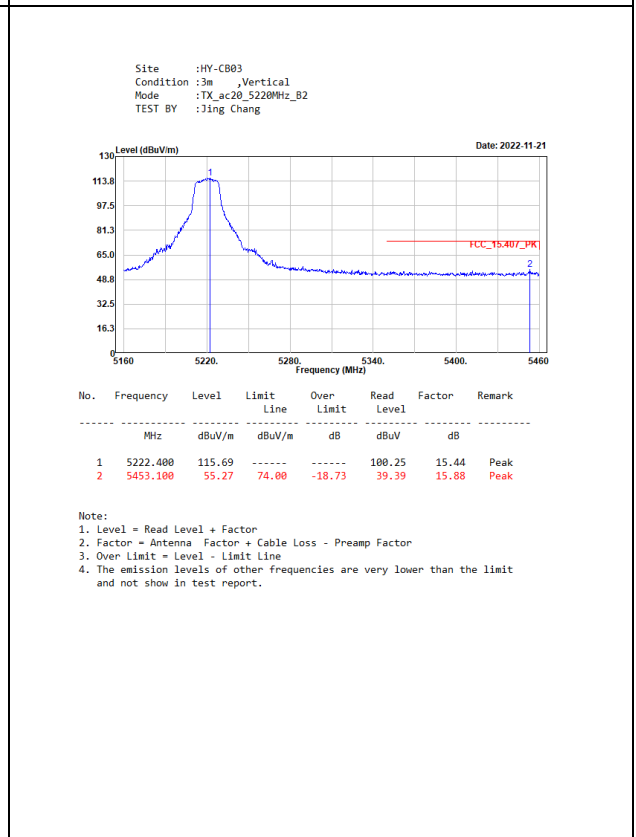
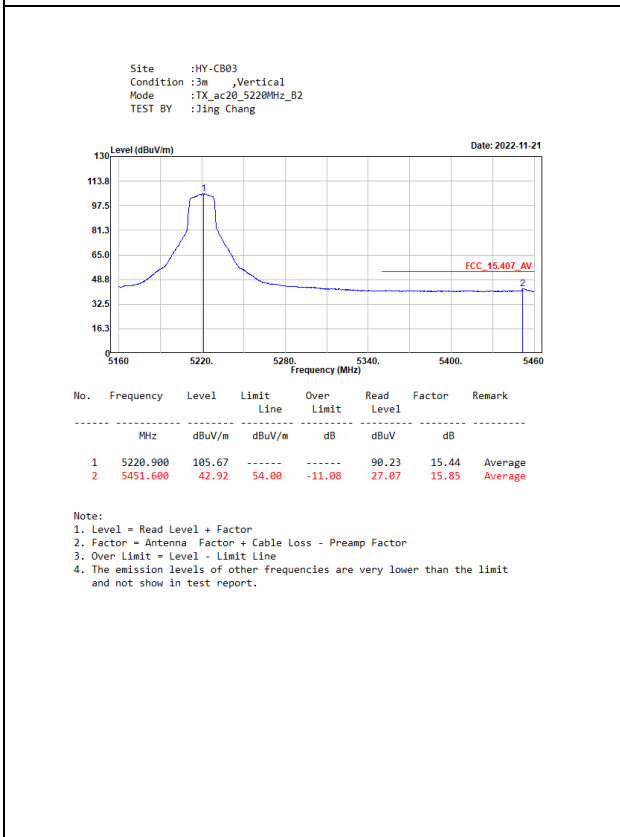
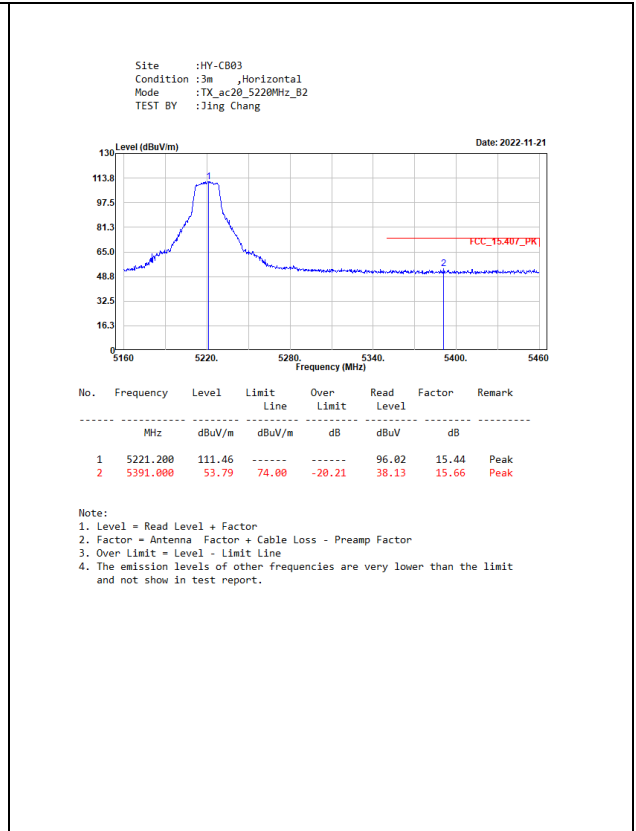
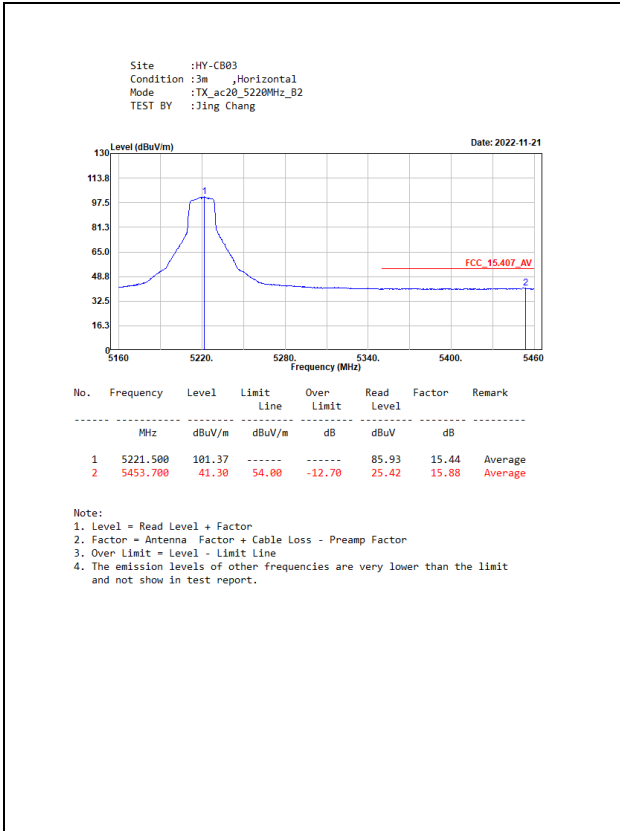

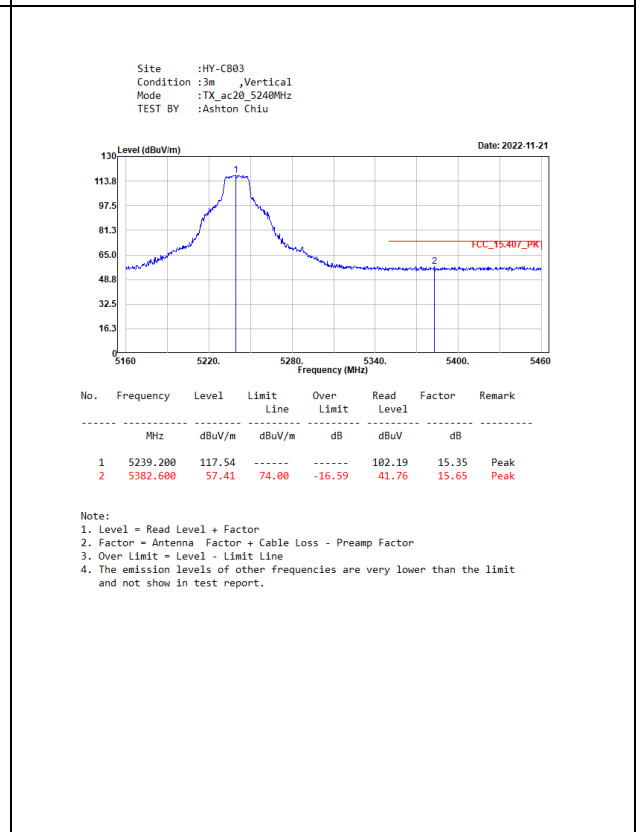
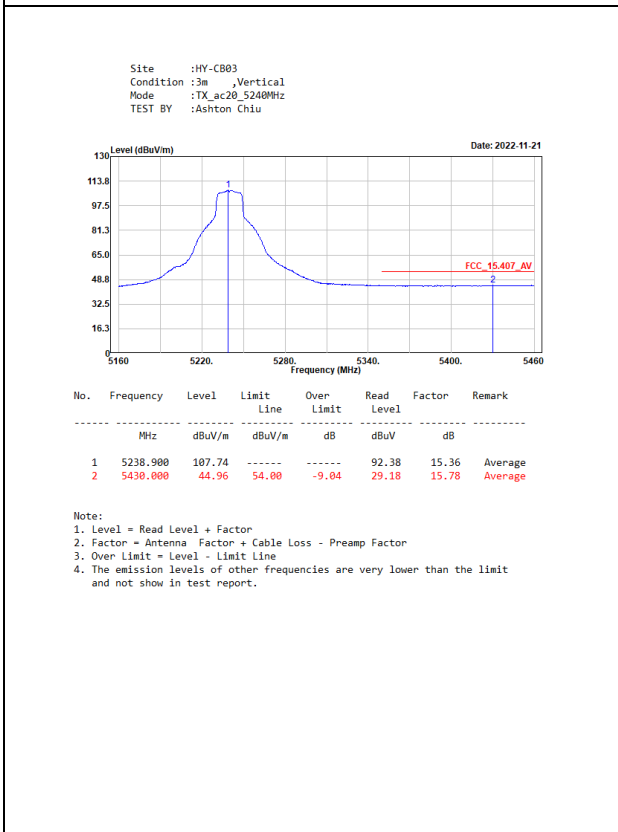
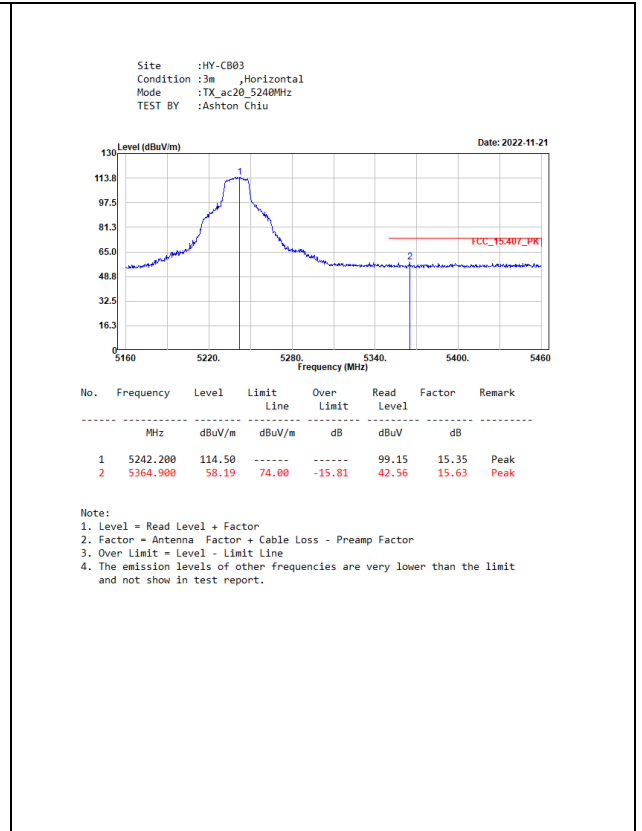
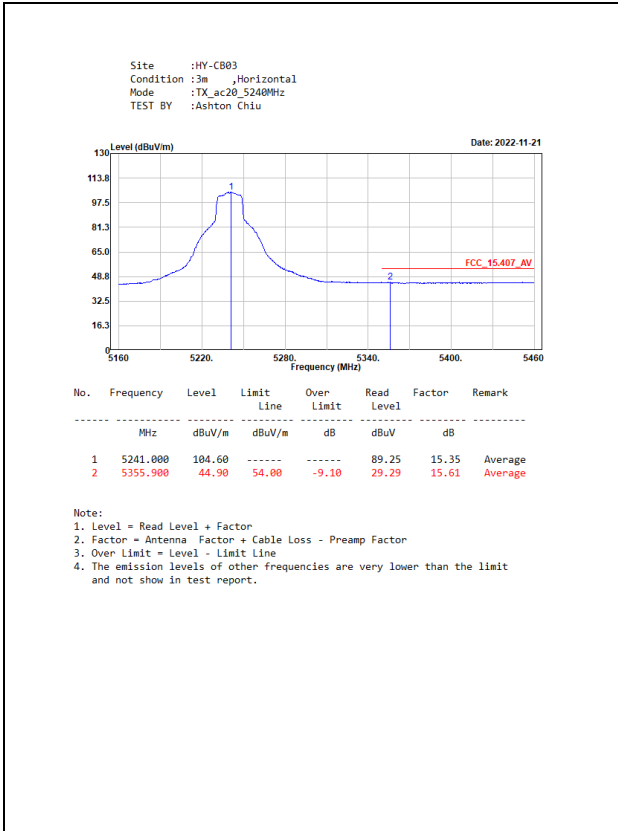

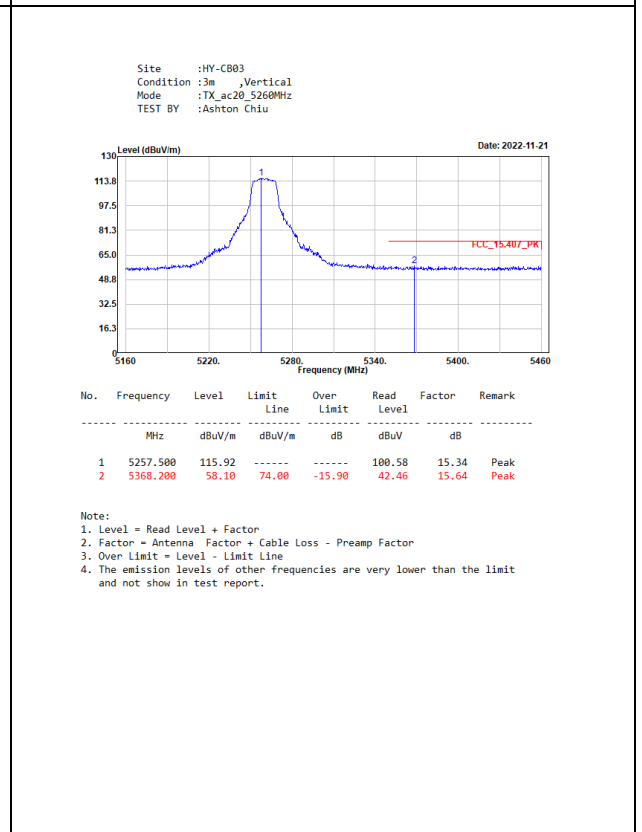
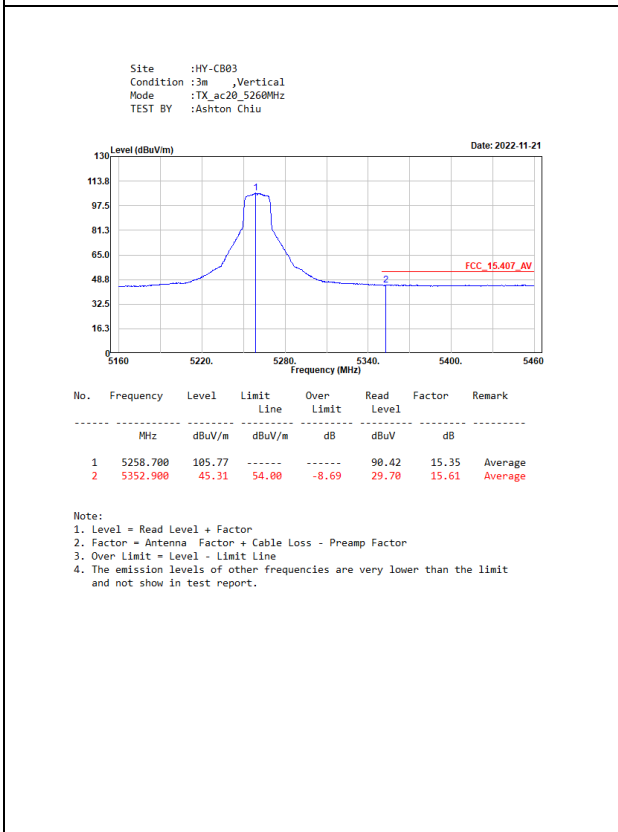
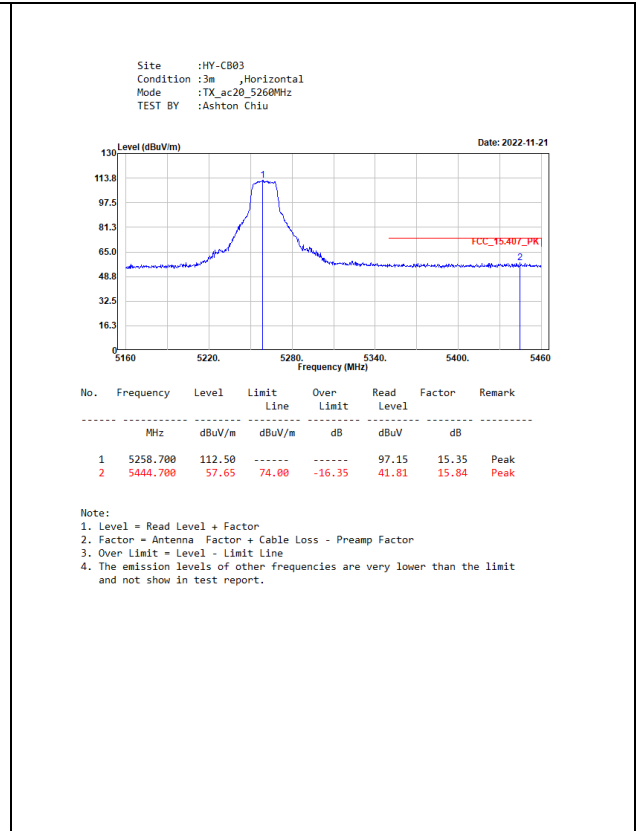
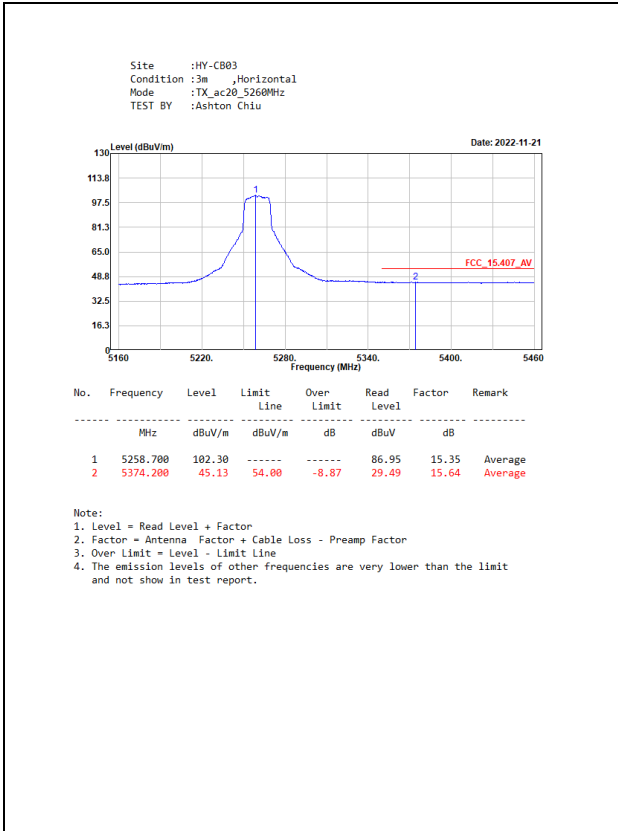

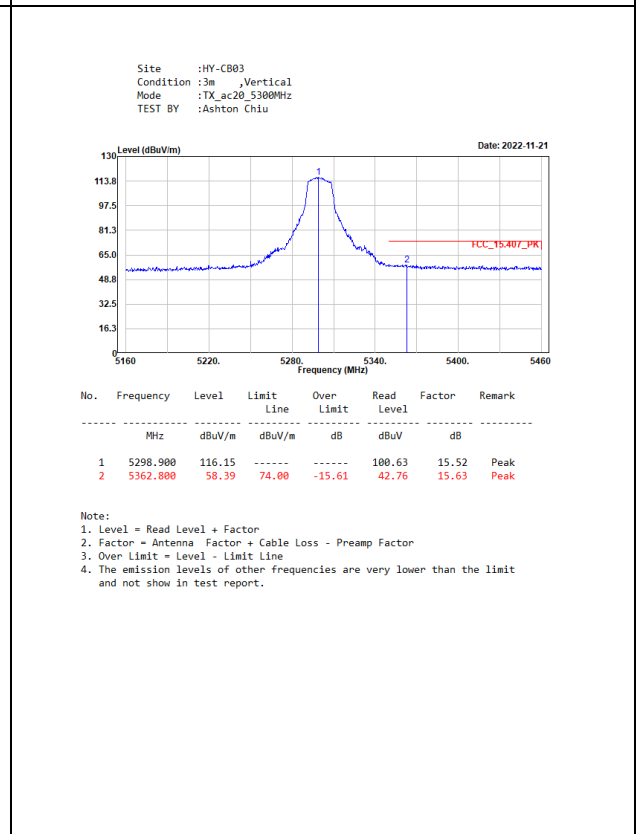
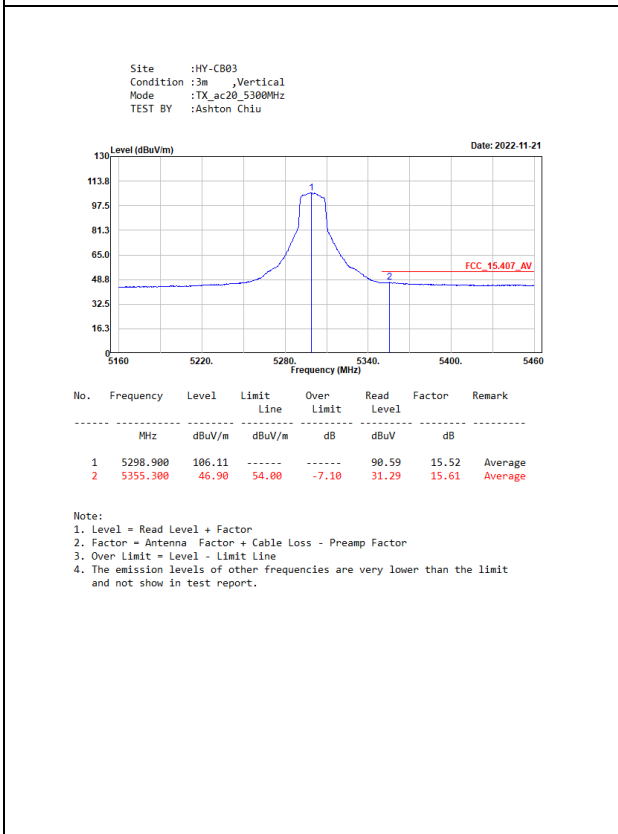
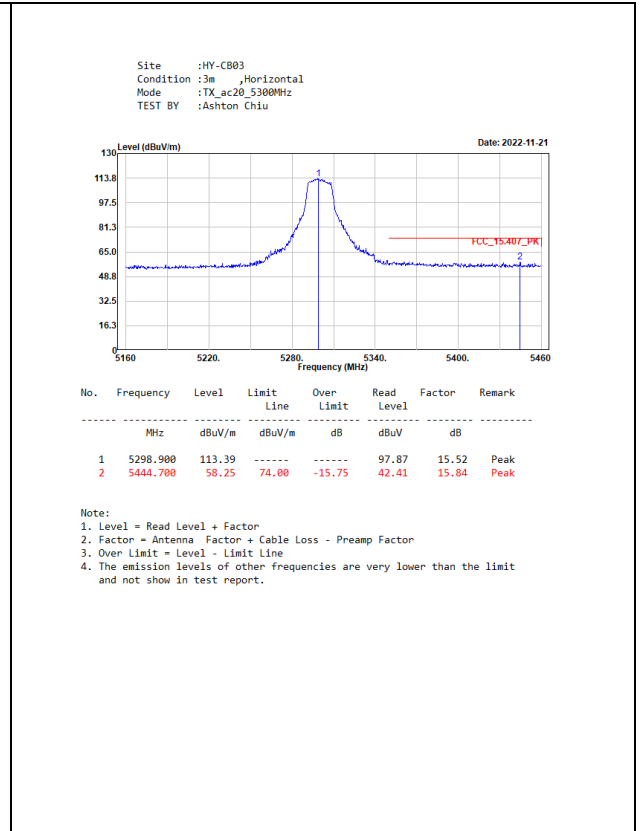
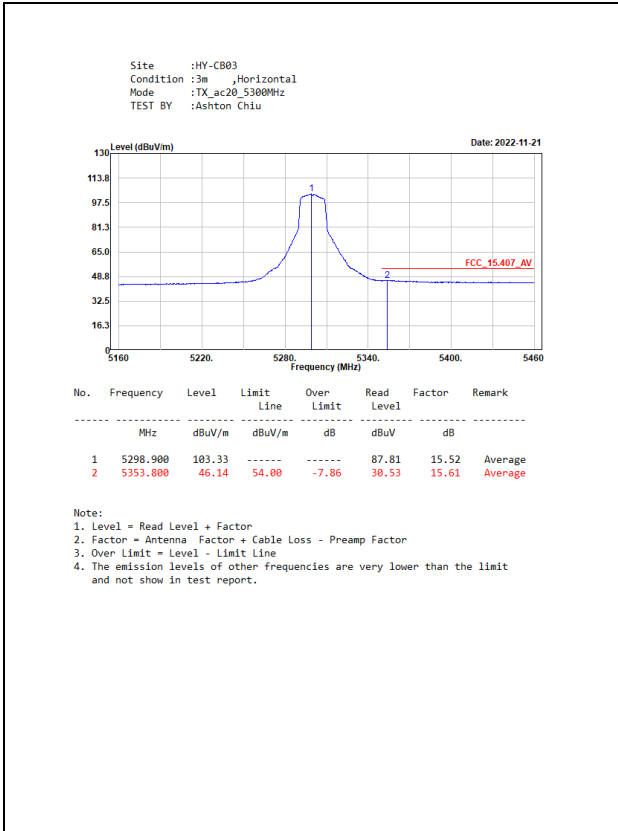

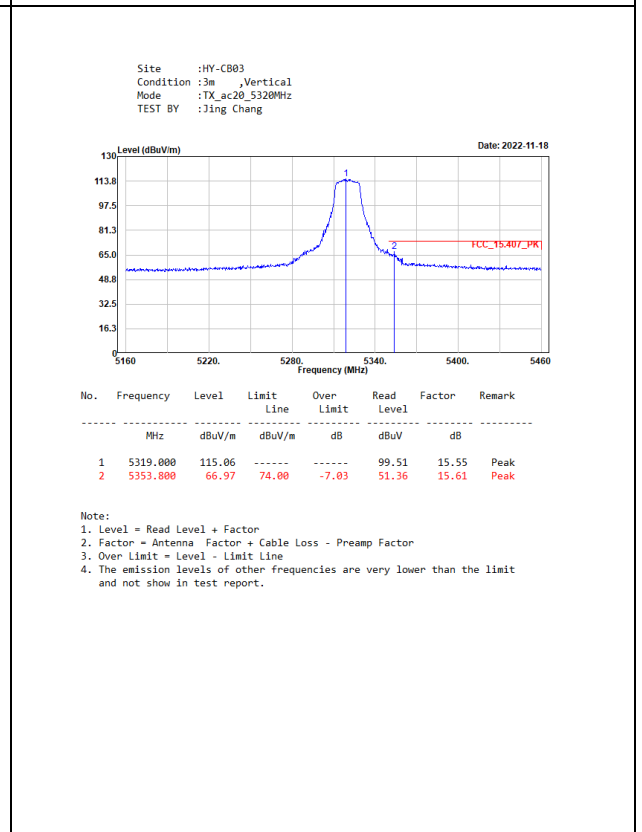
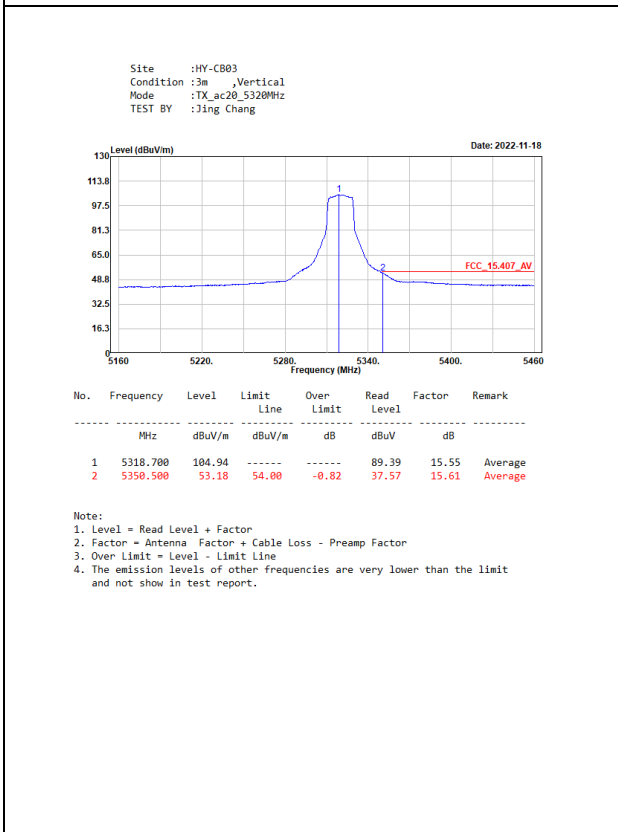
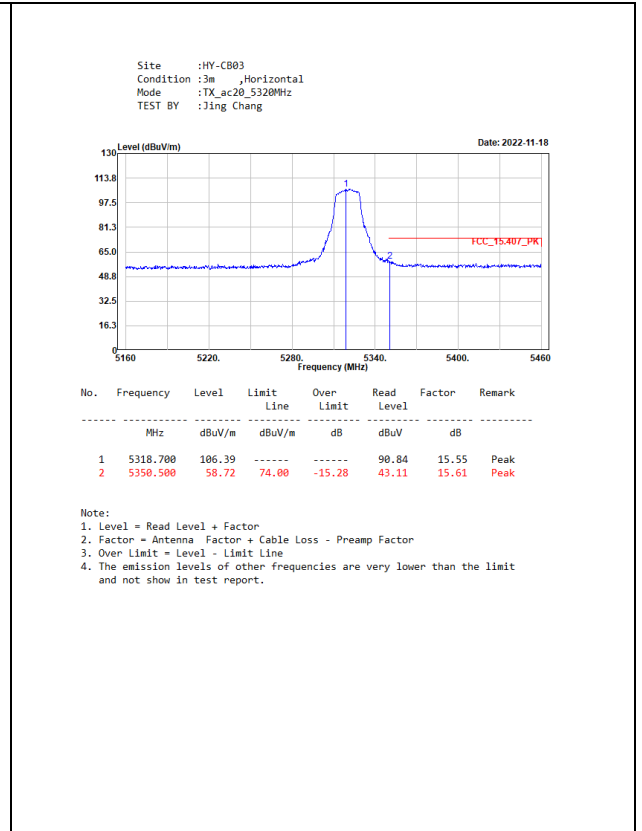
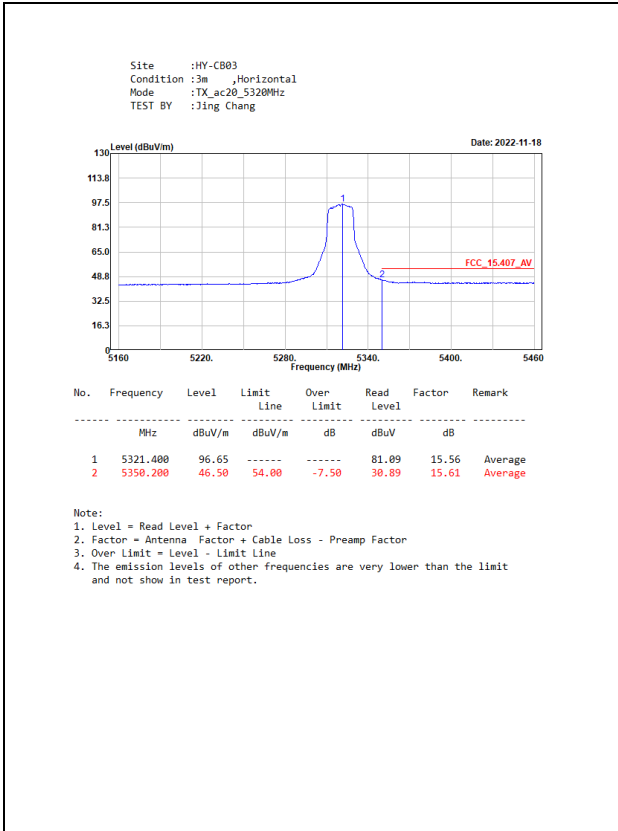

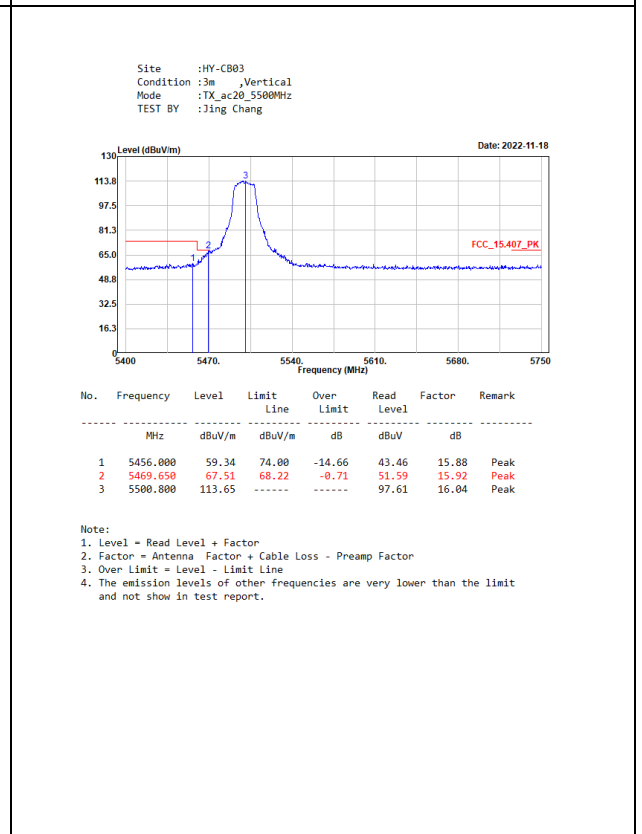
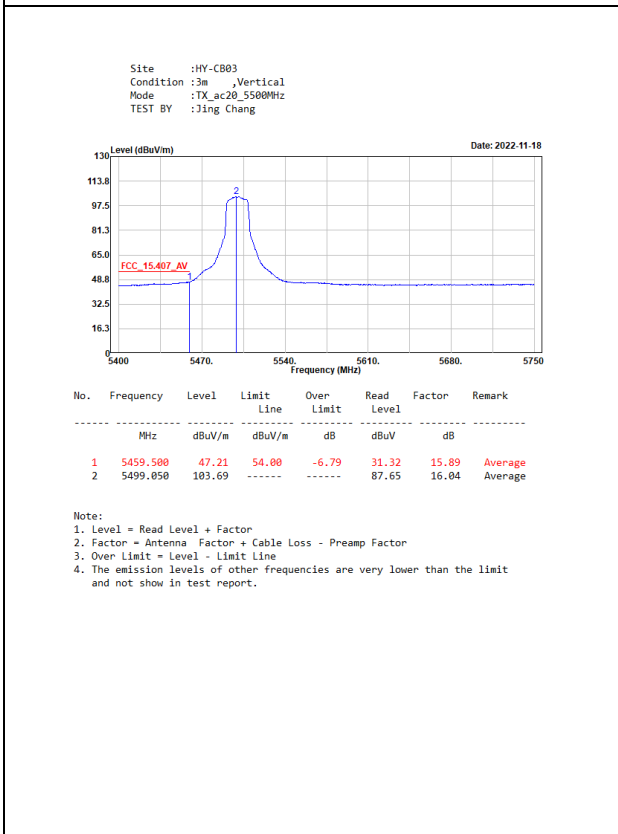
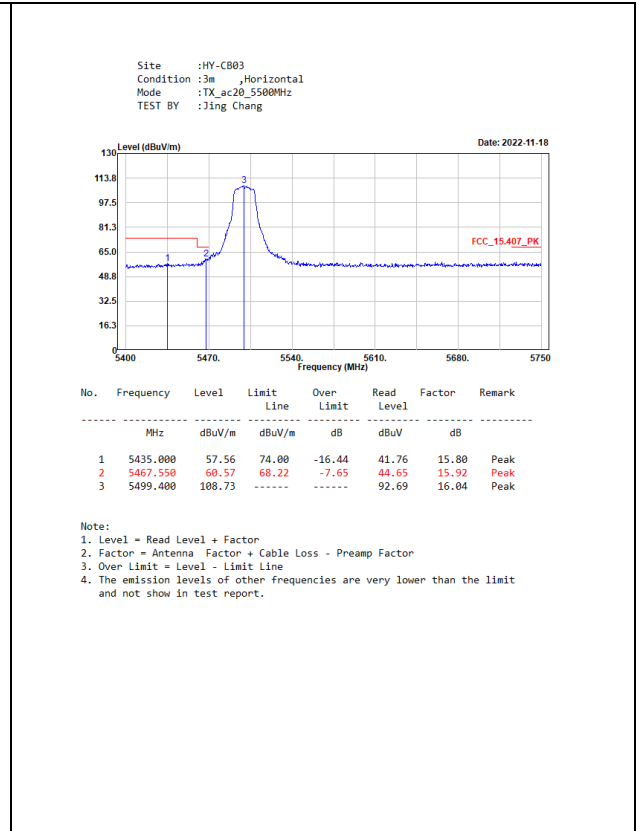
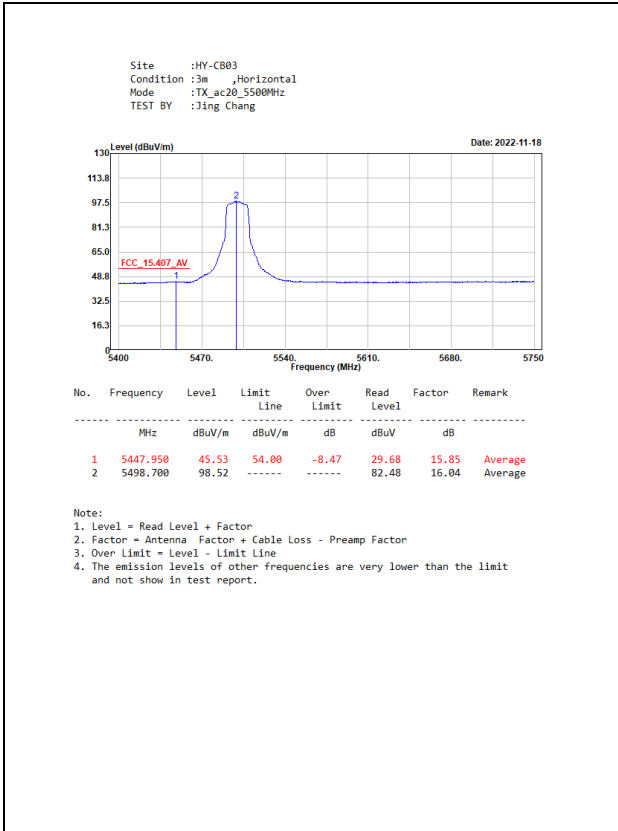

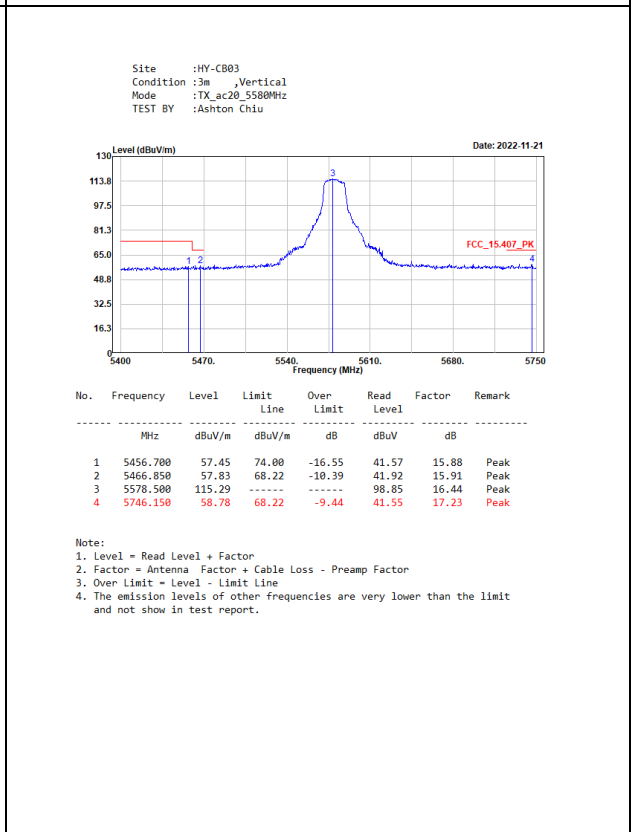
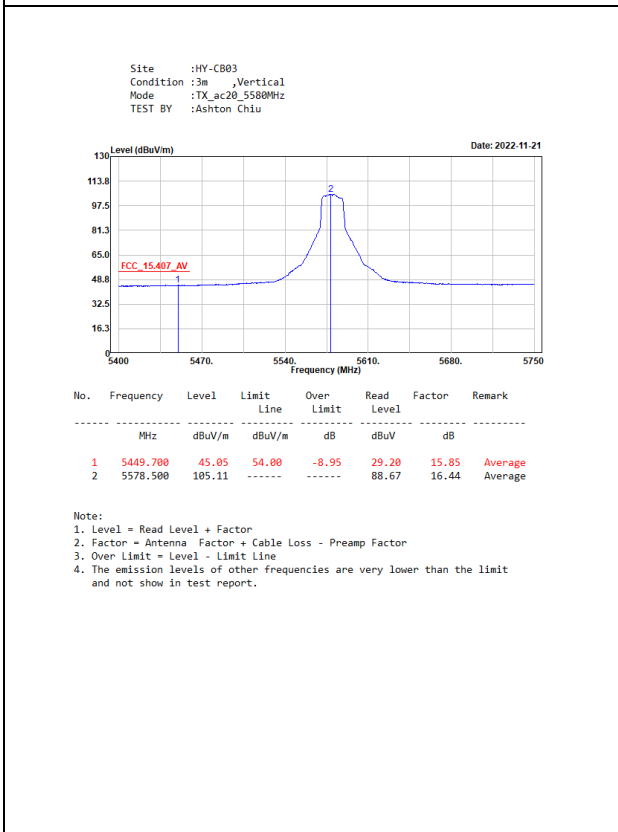
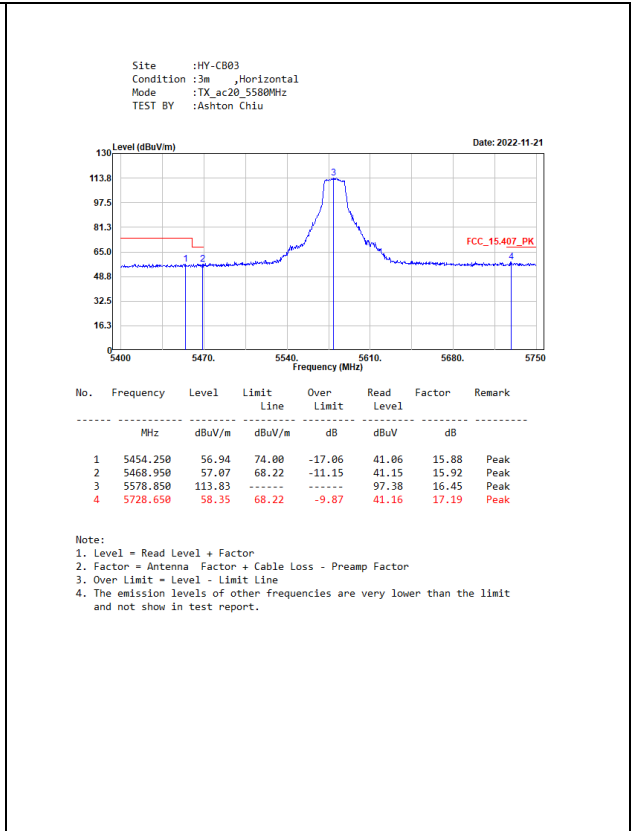
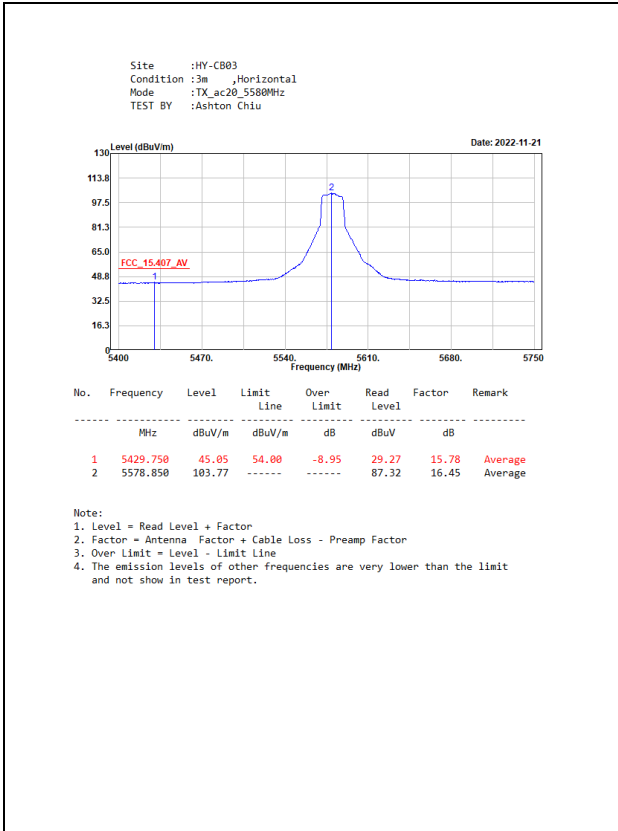

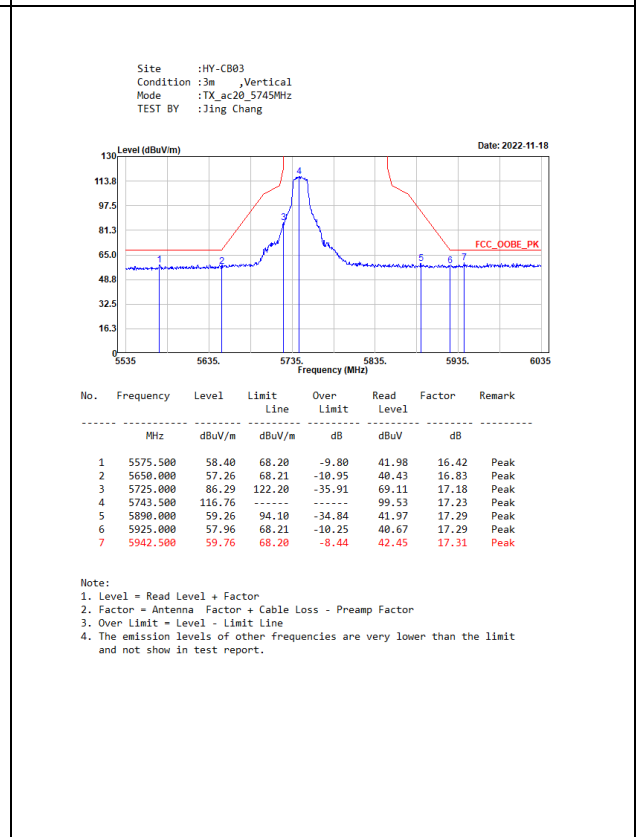
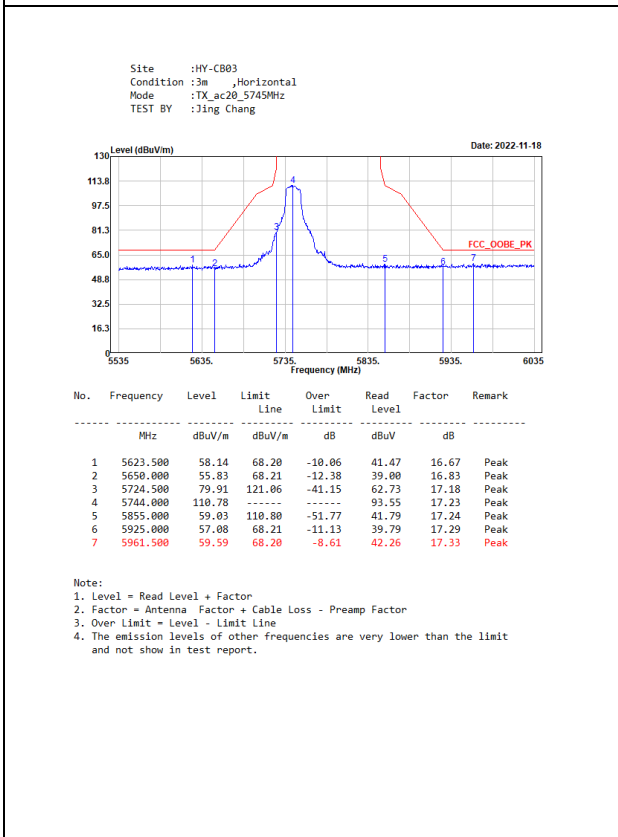
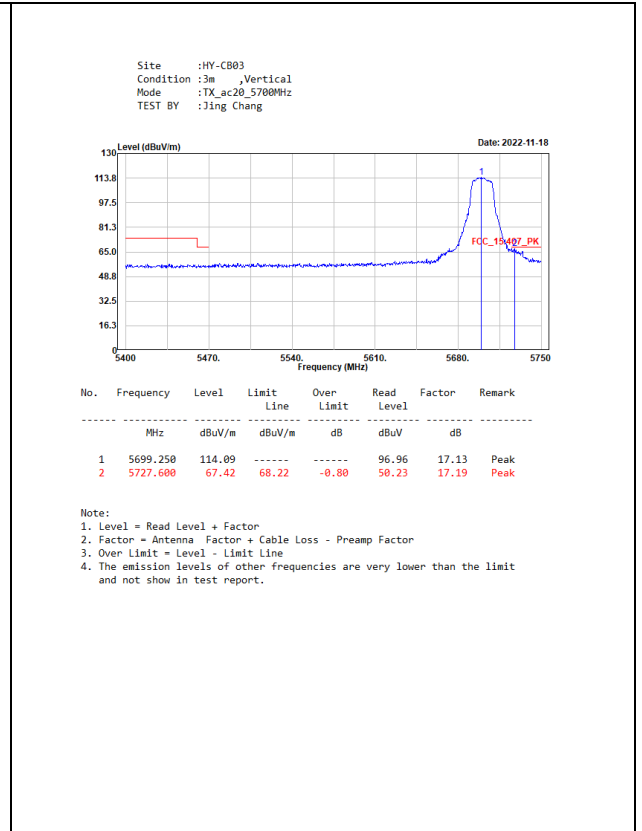
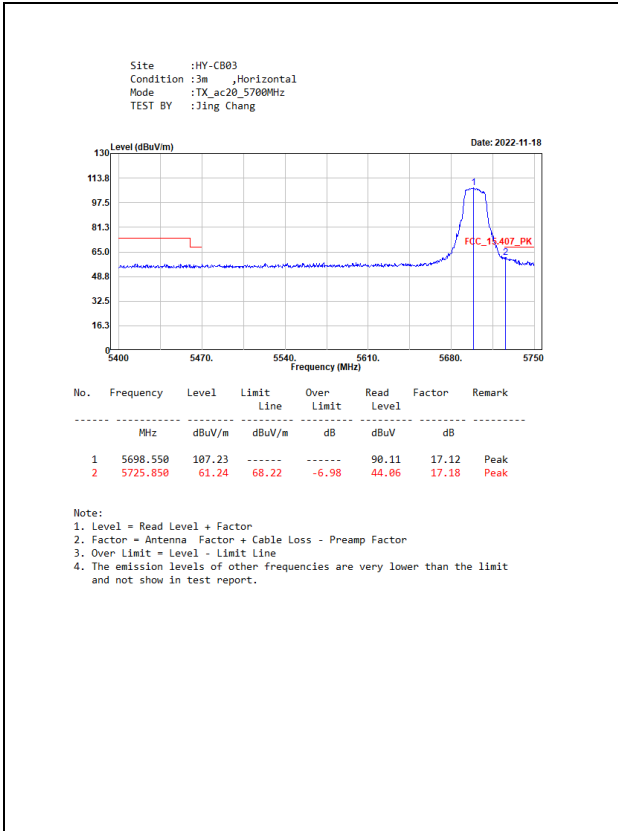

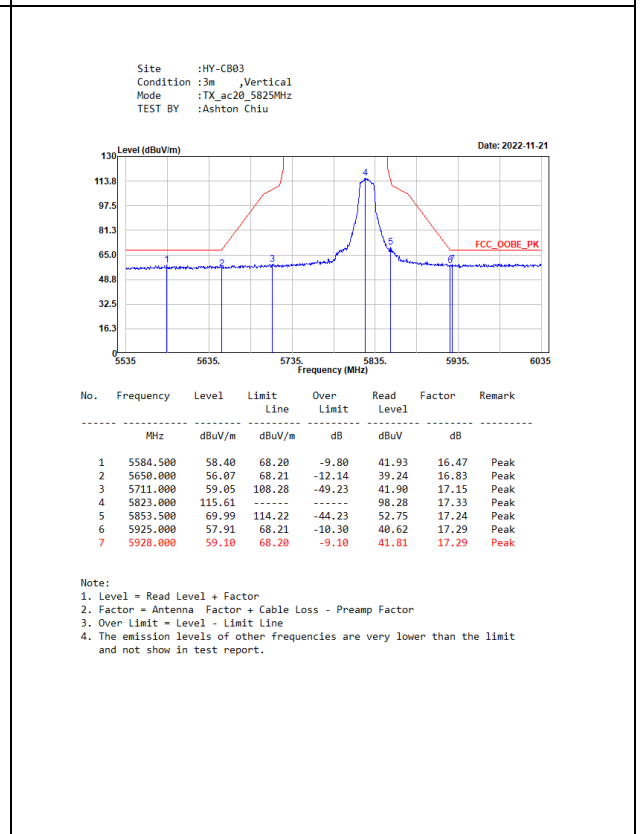
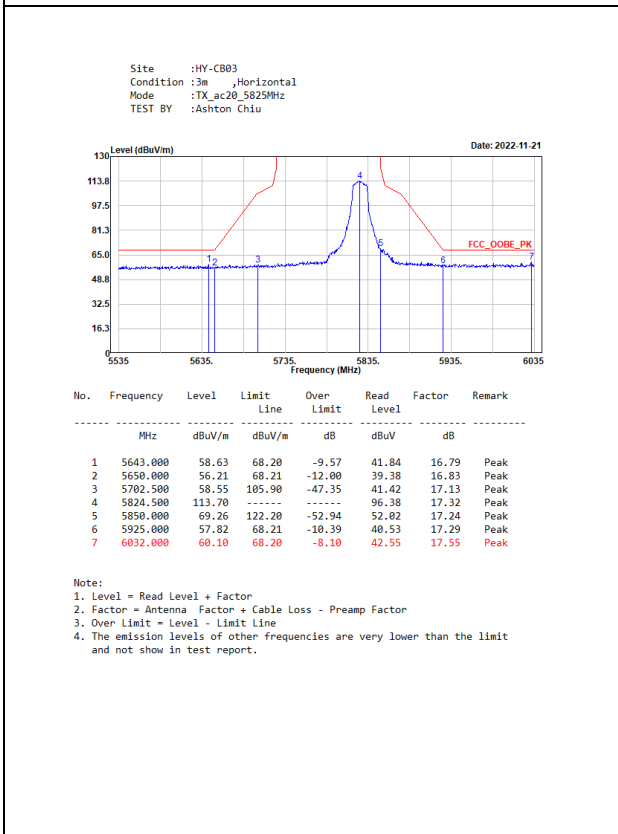
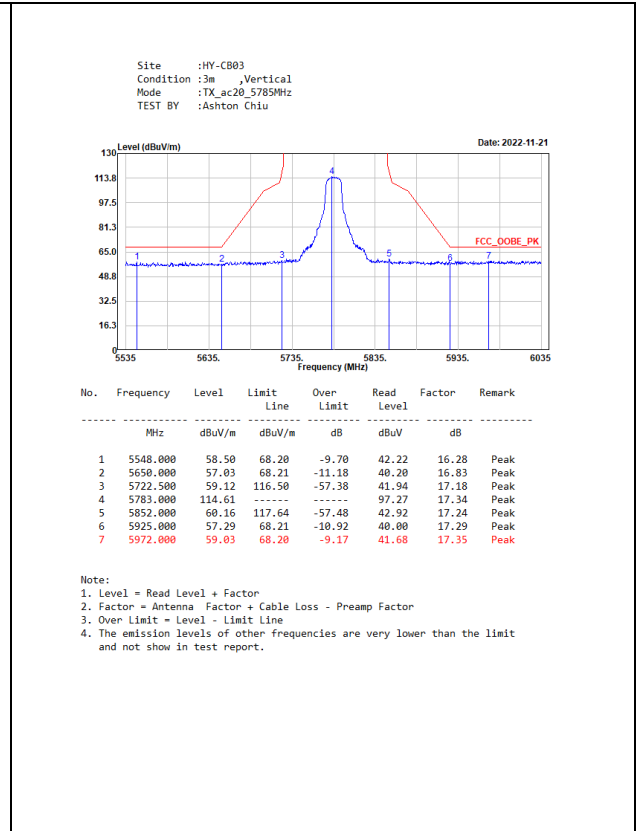
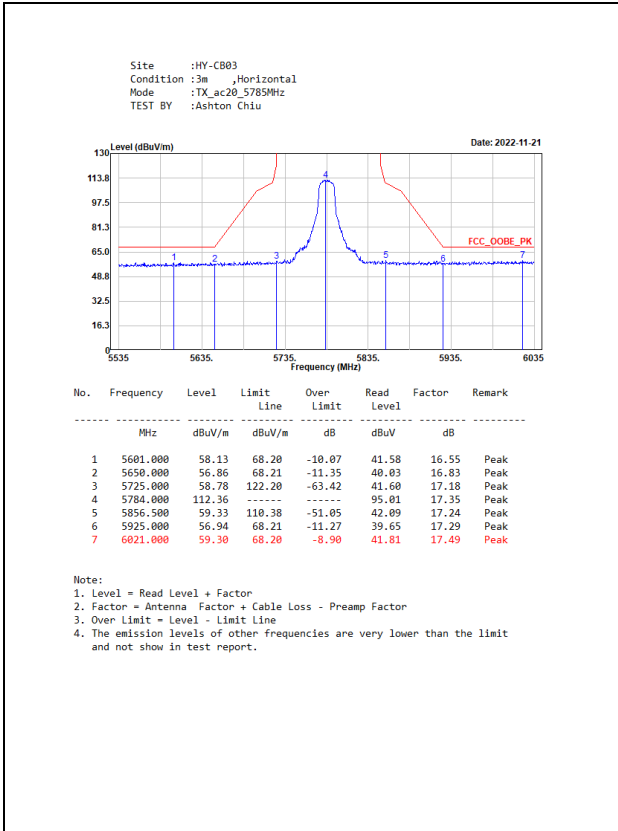

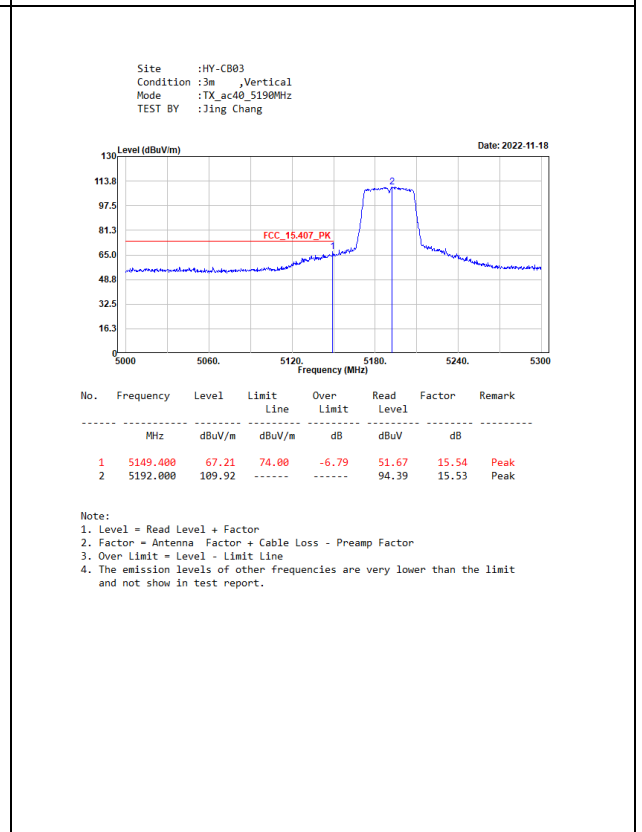
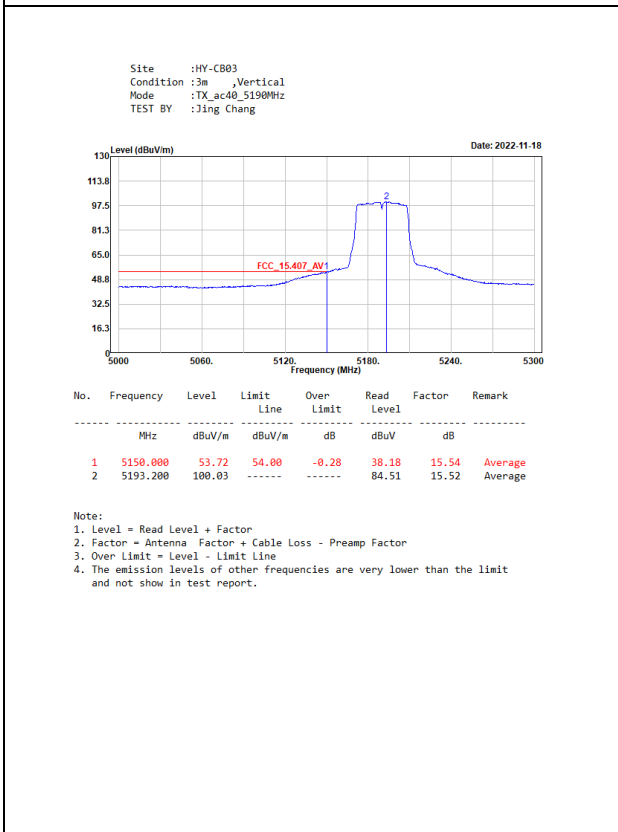
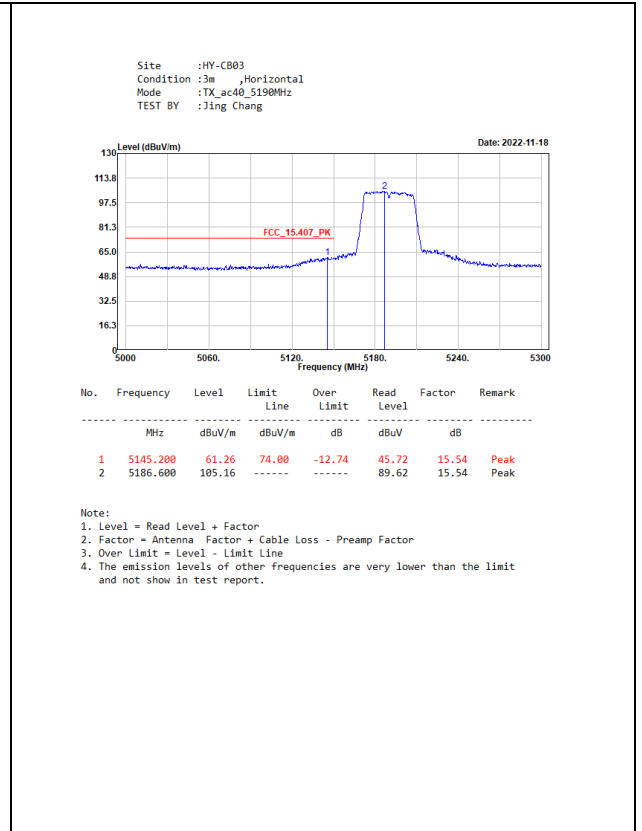
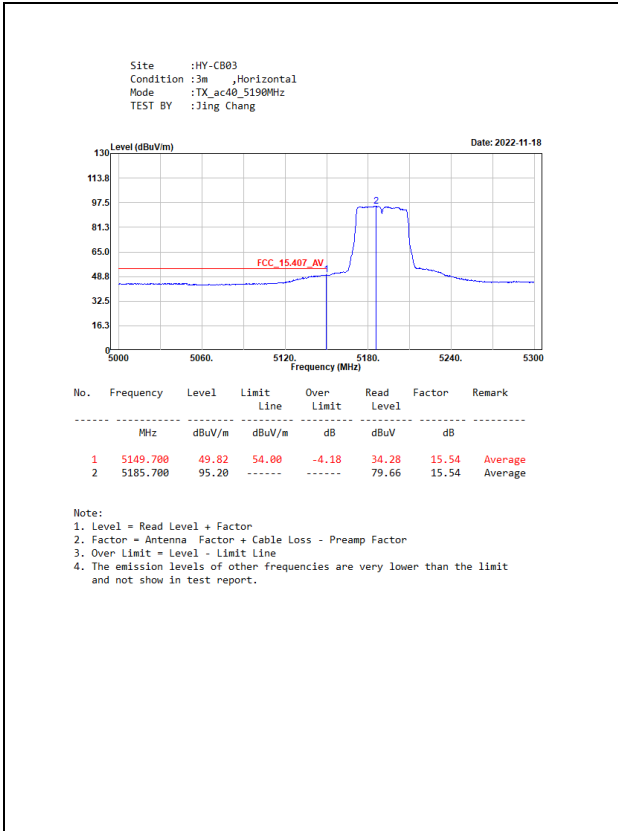

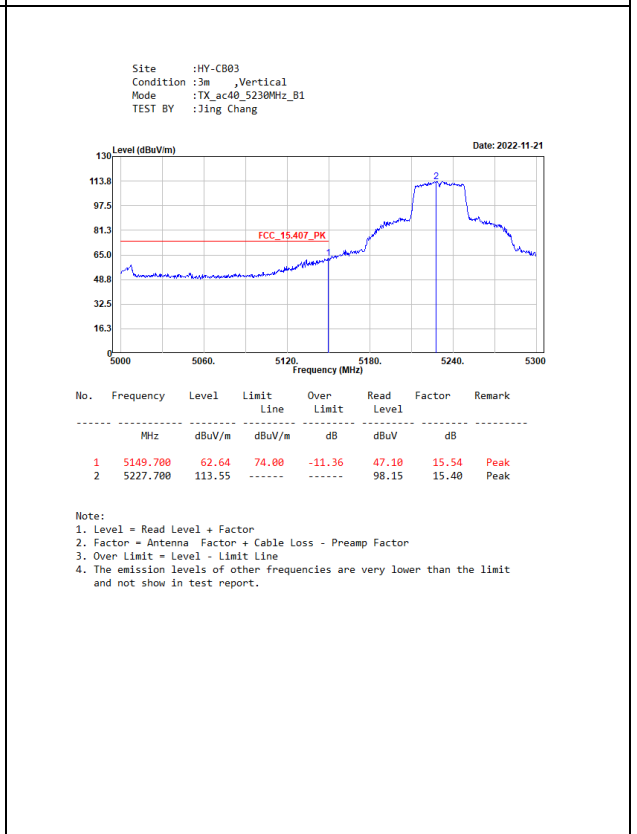
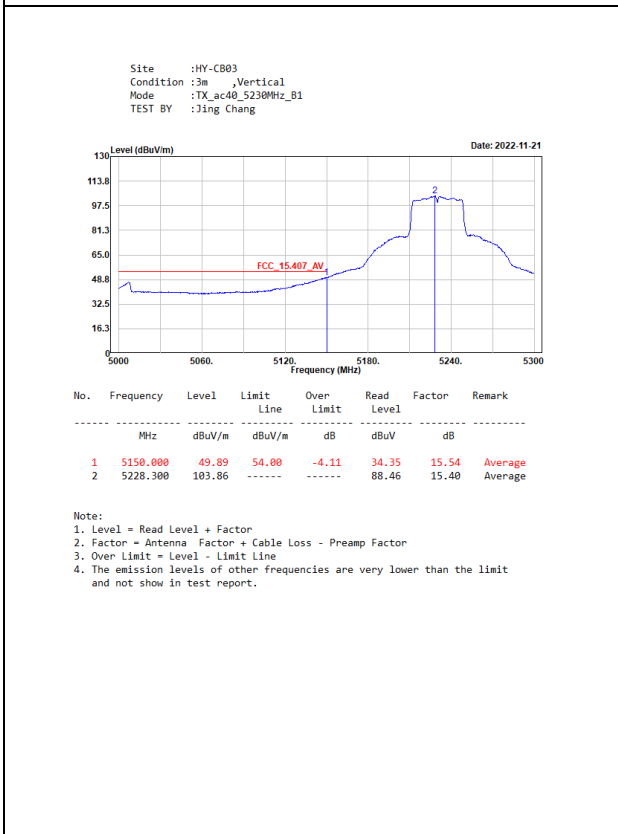
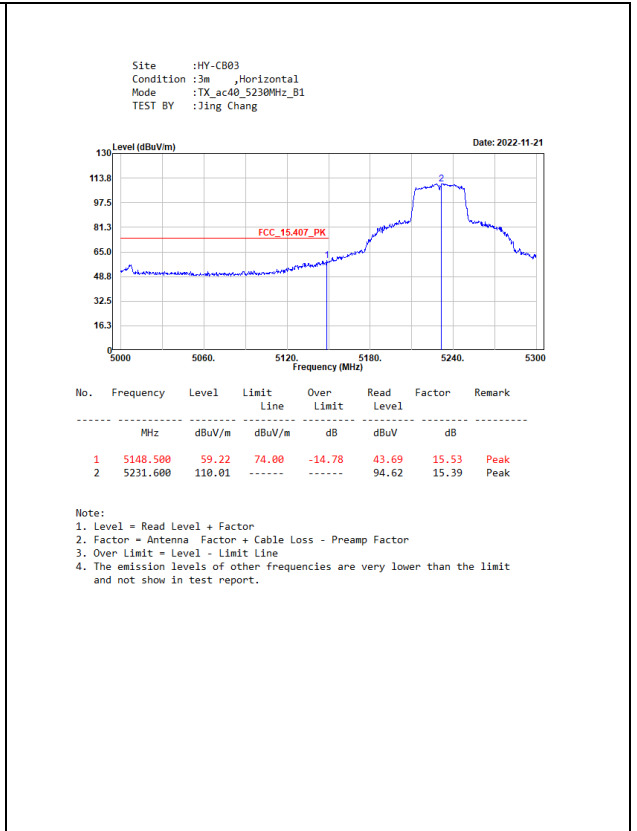
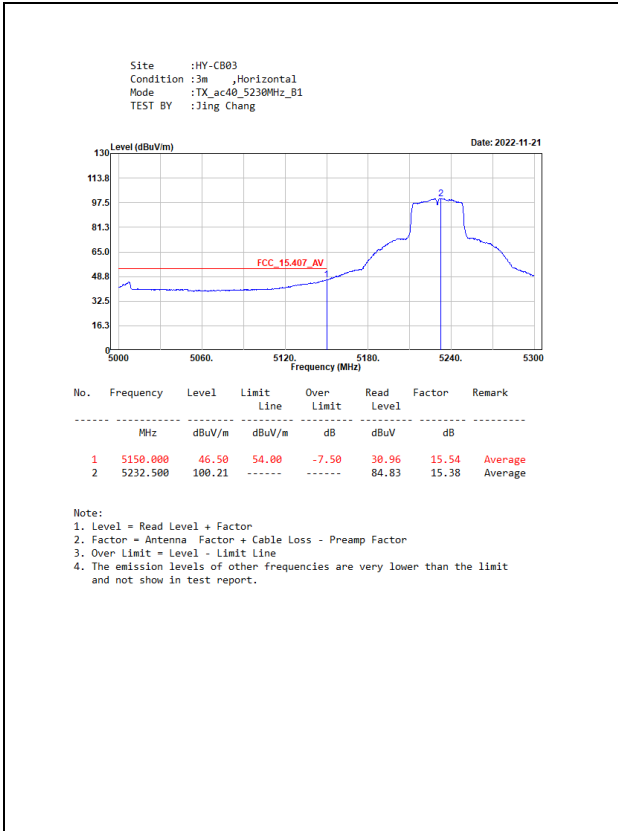

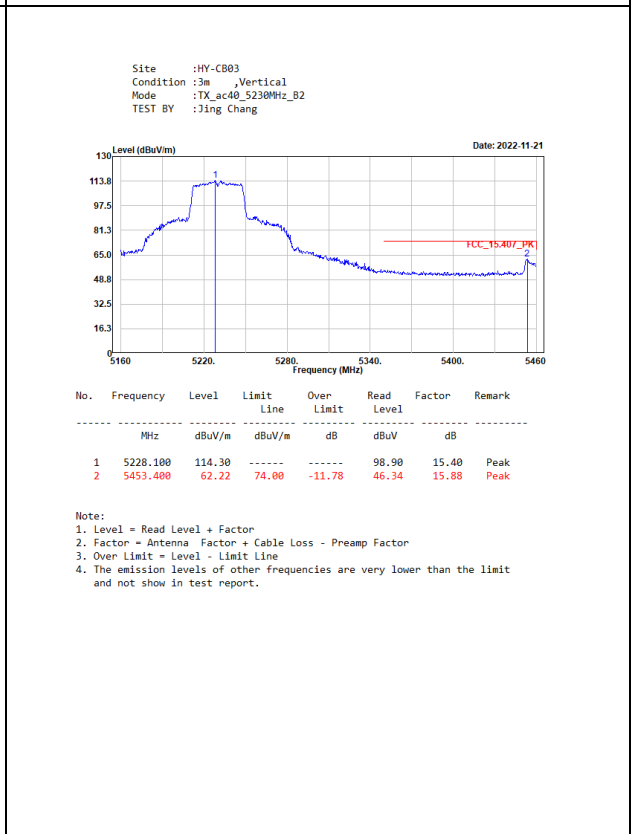
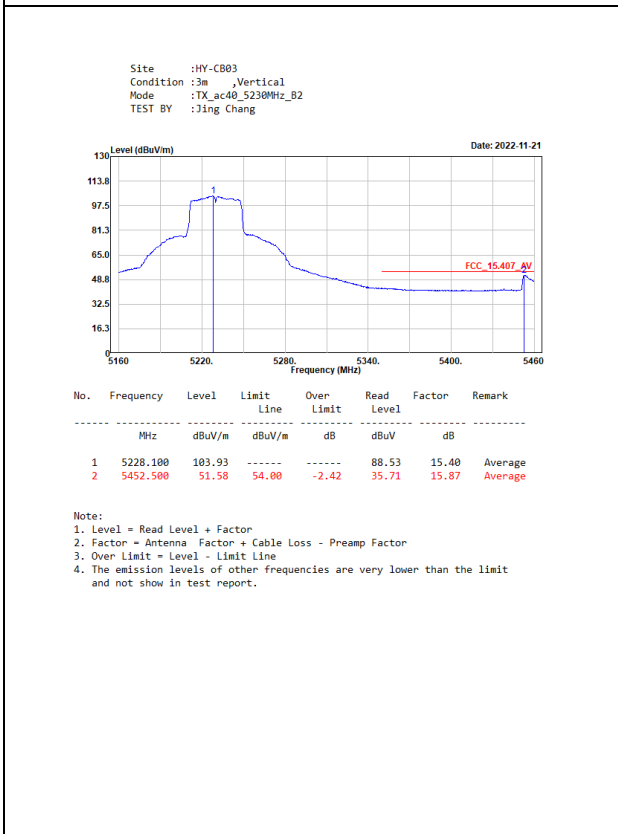
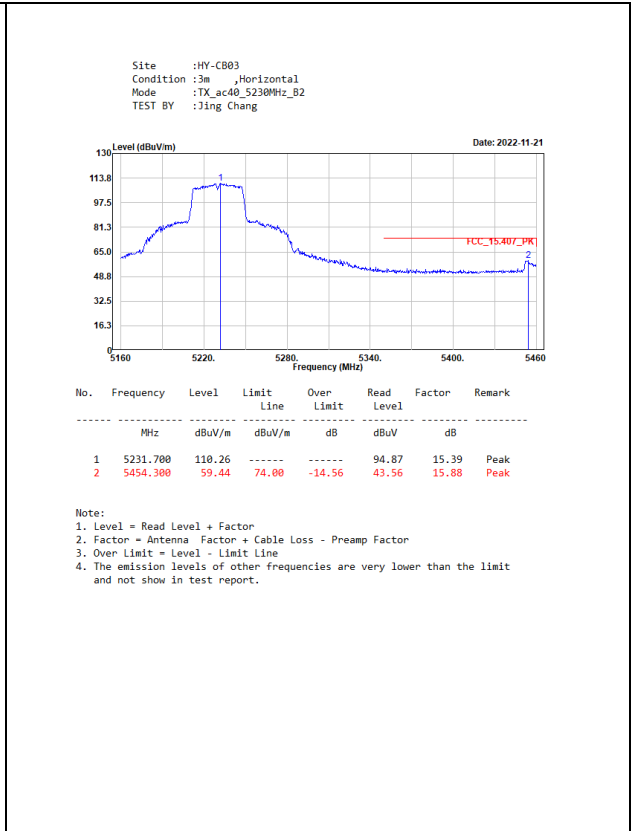
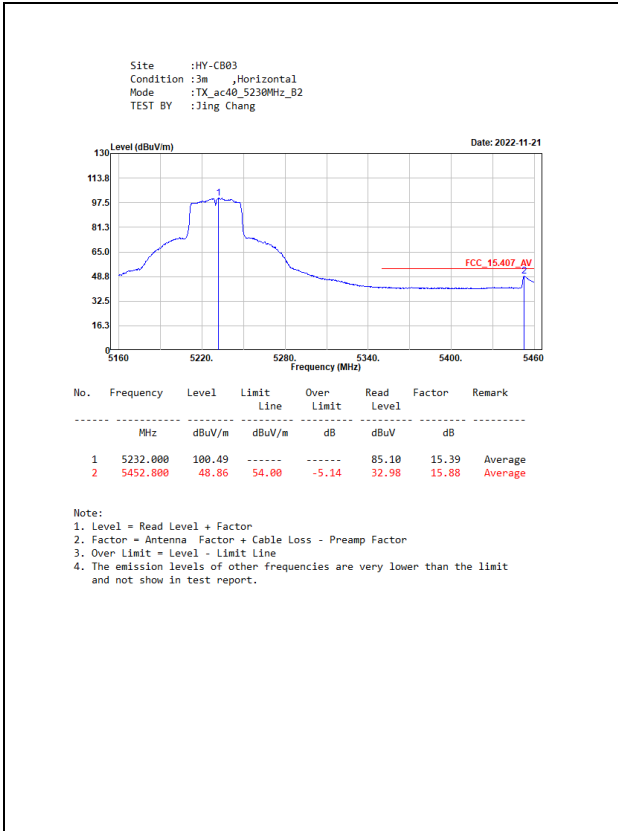

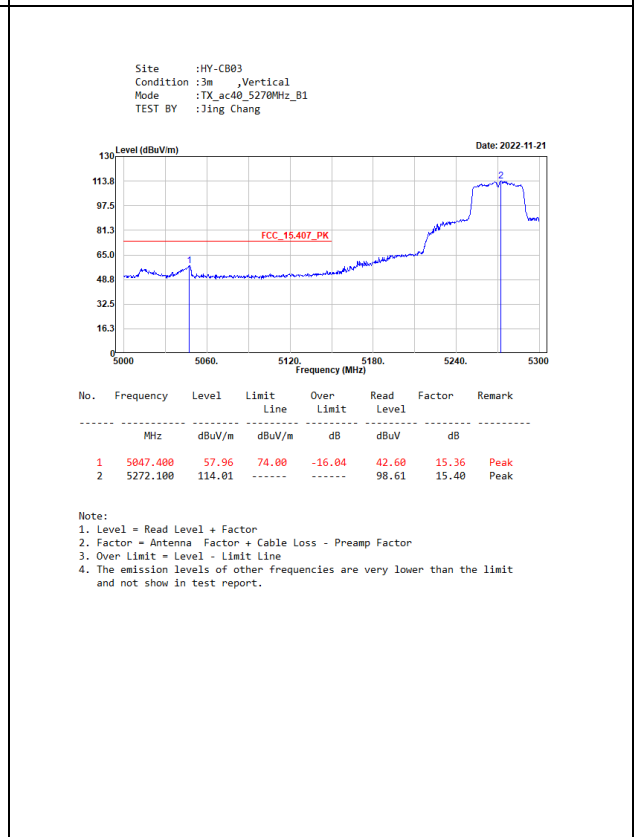
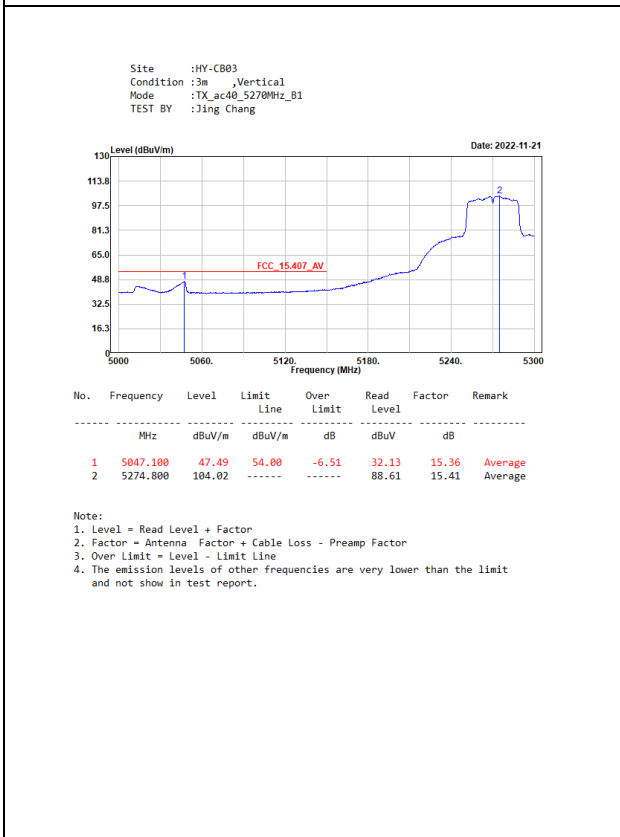
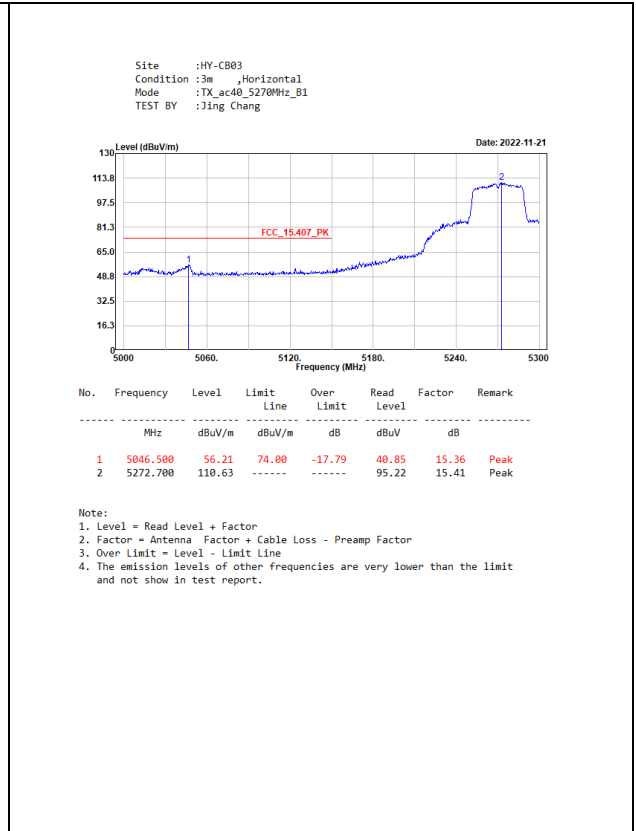
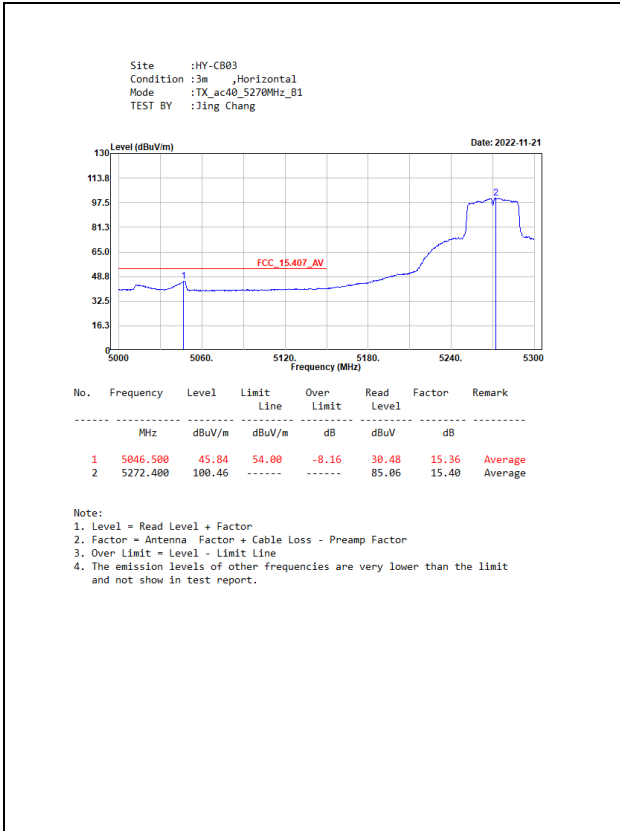

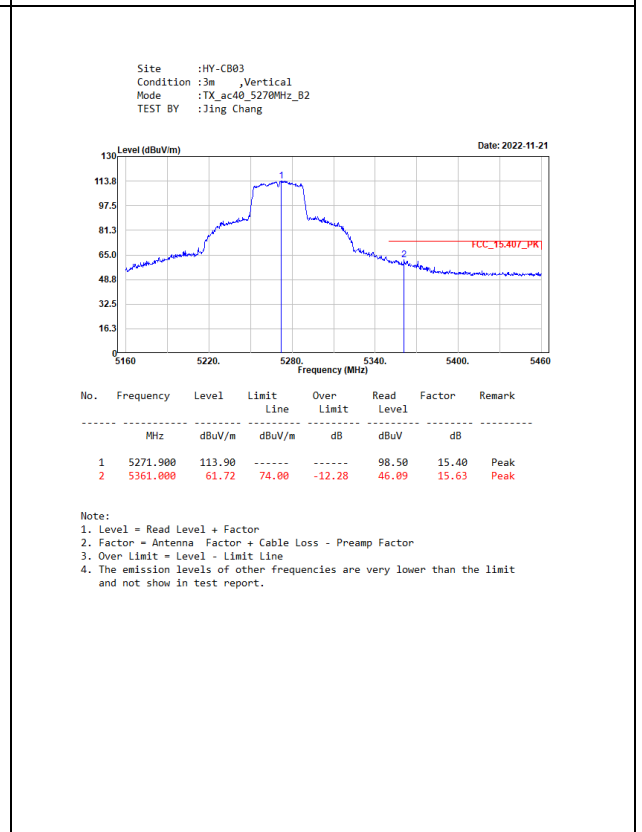
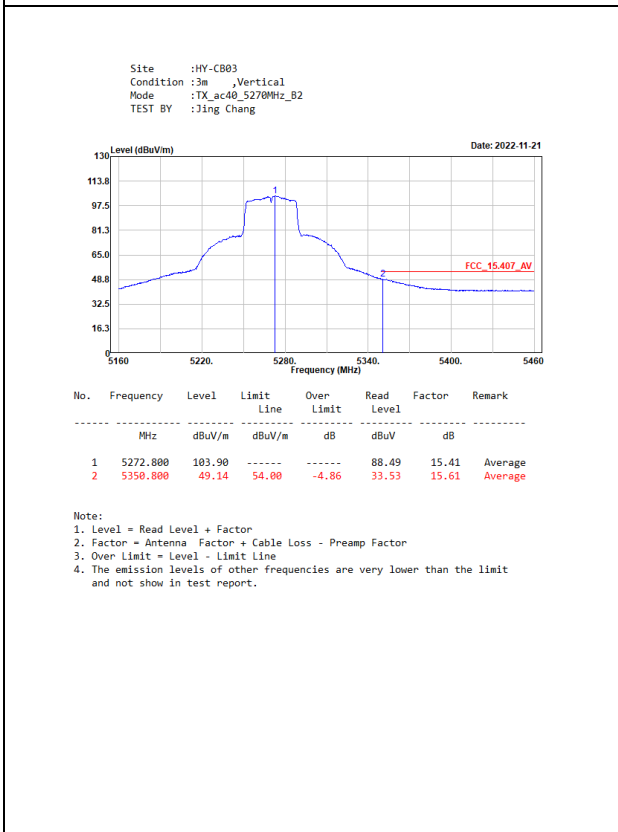
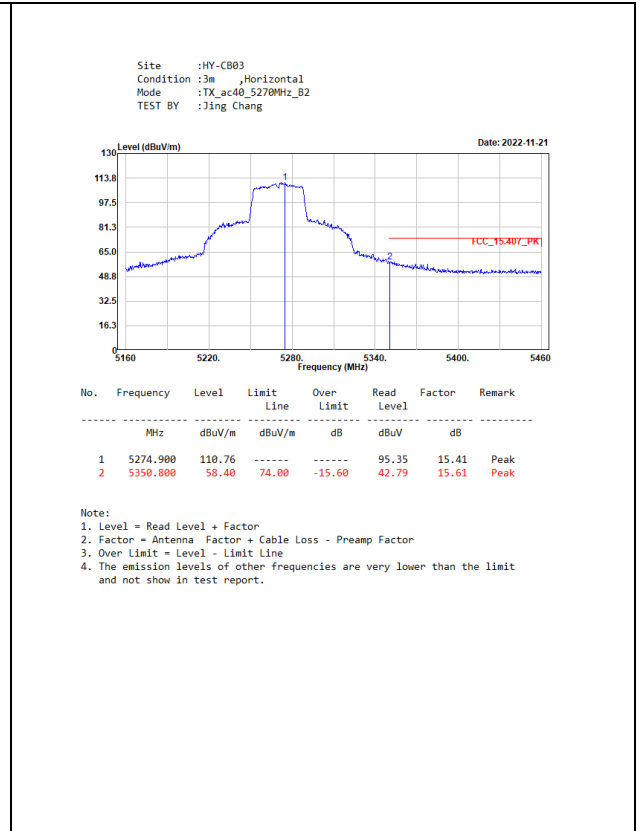
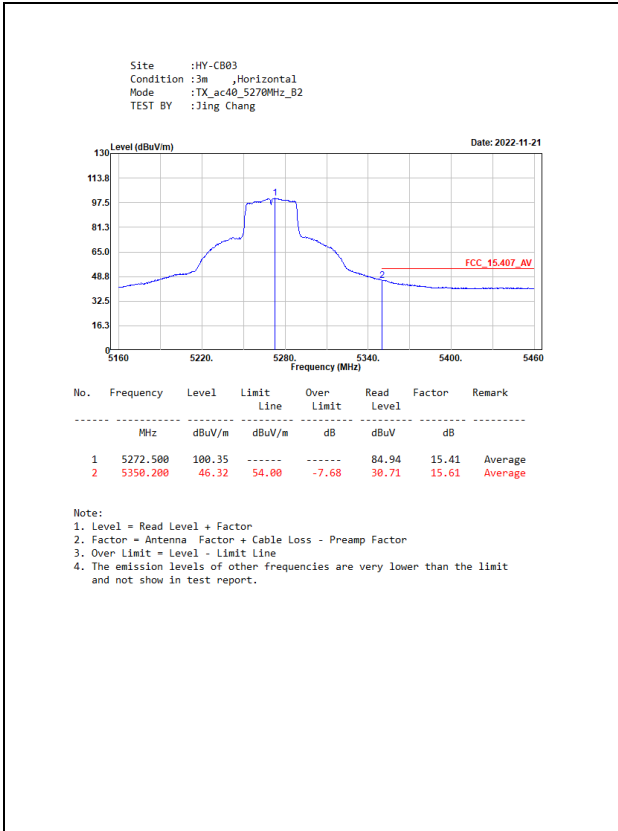

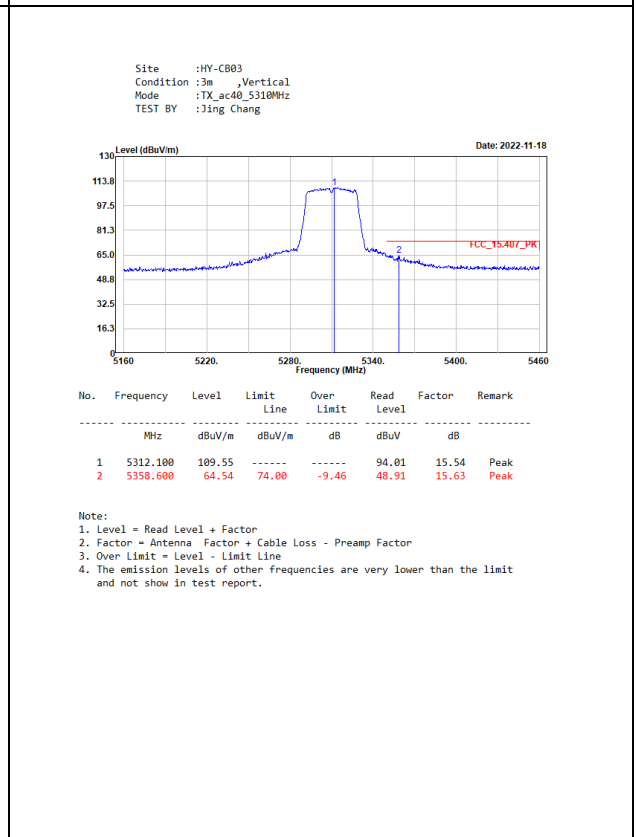
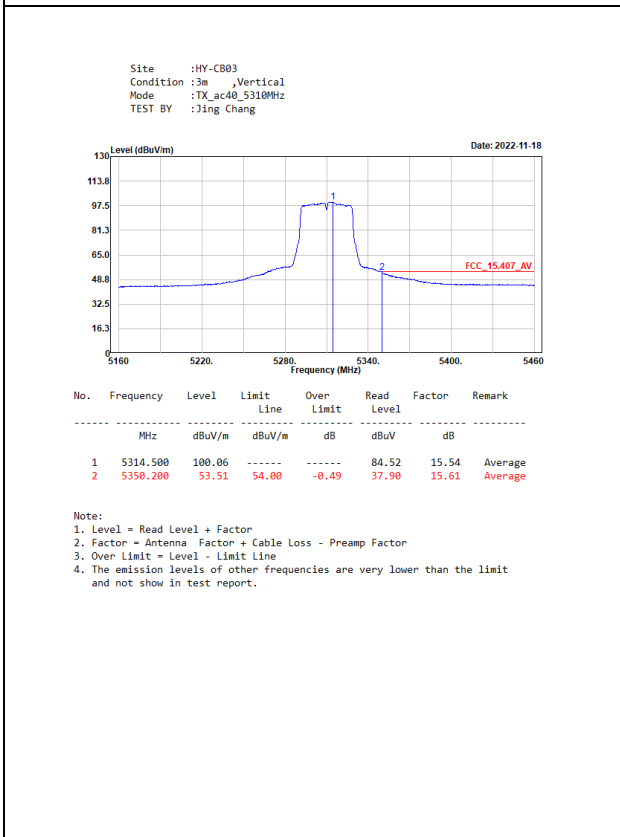
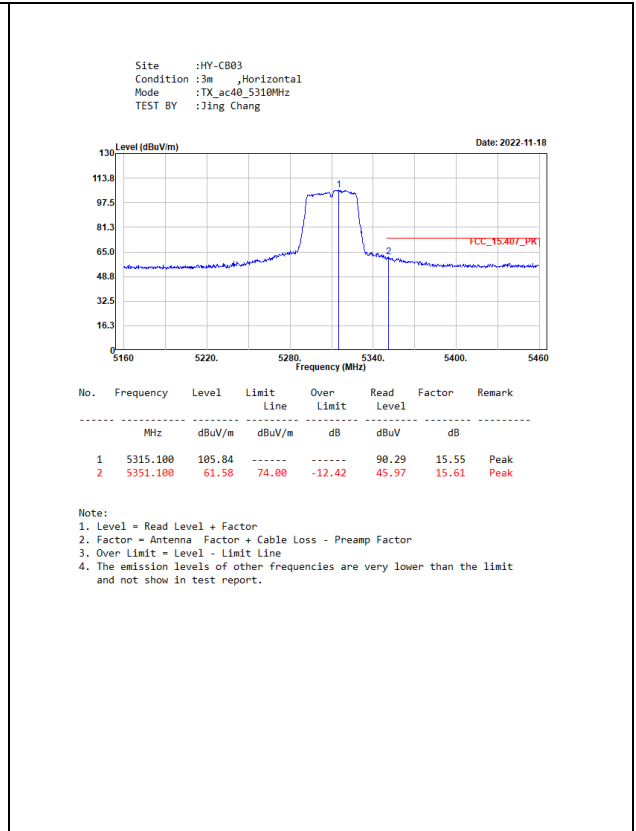
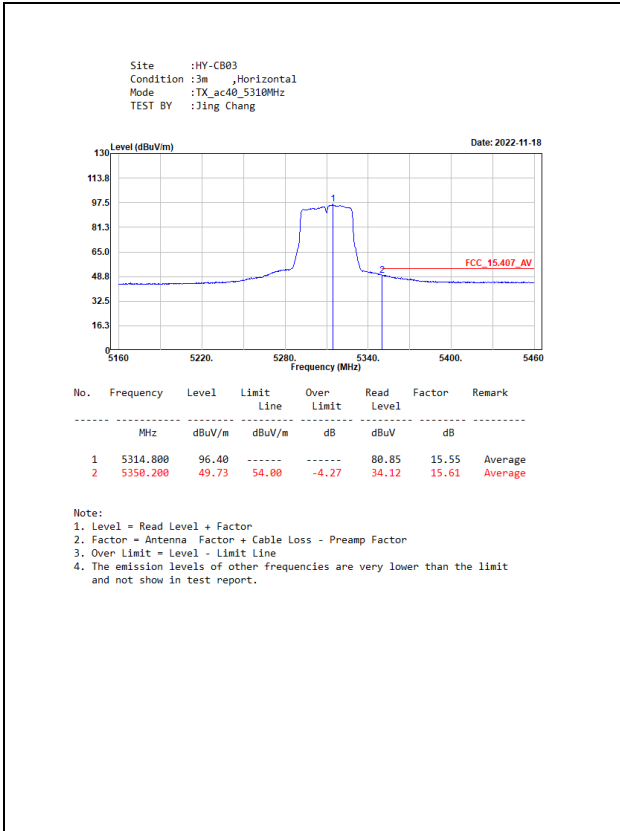

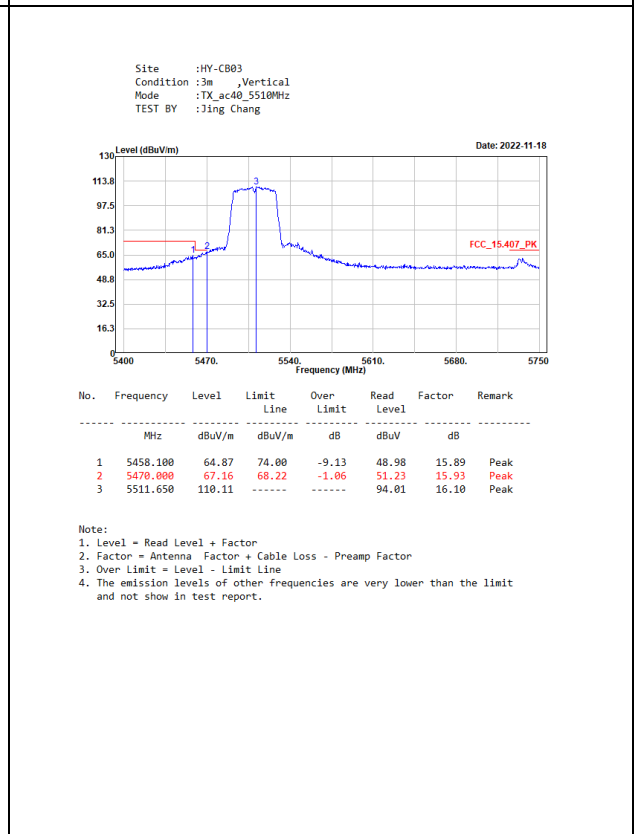
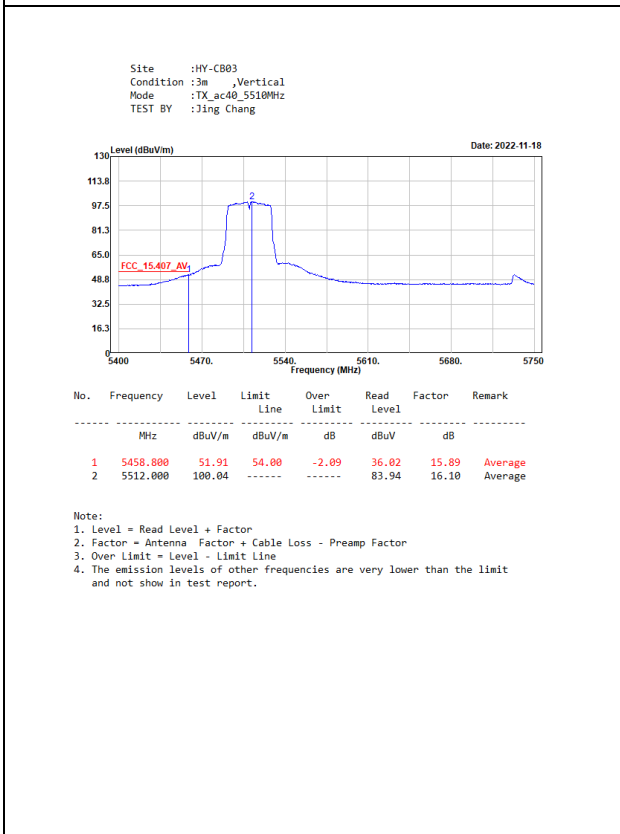
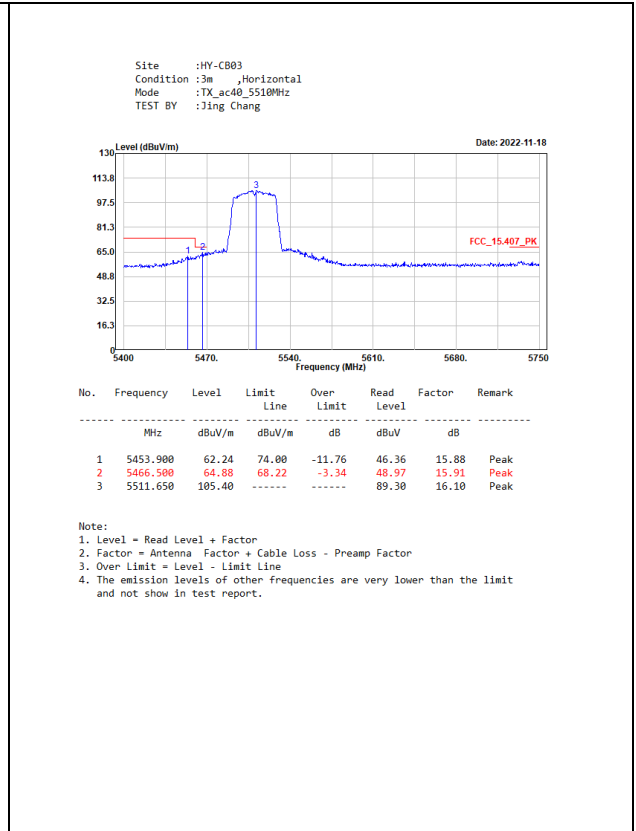
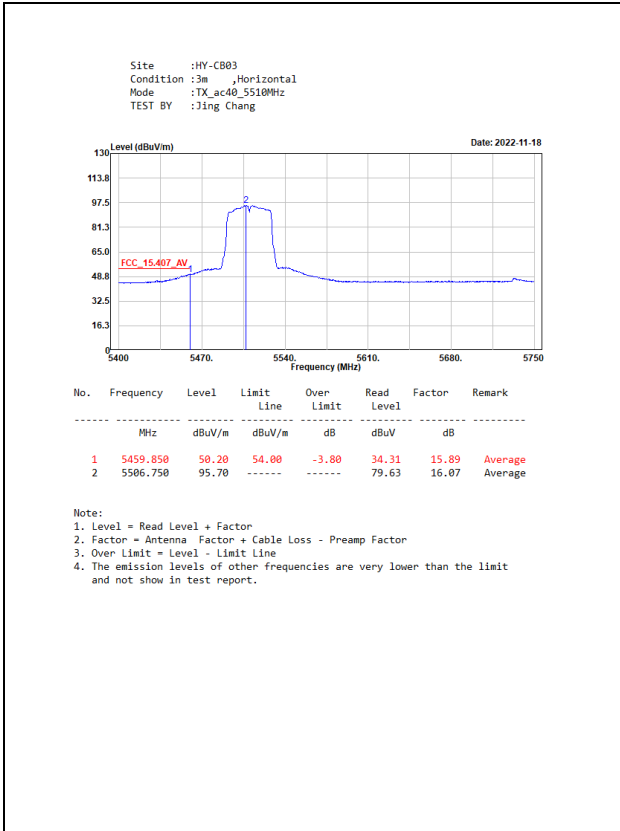

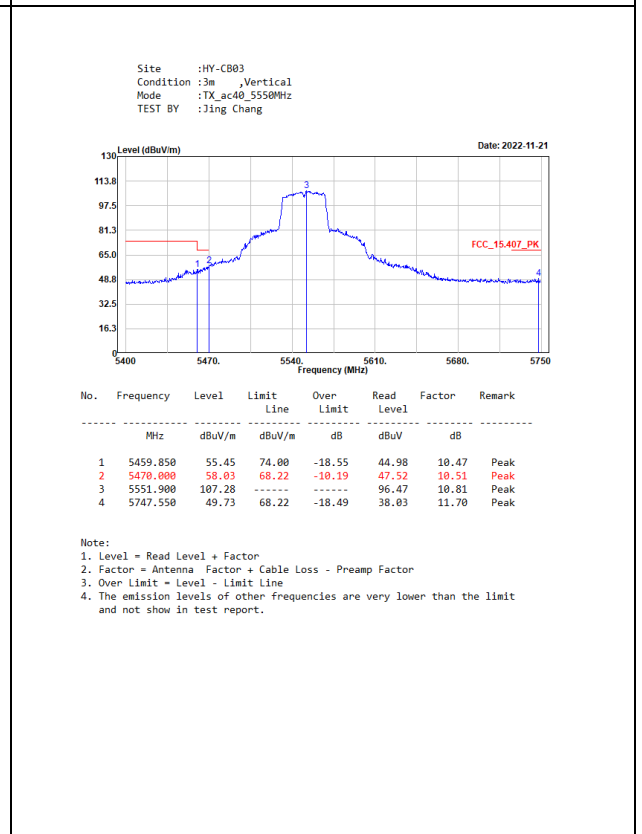
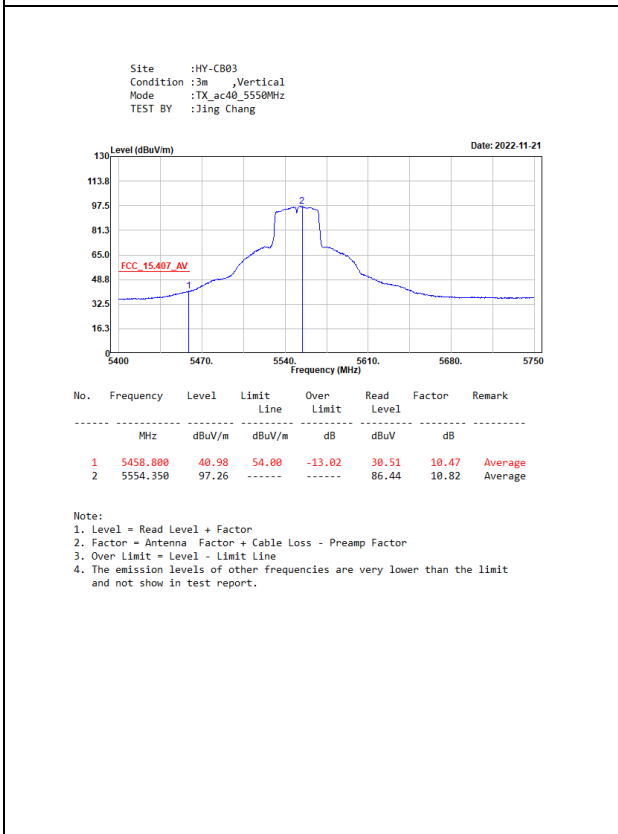
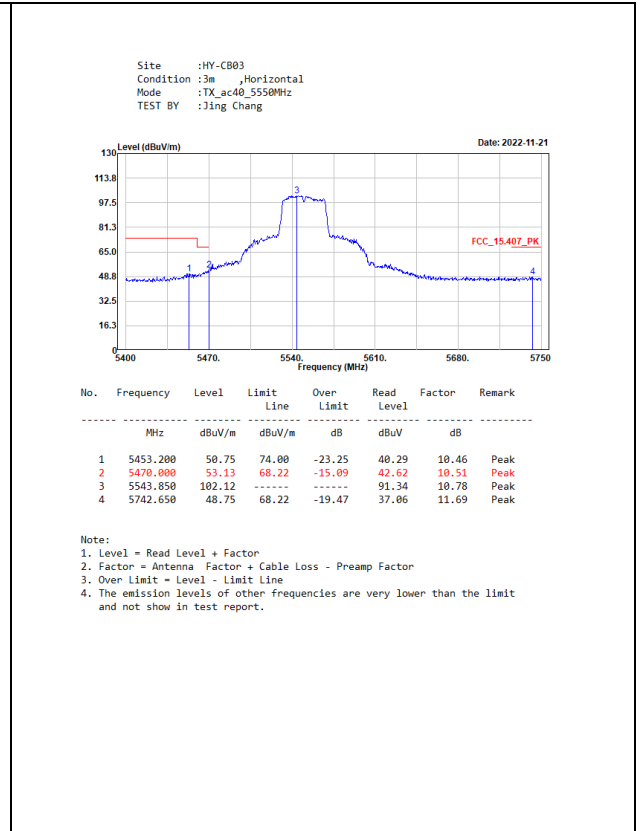
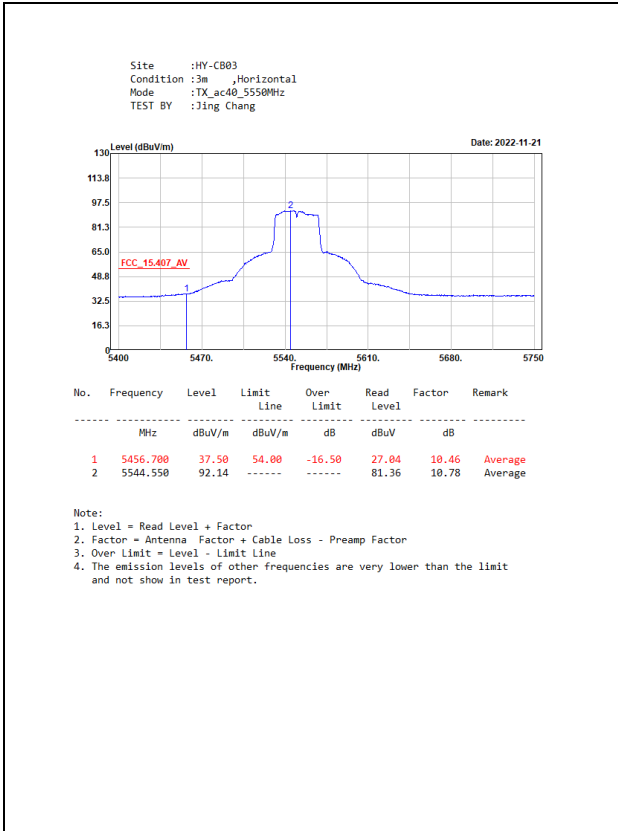

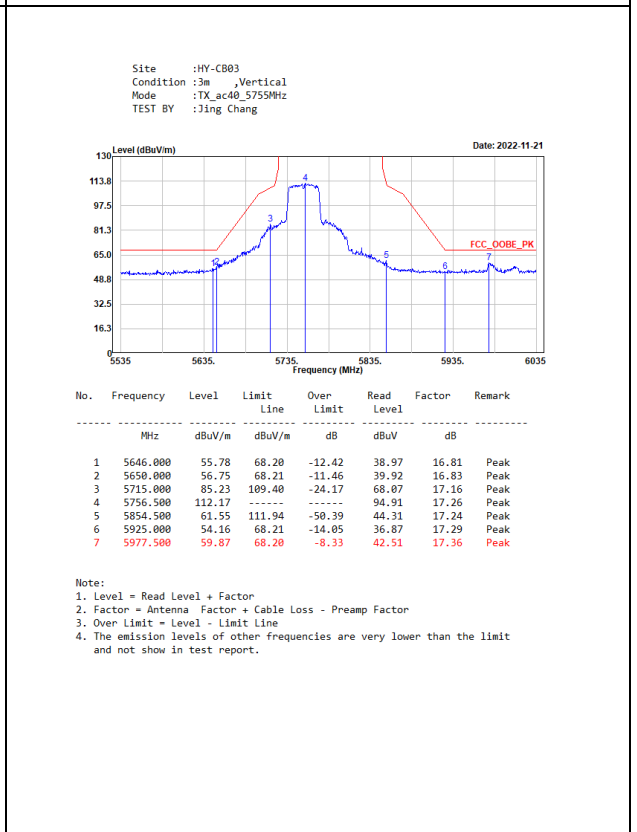
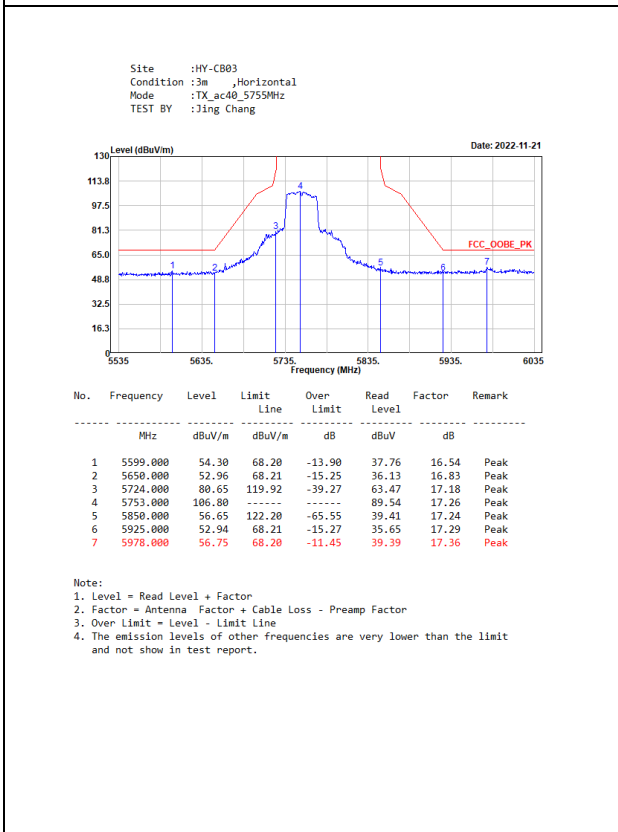
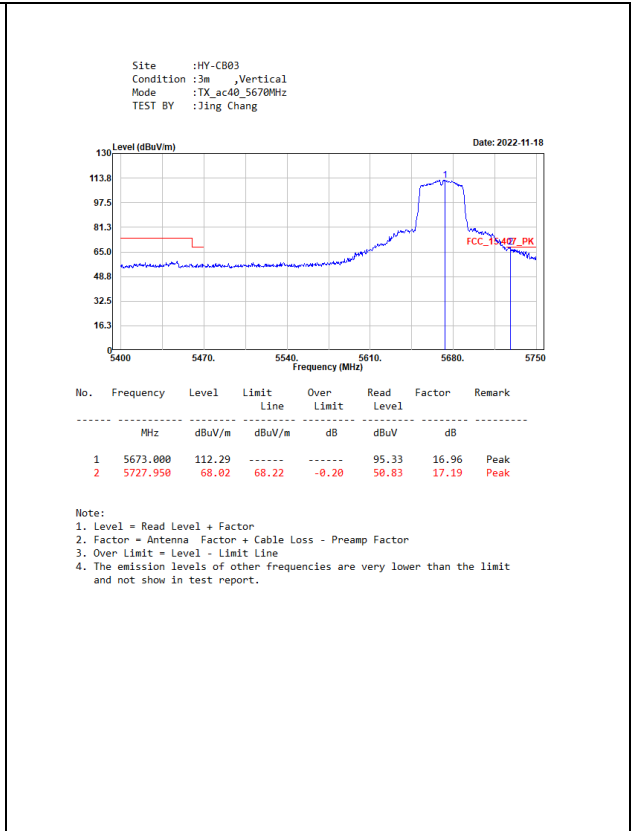
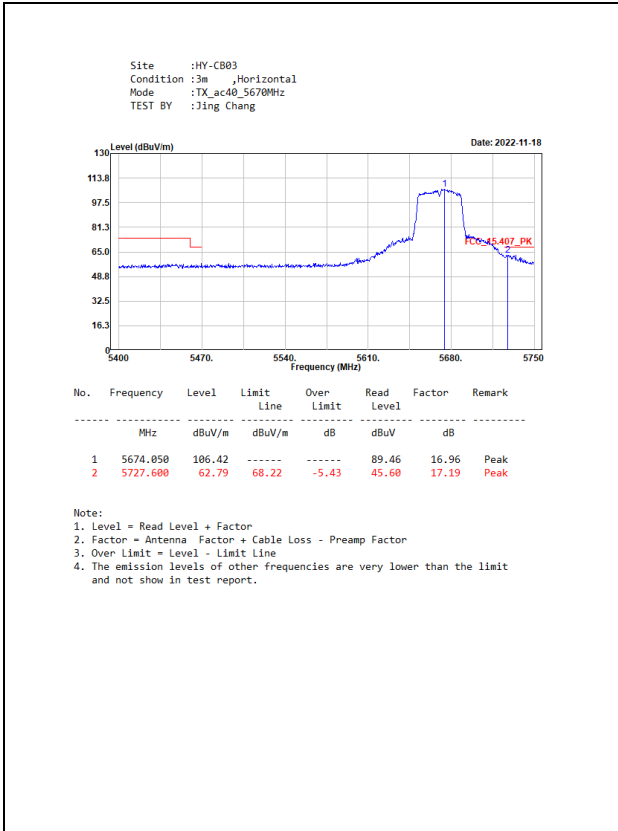

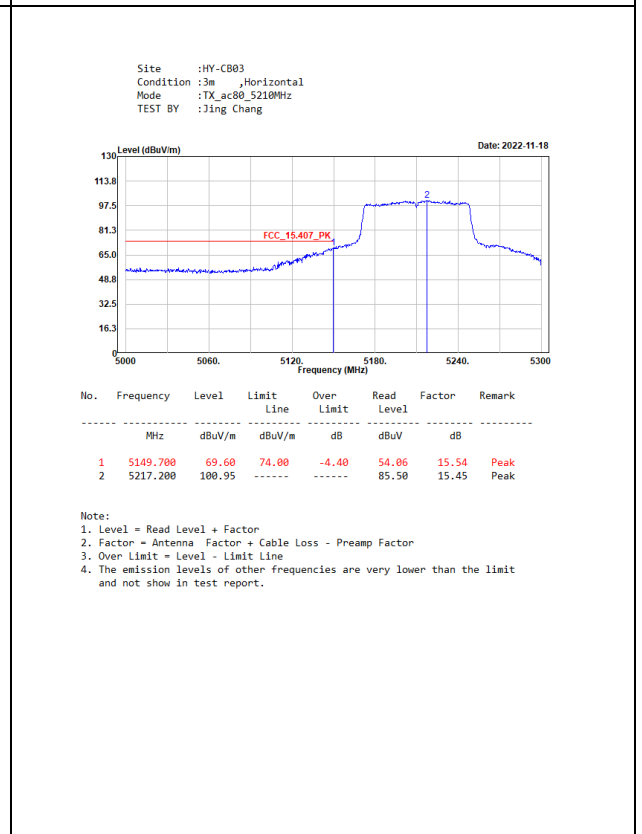
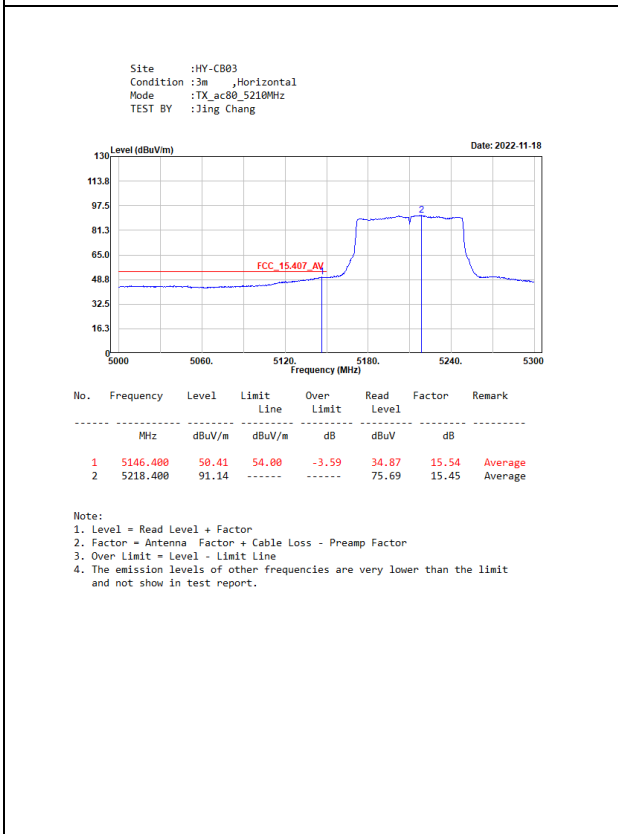
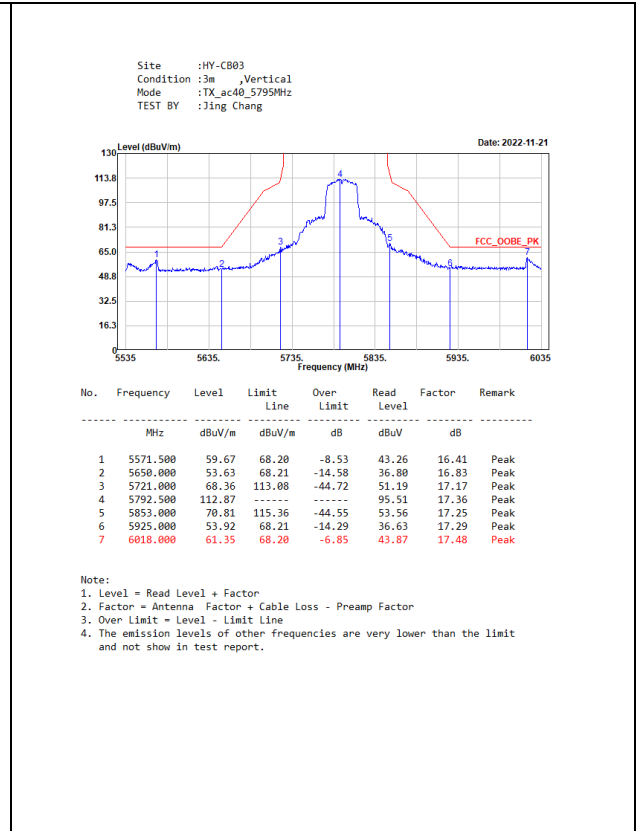
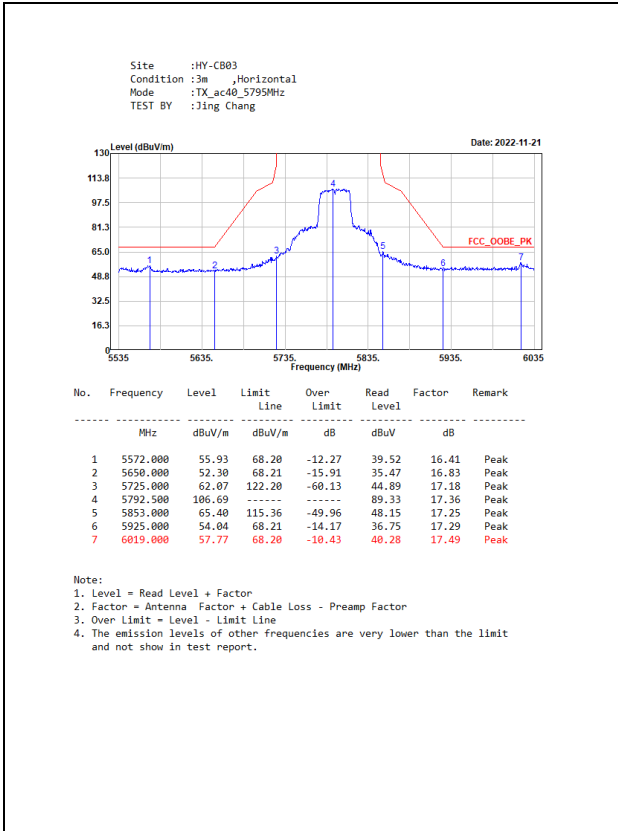

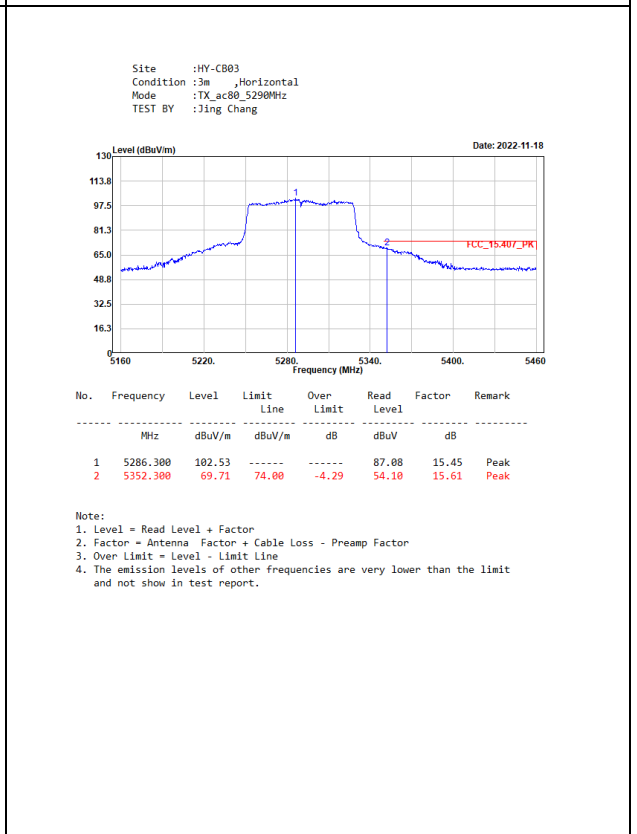
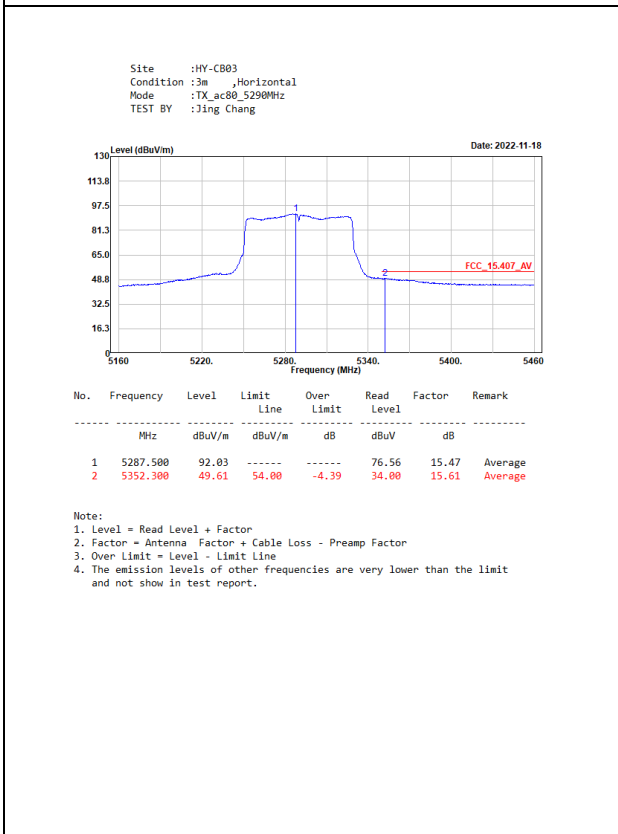
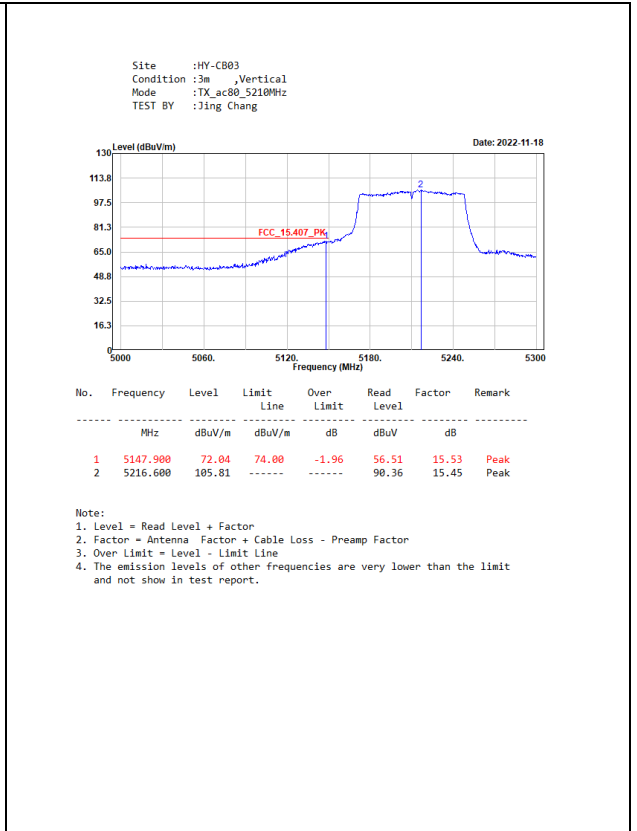
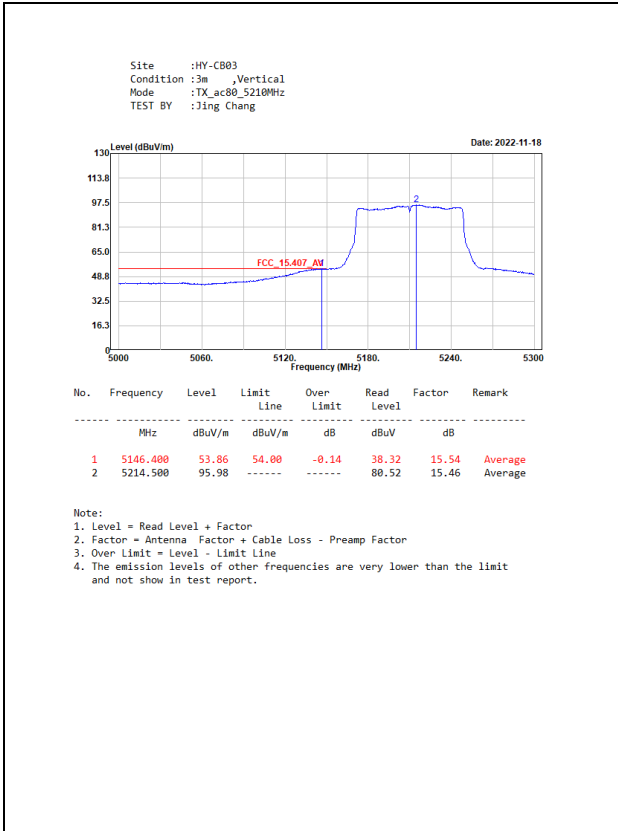

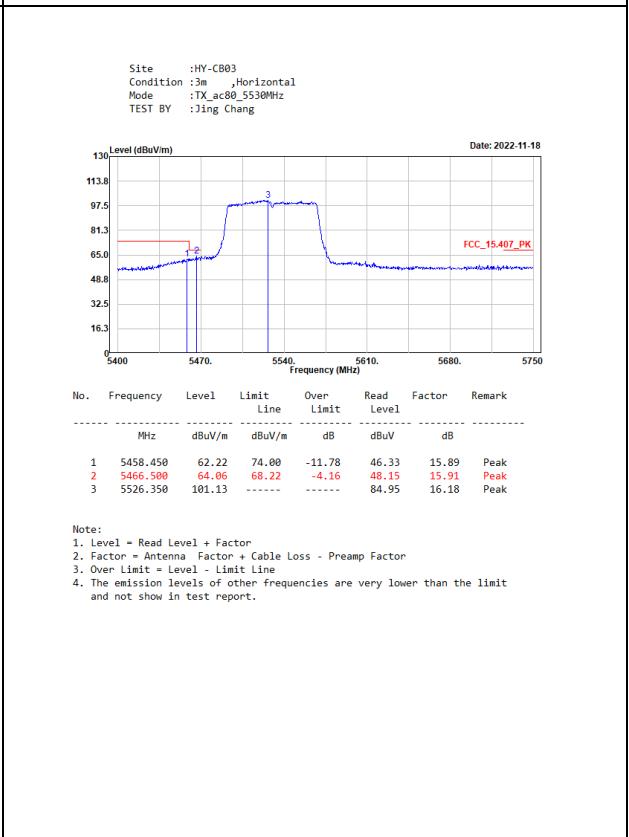
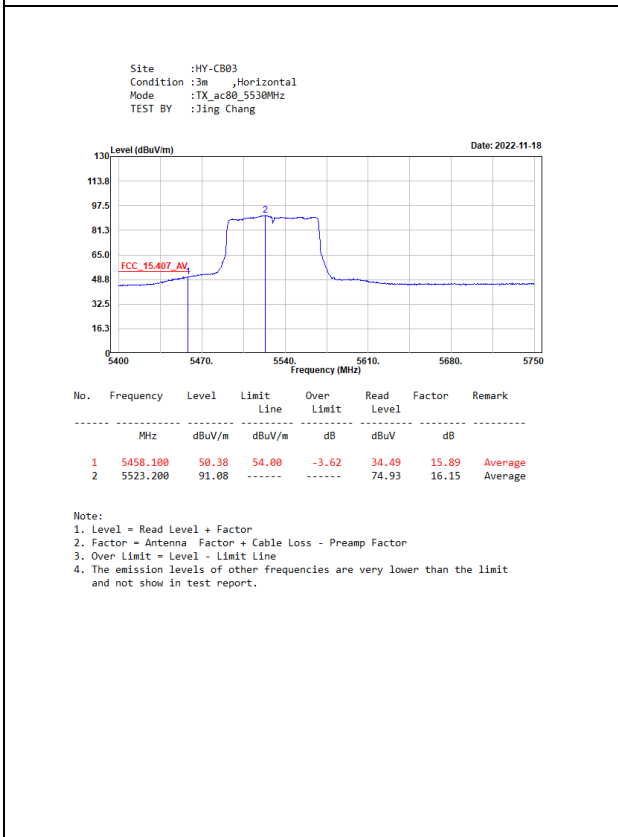
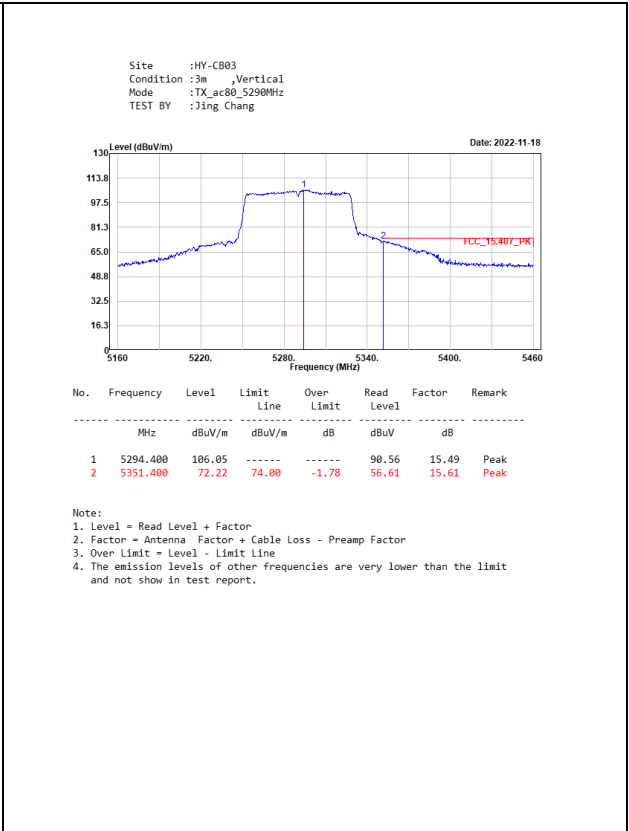
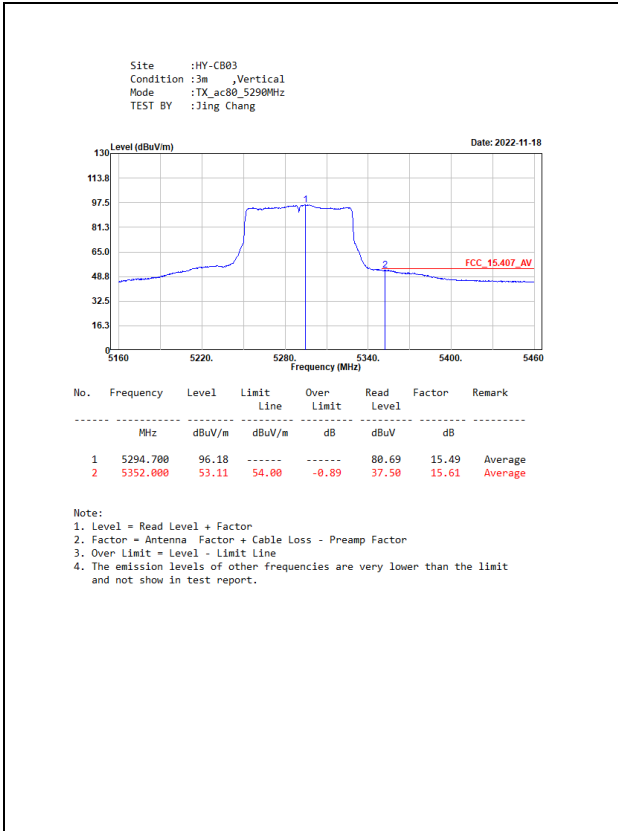

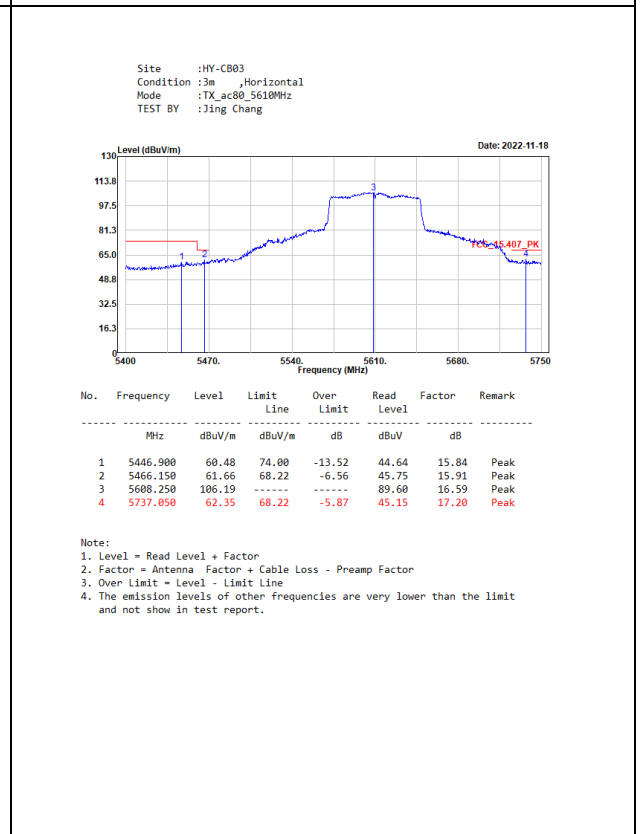
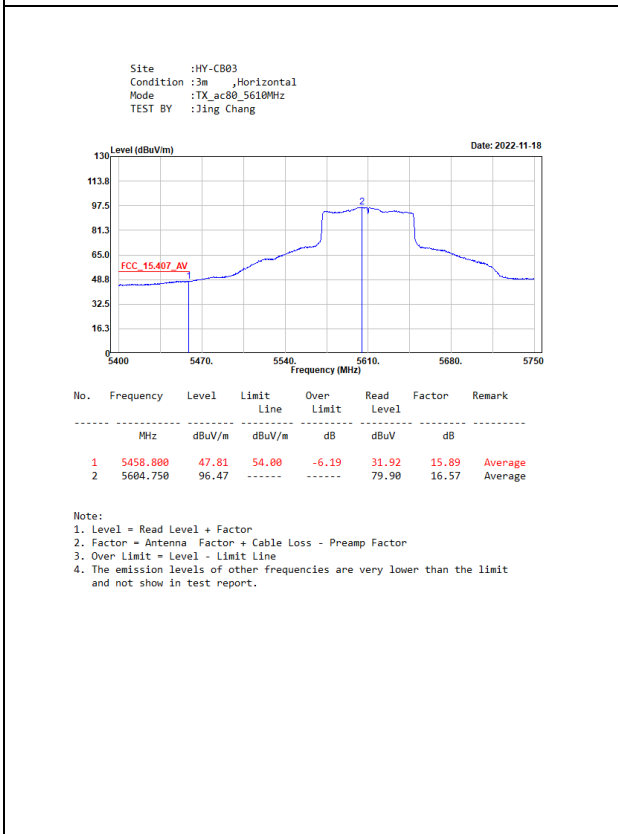
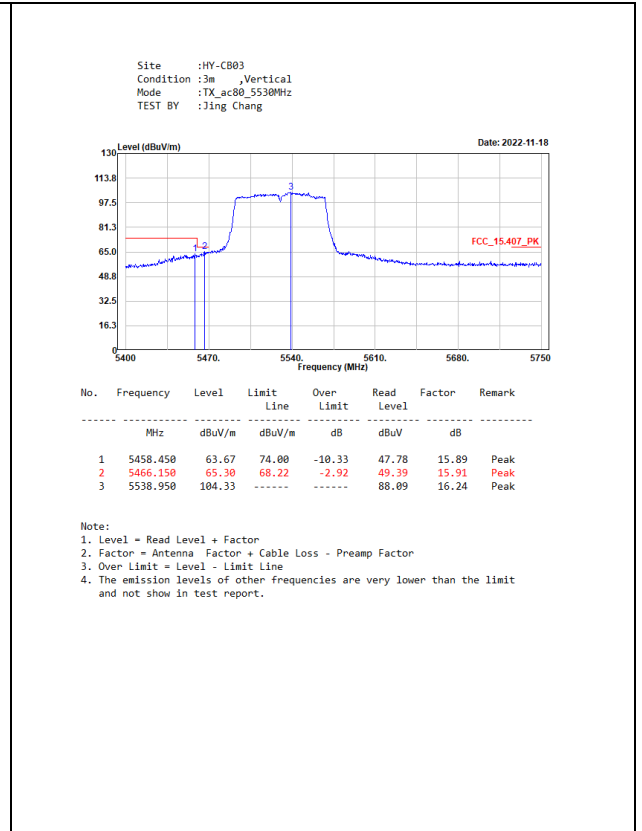
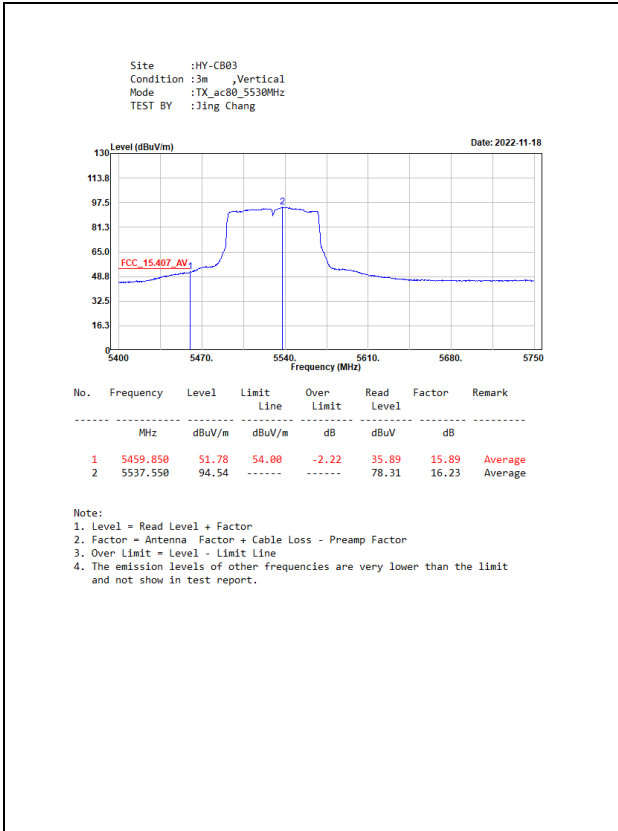

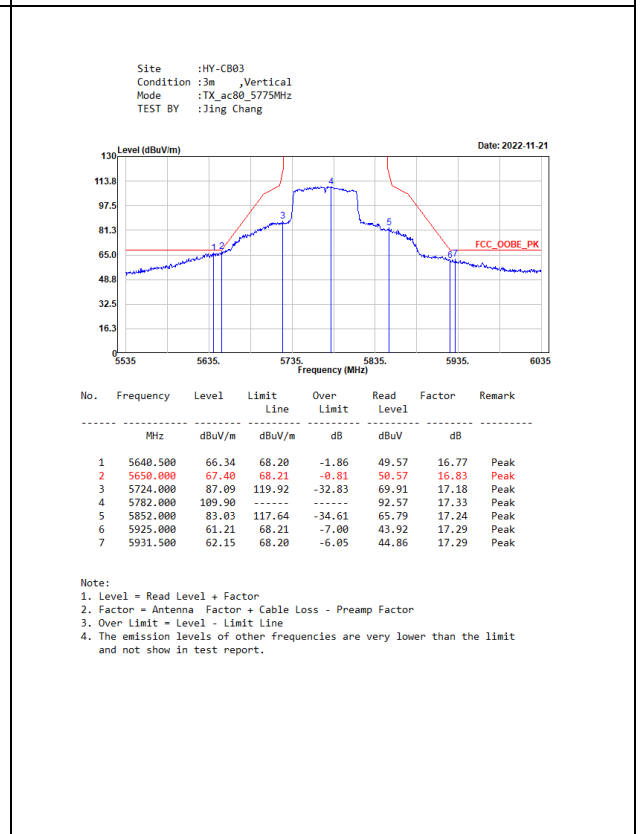
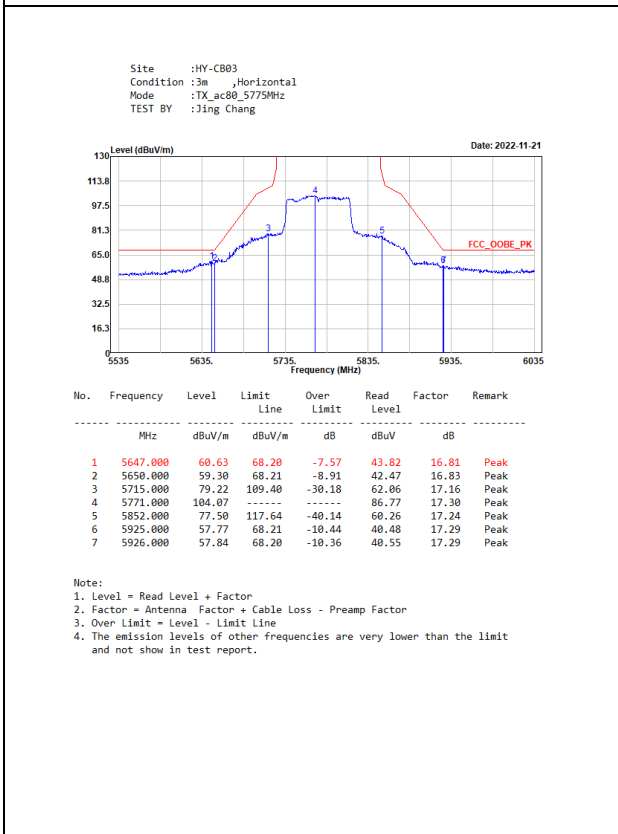
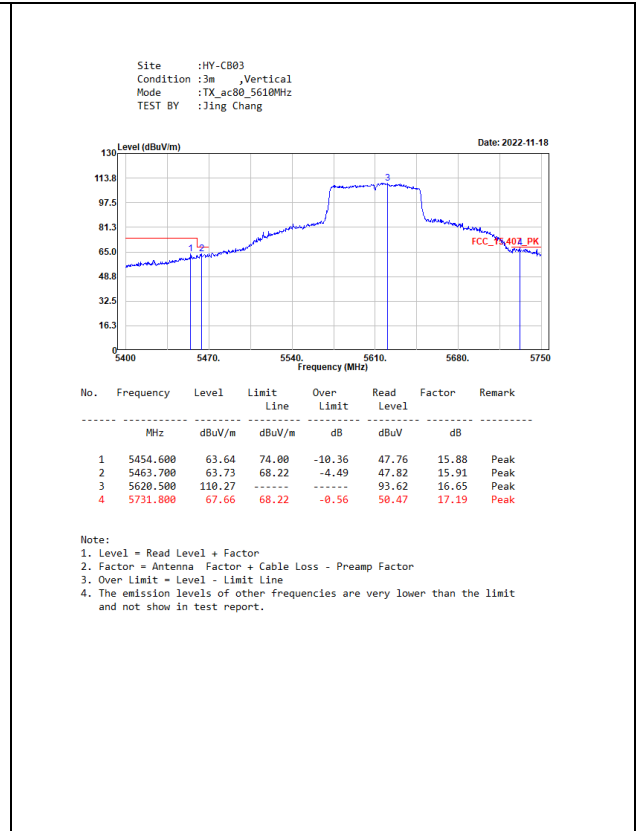
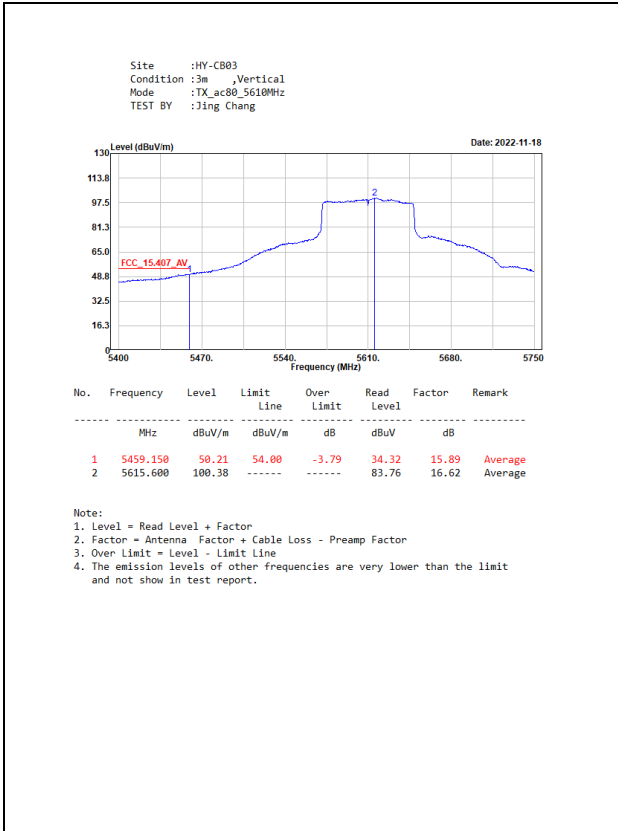

7. Occupied Bandwidth

7.1. Test Setup

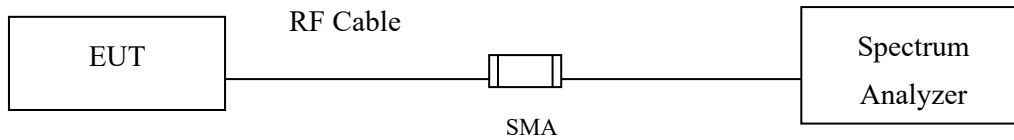

7.2. Limits

For the 5.725-5.85 GHz band, the minimum 6 dB bandwidth of U-NII devices shall be at least 500 kHz

7.3. Test Procedure

The EUT was setup to ANSI C63.10, 2013; tested to UNII test procedure of FCC KDB-789033 for compliance to FCC 47CFR Subpart E requirements.

7.4. Test Result of Occupied Bandwidth

Product : Mobile Computer
 Test Item : Occupied Bandwidth Data
 Test Mode : Transmit (802.11a)
 Test Date : 2022/11/23

Channel No.	Frequency (MHz)	Measurement Level (kHz)	Required Limit (kHz)	Result
149	5745	15345	>500	Pass
157	5785	16304	>500	Pass
165	5825	15664	>500	Pass

Figure Channel 157

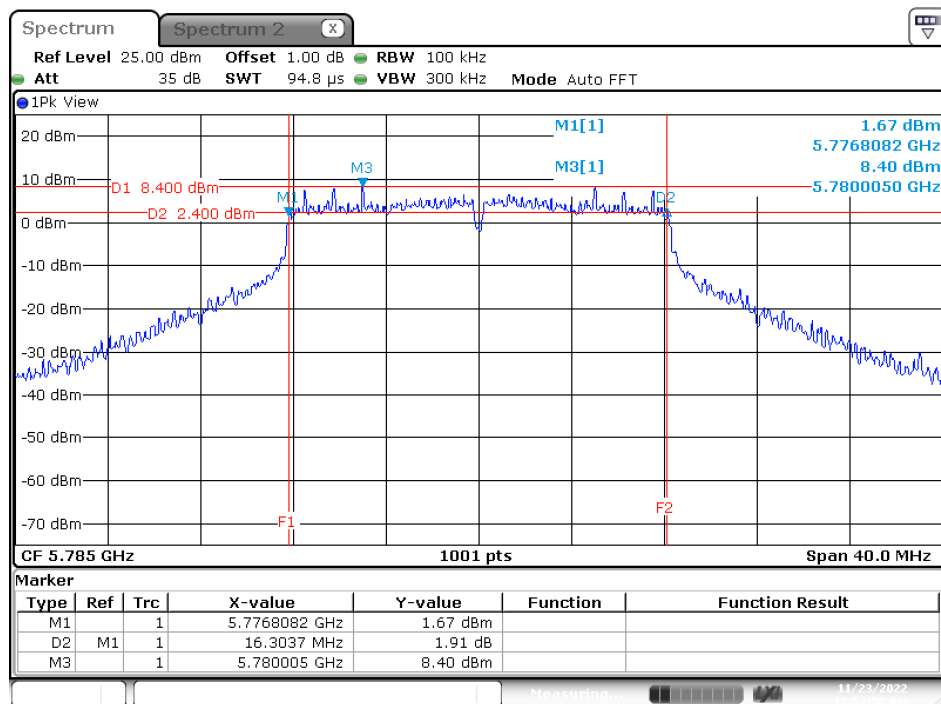

Date: 23.NOV.2022 00:52:58

Product : Mobile Computer
 Test Item : Occupied Bandwidth Data
 Test Mode : Transmit (802.11ac-20MHz)
 Test Date : 2022/11/23

Channel No.	Frequency (MHz)	Measurement Level (kHz)	Required Limit (kHz)	Result
149	5745	15904	>500	Pass
157	5785	15305	>500	Pass
165	5825	17263	>500	Pass

Figure Channel 165

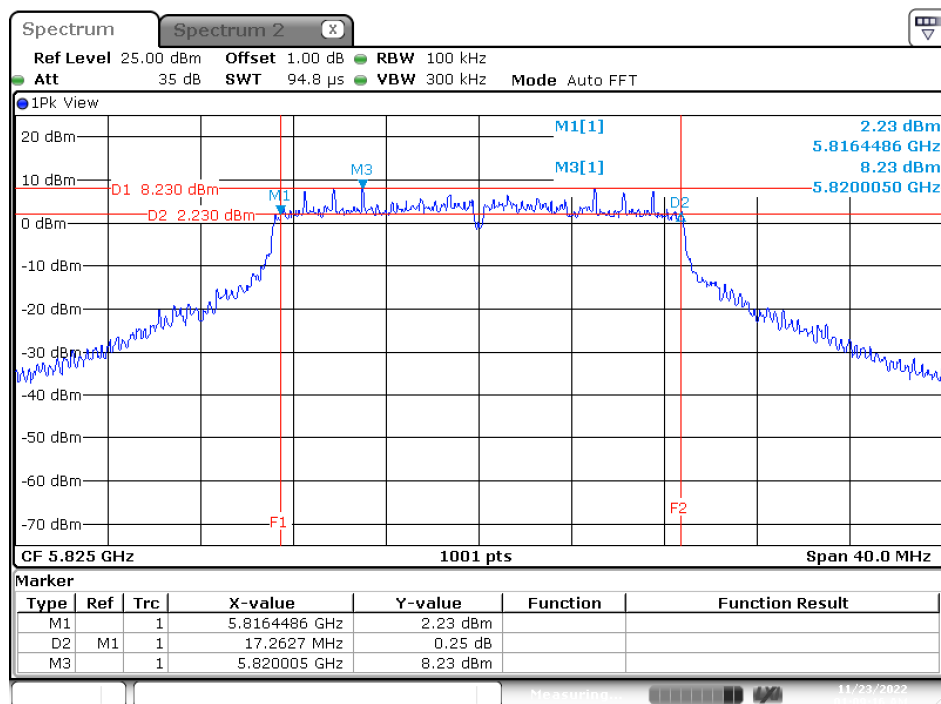

Date: 23.NOV.2022 01:09:17

Product : Mobile Computer
 Test Item : Occupied Bandwidth Data
 Test Mode : Transmit (802.11ac-40MHz)
 Test Date : 2022/11/23

Channel No.	Frequency (MHz)	Measurement Level (kHz)	Required Limit (kHz)	Result
151	5755	35325	>500	Pass
159	5795	35485	>500	Pass

Figure Channel 159

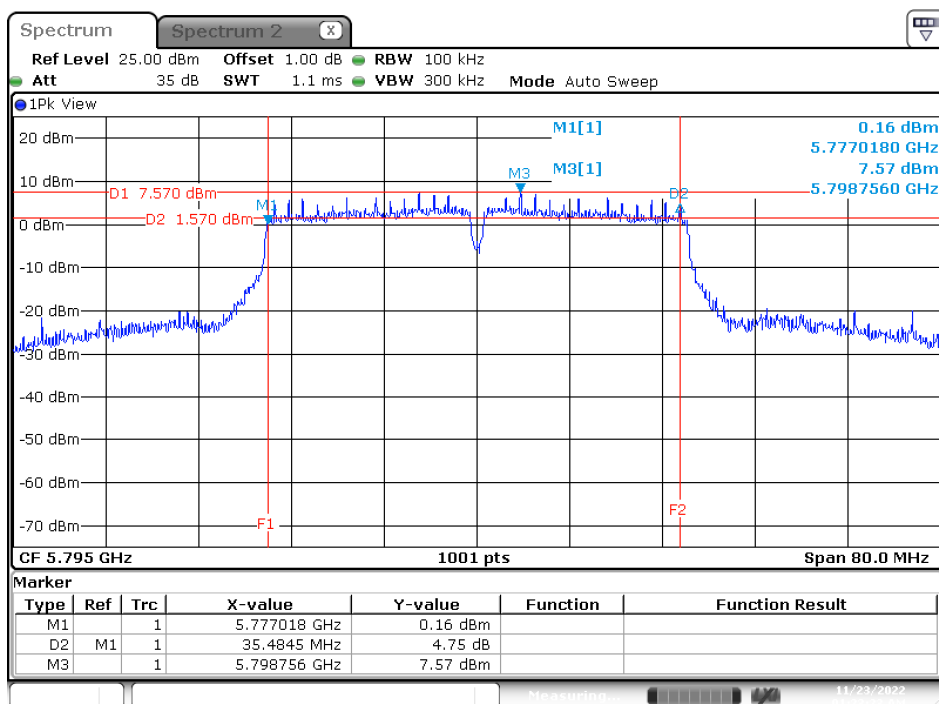

Date: 23.NOV.2022 01:23:23

Product : Mobile Computer
 Test Item : Occupied Bandwidth Data
 Test Mode : Transmit (802.11ac-80MHz)
 Test Date : 2022/11/23

Channel No.	Frequency (MHz)	Measurement Level (kHz)	Required Limit (kHz)	Result
155	5775	75125	>500	Pass

Figure Channel 155

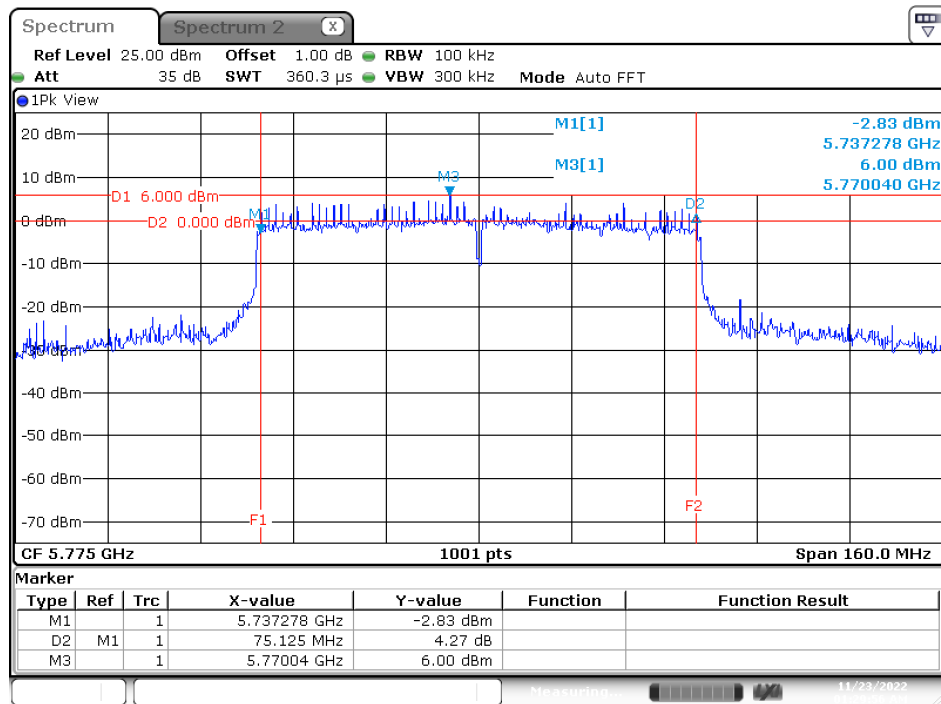

Date: 23.NOV.2022 01:29:57

8. Duty Cycle

8.1. Test Setup

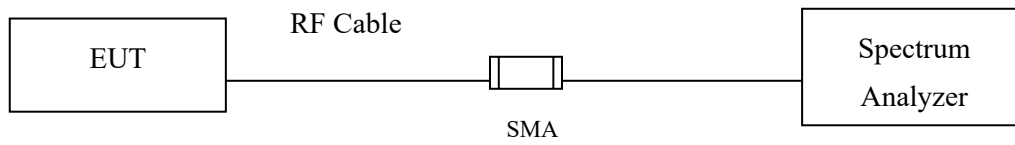

8.2. Test Procedure

The EUT was setup according to ANSI C63.10 2013; tested according to U-NII test procedure of KDB789033 for compliance to FCC 47CFR 15.407 requirements.

8.3. Test Result of Duty Cycle

Product : Mobile Computer
Test Item : Duty Cycle
Test Mode : Transmit

Duty Cycle Formula:

Duty Cycle = Ton / (Ton + Toff)

Duty Factor = 10 Log (1/Duty Cycle)

Results:

5 GHz band	Ton (ms)	Ton + Toff (ms)	Duty Cycle (%)	Duty Factor (dB)
802.11 a	2.0280	2.0735	97.81	0.10
802.11 ac20	1.8980	1.9435	97.66	0.10
802.11 ac40	0.9295	0.9750	95.33	0.21
802.11 ac80	0.4540	0.4920	92.28	0.35

802.11a

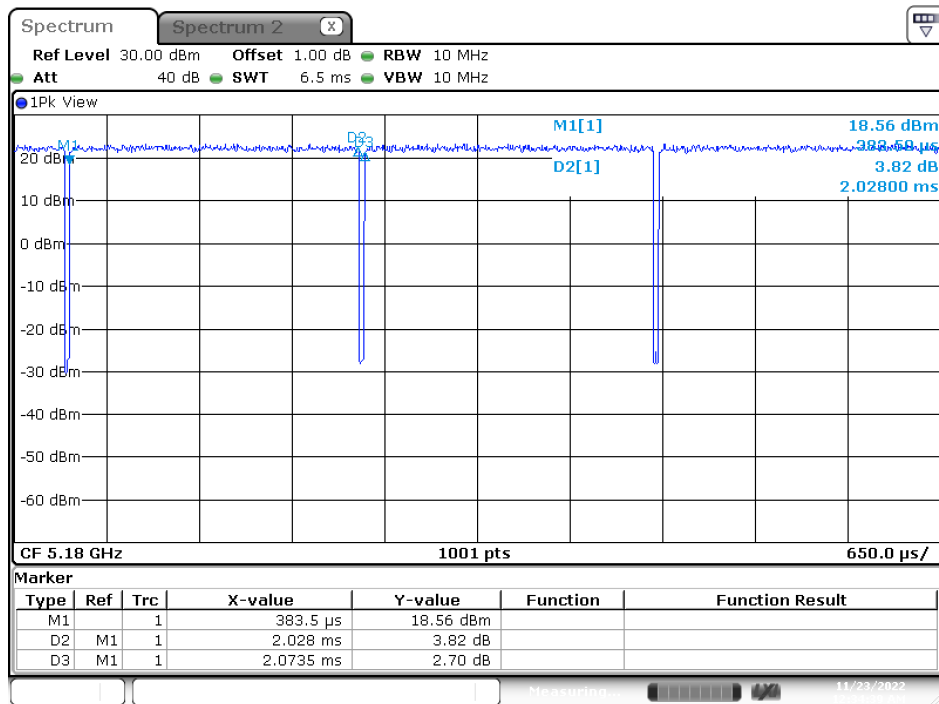

Date: 23.NOV.2022 00:34:40

802.11ac20

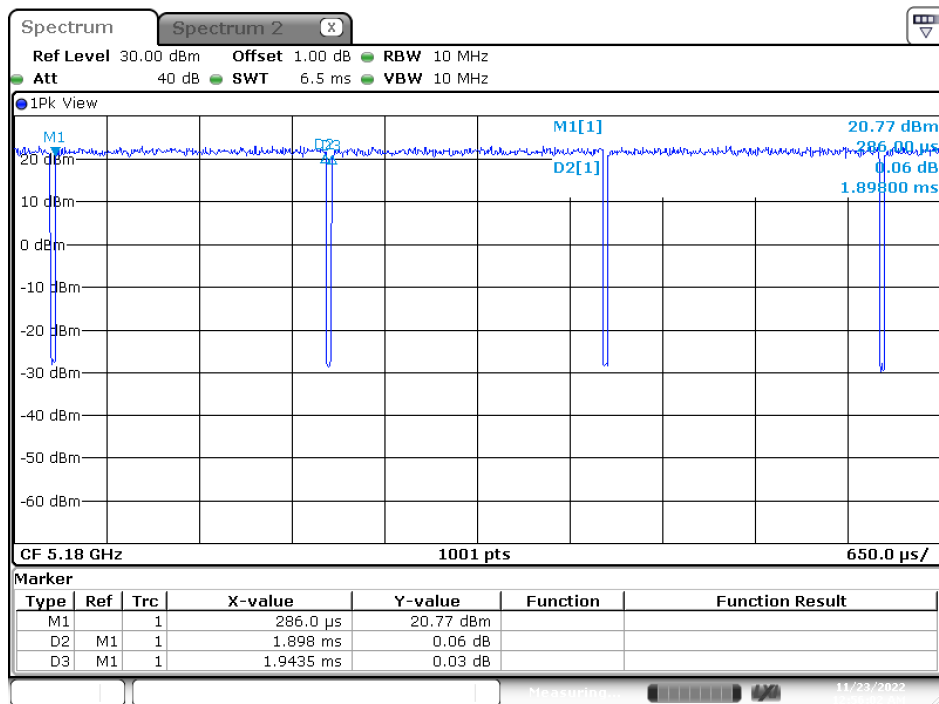

Date: 23.NOV.2022 00:56:02

802.11ac40

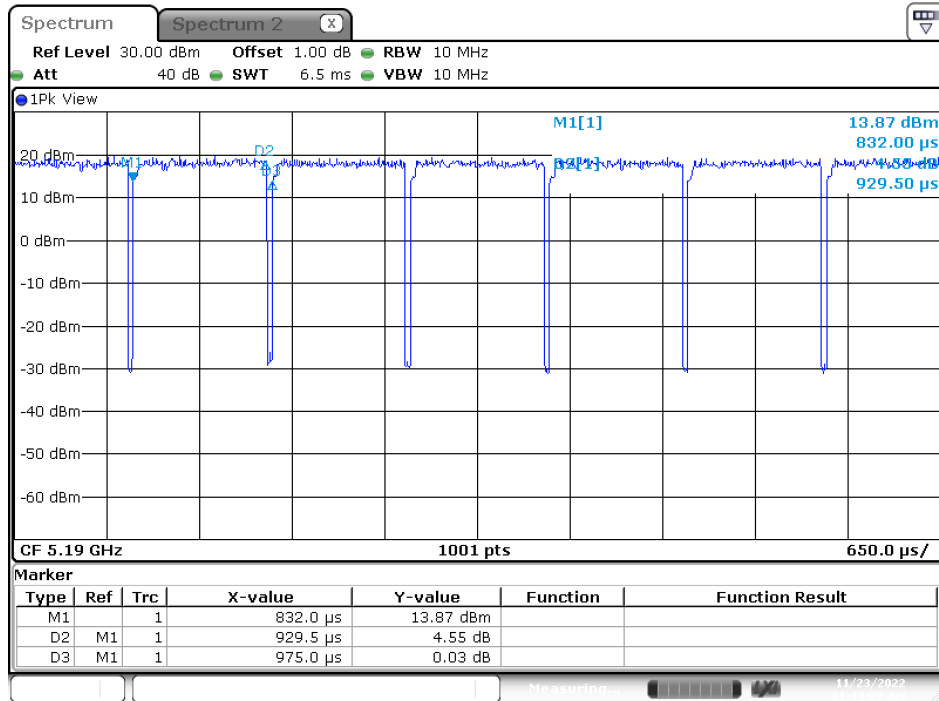

Date: 23.NOV.2022 01:13:23

802.11ac80

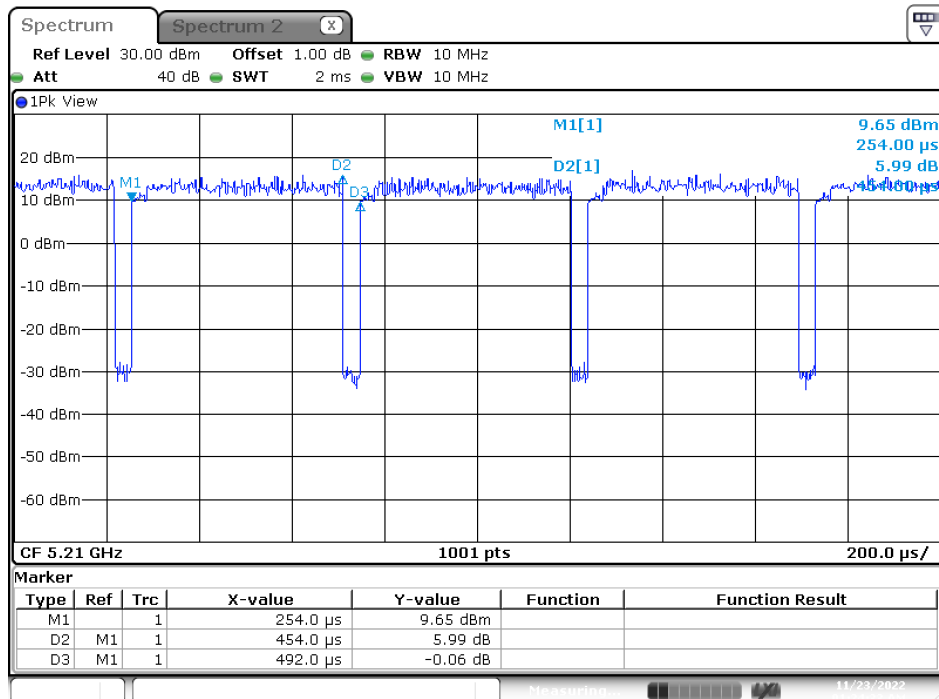

Date: 23.NOV.2022 01:24:33