

## FCC Test Report (Part 24)

**Report No.:** RF161214C23-8

**FCC ID:** Q3N-MR00002

**Test Model:** RS31

**Series Model:** BHT-1600 (refer to item 3.1 for more details)

**Received Date:** Nov. 30, 2016

**Test Date:** Dec. 20, 2016 ~ Jan. 18, 2017

**Issued Date:** Jan. 19, 2017

**Applicant:** CIPHERLAB CO., LTD

**Address:** 12F, 333 Dunhua S. Rd., Sec. 2 Taipei, Taiwan 106

**Issued By:** Bureau Veritas Consumer Products Services (H.K.) Ltd., Taoyuan Branch

**Lab Address:** No. 47-2, 14th Ling, Chia Pau Vil., Lin Kou Dist., New Taipei City, Taiwan (R.O.C.)

**Test Location:** No. 19, Hwa Ya 2nd Rd., Wen Hwa Vil., Kwei Shan Dist., Taoyuan City 33383, TAIWAN (R.O.C.)



This report is for your exclusive use. Any copying or replication of this report to or for any other person or entity, or use of our name or trademark, is permitted only with our prior written permission. This report sets forth our findings solely with respect to the test samples identified herein. The results set forth in this report are not indicative or representative of the quality or characteristics of the lot from which a test sample was taken or any similar or identical product unless specifically and expressly noted. Our report includes all of the tests requested by you and the results thereof based upon the information that you provided to us. You have 60 days from date of issuance of this report to notify us of any material error or omission caused by our negligence, provided, however, that such notice shall be in writing and shall specifically address the issue you wish to raise. A failure to raise such issue within the prescribed time shall constitute your unqualified acceptance of the completeness of this report, the tests conducted and the correctness of the report contents. Unless specific mention, the uncertainty of measurement has been explicitly taken into account to declare the compliance or non-compliance to the specification. The report must not be used by the client to claim product certification, approval, or endorsement by TAF or any government agencies

## Table of Contents

<b>Release Control Record</b> .....	<b>3</b>
<b>1 Certificate of Conformity</b> .....	<b>4</b>
<b>2 Summary of Test Results</b> .....	<b>5</b>
2.1 Measurement Uncertainty.....	5
2.2 Test Site and Instruments.....	6
<b>3 General Information</b> .....	<b>7</b>
3.1 General Description of EUT.....	7
3.2 Configuration of System Under Test.....	8
3.2.1 Description of Support Units.....	8
3.3 Test Mode Applicability and Tested Channel Detail.....	9
3.4 EUT Operating Conditions.....	10
3.5 General Description of Applied Standards.....	10
<b>4 Test Types and Results</b> .....	<b>11</b>
4.1 Output Power Measurement.....	11
4.1.1 Limits of Output Power Measurement.....	11
4.1.2 Test Procedures.....	11
4.1.3 Test Setup.....	12
4.1.4 Test Results.....	13
4.2 Frequency Stability Measurement.....	16
4.2.1 Limits of Frequency Stability Measurement.....	16
4.2.2 Test Procedure.....	16
4.2.3 Test Setup.....	16
4.2.4 Test Results.....	17
4.3 Occupied Bandwidth Measurement.....	18
4.3.1 Test Procedure.....	18
4.3.2 Test Setup.....	18
4.3.3 Test Result.....	19
4.4 Band Edge Measurement.....	21
4.4.1 Limits of Band Edge Measurement.....	21
4.4.2 Test Setup.....	21
4.4.3 Test Procedures.....	21
4.4.4 Test Results.....	22
4.5 Peak To Average Ratio.....	24
4.5.1 Limits of Peak To Average Ratio Measurement.....	24
4.5.2 Test Setup.....	24
4.5.3 Test Procedures.....	24
4.5.4 Test Results.....	25
4.6 Conducted Spurious Emissions.....	27
4.6.1 Limits of Conducted Spurious Emissions Measurement.....	27
4.6.2 Test Setup.....	27
4.6.3 Test Procedure.....	27
4.6.4 Test Results.....	28
4.7 Radiated Emission Measurement.....	46
4.7.1 Limits of Radiated Emission Measurement.....	46
4.7.2 Test Procedure.....	46
4.7.3 Deviation from Test Standard.....	46
4.7.4 Test Setup.....	47
4.7.5 Test Results.....	48
<b>5 Pictures of Test Arrangements</b> .....	<b>64</b>
<b>Appendix – Information on the Testing Laboratories</b> .....	<b>65</b>

### Release Control Record

Issue No.	Description	Date Issued
RF161214C23-8	Original release	Jan. 19, 2017

## 1 Certificate of Conformity

**Product:** Mobile Computer

**Brand:** CIPHERLAB, DENSO (refer to item 3.1 for more details)

**Test Model:** RS31

**Series Model:** BHT-1600 (refer to item 3.1 for more details)

**Sample Status:** Engineering sample

**Applicant:** CIPHERLAB CO., LTD

**Test Date:** Dec. 20, 2016 ~ Jan. 18, 2017

**Standards:** FCC Part 24, Subpart E

The above equipment has been tested by **Bureau Veritas Consumer Products Services (H.K.) Ltd., Taoyuan Branch**, and found compliance with the requirement of the above standards. The test record, data evaluation & Equipment Under Test (EUT) configurations represented herein are true and accurate accounts of the measurements of the sample's EMC characteristics under the conditions specified in this report.

**Prepared by :** Celine Chou , **Date:** Jan. 19, 2017  
Celine Chou / Specialist

**Approved by :** Bruce Chen , **Date:** Jan. 19, 2017  
Bruce Chen / Project Engineer

## 2 Summary of Test Results

Applied Standard: FCC Part 24 & Part 2			
FCC Clause	Test Item	Result	Remarks
2.1046 24.232	Effective radiated power	Pass	Meet the requirement of limit.
2.1046 24.232(d)	Peak To Average Ratio	Pass	Meet the requirement of limit.
2.1055 24.235	Frequency Stability	Pass	Meet the requirement of limit.
2.1049 24.238(b)	Occupied Bandwidth	Pass	Meet the requirement of limit.
24.238(b)	Band Edge Measurements	Pass	Meet the requirement of limit.
2.1051 24.238	Conducted Spurious Emissions	Pass	Meet the requirement of limit.
2.1053 24.238	Radiated Spurious Emissions	Pass	Meet the requirement of limit. Minimum passing margin is -15.90dB at 5557.20MHz.

### 2.1 Measurement Uncertainty

Where relevant, the following measurement uncertainty levels have been estimated for tests performed on the EUT as specified in CISPR 16-4-2:

Measurement	Frequency	Expanded Uncertainty (k=2) (±)
Radiated Emissions up to 1 GHz	30MHz ~ 200MHz	3.63 dB
	200MHz ~1000MHz	3.64 dB
Radiated Emissions above 1 GHz	1GHz ~ 18GHz	2.29 dB
	18GHz ~ 40GHz	2.29 dB

## 2.2 Test Site and Instruments

Description & Manufacturer	Model No.	Serial No.	Cal. Date	Cal. Due
Test Receiver KEYSIGHT	N9038A	MY55420137	Feb. 06, 2016	Feb. 05, 2017
Spectrum Analyzer ROHDE & SCHWARZ	FSP40	100269	Apr. 19, 2016	Apr. 18, 2017
BILOG Antenna SCHWARZBECK	VULB9168	9168-148	Dec. 28, 2015	Dec. 27, 2016
			Dec. 28, 2016	Dec. 27, 2017
HORN Antenna SCHWARZBECK	BBHA 9120 D	9120D-1169	Dec. 27, 2015	Dec. 26, 2016
			Dec. 27, 2016	Dec. 26, 2017
HORN Antenna SCHWARZBECK	BBHA 9170	BBHA9170241	Dec. 14, 2016	Dec. 13, 2017
Loop Antenna	EM-6879	269	Aug. 11, 2016	Aug. 10, 2017
Preamplifier Agilent	8449B	3008A01911	Aug. 09, 2016	Aug. 08, 2017
Preamplifier Agilent	8447D	2944A10638	Aug. 09, 2016	Aug. 08, 2017
RF signal cable HUBER+SUHNER	SUCOFLEX 104	CABLE-CH9-02 (309222 +248780)	Aug. 09, 2016	Aug. 08, 2017
RF signal cable HUBER+SUHNER	SUCOFLEX 104	CABLE-CH9-03 (274092)	Aug. 09, 2016	Aug. 08, 2017
RF signal cable Woken	8D-FB	Cable-CH9-01	Aug. 09, 2016	Aug. 08, 2017
Software BV ADT	ADT_Radiated_ V7.6.15.9.4	NA	NA	NA
Antenna Tower EMCO	2070/2080	512.835.4684	NA	NA
Turn Table EMCO	2087-2.03	NA	NA	NA
Antenna Tower & Turn BV ADT	AT100	AT93021705	NA	NA
Turn Table BV ADT	TT100	TT93021705	NA	NA
Turn Table Controller BV ADT	SC100	SC93021705	NA	NA
WIT Standard Temperature And Humidity Chamber	TH-4S-C	W981030	Jun. 08, 2016	Jun. 07, 2017
Mini-Circuits Power Splitter	ZN2PD-9G	NA	Jun. 09, 2016	Jun. 08, 2017
JFW 20dB attenuation	50HF-020-SMA	NA	NA	NA

- Note: 1. The calibration interval of the above test instruments is 12 months and the calibrations are traceable to NML/ROC and NIST/USA.  
2. The test was performed in HwaYa Chamber 9.  
3. The horn antenna and preamplifier (model: 8449B) are used only for the measurement of emission frequency above 1GHz if tested.  
4. The FCC Site Registration No. is 215374.  
5. The IC Site Registration No. is IC 7450F-9.

### 3 General Information

#### 3.1 General Description of EUT

Product	Mobile Computer
Brand	CIPHERLAB, DENSO (refer to note for more details)
Test Model	RS31
Series Model	BHT-1600
Model Difference	Refer to note as below
Sample Status	Engineering sample
Power Supply Rating	3.85Vdc (Battery) 5Vdc (Adapter)
Modulation Type	GSM, GPRS: GMSK EDGE: 8PSK WCDMA: BPSK, QPSK HSDPA: BPSK HSUPA: QPSK
Operating Frequency	GSM: 1850.2MHz ~ 1909.8MHz WCDMA: 1852.4MHz ~ 1907.6MHz
Max. EIRP Power	GSM: 446.684mW (26.50dBm) WCDMA: 102.329mW (20.10dBm)
Antenna Type	Main: PIFA antenna with 2.23dBi gain Aux: PIFA antenna with 1.51dBi gain
Antenna Connector	Patch
Accessory Device	Adapter, Battery
Data Cable Supplied	1m shielded USB cable without core 1.6m non-shielded snapon cable with one core

Note:

1. All models and brands are listed as below. Model RS31 is the representatives for final test.

Brand	Model	Difference
CIPHERLAB	RS31	All models are electrically identical, different colors, model names and brand names are for marketing purpose.
DENSO	BHT-1600	

2. The EUT uses following adapter and battery.

Adapter	
Brand	Sunny COMPUTER TECHNOLOGY CO., LTD.
Model	SYS1561-1005
Input Power	100-240Vac, 1.0A MAX 50-60Hz
Output Power	+5Vdc, 2A

Battery	
Brand	CIPHERLAB, DENSO
Model	BA-0093A0
Rating	3.85Vdc, 2960mAh, 11.40Wh

### 3.2 Configuration of System Under Test

Test Mode A

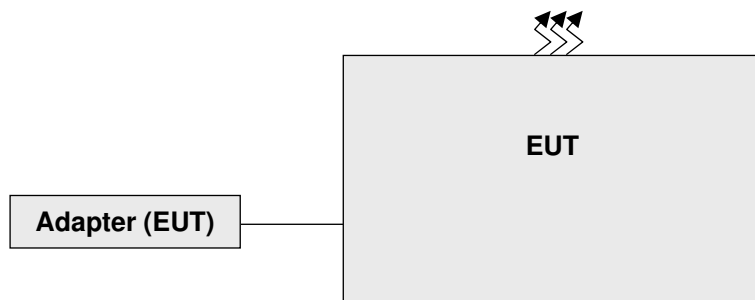

Remote site



Test Mode B

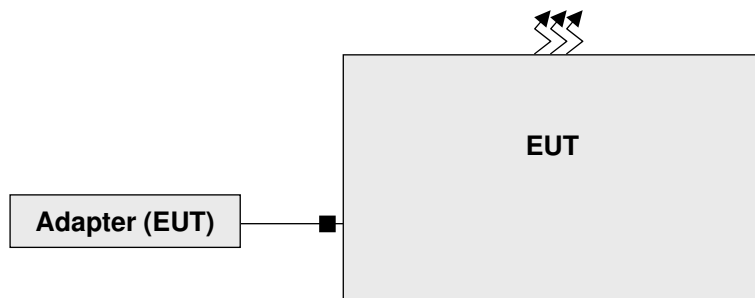

Remote site



#### 3.2.1 Description of Support Units

The EUT has been tested as an independent unit together with other necessary accessories or support units. The following support units or accessories were used to form a representative test configuration during the tests.

ID	Product	Brand	Model No.	Serial No.	FCC ID	Remarks
A.	Universal Radio Communication Tester	R&S	CMU200	123112	NA	-
B.	DC Power Supply	Topward	6603D	700637	NA	-

Note:

1. All power cords of the above support units are non-shielded (1.8m).
2. Item A acted as a communication partner to transfer data.



### 3.3 Test Mode Applicability and Tested Channel Detail

Pre-Scan has been conducted to determine the worst-case mode from all possible combinations between available modulations, data rates, XYZ axis and antenna ports. The worst case was found when positioned on Z-plane. Following channel(s) was (were) selected for the final test as listed below:

Test results are presented in the report as below.

Test Mode	Test Condition
A	EUT + USB Cable + Adapter + Battery
B	EUT + Snapon Cable + Adapter + Battery

#### GSM Mode

EUT Configure Mode	Test Item	Available Channel	Tested Channel	Mode
A	EIRP	512 to 810	512, 661, 810	GSM
A	Frequency Stability	512 to 810	661	GSM
A	Occupied Bandwidth	512 to 810	512, 661, 810	GSM, GPRS, EDGE
A	Band Edge	512 to 810	512, 810	GSM, GPRS, EDGE
A	Peak To Average Ratio	512 to 810	512, 661, 810	GSM, GPRS, EDGE
A	Conducted Emission	512 to 810	512, 661, 810	GSM, GPRS, EDGE
A, B	Radiated Emission Below 1GHz	512 to 810	512, 661, 810	GSM
A	Radiated Emission Above 1GHz	512 to 810	512, 661, 810	GSM

#### WCDMA Mode

EUT Configure Mode	Test Item	Available Channel	Tested Channel	Mode
A	EIRP	9262 to 9538	9262, 9400, 9538	WCDMA
A	Frequency Stability	9262 to 9538	9400	WCDMA
A	Occupied Bandwidth	9262 to 9538	9262, 9400, 9538	WCDMA, HSDPA, HSUPA
A	Band Edge	9262 to 9538	9262, 9538	WCDMA, HSDPA, HSUPA
A	Peak To Average Ratio	9262 to 9538	9262, 9400, 9538	WCDMA, HSDPA, HSUPA
A	Conducted Emission	9262 to 9538	9262, 9400, 9538	WCDMA, HSDPA, HSUPA
A, B	Radiated Emission Below 1GHz	9262 to 9538	9262, 9400, 9538	WCDMA
A	Radiated Emission Above 1GHz	9262 to 9538	9262, 9400, 9538	WCDMA

Test Condition:

Test Item	Environmental Conditions	Input Power (System)	Tested By
EIRP	24deg. C, 64%RH	120Vac, 60Hz	Match Tsui
Frequency Stability	24deg. C, 64%RH	3.85Vdc	Match Tsui
Occupied Bandwidth	24deg. C, 64%RH	120Vac, 60Hz	Match Tsui
Band Edge	24deg. C, 64%RH	120Vac, 60Hz	Match Tsui
Peak To Average Ratio	24deg. C, 64%RH	120Vac, 60Hz	Match Tsui
Conducted Emission	24deg. C, 64%RH	120Vac, 60Hz	Match Tsui
Radiated Emission	24deg. C, 51%RH 25deg. C, 69%RH	120Vac, 60Hz	Bond Tseng Tank Wu

### 3.4 EUT Operating Conditions

The EUT makes a call to the communication simulator. The communication simulator station system controlled a EUT to export maximum output power under transmission mode and specific channel frequency

### 3.5 General Description of Applied Standards

The EUT is a RF Product. According to the specifications of the manufacturer, it must comply with the requirements of the following standards:

**FCC 47 CFR Part 2**

**FCC 47 CFR Part 24**

**KDB 971168 D01 Power Meas License Digital Systems v02r02**

**ANSI/TIA/EIA-603-D 2010**

All test items have been performed and recorded as per the above standards.

Note: The EUT has been verified to comply with the requirements of FCC Part 15, Subpart B, Class B (DoC).  
The test report has been issued separately.

## 4 Test Types and Results

### 4.1 Output Power Measurement

#### 4.1.1 Limits of Output Power Measurement

Mobile / Portable station are limited to 2 watts e.r.p.

#### 4.1.2 Test Procedures

##### **EIRP / ERP Measurement:**

- a. All measurements were done at low, middle and high operational frequency range. RBW and VBW is 1MHz for GSM and 5MHz for WCDMA mode.
- b. Substitution method is used for E.I.R.P measurement. In the semi-anechoic chamber, EUT placed on the 0.8m height of Turn Table, rotated the table around 360 degrees to search the maximum radiation power and receiver antenna shall be rotated vertical and horizontal polarization and moved height from 1m to 4m to find the maximum polar radiated power. The "Read Value" is the spectrum reading the maximum power value.
- c. The substitution horn antenna is substituted for EUT at the same position and signals generator export the CW signal to the substitution antenna via a TX cable. Rotated the Turn Table and moved receiving antenna to find the maximum radiation power. Adjust output power level of S.G to get a Value of spectrum reading equal to "Read Value" of step b. Record the power level of S.G
- d.  $EIRP = \text{Output power level of S.G} - \text{TX cable loss} + \text{Antenna gain of substitution horn}$ . E.R.P power can be calculated form E.I.R.P power by subtracting the gain of dipole,  $E.R.P \text{ power} = E.I.R.P \text{ power} - 2.15\text{dBi}$ .

##### **Conducted Power Measurement:**

The EUT was set up for the maximum power with GSM, WCDMA link data modulation and link up with simulator. Set the EUT to transmit under low, middle and high channel and record the power level shown on simulator.

### 4.1.3 Test Setup

EIRP / ERP Measurement:

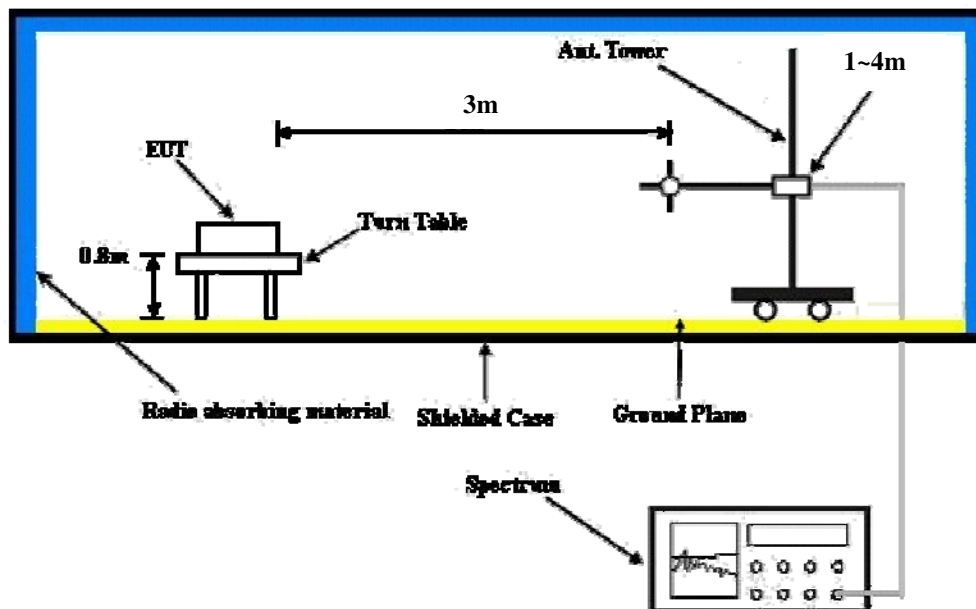

For the actual test configuration, please refer to the attached file (Test Setup Photo).

Conducted Power Measurement:



For the actual test configuration, please refer to the attached file (Test Setup Photo).

#### 4.1.4 Test Results

Conducted Output Power (dBm)

Band	GSM1900		
Channel	512	661	810
Frequency	1850.2	1880	1909.8
GSM	29.91	<b>29.98</b>	29.94
GPRS 8	29.89	29.96	29.92
GPRS 10	29.31	29.38	29.34
GPRS 11	27.61	27.68	27.64
GPRS 12	26.54	26.61	26.57
GPRS 30	29.88	29.95	29.91
GPRS 31	29.30	29.37	29.33
GPRS 32	27.59	27.66	27.62
GPRS 33	26.53	26.60	26.56
EDGE 8 (MCS9)	25.82	25.89	25.85
EDGE 10 (MCS9)	24.84	24.91	24.87
EDGE 11 (MCS9)	22.81	22.88	22.84
EDGE 12 (MCS9)	21.71	21.78	21.74
EDGE 30 (MCS9)	25.79	25.86	25.82
EDGE 31 (MCS9)	24.83	24.90	24.86
EDGE 32 (MCS9)	22.78	22.85	22.81
EDGE 33 (MCS9)	21.70	21.77	21.73

Band	WCDMA II		
Channel	9262	9400	9538
Frequency	1852.4	1880	1907.6
RMC 12.2K	23.26	23.32	<b>23.35</b>
HSDPA Subtest-1	22.16	22.20	22.24
HSDPA Subtest-2	22.13	22.19	22.22
HSDPA Subtest-3	21.69	21.73	21.84
HSDPA Subtest-4	21.56	21.69	21.71
HSUPA Subtest-1	20.36	20.41	20.53
HSUPA Subtest-2	20.26	20.31	20.33
HSUPA Subtest-3	20.77	20.85	20.88
HSUPA Subtest-4	19.84	19.90	19.99
HSUPA Subtest-5	22.24	22.28	22.30

EIRP Power (dBm)  
GSM Mode

MODE		TX channel 512					
Antenna Polarity & Test Distance: Horizontal at 3 M							
No.	Freq. (MHz)	Reading (dBm)	S.G Power Value (dBm)	Correction Factor (dB)	EIRP (dBm)	Limit (dBm)	Margin (dB)
1	1850.20	-16.20	24.00	0.10	24.10	33.00	-8.90
Antenna Polarity & Test Distance: Vertical at 3 M							
No.	Freq. (MHz)	Reading (dBm)	S.G Power Value (dBm)	Correction Factor (dB)	EIRP (dBm)	Limit (dBm)	Margin (dB)
1	1850.20	-14.00	26.40	0.10	26.50	33.00	-6.50

MODE		TX channel 661					
Antenna Polarity & Test Distance: Horizontal at 3 M							
No.	Freq. (MHz)	Reading (dBm)	S.G Power Value (dBm)	Correction Factor (dB)	EIRP (dBm)	Limit (dBm)	Margin (dB)
1	1880.00	-17.90	22.60	0.00	22.60	33.00	-10.40
Antenna Polarity & Test Distance: Vertical at 3 M							
No.	Freq. (MHz)	Reading (dBm)	S.G Power Value (dBm)	Correction Factor (dB)	EIRP (dBm)	Limit (dBm)	Margin (dB)
1	1880.00	-16.40	24.20	0.00	24.20	33.00	-8.80

MODE		TX channel 810					
Antenna Polarity & Test Distance: Horizontal at 3 M							
No.	Freq. (MHz)	Reading (dBm)	S.G Power Value (dBm)	Correction Factor (dB)	EIRP (dBm)	Limit (dBm)	Margin (dB)
1	1909.80	-18.90	21.70	-0.10	21.60	33.00	-11.40
Antenna Polarity & Test Distance: Vertical at 3 M							
No.	Freq. (MHz)	Reading (dBm)	S.G Power Value (dBm)	Correction Factor (dB)	EIRP (dBm)	Limit (dBm)	Margin (dB)
1	1909.80	-16.40	24.40	-0.10	24.30	33.00	-8.70

Note: EIRP (dBm) = S.G Power Value (dBm) + Correction Factor (dB).

WCDMA Mode

MODE		TX channel 9262					
Antenna Polarity & Test Distance: Horizontal at 3 M							
No.	Freq. (MHz)	Reading (dBm)	S.G Power Value (dBm)	Correction Factor (dB)	EIRP (dBm)	Limit (dBm)	Margin (dB)
1	1852.40	-22.50	17.70	0.10	17.80	33.00	-15.20
Antenna Polarity & Test Distance: Vertical at 3 M							
No.	Freq. (MHz)	Reading (dBm)	S.G Power Value (dBm)	Correction Factor (dB)	EIRP (dBm)	Limit (dBm)	Margin (dB)
1	1852.40	-20.40	20.00	0.10	20.10	33.00	-12.90

MODE		TX channel 9400					
Antenna Polarity & Test Distance: Horizontal at 3 M							
No.	Freq. (MHz)	Reading (dBm)	S.G Power Value (dBm)	Correction Factor (dB)	EIRP (dBm)	Limit (dBm)	Margin (dB)
1	1880.00	-25.60	14.90	0.00	14.90	33.00	-18.10
Antenna Polarity & Test Distance: Vertical at 3 M							
No.	Freq. (MHz)	Reading (dBm)	S.G Power Value (dBm)	Correction Factor (dB)	EIRP (dBm)	Limit (dBm)	Margin (dB)
1	1880.00	-21.80	18.80	0.00	18.80	33.00	-14.20

MODE		TX channel 9538					
Antenna Polarity & Test Distance: Horizontal at 3 M							
No.	Freq. (MHz)	Reading (dBm)	S.G Power Value (dBm)	Correction Factor (dB)	EIRP (dBm)	Limit (dBm)	Margin (dB)
1	1907.60	-23.80	16.90	-0.10	16.80	33.00	-16.20
Antenna Polarity & Test Distance: Vertical at 3 M							
No.	Freq. (MHz)	Reading (dBm)	S.G Power Value (dBm)	Correction Factor (dB)	EIRP (dBm)	Limit (dBm)	Margin (dB)
1	1907.60	-22.60	18.20	-0.10	18.10	33.00	-14.90

Note: EIRP (dBm) = S.G Power Value (dBm) + Correction Factor (dB).

## 4.2 Frequency Stability Measurement

### 4.2.1 Limits of Frequency Stability Measurement

1.5 ppm is for base and fixed station. 2.5 ppm is for mobile station.

### 4.2.2 Test Procedure

- Device is placed at the oven room. The oven room could control the temperatures and humidity. Power warm up is at least 15 min and power applied should perform before recording frequency error.
- EUT is connected the external power supply to control the DC input power. The test voltage range is from minimum to maximum working voltage. Each step shall be record the frequency error rate.
- The temperature range step is 10 degrees in this test items. All temperature levels shall be hold the  $\pm 0.5$  °C during the measurement testing. The each temperature step shall be at least 0.5 hours, consider the EUT could be test under the stability condition.

NOTE: The frequency error was recorded frequency error from the communication simulator.

### 4.2.3 Test Setup

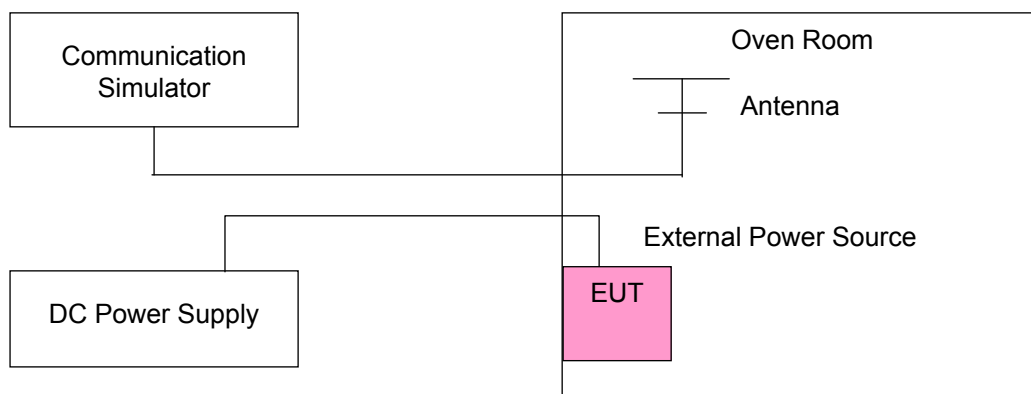



#### 4.2.4 Test Results

##### Frequency Error vs. Voltage

Voltage (Volts)	Frequency Error (ppm)		Limit (ppm)
	GSM	WCDMA	
4.35	-0.005	-0.005	2.5
3.85	-0.005	-0.005	2.5
3.60	-0.005	-0.005	2.5

Note: The applicant defined the normal working voltage is from 3.60Vdc to 4.35Vdc.

##### Frequency Error vs. Temperature.

Temp. (°C)	Frequency Error (ppm)		Limit (ppm)
	GSM	WCDMA	
50	-0.005	-0.005	2.5
40	-0.005	-0.004	2.5
30	-0.005	-0.005	2.5
20	-0.005	-0.005	2.5
10	-0.005	-0.005	2.5
0	-0.007	-0.007	2.5
-10	-0.008	-0.007	2.5
-20	-0.007	-0.007	2.5

### 4.3 Occupied Bandwidth Measurement

#### 4.3.1 Test Procedure

The EUT makes a call to the communication simulator. All measurements were done at low, middle and high operational frequency range. The communication simulator station system controlled a EUT to export maximum output power under transmission mode and specific channel frequency. Use OBW measurement function of Spectrum analyzer to measure 99 % occupied bandwidth.

#### 4.3.2 Test Setup

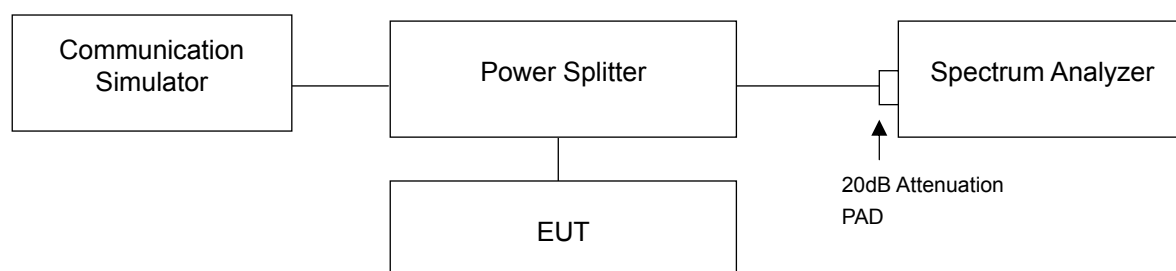

### 4.3.3 Test Result

Channel	Frequency (MHz)	99% Occupied Bandwidth (kHz)		
		GSM	GPRS	EDGE
512	1850.2	250	250	245
661	1880.0	250	250	250
810	1909.8	260	255	260

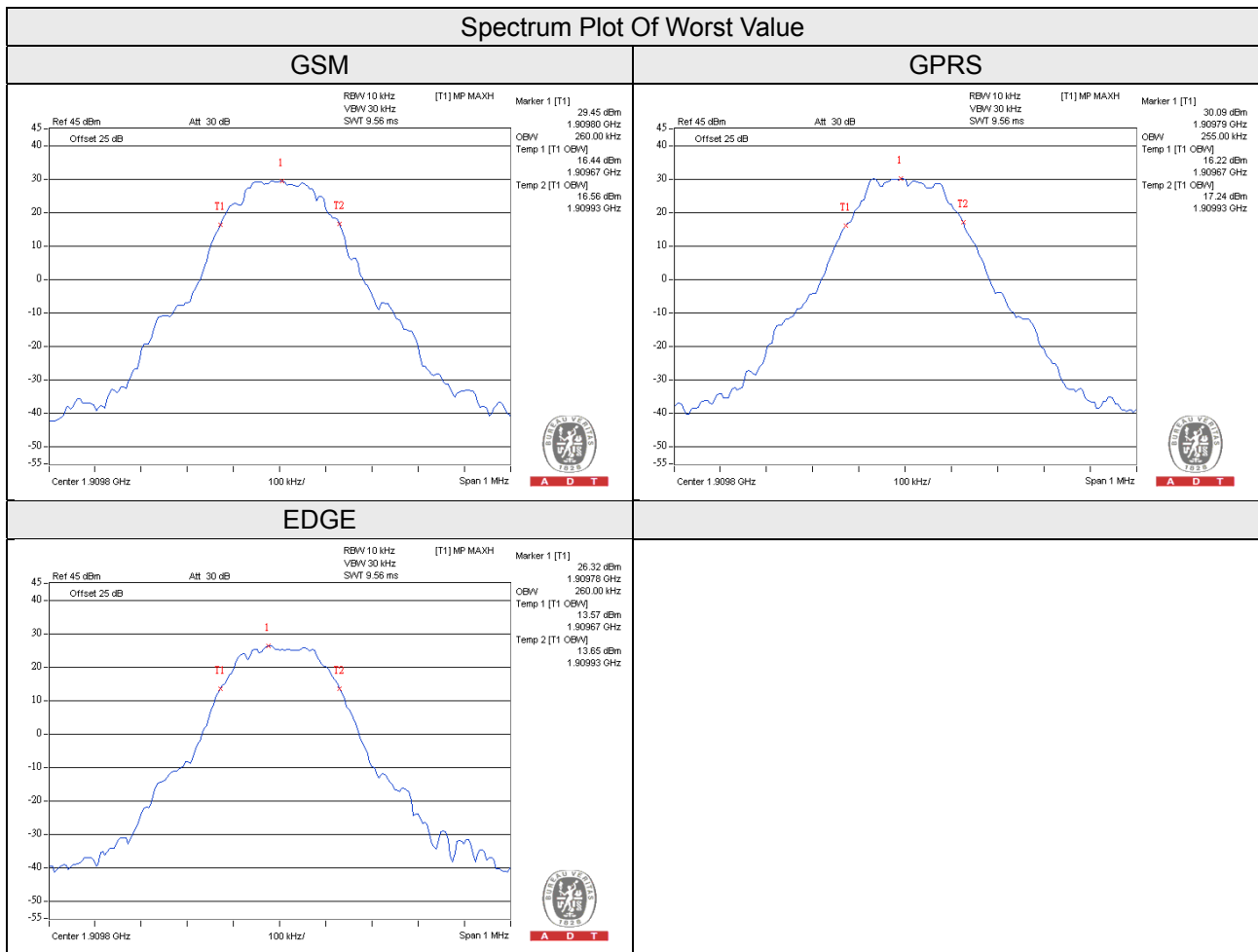

Channel	Frequency (MHz)	99% Occupied Bandwidth (MHz)		
		WCDMA	HSDPA	HSUPA
9262	1852.4	4.23	4.22	4.23
9400	1880.0	4.25	4.22	4.25
9538	1907.6	4.22	4.25	4.23

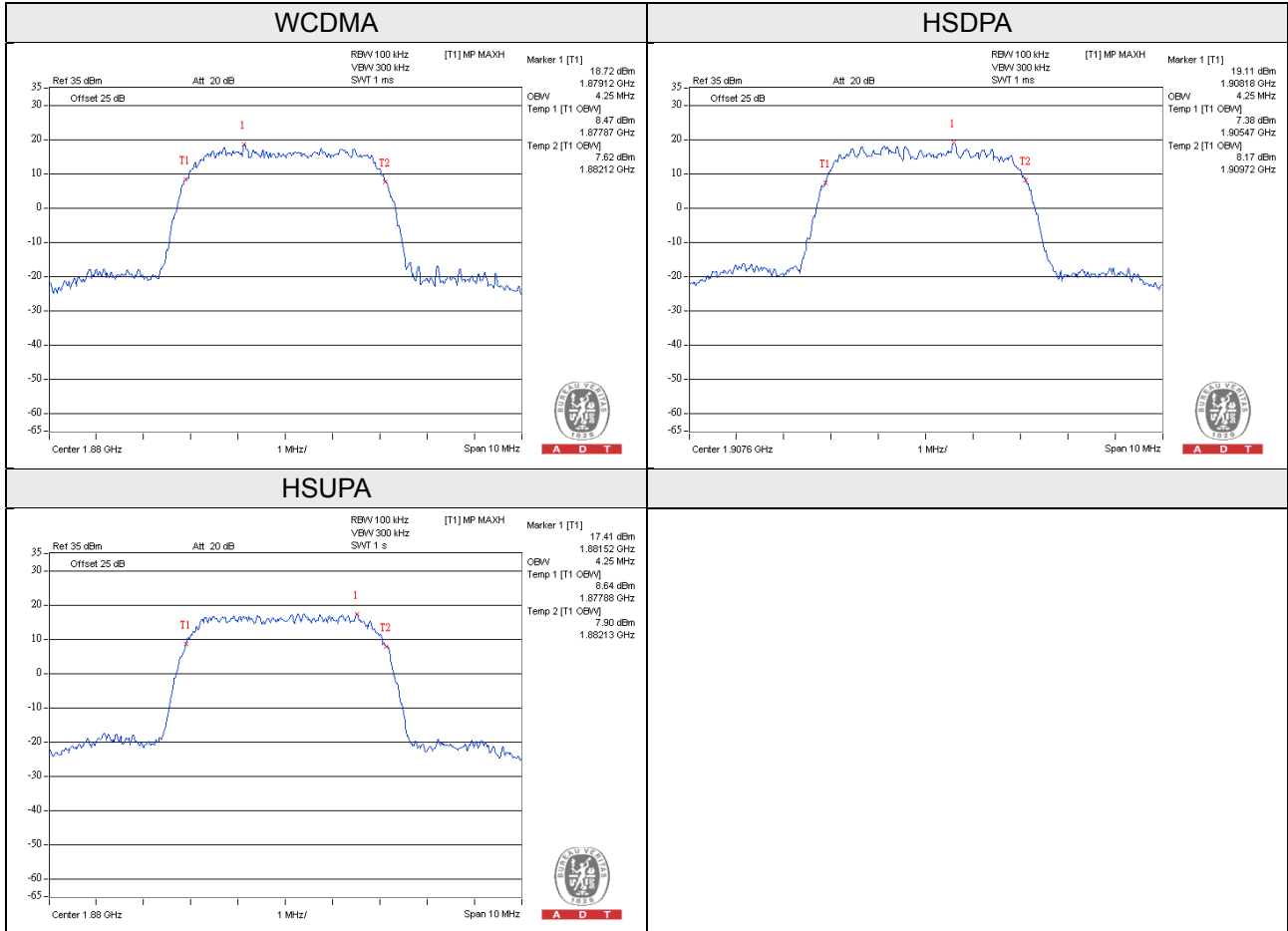

## 4.4 Band Edge Measurement

### 4.4.1 Limits of Band Edge Measurement

Power of any emission outside of the authorized operating frequency ranges must be attenuated below the transmitting power (P) by a factor of at least  $43 + 10 \log(P)$  dB. In the 1 MHz bands immediately outside and adjacent to the frequency block a resolution bandwidth of at least one percent of the emission bandwidth of the fundamental emission of the transmitter may be employed.

### 4.4.2 Test Setup

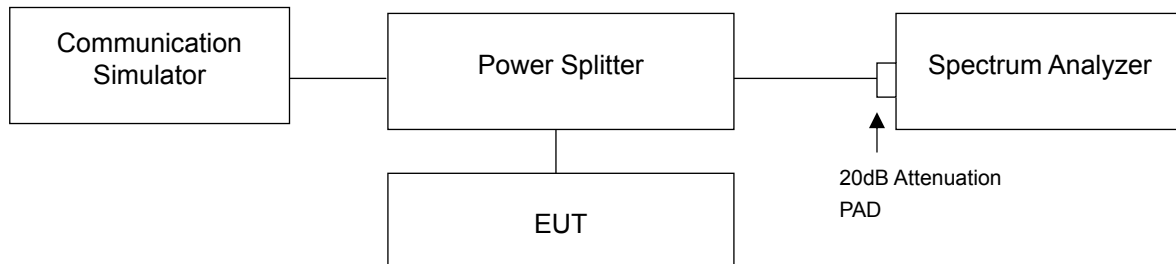

### 4.4.3 Test Procedures

- All measurements were done at low and high operational frequency range.
- The center frequency of spectrum is the band edge frequency and span is 1.5MHz. RB of the spectrum is 3kHz and VB of the spectrum is 10kHz (GSM / GPRS / EDGE).
- The center frequency of spectrum is the band edge frequency and span is 1.5MHz. RB of the spectrum is 100kHz and VB of the spectrum is 300kHz (WCDMA / HSDPA / HSUPA).
- Record the max trace plot into the test report.

### 4.4.4 Test Results

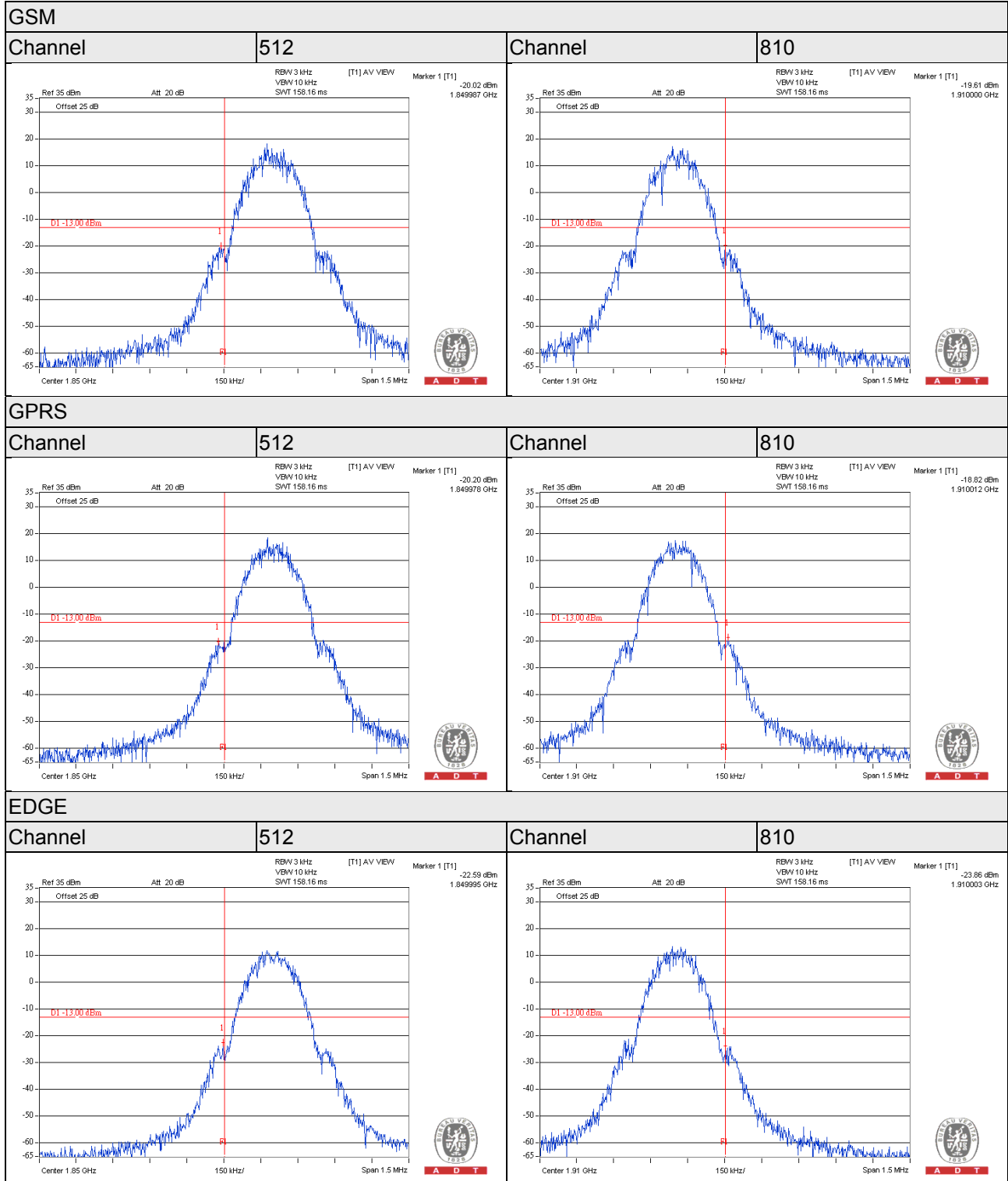

### WCDMA

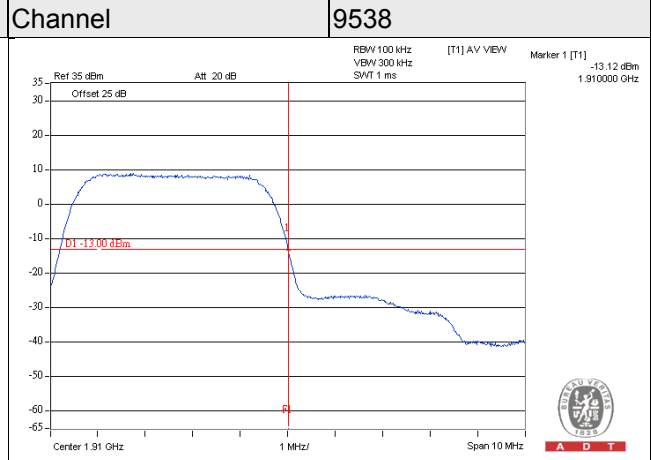
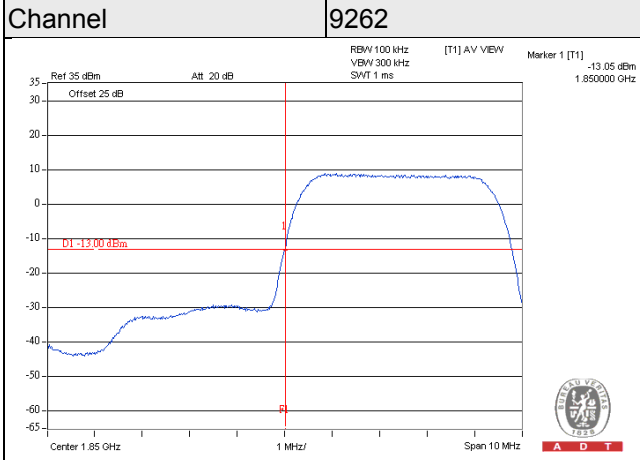

### HSDPA

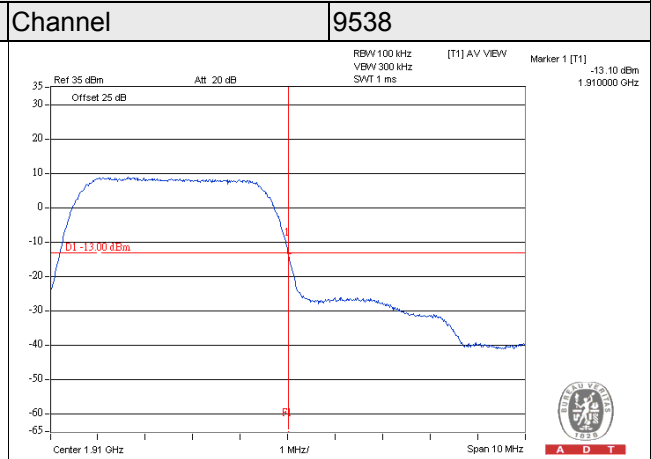
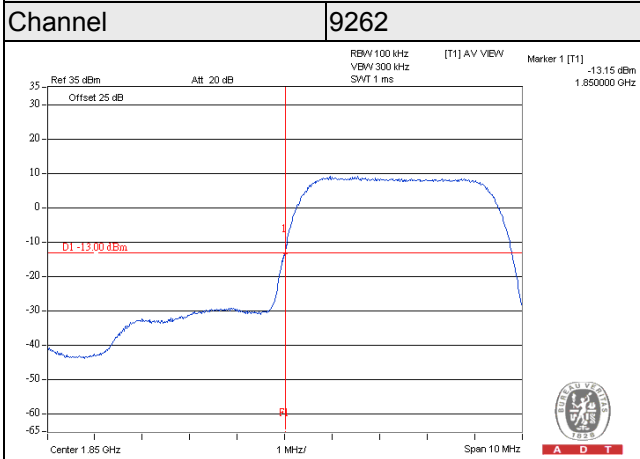

### HSUPA

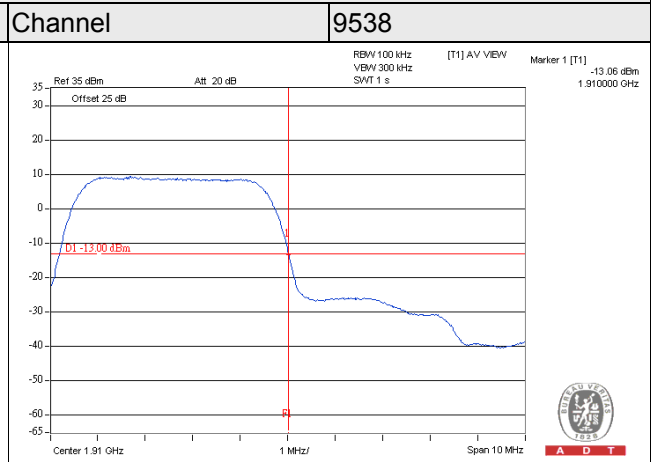
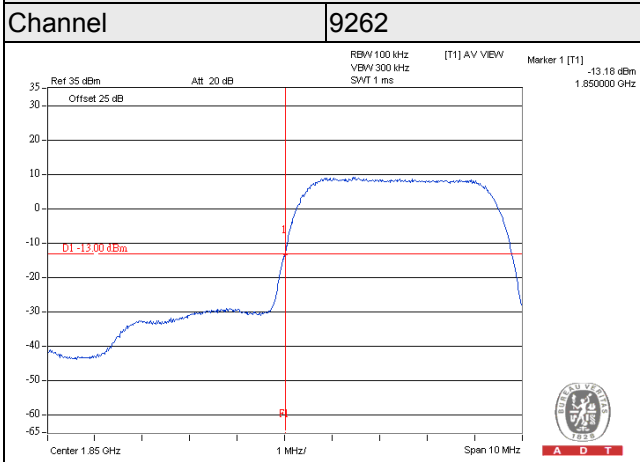

## 4.5 Peak To Average Ratio

### 4.5.1 Limits of Peak To Average Ratio Measurement

In measuring transmissions in this band using an average power technique, the peak to-average ratio (PAR) of the transmission may not exceed 13 dB

### 4.5.2 Test Setup

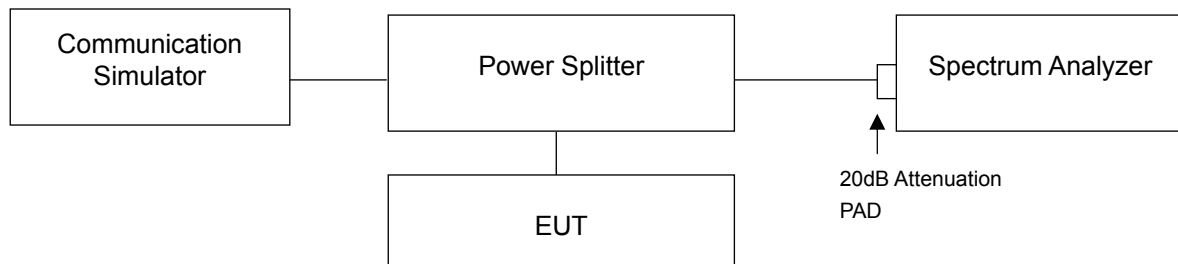

### 4.5.3 Test Procedures

- Set resolution/measurement bandwidth  $\geq$  signal's occupied bandwidth;
- Set the number of counts to a value that stabilizes the measured CCDF curve;
- Record the maximum PAPR level associated with a probability of 0.1%.



#### 4.5.4 Test Results

Channel	Frequency (MHz)	Peak To Average Ratio (dB)		
		GSM	GPRS	EDGE
512	1850.2	3.53	4.28	3.42
661	1880.0	3.74	4.87	3.30
810	1909.8	3.95	4.30	3.15

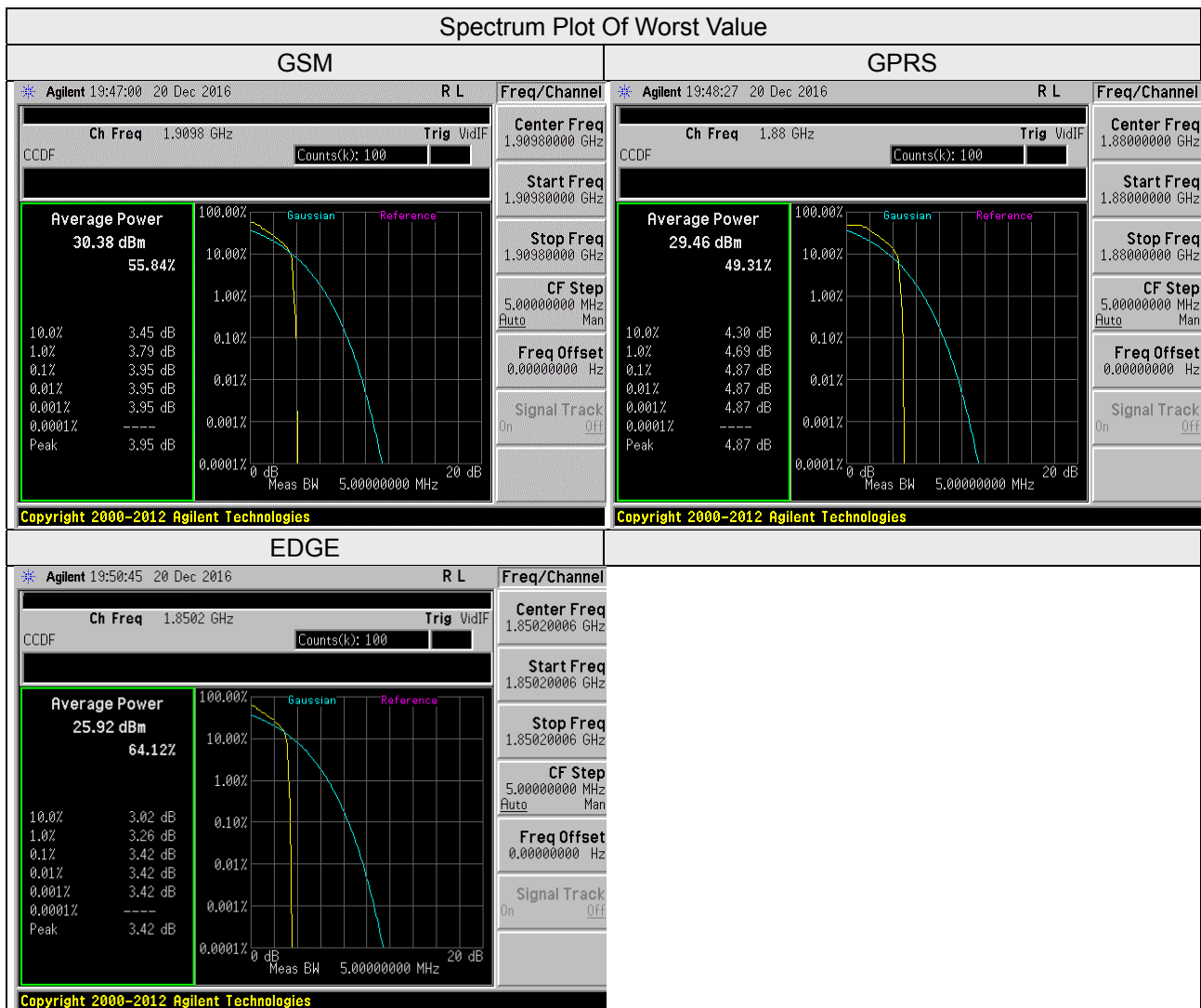

Channel	Frequency (MHz)	Peak To Average Ratio (dB)		
		WCDMA	HSDPA	HSUPA
9262	1852.4	2.70	2.70	2.67
9400	1880.0	2.90	2.91	2.80
9538	1907.6	2.70	2.92	2.95

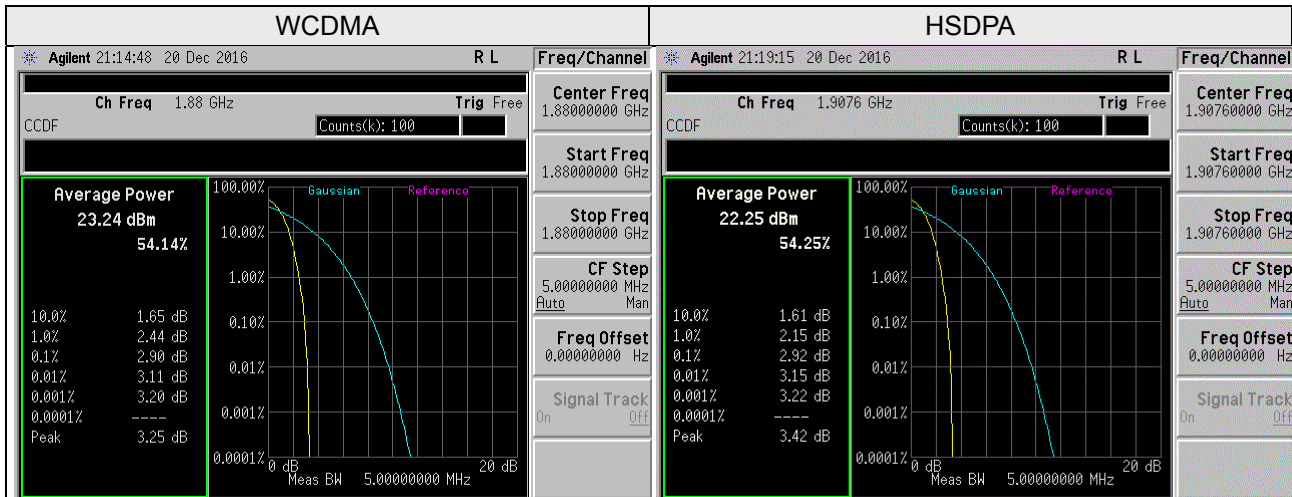

## 4.6 Conducted Spurious Emissions

### 4.6.1 Limits of Conducted Spurious Emissions Measurement

The power of any emission outside of the authorized operating frequency ranges must be attenuated below the transmitting power (P) by a factor of at least  $43 + 10 \log(P)$  dB. The emission limit equal to  $-13\text{dBm}$ .

### 4.6.2 Test Setup

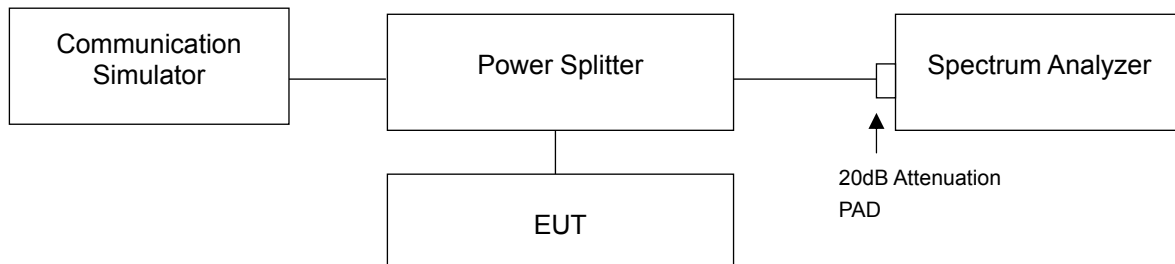

### 4.6.3 Test Procedure

- The EUT makes a phone call to the communication simulator. All measurements were done at low, middle and high operational frequency range.
- Measuring frequency range is from 9 kHz to 20GHz. 20dB attenuation pad is connected with spectrum. RBW=1MHz and VBW=3MHz is used for conducted emission measurement.

### 4.6.4 Test Results

GSM

Channel 512

Frequency Range : 9kHz~3GHz

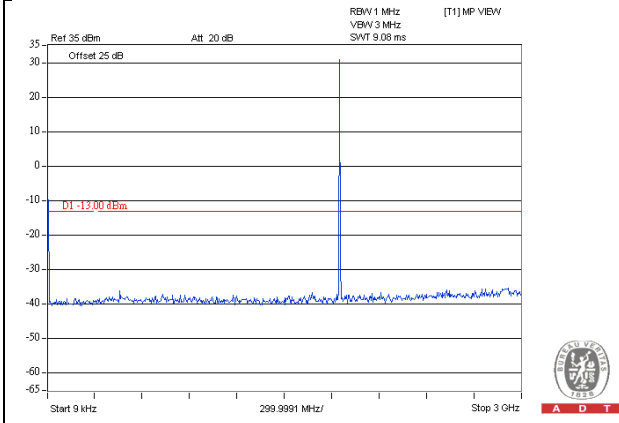

Frequency Range : 3GHz~10GHz

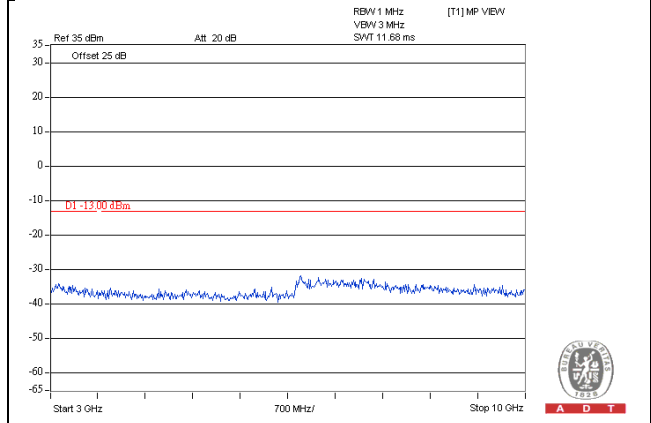

Frequency Range : 10GHz~20GHz

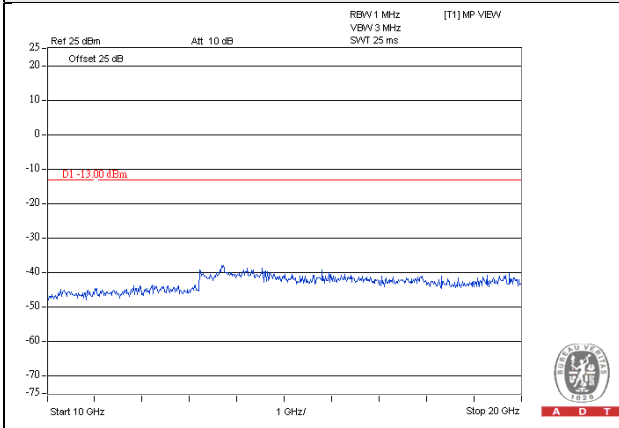

**GSM**

**Channel 661**

**Frequency Range : 9kHz~3GHz**

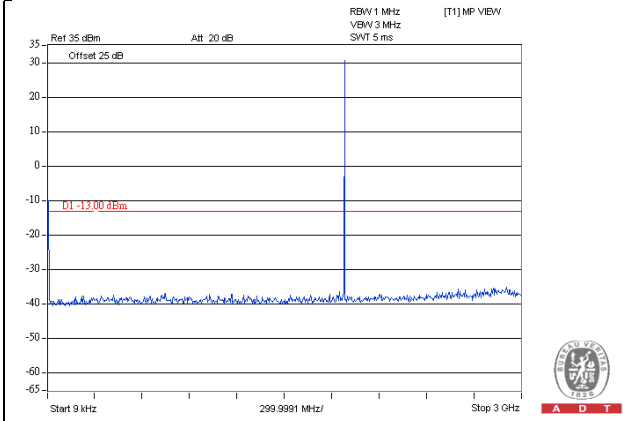

**Frequency Range : 3GHz~10GHz**

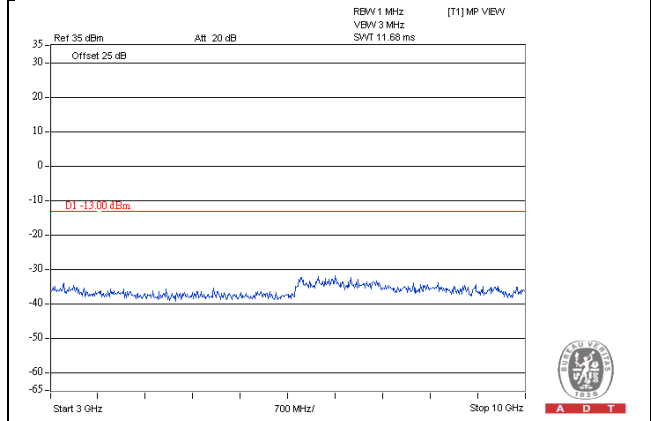

**Frequency Range : 10GHz~20GHz**

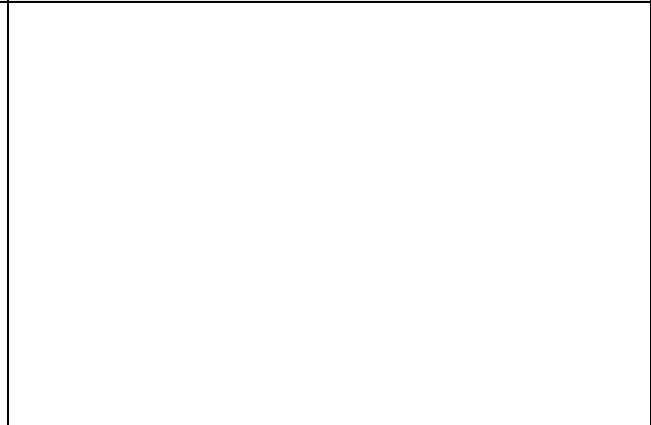
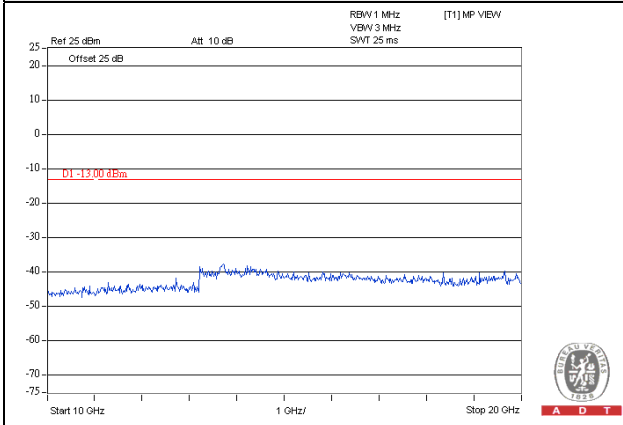

**GSM**

**Channel 810**

**Frequency Range : 9kHz~3GHz**

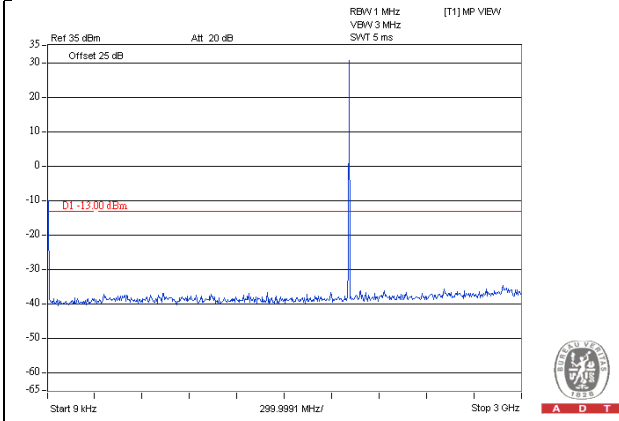

**Frequency Range : 3GHz~10GHz**

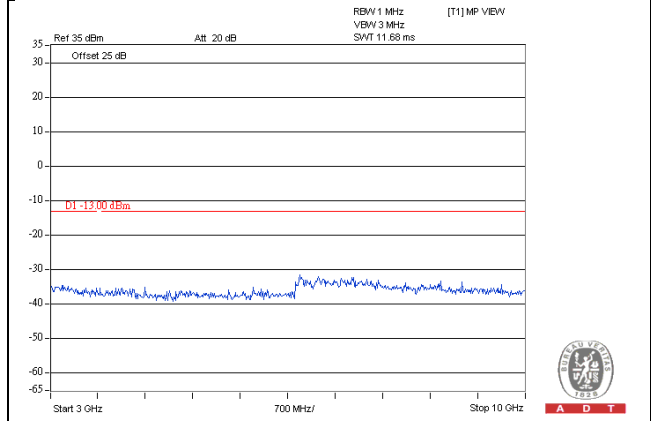

**Frequency Range : 10GHz~20GHz**

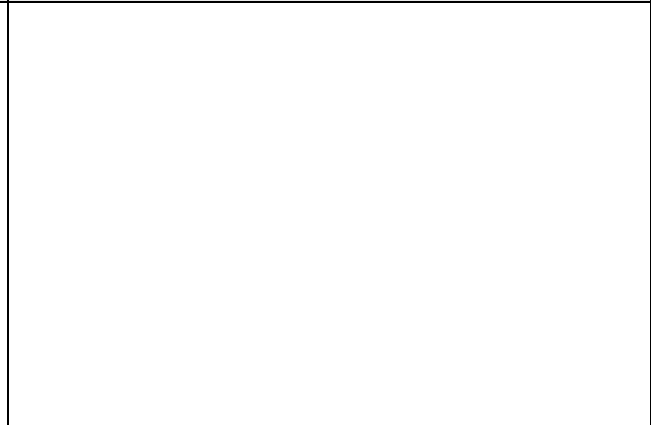
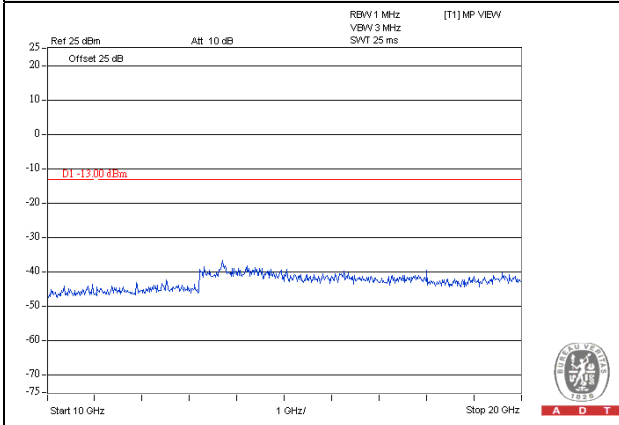

GPRS

Channel 512

Frequency Range : 9kHz~3GHz

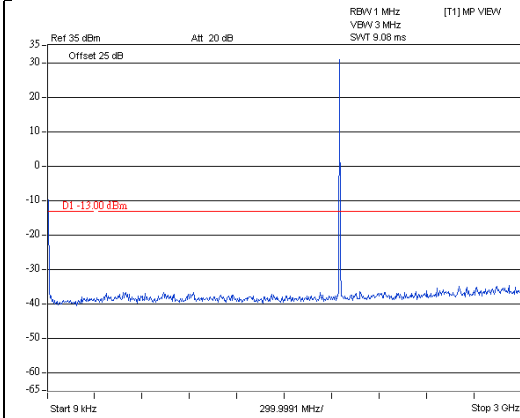

Frequency Range : 3GHz~10GHz

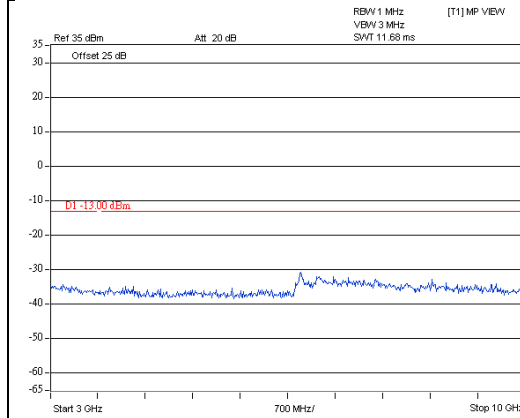

Frequency Range : 10GHz~20GHz

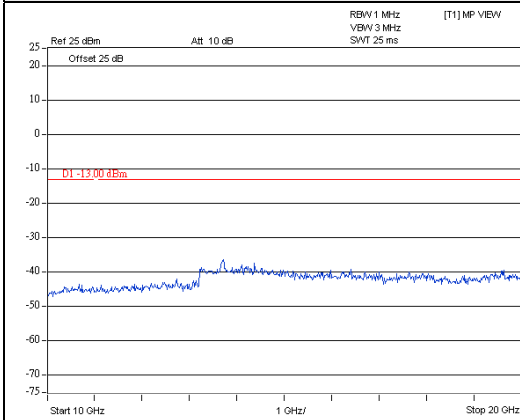

**GPRS**

**Channel 661**

**Frequency Range : 9kHz~3GHz**

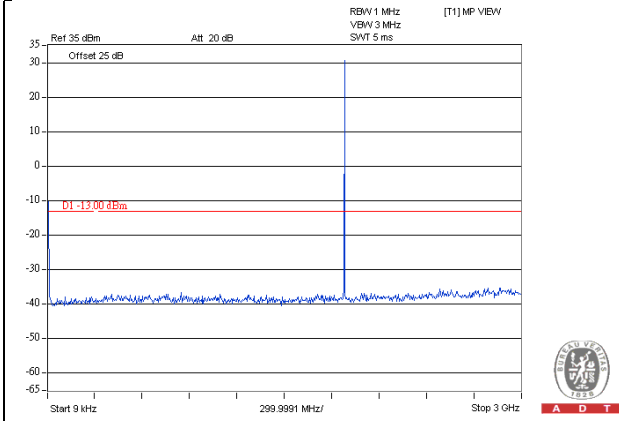

**Frequency Range : 3GHz~10GHz**

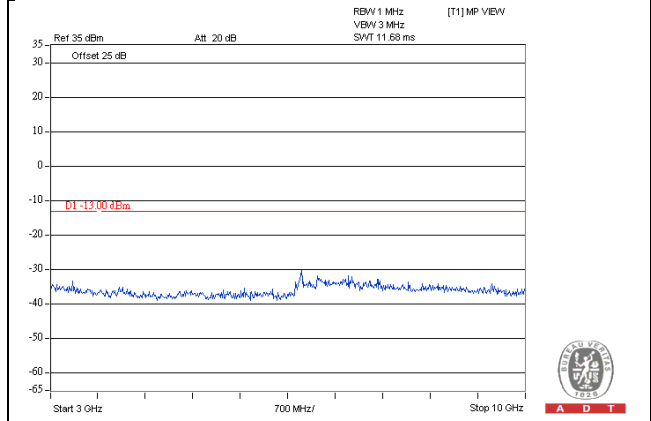

**Frequency Range : 10GHz~20GHz**

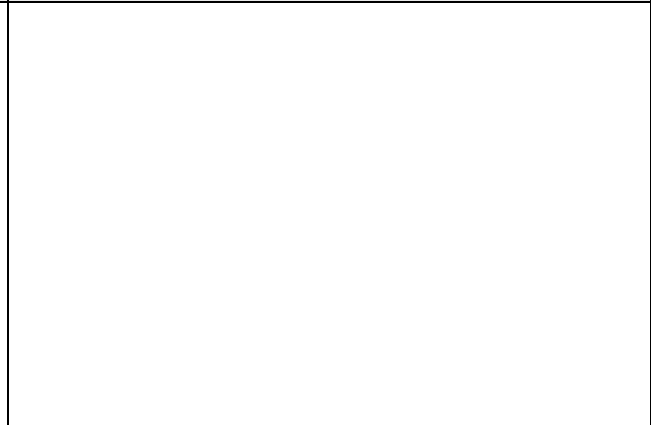
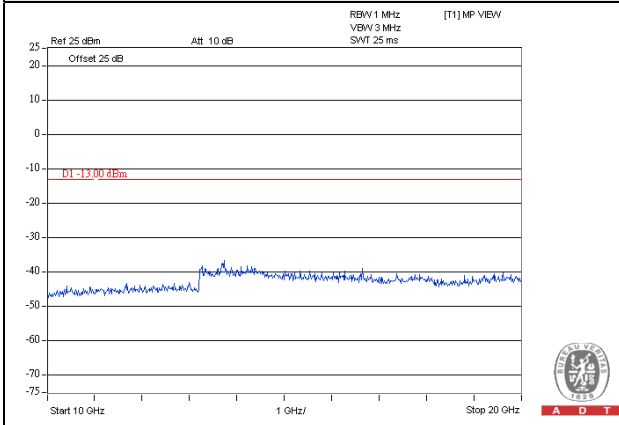



**GPRS**

**Channel 810**

**Frequency Range : 9kHz~3GHz**

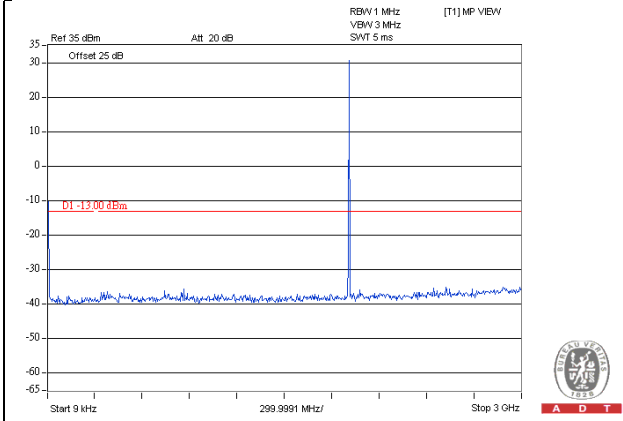

**Frequency Range : 3GHz~10GHz**

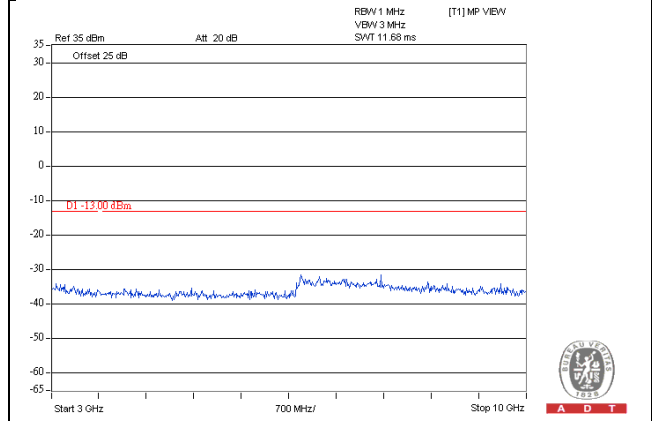

**Frequency Range : 10GHz~20GHz**

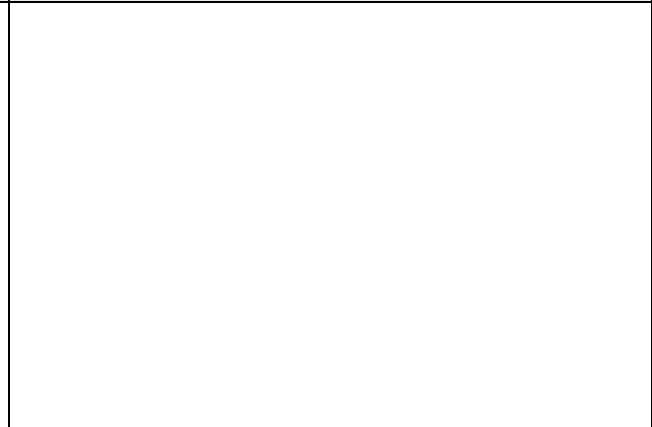
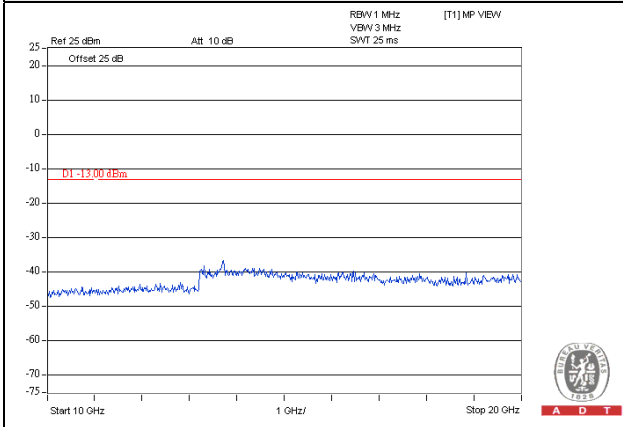

EDGE

Channel 512

Frequency Range : 9kHz~3GHz

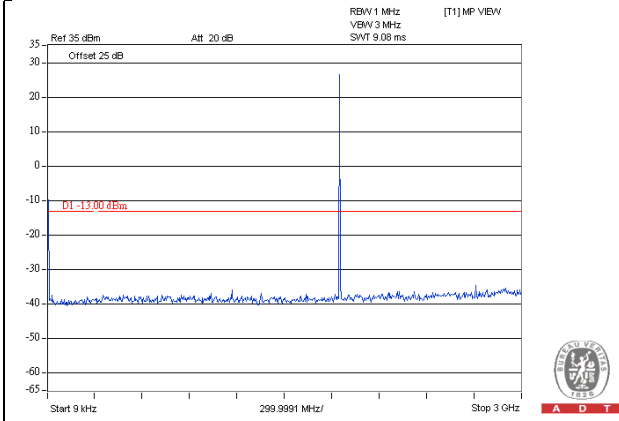

Frequency Range : 3GHz~10GHz

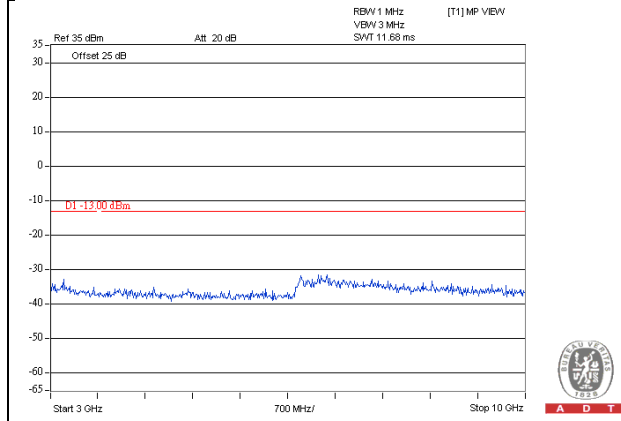

Frequency Range : 10GHz~20GHz

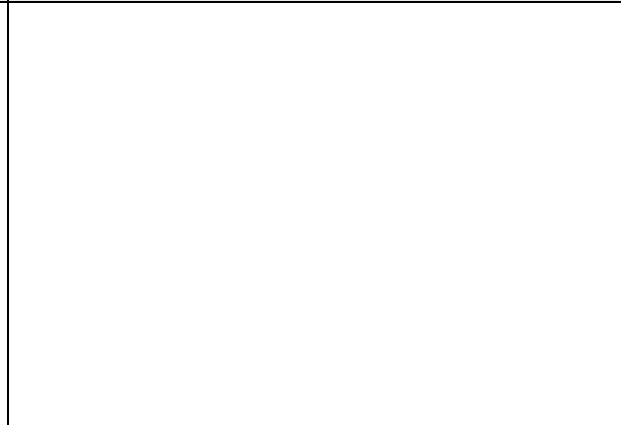
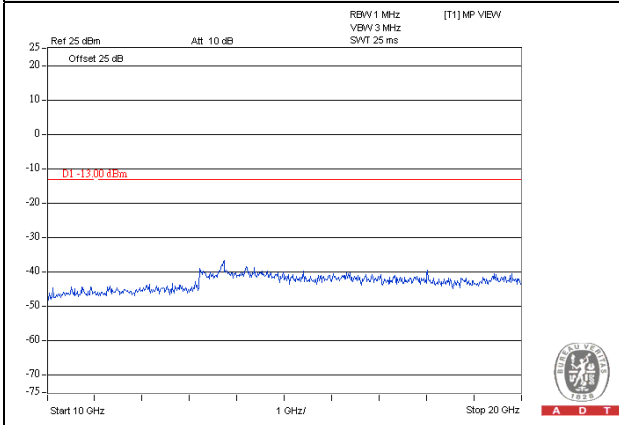

EDGE

Channel 661

Frequency Range : 9kHz~3GHz

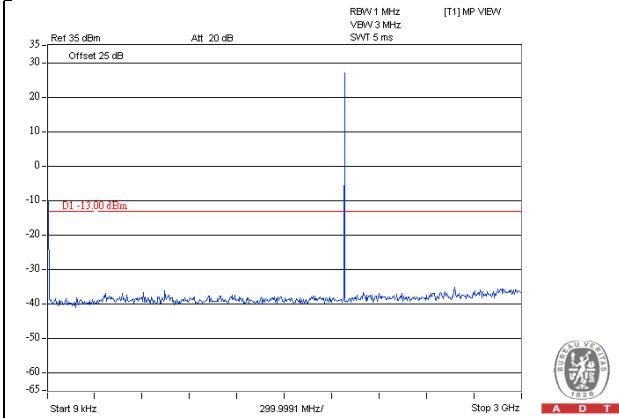

Frequency Range : 3GHz~10GHz

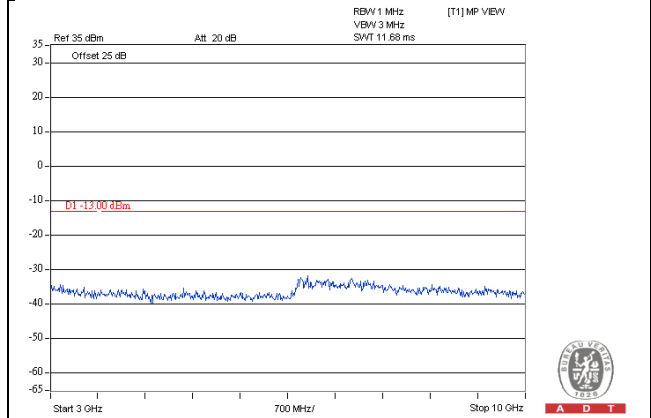

Frequency Range : 10GHz~20GHz

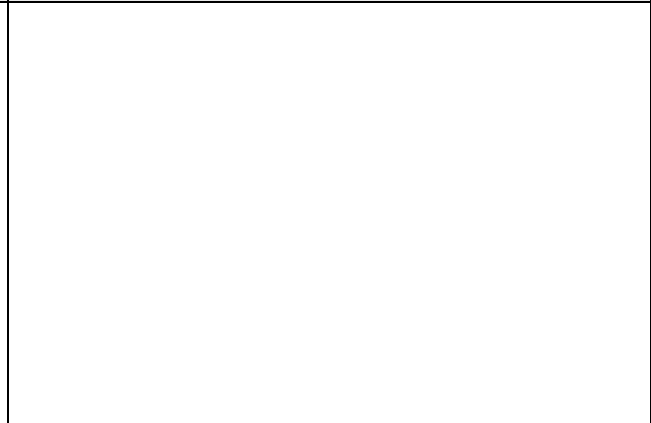
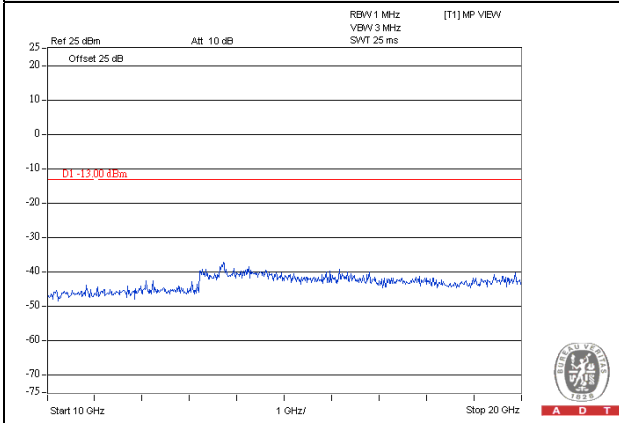

EDGE

Channel 810

Frequency Range : 9kHz~3GHz

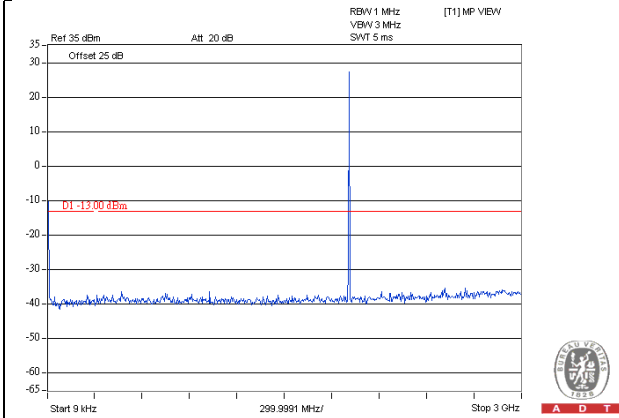

Frequency Range : 3GHz~10GHz

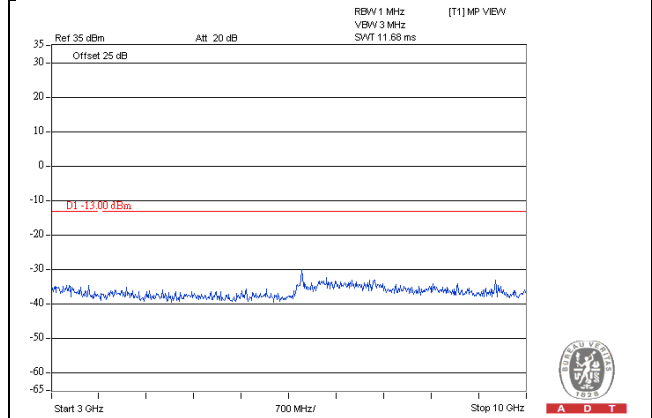

Frequency Range : 10GHz~20GHz

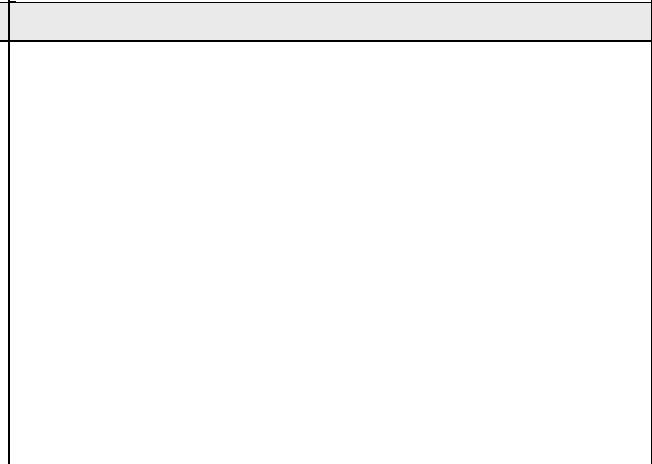
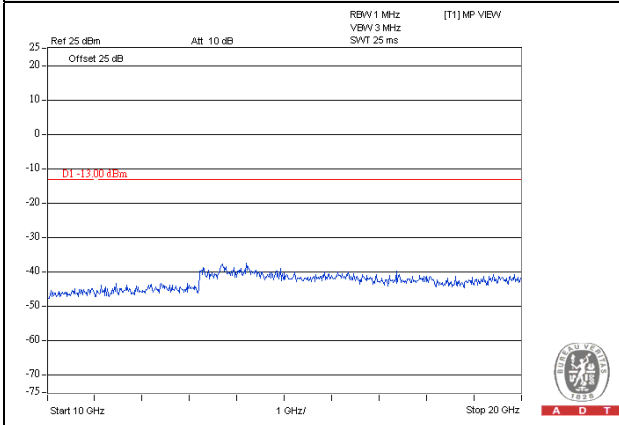

WCDMA

Channel 9262

Frequency Range : 9kHz~3GHz

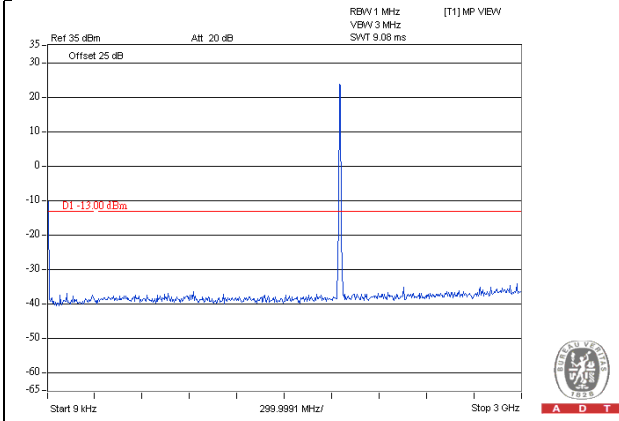

Frequency Range : 3GHz~10GHz

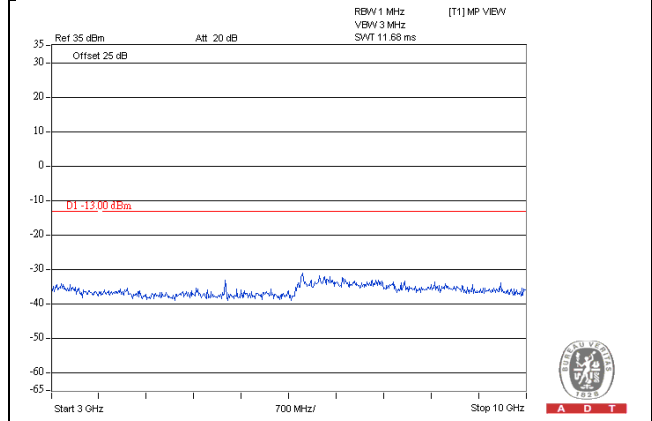

Frequency Range : 10GHz~20GHz

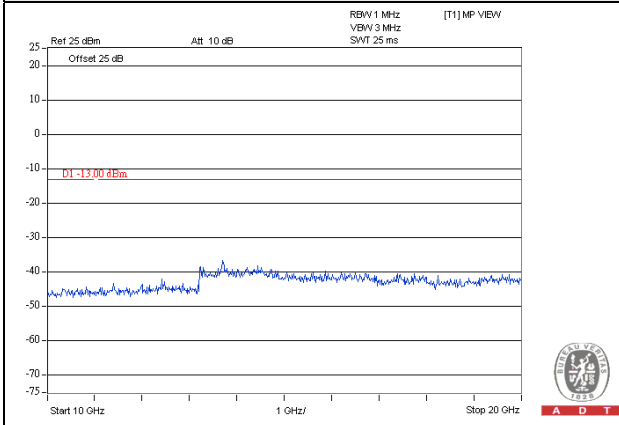

WCDMA

Channel 9400

Frequency Range : 9kHz~3GHz

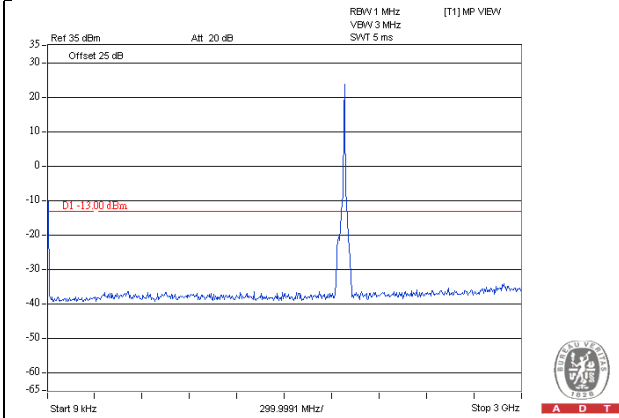

Frequency Range : 3GHz~10GHz

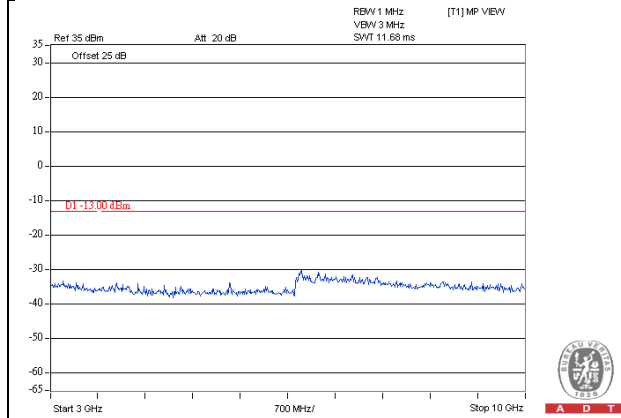

Frequency Range : 10GHz~20GHz

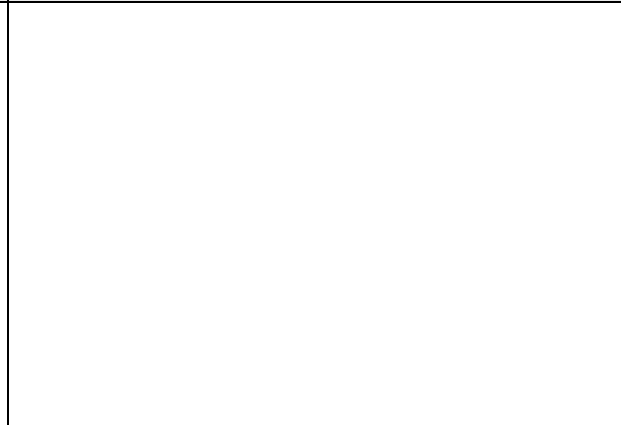
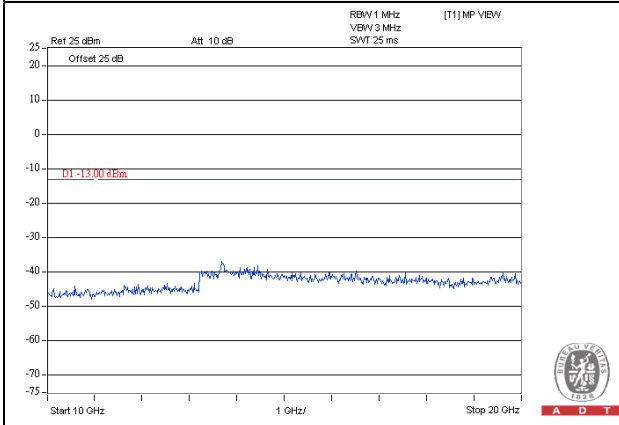

WCDMA

Channel 9538

Frequency Range : 9kHz~3GHz

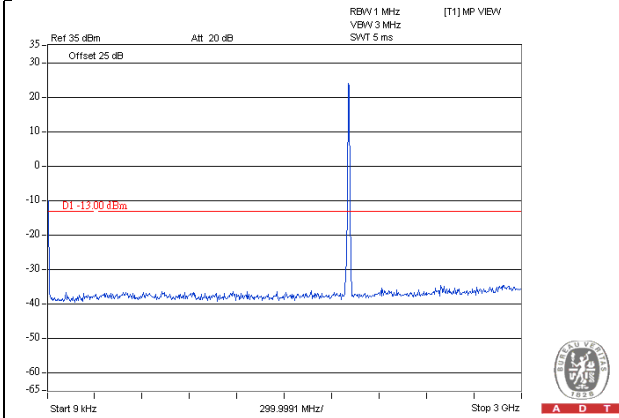

Frequency Range : 3GHz~10GHz

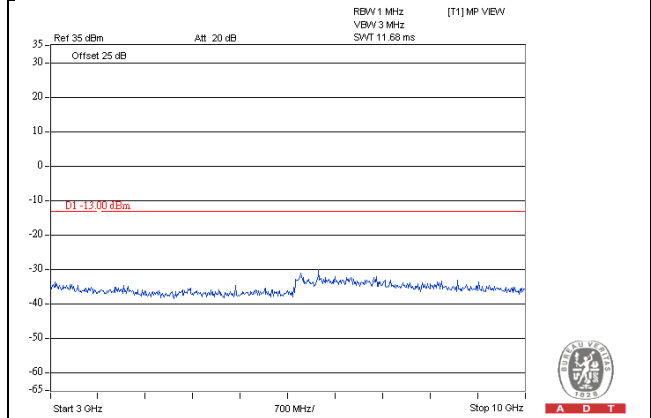

Frequency Range : 10GHz~20GHz

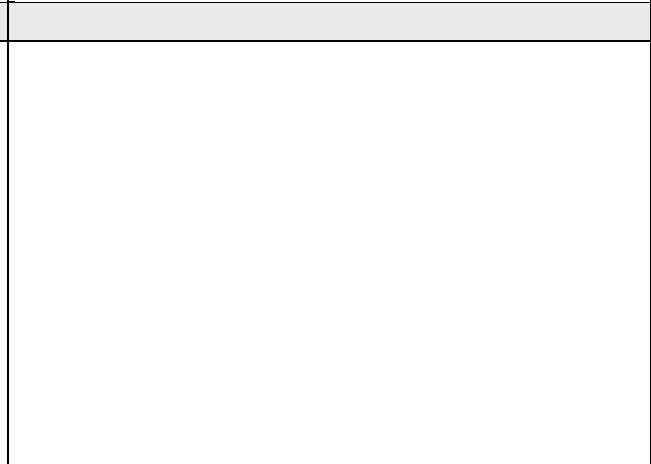
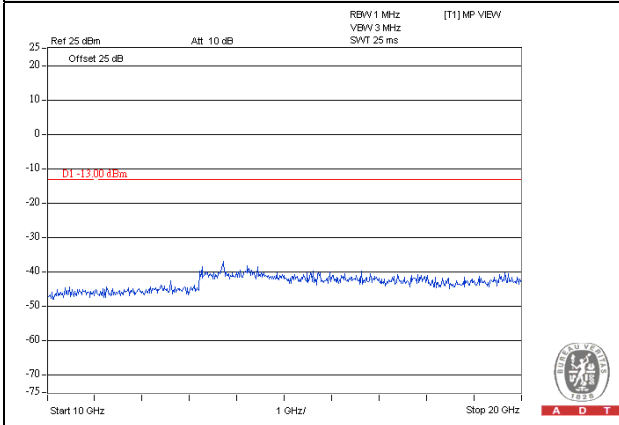

HSDPA

Channel 9262

Frequency Range : 9kHz~3GHz

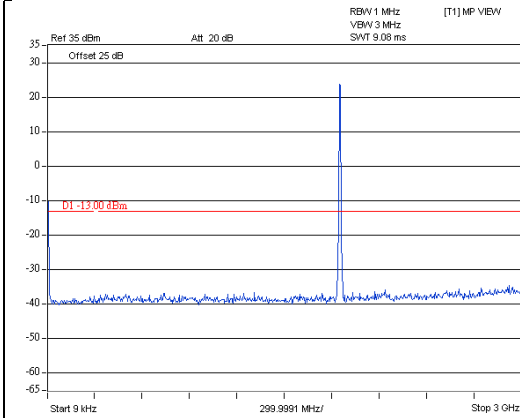

Frequency Range : 3GHz~10GHz

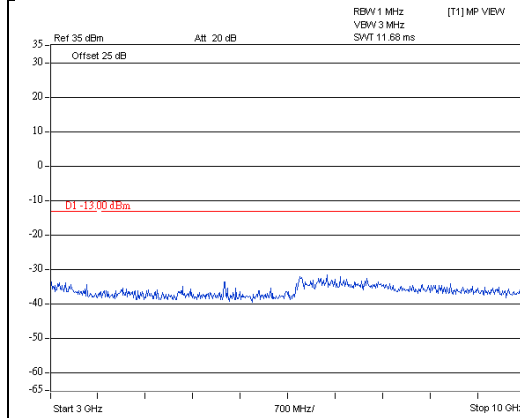

Frequency Range : 10GHz~20GHz

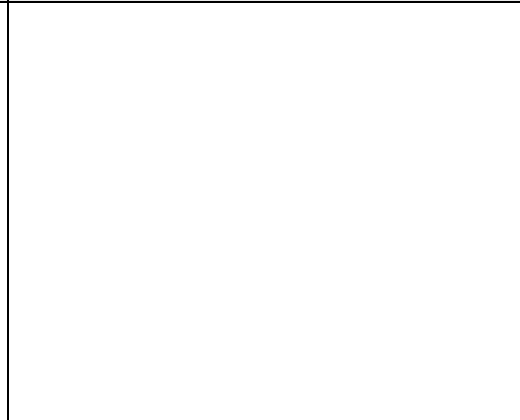
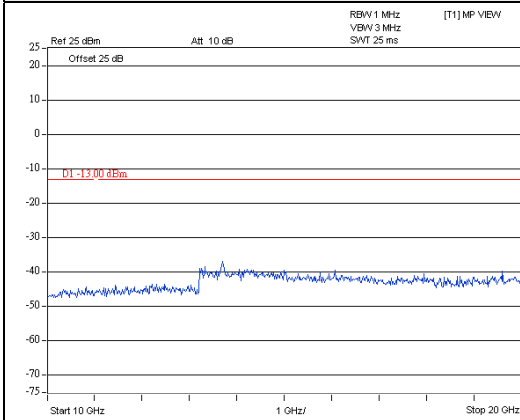



HSDPA

Channel 9400

Frequency Range : 9kHz~3GHz

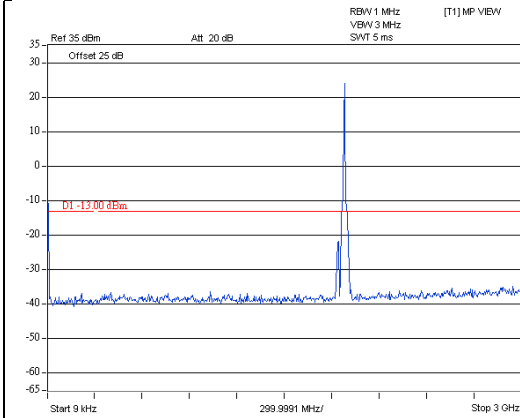

Frequency Range : 3GHz~10GHz

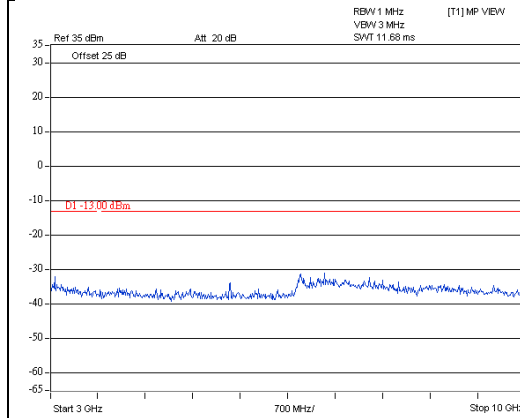

Frequency Range : 10GHz~20GHz

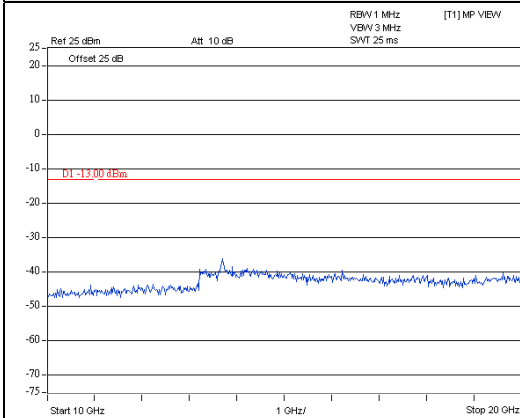

HSDPA

Channel 9538

Frequency Range : 9kHz~3GHz

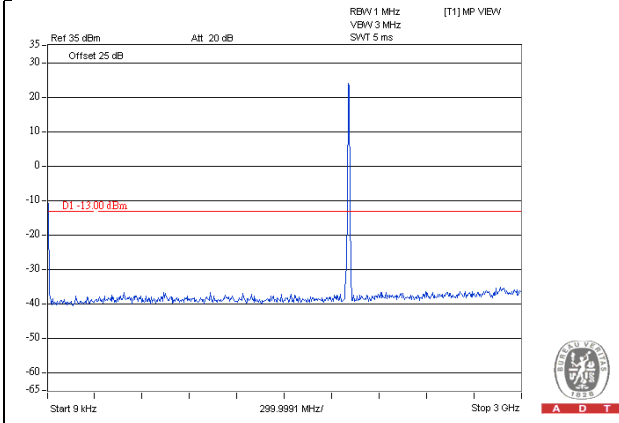

Frequency Range : 3GHz~10GHz

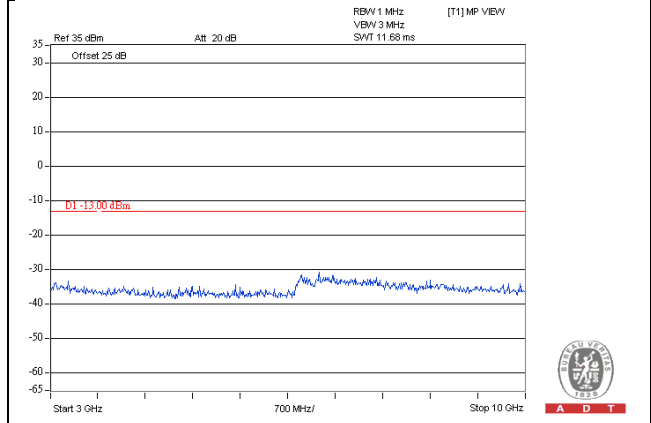

Frequency Range : 10GHz~20GHz

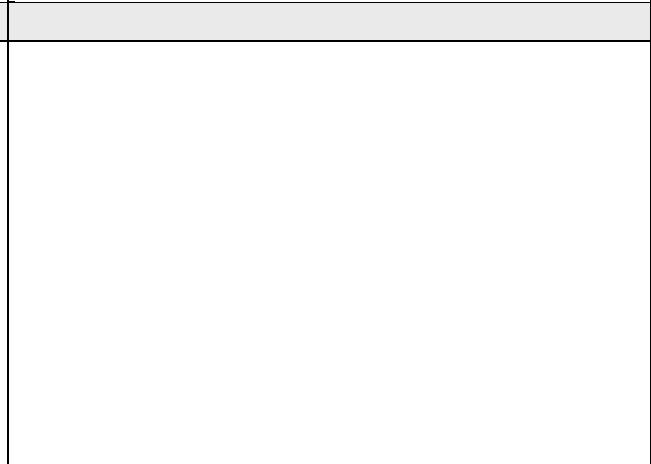
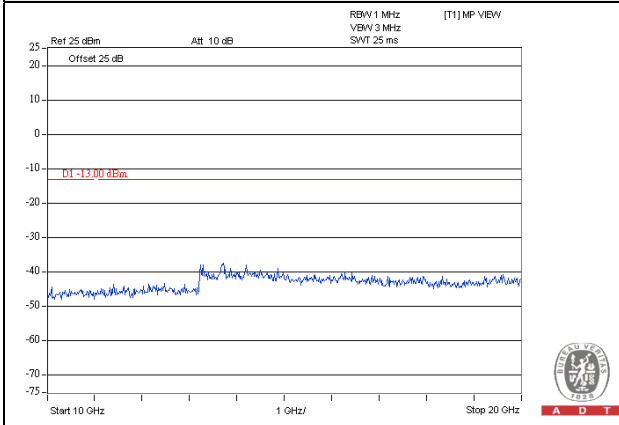

HSUPA

Channel 9262

Frequency Range : 9kHz~3GHz

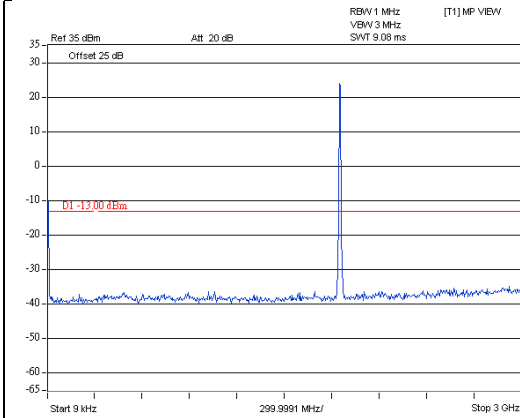

Frequency Range : 3GHz~10GHz

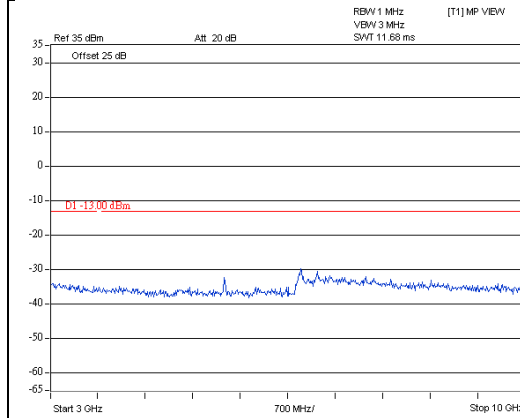

Frequency Range : 10GHz~20GHz

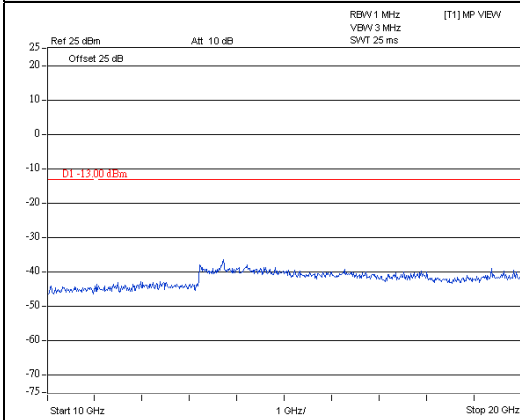

HSUPA

Channel 9400

Frequency Range : 9kHz~3GHz

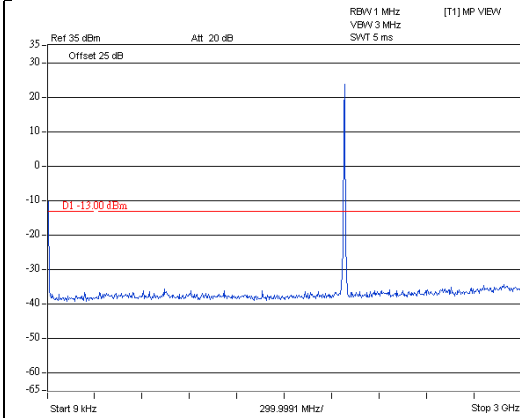

Frequency Range : 3GHz~10GHz

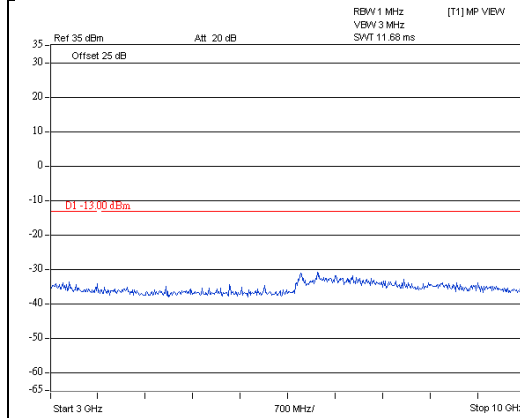

Frequency Range : 10GHz~20GHz

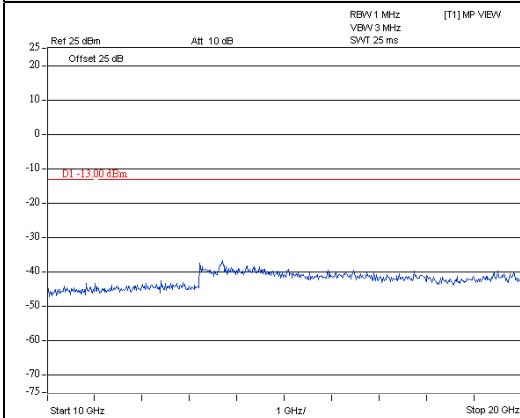

HSUPA

Channel 9538

Frequency Range : 9kHz~3GHz

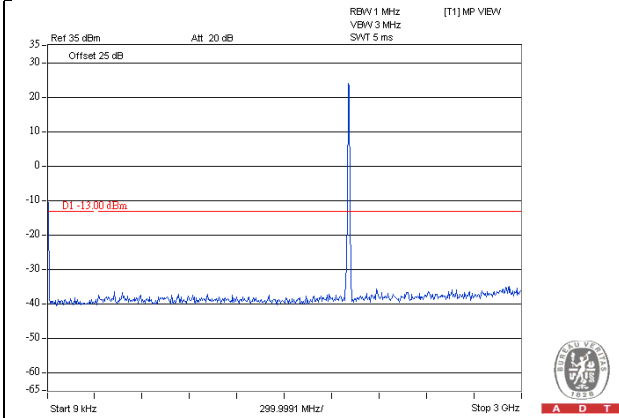

Frequency Range : 3GHz~10GHz

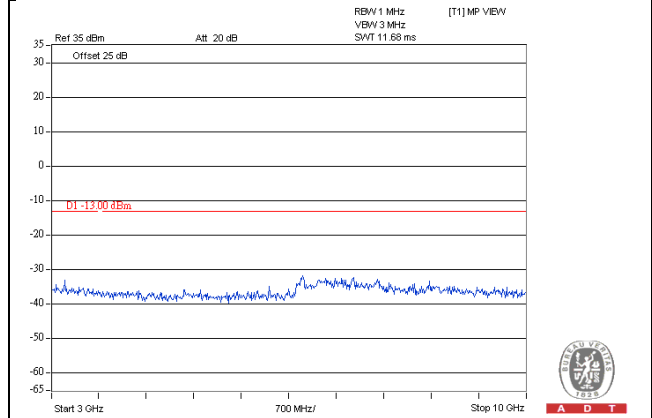

Frequency Range : 10GHz~20GHz

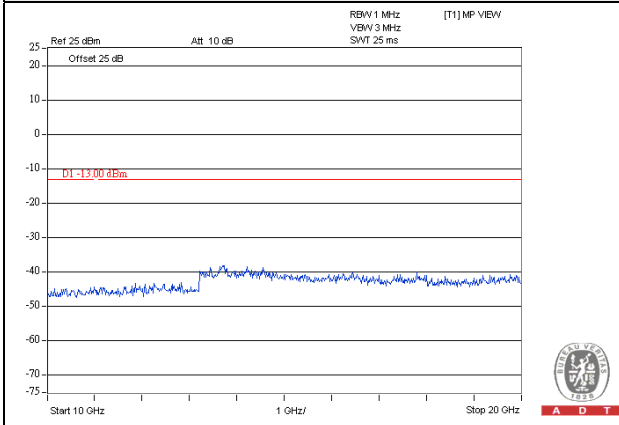

## 4.7 Radiated Emission Measurement

### 4.7.1 Limits of Radiated Emission Measurement

The power of any emission outside of the authorized operating frequency ranges must be attenuated below the transmitting power (P) by a factor of at least  $43 + 10 \log(P)$  dB. The emission limit equal to  $-13\text{dBm}$ .

### 4.7.2 Test Procedure

- a. Substitution method is used for E.I.R.P measurement. In the semi-anechoic chamber, EUT placed on the 0.8m height of Turn Table, rotated the table around 360 degrees to search the maximum radiation power and receiver antenna shall be rotated vertical and horizontal polarization and moved height from 1m to 4m to find the maximum polar radiated power. The "Read Value" is the spectrum reading the maximum power value.
- b. The substitution horn antenna is substituted for EUT at the same position and signals generator export the CW signal to the substitution antenna via a TX cable. Rotated the Turn Table and moved receiving antenna to find the maximum radiation power. Adjust output power level of S.G to get a Value of spectrum reading equal to "Read Value" of step a. Record the power level of S.G
- c.  $\text{EIRP} = \text{Output power level of S.G} - \text{TX cable loss} + \text{Antenna gain of substitution horn}$ .
- d. E.R.P power can be calculated form E.I.R.P power by subtracting the gain of dipole,  $\text{E.R.P power} = \text{E.I.R.P power} - 2.15\text{dBi}$ .

NOTE: The resolution bandwidth and video bandwidth of test receiver/spectrum analyzer is 1MHz/3MHz.

### 4.7.3 Deviation from Test Standard

No deviation.

#### 4.7.4 Test Setup

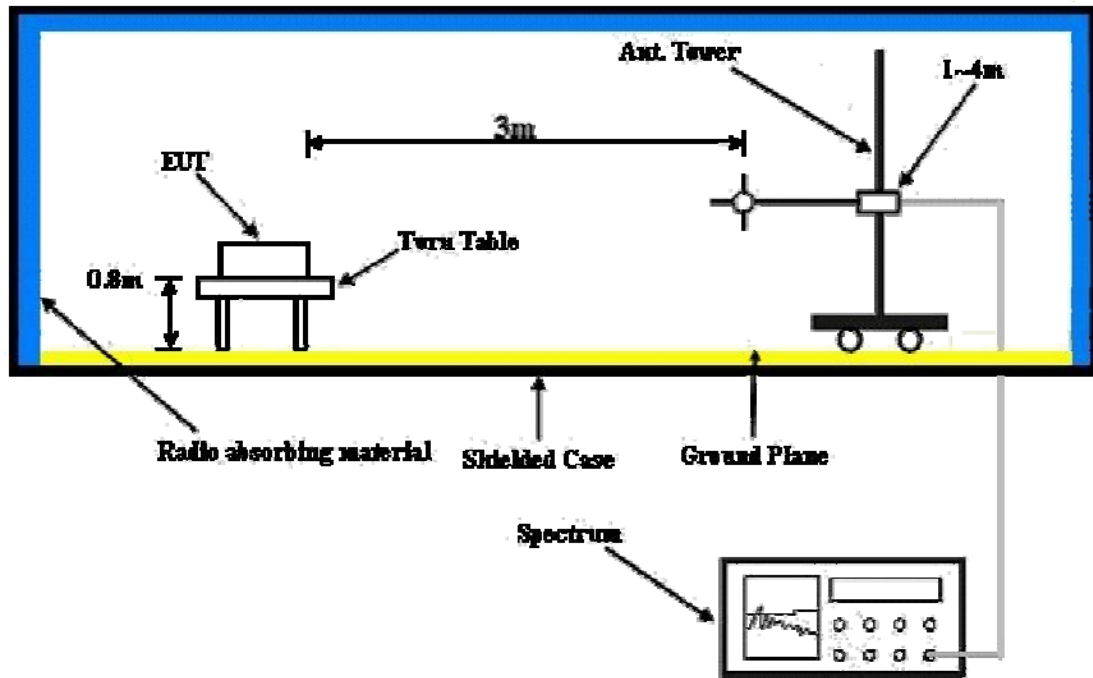

For the actual test configuration, please refer to the attached file (Test Setup Photo).

#### 4.7.5 Test Results

Below 1GHz  
GSM Mode

Mode	TX channel 512	Frequency Range	Below 1000 MHz
Environmental Conditions	25deg. C, 69%RH	Input Power	120Vac, 60Hz
Tested By	Tank Wu	Test Mode	A

Antenna Polarity & Test Distance: Horizontal at 3 M							
No.	Freq. (MHz)	Reading (dBm)	S.G Power Value (dBm)	Correction Factor (dB)	EIRP (dBm)	Limit (dBm)	Margin (dB)
1	33.88	-43.20	-25.40	-17.10	-42.50	-13.00	-29.50
2	62.98	-47.30	-53.00	-2.40	-55.40	-13.00	-42.40
3	86.26	-42.50	-51.50	0.10	-51.40	-13.00	-38.40
4	159.98	-41.80	-46.20	-3.00	-49.20	-13.00	-36.20
5	289.96	-49.90	-53.70	-1.70	-55.40	-13.00	-42.40
6	943.74	-67.20	-64.70	3.70	-61.00	-13.00	-48.00

Antenna Polarity & Test Distance: Vertical at 3 M							
No.	Freq. (MHz)	Reading (dBm)	S.G Power Value (dBm)	Correction Factor (dB)	EIRP (dBm)	Limit (dBm)	Margin (dB)
1	33.88	-31.20	-26.90	-17.10	-44.00	-13.00	-31.00
2	55.22	-34.50	-38.20	-5.40	-43.60	-13.00	-30.60
3	76.56	-44.90	-53.10	0.30	-52.80	-13.00	-39.80
4	144.46	-49.40	-50.50	-3.20	-53.70	-13.00	-40.70
5	289.96	-51.10	-50.40	-1.70	-52.10	-13.00	-39.10
6	945.68	-67.00	-63.70	3.80	-59.90	-13.00	-46.90

Remarks:

1. Output Power (dBm) = S.G Value (dBm) + Correction Factor (dB).
2. Correction Factor (dB) = Substitution Antenna Gain (dB) + Cable Loss (dB).



Mode	TX channel 661	Frequency Range	Below 1000 MHz
Environmental Conditions	25deg. C, 69%RH	Input Power	120Vac, 60Hz
Tested By	Tank Wu	Test Mode	A

Antenna Polarity & Test Distance: Horizontal at 3 M							
No.	Freq. (MHz)	Reading (dBm)	S.G Power Value (dBm)	Correction Factor (dB)	EIRP (dBm)	Limit (dBm)	Margin (dB)
1	30.00	-35.60	-14.40	-19.40	-33.80	-13.00	-20.80
2	88.20	-45.90	-55.40	-0.20	-55.60	-13.00	-42.60
3	158.04	-42.20	-46.50	-2.70	-49.20	-13.00	-36.20
4	187.14	-47.50	-55.20	-2.70	-57.90	-13.00	-44.90
5	289.96	-48.20	-52.00	-1.70	-53.70	-13.00	-40.70
6	949.56	-67.50	-65.10	3.70	-61.40	-13.00	-48.40

Antenna Polarity & Test Distance: Vertical at 3 M							
No.	Freq. (MHz)	Reading (dBm)	S.G Power Value (dBm)	Correction Factor (dB)	EIRP (dBm)	Limit (dBm)	Margin (dB)
1	30.00	-27.20	-19.90	-19.40	-39.30	-13.00	-26.30
2	84.32	-45.60	-53.10	0.40	-52.70	-13.00	-39.70
3	144.46	-49.60	-50.80	-3.20	-54.00	-13.00	-41.00
4	192.96	-51.10	-52.20	-2.60	-54.80	-13.00	-41.80
5	289.96	-51.20	-50.50	-1.70	-52.20	-13.00	-39.20
6	949.56	-67.20	-63.70	3.70	-60.00	-13.00	-47.00

Remarks:

1. Output Power (dBm) = S.G Value (dBm) + Correction Factor (dB).
2. Correction Factor (dB) = Substitution Antenna Gain (dB) + Cable Loss (dB).

Mode	TX channel 810	Frequency Range	Below 1000 MHz
Environmental Conditions	25deg. C, 69%RH	Input Power	120Vac, 60Hz
Tested By	Tank Wu	Test Mode	A

Antenna Polarity & Test Distance: Horizontal at 3 M							
No.	Freq. (MHz)	Reading (dBm)	S.G Power Value (dBm)	Correction Factor (dB)	EIRP (dBm)	Limit (dBm)	Margin (dB)
1	33.88	-41.90	-24.00	-17.10	-41.10	-13.00	-28.10
2	86.26	-43.50	-52.50	0.10	-52.40	-13.00	-39.40
3	161.92	-41.60	-46.40	-2.90	-49.30	-13.00	-36.30
4	289.96	-49.10	-52.90	-1.70	-54.60	-13.00	-41.60
5	357.86	-60.50	-69.60	4.00	-65.60	-13.00	-52.60
6	947.62	-67.00	-64.70	3.80	-60.90	-13.00	-47.90

Antenna Polarity & Test Distance: Vertical at 3 M							
No.	Freq. (MHz)	Reading (dBm)	S.G Power Value (dBm)	Correction Factor (dB)	EIRP (dBm)	Limit (dBm)	Margin (dB)
1	30.00	-28.80	-21.50	-19.40	-40.90	-13.00	-27.90
2	72.68	-44.80	-52.70	-0.10	-52.80	-13.00	-39.80
3	144.46	-50.20	-51.40	-3.20	-54.60	-13.00	-41.60
4	194.90	-53.00	-53.70	-2.60	-56.30	-13.00	-43.30
5	289.96	-51.10	-50.40	-1.70	-52.10	-13.00	-39.10
6	945.68	-67.00	-63.60	3.80	-59.80	-13.00	-46.80

Remarks:

1. Output Power (dBm) = S.G Value (dBm) + Correction Factor (dB).
2. Correction Factor (dB) = Substitution Antenna Gain (dB) + Cable Loss (dB).

Mode	TX channel 512	Frequency Range	Below 1000 MHz
Environmental Conditions	25deg. C, 69%RH	Input Power	120Vac, 60Hz
Tested By	Tank Wu	Test Mode	B

Antenna Polarity & Test Distance: Horizontal at 3 M							
No.	Freq. (MHz)	Reading (dBm)	S.G Power Value (dBm)	Correction Factor (dB)	EIRP (dBm)	Limit (dBm)	Margin (dB)
1	31.94	-44.70	-23.00	-18.30	-41.30	-13.00	-28.30
2	51.34	-60.80	-54.70	-7.30	-62.00	-13.00	-49.00
3	189.08	-52.00	-57.60	-2.80	-60.40	-13.00	-47.40
4	297.72	-60.20	-61.20	-1.70	-62.90	-13.00	-49.90
5	342.34	-61.60	-69.00	3.90	-65.10	-13.00	-52.10
6	967.02	-67.40	-62.60	3.60	-59.00	-13.00	-46.00

Antenna Polarity & Test Distance: Vertical at 3 M							
No.	Freq. (MHz)	Reading (dBm)	S.G Power Value (dBm)	Correction Factor (dB)	EIRP (dBm)	Limit (dBm)	Margin (dB)
1	31.94	-32.10	-24.30	-18.30	-42.60	-13.00	-29.60
2	57.16	-53.70	-55.90	-4.70	-60.60	-13.00	-47.60
3	165.80	-55.10	-55.50	-3.00	-58.50	-13.00	-45.50
4	191.02	-55.90	-55.10	-2.70	-57.80	-13.00	-44.80
5	295.78	-59.30	-57.50	-1.80	-59.30	-13.00	-46.30
6	980.60	-67.90	-62.00	3.50	-58.50	-13.00	-45.50

Remarks:

1. Output Power (dBm) = S.G Value (dBm) + Correction Factor (dB).
2. Correction Factor (dB) = Substitution Antenna Gain (dB) + Cable Loss (dB).

Mode	TX channel 661	Frequency Range	Below 1000 MHz
Environmental Conditions	25deg. C, 69%RH	Input Power	120Vac, 60Hz
Tested By	Tank Wu	Test Mode	B

Antenna Polarity & Test Distance: Horizontal at 3 M							
No.	Freq. (MHz)	Reading (dBm)	S.G Power Value (dBm)	Correction Factor (dB)	EIRP (dBm)	Limit (dBm)	Margin (dB)
1	30.00	-45.60	-22.20	-19.40	-41.60	-13.00	-28.60
2	128.94	-59.90	-62.90	-3.20	-66.10	-13.00	-53.10
3	192.96	-54.20	-60.00	-2.60	-62.60	-13.00	-49.60
4	297.72	-62.10	-63.10	-1.70	-64.80	-13.00	-51.80
5	340.40	-61.30	-68.80	4.00	-64.80	-13.00	-51.80
6	992.24	-67.60	-62.10	3.40	-58.70	-13.00	-45.70

Antenna Polarity & Test Distance: Vertical at 3 M							
No.	Freq. (MHz)	Reading (dBm)	S.G Power Value (dBm)	Correction Factor (dB)	EIRP (dBm)	Limit (dBm)	Margin (dB)
1	31.94	-34.30	-26.50	-18.30	-44.80	-13.00	-31.80
2	55.22	-53.20	-54.70	-5.40	-60.10	-13.00	-47.10
3	128.94	-44.10	-46.30	-3.20	-49.50	-13.00	-36.50
4	191.02	-55.20	-54.40	-2.70	-57.10	-13.00	-44.10
5	288.02	-60.60	-57.30	-1.80	-59.10	-13.00	-46.10
6	976.72	-68.00	-62.20	3.60	-58.60	-13.00	-45.60

Remarks:

1. Output Power (dBm) = S.G Value (dBm) + Correction Factor (dB).
2. Correction Factor (dB) = Substitution Antenna Gain (dB) + Cable Loss (dB).

Mode	TX channel 810	Frequency Range	Below 1000 MHz
Environmental Conditions	25deg. C, 69%RH	Input Power	120Vac, 60Hz
Tested By	Tank Wu	Test Mode	B

Antenna Polarity & Test Distance: Horizontal at 3 M							
No.	Freq. (MHz)	Reading (dBm)	S.G Power Value (dBm)	Correction Factor (dB)	EIRP (dBm)	Limit (dBm)	Margin (dB)
1	31.94	-43.30	-21.60	-18.30	-39.90	-13.00	-26.90
2	53.28	-66.00	-61.50	-6.20	-67.70	-13.00	-54.70
3	128.94	-60.60	-63.60	-3.20	-66.80	-13.00	-53.80
4	189.08	-53.50	-59.10	-2.80	-61.90	-13.00	-48.90
5	297.72	-64.10	-65.10	-1.70	-66.80	-13.00	-53.80
6	831.22	-66.70	-63.70	3.90	-59.80	-13.00	-46.80

Antenna Polarity & Test Distance: Vertical at 3 M							
No.	Freq. (MHz)	Reading (dBm)	S.G Power Value (dBm)	Correction Factor (dB)	EIRP (dBm)	Limit (dBm)	Margin (dB)
1	33.88	-32.70	-26.20	-17.10	-43.30	-13.00	-30.30
2	53.28	-51.40	-52.10	-6.20	-58.30	-13.00	-45.30
3	154.16	-57.60	-57.00	-2.90	-59.90	-13.00	-46.90
4	189.08	-53.50	-52.90	-2.80	-55.70	-13.00	-42.70
5	301.60	-58.90	-62.40	3.70	-58.70	-13.00	-45.70
6	982.54	-67.70	-61.80	3.50	-58.30	-13.00	-45.30

Remarks:

1. Output Power (dBm) = S.G Value (dBm) + Correction Factor (dB).
2. Correction Factor (dB) = Substitution Antenna Gain (dB) + Cable Loss (dB).

WCDMA Mode

Mode	TX channel 9262	Frequency Range	Below 1000 MHz
Environmental Conditions	25deg. C, 69%RH	Input Power	120Vac, 60Hz
Tested By	Tank Wu	Test Mode	A

Antenna Polarity & Test Distance: Horizontal at 3 M							
No.	Freq. (MHz)	Reading (dBm)	S.G Power Value (dBm)	Correction Factor (dB)	EIRP (dBm)	Limit (dBm)	Margin (dB)
1	30.00	-42.10	-20.90	-19.40	-40.30	-13.00	-27.30
2	86.26	-50.50	-59.60	0.10	-59.50	-13.00	-46.50
3	161.92	-50.40	-55.10	-2.90	-58.00	-13.00	-45.00
4	191.02	-50.00	-57.90	-2.70	-60.60	-13.00	-47.60
5	293.84	-52.60	-56.20	-1.80	-58.00	-13.00	-45.00
6	980.60	-61.80	-58.60	3.50	-55.10	-13.00	-42.10

Antenna Polarity & Test Distance: Vertical at 3 M							
No.	Freq. (MHz)	Reading (dBm)	S.G Power Value (dBm)	Correction Factor (dB)	EIRP (dBm)	Limit (dBm)	Margin (dB)
1	31.94	-34.10	-28.40	-18.30	-46.70	-13.00	-33.70
2	55.22	-38.70	-42.30	-5.40	-47.70	-13.00	-34.70
3	163.86	-54.00	-56.30	-2.90	-59.20	-13.00	-46.20
4	191.02	-56.20	-57.60	-2.70	-60.30	-13.00	-47.30
5	278.32	-58.60	-55.90	-1.60	-57.50	-13.00	-44.50
6	990.30	-62.00	-57.80	3.40	-54.40	-13.00	-41.40

Remarks:

1. Output Power (dBm) = S.G Value (dBm) + Correction Factor (dB).
2. Correction Factor (dB) = Substitution Antenna Gain (dB) + Cable Loss (dB).

Mode	TX channel 9400	Frequency Range	Below 1000 MHz
Environmental Conditions	25deg. C, 69%RH	Input Power	120Vac, 60Hz
Tested By	Tank Wu	Test Mode	A

Antenna Polarity & Test Distance: Horizontal at 3 M							
No.	Freq. (MHz)	Reading (dBm)	S.G Power Value (dBm)	Correction Factor (dB)	EIRP (dBm)	Limit (dBm)	Margin (dB)
1	30.00	-42.10	-20.80	-19.40	-40.20	-13.00	-27.20
2	86.26	-52.80	-61.80	0.10	-61.70	-13.00	-48.70
3	161.92	-50.50	-55.20	-2.90	-58.10	-13.00	-45.10
4	191.02	-50.80	-58.60	-2.70	-61.30	-13.00	-48.30
5	293.84	-52.40	-55.90	-1.80	-57.70	-13.00	-44.70
6	974.78	-62.40	-59.20	3.60	-55.60	-13.00	-42.60

Antenna Polarity & Test Distance: Vertical at 3 M							
No.	Freq. (MHz)	Reading (dBm)	S.G Power Value (dBm)	Correction Factor (dB)	EIRP (dBm)	Limit (dBm)	Margin (dB)
1	31.94	-31.00	-25.30	-18.30	-43.60	-13.00	-30.60
2	84.32	-51.00	-58.50	0.40	-58.10	-13.00	-45.10
3	159.98	-54.50	-56.60	-3.00	-59.60	-13.00	-46.60
4	191.02	-57.20	-58.50	-2.70	-61.20	-13.00	-48.20
5	280.26	-59.90	-57.30	-1.60	-58.90	-13.00	-45.90
6	957.32	-61.40	-58.10	3.80	-54.30	-13.00	-41.30

Remarks:

1. Output Power (dBm) = S.G Value (dBm) + Correction Factor (dB).
2. Correction Factor (dB) = Substitution Antenna Gain (dB) + Cable Loss (dB).

Mode	TX channel 9538	Frequency Range	Below 1000 MHz
Environmental Conditions	25deg. C, 69%RH	Input Power	120Vac, 60Hz
Tested By	Tank Wu	Test Mode	A

Antenna Polarity & Test Distance: Horizontal at 3 M							
No.	Freq. (MHz)	Reading (dBm)	S.G Power Value (dBm)	Correction Factor (dB)	EIRP (dBm)	Limit (dBm)	Margin (dB)
1	31.94	-40.20	-20.70	-18.30	-39.00	-13.00	-26.00
2	86.26	-50.20	-59.30	0.10	-59.20	-13.00	-46.20
3	161.92	-49.00	-53.70	-2.90	-56.60	-13.00	-43.60
4	191.02	-50.00	-57.80	-2.70	-60.50	-13.00	-47.50
5	288.02	-51.20	-55.20	-1.80	-57.00	-13.00	-44.00
6	988.36	-61.50	-58.30	3.40	-54.90	-13.00	-41.90

Antenna Polarity & Test Distance: Vertical at 3 M							
No.	Freq. (MHz)	Reading (dBm)	S.G Power Value (dBm)	Correction Factor (dB)	EIRP (dBm)	Limit (dBm)	Margin (dB)
1	33.88	-35.80	-31.40	-17.10	-48.50	-13.00	-35.50
2	82.38	-54.20	-61.30	0.40	-60.90	-13.00	-47.90
3	159.98	-56.60	-58.70	-3.00	-61.70	-13.00	-48.70
4	189.08	-56.50	-58.10	-2.80	-60.90	-13.00	-47.90
5	286.08	-59.40	-57.80	-1.70	-59.50	-13.00	-46.50
6	939.86	-61.80	-58.60	3.70	-54.90	-13.00	-41.90

Remarks:

1. Output Power (dBm) = S.G Value (dBm) + Correction Factor (dB).
2. Correction Factor (dB) = Substitution Antenna Gain (dB) + Cable Loss (dB).



Mode	TX channel 9262	Frequency Range	Below 1000 MHz
Environmental Conditions	25deg. C, 69%RH	Input Power	120Vac, 60Hz
Tested By	Tank Wu	Test Mode	B

Antenna Polarity & Test Distance: Horizontal at 3 M							
No.	Freq. (MHz)	Reading (dBm)	S.G Power Value (dBm)	Correction Factor (dB)	EIRP (dBm)	Limit (dBm)	Margin (dB)
1	31.94	-48.40	-26.70	-18.30	-45.00	-13.00	-32.00
2	68.80	-43.50	-49.30	-0.80	-50.10	-13.00	-37.10
3	138.64	-53.40	-56.20	-3.20	-59.40	-13.00	-46.40
4	200.72	-52.10	-58.10	-2.30	-60.40	-13.00	-47.40
5	328.76	-54.90	-62.80	4.10	-58.70	-13.00	-45.70
6	992.24	-68.30	-62.80	3.40	-59.40	-13.00	-46.40

Antenna Polarity & Test Distance: Vertical at 3 M							
No.	Freq. (MHz)	Reading (dBm)	S.G Power Value (dBm)	Correction Factor (dB)	EIRP (dBm)	Limit (dBm)	Margin (dB)
1	30.00	-39.30	-29.80	-19.40	-49.20	-13.00	-36.20
2	53.28	-41.90	-42.60	-6.20	-48.80	-13.00	-35.80
3	144.46	-47.60	-46.60	-3.20	-49.80	-13.00	-36.80
4	198.78	-54.10	-52.70	-2.40	-55.10	-13.00	-42.10
5	258.92	-57.30	-55.10	-1.50	-56.60	-13.00	-43.60
6	992.24	-68.30	-61.80	3.40	-58.40	-13.00	-45.40

Remarks:

1. Output Power (dBm) = S.G Value (dBm) + Correction Factor (dB).
2. Correction Factor (dB) = Substitution Antenna Gain (dB) + Cable Loss (dB).

Mode	TX channel 9400	Frequency Range	Below 1000 MHz
Environmental Conditions	25deg. C, 69%RH	Input Power	120Vac, 60Hz
Tested By	Tank Wu	Test Mode	B

Antenna Polarity & Test Distance: Horizontal at 3 M							
No.	Freq. (MHz)	Reading (dBm)	S.G Power Value (dBm)	Correction Factor (dB)	EIRP (dBm)	Limit (dBm)	Margin (dB)
1	30.00	-45.90	-22.50	-19.40	-41.90	-13.00	-28.90
2	68.80	-42.40	-48.20	-0.80	-49.00	-13.00	-36.00
3	150.28	-53.40	-55.10	-3.00	-58.10	-13.00	-45.10
4	202.66	-50.90	-56.80	-2.10	-58.90	-13.00	-45.90
5	340.40	-55.50	-63.00	4.00	-59.00	-13.00	-46.00
6	978.66	-69.00	-63.70	3.50	-60.20	-13.00	-47.20

Antenna Polarity & Test Distance: Vertical at 3 M							
No.	Freq. (MHz)	Reading (dBm)	S.G Power Value (dBm)	Correction Factor (dB)	EIRP (dBm)	Limit (dBm)	Margin (dB)
1	33.88	-35.20	-28.70	-17.10	-45.80	-13.00	-32.80
2	53.28	-42.10	-42.80	-6.20	-49.00	-13.00	-36.00
3	142.52	-47.80	-46.90	-3.10	-50.00	-13.00	-37.00
4	198.78	-55.30	-53.90	-2.40	-56.30	-13.00	-43.30
5	260.86	-58.90	-56.40	-1.50	-57.90	-13.00	-44.90
6	943.74	-67.10	-61.70	3.70	-58.00	-13.00	-45.00

Remarks:

1. Output Power (dBm) = S.G Value (dBm) + Correction Factor (dB).
2. Correction Factor (dB) = Substitution Antenna Gain (dB) + Cable Loss (dB).

Mode	TX channel 9538	Frequency Range	Below 1000 MHz
Environmental Conditions	25deg. C, 69%RH	Input Power	120Vac, 60Hz
Tested By	Tank Wu	Test Mode	B

Antenna Polarity & Test Distance: Horizontal at 3 M							
No.	Freq. (MHz)	Reading (dBm)	S.G Power Value (dBm)	Correction Factor (dB)	EIRP (dBm)	Limit (dBm)	Margin (dB)
1	30.00	-43.40	-20.00	-19.40	-39.40	-13.00	-26.40
2	68.80	-44.40	-50.20	-0.80	-51.00	-13.00	-38.00
3	150.28	-54.80	-56.50	-3.00	-59.50	-13.00	-46.50
4	198.78	-51.40	-57.40	-2.40	-59.80	-13.00	-46.80
5	342.34	-55.10	-62.50	3.90	-58.60	-13.00	-45.60
6	943.74	-67.70	-63.10	3.70	-59.40	-13.00	-46.40

Antenna Polarity & Test Distance: Vertical at 3 M							
No.	Freq. (MHz)	Reading (dBm)	S.G Power Value (dBm)	Correction Factor (dB)	EIRP (dBm)	Limit (dBm)	Margin (dB)
1	30.00	-30.80	-21.30	-19.40	-40.70	-13.00	-27.70
2	51.34	-43.70	-43.60	-7.30	-50.90	-13.00	-37.90
3	142.52	-48.60	-47.70	-3.10	-50.80	-13.00	-37.80
4	198.78	-55.00	-53.60	-2.40	-56.00	-13.00	-43.00
5	258.92	-57.50	-55.30	-1.50	-56.80	-13.00	-43.80
6	943.74	-67.20	-61.80	3.70	-58.10	-13.00	-45.10

Remarks:

1. Output Power (dBm) = S.G Value (dBm) + Correction Factor (dB).
2. Correction Factor (dB) = Substitution Antenna Gain (dB) + Cable Loss (dB).

Above 1GHz  
GSM Mode

Mode	TX channel 512	Frequency Range	Above 1000MHz
Environmental Conditions	25deg. C, 69%RH	Input Power	120Vac, 60Hz
Tested By	Tank Wu		

Antenna Polarity & Test Distance: Horizontal at 3 M							
No.	Freq. (MHz)	Reading (dBm)	S.G Power Value (dBm)	Correction Factor (dB)	EIRP (dBm)	Limit (dBm)	Margin (dB)
1	3700.40	-53.10	-46.80	1.40	-45.40	-13.00	-32.40
2	5550.60	-48.10	-37.50	1.40	-36.10	-13.00	-23.10
Antenna Polarity & Test Distance: Vertical at 3 M							
No.	Freq. (MHz)	Reading (dBm)	S.G Power Value (dBm)	Correction Factor (dB)	EIRP (dBm)	Limit (dBm)	Margin (dB)
1	3700.40	-52.80	-46.70	1.40	-45.30	-13.00	-32.30
2	5550.60	-51.50	-41.60	1.40	-40.20	-13.00	-27.20

Remarks:

1. Output Power (dBm) = S.G Value (dBm) + Correction Factor (dB).
2. Correction Factor (dB) = Substitution Antenna Gain (dB) + Cable Loss (dB).

Mode	TX channel 661	Frequency Range	Above 1000MHz
Environmental Conditions	25deg. C, 69%RH	Input Power	120Vac, 60Hz
Tested By	Tank Wu		

Antenna Polarity & Test Distance: Horizontal at 3 M							
No.	Freq. (MHz)	Reading (dBm)	S.G Power Value (dBm)	Correction Factor (dB)	EIRP (dBm)	Limit (dBm)	Margin (dB)
1	3760.00	-53.00	-46.70	1.30	-45.40	-13.00	-32.40
2	5640.00	-50.60	-39.80	1.30	-38.50	-13.00	-25.50
Antenna Polarity & Test Distance: Vertical at 3 M							
No.	Freq. (MHz)	Reading (dBm)	S.G Power Value (dBm)	Correction Factor (dB)	EIRP (dBm)	Limit (dBm)	Margin (dB)
1	3760.00	-51.20	-45.10	1.30	-43.80	-13.00	-30.80
2	5640.00	-51.80	-42.10	1.30	-40.80	-13.00	-27.80

Remarks:

1. Output Power (dBm) = S.G Value (dBm) + Correction Factor (dB).
2. Correction Factor (dB) = Substitution Antenna Gain (dB) + Cable Loss (dB).

Mode	TX channel 810	Frequency Range	Above 1000MHz
Environmental Conditions	25deg. C, 69%RH	Input Power	120Vac, 60Hz
Tested By	Tank Wu		

Antenna Polarity & Test Distance: Horizontal at 3 M							
No.	Freq. (MHz)	Reading (dBm)	S.G Power Value (dBm)	Correction Factor (dB)	EIRP (dBm)	Limit (dBm)	Margin (dB)
1	3819.60	-52.90	-46.80	1.40	-45.40	-13.00	-32.40
2	5729.40	-53.00	-42.10	1.20	-40.90	-13.00	-27.90
Antenna Polarity & Test Distance: Vertical at 3 M							
No.	Freq. (MHz)	Reading (dBm)	S.G Power Value (dBm)	Correction Factor (dB)	EIRP (dBm)	Limit (dBm)	Margin (dB)
1	3819.60	-51.70	-45.60	1.40	-44.20	-13.00	-31.20
2	5729.40	-55.50	-45.40	1.20	-44.20	-13.00	-31.20

Remarks:

1. Output Power (dBm) = S.G Value (dBm) + Correction Factor (dB).
2. Correction Factor (dB) = Substitution Antenna Gain (dB) + Cable Loss (dB).

WCDMA Mode

Mode	TX channel 9262	Frequency Range	Above 1000MHz
Environmental Conditions	25deg. C, 69%RH	Input Power	120Vac, 60Hz
Tested By	Tank Wu		

Antenna Polarity & Test Distance: Horizontal at 3 M							
No.	Freq. (MHz)	Reading (dBm)	S.G Power Value (dBm)	Correction Factor (dB)	EIRP (dBm)	Limit (dBm)	Margin (dB)
1	3704.80	-55.10	-46.60	1.40	-45.20	-13.00	-32.20
2	5557.20	-44.70	-31.80	1.30	-30.50	-13.00	-17.50

Antenna Polarity & Test Distance: Vertical at 3 M							
No.	Freq. (MHz)	Reading (dBm)	S.G Power Value (dBm)	Correction Factor (dB)	EIRP (dBm)	Limit (dBm)	Margin (dB)
1	3704.80	-55.80	-47.60	1.40	-46.20	-13.00	-33.20
<b>2</b>	<b>5557.20</b>	<b>-42.30</b>	<b>-30.20</b>	<b>1.30</b>	<b>-28.90</b>	<b>-13.00</b>	<b>-15.90</b>

Remarks:

1. Output Power (dBm) = S.G Value (dBm) + Correction Factor (dB).
2. Correction Factor (dB) = Substitution Antenna Gain (dB) + Cable Loss (dB).

Mode	TX channel 9400	Frequency Range	Above 1000MHz
Environmental Conditions	25deg. C, 69%RH	Input Power	120Vac, 60Hz
Tested By	Tank Wu		

Antenna Polarity & Test Distance: Horizontal at 3 M							
No.	Freq. (MHz)	Reading (dBm)	S.G Power Value (dBm)	Correction Factor (dB)	EIRP (dBm)	Limit (dBm)	Margin (dB)
1	3760.00	-56.60	-48.10	1.30	-46.80	-13.00	-33.80
2	5640.00	-47.90	-34.90	1.30	-33.60	-13.00	-20.60

Antenna Polarity & Test Distance: Vertical at 3 M							
No.	Freq. (MHz)	Reading (dBm)	S.G Power Value (dBm)	Correction Factor (dB)	EIRP (dBm)	Limit (dBm)	Margin (dB)
1	3760.00	-56.50	-48.20	1.30	-46.90	-13.00	-33.90
2	5640.00	-45.40	-33.50	1.30	-32.20	-13.00	-19.20

Remarks:

1. Output Power (dBm) = S.G Value (dBm) + Correction Factor (dB).
2. Correction Factor (dB) = Substitution Antenna Gain (dB) + Cable Loss (dB).

Mode	TX channel 9538	Frequency Range	Above 1000MHz
Environmental Conditions	25deg. C, 69%RH	Input Power	120Vac, 60Hz
Tested By	Tank Wu		

Antenna Polarity & Test Distance: Horizontal at 3 M							
No.	Freq. (MHz)	Reading (dBm)	S.G Power Value (dBm)	Correction Factor (dB)	EIRP (dBm)	Limit (dBm)	Margin (dB)
1	3815.20	-56.80	-48.50	1.40	-47.10	-13.00	-34.10
2	5722.80	-49.20	-36.10	1.20	-34.90	-13.00	-21.90

Antenna Polarity & Test Distance: Vertical at 3 M							
No.	Freq. (MHz)	Reading (dBm)	S.G Power Value (dBm)	Correction Factor (dB)	EIRP (dBm)	Limit (dBm)	Margin (dB)
1	3815.20	-57.50	-49.30	1.40	-47.90	-13.00	-34.90
2	5722.80	-45.10	-33.00	1.20	-31.80	-13.00	-18.80

Remarks:

1. Output Power (dBm) = S.G Value (dBm) + Correction Factor (dB).
2. Correction Factor (dB) = Substitution Antenna Gain (dB) + Cable Loss (dB).

## 5 Pictures of Test Arrangements

Please refer to the attached file (Test Setup Photo).



## Appendix – Information on the Testing Laboratories

We, Bureau Veritas Consumer Products Services (H.K.) Ltd., Taoyuan Branch, were founded in 1988 to provide our best service in EMC, Radio, Telecom and Safety consultation. Our laboratories are accredited and approved according to ISO/IEC 17025.

If you have any comments, please feel free to contact us at the following:

**Linko EMC/RF Lab**

Tel: 886-2-26052180

Fax: 886-2-26051924

**Hsin Chu EMC/RF/Telecom Lab**

Tel: 886-3-6668565

Fax: 886-3-6668323

**Hwa Ya EMC/RF/Safety Lab**

Tel: 886-3-3183232

Fax: 886-3-3270892

**Email:** [service.adt@tw.bureauveritas.com](mailto:service.adt@tw.bureauveritas.com)

**Web Site:** [www.bureauveritas-adt.com](http://www.bureauveritas-adt.com)

The address and road map of all our labs can be found in our web site also.

--- END ---