



FCC 47 CFR PART 15 SUBPART E

TEST REPORT

For

Mobile Computer

Model: CP60G

Trade Name: CIPHERLAB

Issued to

Cipherlab Co., Ltd.

12F, 333 Dunhua S. Rd., Sec.2, Taipei, Taiwan R.O.C.

Issued by

Compliance Certification Services Inc.

No.11, Wu-Gong 6th Rd., Wugu Dist.,

New Taipei City 24891, Taiwan (R.O.C.)

<http://www.ccsrf.com>

service@ccsrf.com

Issued Date: April 2, 2013



Note: This report shall not be reproduced except in full, without the written approval of Compliance Certification Services Inc. This document may be altered or revised by Compliance Certification Services Inc. personnel only, and shall be noted in the revision section of the document.



Revision History

Rev.	Issue Date	Revisions	Effect Page	Revised By
00	April 2, 2013	Initial Issue	ALL	Rachel Wu



TABLE OF CONTENTS

1. TEST RESULT CERTIFICATION.....	4
2. EUT DESCRIPTION	5
3. TEST METHODOLOGY	7
3.1 EUT CONFIGURATION	7
3.2 EUT EXERCISE	7
3.3 GENERAL TEST PROCEDURES	7
3.4 FCC PART 15.205 RESTRICTED BANDS OF OPERATIONS	8
3.5 DESCRIPTION OF TEST MODES	9
4. INSTRUMENT CALIBRATION.....	10
4.1 MEASURING INSTRUMENT CALIBRATION	10
4.2 MEASUREMENT EQUIPMENT USED	10
4.3 MEASUREMENT UNCERTAINTY	11
5. FACILITIES AND ACCREDITATIONS	12
5.1 FACILITIES	12
5.2 EQUIPMENT	12
5.3 TABLE OF ACCREDITATIONS AND LISTINGS	13
6. SETUP OF EQUIPMENT UNDER TEST	14
6.1 SETUP CONFIGURATION OF EUT	14
6.2 SUPPORT EQUIPMENT	14
7. FCC PART 15 REQUIREMENTS.....	15
7.1 26 DB EMISSION BANDWIDTH	15
7.2 MAXIMUM CONDUCTED OUTPUT POWER	26
7.3 BAND EDGES MEASUREMENT	39
7.4 PEAK POWER SPECTRAL DENSITY	48
7.5 PEAK EXCURSION	59
7.6 RADIATED UNDESIRABLE EMISSION.....	70
7.7 CONDUCTED UNDESIRABLE EMISSION	93
7.8 POWERLINE CONDUCTED EMISSIONS	103
7.9 FREQUENCY STABILITY.....	106
7.10 DYNAMIC FREQUENCY SELECTION.....	119
APPENDIX I RADIO FREQUENCY EXPOSURE	144
APPENDIX II PHOTOGRAPHS OF TEST SETUP.....	145



1. TEST RESULT CERTIFICATION

Applicant: Cipherlab Co., Ltd.
12F, 333 Dunhua S. Rd., Sec.2, Taipei, Taiwan R.O.C.

Equipment Under Test: Mobile Computer

Trade Name: CIPHERLAB

Model: CP60G

Date of Test: October 16 ~ November 24, 2012

APPLICABLE STANDARDS	
STANDARD	TEST RESULT
FCC 47 CFR Part 15 Subpart E	No non-compliance noted

We hereby certify that:

Compliance Certification Services Inc. tested the above equipment. The test data, data evaluation, test procedures, and equipment configurations shown in this report were made in accordance with the procedures given in ANSI C63.4: 2003 and the energy emitted by the sample EUT tested as described in this report is in compliance with conducted and radiated emission limits of FCC Rules Part 15.407.

The test results of this report relate only to the tested sample identified in this report.

Approved by:

Miller Lee
Section Manager
Compliance Certification Services Inc.

Reviewed by:

Gina Lo
Section Manager
Compliance Certification Services Inc.



2. EUT DESCRIPTION

Product	Mobile Computer			
Trade Name	CIPHERLAB			
Model Number	CP60G			
Model Discrepancy	N/A			
Received Date	March 21, 2013			
Power Supply	<p>1. Vdc from Power Adapter Brand: Adapter Technology Co., LTD., Model: STD-05040T I/P: 100-240V, 47-63Hz, 0.58A MAX O/P: 5V, 4A, 20W MAX</p> <p>2. Vdc from Battery a). Model: BA-0064A4 Rating: 3.7V, 4400mAh, 16.28Wh b) Model: BA-0063A6 Rating: 3.7V, 3600mAh, 13.32Wh</p>			
Operating Frequency Range & Number of Channels		Mode	Frequency Range (MHz)	Number of Channels
	UNII Band I	IEEE 802.11a	5180 – 5240	4 Channels
		IEEE 802.11n HT 20 MHz mode	5180 – 5240	4 Channels
	UNII Band II	IEEE 802.11a	5260 - 5320	4 Channels
		IEEE 802.11n HT 20 MHz mode	5260 - 5320	4 Channels
	UNII Band III	IEEE 802.11a	5500 - 5700	8 Channels
IEEE 802.11n HT 20 MHz mode		5500 – 5700	8 Channels	
Transmit Power	IEEE 802.11a mode / 5180 ~ 5240MHz: 12.05 dBm IEEE 802.11n HT 20 MHz mode / 5180 ~ 5240MHz: 11.05dBm IEEE 802.11a mode / 5260 ~ 5320MHz: 11.97 dBm IEEE 802.11n HT 20 MHz mode / 5260 ~ 5320MHz: 11.04 dBm IEEE 802.11a mode / 5500 ~ 5700MHz: 8.67 dBm IEEE 802.11n HT 20 MHz mode / 5500 ~ 5700MHz: 7.98dBm			
Modulation Technique	OFDM (QPSK, BPSK, 16-QAM, 64-QAM)			
Transmit Data Rate	802.11n: Up to MCS7 802.11a: 54, 48, 36, 24, 18, 12, 9, 6 Mbps			
Antenna Specification	Gain: 1.72 dBi			
Antenna Designation	mono pole antenna			



Operation Frequency:

UNLICENSED NATIONAL INFORMATION INFRASTRUCTURE (U-NII)	
CHANNEL	MHz
36	5180
38	5190
40	5200
44	5220
46	5230
48	5240
52	5260
54	5270
56	5280
60	5300
62	5310
64	5320
100	5500
102	5510
104	5520
108	5540
110	5550
112	5560
116	5580
132	5660
134	5670
136	5680
140	5700

Remark:

1. The sample selected for test was engineering sample that approximated to production product and was provided by manufacturer.
2. This submittal(s) (test report) is intended for FCC ID: Q3N-CP60G filing to comply with Section 15.407 of the FCC Part 15, Subpart E Rules.



3. TEST METHODOLOGY

Both conducted and radiated testing was performed according to the procedures in ANSI C63.4. Radiated testing was performed at an antenna to EUT distance 3 meters.

The tests documented in this report were performed in accordance with ANSI C63.4 and KDB789033.

3.1 EUT CONFIGURATION

The EUT configuration for testing is installed for RF field strength measurement to meet the Commissions requirement, and is operated in a manner intended to generate the maximum emission in a continuous normal application.

3.2 EUT EXERCISE

The EUT is operated in the engineering mode to fix the Tx frequency for the purposes of measurement.

According to its specifications, the EUT must comply with the requirements of Section 15.407 under the FCC Rules Part 15 Subpart E.

3.3 GENERAL TEST PROCEDURES

Conducted Emissions

The EUT is placed on the turntable, which is positioned at 0.8 m above the ground plane. According to the requirements in Section 13.1.4.1 of ANSI C63.4, the conducted emission from the EUT is measured in the frequency range between 0.15 MHz and 30MHz, using the CISPR Quasi-Peak detector mode.

Radiated Emissions

The EUT is placed on the turntable, which is 0.8 m above the ground plane. The turntable is then rotated for 360 degrees to determine the proper orientation for the maximum emission level. The EUT is set 3m away from the receiving antenna, which is varied from 1m to 4m to find out the highest emission level. And, each emission is to be maximized by changing the horizontal and vertical polarization of the receiving antenna. In order to find out the maximum emissions, exploratory radiated emission measurements were made according to the requirements in Section 13.1.4.1 of ANSI C63.4.



3.4 FCC PART 15.205 RESTRICTED BANDS OF OPERATIONS

(a) Except as shown in paragraph (d) of this section, only spurious emissions are permitted in any of the frequency bands listed below:

MHz	MHz	MHz	GHz
0.090 - 0.110	16.42 - 16.423	399.9 - 410	4.5 - 5.15
¹ 0.495 - 0.505	16.69475 - 16.69525	608 - 614	5.35 - 5.46
2.1735 - 2.1905	16.80425 - 16.80475	960 - 1240	7.25 - 7.75
4.125 - 4.128	25.5 - 25.67	1300 - 1427	8.025 - 8.5
4.17725 - 4.17775	37.5 - 38.25	1435 - 1626.5	9.0 - 9.2
4.20725 - 4.20775	73 - 74.6	1645.5 - 1646.5	9.3 - 9.5
6.215 - 6.218	74.8 - 75.2	1660 - 1710	10.6 - 12.7
6.26775 - 6.26825	108 - 121.94	1718.8 - 1722.2	13.25 - 13.4
6.31175 - 6.31225	123 - 138	2200 - 2300	14.47 - 14.5
8.291 - 8.294	149.9 - 150.05	2310 - 2390	15.35 - 16.2
8.362 - 8.366	156.52475 -	2483.5 - 2500	17.7 - 21.4
8.37625 - 8.38675	156.52525	2655 - 2900	22.01 - 23.12
8.41425 - 8.41475	156.7 - 156.9	3260 - 3267	23.6 - 24.0
12.29 - 12.293	162.0125 - 167.17	3332 - 3339	31.2 - 31.8
12.51975 - 12.52025	167.72 - 173.2	3345.8 - 3358	36.43 - 36.5
12.57675 - 12.57725	240 - 285	3600 - 4400	(²)
13.36 - 13.41	322 - 335.4		

¹ Until February 1, 1999, this restricted band shall be 0.490-0.510 MHz.

² Above 38.6

(b) Except as provided in paragraphs (d) and (e), the field strength of emissions appearing within these frequency bands shall not exceed the limits shown in Section 15.209. At frequencies equal to or less than 1000 MHz, compliance with the limits in Section 15.209 shall be demonstrated using measurement instrumentation employing a CISPR quasi-peak detector. Above 1000 MHz, compliance with the emission limits in Section 15.209 shall be demonstrated based on the average value of the measured emissions. The provisions in Section 15.35 apply to these measurements.



3.5 DESCRIPTION OF TEST MODES

The EUT (model: CP60G) had been tested under operating condition.

Software used to control the EUT for staying in continuous transmitting mode was programmed.

The field strength of spurious emission was measured in the following position: EUT stand-up position (Z axis), lie-down position (X, Y axis). The worst emission was found in stand-up position (Z axis) and the worst case was recorded.

After verification, all tests were carried out with the worst case test modes as shown below except radiated spurious emission below 1GHz, which worst case was in normal link mode only.

IEEE 802.11a mode / 5180 ~ 5240MHz:

Channel Low (5180MHz), Channel Mid (5220MHz) and Channel High (5240MHz) with 6Mbps data rate were chosen for full testing.

IEEE 802.11n HT 20 MHz mode / 5180 ~ 5240MHz:

Channel Low (5180MHz), Channel Mid (5220MHz) and Channel High (5240MHz) with 6.5Mbps data rate were chosen for full testing.

IEEE 802.11a mode / 5260 ~ 5320MHz:

Channel Low (5260MHz), Channel Mid (5280MHz) and Channel High (5320MHz) with 6Mbps data rate were chosen for full testing.

IEEE 802.11n HT 20 MHz mode / 5260 ~ 5320MHz:

Channel Low (5260MHz), Channel Mid (5280MHz) and Channel High (5320MHz) with 6.5Mbps data rate were chosen for full testing.

IEEE 802.11a mode / 5500 ~ 5700MHz:

Channel Low (5500MHz), Channel Mid (5580MHz) and Channel High (5700MHz) with 6Mbps data rate were chosen for full testing.

IEEE 802.11n HT 20 MHz mode / 5500 ~ 5700MHz:

Channel Low (5500MHz), Channel Mid (5580MHz) and Channel High (5700MHz) with 6.5Mbps data rate were chosen for full testing.



4. INSTRUMENT CALIBRATION

4.1 MEASURING INSTRUMENT CALIBRATION

The measuring equipment, which was utilized in performing the tests documented herein, has been calibrated in accordance with the manufacturer's recommendations for utilizing calibration equipment, which is traceable to recognized national standards.

4.2 MEASUREMENT EQUIPMENT USED

Equipment Used for Emissions Measurement

Remark: Each piece of equipment is scheduled for calibration once a year and Loop Antenna is scheduled for calibration once three years.

Conducted Emissions Test Site				
Name of Equipment	Manufacturer	Model	Serial Number	Calibration Due
Spectrum Analyzer	Agilent	E4446A	MY43360131	03/15/2014
Power Meter	Anritsu	ML2495A	1012009	04/26/2013
Power Sensor	Anritsu	MA2411B	0917072	04/26/2013

Wugu 966 Chamber A				
Name of Equipment	Manufacturer	Model	Serial Number	Calibration Due
Spectrum Analyzer	Agilent	E4446A	US42510252	11/01/2013
EMI Test Receiver	R&S	ESCI	100064	02/15/2014
Pre-Amplifier	Mini-Circuits	ZFL-1000LN	SF350700823	01/11/2014
Pre-Amplifier	MITEQ	AFS44-00102650-42-10P-44	1415367	11/17/2014
Bilog Antenna	Sunol Sciences	JB3	A030105	10/02/2013
Horn Antenna	EMCO	3117	00055165	01/10/2014
Horn Antenna	EMCO	3116	00026370	10/11/2013
Loop Antenna	EMCO	6502	8905/2356	06/10/2013
Turn Table	CCS	CC-T-1F	N/A	N.C.R
Antenna Tower	CCS	CC-A-1F	N/A	N.C.R
Controller	CCS	CC-C-1F	N/A	N.C.R
Site NSA	CCS	N/A	N/A	12/24/2013
Test S/W	EZ-EMC (CCS-3A1RE)			

Conducted Emission room # B				
Name of Equipment	Manufacturer	Model	Serial Number	Calibration Due
EMI Test Receiver	R&S	ESCI	101073	07/31/2013
LISN	R&S	ENV216	101054	06/06/2013
LISN	EMCO	3825/2	9106-1809	07/03/2013
ISN	FCC	FCC-TLISN-T2-02-09	100105	07/30/2013
ISN	FCC	FCC-TLISN-T4-02-09	20395	05/24/2013
ISN	FCC	FCC-TLISN-T8-02-09	100106	07/31/2013
Capacitive Voltage Probe	FCC	F-CVP-1	100185	03/24/2014
Test S/W	CCS-3A1-CE			

Dynamic Frequency Selection				
Name of Equipment	Manufacturer	Model	Serial Number	Calibration Due
Vector Signal Generator	ROHDE&SCHWARZ	SMU200A	101480	12/05/2013
Spectrum Analyzer	Agilent	E4446A	MY43360131	05/21/2013



4.3 MEASUREMENT UNCERTAINTY

PARAMETER	UNCERTAINTY
Powerline Conducted Emission	+/- 1.2159
3M Semi Anechoic Chamber / 30M~200M	+/- 4.0138
3M Semi Anechoic Chamber / 200M~1000M	+/- 3.9483
3M Semi Anechoic Chamber / 1G~8G	+/- 2.5975
3M Semi Anechoic Chamber / 8G~18G	+/- 2.6112
3M Semi Anechoic Chamber / 18G~26G	+/- 2.7389
3M Semi Anechoic Chamber / 26G~40G	+/- 2.9683

Remark: This uncertainty represents an expanded uncertainty expressed at approximately the 95% confidence level using a coverage factor of $k=2$.



5. FACILITIES AND ACCREDITATIONS

5.1 FACILITIES

All measurement facilities used to collect the measurement data are located at

No.199, Chungshen Road, Hsintien City, Taipei Hsien, Taiwan, R.O.C.

Tel: 886-2-2217-0894 / Fax: 886-2-2217-1029

No.11, Wu-Gong 6th Rd., Wugu Dist., New Taipei City 24891, Taiwan (R.O.C.)

Tel: 886-2-2299-9720 / Fax: 886-2-2298-4045

No.81-1, Lane 210, Bade 2nd Rd., Lujhu Township, Taoyuan County 33841, TAIWAN, R.O.C.

Tel: 886-3-324-0332 / Fax: 886-3-324-5235

The sites are constructed in conformance with the requirements of ANSI C63.7, ANSI C63.4 and CISPR Publication 22.

5.2 EQUIPMENT

Radiated emissions are measured with one or more of the following types of linearly polarized antennas: tuned dipole, biconical, log periodic, bi-log, and/or ridged waveguide, horn. Spectrum analyzers with pre-selectors and quasi-peak detectors are used to perform radiated measurements.



Conducted emissions are measured with Line Impedance Stabilization Networks and EMI Test Receivers.

Calibrated wideband preamplifiers, coaxial cables, and coaxial attenuators are also used for making measurements.

All receiving equipment conforms to CISPR Publication 16-1, "Radio Interference Measuring Apparatus and Measurement Methods."



5.3 TABLE OF ACCREDITATIONS AND LISTINGS

Country	Agency	Scope of Accreditation	Logo
USA	FCC	3M Semi Anechoic Chamber (FCC MRA: TW1039) to perform FCC Part 15 measurements	 FCC MRA: TW1039
Taiwan	TAF	LP0002, RTTE01, FCC Method-47 CFR Part 15 Subpart C, D, E, RSS-210, RSS-310 IDA TS SRD, AS/NZS 4268, AS/NZS 4771, TS 12.1 & 12.2, ETSI EN 300 440-1, ETSI EN 300 440-2, ETSI EN 300 328, ETSI EN 300 220-1, ETSI EN 300 220-2, ETSI EN 301 893, ETSI EN 301 489-1/3/7/17 FCC OET Bulletin 65 + Supplement C, EN 50360, EN 50361, EN 50371, RSS 102, EN 50383, EN 50385, EN 50392, IEC 62209, CNS 14958-1, CNS 14959 FCC Method -47 CFR Part 15 Subpart B IEC / EN 61000-3-2, IEC / EN 61000-3-3, IEC / EN 61000-4-2/3/4/5/6/8/11	
Canada	Industry Canada	3M Semi Anechoic Chamber (IC 2324G-1 / IC 2324G-2) to perform	 IC 2324G-1 IC 2324G-2

* No part of this report may be used to claim or imply product endorsement by A2LA or any agency of the US Government.



6. SETUP OF EQUIPMENT UNDER TEST

6.1 SETUP CONFIGURATION OF EUT

See test photographs attached in Appendix I for the actual connections between EUT and support equipment.

6.2 SUPPORT EQUIPMENT

No.	Device Type	Brand	Model	Series No.	FCC ID	Power Cord	Data Cable
1	PC	HP	Compaq dx7510 mtpc	SGH947RR1Y	FCC DoC	Non-Shielded, 1.8 m	Shielded, 1.8 m with 2 cores
2	LCD Monitor	DELL	U2410F	CN-082WXD-72872-16 R-04TL	FCC DoC	Non-Shielded, 1.8 m	N/A
3	Printer	EPSON	Stylus-C63	FAPY150360	FCC DoC	Non-Shielded, 1.8 m	Shielded, 1.8 m
4	HDD	WD	My Passport	WX31A41A7211	FCC DoC	N/A	Shielded, 1.5 m
5	Docking	N/A	N/A	N/A	N/A	N/A	Shielded, 1.8 m
6	Keyboard	DELL	SK-8115	MY-ODJ325-71619-9BP-0931	FCC DoC	N/A	Shielded, 1.8 m
7	Mouse	DELL	OXN867	J0206CRS	FCC DoC	N/A	Shielded, 1.8 m
8.	SIM Card	N/A	N/A	N/A	N/A	N/A	N/A
9.	Micro SD 8G	Transcend	N/A	N/A	N/A	N/A	N/A
10.	Universal Radio Communication Tester (Remote)	R&S	CMU200	101245	N/A	Non-Shielded, 1.8 m	N/A

Remark:

1. All the equipment/cables were placed in the worst-case configuration to maximize the emission during the test.
2. Grounding was established in accordance with the manufacturer's requirements and conditions for the intended use.



7. FCC PART 15 REQUIREMENTS

7.1 26 DB EMISSION BANDWIDTH

LIMIT

According to §15.303(c), for purposes of this subpart the emission bandwidth shall be determined by measuring the width of the signal between two points, one below the carrier center frequency and one above the carrier center frequency, that are 26 dB down relative to the maximum level of the modulated carrier. Compliance with the emissions limits is based on the use of measurement instrumentation employing a peak detector function with an instrument resolutions bandwidth approximately equal to 1.0 percent of the emission bandwidth of the device under measurement.

Test Configuration

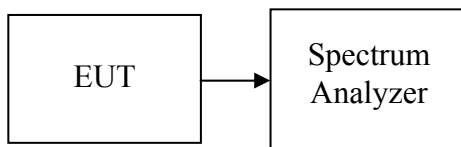

TEST PROCEDURE

1. Place the EUT on the table and set it in the transmitting mode.
2. Remove the antenna from the EUT and then connect a low-loss RF cable from the antenna port to the spectrum analyzer.
3. Set the spectrum analyzer as RBW > 1%EBW, VBW > RBW, Span >26dB bandwidth, and Sweep = auto.
4. Mark the peak frequency and -26dB (upper and lower) frequency.
5. Repeat until all the rest channels were investigated.

TEST RESULTS

No non-compliance noted



Test Data

Test mode: IEEE 802.11a mode / 5180 ~ 5240MHz

Channel	Frequency (MHz)	Bandwidth (MHz)
Low	5180	20.200
Mid	5220	20.262
High	5240	20.938

Test mode: IEEE 802.11n HT 20 MHz mode / 5180 ~ 5240MHz

Channel	Frequency (MHz)	Bandwidth (MHz)
Low	5180	21.032
Mid	5220	21.263
High	5240	21.097

Test mode: IEEE 802.11a mode / 5260 ~ 5320MHz

Channel	Frequency (MHz)	Bandwidth (MHz)
Low	5260	20.834
Mid	5280	20.188
High	5320	20.500

Test mode: IEEE 802.11n HT 20 MHz mode / 5260 ~ 5320MHz

Channel	Frequency (MHz)	Bandwidth (MHz)
Low	5260	21.456
Mid	5280	21.109
High	5320	21.562

Test mode: IEEE 802.11a mode / 5500 ~ 5700MHz

Channel	Frequency (MHz)	Bandwidth (MHz)
Low	5500	19.894
Mid	5580	20.193
High	5700	19.257

Test mode: IEEE 802.11n HT 20 MHz mode / 5500 ~ 5700MHz

Channel	Frequency (MHz)	Bandwidth (MHz)
Low	5500	20.777
Mid	5580	21.549
High	5700	21.341



Test Plot

IEEE 802.11a mode / 5180 ~ 5240MHz

CH Low

Agilent 15:51:15 Oct 31, 2012

R T

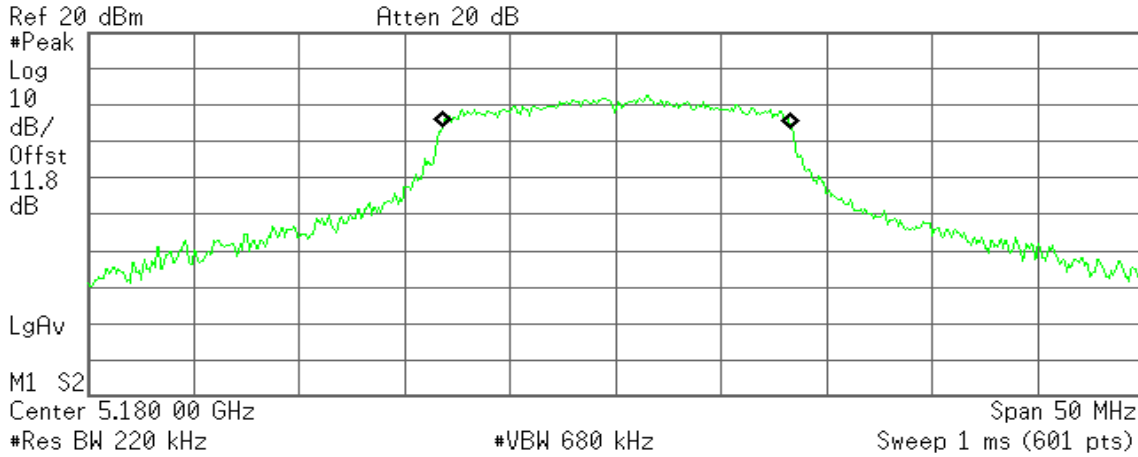

Occupied Bandwidth
16.4589 MHz

Occ BW % Pwr 99.00 %
x dB -26.00 dB

Transmit Freq Error 28.971 kHz
x dB Bandwidth 20.200 MHz

CH Mid

Agilent 15:54:41 Oct 31, 2012

R T

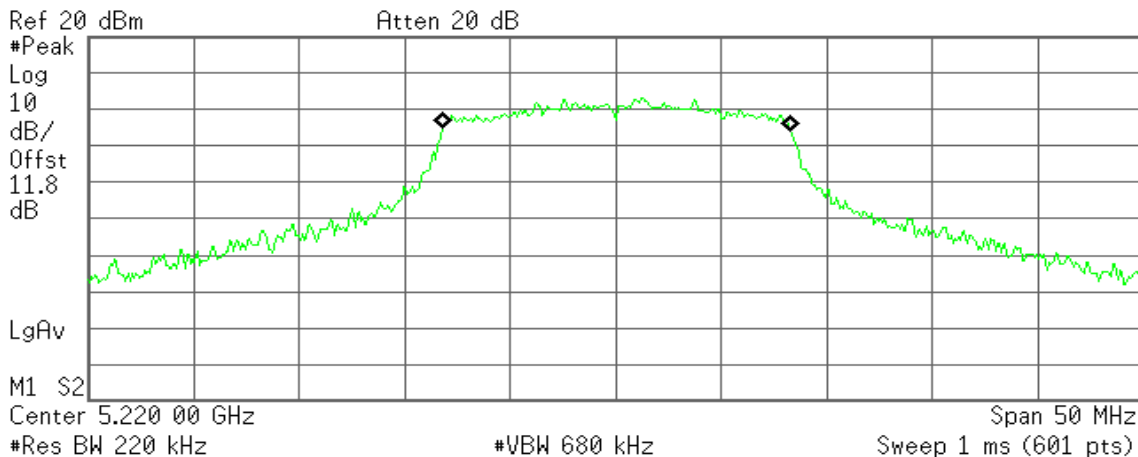

Occupied Bandwidth
16.4523 MHz

Occ BW % Pwr 99.00 %
x dB -26.00 dB

Transmit Freq Error 46.025 kHz
x dB Bandwidth 20.262 MHz



CH High

Agilent 15:58:03 Oct 31, 2012

R T

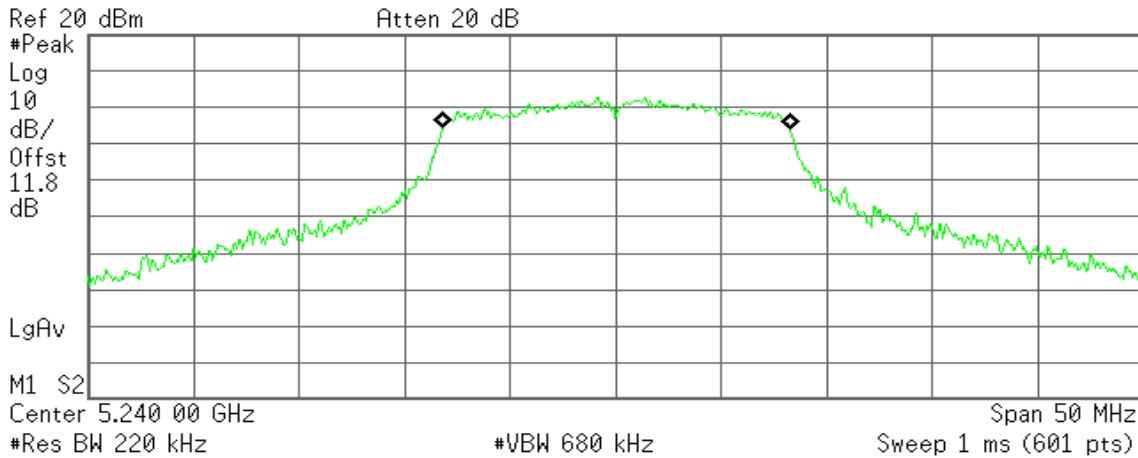

Occupied Bandwidth
16.4046 MHz

Occ BW % Pwr 99.00 %
x dB -26.00 dB

Transmit Freq Error 43.059 kHz
x dB Bandwidth 20.938 MHz

IEEE 802.11n HT 20 MHz mode / 5180 ~ 5240MHz

CH Low

Agilent 17:09:59 Oct 31, 2012

R T

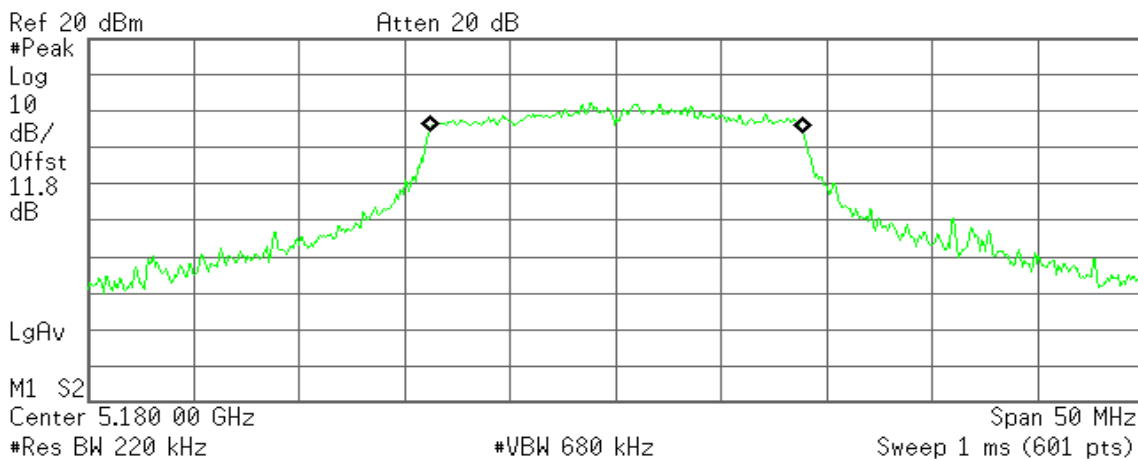

Occupied Bandwidth
17.6355 MHz

Occ BW % Pwr 99.00 %
x dB -26.00 dB

Transmit Freq Error 29.087 kHz
x dB Bandwidth 21.032 MHz



CH Mid

Agilent 17:14:45 Oct 31, 2012

R T

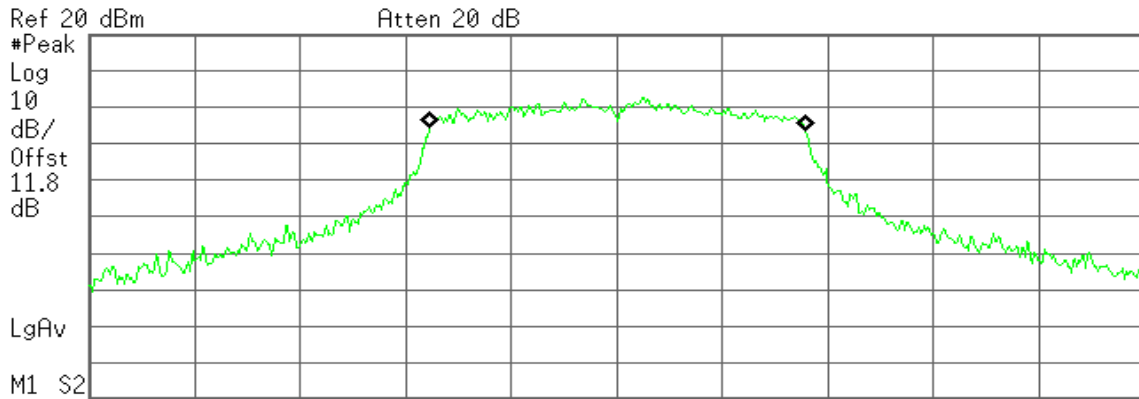

Center 5.220 00 GHz

Span 50 MHz

#Res BW 240 kHz

#VBW 680 kHz

Sweep 1 ms (601 pts)

Occupied Bandwidth
17.7013 MHz

Occ BW % Pwr 99.00 %
x dB -26.00 dB

Transmit Freq Error 39.480 kHz
x dB Bandwidth 21.263 MHz

CH High

Agilent 17:19:27 Oct 31, 2012

R T

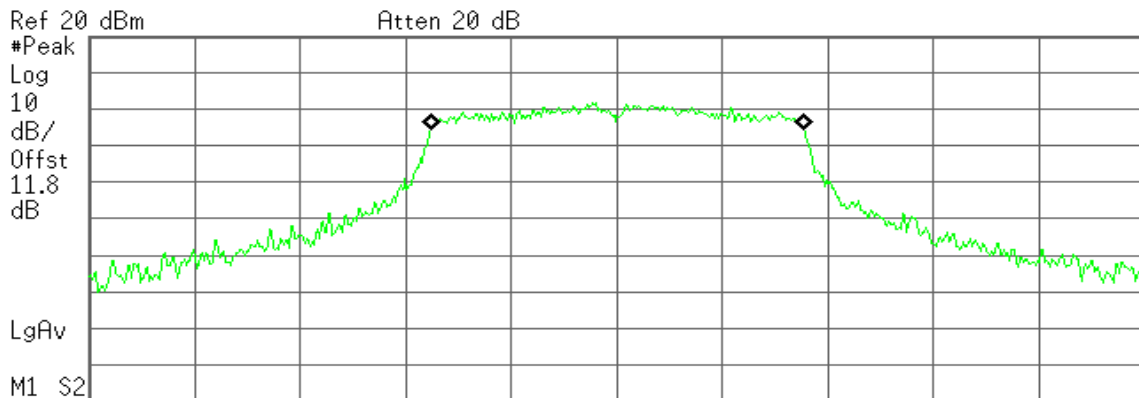

Center 5.240 00 GHz

Span 50 MHz

#Res BW 240 kHz

#VBW 680 kHz

Sweep 1 ms (601 pts)

Occupied Bandwidth
17.6344 MHz

Occ BW % Pwr 99.00 %
x dB -26.00 dB

Transmit Freq Error 34.220 kHz
x dB Bandwidth 21.097 MHz



IEEE 802.11a mode / 5260 ~ 5320MHz

CH Low

Agilent 19:15:02 Oct 30, 2012

R T

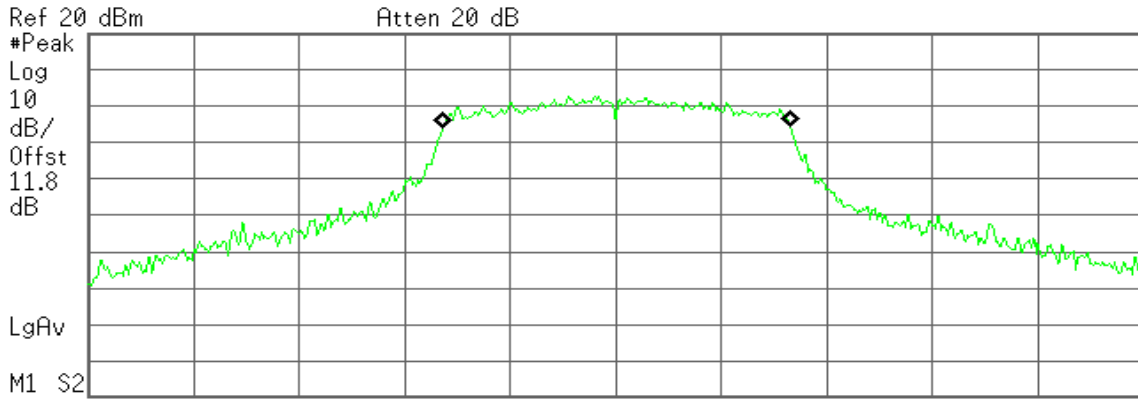

Center 5.260 00 GHz Span 50 MHz
 #Res BW 220 kHz #VBW 680 kHz Sweep 1 ms (601 pts)

Occupied Bandwidth
16.4453 MHz

Occ BW % Pwr 99.00 %
x dB -26.00 dB

Transmit Freq Error 52.256 kHz
x dB Bandwidth 20.834 MHz

CH Mid

Agilent 19:25:43 Oct 30, 2012

R T

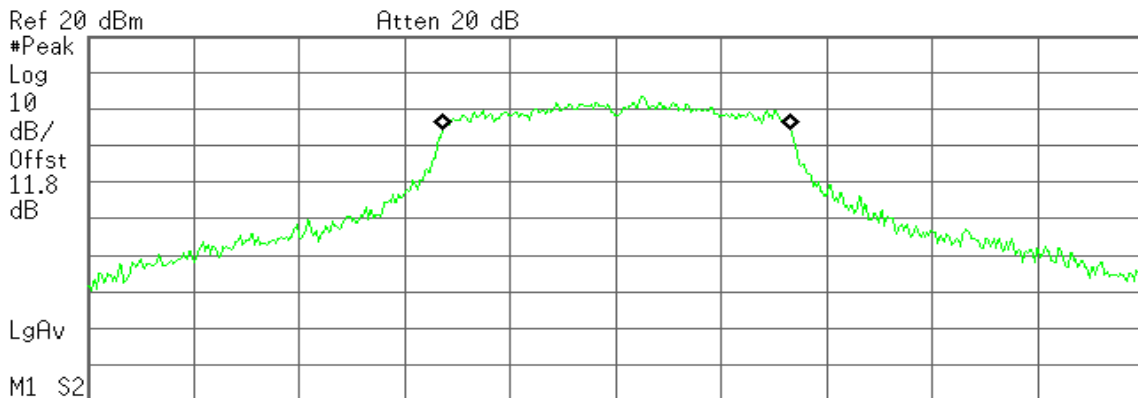

Center 5.280 00 GHz Span 50 MHz
 #Res BW 220 kHz #VBW 680 kHz Sweep 1 ms (601 pts)

Occupied Bandwidth
16.4489 MHz

Occ BW % Pwr 99.00 %
x dB -26.00 dB

Transmit Freq Error 45.086 kHz
x dB Bandwidth 20.188 MHz



CH High

Agilent 19:29:02 Oct 30, 2012

R T

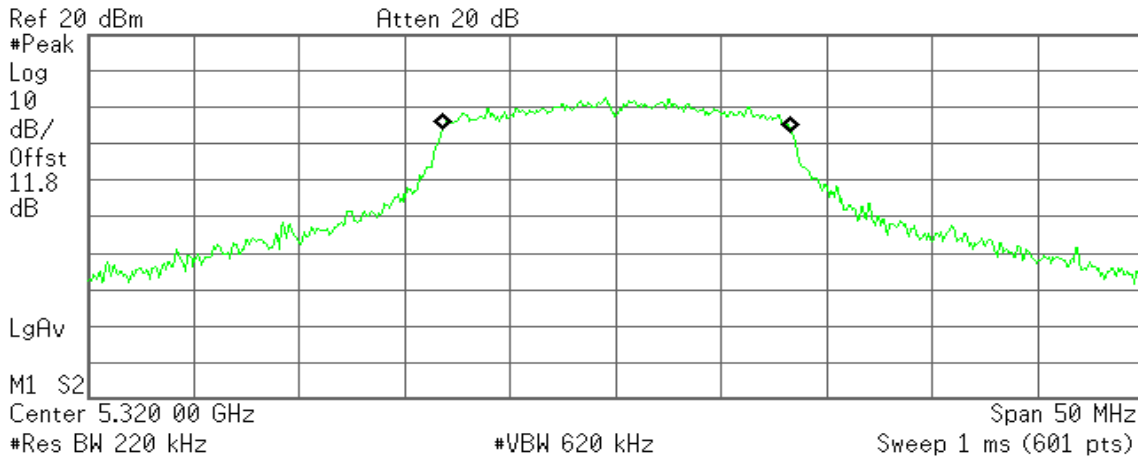

Occupied Bandwidth
16.4697 MHz

Occ BW % Pwr 99.00 %
x dB -26.00 dB

Transmit Freq Error 49.321 kHz
x dB Bandwidth 20.500 MHz

IEEE 802.11n HT 20 MHz mode / 5260 ~ 5320MHz

CH Low

Agilent 19:46:27 Oct 30, 2012

R T

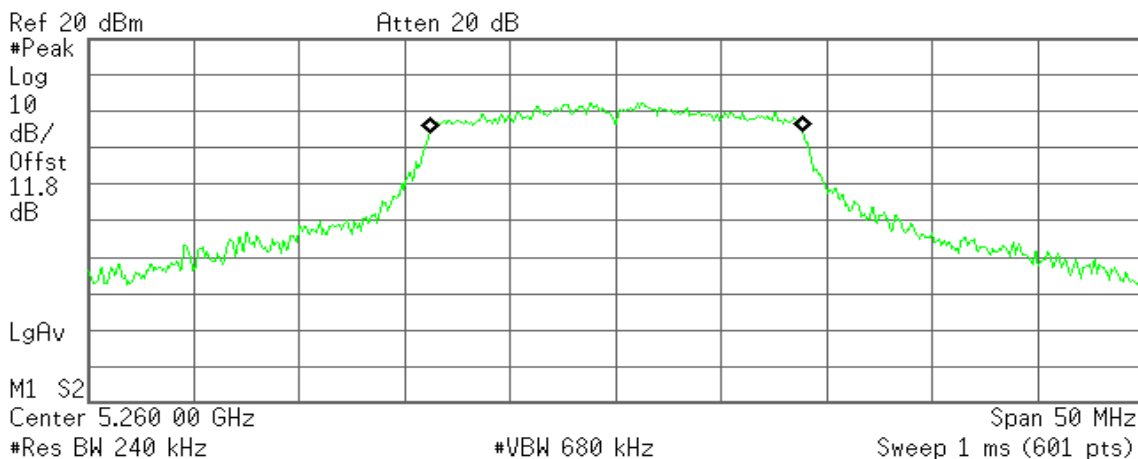

Occupied Bandwidth
17.6399 MHz

Occ BW % Pwr 99.00 %
x dB -26.00 dB

Transmit Freq Error 34.752 kHz
x dB Bandwidth 21.456 MHz



CH Mid

Agilent 19:49:55 Oct 30, 2012

R T

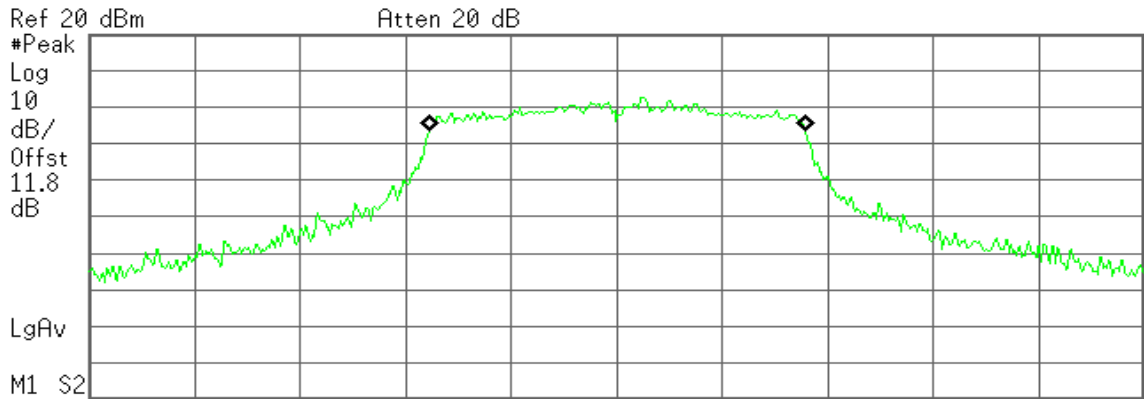

Occupied Bandwidth
17.6935 MHz

Occ BW % Pwr 99.00 %
x dB -26.00 dB

Transmit Freq Error 36.485 kHz
x dB Bandwidth 21.109 MHz

CH High

Agilent 19:53:24 Oct 30, 2012

R T

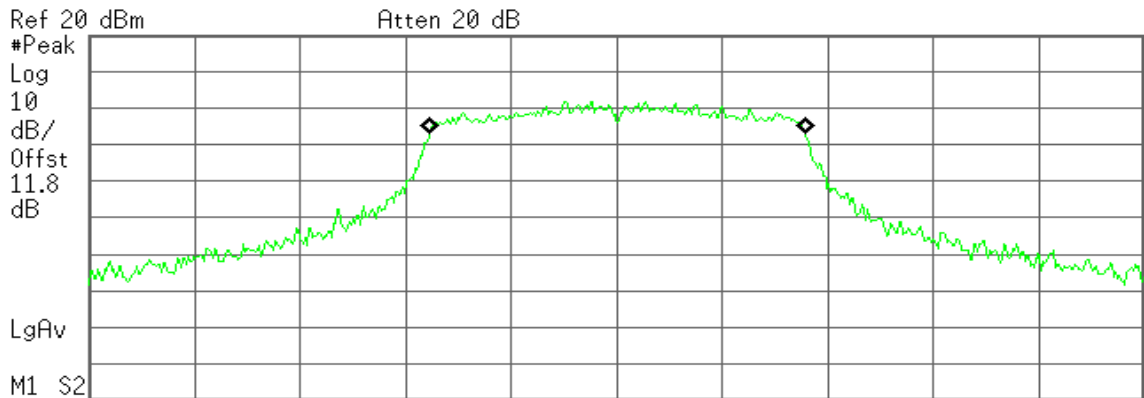

Occupied Bandwidth
17.6992 MHz

Occ BW % Pwr 99.00 %
x dB -26.00 dB

Transmit Freq Error 40.539 kHz
x dB Bandwidth 21.562 MHz



Test mode: IEEE 802.11a mode / 5500 ~ 5700MHz

CH Low

Agilent 19:33:41 Oct 30, 2012

R T

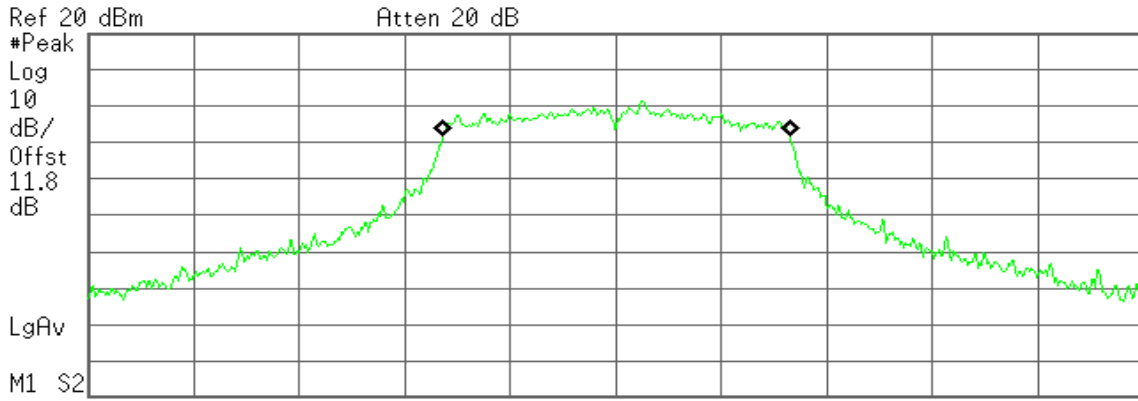

Ref 20 dBm Atten 20 dB
 Center 5.500 00 GHz Span 50 MHz
 #Res BW 220 kHz #VBW 620 kHz Sweep 1 ms (601 pts)

Occupied Bandwidth
16.3788 MHz

Occ BW % Pwr 99.00 %
x dB -26.00 dB

Transmit Freq Error 20.617 kHz
x dB Bandwidth 19.894 MHz

CH Mid

Agilent 19:37:18 Oct 30, 2012

R T

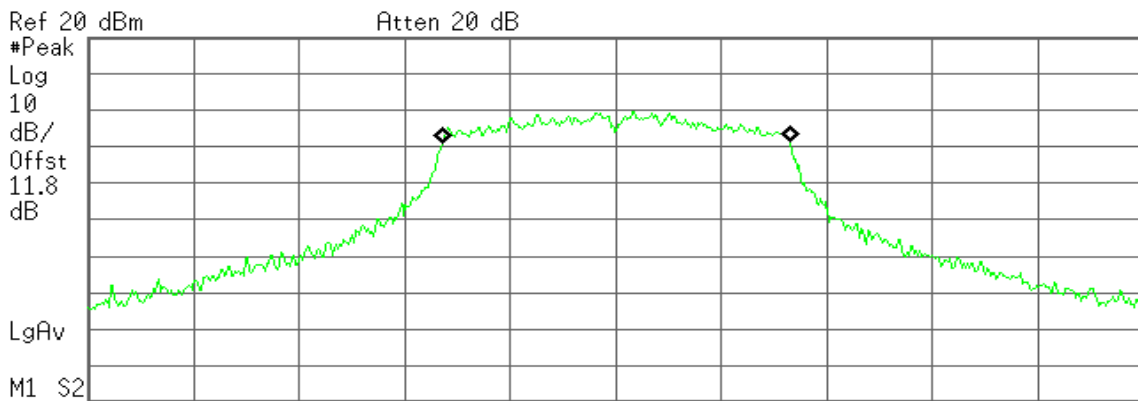

Ref 20 dBm Atten 20 dB
 Center 5.580 00 GHz Span 50 MHz
 #Res BW 220 kHz #VBW 680 kHz Sweep 1 ms (601 pts)

Occupied Bandwidth
16.4131 MHz

Occ BW % Pwr 99.00 %
x dB -26.00 dB

Transmit Freq Error 22.091 kHz
x dB Bandwidth 20.193 MHz



CH High

Agilent 19:40:35 Oct 30, 2012

R T

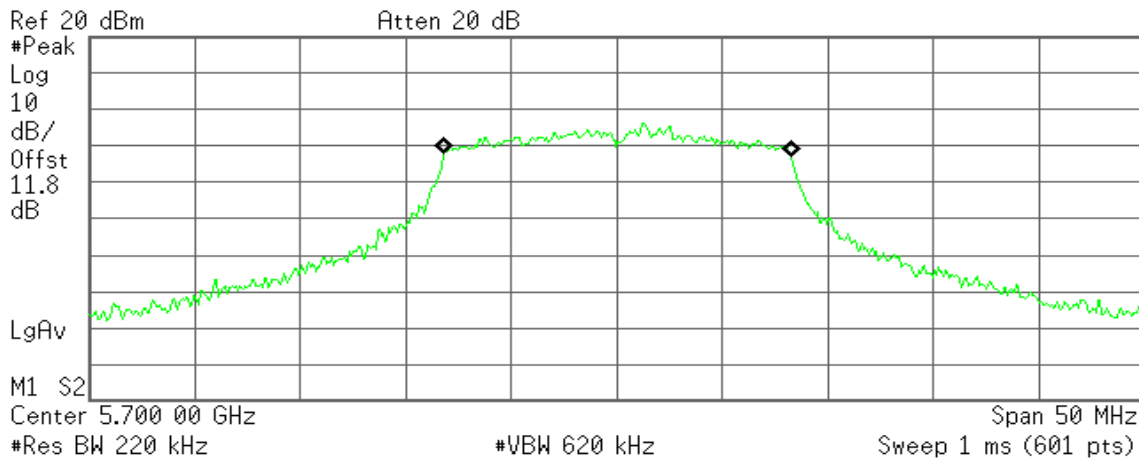

Occupied Bandwidth
16.3992 MHz

Occ BW % Pwr 99.00 %
x dB -26.00 dB

Transmit Freq Error 34.006 kHz
x dB Bandwidth 19.257 MHz

IEEE 802.11n HT 20 MHz mode / 5500 ~ 5700MHz

CH Low

Agilent 19:57:46 Oct 30, 2012

R T

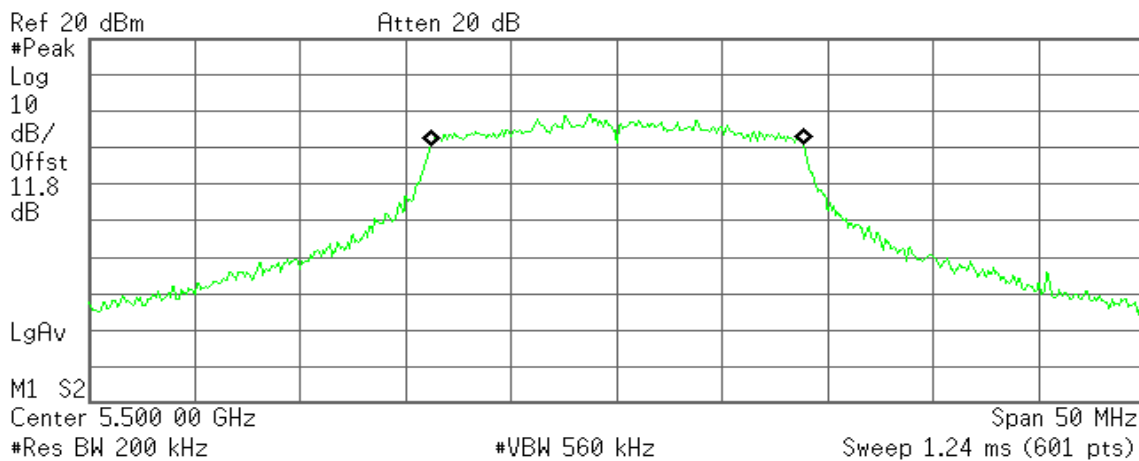

Occupied Bandwidth
17.6085 MHz

Occ BW % Pwr 99.00 %
x dB -26.00 dB

Transmit Freq Error 18.269 kHz
x dB Bandwidth 20.777 MHz



CH Mid

Agilent 20:00:49 Oct 30, 2012

R T

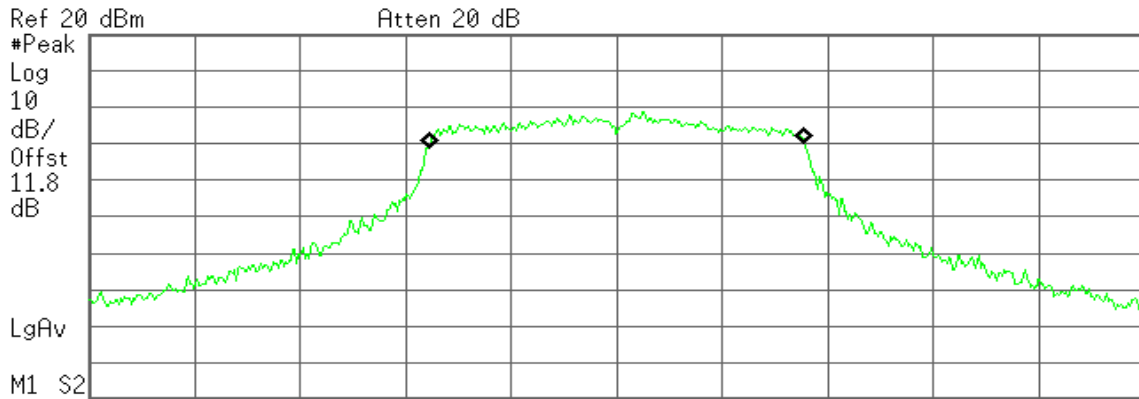

Occupied Bandwidth
17.7025 MHz

Occ BW % Pwr 99.00 %
x dB -26.00 dB

Transmit Freq Error 20.622 kHz
x dB Bandwidth 21.549 MHz

CH High

Agilent 20:03:54 Oct 30, 2012

R T

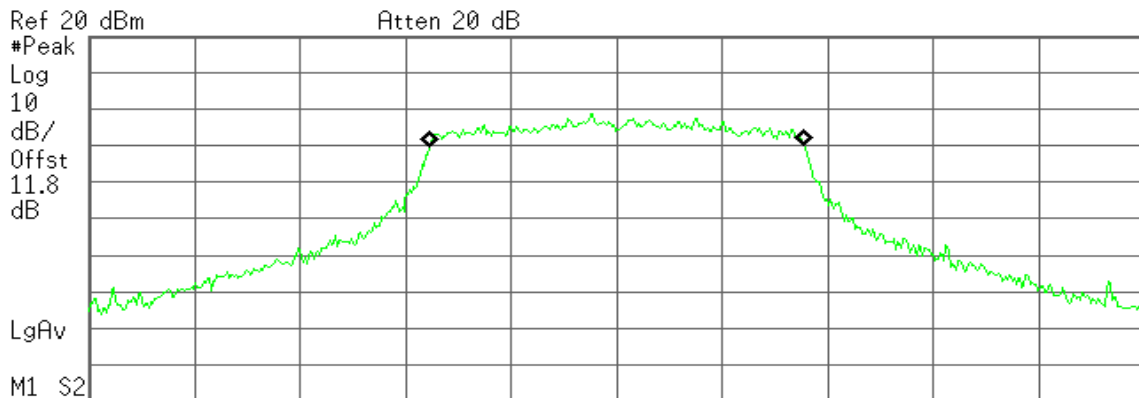

Occupied Bandwidth
17.6909 MHz

Occ BW % Pwr 99.00 %
x dB -26.00 dB

Transmit Freq Error 19.997 kHz
x dB Bandwidth 21.341 MHz



7.2 MAXIMUM CONDUCTED OUTPUT POWER

LIMIT

According to §15.407(a),

- (1) For the band 5.15-5.25 GHz, the maximum conducted output power over the frequency band of operation shall not exceed the lesser of 50 mW or $4 \text{ dBm} + 10 \log B$, where B is the 26 dB emission bandwidth in MHz.
- (2) For the 5.25-5.35 GHz and 5.47-5.725 GHz bands, the maximum conducted output power over the frequency bands of operation shall not exceed the lesser of 250 mW or $11 \text{ dBm} + 10 \log B$, where B is the 26 dB emission bandwidth in MHz.

If transmitting antennas of directional gain greater than 6dBi are used, both the peak transmit power and the peak power spectral density shall be reduced by the amount in dB that the directional gain of the antenna exceeds 6dBi.

The peak power shall not exceed the limit as follow:

Specified Limit of the Peak Power

Test mode: IEEE 802.11a mode / 5180 ~ 5240MHz

Channel	Frequency (MHz)	26 dB Bandwidth (B) (MHz)	10 Log B (dB)	4 + 10 Log B (dBm)	Maximum Conducted Output Power Limit (dBm)
Low	5180	20.2	13.05351	17.0535	17.00
Mid	5220	20.262	13.06682	17.0668	17.00
High	5240	20.938	13.20935	17.2094	17.00

Test mode: IEEE 802.11n HT 20 MHz mode / 5180 ~ 5240MHz

Channel	Frequency (MHz)	26 dB Bandwidth (B) (MHz)	10 Log B (dB)	4 + 10 Log B (dBm)	Maximum Conducted Output Power Limit (dBm)
Low	5180	21.032	13.22881	17.2288	17.00
Mid	5220	21.263	13.27625	17.2762	17.00
High	5240	21.097	13.24221	17.2422	17.00

Test mode: IEEE 802.11a mode / 5260 ~ 5320MHz

Channel	Frequency (MHz)	26 dB Bandwidth (B) (MHz)	10 Log B (dB)	11 + 10 Log B (dBm)	Maximum Conducted Output Power Limit (dBm)
Low	5260	20.834	13.18773	24.1877	24.00
Mid	5280	20.188	13.05093	24.0509	24.00
High	5320	20.5	13.11754	24.1175	24.00

Test mode: IEEE 802.11n HT 20 MHz mode / 5260 ~ 5320MHz

Channel	Frequency (MHz)	26 dB Bandwidth (B) (MHz)	10 Log B (dB)	11 + 10 Log B (dBm)	Maximum Conducted Output Power Limit (dBm)
Low	5260	21.456	13.31549	24.3155	24.00
Mid	5280	21.109	13.24468	24.2447	24.00
High	5320	21.562	13.33689	24.3369	24.00



Test mode: IEEE 802.11a mode / 5500 ~ 5700MHz

Channel	Frequency (MHz)	26 dB Bandwidth (B) (MHz)	10 Log B (dB)	11 + 10 Log B (dBm)	Maximum Conducted Output Power Limit (dBm)
Low	5500	19.894	12.98722	23.9872	24.00
Mid	5580	20.193	13.05201	24.0520	24.00
High	5700	19.257	12.84589	23.8459	24.00

Test mode: IEEE 802.11n HT 20 MHz mode/ 5500 ~ 5700MHz

Channel	Frequency (MHz)	26 dB Bandwidth (B) (MHz)	10 Log B (dB)	11 + 10 Log B (dBm)	Maximum Conducted Output Power Limit (dBm)
Low	5500	20.777	13.17583	24.1758	24.00
Mid	5580	21.549	13.33427	24.3343	24.00
High	5700	21.341	13.29215	24.2921	24.00



Test Configuration

The EUT was connected to a spectrum analyzer through a 50 Ω RF cable.

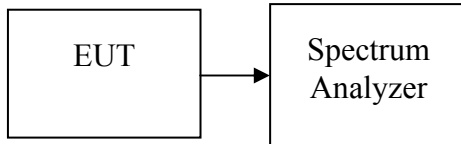

TEST PROCEDURE

Set span to encompass the entire emission bandwidth (EBW) of the signal.

Set RBW = 1 MHz / Set VBW = 3 MHz.

Use sample detector mode if bin width (i.e., span/number of points in spectrum display) < 0.5 RBW. Otherwise use peak detector mode. Use a video trigger with the trigger level set to enable triggering only on full power pulses. Transmitter must operate at full control power for entire sweep of every sweep. If the device transmits continuously, with no off intervals or reduced power intervals, the trigger may be set to “free run”. Trace average 100 traces in power averaging mode. Compute power by integrating the spectrum across the 26 dB EBW of the signal. The integration can be performed using the spectrum analyzer’s band power measurement function with band limits set equal to the EBW band edges or by summing power levels in each 1 MHz band in linear power terms. The 1 MHz band power levels to be summed can be obtained by averaging, in linear power terms, power levels in each frequency bin across the 1 MHz.

TEST RESULTS

No non-compliance noted



Test Data

Test mode: IEEE 802.11a mode / 5180 ~ 5240MHz

Channel	Frequency (MHz)	Maximum Conducted Output Power (dBm)	Limit (dBm)
Low	5180	12.00	17.00
Mid	5220	11.32	17.00
High	5240	12.00	17.00

Test mode: IEEE 802.11n HT 20 MHz mode / 5180 ~ 5240MHz

Channel	Frequency (MHz)	Maximum Conducted Output Power (dBm)	Limit (dBm)
Low	5180	11.05	17.00
Mid	5220	10.74	17.00
High	5240	10.95	17.00

Test mode: IEEE 802.11a mode / 5260 ~ 5320MHz

Channel	Frequency (MHz)	Maximum Conducted Output Power (dBm)	Limit (dBm)
Low	5260	11.77	24.00
Mid	5280	10.12	24.00
High	5320	11.75	24.00

Test mode: IEEE 802.11n HT 20 MHz mode / 5260 ~ 5320MHz

Channel	Frequency (MHz)	Maximum Conducted Output Power (dBm)	Limit (dBm)
Low	5260	11.04	24.00
Mid	5280	10.57	24.00
High	5320	10.82	24.00

Test mode: IEEE 802.11a mode / 5500 ~ 5700MHz

Channel	Frequency (MHz)	Maximum Conducted Output Power (dBm)	Limit (dBm)
Low	5500	8.50	23.99
Mid	5580	8.67	24.00
High	5700	6.42	23.85

Test mode: IEEE 802.11n HT 20 MHz mode / 5500 ~ 5700MHz

Channel	Frequency (MHz)	Maximum Conducted Output Power (dBm)	Limit (dBm)
Low	5500	7.98	24.00
Mid	5580	6.82	24.00
High	5700	7.27	24.00



Test Plot

IEEE 802.11a mode / 5180 ~ 5240MHz

CH Low

Agilent 15:51:50 Oct 31, 2012

R T

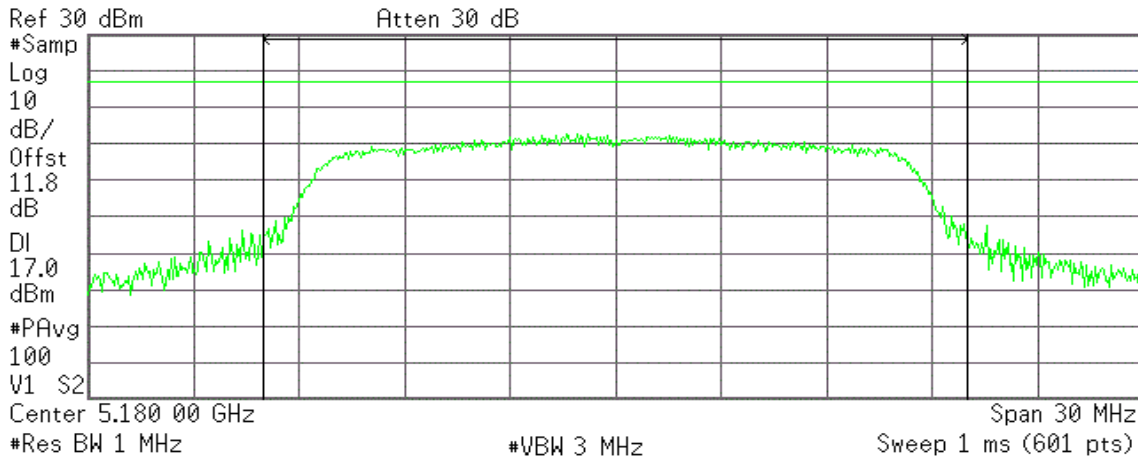

Channel Power

12.00 dBm /20.0000 MHz

Power Spectral Density

-61.01 dBm/Hz

CH Mid

Agilent 15:55:11 Oct 31, 2012

R T

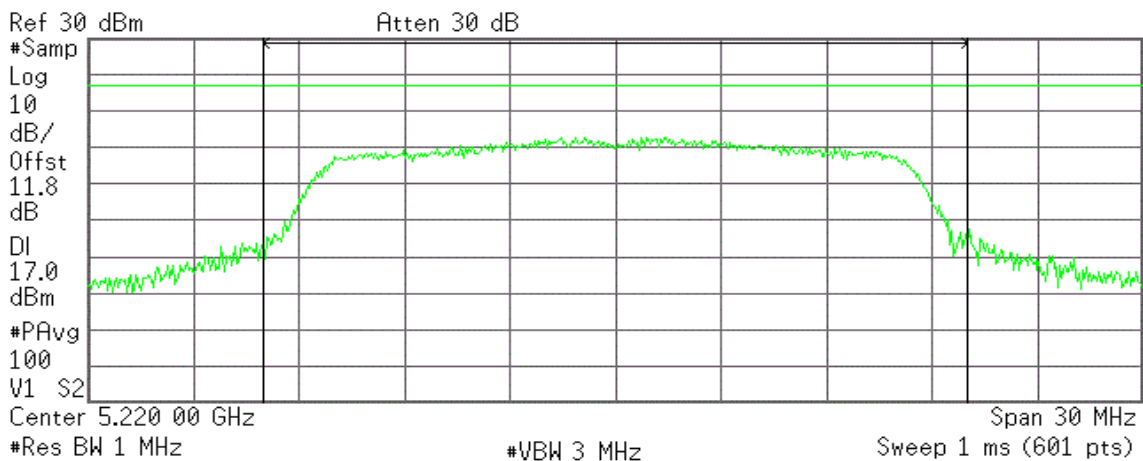

Channel Power

11.32 dBm /20.0000 MHz

Power Spectral Density

-61.69 dBm/Hz



CH High

Agilent 15:58:28 Oct 31, 2012

R T

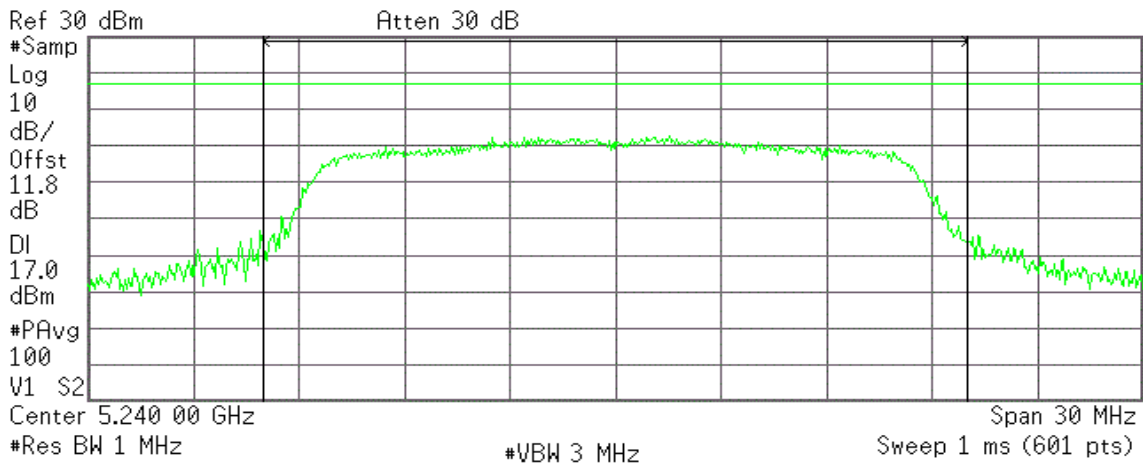

Channel Power

12.00 dBm /20.0000 MHz

Power Spectral Density

-60.78 dBm/Hz

IEEE 802.11n HT 20 MHz mode / 5180 ~ 5240MHz

CH Low

Agilent 17:10:38 Oct 31, 2012

R T

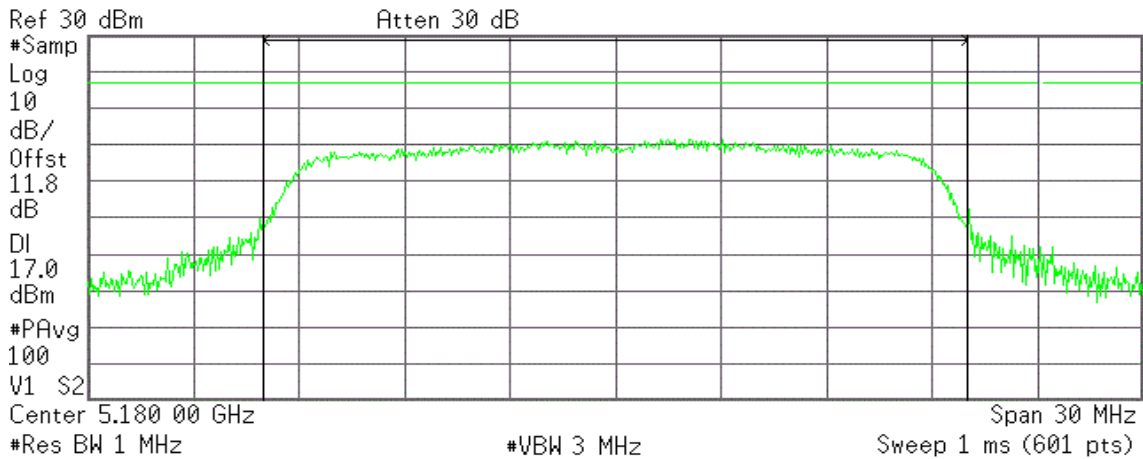

Channel Power

11.05 dBm /20.0000 MHz

Power Spectral Density

-61.96 dBm/Hz



CH Mid

Agilent 17:15:11 Oct 31, 2012

R T

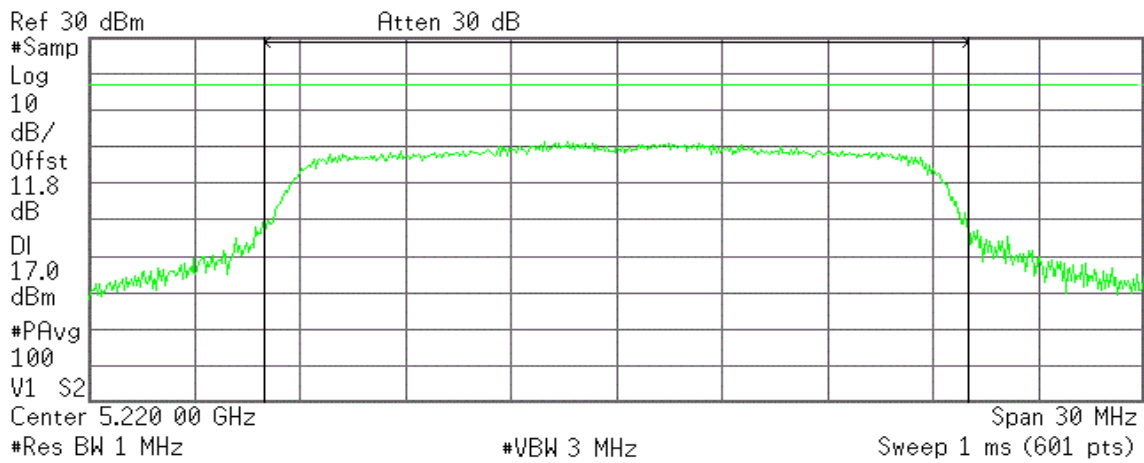

Channel Power

10.74 dBm /20.0000 MHz

Power Spectral Density

-62.27 dBm/Hz

CH High

Agilent 17:19:54 Oct 31, 2012

R T

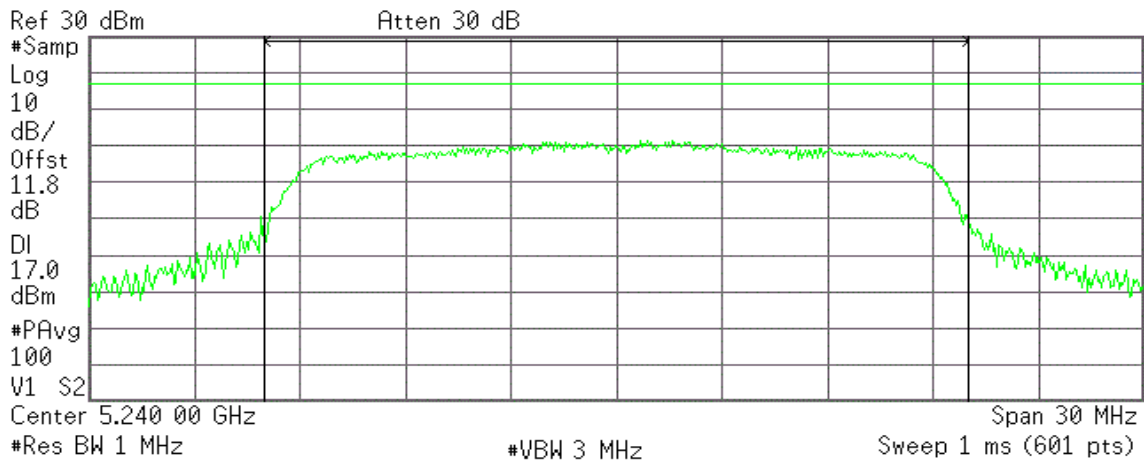

Channel Power

10.95 dBm /20.0000 MHz

Power Spectral Density

-62.06 dBm/Hz



IEEE 802.11a mode / 5260 ~ 5320MHz

CH Low

Agilent 19:17:18 Oct 30, 2012

R T

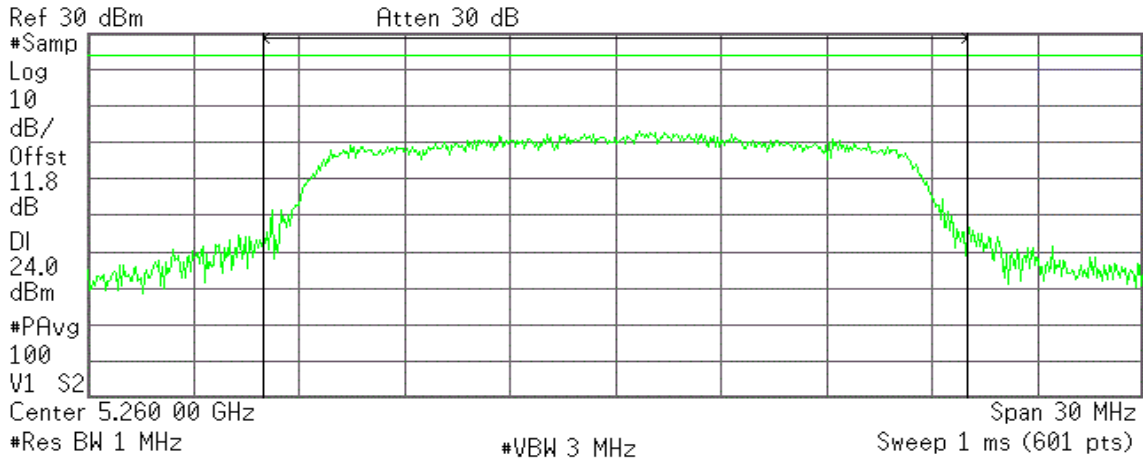

Channel Power

11.77 dBm /20.0000 MHz

Power Spectral Density

-60.87 dBm/Hz

CH Mid

Agilent 19:26:12 Oct 30, 2012

R T

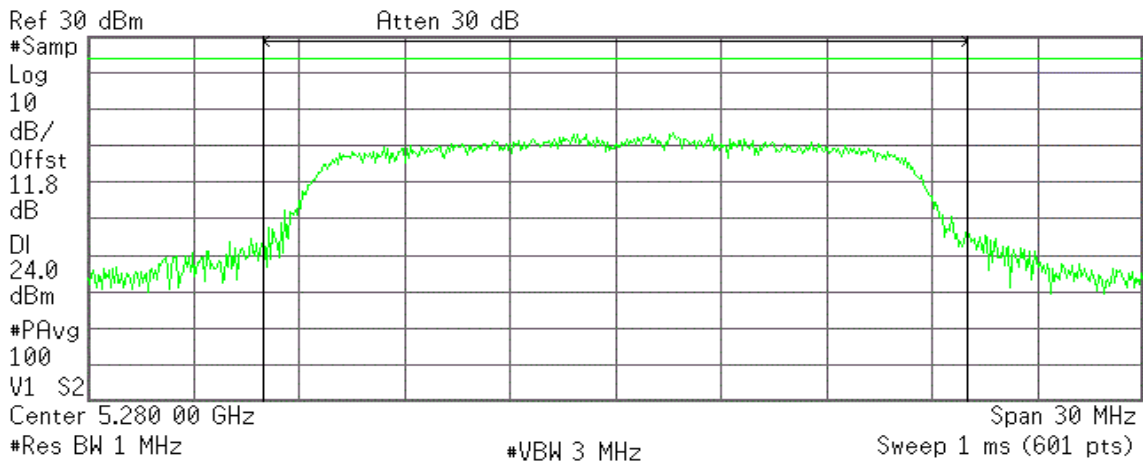

Channel Power

10.12 dBm /20.0000 MHz

Power Spectral Density

-62.89 dBm/Hz



CH High

Agilent 19:29:34 Oct 30, 2012

R T

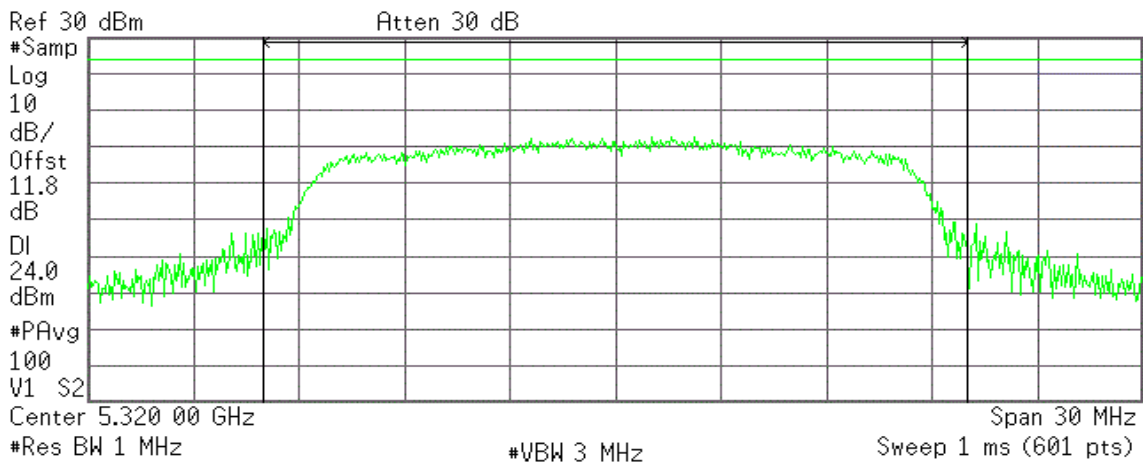

Channel Power

11.75 dBm /20.0000 MHz

Power Spectral Density

-61.26 dBm/Hz

IEEE 802.11n HT 20 MHz mode / 5260 ~ 5320MHz

CH Low

Agilent 19:46:56 Oct 30, 2012

R T

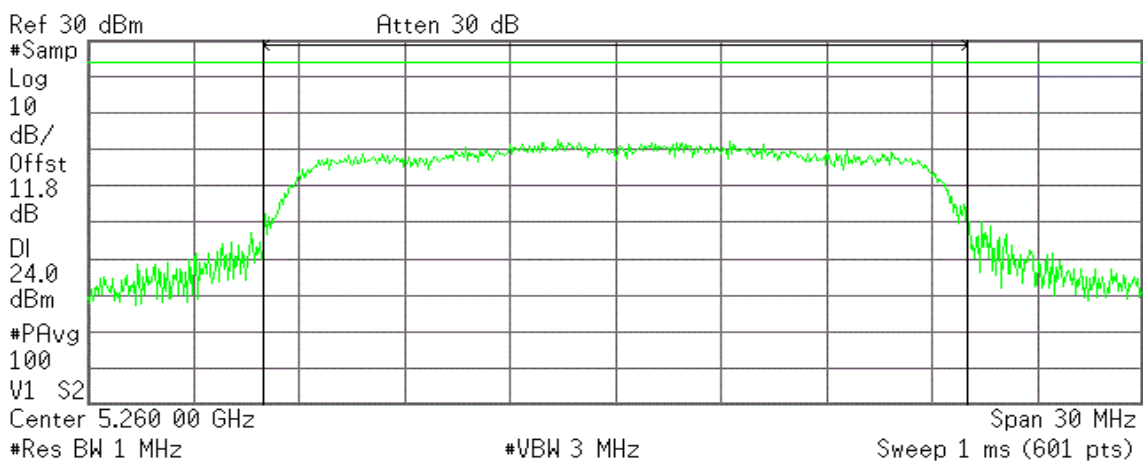

Channel Power

11.04 dBm /20.0000 MHz

Power Spectral Density

-61.97 dBm/Hz



CH Mid

Agilent 19:50:23 Oct 30, 2012

R T

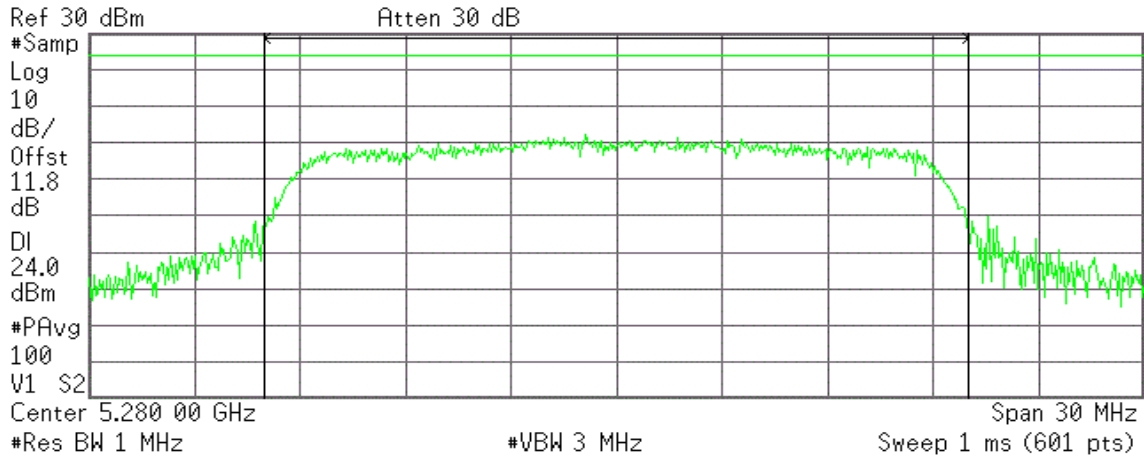

Channel Power

10.57 dBm /20.0000 MHz

Power Spectral Density

-62.44 dBm/Hz

CH High

Agilent 19:53:50 Oct 30, 2012

R T

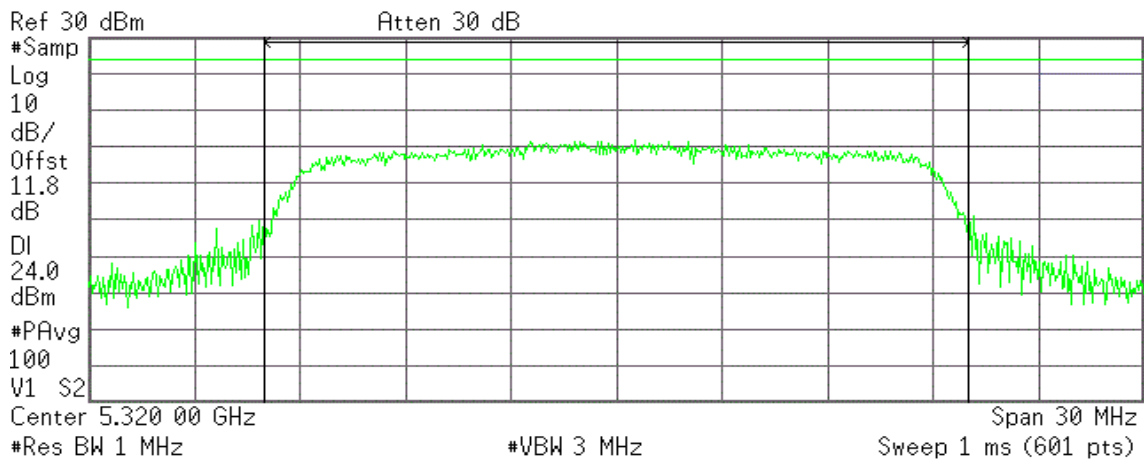

Channel Power

10.82 dBm /20.0000 MHz

Power Spectral Density

-62.19 dBm/Hz



Test mode: IEEE 802.11a mode / 5500 ~ 5700MHz

CH Low

Agilent 19:34:07 Oct 30, 2012

R T

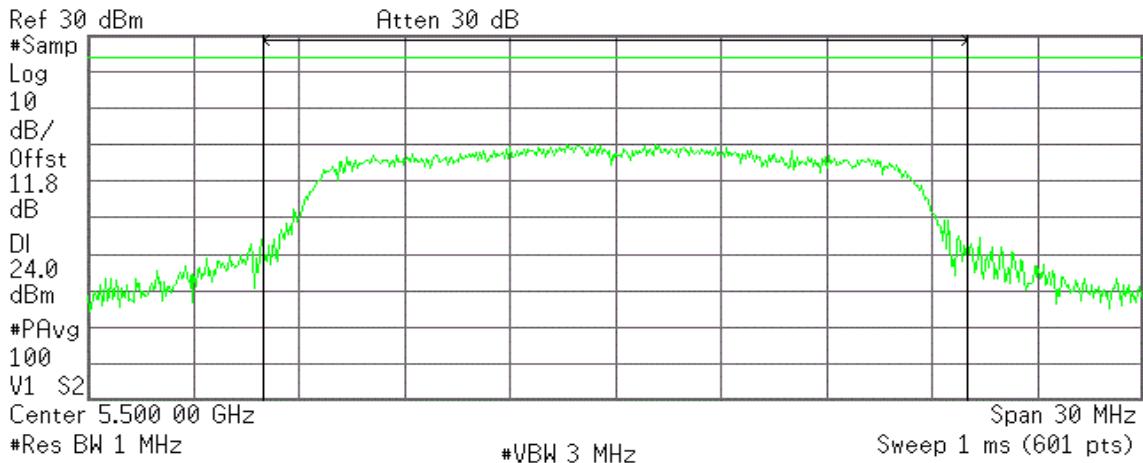

Channel Power

8.50 dBm /20.0000 MHz

Power Spectral Density

-64.51 dBm/Hz

CH Mid

Agilent 19:37:42 Oct 30, 2012

R T

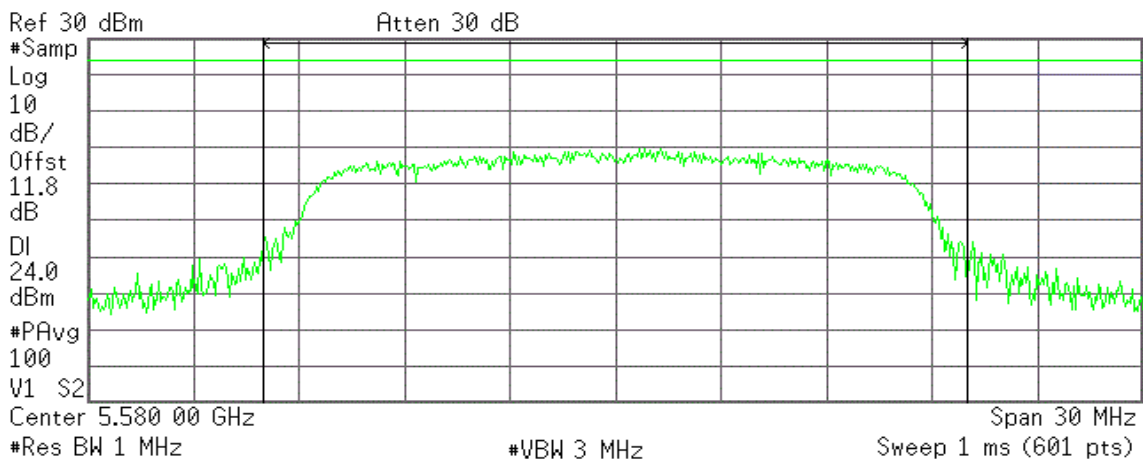

Channel Power

8.67 dBm /20.0000 MHz

Power Spectral Density

-64.34 dBm/Hz



CH High

Agilent 15:08:48 Dec 25, 2012

R T

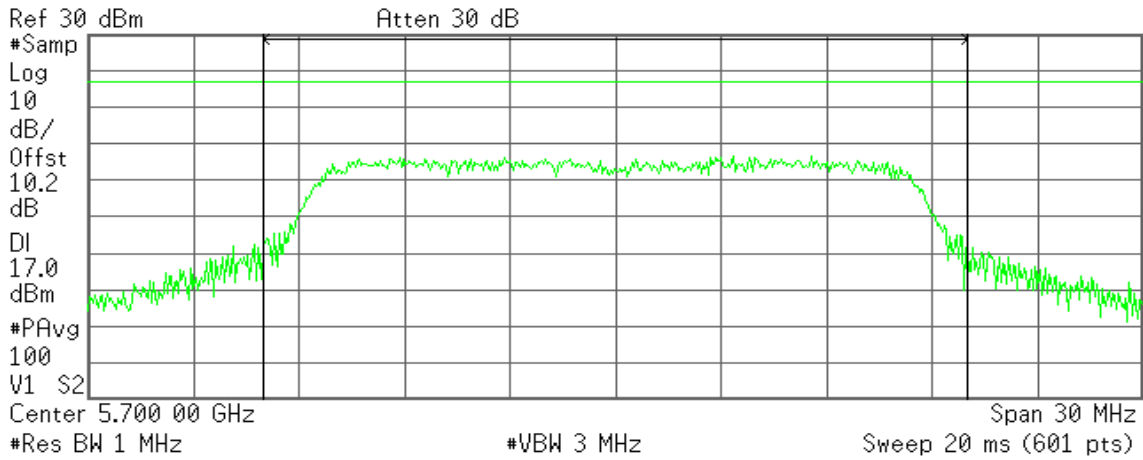

Channel Power

6.42 dBm /20.0000 MHz

Power Spectral Density

-66.82 dBm/Hz

IEEE 802.11n HT 20 MHz mode / 5500 ~ 5700MHz

CH Low

Agilent 19:58:13 Oct 30, 2012

R T

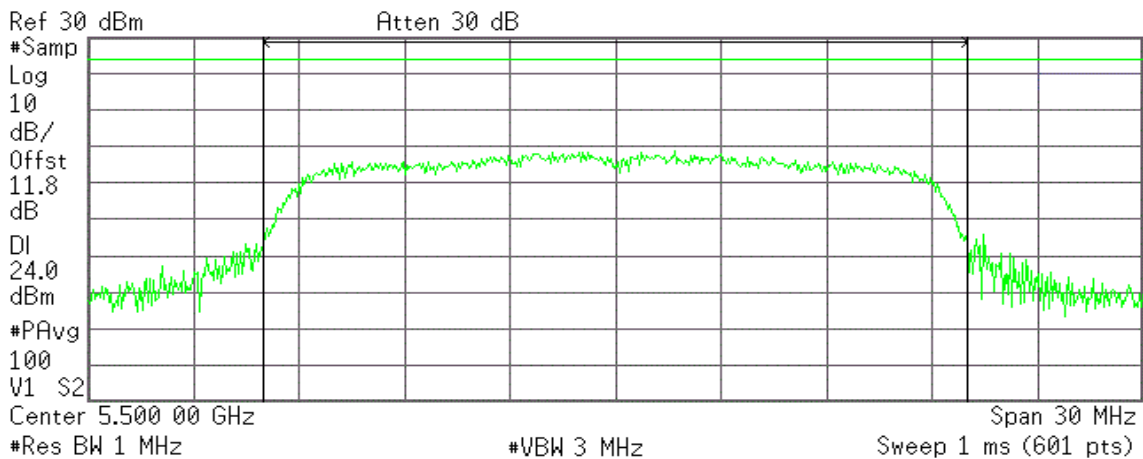

Channel Power

7.98 dBm /20.0000 MHz

Power Spectral Density

-65.03 dBm/Hz



CH Mid

Agilent 20:01:13 Oct 30, 2012

R T

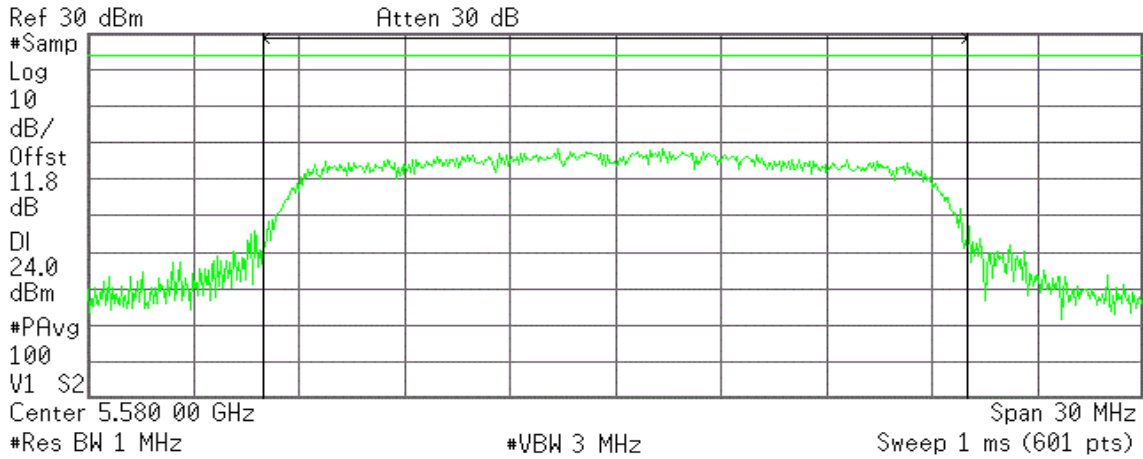

Channel Power

6.82 dBm /20.0000 MHz

Power Spectral Density

-66.19 dBm/Hz

CH High

Agilent 20:04:17 Oct 30, 2012

R T

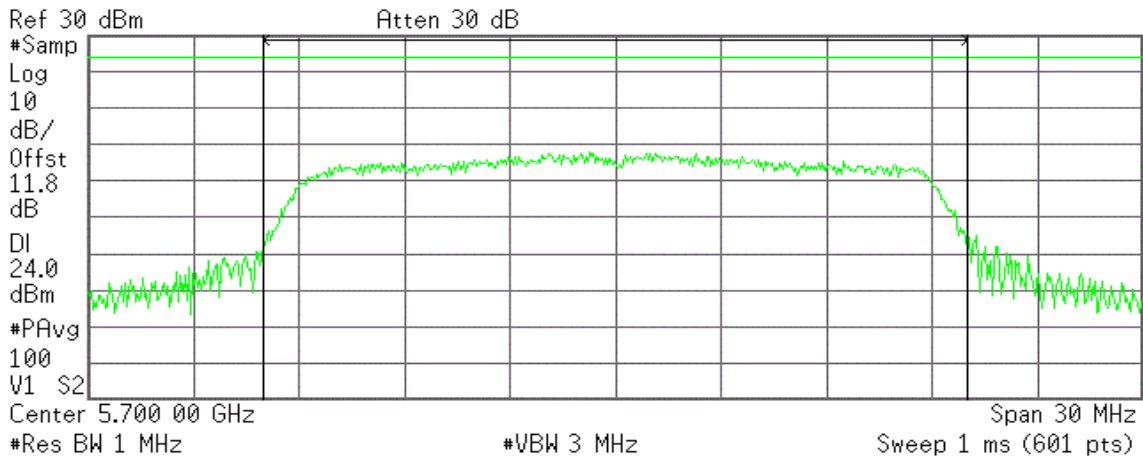

Channel Power

7.27 dBm /20.0000 MHz

Power Spectral Density

-65.74 dBm/Hz



7.3 BAND EDGES MEASUREMENT

LIMIT

According to §15.407(b),

(1) The provisions of Section 15.205 of this part apply to intentional radiators operating under this section.

(2) When measuring the emission limits, the nominal carrier frequency shall be adjusted as close to the upper and lower frequency block edges as the design of the equipment permits.

Test Configuration

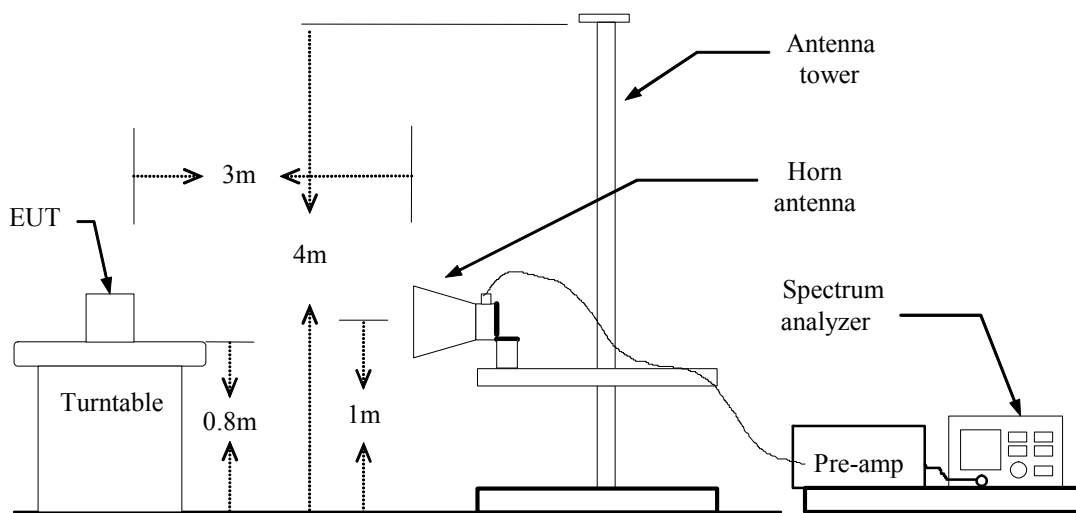

TEST PROCEDURE

1. The EUT is placed on a turntable, which is 0.8m above the ground plane.
2. The turntable shall be rotated for 360 degrees to determine the position of maximum emission level.
3. EUT is set 3m away from the receiving antenna, which is varied from 1m to 4m to find out the highest emission.
4. Set the spectrum analyzer in the following setting in order to capture the lower and upper band-edges of the emission:
 - (a) PEAK: RBW=VBW=1MHz / Sweep=AUTO
 - (b) AVERAGE: RBW=1MHz / VBW=10Hz / Sweep=AUTO
5. Repeat the procedures until all the PEAK and AVERAGE versus POLARIZATION are measured.

TEST RESULTS

Refer to attach spectrum analyzer data chart.

802.11a Mode

1. Operating Frequency: 5500-5700MHz
2. CH Low: 5500MHz, CH High: 5700MHz
3. 26dB bandwidth: CH Low: 19.894MHz, CH High: 19.257MHz

Because the mentioned conditions, the test is not applicable.



Band Edges (IEEE 802.11a mode / 5180 MHz)

Detector mode: Peak

Polarity: Vertical

Agilent 12:01:46 16 Oct 2012

R T

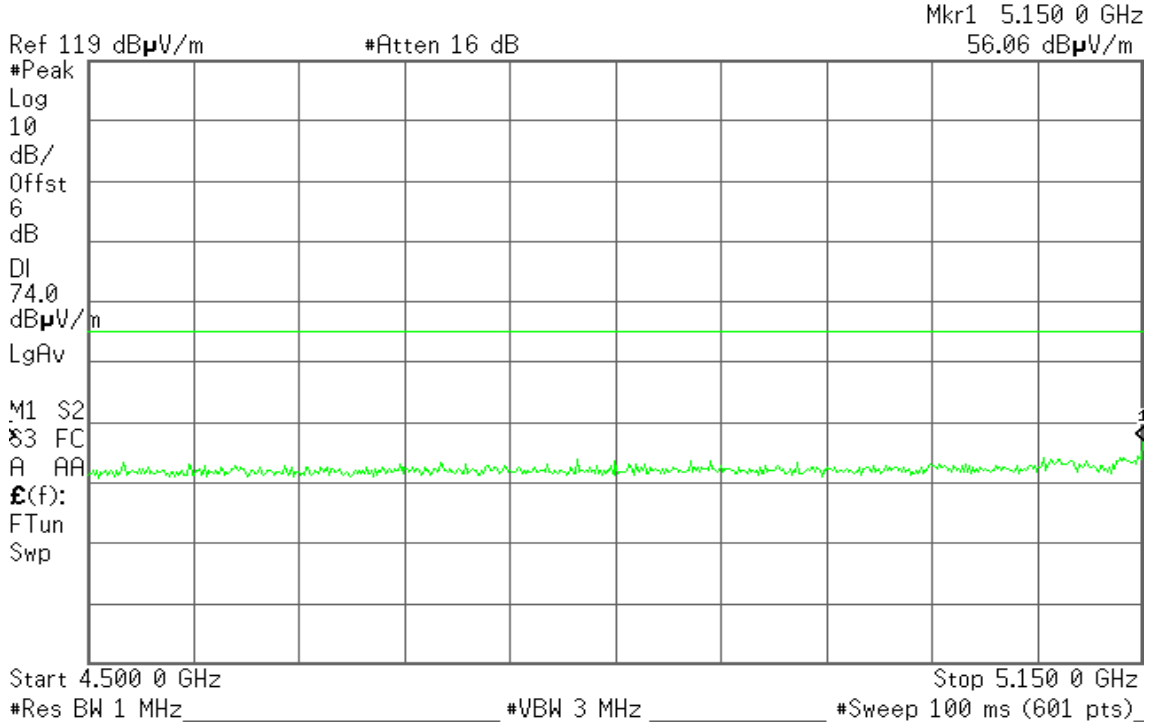

Detector mode: Average

Polarity: Vertical

Agilent 12:02:09 16 Oct 2012

R T

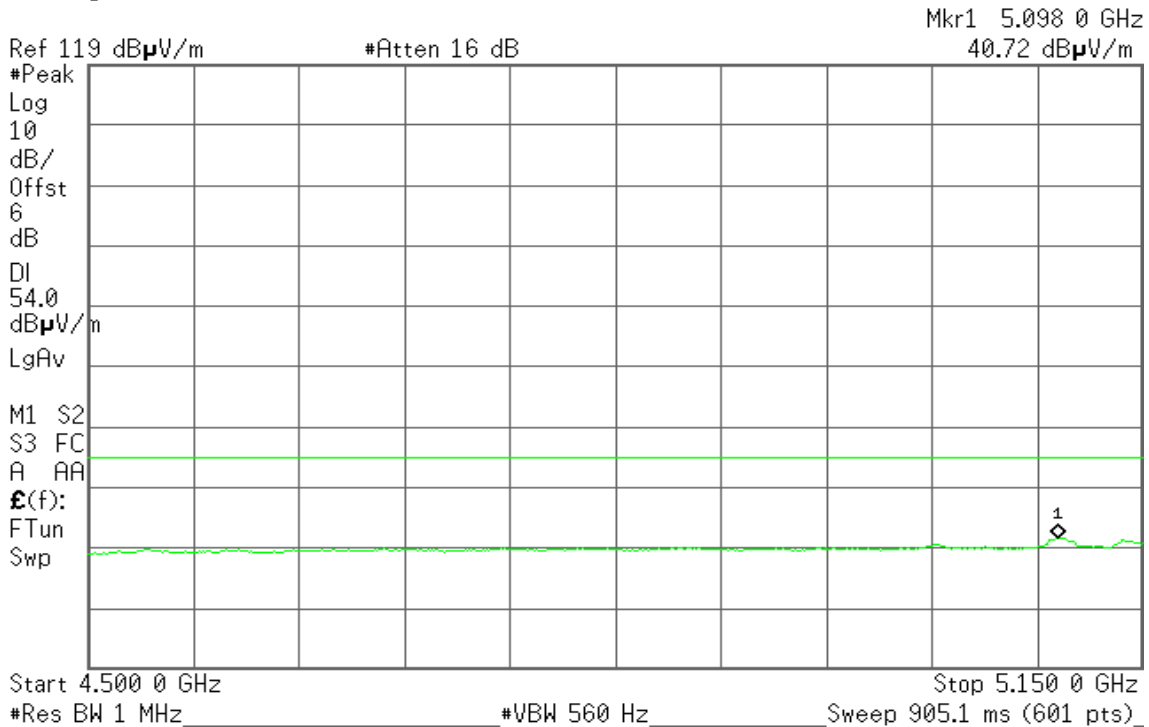



Detector mode: Peak

Polarity: Horizontal

* Agilent 11:56:00 16 Oct 2012

R T

Mkr1 5.150 0 GHz
67.55 dB μ V/m

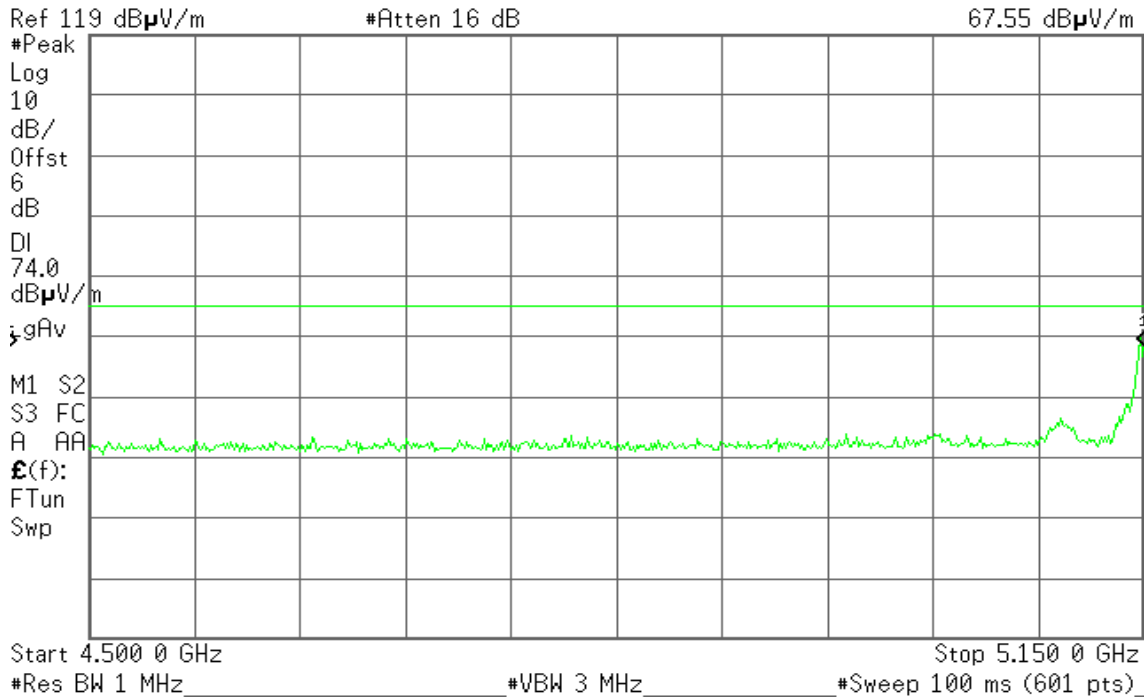

Detector mode: Average

Polarity: Horizontal

* Agilent 11:57:24 16 Oct 2012

R T

Mkr1 5.150 0 GHz
45.81 dB μ V/m

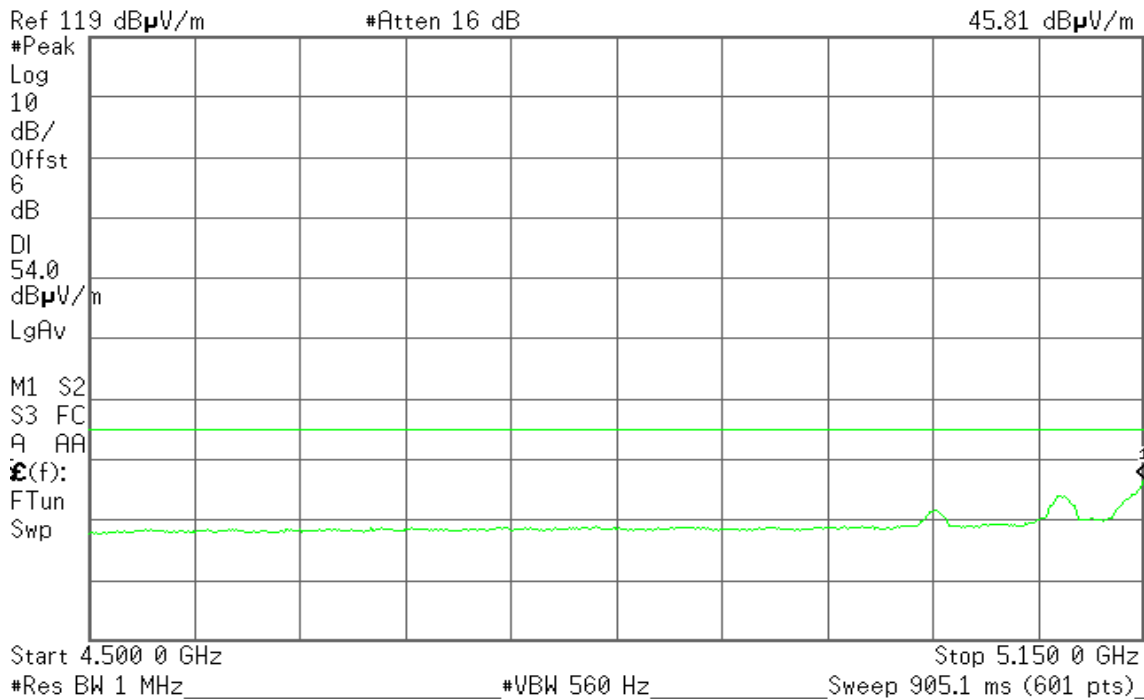



Band Edges (IEEE 802.11a mode / 5320 MHz)

Detector mode: Peak

Polarity: Vertical

Agilent 13:34:09 16 Oct 2012

R T

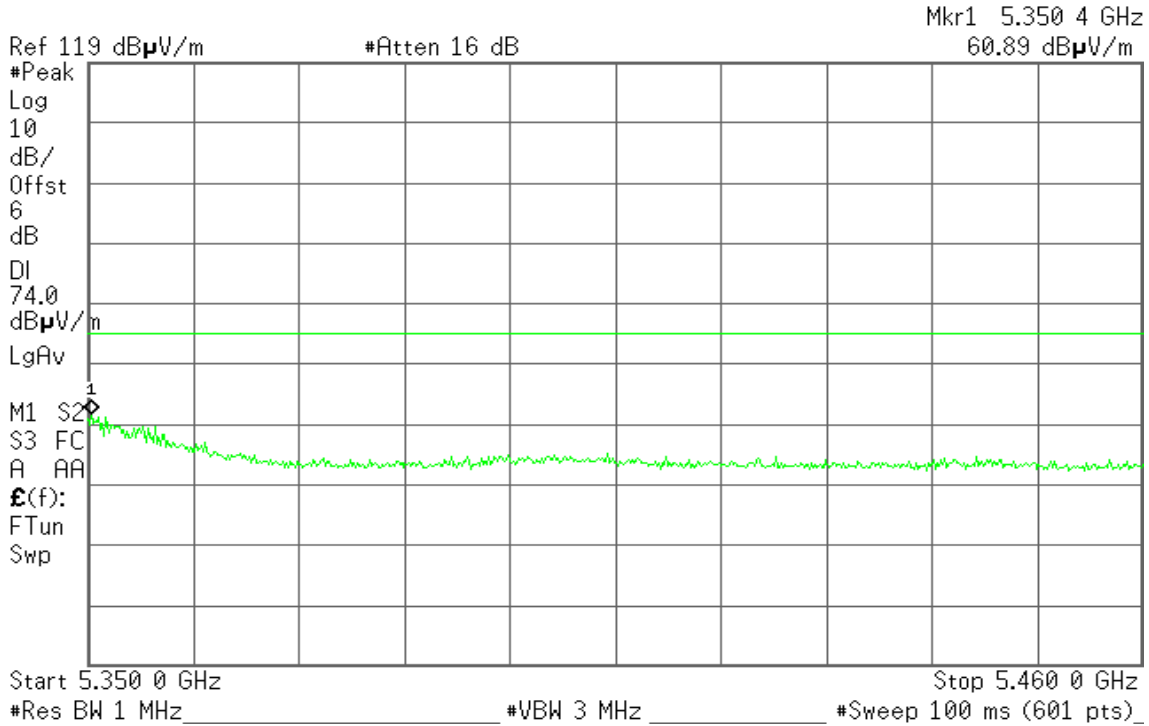

Detector mode: Average

Polarity: Vertical

Agilent 13:34:34 16 Oct 2012

R T

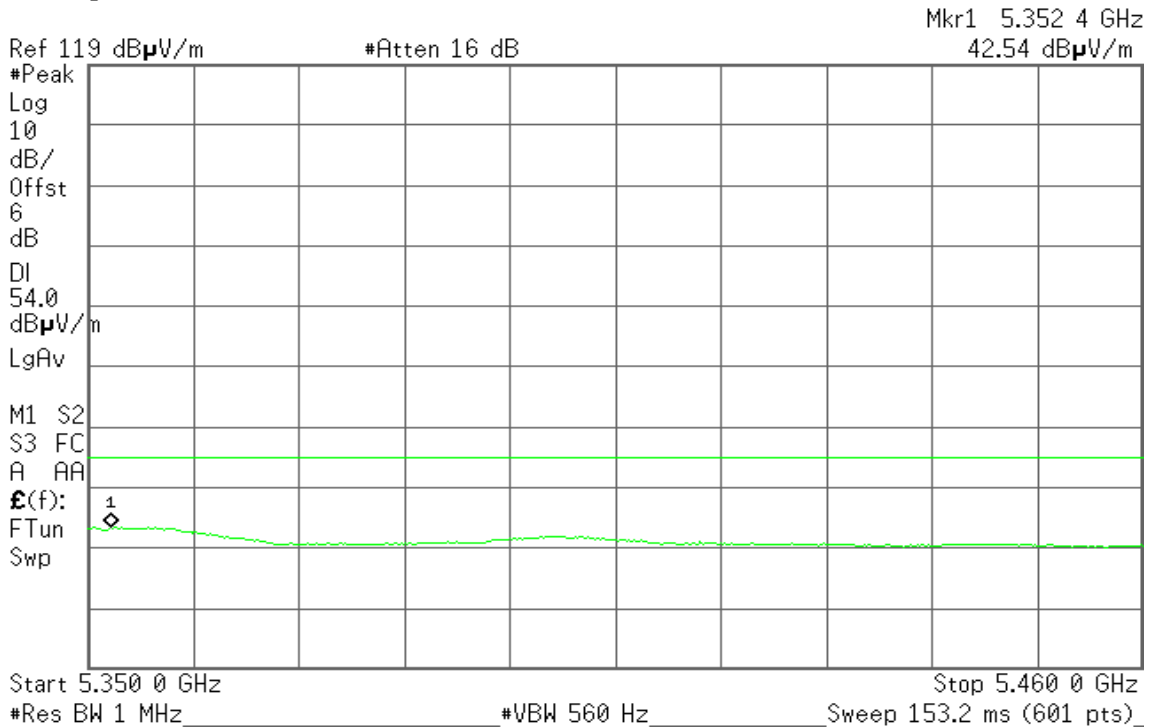



Detector mode: Peak

Polarity: Horizontal

Agilent 13:27:11 16 Oct 2012

R T

Mkr1 5.3516 GHz
59.94 dB μ V/m

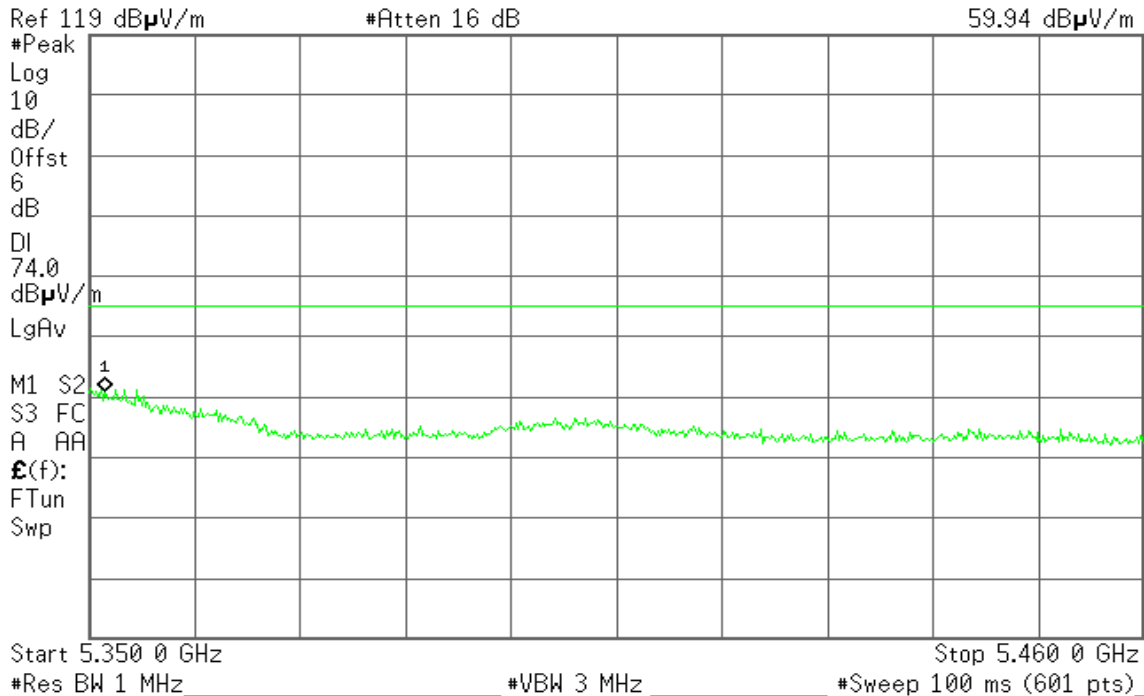

Detector mode: Average

Polarity: Horizontal

Agilent 13:27:35 16 Oct 2012

R T

Mkr1 5.3529 GHz
44.08 dB μ V/m

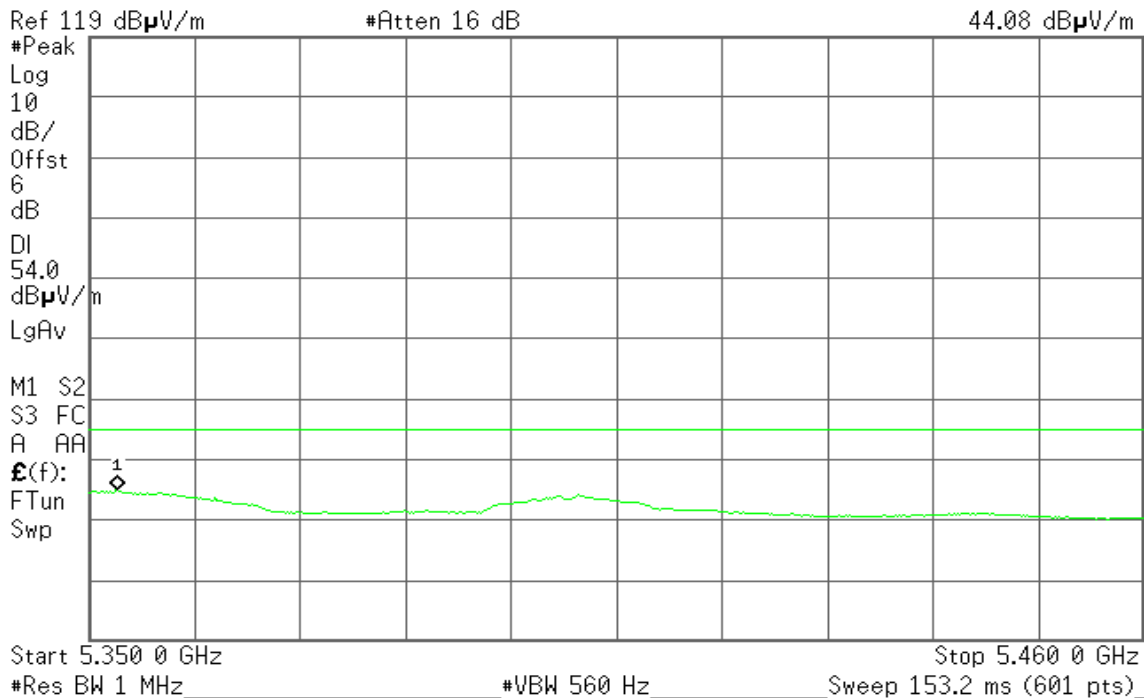



Band Edges (IEEE 802.11n HT 20 MHz mode / 5180 MHz)

Detector mode: Peak

Polarity: Vertical

Agilent 15:13:02 16 Oct 2012

R T

Mkr1 5.146 8 GHz
55.07 dB μ V/m

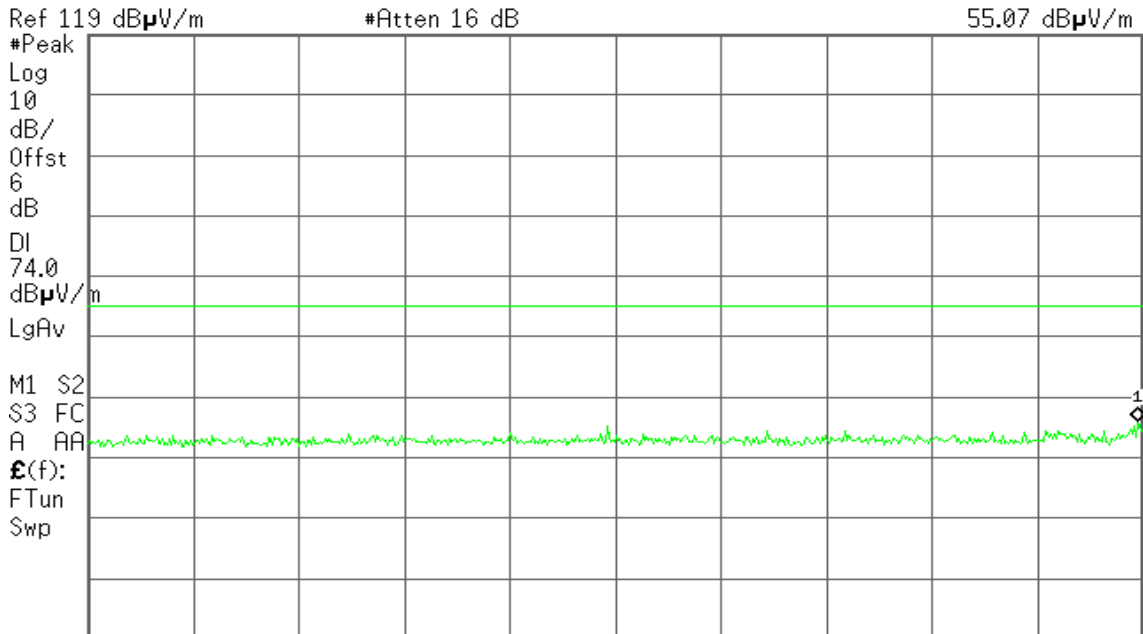

Start 4.500 0 GHz Stop 5.150 0 GHz
#Res BW 1 MHz #VBW 3 MHz #Sweep 100 ms (601 pts)

Detector mode: Average

Polarity: Vertical

Agilent 15:13:56 16 Oct 2012

R T

Mkr1 5.146 8 GHz
40.01 dB μ V/m

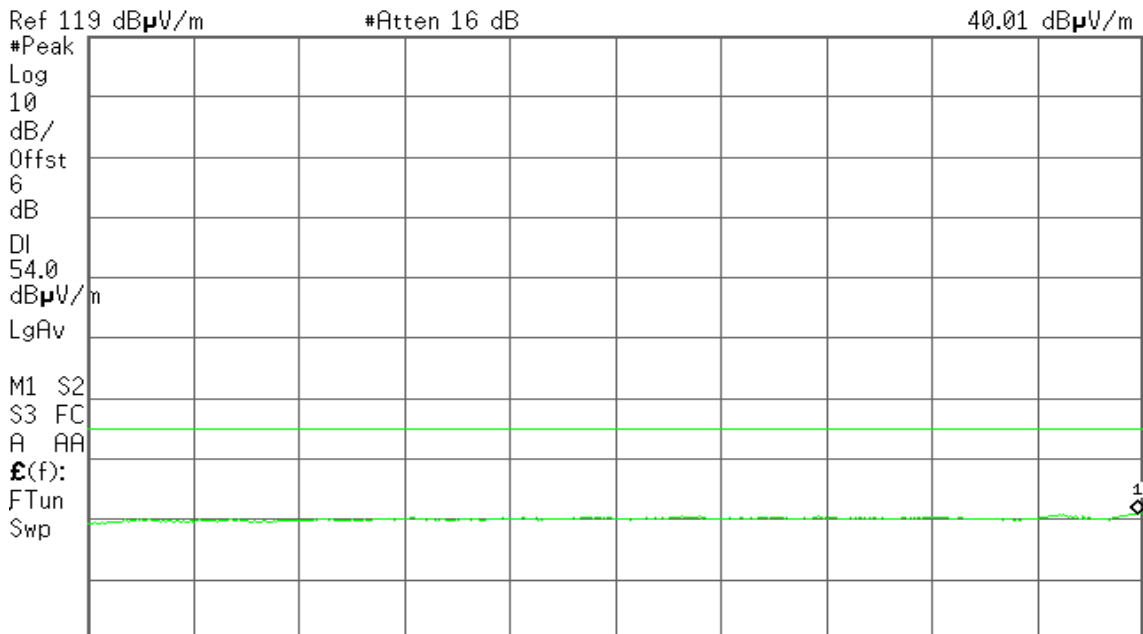

Start 4.500 0 GHz Stop 5.150 0 GHz
#Res BW 1 MHz #VBW 560 Hz Sweep 905.1 ms (601 pts)



Detector mode: Peak

Polarity: Horizontal

Agilent 15:21:14 16 Oct 2012

R T

Mkr1 5.146 8 GHz
67.35 dB μ V/m

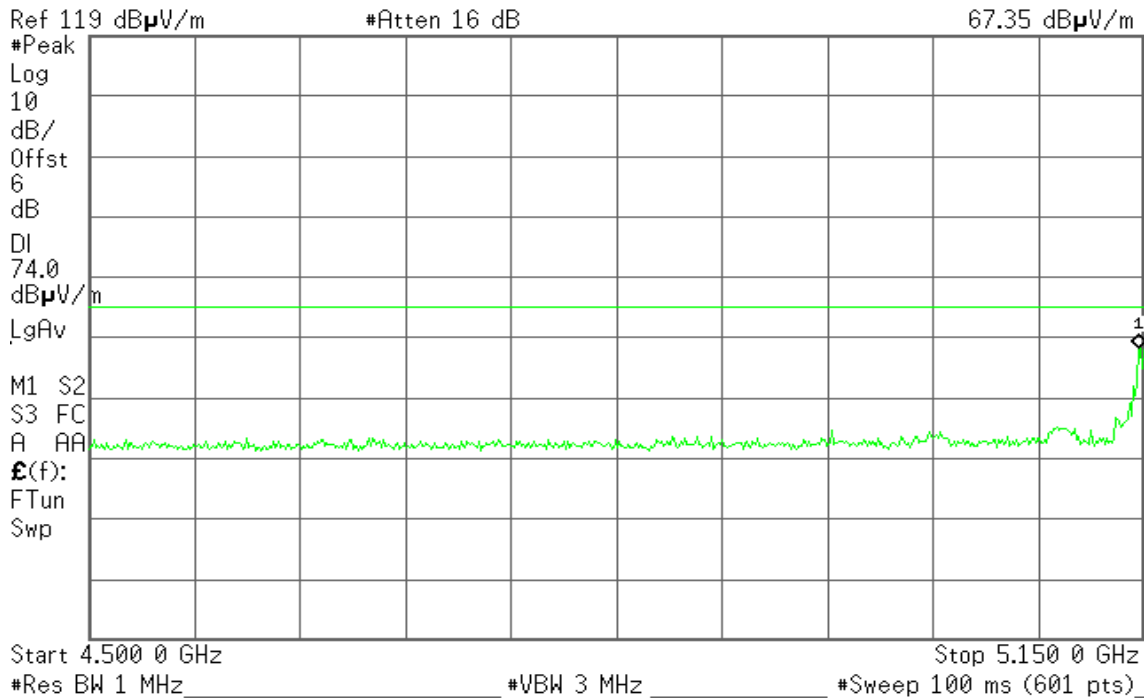

Detector mode: Average

Polarity: Horizontal

Agilent 15:21:45 16 Oct 2012

R T

Mkr1 5.150 0 GHz
44.71 dB μ V/m

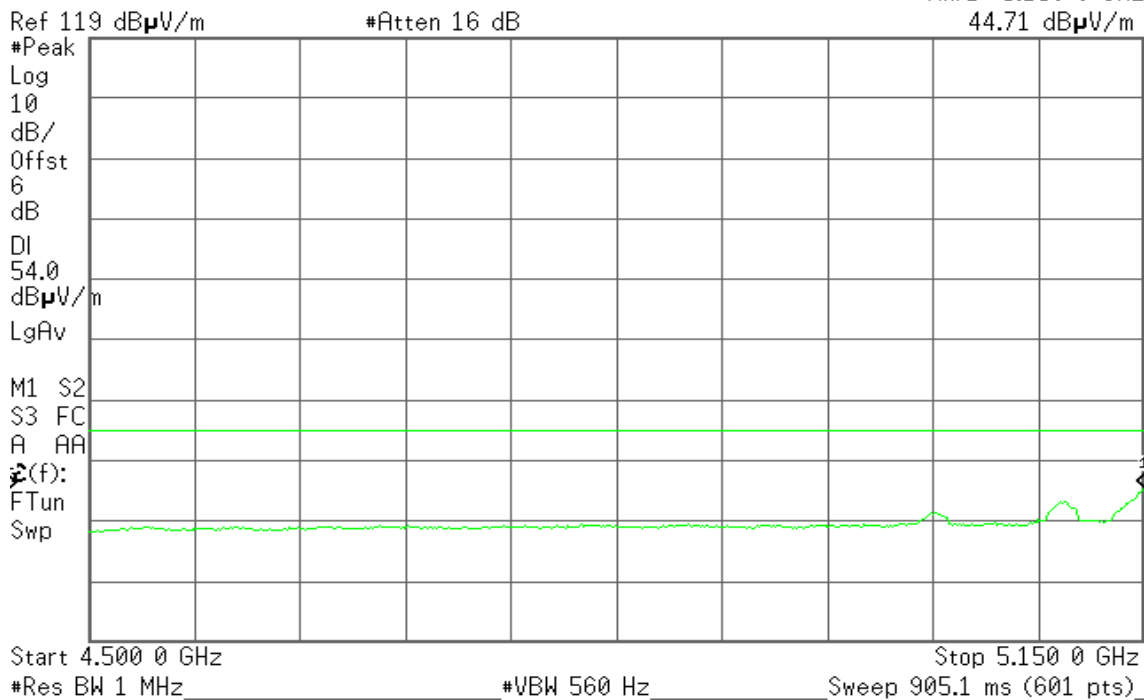



Band Edges (IEEE 802.11n HT 20 MHz mode / 5320 MHz)

Detector mode: Peak

Polarity: Vertical

Agilent 16:48:39 16 Oct 2012

R T

Mkr1 5.352 4 GHz
62.44 dB μ V/m

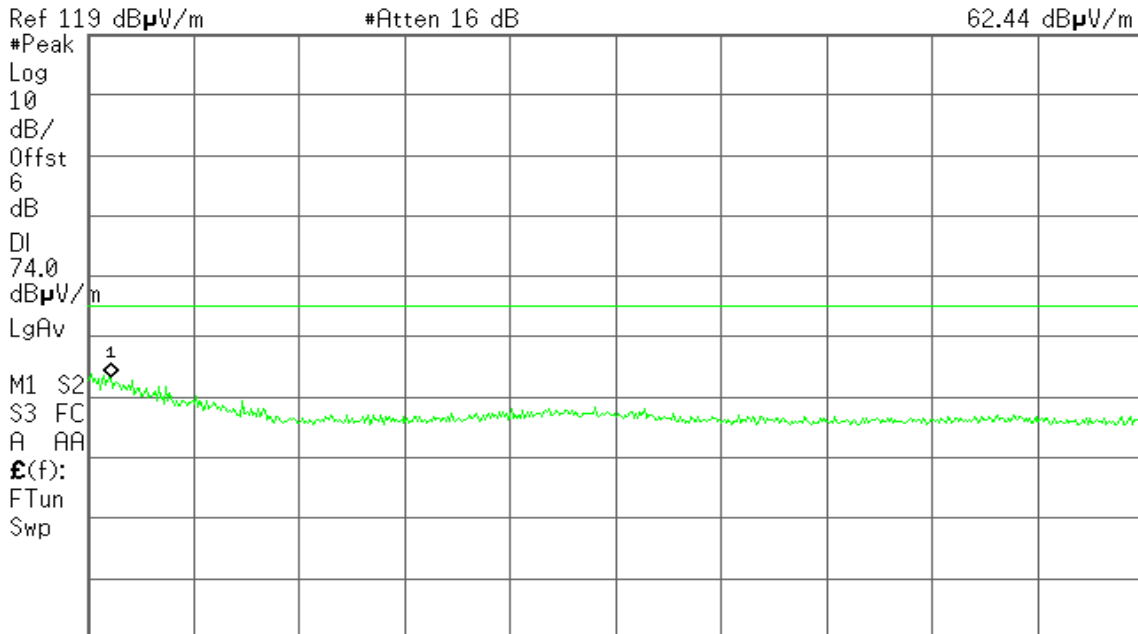

Start 5.350 0 GHz Stop 5.460 0 GHz
#Res BW 3 MHz #VBW 3 MHz #Sweep 100 ms (601 pts)

Detector mode: Average

Polarity: Vertical

Agilent 16:49:34 16 Oct 2012

R T

Mkr1 5.352 4 GHz
46.20 dB μ V/m

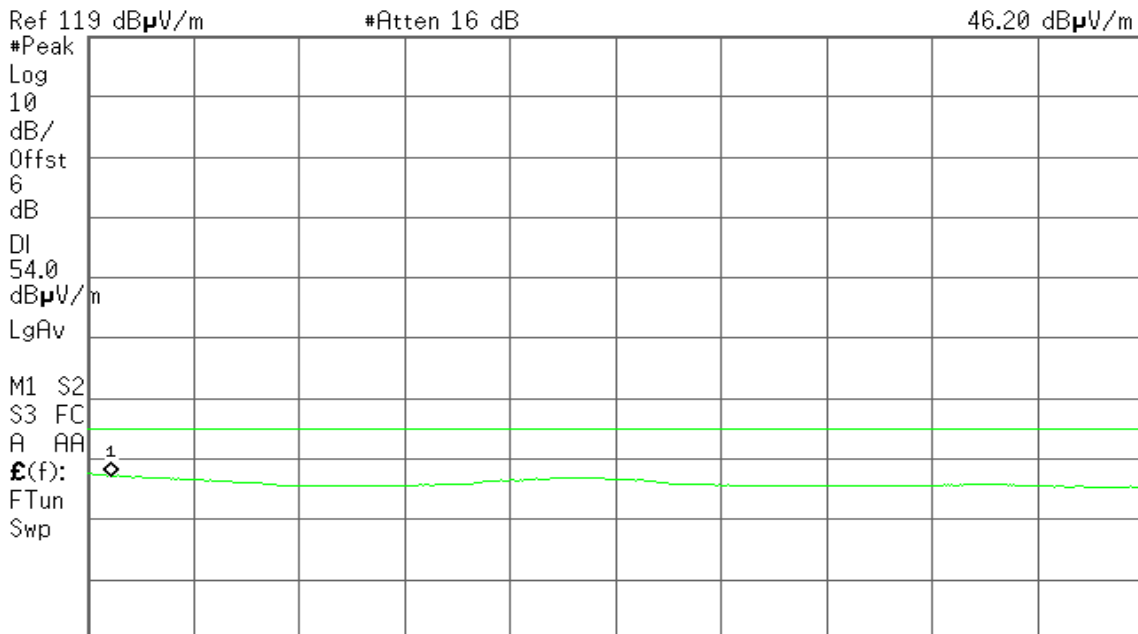

Start 5.350 0 GHz Stop 5.460 0 GHz
#Res BW 3 MHz #VBW 560 Hz Sweep 51.08 ms (601 pts)



Detector mode: Peak

Polarity: Horizontal

Agilent 16:42:30 16 Oct 2012

R T

Mkr1 5.350 2 GHz
59.74 dBµV/m

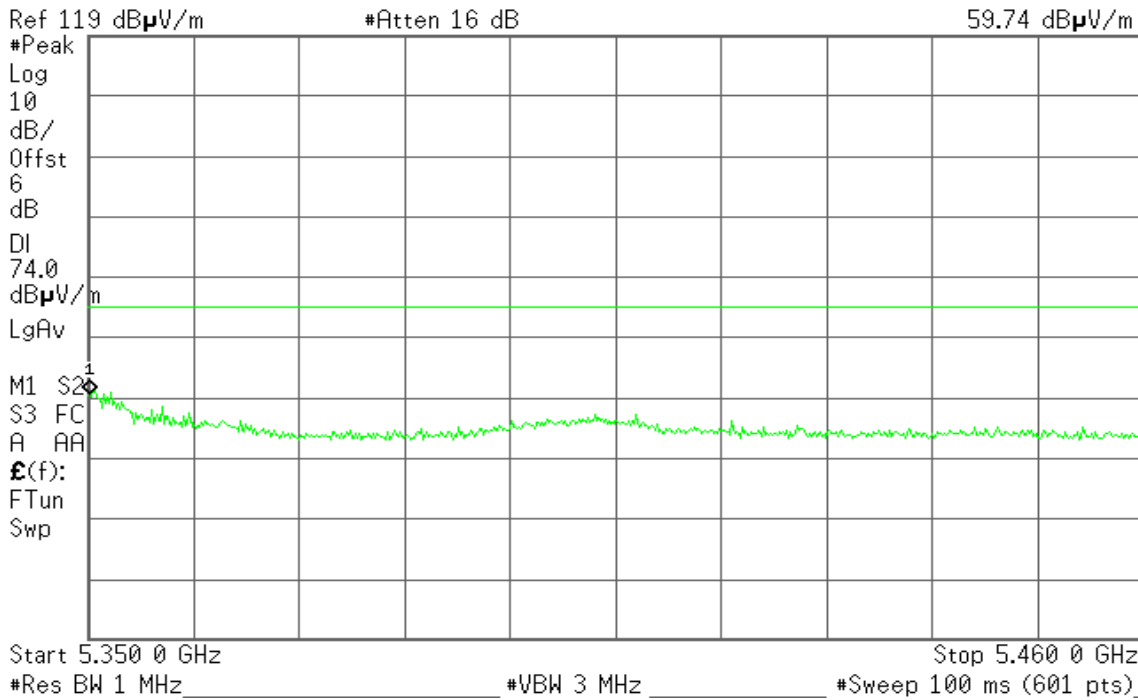

Detector mode: Average

Polarity: Horizontal

Agilent 16:43:15 16 Oct 2012

R T

Mkr1 5.399 3 GHz
42.93 dBµV/m

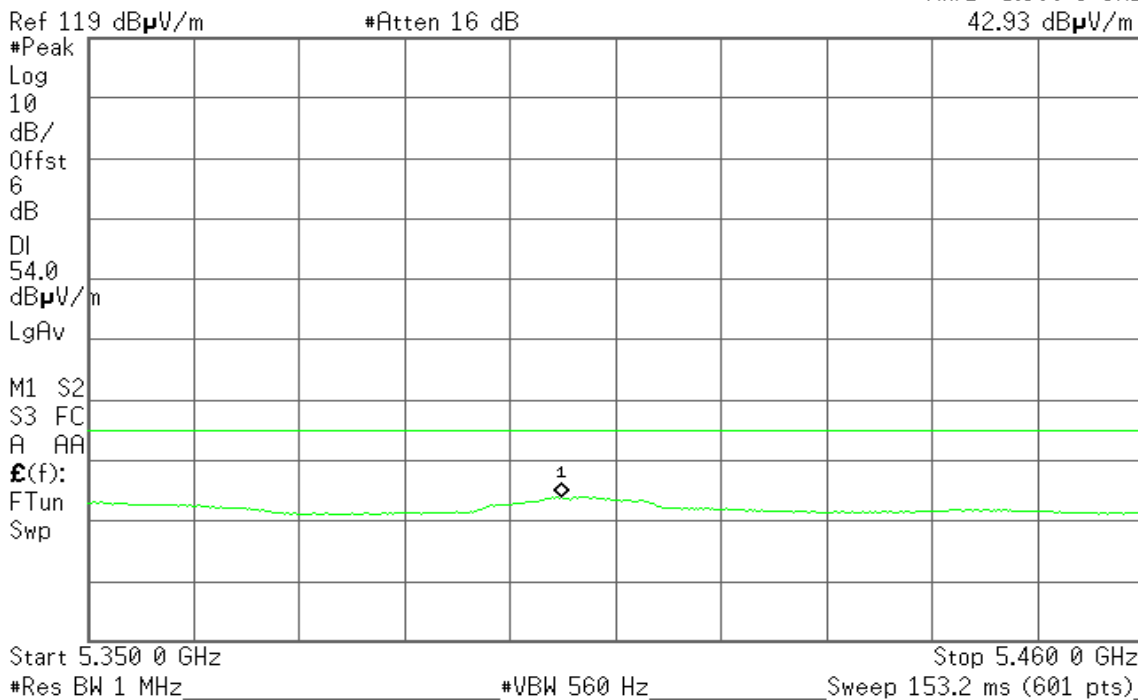



7.4 PEAK POWER SPECTRAL DENSITY

LIMIT

According to §15.407(a),

- (1) For the band 5.15-5.25 GHz, the peak power spectral density shall not exceed 4dBm in any 1MHz band.
- (2) For the band 5.25-5.35 GHz and 5.47-5.725 GHz bands, the peak power spectral density shall not exceed 11dBm in any 1MHz band.

If transmitting antennas of directional gain greater than 6dBi are used, both the peak transmit power and the peak power spectral density shall be reduced by the amount in dB that the directional gain of the antenna exceeds 6dBi.

Test Configuration

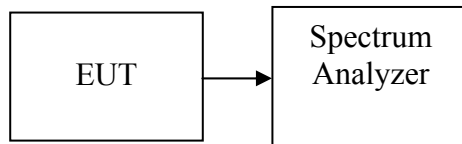

TEST PROCEDURE

1. Place the EUT on the table and set it in transmitting mode.
Remove the antenna from the EUT and then connect a low loss RF cable from the antenna port to the spectrum analyzer.
2. Set the spectrum analyzer as RBW = 1MHz, VBW = 3MHz, Span = Sweep= AUTO
3. Record the max. reading.
4. Repeat the above procedure until the measurements for all frequencies are completed

TEST RESULTS

No non-compliance noted

**Test Data****Test mode: IEEE 802.11a mode / 5180 ~ 5240MHz**

Channel	Frequency (MHz)	PPSD (dBm)	Limit (dBm)	Margin	Result
Low	5180	2.390	4.00	-1.61	PASS
Mid	5220	2.837	4.00	-1.163	PASS
High	5240	2.564	4.00	-1.436	PASS

Test mode: IEEE 802.11n HT 20 MHz mode / 5180 ~ 5240MHz

Channel	Frequency (MHz)	PPSD (dBm)	Limit (dBm)	Margin	Result
Low	5180	1.603	4.00	-2.397	PASS
Mid	5220	1.447	4.00	-2.553	PASS
High	5240	1.401	4.00	-2.599	PASS

Test mode: IEEE 802.11a mode/ 5260 ~ 5320MHz

Channel	Frequency (MHz)	PPSD (dBm)	Limit (dBm)	Margin	Result
Low	5260	2.748	11.00	-8.252	PASS
Mid	5280	3.643	11.00	-7.357	PASS
High	5320	2.855	11.00	-8.145	PASS

Test mode: IEEE 802.11n HT 20 MHz mode / 5260 ~ 5320MHz

Channel	Frequency (MHz)	PPSD (dBm)	Limit (dBm)	Margin	Result
Low	5260	2.616	11.00	-8.384	PASS
Mid	5280	2.253	11.00	-8.747	PASS
High	5320	1.996	11.00	-9.004	PASS

Test mode: IEEE 802.11a mode / 5500 ~ 5700MHz

Channel	Frequency (MHz)	PPSD (dBm)	Limit (dBm)	Margin	Result
Low	5500	0.316	11.00	-10.684	PASS
Mid	5580	-0.398	11.00	-11.398	PASS
High	5700	-4.497	11.00	-15.497	PASS

Test mode: IEEE 802.11n HT 20 MHz mode / 5500 ~ 5700MHz

Channel	Frequency (MHz)	PPSD (dBm)	Limit (dBm)	Margin	Result
Low	5500	-1.299	11.00	-12.299	PASS
Mid	5580	-1.747	11.00	-12.747	PASS
High	5700	1.815	11.00	-9.185	PASS



Test Plot

IEEE 802.11a mode / 5180 ~ 5240MHz

CH Low

Agilent 14:09:45 Oct 31, 2012

R T

Mkr1 5.181 20GHz
2.390 dBm

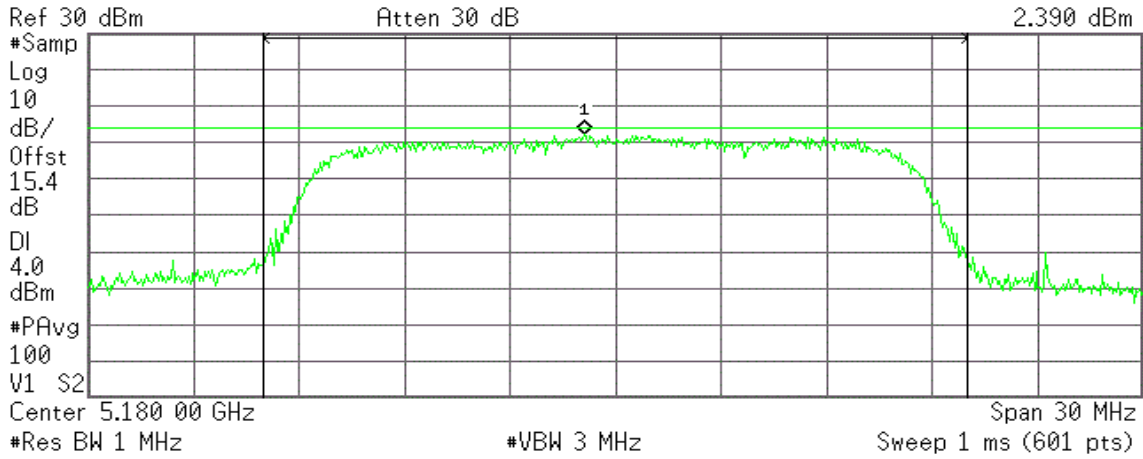

Channel Power

11.48 dBm /20.0000 MHz

Power Spectral Density

-61.53 dBm/Hz

CH Mid

Agilent 15:55:33 Oct 31, 2012

R T

Mkr1 5.221 45 GHz
2.837 dBm

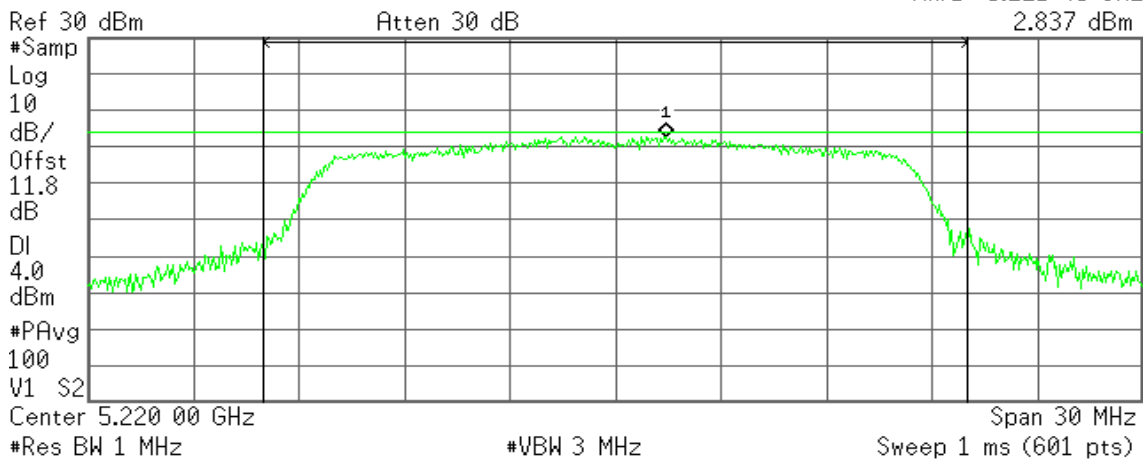

Channel Power

11.98 dBm /20.0000 MHz

Power Spectral Density

-61.03 dBm/Hz



CH High

Agilent 15:58:47 Oct 31, 2012

R T

Mkr1 5.241 55 GHz
2.564 dBm

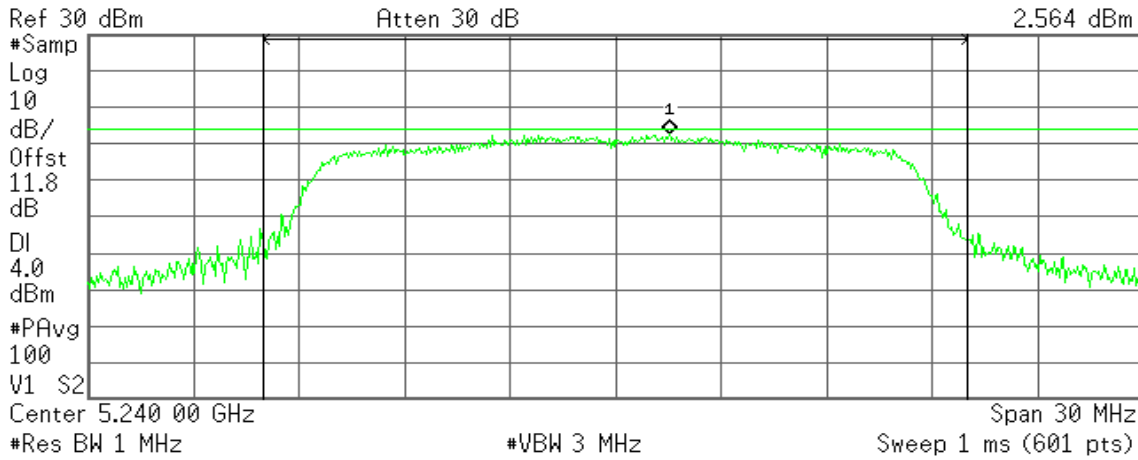

Channel Power

11.96 dBm /20.0000 MHz

Power Spectral Density

-61.05 dBm/Hz

IEEE 802.11n HT 20 MHz mode / 5180 ~ 5240MHz

CH Low

Agilent 17:10:53 Oct 31, 2012

R T

Mkr1 5.181 50 GHz
1.603 dBm

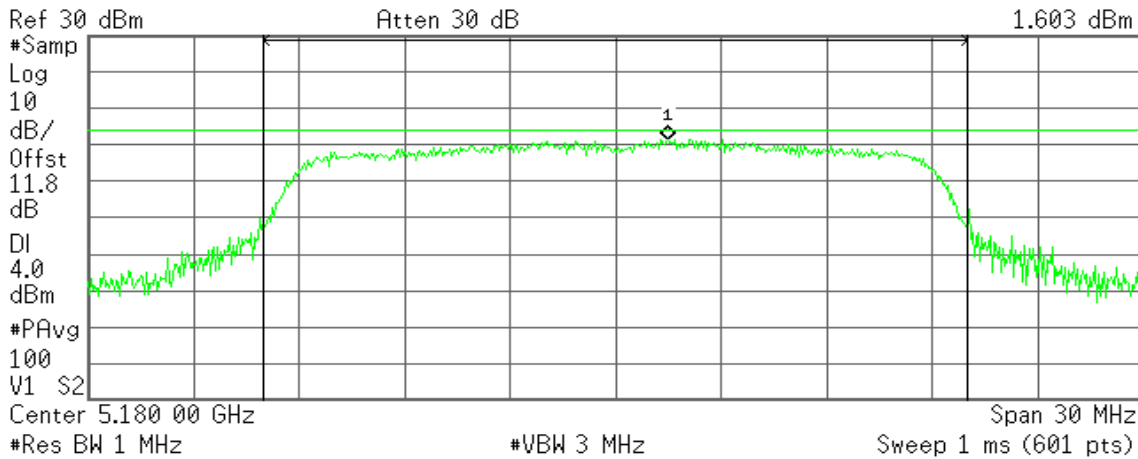

Channel Power

10.94 dBm /20.0000 MHz

Power Spectral Density

-62.07 dBm/Hz



CH Mid

Agilent 17:15:32 Oct 31, 2012

R T

Mkr1 5.217 95 GHz
1.447 dBm

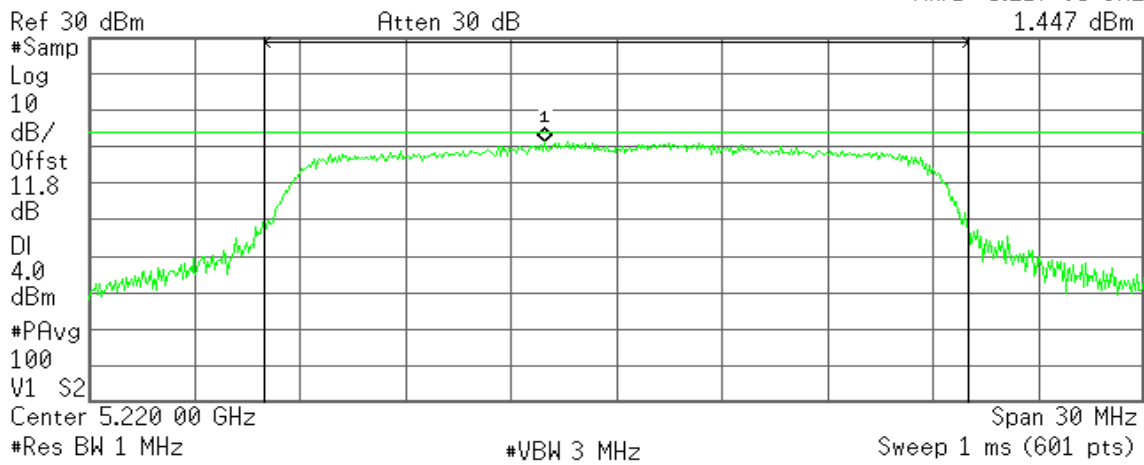

Channel Power

10.59 dBm /20.0000 MHz

Power Spectral Density

-62.42 dBm/Hz

CH High

Agilent 17:20:10 Oct 31, 2012

R T

Mkr1 5.241 60 GHz
1.401 dBm

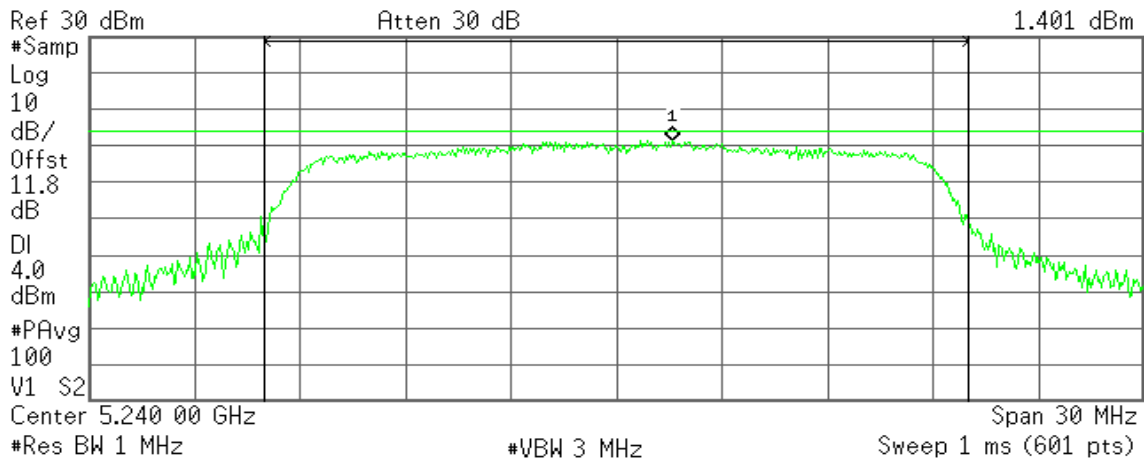

Channel Power

11.40 dBm /20.0000 MHz

Power Spectral Density

-61.61 dBm/Hz



IEEE 802.11a mode / 5260 ~ 5320MHz

CH Low

Agilent 14:20:26 Oct 30, 2012

R T

Mkr1 5.259 10 GHz
2.748 dBm

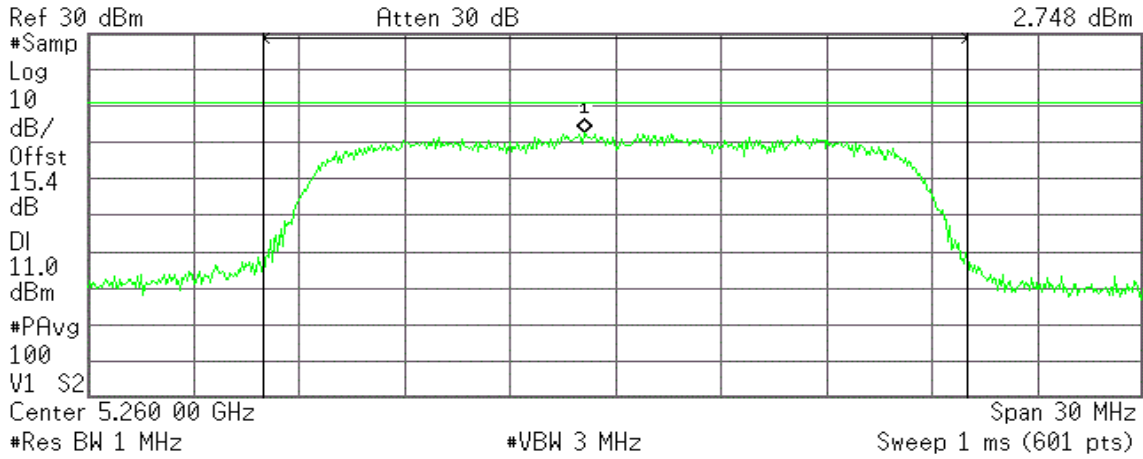

Channel Power

11.87 dBm /20.0000 MHz

Power Spectral Density

-61.14 dBm/Hz

CH Mid

Agilent 19:26:28 Oct 30, 2012

R T

Mkr1 5.281 65 GHz
3.643 dBm

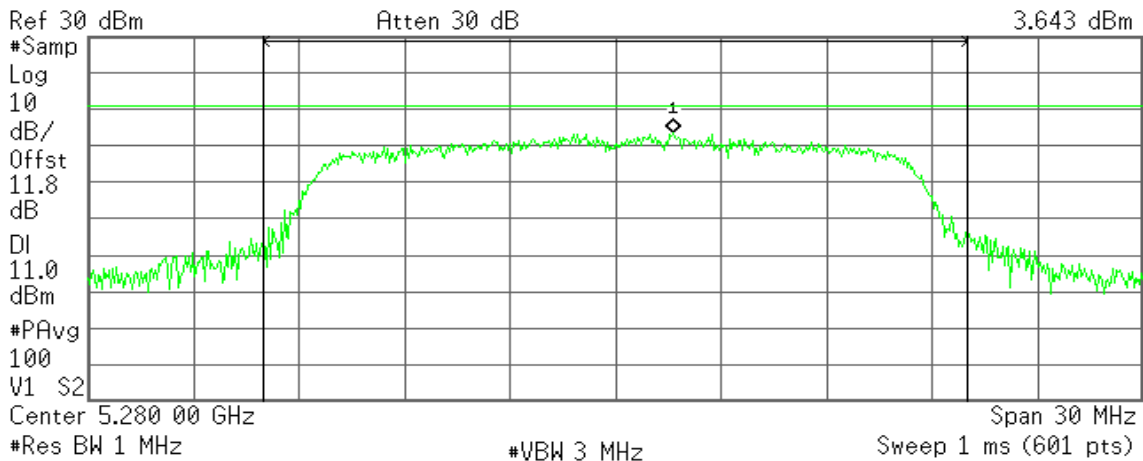

Channel Power

10.27 dBm /20.0000 MHz

Power Spectral Density

-62.74 dBm/Hz



CH High

Agilent 19:29:49 Oct 30, 2012

R T

Mkr1 5.321 05 GHz
2.855 dBm

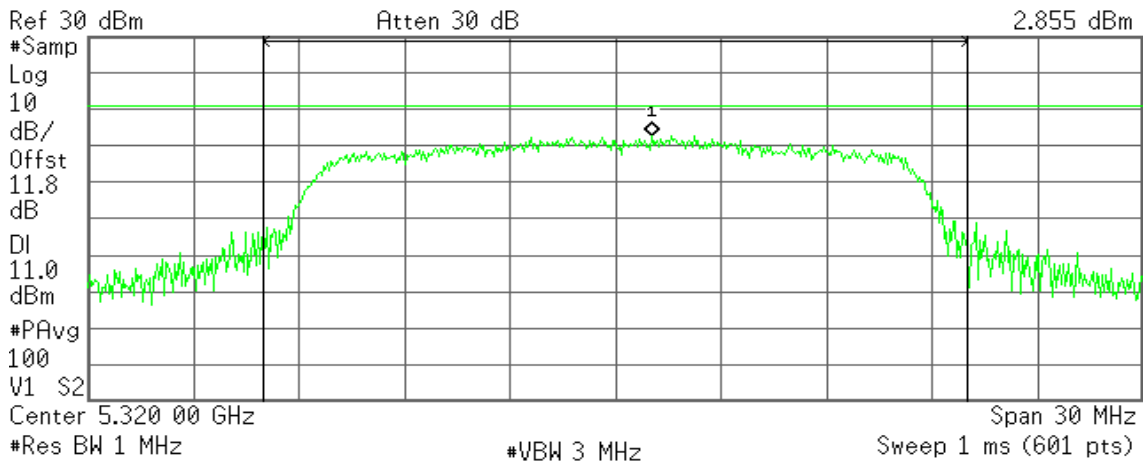

Channel Power

11.83 dBm /20.0000 MHz

Power Spectral Density

-61.18 dBm/Hz

IEEE 802.11n HT 20 MHz mode / 5260 ~ 5320MHz

CH Low

Agilent 19:47:13 Oct 30, 2012

R T

Mkr1 5.258 35 GHz
2.616 dBm

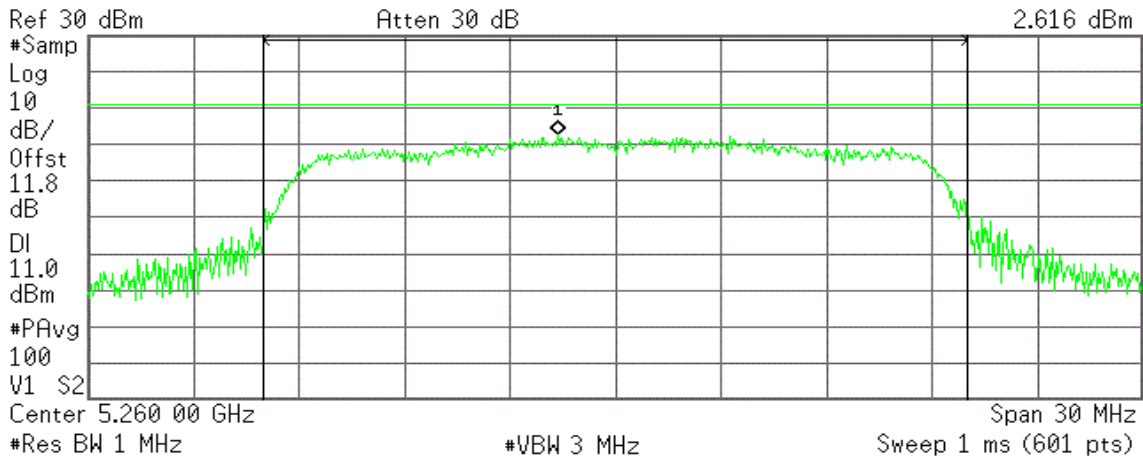

Channel Power

10.93 dBm /20.0000 MHz

Power Spectral Density

-62.09 dBm/Hz



CH Mid

Agilent 19:50:36 Oct 30, 2012

R T

Mkr1 5.279 10 GHz
2.253 dBm

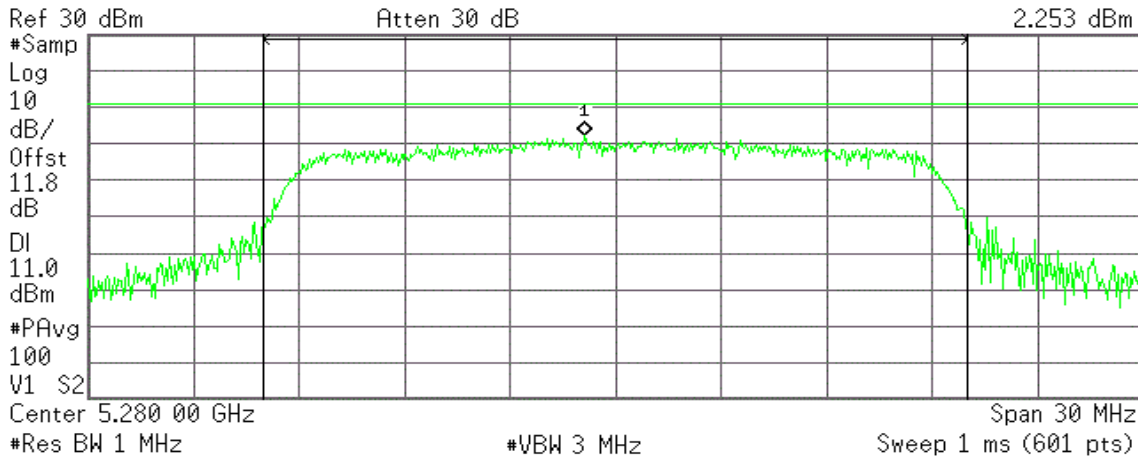

Channel Power

10.97 dBm /20.0000 MHz

Power Spectral Density

-62.04 dBm/Hz

CH High

Agilent 19:54:03 Oct 30, 2012

R T

Mkr1 5.320 55 GHz
1.996 dBm

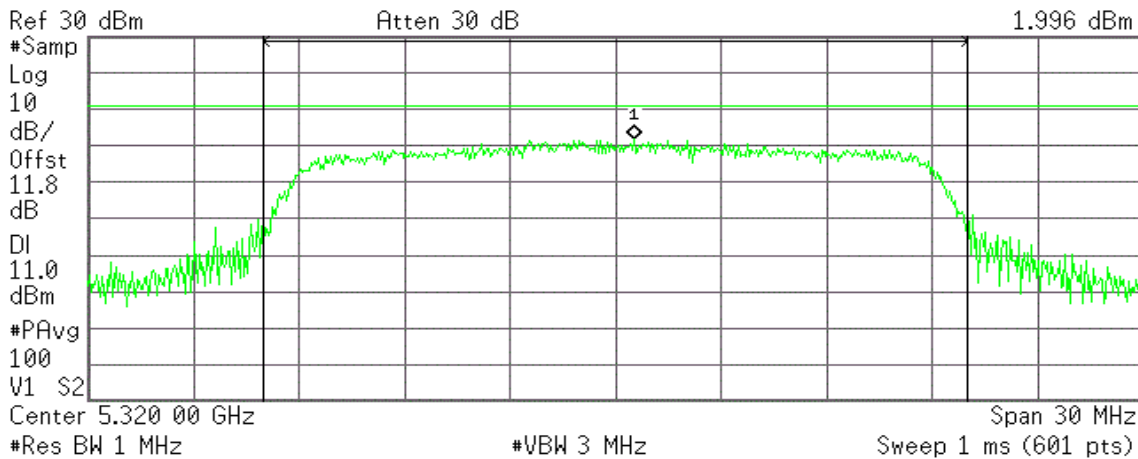

Channel Power

10.49 dBm /20.0000 MHz

Power Spectral Density

-62.52 dBm/Hz



Test mode: IEEE 802.11a mode / 5500 ~ 5700MHz

CH Low

Agilent 19:34:21 Oct 30, 2012

R T

Mkr1 5.499 40 GHz
0.316 dBm

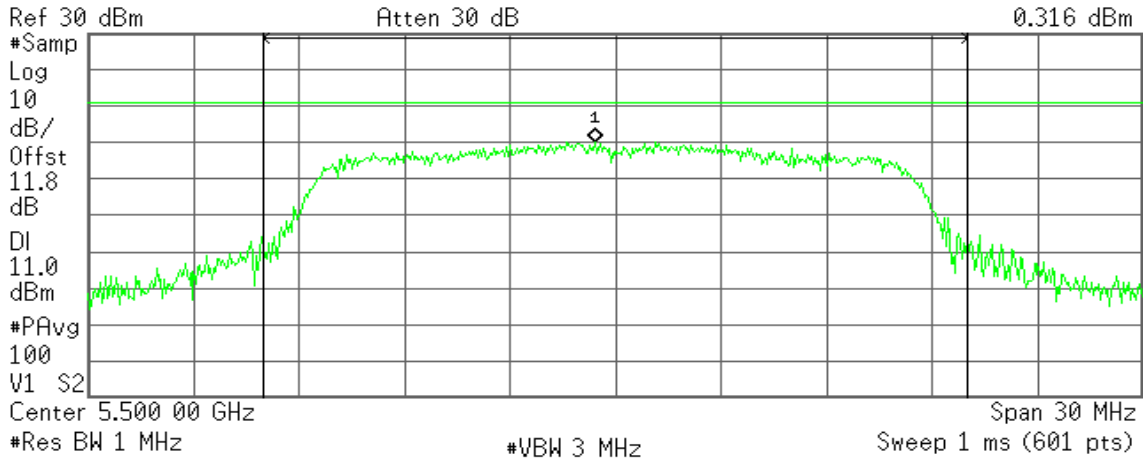

Channel Power

7.63 dBm /20.0000 MHz

Power Spectral Density

-65.38 dBm/Hz

CH Mid

Agilent 19:37:55 Oct 30, 2012

R T

Mkr1 5.580 85 GHz
-0.398 dBm

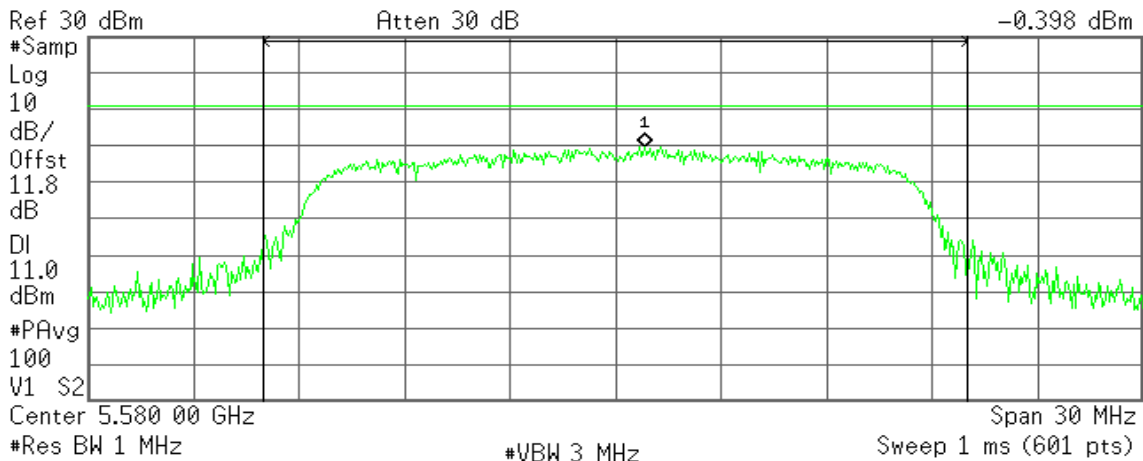

Channel Power

8.37 dBm /20.0000 MHz

Power Spectral Density

-64.64 dBm/Hz



CH High

Agilent 19:41:15 Oct 30, 2012

R T

Mkr1 5.699 25 GHz
-4.497 dBm

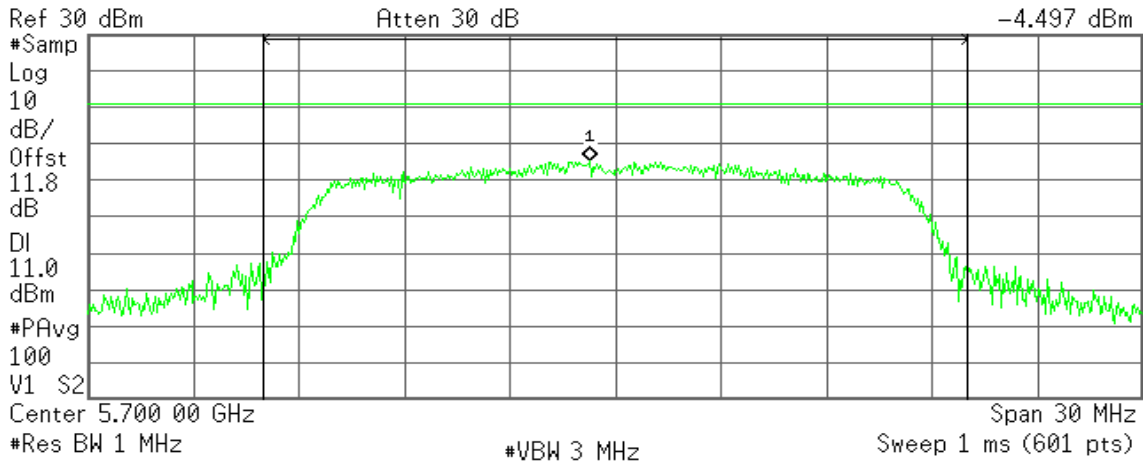

Channel Power

2.72 dBm /20.0000 MHz

Power Spectral Density

-70.29 dBm/Hz

IEEE 802.11n HT 20 MHz mode / 5500 ~ 5700MHz

CH Low

Agilent 19:58:26 Oct 30, 2012

R T

Mkr1 5.501 70 GHz
-1.299 dBm

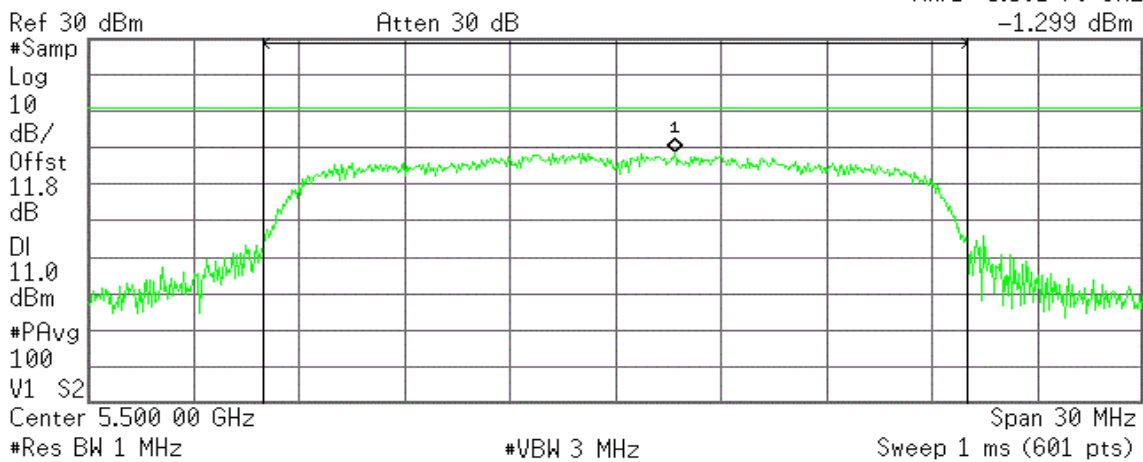

Channel Power

7.42 dBm /20.0000 MHz

Power Spectral Density

-65.59 dBm/Hz



CH Mid

Agilent 20:01:25 Oct 30, 2012

R T

Mkr1 5.578 35 GHz
-1.747 dBm

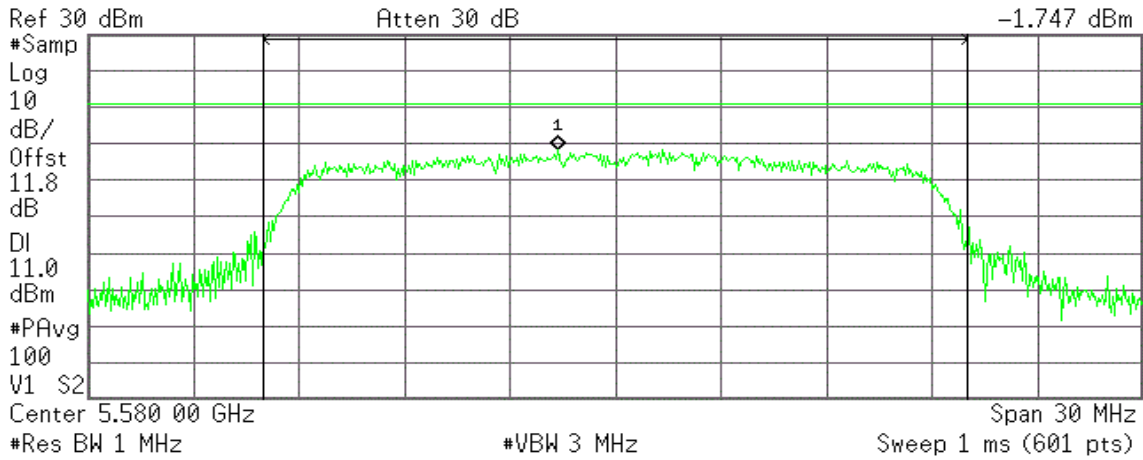

Channel Power

6.86 dBm /20.0000 MHz

Power Spectral Density

-66.15 dBm/Hz

CH High

Agilent 20:04:28 Oct 30, 2012

R T

Mkr1 5.699 25 GHz
-1.815 dBm

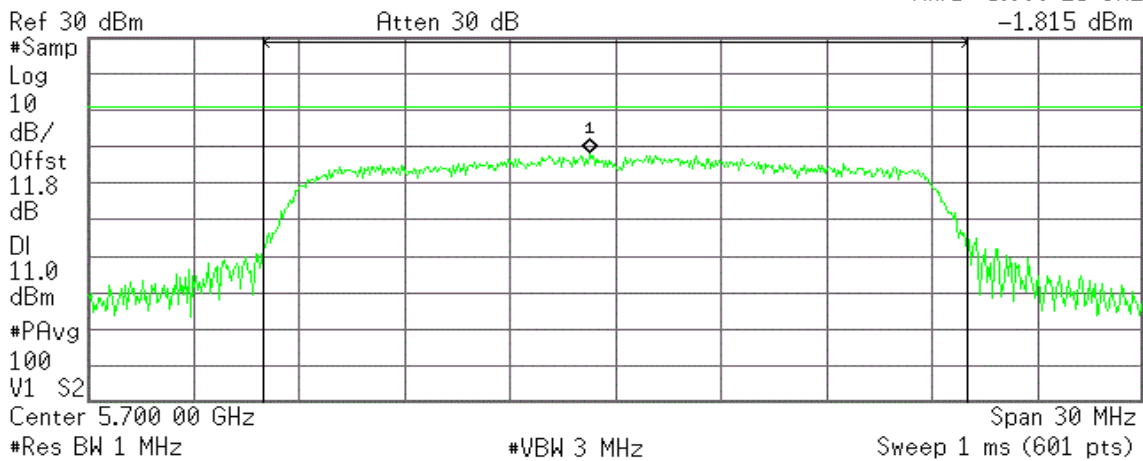

Channel Power

6.27 dBm /20.0000 MHz

Power Spectral Density

-66.74 dBm/Hz



7.5 PEAK EXCURSION

LIMIT

According to §15.407(a)(6), the ratio of the peak excursion of the modulation envelope (measured using a peak hold function) to the maximum conducted output power (measured as specified above) shall not exceed 13 dB across any 1 MHz bandwidth or the emission bandwidth whichever is less.

Test Configuration

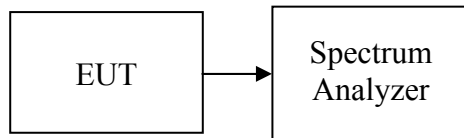

TEST PROCEDURE

The test is performed in accordance with KDB789033 D01 General UNII Test Procedures v01r02 .

1. Place the EUT on the table and set it in transmitting mode.
2. Remove the antenna from the EUT and then connect a low loss RF cable from the antenna port to spectrum.
3. Trace A, Set RBW =1MHz, VBW \geq 3 MHz. Set the spectrum analyzer span to view the entire emission bandwidth , Max. hold.
4. Delta Mark trace A Maximum frequency and trace B same frequency.
5. Repeat the above procedure until measurements for all frequencies were complete.

TEST RESULTS

No non-compliance noted

**Test Data****Test mode: IEEE 802.11a mode / 5180 ~ 5240MHz**

Channel	Frequency (MHz)	Peak Excursion (dB)	Limit (dB)	Margin (dB)	Result
Low	5180	9.12	13.00	-3.88	PASS
Mid	5220	10.01	13.00	-2.99	PASS
High	5240	12.00	13.00	-1.00	PASS

Test mode: IEEE 802.11n HT 20 MHz mode / 5180 ~ 5240MHz

Channel	Frequency (MHz)	Peak Excursion (dB)	Limit (dB)	Margin (dB)	Result
Low	5180	12.82	13.00	-0.18	PASS
Mid	5220	9.14	13.00	-3.86	PASS
High	5240	9.78	13.00	-3.22	PASS

Test mode: IEEE 802.11a mode / 5260 ~ 5320MHz

Channel	Frequency (MHz)	Peak Excursion (dB)	Limit (dB)	Margin (dB)	Result
Low	5260	11.59	13.00	-1.41	PASS
Mid	5280	9.78	13.00	-3.22	PASS
High	5320	8.06	13.00	-4.94	PASS

Test mode: IEEE 802.11n HT 20 MHz mode / 5260 ~ 5320MHz

Channel	Frequency (MHz)	Peak Excursion (dB)	Limit (dB)	Margin (dB)	Result
Low	5260	10.74	13.00	-2.26	PASS
Mid	5280	9.66	13.00	-3.34	PASS
High	5320	11.37	13.00	-1.63	PASS

Test mode: IEEE 802.11a mode / 5500 ~ 5700MHz

Channel	Frequency (MHz)	Peak Excursion (dB)	Limit (dB)	Margin (dB)	Result
Low	5500	9.78	13.00	-3.22	PASS
Mid	5580	8.95	13.00	-4.05	PASS
High	5700	12.14	13.00	-0.86	PASS

Test mode: IEEE 802.11n HT 20 MHz mode / 5500 ~ 5700MHz

Channel	Frequency (MHz)	Peak Excursion (dB)	Limit (dB)	Margin (dB)	Result
Low	5500	9.77	13.00	-3.23	PASS
Mid	5580	9.60	13.00	-3.40	PASS
High	5700	9.67	13.00	-3.33	PASS



Test Plot

IEEE 802.11a mode / 5180 ~ 5240MHz

CH Low

Agilent 15:52:28 Oct 31, 2012

R T

Mkr1 0 Hz
9.12 dB

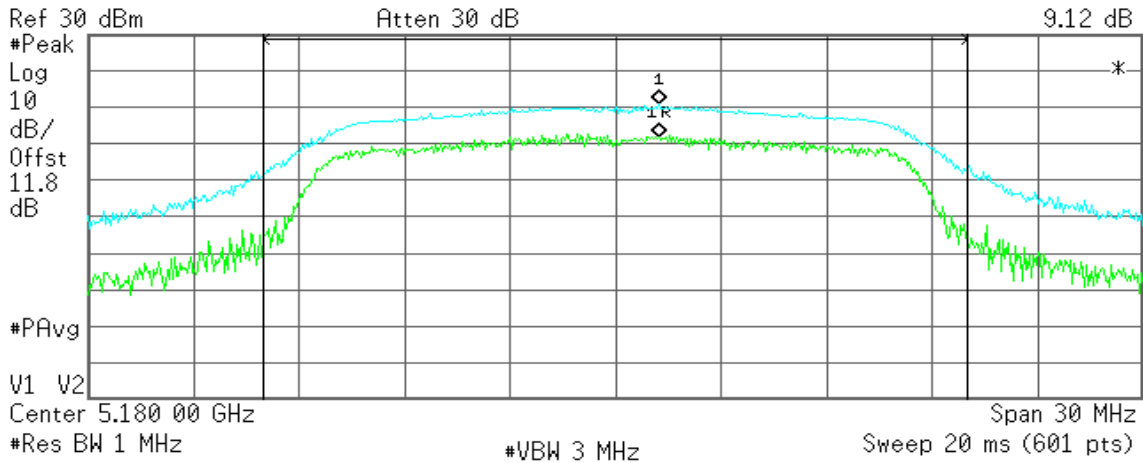

Channel Power

18.26 dBm /20.0000 MHz

Power Spectral Density

-54.75 dBm/Hz

CH Mid

Agilent 15:55:57 Oct 31, 2012

R T

Mkr1 0 Hz
10.01 dB

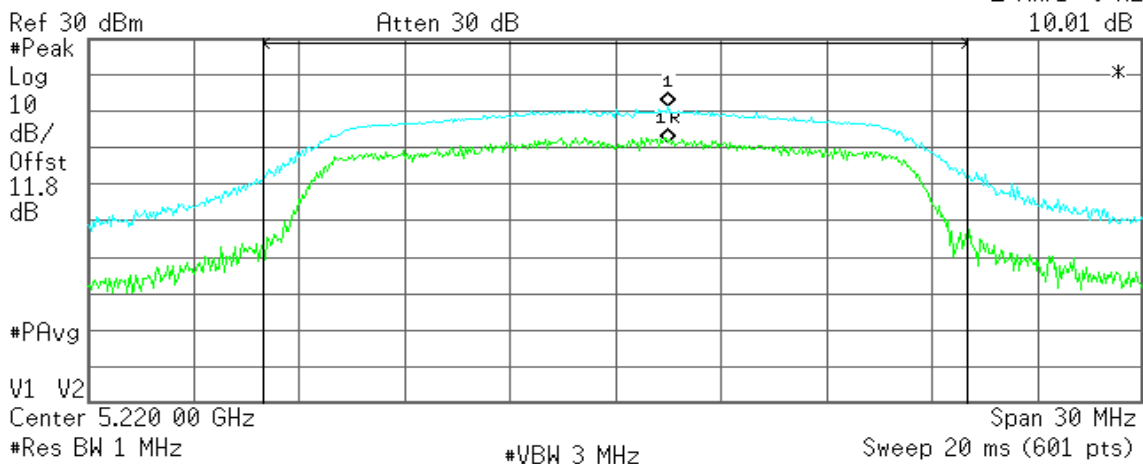

Channel Power

18.33 dBm /20.0000 MHz

Power Spectral Density

-54.68 dBm/Hz



CH High

Agilent 15:59:10 Oct 31, 2012

R T

Mkr1 0 Hz
12.00 dB

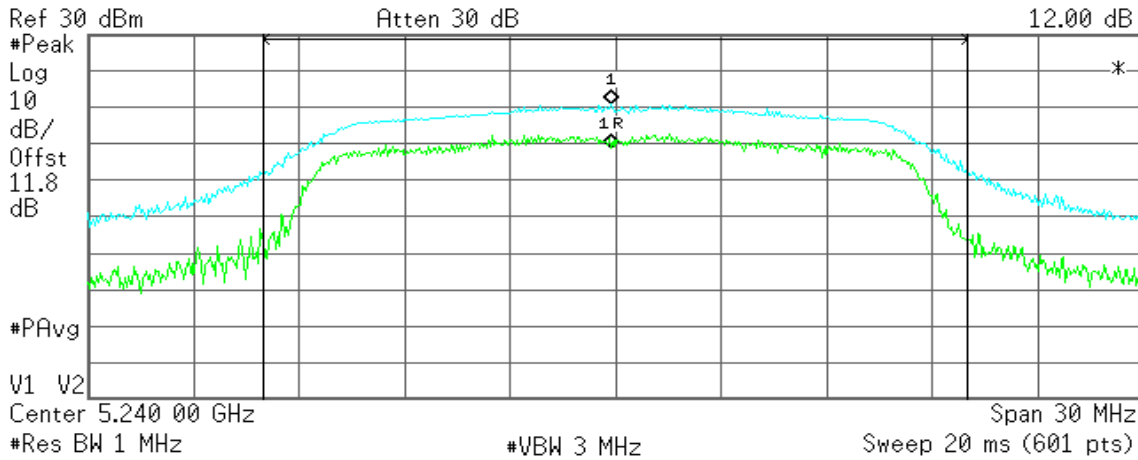

Channel Power

18.21 dBm /20.0000 MHz

Power Spectral Density

-54.80 dBm/Hz

IEEE 802.11n HT 20 MHz mode / 5180 ~ 5240MHz

CH Low

Agilent 17:11:43 Oct 31, 2012

R T

Mkr1 0 Hz
12.82 dB

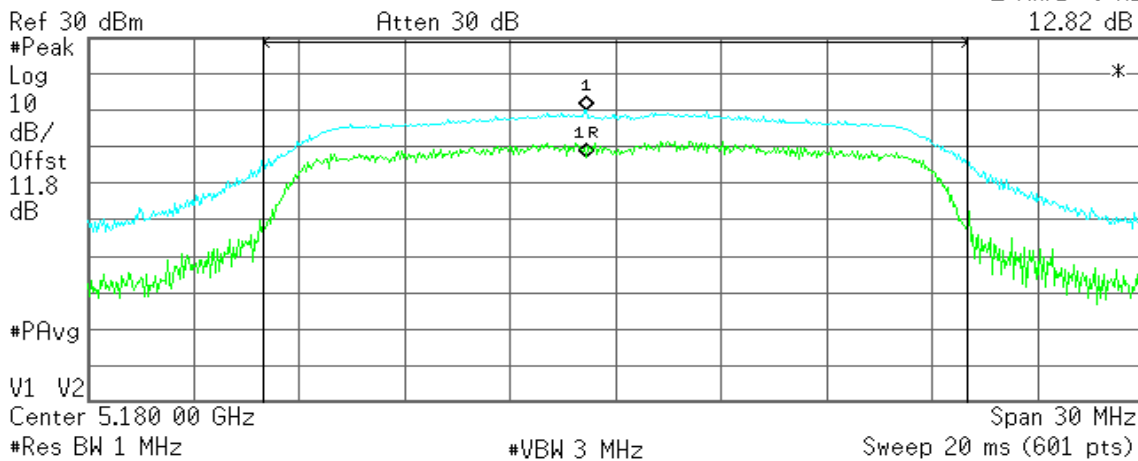

Channel Power

17.54 dBm /20.0000 MHz

Power Spectral Density

-55.47 dBm/Hz



CH Mid

Agilent 17:15:58 Oct 31, 2012

R T

Mkr1 0 Hz
9.14 dB

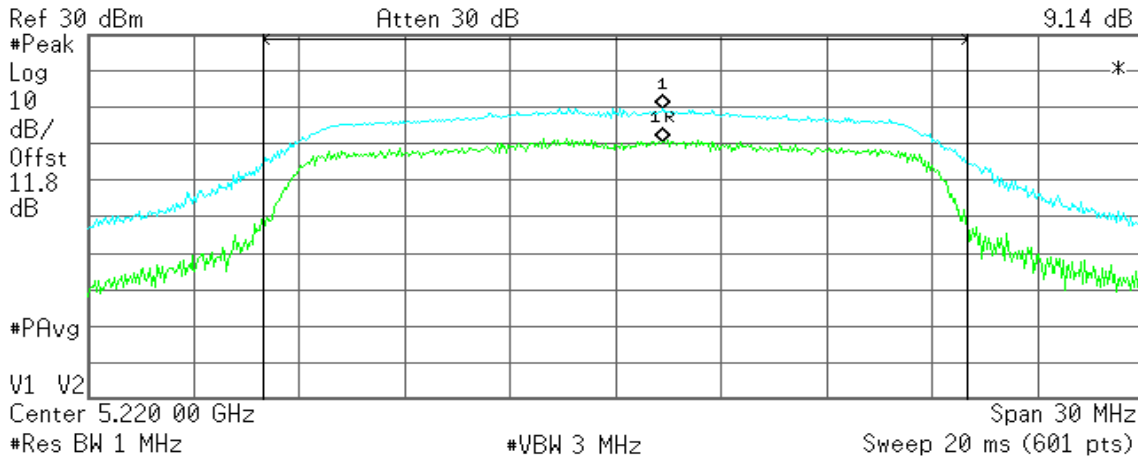

Channel Power

17.58 dBm /20.0000 MHz

Power Spectral Density

-55.43 dBm/Hz

CH High

Agilent 17:20:37 Oct 31, 2012

R T

Mkr1 0 Hz
9.78 dB

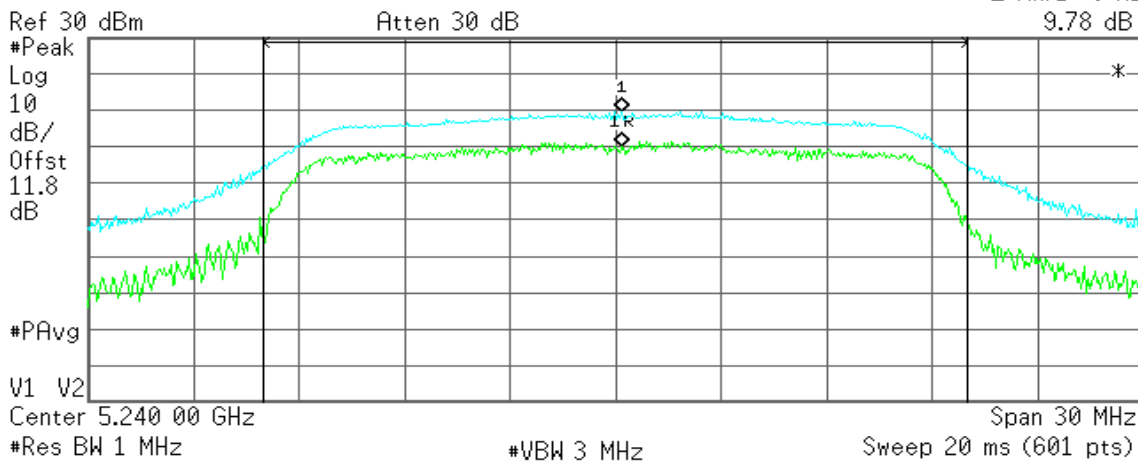

Channel Power

17.57 dBm /20.0000 MHz

Power Spectral Density

-55.44 dBm/Hz



IEEE 802.11a mode / 5260 ~ 5320MHz

CH Low

Agilent 19:22:23 Oct 30, 2012

R T

Mkr1 0 Hz
11.59 dB

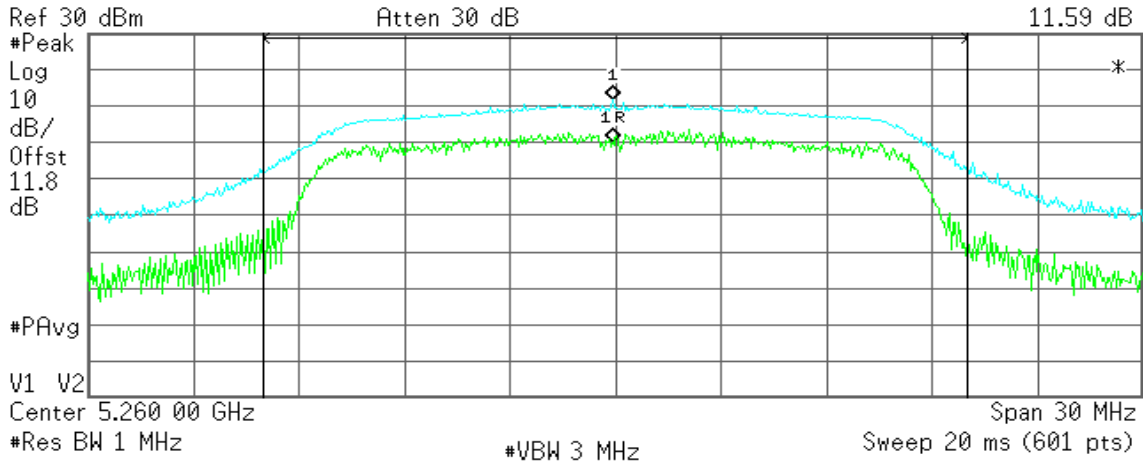

Channel Power

18.28 dBm /20.0000 MHz

Power Spectral Density

-54.73 dBm/Hz

CH Mid

Agilent 19:27:01 Oct 30, 2012

R T

Mkr1 0 Hz
9.78 dB

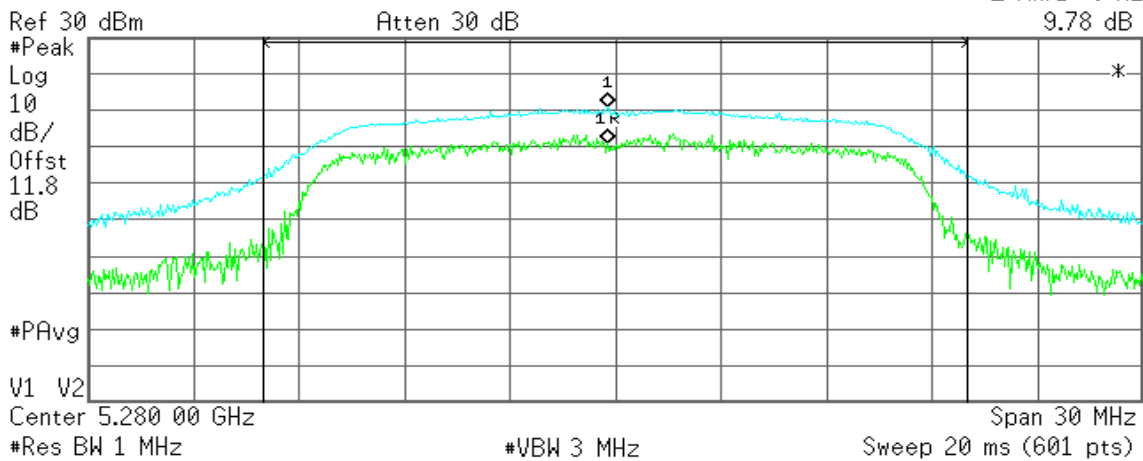

Channel Power

18.16 dBm /20.0000 MHz

Power Spectral Density

-54.85 dBm/Hz



CH High

Agilent 19:30:15 Oct 30, 2012

R T

Mkr1 0 Hz
8.06 dB

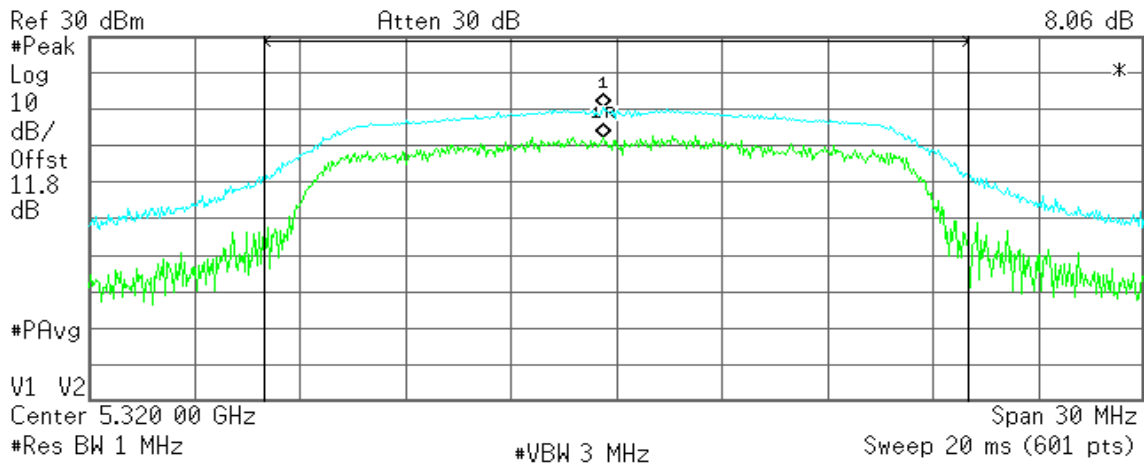

Channel Power

17.78 dBm /20.0000 MHz

Power Spectral Density

-55.23 dBm/Hz

IEEE 802.11n HT 20 MHz mode / 5260 ~ 5320MHz

CH Low

Agilent 19:47:41 Oct 30, 2012

R T

Mkr1 0 Hz
10.74 dB

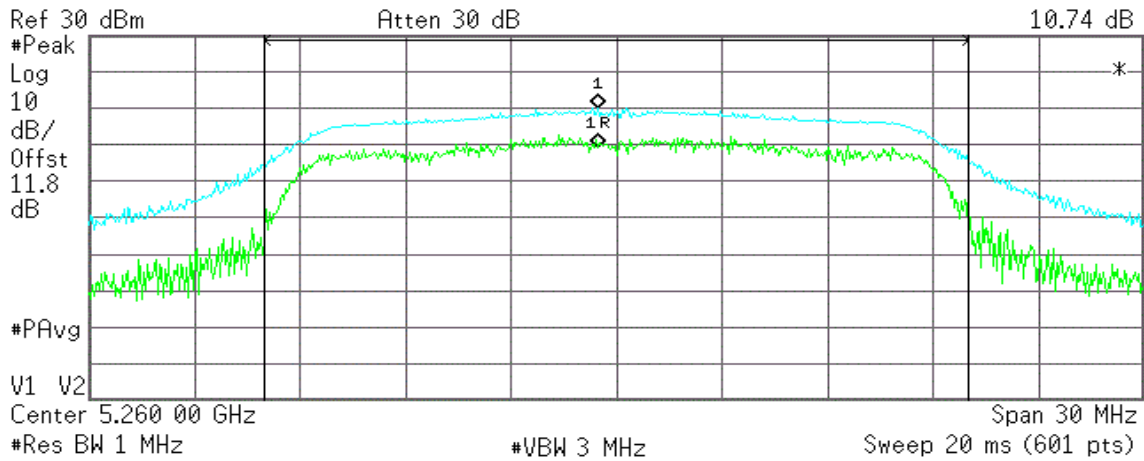

Channel Power

17.77 dBm /20.0000 MHz

Power Spectral Density

-55.24 dBm/Hz



CH Mid

Agilent 19:51:00 Oct 30, 2012

R T

Mkr1 0 Hz
9.66 dB

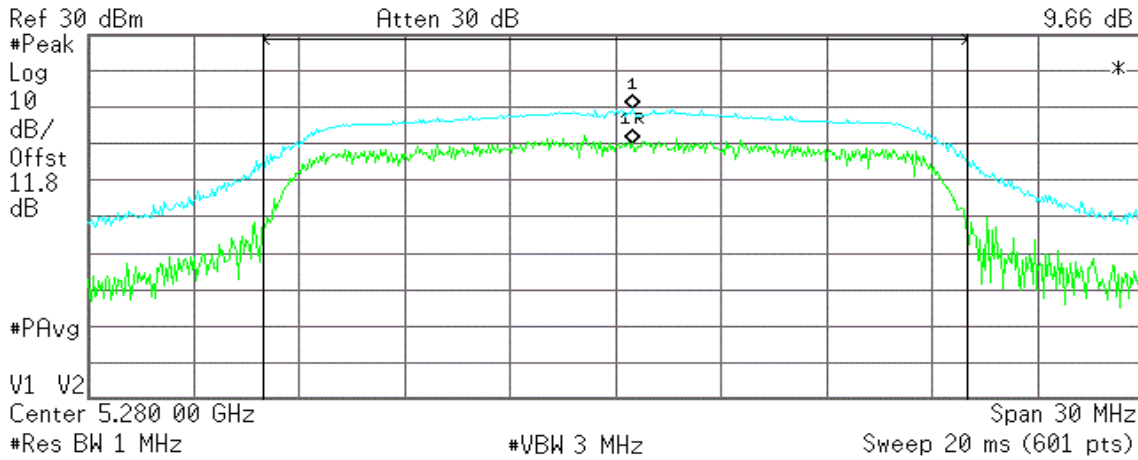

Channel Power

17.16 dBm /20.0000 MHz

Power Spectral Density

-55.85 dBm/Hz

CH High

Agilent 15:28:28 Jul 25, 2012

R T

Mkr1 0 Hz
11.37 dB

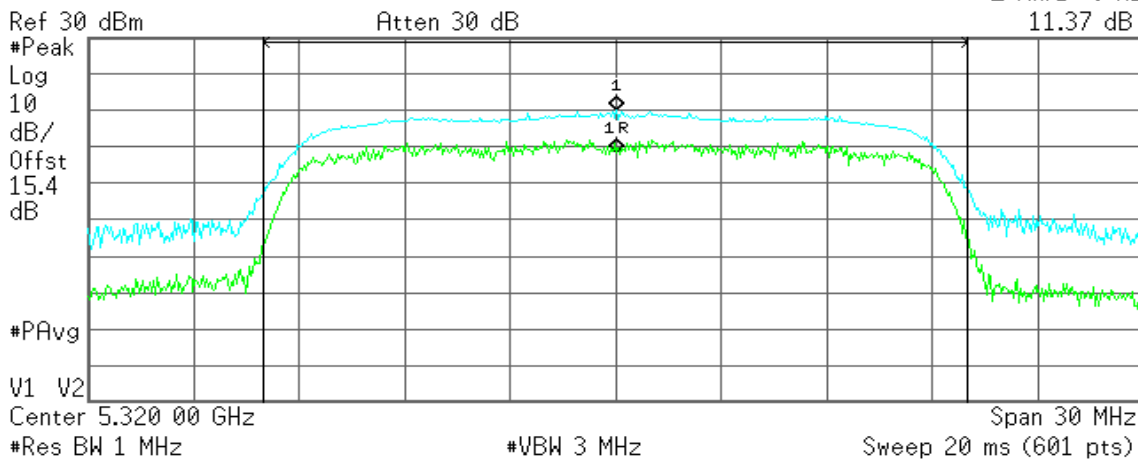

Channel Power

17.89 dBm /20.0000 MHz

Power Spectral Density

-55.12 dBm/Hz



Test mode: IEEE 802.11a mode / 5500 ~ 5700MHz

CH Low

Agilent 19:34:47 Oct 30, 2012

R T

Mkr1 0 Hz
9.78 dB

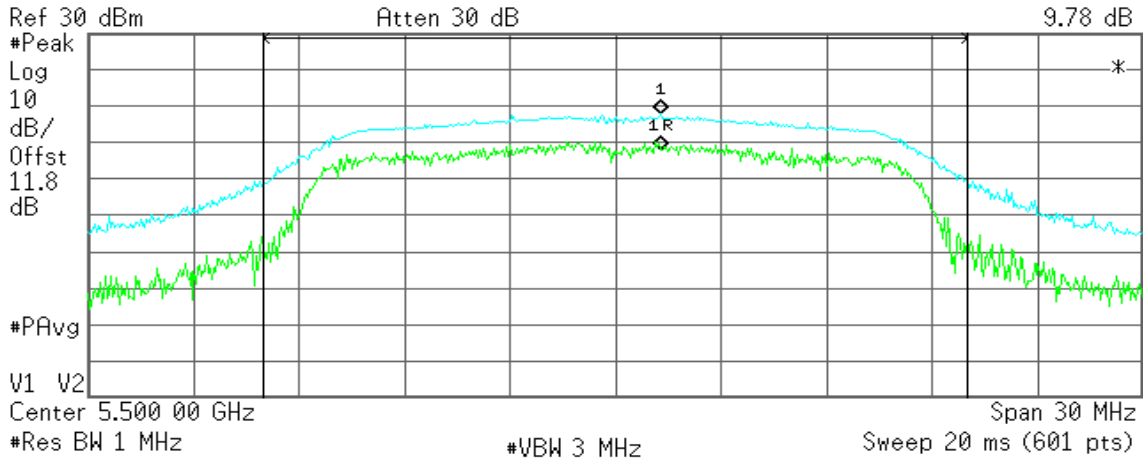

Channel Power

15.32 dBm /20.0000 MHz

Power Spectral Density

-57.69 dBm/Hz

CH Mid

Agilent 19:38:19 Oct 30, 2012

R T

Mkr1 0 Hz
8.95 dB

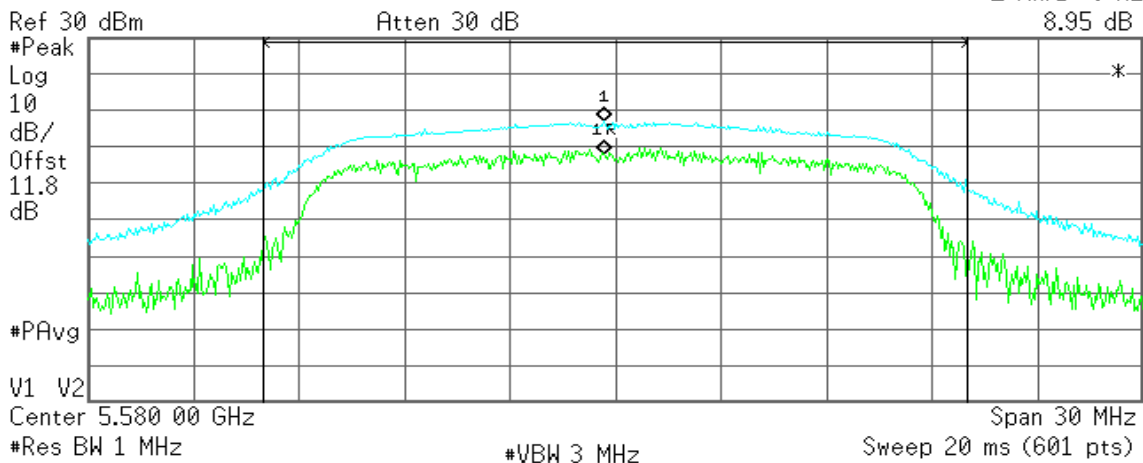

Channel Power

14.51 dBm /20.0000 MHz

Power Spectral Density

-58.50 dBm/Hz



CH High

Agilent 19:41:39 Oct 30, 2012

R T

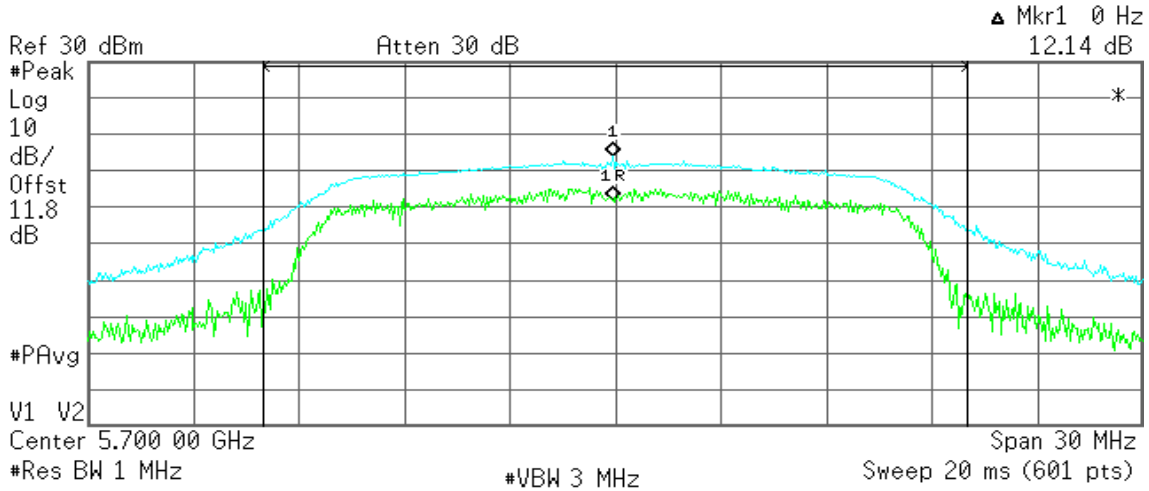

Channel Power

10.34 dBm /20.0000 MHz

Power Spectral Density

-62.67 dBm/Hz

IEEE 802.11n HT 20 MHz mode / 5500 ~ 5700MHz

CH Low

Agilent 19:58:50 Oct 30, 2012

R T

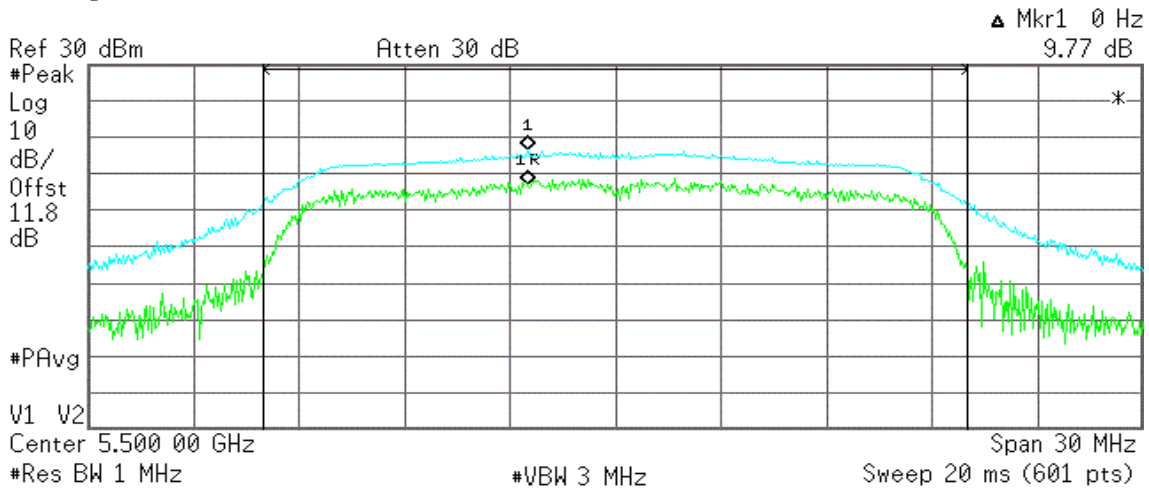

Channel Power

14.23 dBm /20.0000 MHz

Power Spectral Density

-58.78 dBm/Hz



CH Mid

Agilent 20:01:51 Oct 30, 2012

R T

Mkr1 0 Hz
9.60 dB

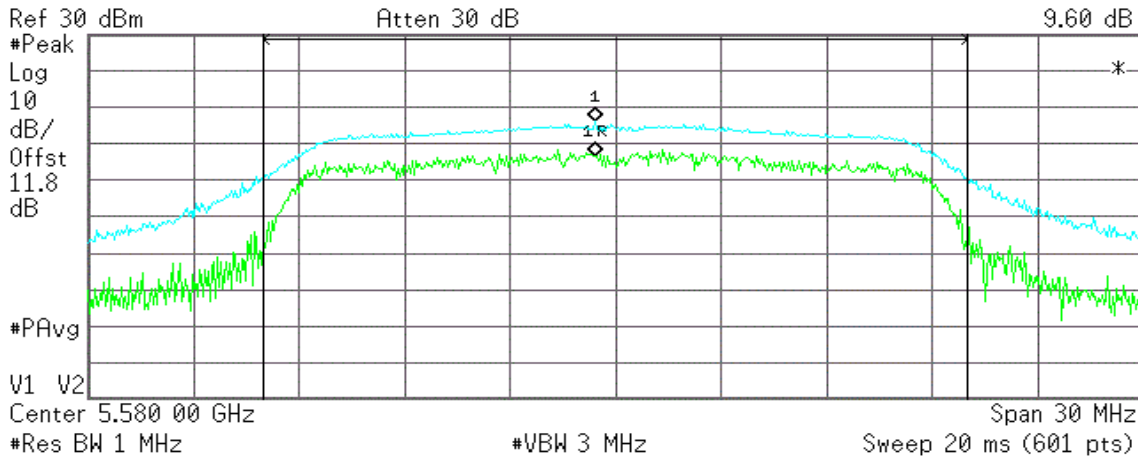

Channel Power

13.54 dBm /20.0000 MHz

Power Spectral Density

-59.47 dBm/Hz

CH High

Agilent 20:04:54 Oct 30, 2012

R T

Mkr1 0 Hz
9.67 dB

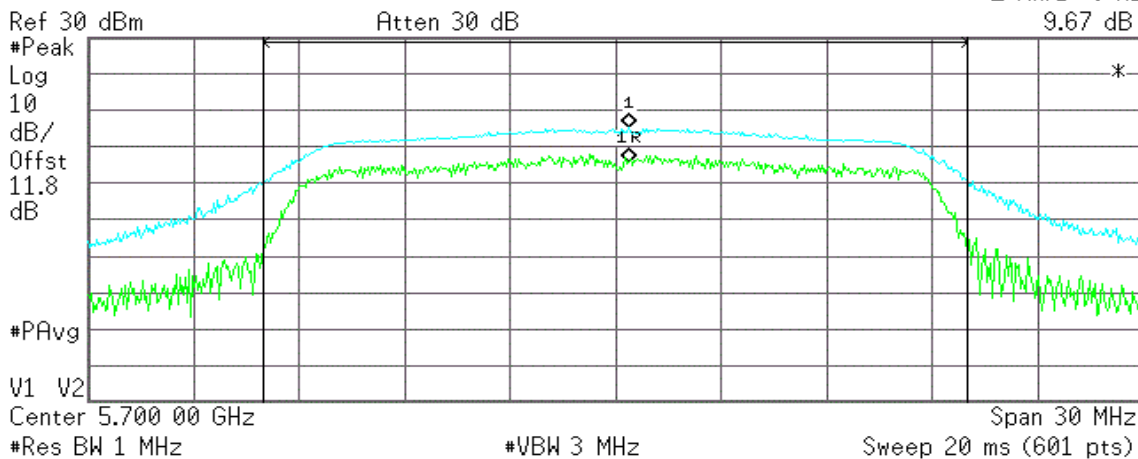

Channel Power

13.29 dBm /20.0000 MHz

Power Spectral Density

-59.72 dBm/Hz



7.6 RADIATED UNDESIRABLE EMISSION

1. According to §15.209(a), except as provided elsewhere in this Subpart, the emissions from an intentional radiator shall not exceed the field strength levels specified in the following table:

Frequency (MHz)	Field Strength ($\mu\text{V/m}$)	Measurement Distance (m)
30-88	100*	3
88-216	150*	3
216-960	200*	3
Above 960	500	3

Remark: Except as provided in paragraph (g), fundamental emissions from intentional radiators operating under this Section shall not be located in the frequency bands 54-72 MHz, 76-88 MHz, 174-216 MHz or 470-806 MHz. However, operation within these frequency bands is permitted under other sections of this Part, e.g., Sections 15.231 and 15.241.

2. In the emission table above, the tighter limit applies at the band edges.

Frequency (MHz)	Field Strength ($\mu\text{V/m}$ at 3-meter)	Field Strength (dB $\mu\text{V/m}$ at 3-meter)
30-88	100	40
88-216	150	43.5
216-960	200	46
Above 960	500	54



Test Configuration

9kHz ~ 30MHz

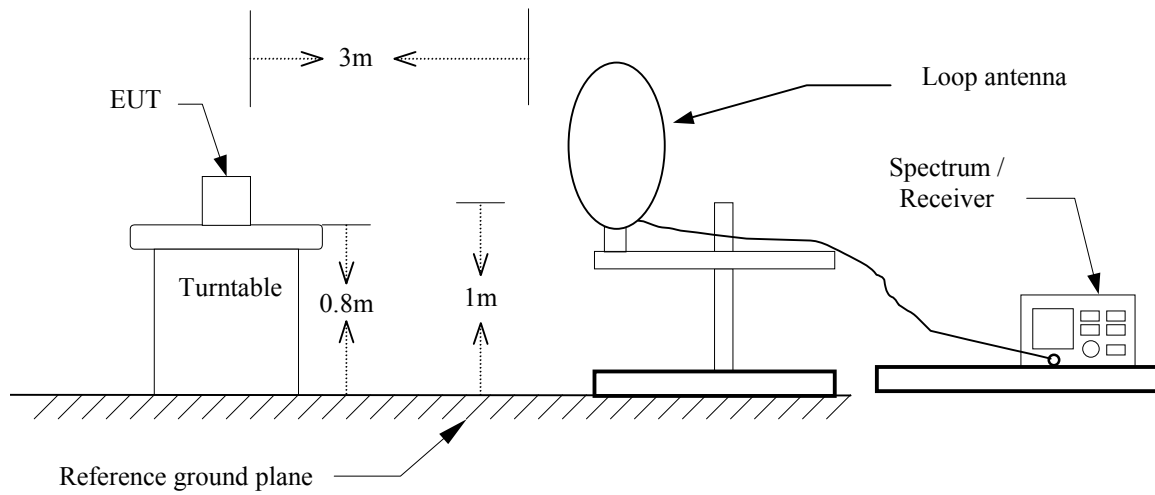

30MHz ~ 1GHz

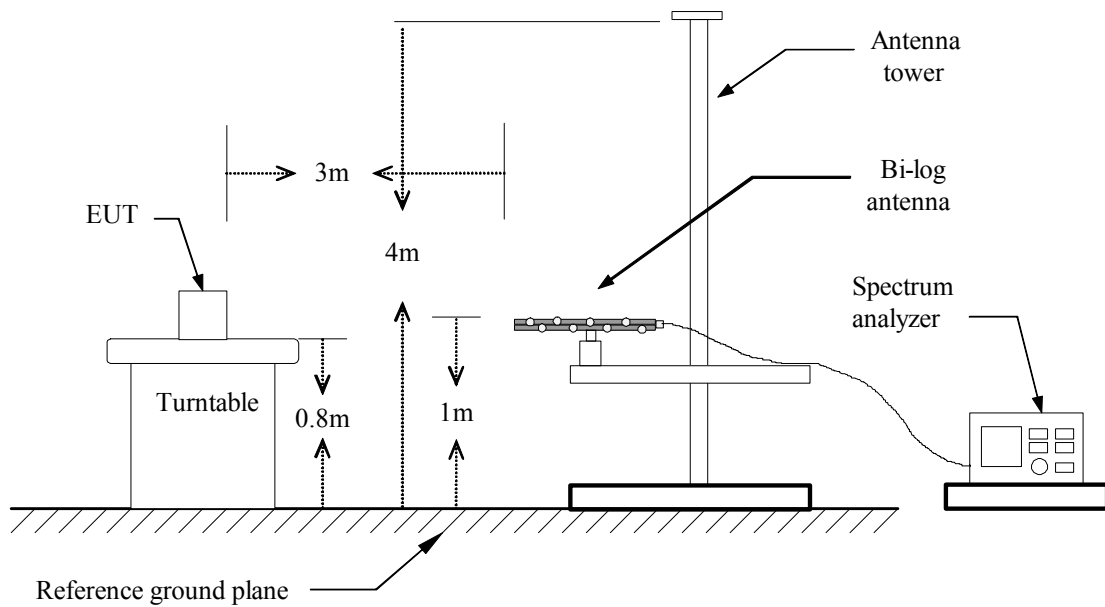



Above 1 GHz

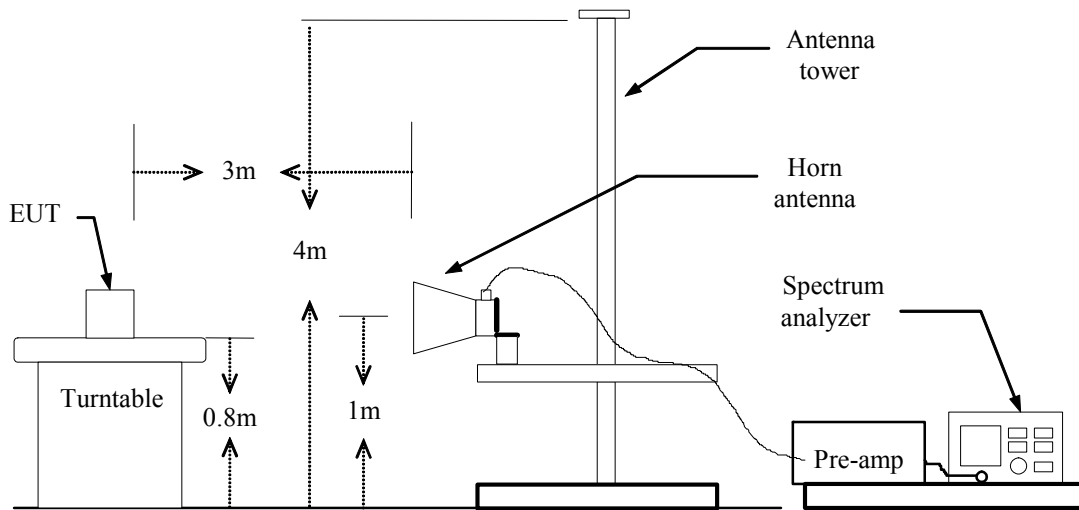



TEST PROCEDURE

1. The EUT is placed on a turntable, which is 0.8m above ground plane.
2. The turntable shall be rotated for 360 degrees to determine the position of maximum emission level.
3. EUT is set 3m away from the receiving antenna, which is varied from 1m to 4m to find out the highest emissions.
4. Maximum procedure was performed on the six highest emissions to ensure EUT compliance.
5. And also, each emission was to be maximized by changing the polarization of receiving antenna both horizontal and vertical.
6. Set the spectrum analyzer in the following setting as:

Below 1GHz:

RBW=100kHz / VBW=300kHz / Sweep=AUTO

Above 1GHz:

(a) PEAK: RBW=VBW=1MHz / Sweep=AUTO

(b) AVERAGE: RBW=1MHz / VBW=10Hz / Sweep=AUTO

7. Repeat above procedures until the measurements for all frequencies are complete.

**TEST RESULTS****Below 1 GHz**

Operation Mode: Normal Link **Test Date:** November 24, 2012
Temperature: 27°C **Tested by:** Shawn Wu
Humidity: 53 % RH **Polarity:** Ver. / Hor.

Frequency (MHz)	Reading (dBuV)	Correction Factor (dB/m)	Result (dBuV/m)	Limit (dBuV/m)	Margin (dB)	Remark	Ant.Pol. (H/V)
96.2833	40.20	-16.87	23.33	43.50	-20.17	peak	V
215.9167	34.52	-13.44	21.08	43.50	-22.42	peak	V
311.3000	32.33	-10.98	21.35	46.00	-24.65	peak	V
384.0500	37.41	-9.84	27.57	46.00	-18.43	peak	V
527.9333	39.04	-7.85	31.19	46.00	-14.81	peak	V
576.4333	39.65	-7.37	32.28	46.00	-13.72	peak	V
144.7833	32.96	-12.84	20.12	43.50	-23.38	peak	H
167.4167	37.28	-13.60	23.68	43.50	-19.82	peak	H
191.6667	39.46	-13.13	26.33	43.50	-17.17	peak	H
215.9167	42.59	-13.44	29.15	43.50	-14.35	peak	H
264.4167	37.88	-12.02	25.86	46.00	-20.14	peak	H
335.5500	32.70	-10.54	22.16	46.00	-23.84	peak	H

Remark:

1. No emission found between lowest internal used/generated frequency to 30MHz (9kHz~30MHz)
2. Radiated emissions measured in frequency range from 30 MHz to 1000MHz were made with an instrument using peak/quasi-peak detector mode.
3. Quasi-peak test would be performed if the peak result were greater than the quasi-peak limit or as required by the applicant.
4. Measurements above show only up to 6 maximum emissions noted, or would be lesser, with " N/A " remark, if no specific emissions from the EUT are recorded (ie: margin>20dB from the applicable limit) and considered that's already beyond the background noise floor.
5. Margin (dB) = Remark result (dBuV/m) – Quasi-peak limit (dBuV/m).



Above 1 GHz

Operation Mode: Tx / IEEE 802.11a mode / 5180 ~ 5240MHz / CH Low **Test Date:** October 31, 2012

Temperature: 25°C **Tested by:** Shawn Wu

Humidity: 50% RH **Polarity:** Ver. / Hor.

Frequency (MHz)	Reading (dBuV)	Correction (dB/m)	Result (dBuV/m)	Limit (dBuV/m)	Margin (dB)	Remark	Ant.Pol. (H/V)
3181.667	65.15	-16.42	48.73	74.00	-25.27	peak	V
N/A							
3648.333	64.18	-15.55	48.63	74.00	-25.37	peak	H
N/A							

Remark:

1. Measuring frequencies from 1 GHz to the 10th harmonic of highest fundamental frequency.
2. Radiated emissions measured in frequency above 1000MHz were made with an instrument using peak/average detector mode.
3. Average test would be performed if the peak result were greater than the average limit.
4. Data of measurement within this frequency range shown “ --- ” in the table above means the reading of emissions are attenuated more than 20dB below the permissible limits or the field strength is too small to be measured.
5. Measurements above show only up to 6 maximum emissions noted, or would be lesser, with “ N/A ” remark, if no specific emissions from the EUT are recorded (ie: margin>20dB from the applicable limit) and considered that's already beyond the background noise floor.
6. Margin (dB) = Remark result (dBuV/m) – Average limit (dBuV/m).



Operation Mode: Tx / IEEE 802.11a mode / 5180 ~ 5240MHz / CH Mid **Test Date:** October 31, 2012
Temperature: 25°C **Tested by:** Shawn Wu
Humidity: 50% RH **Polarity:** Ver. / Hor.

Frequency (MHz)	Reading (dBuV)	Correction (dB/m)	Result (dBuV/m)	Limit (dBuV/m)	Margin (dB)	Remark	Ant.Pol. (H/V)
5386.667	68.22	-10.84	57.38	74.00	-16.62	peak	V
5386.667	61.16	-10.84	50.32	54.00	-3.68	AVG	V
N/A							
5386.667	65.86	-10.84	55.02	74.00	-18.98	peak	H
5386.667	58.54	-10.84	47.70	54.00	-6.30	AVG	H
N/A							

Remark:

1. Measuring frequencies from 1 GHz to the 10th harmonic of highest fundamental frequency.
2. Radiated emissions measured in frequency above 1000MHz were made with an instrument using peak/average detector mode.
3. Average test would be performed if the peak result were greater than the average limit.
4. Data of measurement within this frequency range shown “ --- ” in the table above means the reading of emissions are attenuated more than 20dB below the permissible limits or the field strength is too small to be measured.
5. Measurements above show only up to 6 maximum emissions noted, or would be lesser, with “ N/A ” remark, if no specific emissions from the EUT are recorded (ie: margin>20dB from the applicable limit) and considered that's already beyond the background noise floor.
6. Margin (dB) = Remark result (dBuV/m) – Average limit (dBuV/m).



Operation Mode: Tx / IEEE 802.11a mode / 5180 ~ 5240MHz / CH High **Test Date:** October 31, 2012
Temperature: 25°C **Tested by:** Shawn Wu
Humidity: 50% RH **Polarity:** Ver. / Hor.

Frequency (MHz)	Reading (dBuV)	Correction (dB/m)	Result (dBuV/m)	Limit (dBuV/m)	Margin (dB)	Remark	Ant.Pol. (H/V)
5398.333	65.87	-10.82	55.05	74.00	-18.95	peak	V
5398.333	57.87	-10.82	47.05	54.00	-6.95	AVG	V
N/A							
5398.333	65.83	-10.82	55.01	74.00	-18.99	peak	H
5398.333	58.34	-10.82	47.52	54.00	-6.48	AVG	H
N/A							

Remark:

1. Measuring frequencies from 1 GHz to the 10th harmonic of highest fundamental frequency.
2. Radiated emissions measured in frequency above 1000MHz were made with an instrument using peak/average detector mode.
3. Average test would be performed if the peak result were greater than the average limit.
4. Data of measurement within this frequency range shown “ --- ” in the table above means the reading of emissions are attenuated more than 20dB below the permissible limits or the field strength is too small to be measured.
5. Measurements above show only up to 6 maximum emissions noted, or would be lesser, with “ N/A ” remark, if no specific emissions from the EUT are recorded (ie: margin>20dB from the applicable limit) and considered that's already beyond the background noise floor.
6. Margin (dB) = Remark result (dBuV/m) – Average limit (dBuV/m).



Operation Mode: Tx / IEEE 802.11n HT 20 MHz mode / 5180 ~ 5240MHz / CH Low **Test Date:** October 31, 2012
Temperature: 25°C **Tested by:** Shawn Wu
Humidity: 50% RH **Polarity:** Ver. / Hor.

Frequency (MHz)	Reading (dBuV)	Correction (dB/m)	Result (dBuV/m)	Limit (dBuV/m)	Margin (dB)	Remark	Ant.Pol. (H/V)
5340.000	68.56	-10.96	57.60	74.00	-16.40	peak	V
5340.000	59.69	-10.96	48.73	54.00	-5.27	AVG	V
N/A							
3216.667	64.80	-16.38	48.42	74.00	-25.58	peak	H
N/A							

Remark:

1. Measuring frequencies from 1 GHz to the 10th harmonic of highest fundamental frequency.
2. Radiated emissions measured in frequency above 1000MHz were made with an instrument using peak/average detector mode.
3. Average test would be performed if the peak result were greater than the average limit.
4. Data of measurement within this frequency range shown “ --- ” in the table above means the reading of emissions are attenuated more than 20dB below the permissible limits or the field strength is too small to be measured.
5. Measurements above show only up to 6 maximum emissions noted, or would be lesser, with “ N/A ” remark, if no specific emissions from the EUT are recorded (ie: margin>20dB from the applicable limit) and considered that's already beyond the background noise floor.
6. Margin (dB) = Remark result (dBuV/m) – Average limit (dBuV/m).



Operation Mode: Tx / IEEE 802.11n HT 20 MHz mode / 5180 ~ 5240MHz / CH Mid **Test Date:** October 31, 2012

Temperature: 25°C **Tested by:** Shawn Wu

Humidity: 50% RH **Polarity:** Ver. / Hor.

Frequency (MHz)	Reading (dBuV)	Correction (dB/m)	Result (dBuV/m)	Limit (dBuV/m)	Margin (dB)	Remark	Ant.Pol. (H/V)
5375.000	68.34	-10.87	57.47	74.00	-16.53	peak	V
5375.000	57.51	-10.87	46.64	54.00	-7.36	AVG	V
N/A							
5375.000	66.95	-10.87	56.08	74.00	-17.92	peak	H
5375.000	56.19	-10.87	45.32	54.00	-8.68	AVG	H
N/A							

Remark:

1. Measuring frequencies from 1 GHz to the 10th harmonic of highest fundamental frequency.
2. Radiated emissions measured in frequency above 1000MHz were made with an instrument using peak/average detector mode.
3. Average test would be performed if the peak result were greater than the average limit.
4. Data of measurement within this frequency range shown “ --- ” in the table above means the reading of emissions are attenuated more than 20dB below the permissible limits or the field strength is too small to be measured.
5. Measurements above show only up to 6 maximum emissions noted, or would be lesser, with “ N/A ” remark, if no specific emissions from the EUT are recorded (ie: margin>20dB from the applicable limit) and considered that's already beyond the background noise floor.
6. Margin (dB) = Remark result (dBuV/m) – Average limit (dBuV/m).



Operation Mode: Tx / IEEE 802.11n HT 20 MHz mode / 5180 ~ 5240MHz / CH High **Test Date:** October 31, 2012
Temperature: 25°C **Tested by:** Shawn Wu
Humidity: 50% RH **Polarity:** Ver. / Hor.

Frequency (MHz)	Reading (dBuV)	Correction (dB/m)	Result (dBuV/m)	Limit (dBuV/m)	Margin (dB)	Remark	Ant.Pol. (H/V)
5398.333	65.58	-10.82	54.76	74.00	-19.24	peak	V
5398.333	54.58	-10.82	43.76	54.00	-10.24	AVG	V
N/A							
5410.000	66.07	-10.79	55.28	74.00	-18.72	peak	H
5410.000	56.43	-10.79	45.64	54.00	-8.36	AVG	H
N/A							

Remark:

1. Measuring frequencies from 1 GHz to the 10th harmonic of highest fundamental frequency.
2. Radiated emissions measured in frequency above 1000MHz were made with an instrument using peak/average detector mode.
3. Average test would be performed if the peak result were greater than the average limit.
4. Data of measurement within this frequency range shown “ --- ” in the table above means the reading of emissions are attenuated more than 20dB below the permissible limits or the field strength is too small to be measured.
5. Measurements above show only up to 6 maximum emissions noted, or would be lesser, with “ N/A ” remark, if no specific emissions from the EUT are recorded (ie: margin>20dB from the applicable limit) and considered that's already beyond the background noise floor.
6. Margin (dB) = Remark result (dBuV/m) – Average limit (dBuV/m).



Operation Mode: Tx / IEEE 802.11a mode / 5260 ~ 5320MHz / CH Low **Test Date:** October 31, 2012
Temperature: 25°C **Tested by:** Shawn Wu
Humidity: 50% RH **Polarity:** Ver. / Hor.

Frequency (MHz)	Reading (dBuV)	Correction (dB/m)	Result (dBuV/m)	Limit (dBuV/m)	Margin (dB)	Remark	Ant.Pol. (H/V)
5421.667	66.73	-10.76	55.97	74.00	-18.03	peak	V
5421.667	58.60	-10.76	47.84	54.00	-6.16	AVG	
N/A							
4033.333	64.05	-14.44	49.61	74.00	-24.39	peak	H
N/A							

Remark:

1. Measuring frequencies from 1 GHz to the 10th harmonic of highest fundamental frequency.
2. Radiated emissions measured in frequency above 1000MHz were made with an instrument using peak/average detector mode.
3. Average test would be performed if the peak result were greater than the average limit.
4. Data of measurement within this frequency range shown “ --- ” in the table above means the reading of emissions are attenuated more than 20dB below the permissible limits or the field strength is too small to be measured.
5. Measurements above show only up to 6 maximum emissions noted, or would be lesser, with “ N/A ” remark, if no specific emissions from the EUT are recorded (ie: margin>20dB from the applicable limit) and considered that's already beyond the background noise floor.
6. Margin (dB) = Remark result (dBuV/m) – Average limit (dBuV/m).



Operation Mode: Tx / IEEE 802.11a mode / 5260 ~ 5320MHz / CH Mid **Test Date:** October 31, 2012
Temperature: 25°C **Tested by:** Shawn Wu
Humidity: 50% RH **Polarity:** Ver. / Hor.

Frequency (MHz)	Reading (dBuV)	Correction (dB/m)	Result (dBuV/m)	Limit (dBuV/m)	Margin (dB)	Remark	Ant.Pol. (H/V)
5445.000	66.58	-10.70	55.88	74.00	-18.12	peak	V
5445.000	58.06	-10.70	47.36	54.00	-6.64	AVG	V
N/A							
3835.000	65.42	-15.01	50.41	74.00	-23.59	peak	H
N/A							

Remark:

1. Measuring frequencies from 1 GHz to the 10th harmonic of highest fundamental frequency.
2. Radiated emissions measured in frequency above 1000MHz were made with an instrument using peak/average detector mode.
3. Average test would be performed if the peak result were greater than the average limit.
4. Data of measurement within this frequency range shown " --- " in the table above means the reading of emissions are attenuated more than 20dB below the permissible limits or the field strength is too small to be measured.
5. Measurements above show only up to 6 maximum emissions noted, or would be lesser, with " N/A " remark, if no specific emissions from the EUT are recorded (ie: margin>20dB from the applicable limit) and considered that's already beyond the background noise floor.
6. Margin (dB) = Remark result (dBuV/m) – Average limit (dBuV/m).



Operation Mode: Tx / IEEE 802.11a mode / 5260 ~ 5320MHz / CH High **Test Date:** October 31, 2012
Temperature: 25°C **Tested by:** Shawn Wu
Humidity: 50% RH **Polarity:** Ver. / Hor.

Frequency (MHz)	Reading (dBuV)	Correction (dB/m)	Result (dBuV/m)	Limit (dBuV/m)	Margin (dB)	Remark	Ant.Pol. (H/V)
4010.000	64.15	-14.49	49.66	74.00	-24.34	peak	V
N/A							
3975.000	64.33	-14.59	49.74	74.00	-24.26	peak	H
N/A							

Remark:

1. Measuring frequencies from 1 GHz to the 10th harmonic of highest fundamental frequency.
2. Radiated emissions measured in frequency above 1000MHz were made with an instrument using peak/average detector mode.
3. Average test would be performed if the peak result were greater than the average limit.
4. Data of measurement within this frequency range shown “ --- ” in the table above means the reading of emissions are attenuated more than 20dB below the permissible limits or the field strength is too small to be measured.
5. Measurements above show only up to 6 maximum emissions noted, or would be lesser, with “ N/A ” remark, if no specific emissions from the EUT are recorded (ie: margin>20dB from the applicable limit) and considered that's already beyond the background noise floor.
6. $Margin (dB) = Remark\ result (dBuV/m) - Average\ limit (dBuV/m)$.



Operation Mode: Tx / IEEE 802.11n HT 20 MHz mode / 5260 ~ 5320MHz / CH Low **Test Date:** October 31, 2012
Temperature: 25°C **Tested by:** Shawn Wu
Humidity: 50% RH **Polarity:** Ver. / Hor.

Frequency (MHz)	Reading (dBuV)	Correction (dB/m)	Result (dBuV/m)	Limit (dBuV/m)	Margin (dB)	Remark	Ant.Pol. (H/V)
5421.667	65.65	-10.76	54.89	74.00	-19.11	peak	V
5421.667	53.81	-10.76	43.05	74.00	-30.95	peak	V
N/A							
5421.667	64.73	-10.76	53.97	74.00	-20.03	peak	H
5421.667	53.61	-10.76	42.85	54.00	-11.15	AVG	H
N/A							

Remark:

1. Measuring frequencies from 1 GHz to the 10th harmonic of highest fundamental frequency.
2. Radiated emissions measured in frequency above 1000MHz were made with an instrument using peak/average detector mode.
3. Average test would be performed if the peak result were greater than the average limit.
4. Data of measurement within this frequency range shown “ --- ” in the table above means the reading of emissions are attenuated more than 20dB below the permissible limits or the field strength is too small to be measured.
5. Measurements above show only up to 6 maximum emissions noted, or would be lesser, with “ N/A ” remark, if no specific emissions from the EUT are recorded (ie: margin>20dB from the applicable limit) and considered that's already beyond the background noise floor.
6. Margin (dB) = Remark result (dBuV/m) – Average limit (dBuV/m).



Operation Mode: Tx / IEEE 802.11n HT 20 MHz mode / 5260 ~ 5320MHz / CH Mid **Test Date:** October 31, 2012
Temperature: 25°C **Tested by:** Shawn Wu
Humidity: 50% RH **Polarity:** Ver. / Hor.

Frequency (MHz)	Reading (dBuV)	Correction (dB/m)	Result (dBuV/m)	Limit (dBuV/m)	Margin (dB)	Remark	Ant.Pol. (H/V)
5445.000	65.18	-10.70	54.48	74.00	-19.52	peak	V
5445.000	53.93	-10.70	43.23	54.00	-10.77	AVG	V
N/A							
3193.333	65.11	-16.41	48.70	74.00	-25.30	peak	H
N/A							

Remark:

1. Measuring frequencies from 1 GHz to the 10th harmonic of highest fundamental frequency.
2. Radiated emissions measured in frequency above 1000MHz were made with an instrument using peak/average detector mode.
3. Average test would be performed if the peak result were greater than the average limit.
4. Data of measurement within this frequency range shown “ --- ” in the table above means the reading of emissions are attenuated more than 20dB below the permissible limits or the field strength is too small to be measured.
5. Measurements above show only up to 6 maximum emissions noted, or would be lesser, with “ N/A ” remark, if no specific emissions from the EUT are recorded (ie: margin>20dB from the applicable limit) and considered that's already beyond the background noise floor.
6. Margin (dB) = Remark result (dBuV/m) – Average limit (dBuV/m).



Operation Mode: Tx / IEEE 802.11n HT 20 MHz mode / 5260 ~ 5320MHz / CH High **Test Date:** October 31, 2012
Temperature: 25°C **Tested by:** Shawn Wu
Humidity: 50% RH **Polarity:** Ver. / Hor.

Frequency (MHz)	Reading (dBuV)	Correction (dB/m)	Result (dBuV/m)	Limit (dBuV/m)	Margin (dB)	Remark	Ant.Pol. (H/V)
2598.333	64.83	-17.63	47.20	74.00	-26.80	peak	V
N/A							
3228.333	65.11	-16.36	48.75	74.00	-25.25	peak	H
N/A							

Remark:

1. Measuring frequencies from 1 GHz to the 10th harmonic of highest fundamental frequency.
2. Radiated emissions measured in frequency above 1000MHz were made with an instrument using peak/average detector mode.
3. Average test would be performed if the peak result were greater than the average limit.
4. Data of measurement within this frequency range shown “ --- ” in the table above means the reading of emissions are attenuated more than 20dB below the permissible limits or the field strength is too small to be measured.
5. Measurements above show only up to 6 maximum emissions noted, or would be lesser, with “ N/A ” remark, if no specific emissions from the EUT are recorded (ie: margin>20dB from the applicable limit) and considered that's already beyond the background noise floor.
6. Margin (dB) = Remark result (dBuV/m) – Average limit (dBuV/m).



Operation Mode: Tx / IEEE 802.11a mode / 5500 ~ 5700MHz / CH Low **Test Date:** October 31, 2012
Temperature: 25°C **Tested by:** Shawn Wu
Humidity: 50% RH **Polarity:** Ver. / Hor.

Frequency (MHz)	Reading (dBuV)	Correction (dB/m)	Result (dBuV/m)	Limit (dBuV/m)	Margin (dB)	Remark	Ant.Pol. (H/V)
3811.667	64.41	-15.07	49.34	74.00	-24.66	peak	V
N/A							
3893.333	64.00	-14.83	49.17	74.00	-24.83	peak	H
N/A							

Remark:

1. Measuring frequencies from 1 GHz to the 10th harmonic of highest fundamental frequency.
2. Radiated emissions measured in frequency above 1000MHz were made with an instrument using peak/average detector mode.
3. Average test would be performed if the peak result were greater than the average limit or as required by the applicant.
4. Data of measurement within this frequency range shown “ --- ” in the table above means the reading of emissions are attenuated more than 20dB below the permissible limits or the field strength is too small to be measured.
5. Measurements above show only up to 6 maximum emissions noted, or would be lesser, with “ N/A ” remark, if no specific emissions from the EUT are recorded (ie: margin>20dB from the applicable limit) and considered that's already beyond the background noise floor.
6. Margin (dB) = Remark result (dBuV/m) – Average limit (dBuV/m).



Operation Mode: Tx / IEEE 802.11a mode / 5500 ~ 5700MHz /CH Mid **Test Date:** October 31, 2012
Temperature: 25°C **Tested by:** Shawn Wu
Humidity: 50% RH **Polarity:** Ver. / Hor.

Frequency (MHz)	Reading (dBuV)	Correction (dB/m)	Result (dBuV/m)	Limit (dBuV/m)	Margin (dB)	Remark	Ant.Pol. (H/V)
3963.333	63.94	-14.63	49.31	74.00	-24.69	peak	V
N/A							
4021.667	64.61	-14.46	50.15	74.00	-23.85	peak	H
N/A							

Remark:

1. Measuring frequencies from 1 GHz to the 10th harmonic of highest fundamental frequency.
2. Radiated emissions measured in frequency above 1000MHz were made with an instrument using peak/average detector mode.
3. Average test would be performed if the peak result were greater than the average limit.
4. Data of measurement within this frequency range shown “ --- ” in the table above means the reading of emissions are attenuated more than 20dB below the permissible limits or the field strength is too small to be measured.
5. Measurements above show only up to 6 maximum emissions noted, or would be lesser, with “ N/A ” remark, if no specific emissions from the EUT are recorded (ie: margin>20dB from the applicable limit) and considered that's already beyond the background noise floor.
6. Margin (dB) = Remark result (dBuV/m) – Average limit (dBuV/m).



Operation Mode: Tx / IEEE 802.11a mode / 5500 ~ 5700MHz / CH High **Test Date:** October 31, 2012
Temperature: 25°C **Tested by:** Shawn Wu
Humidity: 50% RH **Polarity:** Ver. / Hor.

Frequency (MHz)	Reading (dBuV)	Correction (dB/m)	Result (dBuV/m)	Limit (dBuV/m)	Margin (dB)	Remark	Ant.Pol. (H/V)
3858.333	65.18	-14.94	50.24	74.00	-23.76	peak	V
N/A							
3963.333	64.63	-14.63	50.00	74.00	-24.00	peak	H
N/A							

Remark:

1. Measuring frequencies from 1 GHz to the 10th harmonic of highest fundamental frequency.
2. Radiated emissions measured in frequency above 1000MHz were made with an instrument using peak/average detector mode.
3. Average test would be performed if the peak result were greater than the average limit.
4. Data of measurement within this frequency range shown “ --- ” in the table above means the reading of emissions are attenuated more than 20dB below the permissible limits or the field strength is too small to be measured.
5. Measurements above show only up to 6 maximum emissions noted, or would be lesser, with “ N/A ” remark, if no specific emissions from the EUT are recorded (ie: margin>20dB from the applicable limit) and considered that's already beyond the background noise floor.
6. Margin (dB) = Remark result (dBuV/m) – Average limit (dBuV/m).



Operation Mode: Tx / IEEE 802.11n HT 20 MHz mode / 5500 ~ 5700MHz / CH Low **Test Date:** October 31, 2012

Temperature: 25°C **Tested by:** Shawn Wu

Humidity: 50% RH **Polarity:** Ver. / Hor.

Frequency (MHz)	Reading (dBuV)	Correction (dB/m)	Result (dBuV/m)	Limit (dBuV/m)	Margin (dB)	Remark	Ant.Pol. (H/V)
3170.000	64.70	-16.44	48.26	74.00	-25.74	peak	V
N/A							
3088.333	65.60	-16.55	49.05	74.00	-24.95	peak	H
N/A							

Remark:

1. Measuring frequencies from 1 GHz to the 10th harmonic of highest fundamental frequency.
2. Radiated emissions measured in frequency above 1000MHz were made with an instrument using peak/average detector mode.
3. Average test would be performed if the peak result were greater than the average limit or as required by the applicant.
4. Data of measurement within this frequency range shown “ --- ” in the table above means the reading of emissions are attenuated more than 20dB below the permissible limits or the field strength is too small to be measured.
5. Measurements above show only up to 6 maximum emissions noted, or would be lesser, with “ N/A ” remark, if no specific emissions from the EUT are recorded (ie: margin>20dB from the applicable limit) and considered that's already beyond the background noise floor.
6. Margin (dB) = Remark result (dBuV/m) – Average limit (dBuV/m).



Operation Mode: Tx / IEEE 802.11n HT 20 MHz mode / 5500 ~ 5700MHz / CH Mid **Test Date:** October 31, 2012
Temperature: 25°C **Tested by:** Shawn Wu
Humidity: 50% RH **Polarity:** Ver. / Hor.

Frequency (MHz)	Reading (dBuV)	Correction (dB/m)	Result (dBuV/m)	Limit (dBuV/m)	Margin (dB)	Remark	Ant.Pol. (H/V)
3298.333	64.70	-16.26	48.44	74.00	-25.56	peak	V
N/A							
2365.000	64.59	-18.21	46.38	74.00	-27.62	peak	H
N/A							

Remark:

1. Measuring frequencies from 1 GHz to the 10th harmonic of highest fundamental frequency.
2. Radiated emissions measured in frequency above 1000MHz were made with an instrument using peak/average detector mode.
3. Average test would be performed if the peak result were greater than the average limit.
4. Data of measurement within this frequency range shown “ --- ” in the table above means the reading of emissions are attenuated more than 20dB below the permissible limits or the field strength is too small to be measured.
5. Measurements above show only up to 6 maximum emissions noted, or would be lesser, with “ N/A ” remark, if no specific emissions from the EUT are recorded (ie: margin>20dB from the applicable limit) and considered that's already beyond the background noise floor.
6. Margin (dB) = Remark result (dBuV/m) – Average limit (dBuV/m).



Operation Mode: Tx / IEEE 802.11n HT 20 MHz mode / 5500 ~ 5700MHz / CH High **Test Date:** October 31, 2012

Temperature: 25°C **Tested by:** Shawn Wu

Humidity: 50% RH **Polarity:** Ver. / Hor.

Frequency (MHz)	Reading (dBuV)	Correction (dB/m)	Result (dBuV/m)	Limit (dBuV/m)	Margin (dB)	Remark	Ant.Pol. (H/V)
3893.333	65.49	-14.83	50.66	74.00	-23.34	peak	V
N/A							
5865.000	65.71	-9.68	56.03	74.00	-17.97	peak	H
5865.000	57.06	-9.68	47.38	54.00	-6.62	AVG	H
N/A							

Remark:

1. Measuring frequencies from 1 GHz to the 10th harmonic of highest fundamental frequency.
2. Radiated emissions measured in frequency above 1000MHz were made with an instrument using peak/average detector mode.
3. Average test would be performed if the peak result were greater than the average limit or as required by the applicant.
4. Data of measurement within this frequency range shown “ --- ” in the table above means the reading of emissions are attenuated more than 20dB below the permissible limits or the field strength is too small to be measured.
5. Measurements above show only up to 6 maximum emissions noted, or would be lesser, with “ N/A ” remark, if no specific emissions from the EUT are recorded (ie: margin>20dB from the applicable limit) and considered that's already beyond the background noise floor.
6. Margin (dB) = Remark result (dBuV/m) – Average limit (dBuV/m).



7.7 CONDUCTED UNDESIRABLE EMISSION

LIMIT

According to 15.407(b),

- (1) For transmitters operating in the 5.15-5.25 GHz band: all emissions outside of the 5.15-5.35 GHz band shall not exceed an EIRP of -27 dBm/MHz.
- (2) For transmitters operating in the 5.25-5.35 GHz band: all emissions outside of the 5.15-5.35 GHz band shall not exceed an EIRP of -27 dBm/MHz. Devices operating in the 5.25-5.35 GHz band that generate emissions in the 5.15-5.25 GHz band must meet all applicable technical requirements for operation in the 5.15-5.25 GHz band (including indoor use) or alternatively meet an out-of-band emission EIRP limit of -27 dBm/MHz in the 5.15-5.25 GHz band.

The provisions of §15.205 apply to intentional radiators operating under this section.

Test Configuration

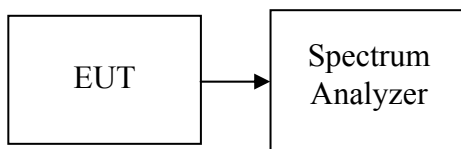

TEST PROCEDURE

Conducted RF measurements of the transmitter output were made to confirm that the EUT antenna port conducted emissions meet the specified limit and to identify any spurious signals that require further investigation or measurements on the radiated emissions site.

The transmitter output is connected to the spectrum analyzer. The resolution bandwidth is set to 1 MHz. The video bandwidth is set to 1 MHz. Peak detection measurements are compared to the average EIRP limit, adjusted for the maximum antenna gain. If necessary, additional average detection measurements are made.

Measurements are made over the 30 MHz to 40 GHz range with the transmitter set to the lowest, middle, and highest channels.

TEST RESULTS

No non-compliance noted



Test Plot

IEEE 802.11a mode / 5180 ~ 5240MHz

CH Low

Agilent 15:53:28 Oct 31, 2012

R T

Mkr2 10.36 GHz
-51.86 dBm

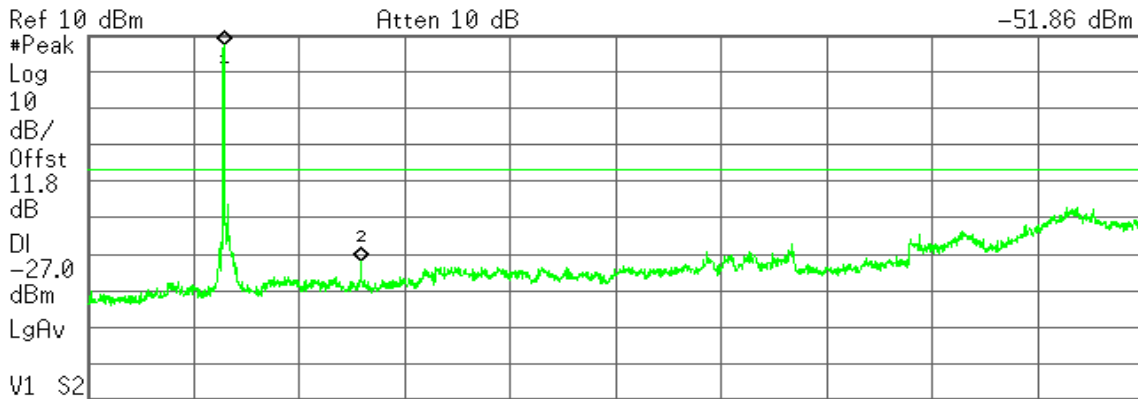

Marker	Trace	Type	X Axis	Amplitude
1	(1)	Freq	5.19 GHz	7.59 dBm
2	(1)	Freq	10.36 GHz	-51.86 dBm

CH Mid

Agilent 15:56:53 Oct 31, 2012

R T

Mkr2 10.44 GHz
-49.76 dBm

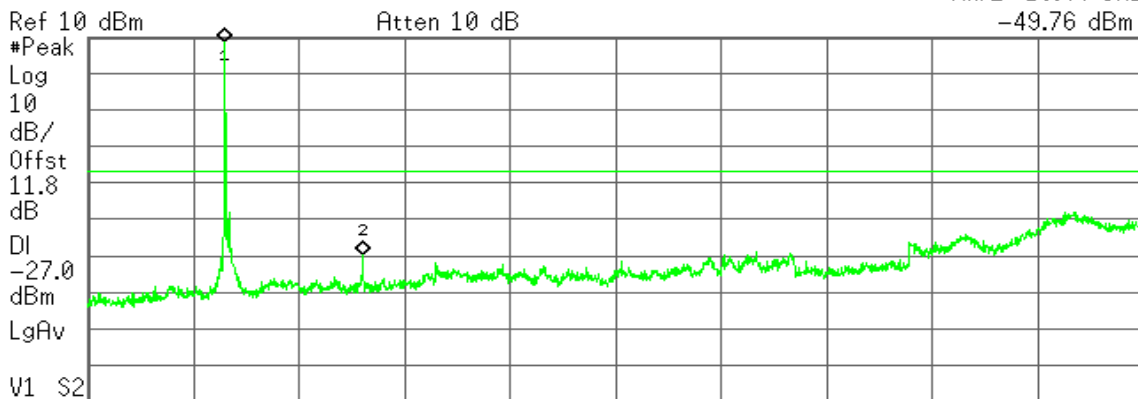

Marker	Trace	Type	X Axis	Amplitude
1	(1)	Freq	5.23 GHz	8.90 dBm
2	(1)	Freq	10.44 GHz	-49.76 dBm



CH High

Agilent 16:00:26 Oct 31, 2012

R T

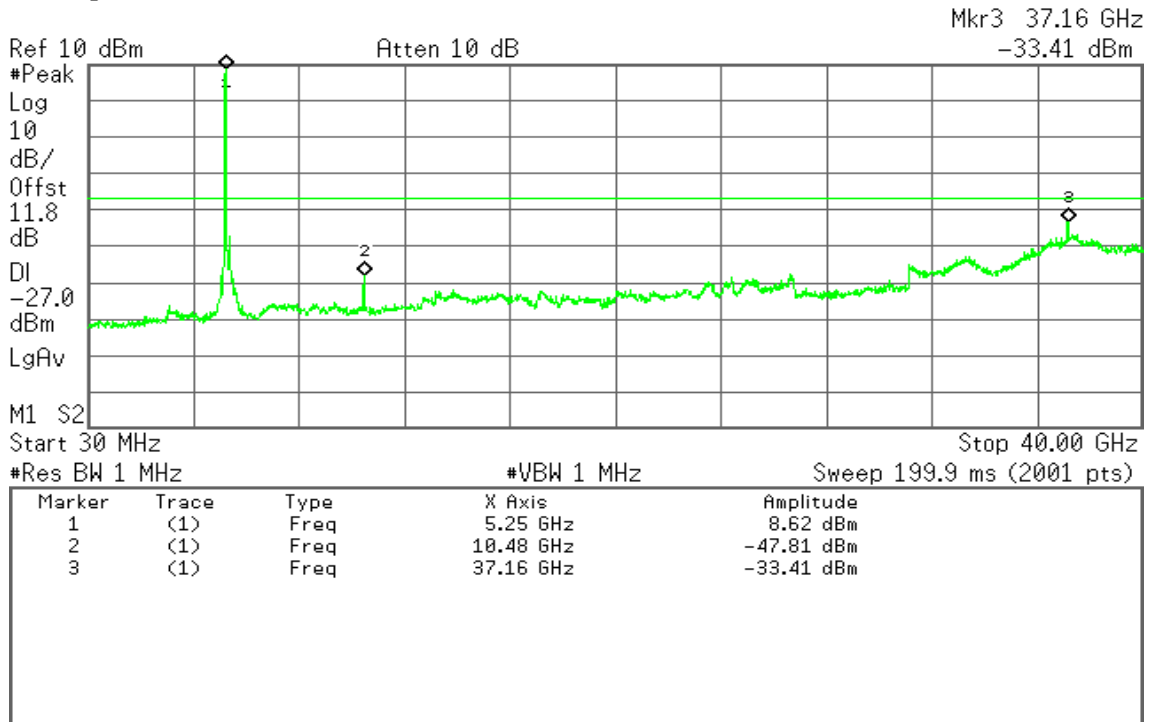

IEEE 802.11n HT 20 MHz mode / 5180 ~ 5240MHz

CH Low

Agilent 17:13:01 Oct 31, 2012

R T

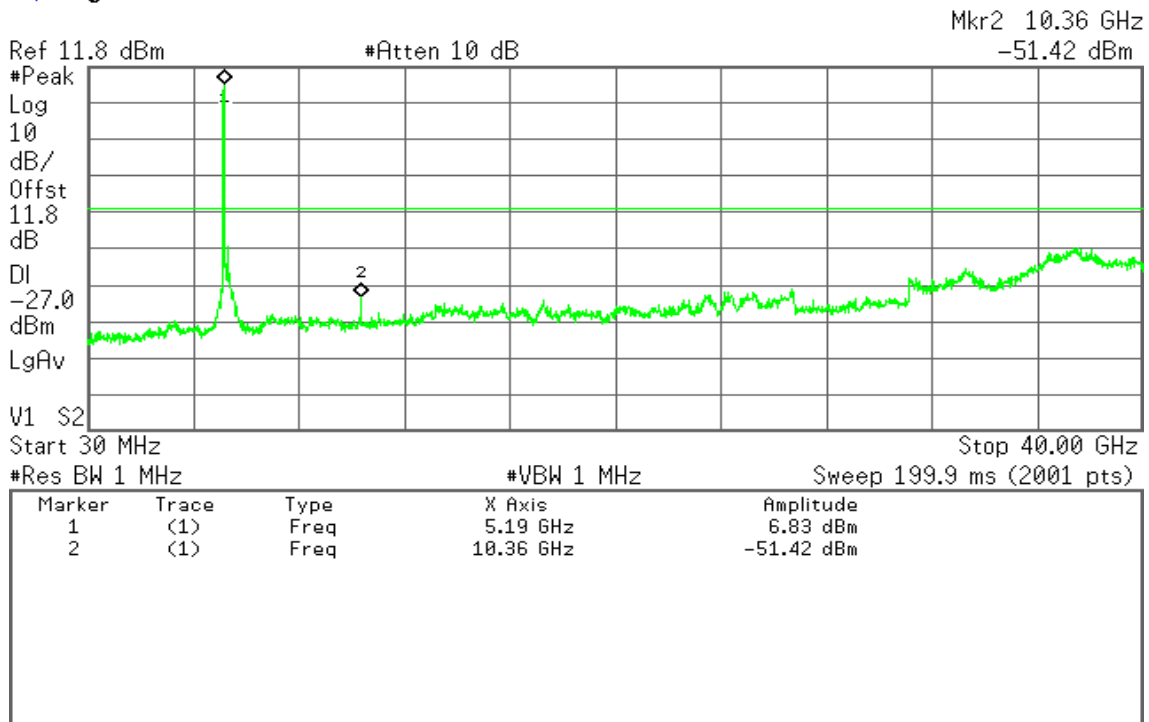



CH Mid

Agilent 17:17:15 Oct 31, 2012

R T

Mkr2 10.44 GHz
-52.95 dBm

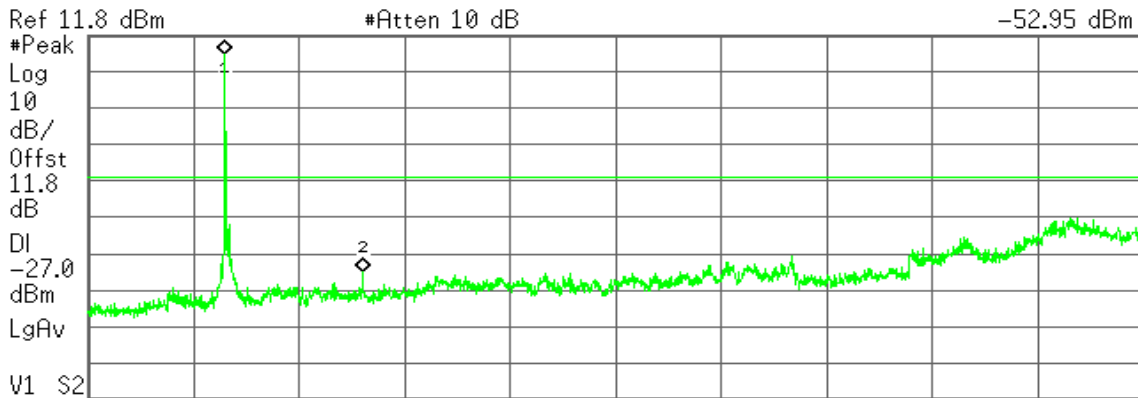

Start 30 MHz Stop 40.00 GHz
#Res BW 1 MHz #VBW 1 MHz Sweep 199.9 ms (2001 pts)

Marker	Trace	Type	X Axis	Amplitude
1	(1)	Freq	5.23 GHz	6.59 dBm
2	(1)	Freq	10.44 GHz	-52.95 dBm

CH High

Agilent 17:21:37 Oct 31, 2012

R T

Mkr2 10.48 GHz
-51.83 dBm

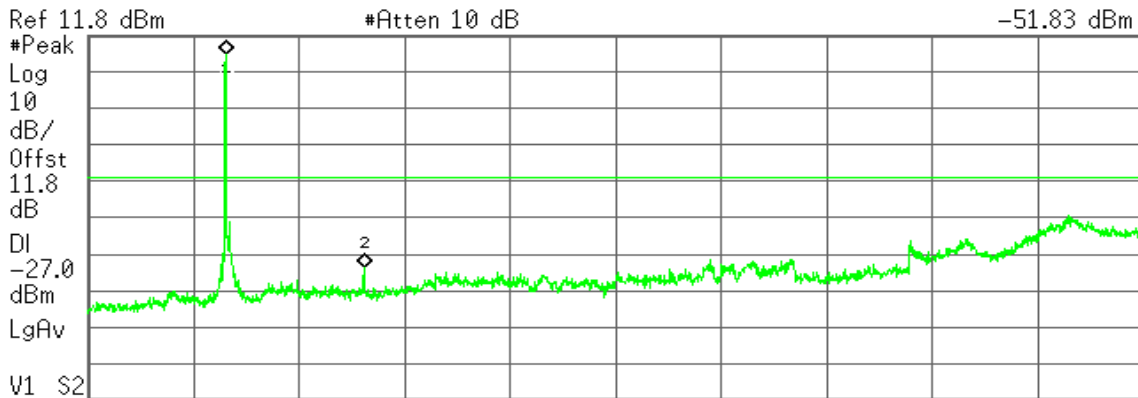

Start 30 MHz Stop 40.00 GHz
#Res BW 1 MHz #VBW 1 MHz Sweep 199.9 ms (2001 pts)

Marker	Trace	Type	X Axis	Amplitude
1	(1)	Freq	5.25 GHz	6.45 dBm
2	(1)	Freq	10.48 GHz	-51.83 dBm



IEEE 802.11a mode / 5260 ~ 5320MHz

CH Low

Agilent 19:23:32 Oct 30, 2012

R T

Mkr2 10.52 GHz
-48.19 dBm

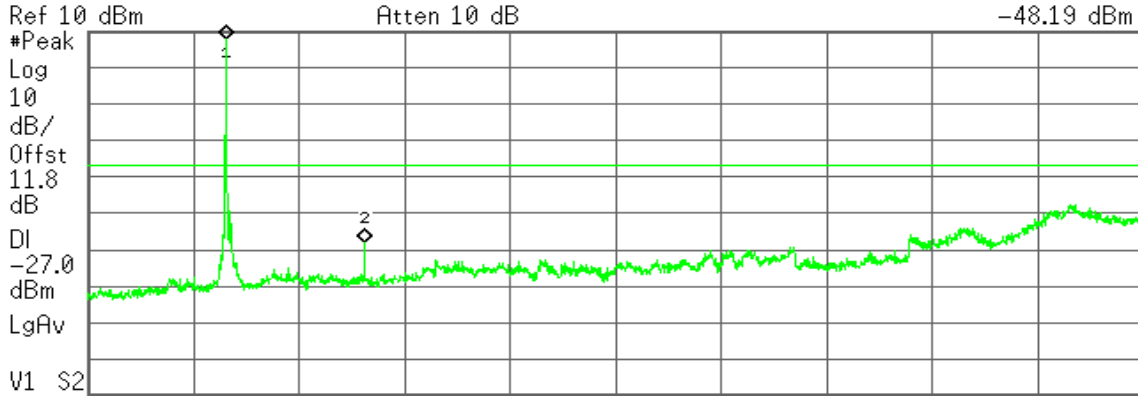

Start 30 MHz Stop 40.00 GHz
#Res BW 1 MHz #VBW 1 MHz Sweep 199.9 ms (2001 pts)

Marker	Trace	Type	X Axis	Amplitude
1	(1)	Freq	5.27 GHz	8.02 dBm
2	(1)	Freq	10.52 GHz	-48.19 dBm

CH Mid

Agilent 19:27:52 Oct 30, 2012

R T

Mkr2 10.56 GHz
-49.42 dBm

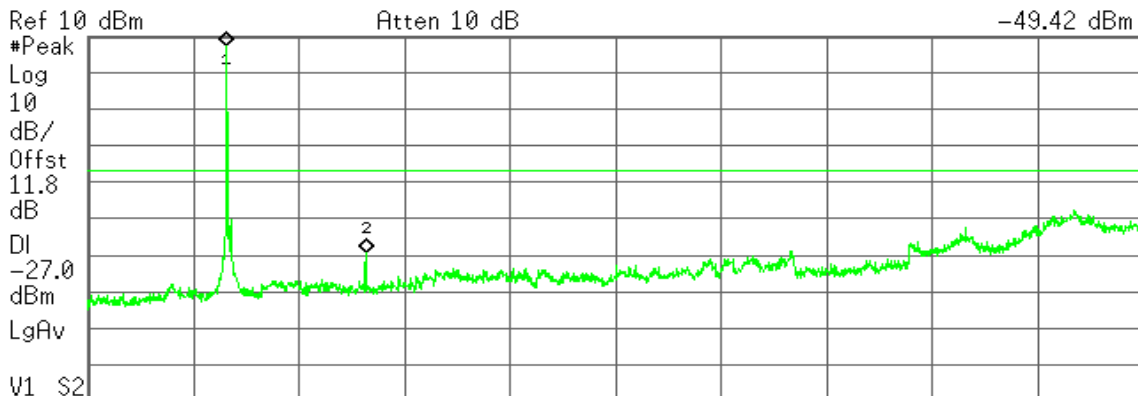

Start 30 MHz Stop 40.00 GHz
#Res BW 1 MHz #VBW 1 MHz Sweep 199.9 ms (2001 pts)

Marker	Trace	Type	X Axis	Amplitude
1	(1)	Freq	5.29 GHz	7.35 dBm
2	(1)	Freq	10.56 GHz	-49.42 dBm



CH High

Agilent 19:31:24 Oct 30, 2012

R T

Mkr2 10.64 GHz
-49.43 dBm

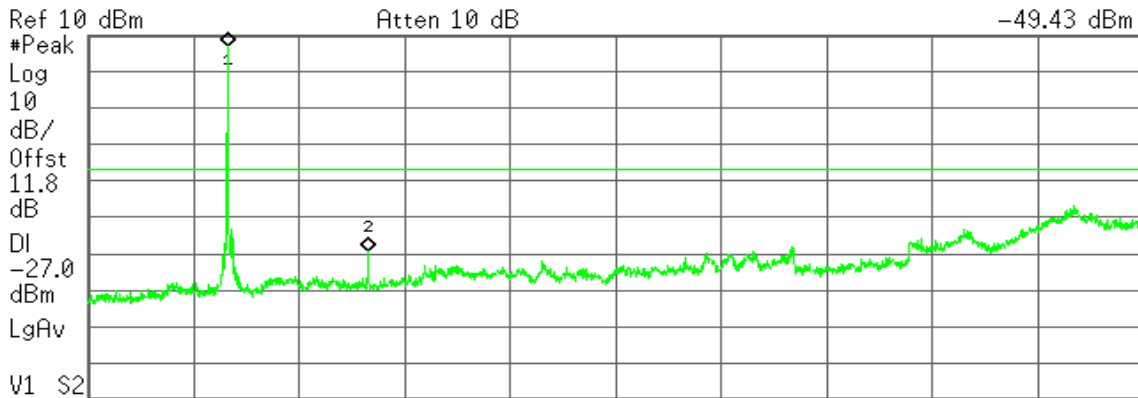

Start 30 MHz Stop 40.00 GHz
#Res BW 1 MHz #VBW 1 MHz Sweep 199.9 ms (2001 pts)

Marker	Trace	Type	X Axis	Amplitude
1	(1)	Freq	5.33 GHz	7.05 dBm
2	(1)	Freq	10.64 GHz	-49.43 dBm

IEEE 802.11n HT 20 MHz mode / 5260 ~ 5320MHz

CH Low

Agilent 19:48:49 Oct 30, 2012

R T

Mkr2 10.52 GHz
-51.68 dBm

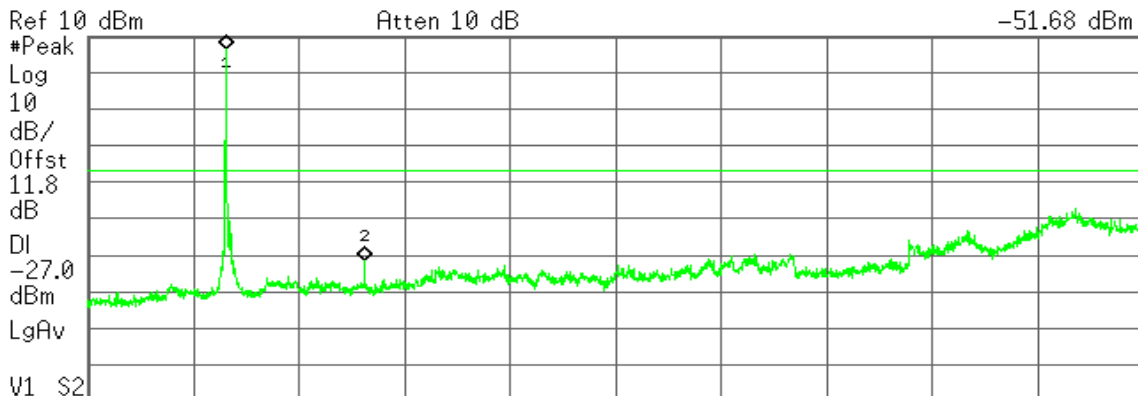

Start 30 MHz Stop 40.00 GHz
#Res BW 1 MHz #VBW 1 MHz Sweep 199.9 ms (2001 pts)

Marker	Trace	Type	X Axis	Amplitude
1	(1)	Freq	5.27 GHz	6.68 dBm
2	(1)	Freq	10.52 GHz	-51.68 dBm



CH Mid

Agilent 19:51:59 Oct 30, 2012

R T

Mkr2 10.56 GHz
-51.22 dBm

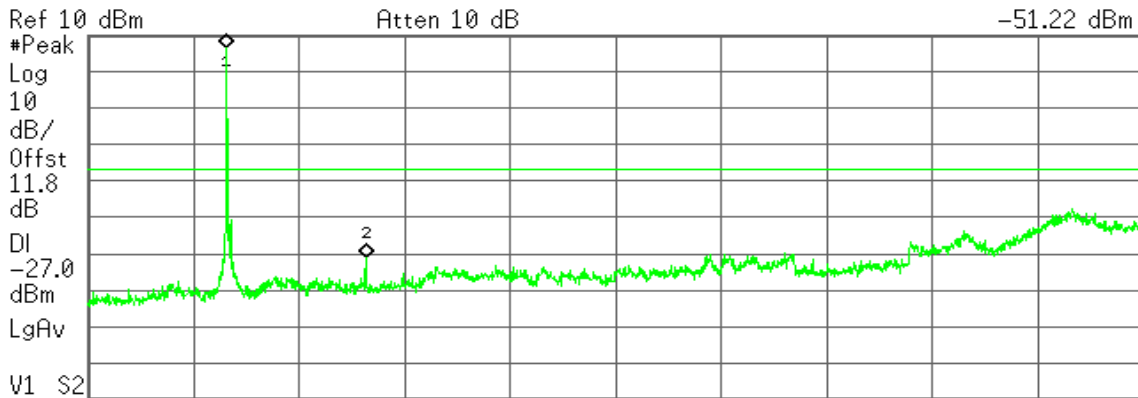

Start 30 MHz Stop 40.00 GHz
#Res BW 1 MHz #VBW 1 MHz Sweep 199.9 ms (2001 pts)

Marker	Trace	Type	X Axis	Amplitude
1	(1)	Freq	5.29 GHz	6.69 dBm
2	(1)	Freq	10.56 GHz	-51.22 dBm

CH High

Agilent 19:55:46 Oct 30, 2012

R T

Mkr2 10.64 GHz
-49.35 dBm

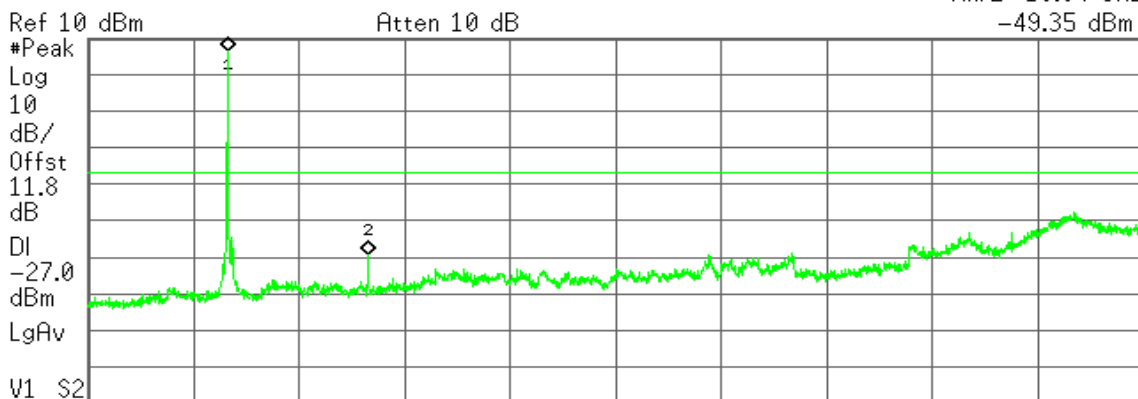

Start 30 MHz Stop 40.00 GHz
#Res BW 1 MHz #VBW 1 MHz Sweep 199.9 ms (2001 pts)

Marker	Trace	Type	X Axis	Amplitude
1	(1)	Freq	5.33 GHz	6.53 dBm
2	(1)	Freq	10.64 GHz	-49.35 dBm



Test mode: IEEE 802.11a mode / 5500 ~ 5700MHz

CH Low

Agilent 19:36:05 Oct 30, 2012

R T

Mkr1 5.51 GHz
5.33 dBm

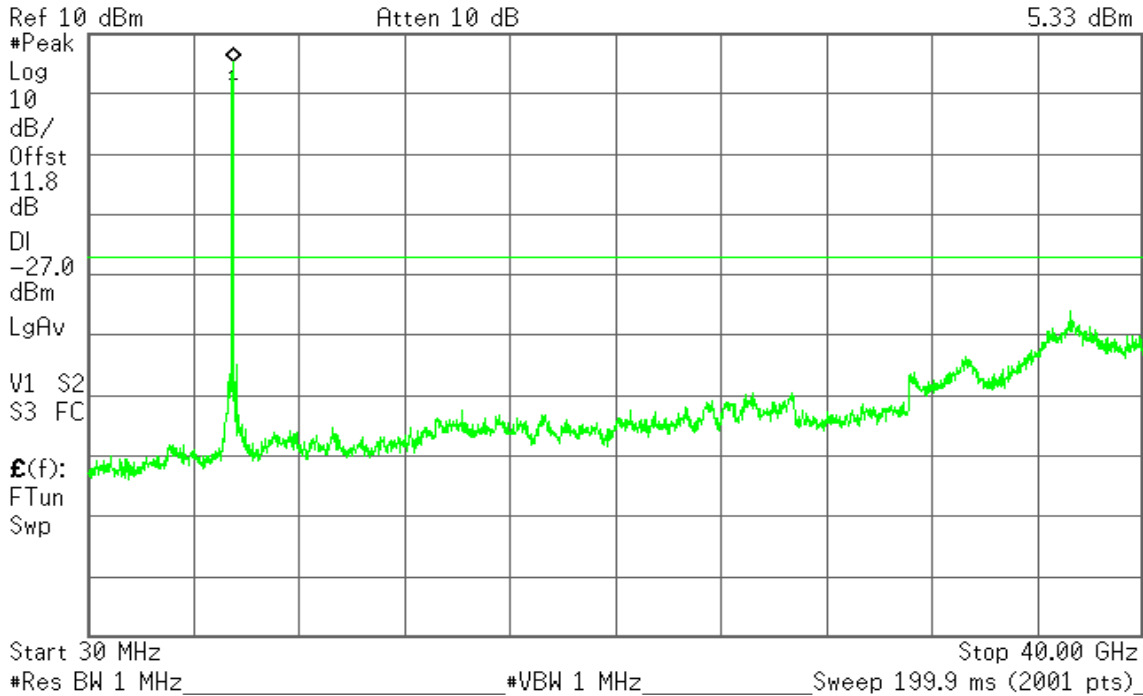

CH Mid

Agilent 19:39:13 Oct 30, 2012

R T

Mkr1 5.59 GHz
3.80 dBm

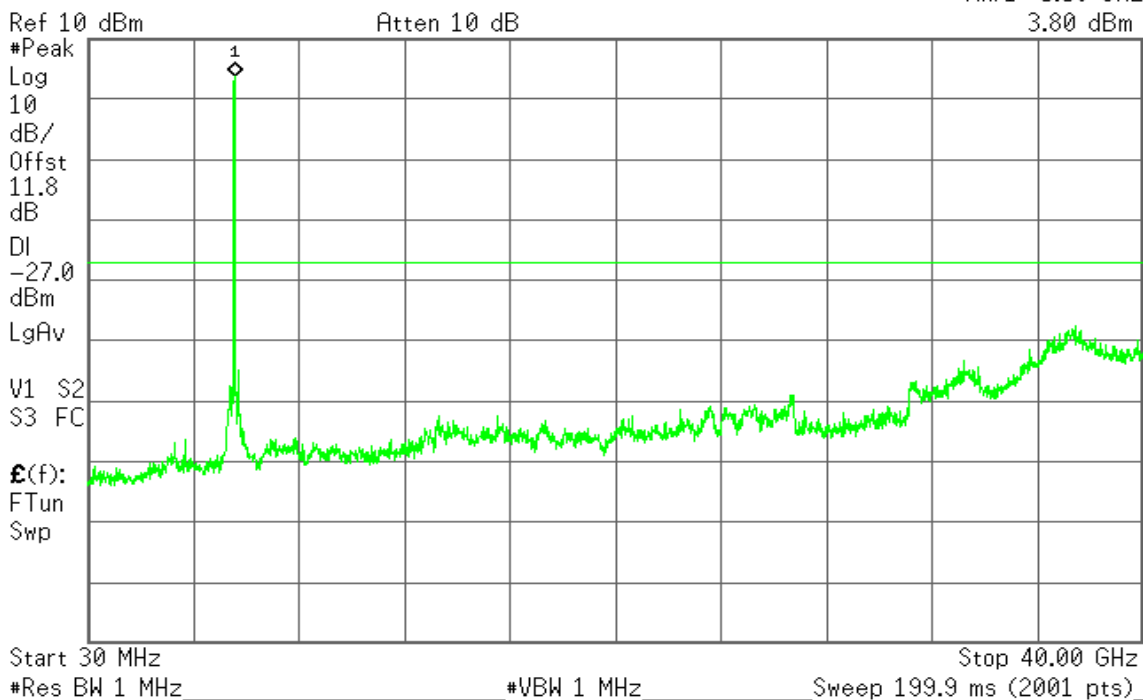



CH High

Agilent 19:42:33 Oct 30, 2012

R T

Mkr1 5.71 GHz
1.06 dBm

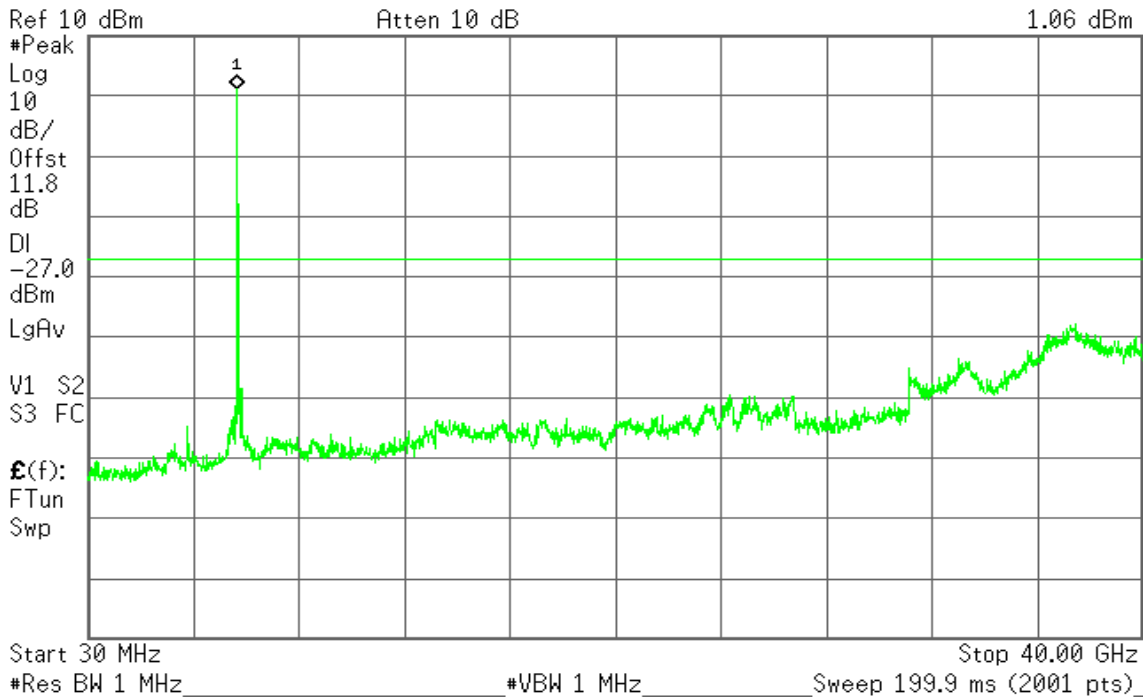

IEEE 802.11n HT 20 MHz mode / 5500 ~ 5700MHz

CH Low

Agilent 19:59:41 Oct 30, 2012

R T

Mkr1 5.51 GHz
3.71 dBm

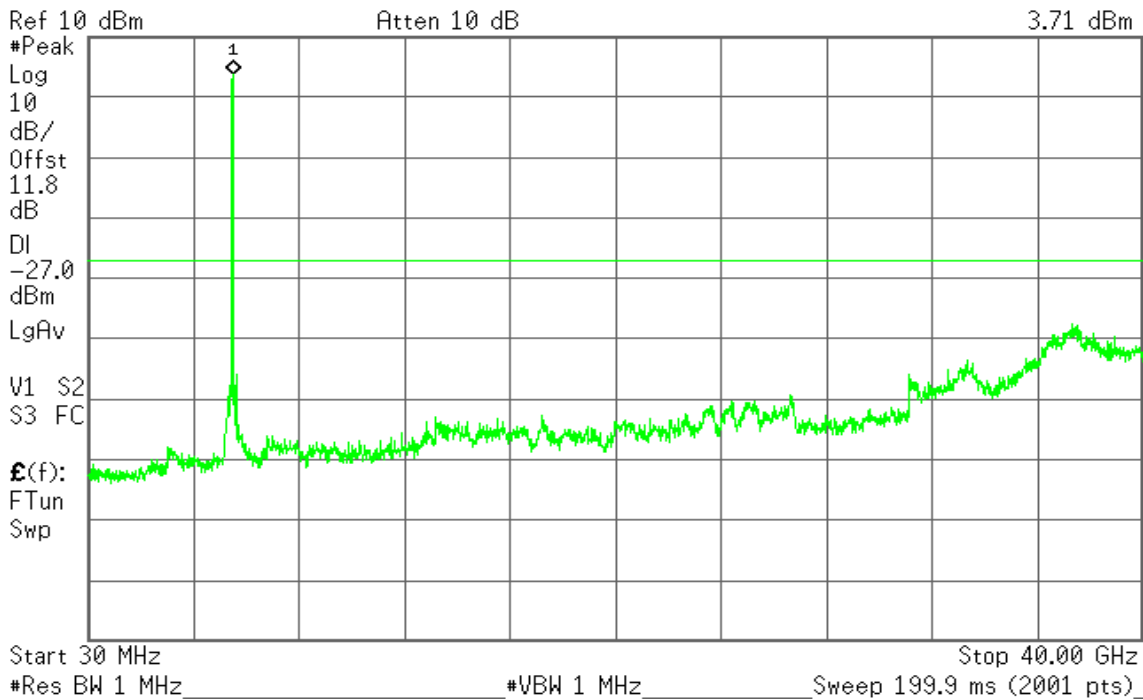



CH Mid

Agilent 20:02:39 Oct 30, 2012

R T

Mkr1 5.59 GHz
2.57 dBm

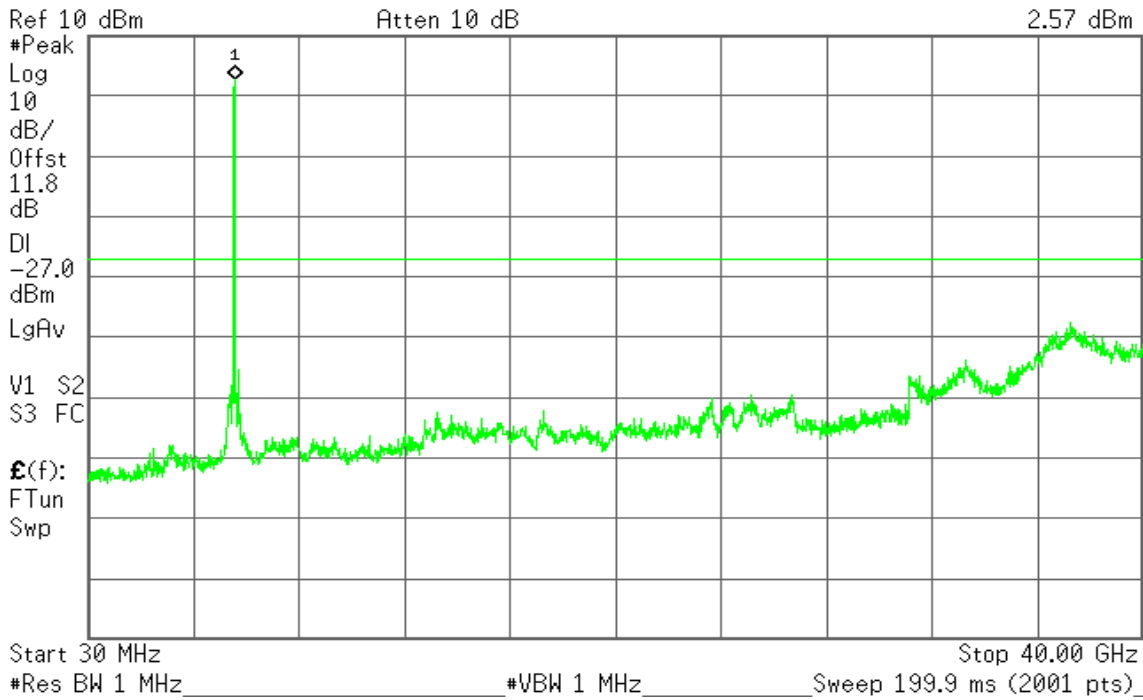

CH High

Agilent 20:05:55 Oct 30, 2012

R T

Mkr1 5.71 GHz
3.12 dBm

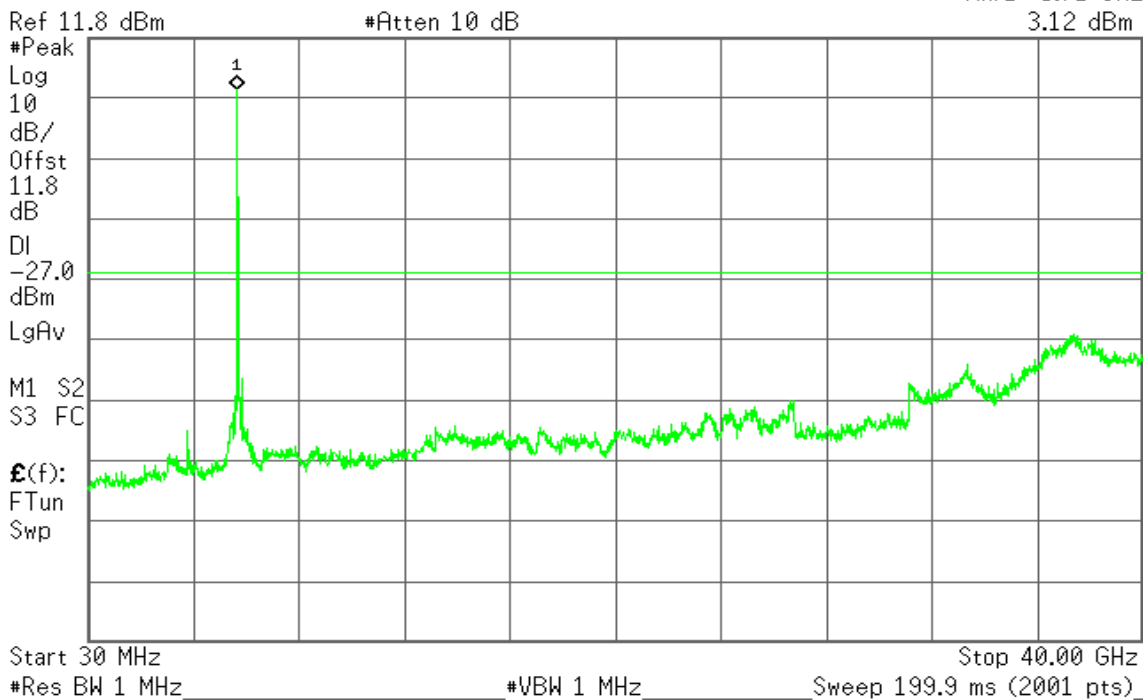



7.8 POWERLINE CONDUCTED EMISSIONS

LIMIT

According to §15.207(a), except as shown in paragraphs (b) and (c) of this section, for an intentional radiator that is designed to be connected to the public utility (AC) power line, the radio frequency voltage that is conducted back onto the AC power line on any frequency or frequencies within the band 150 kHz to 30 MHz shall not exceed the limits in the following table, as measured using a 50 μ H/50 ohms line impedance stabilization network (LISN). Compliance with the provisions of this paragraph shall be based on the measurement of the radio frequency voltage between each power line and ground at the power terminal. The lower limit applies at the boundary between the frequency ranges.

Frequency Range (MHz)	Limits (dB μ V)	
	Quasi-peak	Average
0.15 to 0.50	66 to 56*	56 to 46*
0.50 to 5	56	46
5 to 30	60	50

* Decreases with the logarithm of the frequency.

TEST CONFIGURATION

See test photographs attached in Appendix 1 for the actual connections between EUT and support equipment.

TEST PROCEDURE

1. The EUT was placed on a table, which is 0.8m above ground plane.
2. Maximum procedure was performed on the six highest emissions to ensure EUT compliance.
3. Repeat above procedures until all frequency measured were complete.

**TEST RESULTS**

The initial step in collecting conducted data is a spectrum analyzer peak scan of the measurement range. Significant peaks are then marked as shown on the following data page, and these signals are then quasi-peaked.

Test Data

Operation Mode: Normal Link **Test Date:** October 26, 2012
Temperature: 24°C **Tested by:** Moore Cheng
Humidity: 50% RH

Freq. (MHz)	QP Reading (dBuV)	AV Reading (dBuV)	Corr. factor (dB/m)	QP Result (dBuV/m)	AV Result (dBuV/m)	QP Limit (dBuV)	AV Limit (dBuV)	QP Margin (dB)	AV Margin (dB)	Note
0.1660	34.28	19.85	9.87	44.15	29.72	65.15	55.16	-21.00	-25.44	L1
0.2100	27.49	15.57	9.87	37.36	25.44	63.20	53.21	-25.84	-27.77	L1
0.6460	23.65	18.05	9.89	33.54	27.94	56.00	46.00	-22.46	-18.06	L1
8.9580	23.16	17.54	10.13	33.29	27.67	60.00	50.00	-26.71	-22.33	L1
17.7500	19.46	13.11	10.34	29.80	23.45	60.00	50.00	-30.20	-26.55	L1
21.8700	17.32	11.74	10.46	27.78	22.20	60.00	50.00	-32.22	-27.80	L1
0.1660	34.73	18.17	9.63	44.36	27.80	65.15	55.16	-20.79	-27.36	L2
0.3260	21.69	14.87	9.65	31.34	24.52	59.55	49.55	-28.21	-25.03	L2
0.6340	24.62	18.93	9.67	34.29	28.60	56.00	46.00	-21.71	-17.40	L2
4.5460	19.52	12.24	9.82	29.34	22.06	56.00	46.00	-26.66	-23.94	L2
9.8580	21.25	16.03	9.96	31.21	25.99	60.00	50.00	-28.79	-24.01	L2
18.0260	19.12	13.07	10.23	29.35	23.30	60.00	50.00	-30.65	-26.70	L2

Remark:

1. Measuring frequencies from 0.15 MHz to 30MHz.
2. The emissions measured in frequency range from 0.15 MHz to 30MHz were made with an instrument using Quasi-peak detector and average detector.
3. The IF bandwidth of SPA between 0.15MHz and 30MHz was 10 kHz; the IF bandwidth of Test Receiver between 0.15MHz and 30MHz was 9 kHz;
4. L1 = Line One (Live Line) / L2 = Line Two (Neutral Line)



Test Plots

Conducted emissions (Line 1)

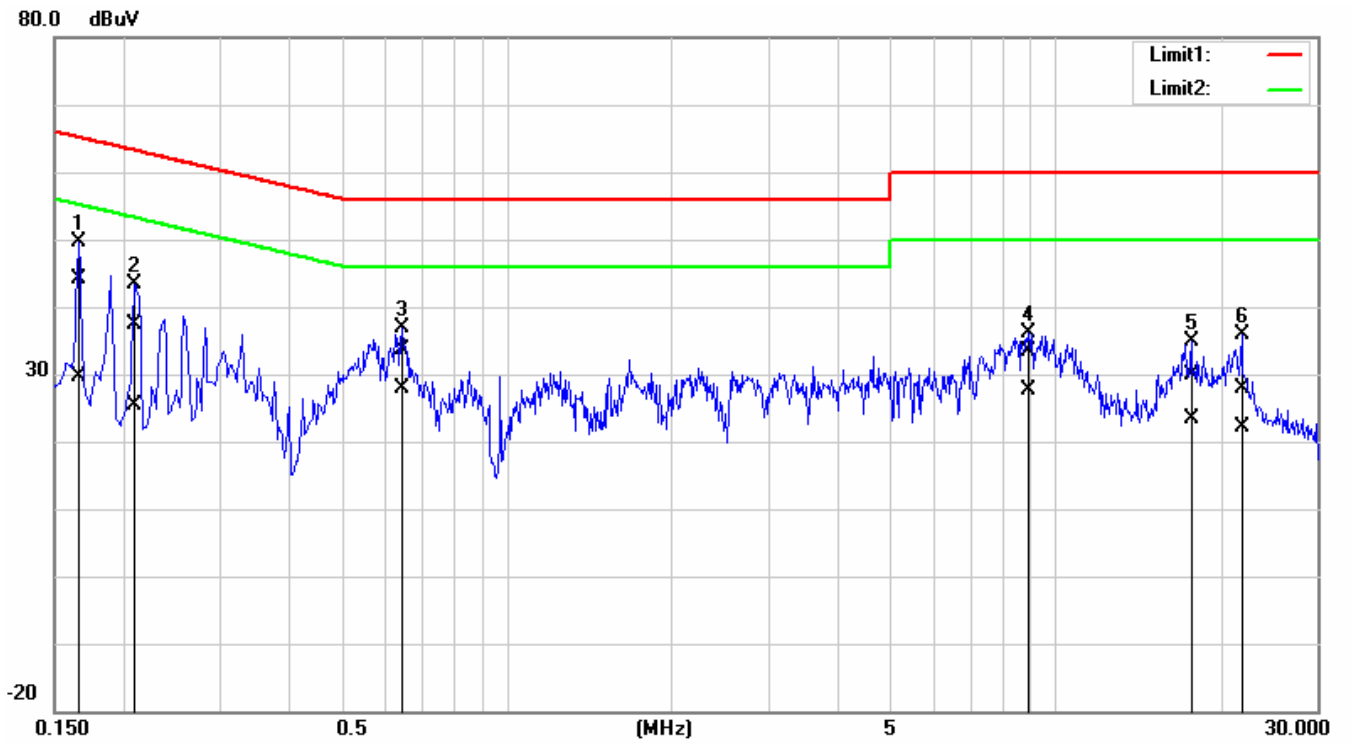

Conducted emissions (Line 2)

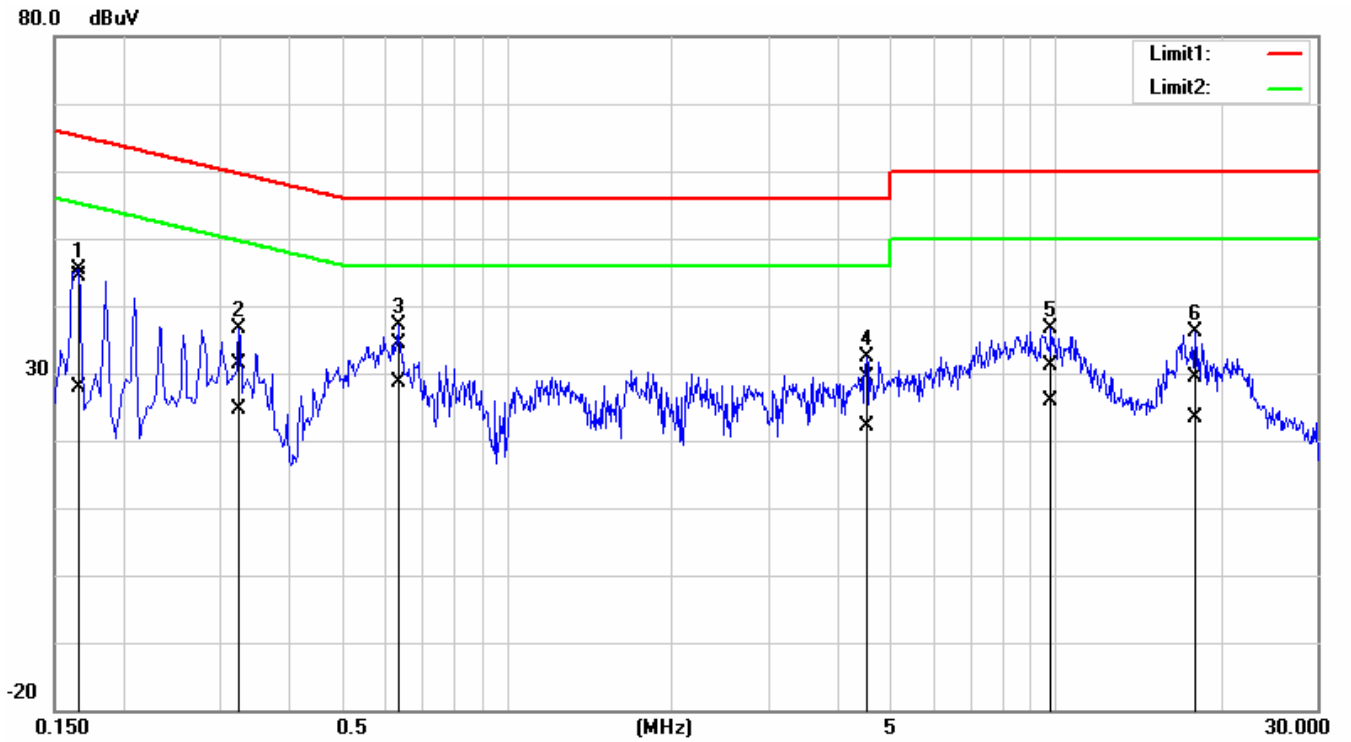



7.9 FREQUENCY STABILITY

LIMIT

According to §15.407(g), manufacturers of U-NII devices are responsible for ensuring frequency stability such that an emission is maintained within the band of operation under all conditions of normal operation as specified in the user's manual.

Test Configuration

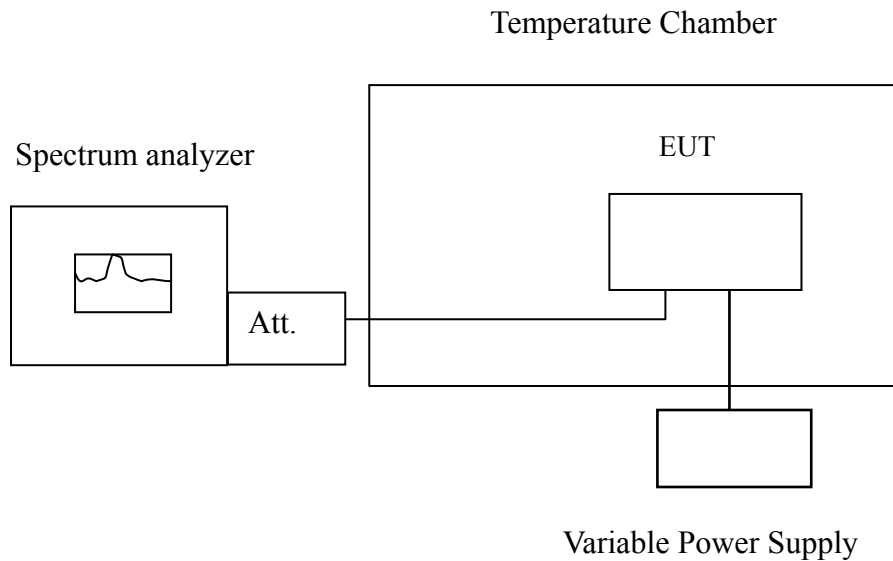

Remark: Measurement setup for testing on Antenna connector



TEST PROCEDURE

The equipment under test was connected to an external AC or DC power supply and input rated voltage. RF output was connected to a frequency counter or spectrum analyzer via feed through attenuators. The EUT was placed inside the temperature chamber. Set the spectrum analyzer RBW low enough to obtain the desired frequency resolution and measure EUT 20°C operating frequency as reference frequency. Turn EUT off and set the chamber temperature to -20°C. After the temperature stabilized for approximately 30 minutes recorded the frequency. Repeat step measure with 10°C increased per stage until the highest temperature of +50°C reached.

TEST RESULTS

No non-compliance noted.

IEEE 802.11a mode / 5180 ~ 5240 MHz:

CH Low

Operating Frequency: 5180 MHz				
Environment Temperature (°C)	Voltage (V)	Measured Frequency (MHz)	Limit Range	Test Result
50	110	5179.989565	5150~5250	Pass
40	110	5179.988320	5150~5250	Pass
30	110	5179.998235	5150~5250	Pass
20	110	5180.007437	5150~5250	Pass
10	110	5179.991485	5150~5250	Pass
0	110	5179.985975	5150~5250	Pass
-10	110	5179.974236	5150~5250	Pass
-20	110	5179.990652	5150~5250	Pass

Operating Frequency: 5180 MHz				
Environment Temperature (°C)	Voltage (V)	Measured Frequency (MHz)	Limit Range	Test Result
20	99	5180.004122	5150~5250	Pass
	110	5180.004512	5150~5250	Pass
	121	5179.998922	5150~5250	Pass



CH High

Operating Frequency: 5240 MHz				
Environment Temperature (°C)	Voltage (V)	Measured Frequency (MHz)	Limit Range	Test Result
50	110	5239.989452	5150~5250	Pass
40	110	5240.020647	5150~5250	Pass
30	110	5240.003290	5150~5250	Pass
20	110	5239.970020	5150~5250	Pass
10	110	5239.998240	5150~5250	Pass
0	110	5240.018270	5150~5250	Pass
-10	110	5240.002685	5150~5250	Pass
-20	110	5239.977845	5150~5250	Pass

Operating Frequency: 5240 MHz				
Environment Temperature (°C)	Voltage (V)	Measured Frequency (MHz)	Limit Range	Test Result
20	99	5240.017424	5150~5250	Pass
	110	5239.996425	5150~5250	Pass
	121	5239.988885	5150~5250	Pass



IEEE 802.11n HT 20 MHz mode / 5180 ~ 5240 MHz:

CH Low

Operating Frequency: 5180 MHz				
Environment Temperature (°C)	Voltage (V)	Measured Frequency (MHz)	Limit Range	Test Result
50	110	5240.007474	5150~5250	Pass
40	110	5239.974194	5150~5250	Pass
30	110	5239.994154	5150~5250	Pass
20	110	5240.015372	5150~5250	Pass
10	110	5239.998314	5150~5250	Pass
0	110	5240.014170	5150~5250	Pass
-10	110	5239.985424	5150~5250	Pass
-20	110	5239.999047	5150~5250	Pass

Operating Frequency: 5180 MHz				
Environment Temperature (°C)	Voltage (V)	Measured Frequency (MHz)	Limit Range	Test Result
20	99	5239.985845	5150~5250	Pass
	110	5240.000245	5150~5250	Pass
	121	5239.976755	5150~5250	Pass



CH High

Operating Frequency: 5240 MHz				
Environment Temperature (°C)	Voltage (V)	Measured Frequency (MHz)	Limit Range	Test Result
50	110	5240.007474	5150~5250	Pass
40	110	5239.974194	5150~5250	Pass
30	110	5239.994154	5150~5250	Pass
20	110	5240.015372	5150~5250	Pass
10	110	5239.998314	5150~5250	Pass
0	110	5240.014170	5150~5250	Pass
-10	110	5239.985424	5150~5250	Pass
-20	110	5239.999047	5150~5250	Pass

Operating Frequency: 5240 MHz				
Environment Temperature (°C)	Voltage (V)	Measured Frequency (MHz)	Limit Range	Test Result
20	99	5239.985845	5150~5250	Pass
	110	5240.000245	5150~5250	Pass
	121	5239.976755	5150~5250	Pass



IEEE 802.11a mode / 5260 ~ 5320 MHz:

CH Low

Operating Frequency: 5260 MHz				
Environment Temperature (°C)	Voltage (V)	Measured Frequency (MHz)	Limit Range	Test Result
50	110	5260.000780	5250~5350	Pass
40	110	5259.981938	5250~5350	Pass
30	110	5260.004912	5250~5350	Pass
20	110	5260.013441	5250~5350	Pass
10	110	5260.047851	5250~5350	Pass
0	110	5259.978114	5250~5350	Pass
-10	110	5259.971350	5250~5350	Pass
-20	110	5260.015207	5250~5350	Pass

Operating Frequency: 5260 MHz				
Environment Temperature (°C)	Voltage (V)	Measured Frequency (MHz)	Limit Range	Test Result
20	99	5260.008806	5250~5350	Pass
	110	5259.987968	5250~5350	Pass
	121	5260.001798	5250~5350	Pass



CH High

Operating Frequency: 5320 MHz				
Environment Temperature (°C)	Voltage (V)	Measured Frequency (MHz)	Limit Range	Test Result
50	110	5320.015021	5250~5350	Pass
40	110	5320.010240	5250~5350	Pass
30	110	5319.983545	5250~5350	Pass
20	110	5320.009328	5250~5350	Pass
10	110	5319.995052	5250~5350	Pass
0	110	5319.988027	5250~5350	Pass
-10	110	5319.982589	5250~5350	Pass
-20	110	5319.997878	5250~5350	Pass

Operating Frequency: 5320 MHz				
Environment Temperature (°C)	Voltage (V)	Measured Frequency (MHz)	Limit Range	Test Result
20	99	5319.979285	5250~5350	Pass
	110	5319.983498	5250~5350	Pass
	121	5320.016241	5250~5350	Pass



IEEE 802.11n HT 20 MHz mode / 5260 ~ 5320 MHz:

CH Low

Operating Frequency: 5260 MHz				
Environment Temperature (°C)	Voltage (V)	Measured Frequency (MHz)	Limit Range	Test Result
50	110	5260.006765	5250~5350	Pass
40	110	5259.988354	5250~5350	Pass
30	110	5259.991983	5250~5350	Pass
20	110	5259.995440	5250~5350	Pass
10	110	5260.014624	5250~5350	Pass
0	110	5259.983864	5250~5350	Pass
-10	110	5259.994107	5250~5350	Pass
-20	110	5259.981503	5250~5350	Pass

Operating Frequency: 5260 MHz				
Environment Temperature (°C)	Voltage (V)	Measured Frequency (MHz)	Limit Range	Test Result
20	99	5260.009741	5250~5350	Pass
	110	5259.993321	5250~5350	Pass
	121	5259.978913	5250~5350	Pass



CH High

Operating Frequency: 5320 MHz				
Environment Temperature (°C)	Voltage (V)	Measured Frequency (MHz)	Limit Range	Test Result
50	110	5320.008094	5250~5350	Pass
40	110	5319.974507	5250~5350	Pass
30	110	5320.010984	5250~5350	Pass
20	110	5320.008052	5250~5350	Pass
10	110	5319.999244	5250~5350	Pass
0	110	5320.014164	5250~5350	Pass
-10	110	5319.974987	5250~5350	Pass
-20	110	5319.999357	5250~5350	Pass

Operating Frequency: 5320 MHz				
Environment Temperature (°C)	Voltage (V)	Measured Frequency (MHz)	Limit Range	Test Result
20	99	5319.970164	5250~5350	Pass
	110	5319.984014	5250~5350	Pass
	121	5319.987335	5250~5350	Pass



IEEE 802.11a mode / 5500 ~ 5700 MHz:

CH Low

Operating Frequency: 5500 MHz				
Environment Temperature (°C)	Voltage (V)	Measured Frequency (MHz)	Limit Range	Test Result
50	110	5499.981545	5470~5725	Pass
40	110	5499.980725	5470~5725	Pass
30	110	5500.018785	5470~5725	Pass
20	110	5500.006820	5470~5725	Pass
10	110	5499.971298	5470~5725	Pass
0	110	5500.002674	5470~5725	Pass
-10	110	5500.020589	5470~5725	Pass
-20	110	5499.994924	5470~5725	Pass

Operating Frequency: 5500 MHz				
Environment Temperature (°C)	Voltage (V)	Measured Frequency (MHz)	Limit Range	Test Result
20	99	5499.976285	5470~5725	Pass
	110	5500.002325	5470~5725	Pass
	121	5499.974831	5470~5725	Pass



CH High

Operating Frequency: 5700 MHz				
Environment Temperature (°C)	Voltage (V)	Measured Frequency (MHz)	Limit Range	Test Result
50	110	5699.990575	5470~5725	Pass
40	110	5700.017006	5470~5725	Pass
30	110	5700.008576	5470~5725	Pass
20	110	5699.972451	5470~5725	Pass
10	110	5700.012964	5470~5725	Pass
0	110	5699.994966	5470~5725	Pass
-10	110	5700.013206	5470~5725	Pass
-20	110	5700.017128	5470~5725	Pass

Operating Frequency: 5700 MHz				
Environment Temperature (°C)	Voltage (V)	Measured Frequency (MHz)	Limit Range	Test Result
20	99	5700.005735	5470~5725	Pass
	110	5699.992222	5470~5725	Pass
	121	5699.987681	5470~5725	Pass



IEEE 802.11n HT 20 MHz mode / 5500 ~ 5700 MHz:

CH Low

Operating Frequency: 5500 MHz				
Environment Temperature (°C)	Voltage (V)	Measured Frequency (MHz)	Limit Range	Test Result
50	110	5499.984976	5470~5725	Pass
40	110	5499.971681	5470~5725	Pass
30	110	5500.007799	5470~5725	Pass
20	110	5499.977233	5470~5725	Pass
10	110	5500.012248	5470~5725	Pass
0	110	5499.999387	5470~5725	Pass
-10	110	5499.991675	5470~5725	Pass
-20	110	5499.984289	5470~5725	Pass

Operating Frequency: 5500 MHz				
Environment Temperature (°C)	Voltage (V)	Measured Frequency (MHz)	Limit Range	Test Result
20	99	5499.990697	5470~5725	Pass
	110	5500.009397	5470~5725	Pass
	121	5499.970732	5470~5725	Pass



CH High

Operating Frequency: 5700 MHz				
Environment Temperature (°C)	Voltage (V)	Measured Frequency (MHz)	Limit Range	Test Result
50	110	5699.972288	5470~5725	Pass
40	110	5699.987482	5470~5725	Pass
30	110	5699.972719	5470~5725	Pass
20	110	5699.982575	5470~5725	Pass
10	110	5700.013833	5470~5725	Pass
0	110	5699.973165	5470~5725	Pass
-10	110	5700.002159	5470~5725	Pass
-20	110	5699.982367	5470~5725	Pass

Operating Frequency: 5700 MHz				
Environment Temperature (°C)	Voltage (V)	Measured Frequency (MHz)	Limit Range	Test Result
20	99	5699.972476	5470~5725	Pass
	110	5699.991943	5470~5725	Pass
	121	5700.012427	5470~5725	Pass



7.10 DYNAMIC FREQUENCY SELECTION

LIMIT

According to §15.407 (h) and FCC 06-96 appendix “compliance measurement procedures for unlicensed-national information infrastructure devices operating in the 5250-5350 MHz and 5470-5725 MHz bands incorporating dynamic frequency selection”.

Table 1: Applicability of DFS requirements prior to use of a channel

Requirement	Operational Mode		
	Master	Client (without radar detection)	Client(with radar detection)
Non-Occupancy Period	Yes	Yes	Yes
DFS Detection Threshold	Yes	Not required	Yes
Channel Availability Check Time	Yes	Not required	Not required
Uniform Spreading	Yes	Not required	Not required
U-NII Detection Bandwidth	Yes	Not required	Yes

Table 2: Applicability of DFS requirements during normal operation

Requirement	Operational Mode		
	Master	Client (without radar detection)	Client(with radar detection)
DFS Detection Threshold	Yes	Not required	Yes
Channel Closing Transmission Time	Yes	Yes	Yes
Channel Move Time	Yes	Yes	Yes
U-NII Detection Bandwidth	Yes	Not required	Yes

Table 3: Interference Threshold values, Master or Client incorporating In-Service

Maximum Transmit Power	Value (see note)
≥ 200 Milliwatt	-64 dBm
< 200 Milliwatt	-62 dBm

Note 1: This is the level at the input of the receiver assuming a 0 dBi receive antenna.

Note 2: Throughout these test procedures an additional 1 dB has been added to the amplitude of the test transmission waveforms to account for variations in measurement equipment. This will ensure that the test signal is at or above the detection threshold level to trigger a DFS response.



Table 4: DFS Response requirement values

Parameter	Value
Non-occupancy period	30 minutes
Channel Availability Check Time	60 seconds
Channel Move Time	10 seconds
Channel Closing Transmission Time	200 milliseconds + approx. 60 milliseconds over remaining 10 second period
U-NII Detection Bandwidth	Minimum 80% of the UNII 99% transmission power bandwidth. See Note 3.

The instant that the Channel Move Time and the Channel Closing Transmission Time begins is as follows:

- For the Short pulse radar Test Signals this instant is the end of the Burst.
- For the Frequency Hopping radar Test Signal, this instant is the end of the last radar burst generated.
- For the Long Pulse radar Test Signal this instant is the end of the 12 second period defining the radar transmission.

The Channel Closing Transmission Time is comprised of 200 milliseconds starting at the beginning of the Channel Move Time plus any additional intermittent control signals required to facilitate channel changes (an aggregate of approximately 60 milliseconds) during the remainder of the 10 second period. The aggregate duration of control signals will not count quiet periods in between transmissions.

Table 5 – Short Pulse Radar Test Waveforms

Radar Type	Pulse Width (Microseconds)	PRI (Microseconds)	Pulses	Minimum Percentage of Successful Detection	Minimum Trials
1	1	1428	18	60%	30
2	1-5	150-230	23-29	60%	30
3	6-10	200-500	16-18	60%	30
4	11-20	200-500	12-16	60%	30
Aggregate (Radar Types 1-4)				80%	120

Table 6 – Long Pulse Radar Test Signal

Radar Waveform	Bursts	Pulses per Burst	Pulse Width (µsec)	Chirp Width (µsec)	PRI (µsec)	Minimum Percentage of Successful Detection	Minimum Trials
5	8-20	1-3	50-100	5-20	1000-2000	80%	30

Table 7 – Frequency Hopping Radar Test Signal

Radar Waveform	Pulse Width (µsec)	PRI (µsec)	Burst Length (ms)	Pulses Per Hop	Hopping Rate (kHz)	Minimum Percentage of Successful Detection	Minimum Trials
6	1	333	300	9	0.33	70%	30



DESCRIPTION OF EUT

Overview Of EUT With Respect To §15.407 (H) Requirements

The EUT operates over the 5250-5350 MHz and 5470-5725Mhz range as a Client Device that does not have radar detection capability.

The antenna assembly utilized with the EUT has a gain of 1.72 dBi.

The highest power level is 12.14 dBm EIRP in the 5250-5350 MHz band and 8.67dBm EIRP in 5470-5725MHz Band.

The EUT uses one transmitter connected to two 50-ohm coaxial antenna ports via a diversity switch. Two antenna port is connected to the test system since the EUT has two antenna.

The Slave device associated with the EUT during these tests does not have radar detection capability.

WLAN traffic is generated by streaming the video file TestFile.mp2 “6 ½ Magic Hours” from the Master to the Slave in full motion video mode using the media player with the V2.61 Codec package.

TPC is not required since the maximum EIRP is less than 500 mW (27 dBm).

The EUT utilizes the 802.11a architecture, with a nominal channel bandwidth of 20 MHz.

The Master Device is a Cisco Aironet 802.11a/b/g Access Point, FCC ID: LDK102056.

The rated output power of the Master unit is < 23dBm (EIRP). Therefore the required interference threshold level is -62 dBm. After correction for antenna gain and procedural adjustments, the required conducted threshold at the antenna port is $-62 + 5 = -57$ dBm.

The calibrated conducted DFS Detection Threshold level is set to -62 dBm. The tested level is lower than the required level hence it provides margin to the limit.

Manufacturer’s Statement Regarding Uniform Channel Spreading

The end product implements an automatic channel selection feature at startup such that operation commences on channels distributed across the entire set of allowed 5GHz channels. This feature will ensure uniform spreading is achieved while avoiding non-allowed channels due to prior radar events.



TEST AND MEASUREMENT SYSTEM

System Overview

The measurement system is based on a conducted test method.

The short pulse and long pulse signal generating system utilizes the NTIA software. The Vector Signal Generator has been validated by the NTIA. The hopping signal generating system utilizes the CCS simulated hopping method and system, which has been validated by the DoD, FCC and NTIA. The software selects waveform parameters from within the bounds of the signal type on a random basis using uniform distribution.

The short pulse types 2, 3 and 4, and the long pulse type 5 parameters are randomized at run-time.

The hopping type 6 pulse parameters are fixed while the hopping sequence is based on the August 2005 NTIA Hopping Frequency List. The initial starting point randomized at run-time and each subsequent starting point is incremented by 475. Each frequency in the 100-length segment is compared to the boundaries of the EUT Detection Bandwidth and the software creates a hopping burst pattern in accordance with Section 7.4.1.3 Method #2 Simulated Frequency Hopping Radar Waveform Generating Subsystem of FCC 06-96 APPENDIX. The frequency of the signal generator is incremented in 1 MHz steps from FL to FH for each successive trial. This incremental sequence is repeated as required to generate a minimum of 30 total trials and to maintain a uniform frequency distribution over the entire Detection Bandwidth.

The signal monitoring equipment consists of a spectrum analyzer set to display 8001 bins on the horizontal axis. The time-domain resolution is 2 msec / bin with a 16 second sweep time, meeting the 10 second short pulse reporting criteria. The aggregate ON time is calculated by multiplying the number of bins above a threshold during a particular observation period by the dwell time per bin, with the analyzer set to peak detection and max hold. The time-domain resolution is 3 msec / bin with a 24 second sweep time, meeting the 22 second long pulse reporting criteria and allowing a minimum of 10 seconds after the end of the long pulse waveform.

Should multiple RF ports be utilized for the Master and/or Slave devices (for example, for diversity or MIMO implementations), 50 ohm termination would be removed from the splitter so that connection can be established between splitter and the Master and/or Slave devices.

Conducted Method System Block Diagram

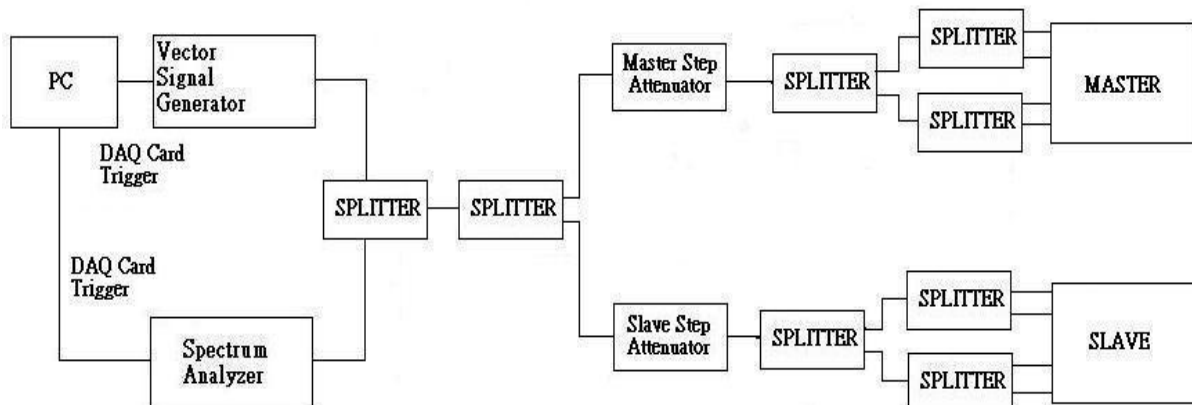



System Calibration

Connect the spectrum analyzer to the test system in place of the master device. Set the signal generator to CW mode. Adjust the amplitude of the signal generator to yield a measured level of -62 dBm on the spectrum analyzer.

Without changing any of the instrument settings, reconnect the spectrum analyzer to the Common port of the Spectrum Analyzer Combiner/Divider and connect a 50 ohm load to the Master Device port of the test system.

Measure the amplitude and calculate the difference from -62 dBm. Adjust the Reference Level Offset of the spectrum analyzer to this difference. Confirm that the signal is displayed at -62 dBm. Readjust the RBW and VBW to 3 MHz, set the span to 10 MHz, and confirm that the signal is still displayed at -62 dBm.

The spectrum analyzer displays the level of the signal generator as received at the antenna ports of the Master Device. The interference detection threshold may be varied from the calibrated value of -62 dBm and the spectrum analyzer will still indicate the level as received by the Master Device.

Set the signal generator to produce a radar waveform, trigger a burst manually and measure the level on the spectrum analyzer. Readjust the amplitude of the signal generator as required so that the peak level of the waveform is at a displayed level equal to the required or desired interference detection threshold. Separate signal generator amplitude settings are determined as required for each radar type.

Adjustment Of Displayed Traffic Level

Establish a link between the Master and Slave, adjusting the Link Step Attenuator as needed to provide a suitable received level at the Master and Slave devices. Stream the video test file to generate WLAN traffic. Confirm that the WLAN traffic level, as displayed on the spectrum analyzer, is at lower amplitude than the radar detection threshold. Confirm that the displayed traffic is from the Master Device. For Master Device testing confirm that the displayed traffic does not include Slave Device traffic. For Slave Device testing confirm that the displayed traffic does not include Master Device traffic.

If a different setting of the Master Step Attenuator is required to meet the above conditions, perform a new System Calibration for the new Master Step Attenuator setting.



Test Setup

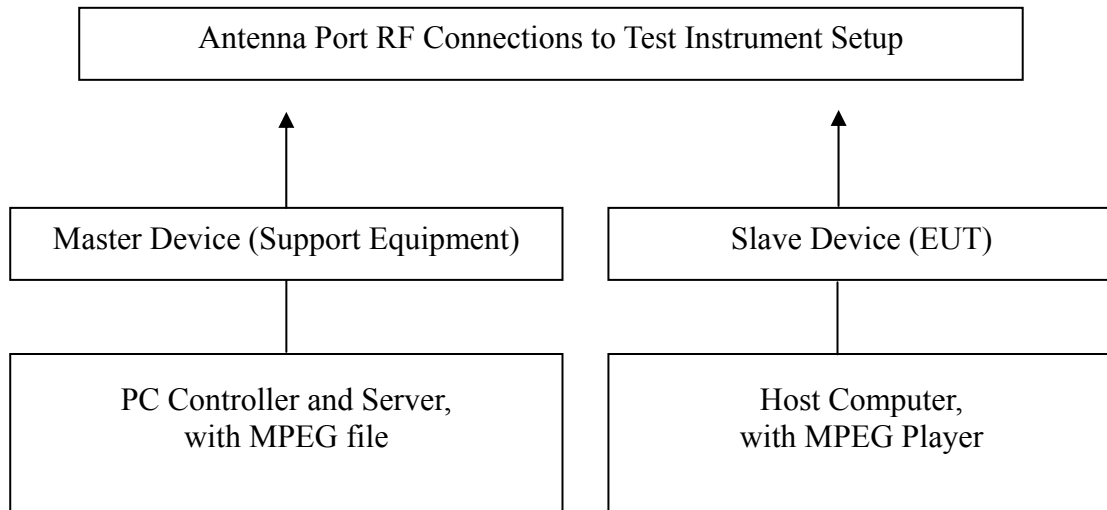

TEST RESULTS

No non-compliance noted



Test Plot

PLOTS OF RADAR WAVEFORMS

Sample of Short Pulse Radar Type 1

Agilent 07:42:53 Nov 22, 2012

R T

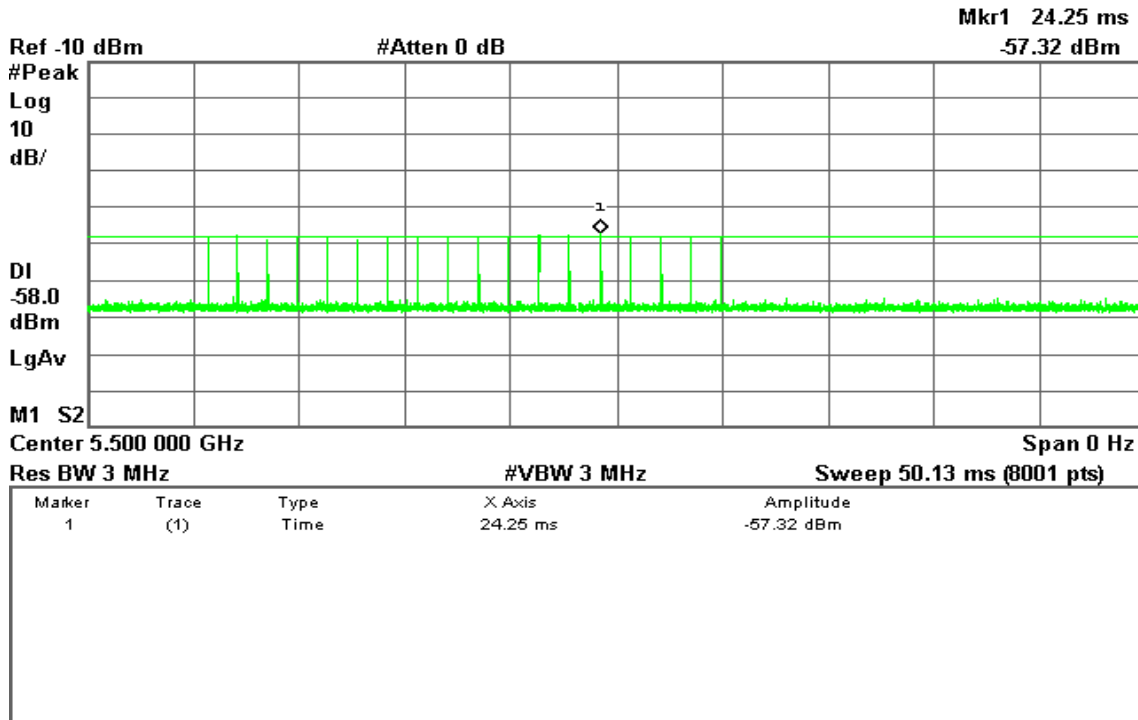

Sample of Short Pulse Radar Type 2

Agilent 07:44:15 Nov 22, 2012

R T

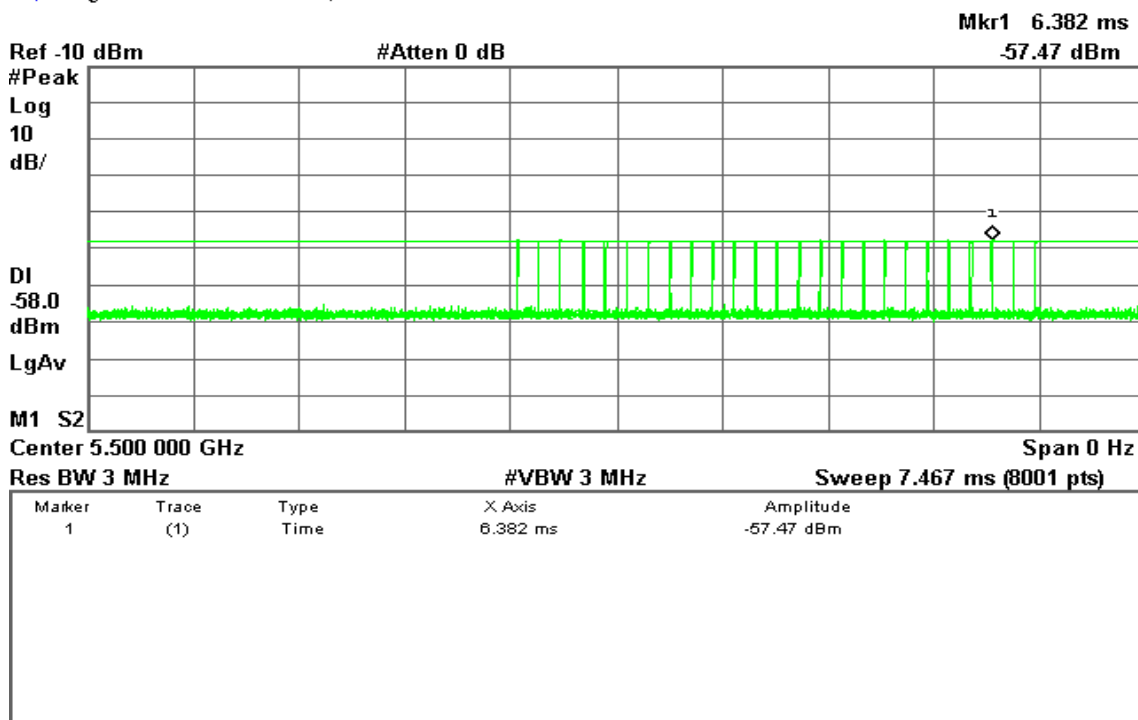



Sample of Short Pulse Radar Type 3

Agilent 07:45:28 Nov 22, 2012

R T

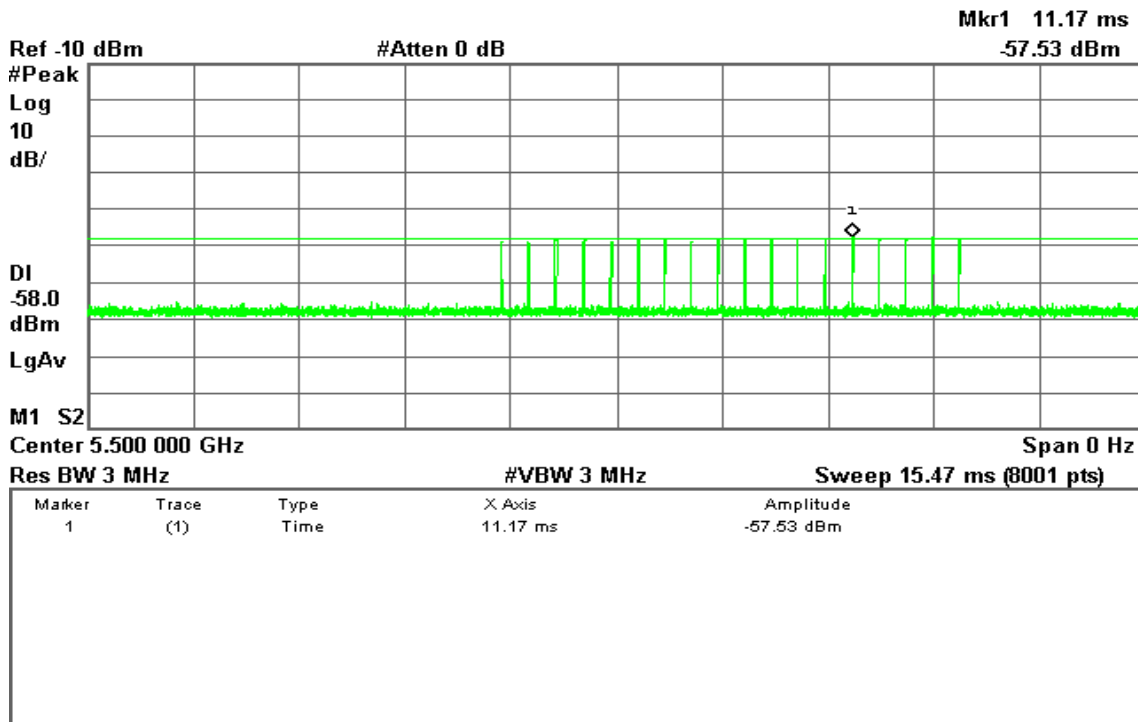

Sample of Short Pulse Radar Type 4

Agilent 07:47:33 Nov 22, 2012

R T

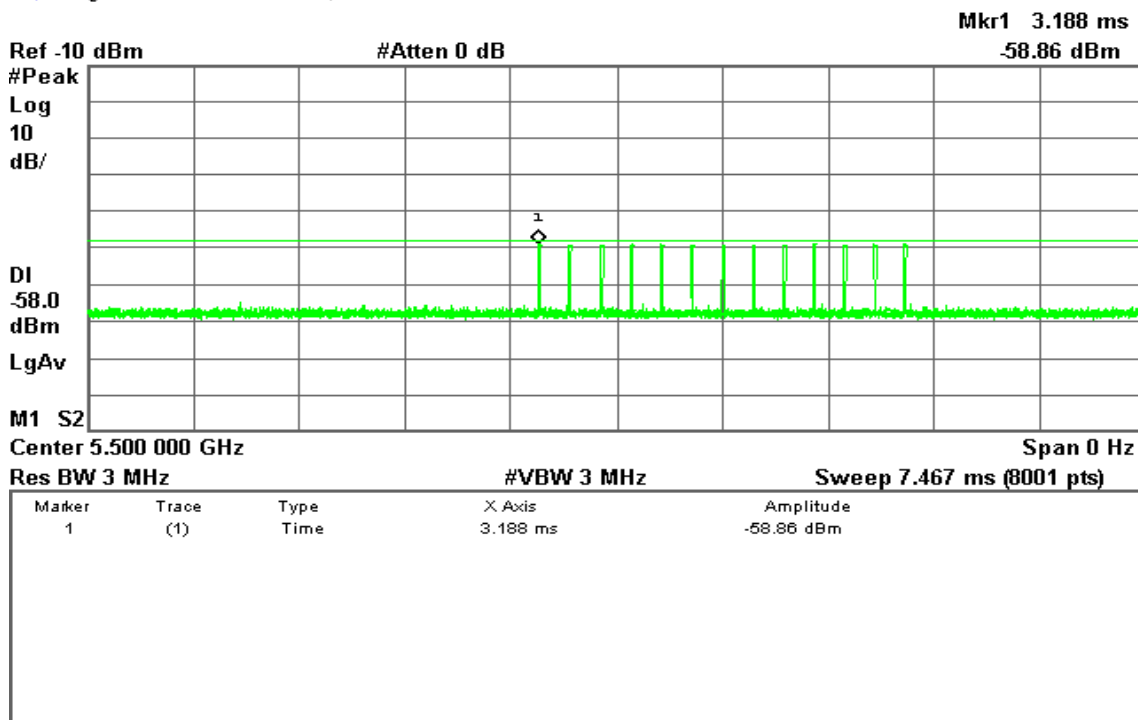



Sample of Long Pulse Radar Type 5

Agilent 07:40:30 Nov 22, 2012

R T

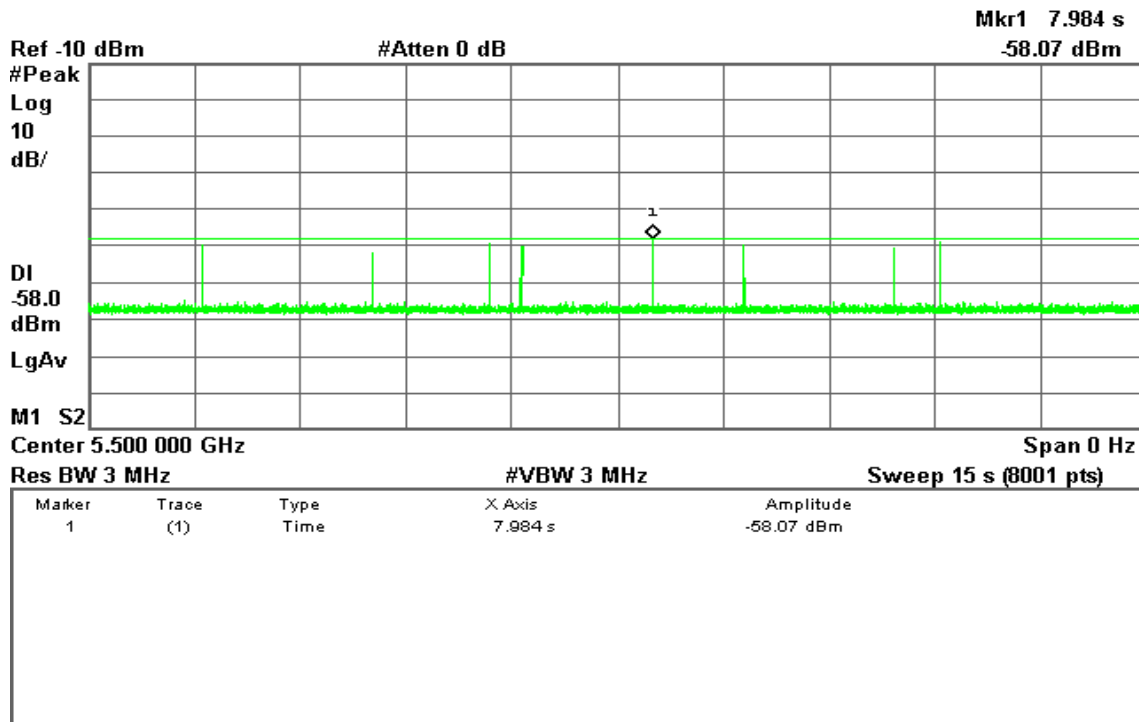

Sample of Frequency Hopping Radar Type 6

Agilent 07:51:31 Nov 22, 2012

R T

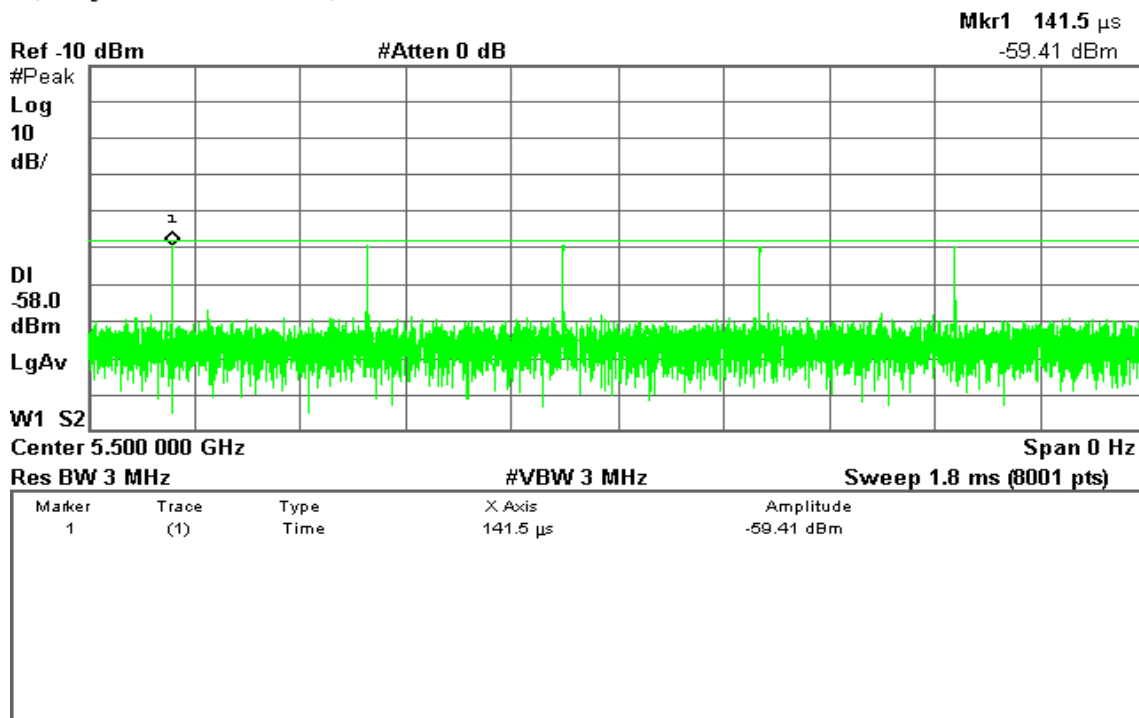



PLOT OF WLAN TRAFFIC FROM MASTER(20MHz)

Agilent 07:50:14 Nov 22, 2012

R T

Mkr1 341.9 ms
-58.22 dBm

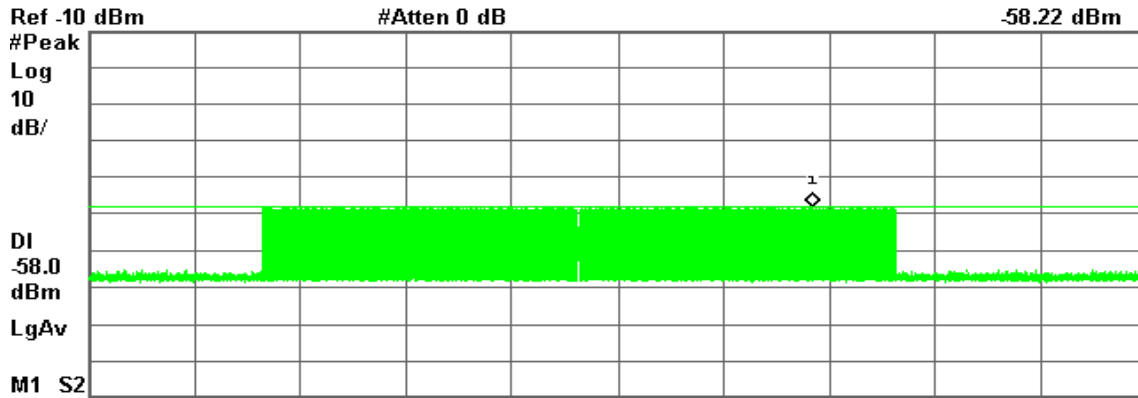

Center 5.500 000 GHz

Span 0 Hz

Res BW 3 MHz

#VBW 3 MHz

Sweep 500.3 ms (8001 pts)

Marker	Trace	Type	X Axis	Amplitude
1	(1)	Time	341.9 ms	-58.22 dBm



TEST CHANNEL AND METHOD

All tests were performed at a channel center frequency of IEEE 802.11n HT 20 MHz: 5300MHz and 5500MHz; utilizing a conducted test method.

CHANNEL MOVE TIME AND CHANNEL CLOSING TRANSMISSION TIME

GENERAL REPORTING NOTES

The reference marker is set at the end of last radar pulse.

The delta marker is set at the end of the last WLAN transmission following the radar pulse. This delta is the channel move time.

The aggregate channel closing transmission time is calculated as follows:

Aggregate Transmission Time =

(Number of analyzer bins showing transmission) * (dwell time per bin)

The observation period over which the aggregate time is calculated

Begins at (Reference Marker + 200 msec) and

Ends no earlier than (Reference Marker + 10 sec).



Observation: (5250~5350MHz Band) of IEEE 802.11 -5G (20MHz) CH60

Type 1 Channel Move Time Results

No non-compliance noted.

Channel Move Time (s)	Limit (s)
0.8419	10

Agilent 03:18:21 Nov 22, 2012

R T

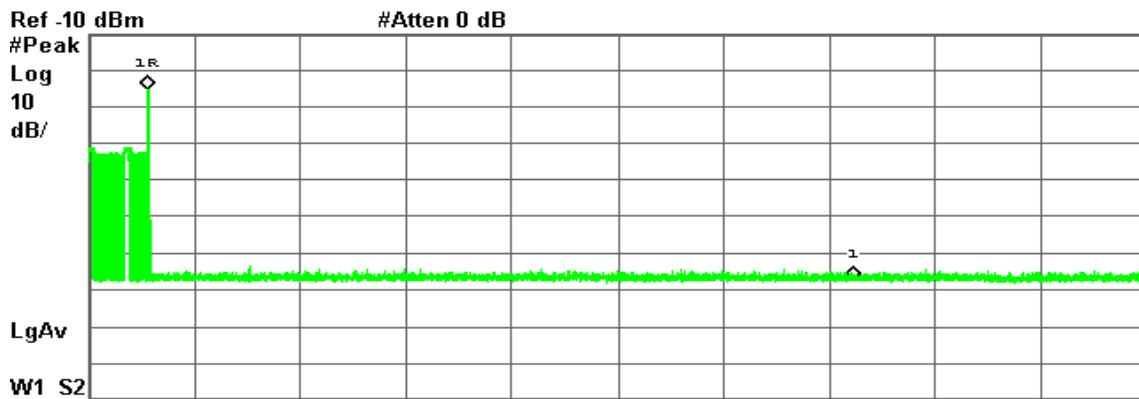

Center 5.300 000 GHz Span 0 Hz
 Res BW 3 MHz VBW 3 MHz Sweep 15 s (8001 pts)

Marker	Trace	Type	X Axis	Amplitude
1R	(1)	Time	841.9 ms	-25.15 dBm
1Δ	(1)	Time	10 s	-52.17 dB



Type 5 Channel Move Time Results

No non-compliance noted.

Channel Move Time (s)	Limit (s)
0.15	10

Agilent 06:06:25 Nov 22, 2012

T

Δ Mkr2 15 ms
-19.59 dB

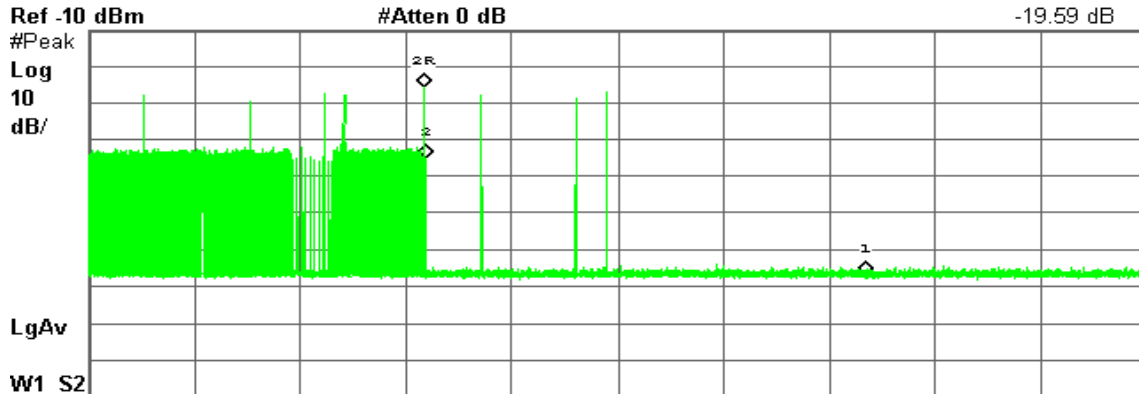

Center 5.300 000 GHz Span 0 Hz
Res BW 3 MHz VBW 3 MHz Sweep 24 s (8001 pts)

Marker	Trace	Type	X Axis	Amplitude
1R	(1)	Time	7.632 s	-25.63 dBm
1Δ	(1)	Time	10 s	-51.28 dB
2R	(1)	Time	7.632 s	-25.63 dBm
2Δ	(1)	Time	15 ms	-19.59 dB



Observation: (5250~5350MHz Band) of IEEE 802.11-5G (20MHz) CH60

Type 1 Channel Closing Transmission Time Results

No non-compliance noted.

Channel Closing Transmission Time (ms)	Limit (ms)	Margin (ms)
1.87	60	-58.13

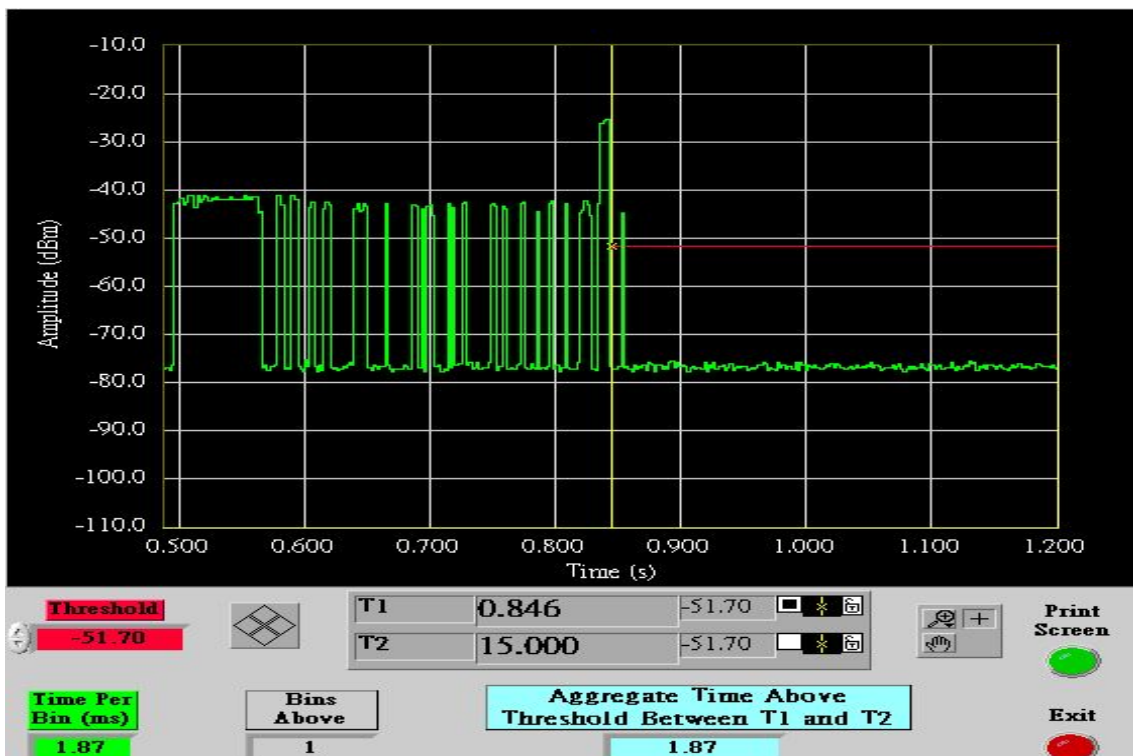
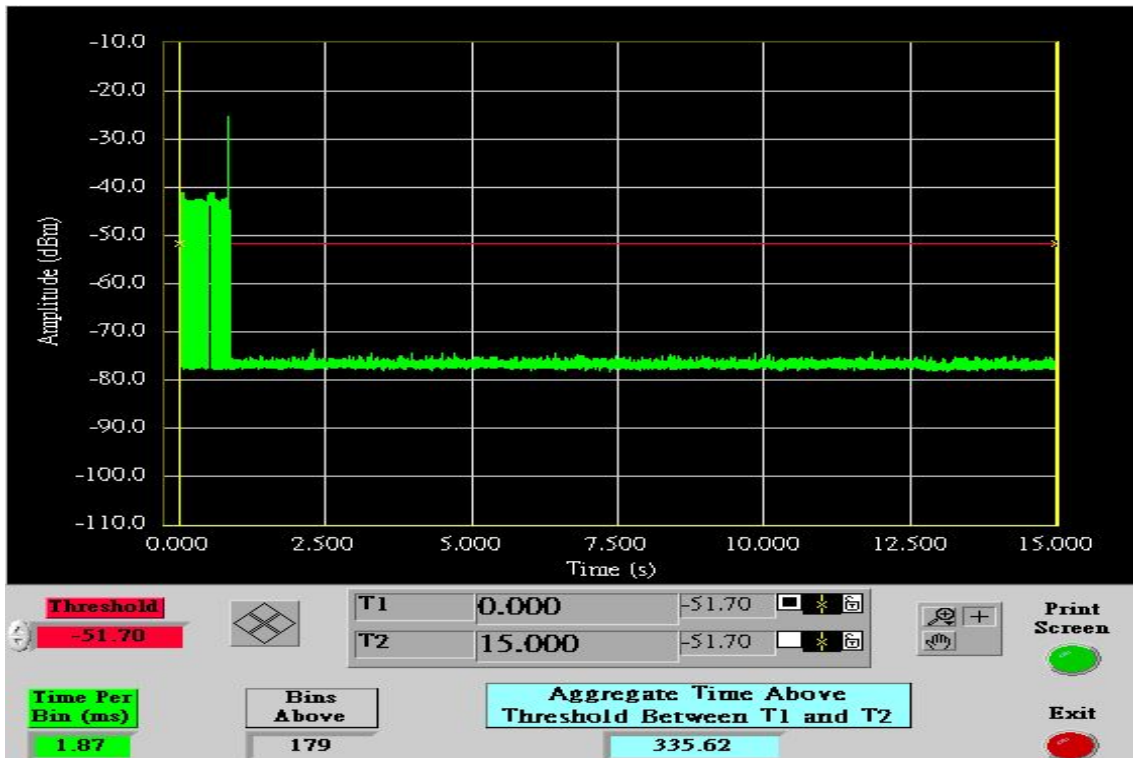

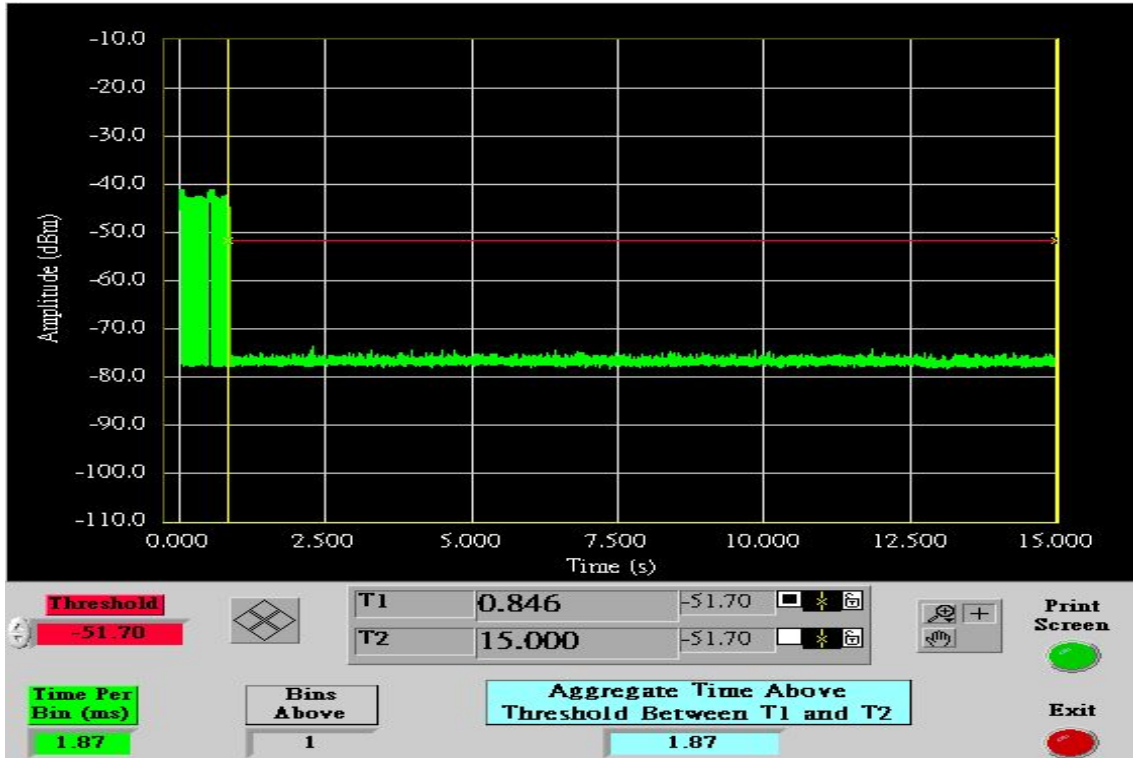



Type 5 Channel Closing Transmission Time Results

No non-compliance noted.

Channel Closing Transmission Time (ms)	Limit (ms)	Margin (ms)
12	60	-48

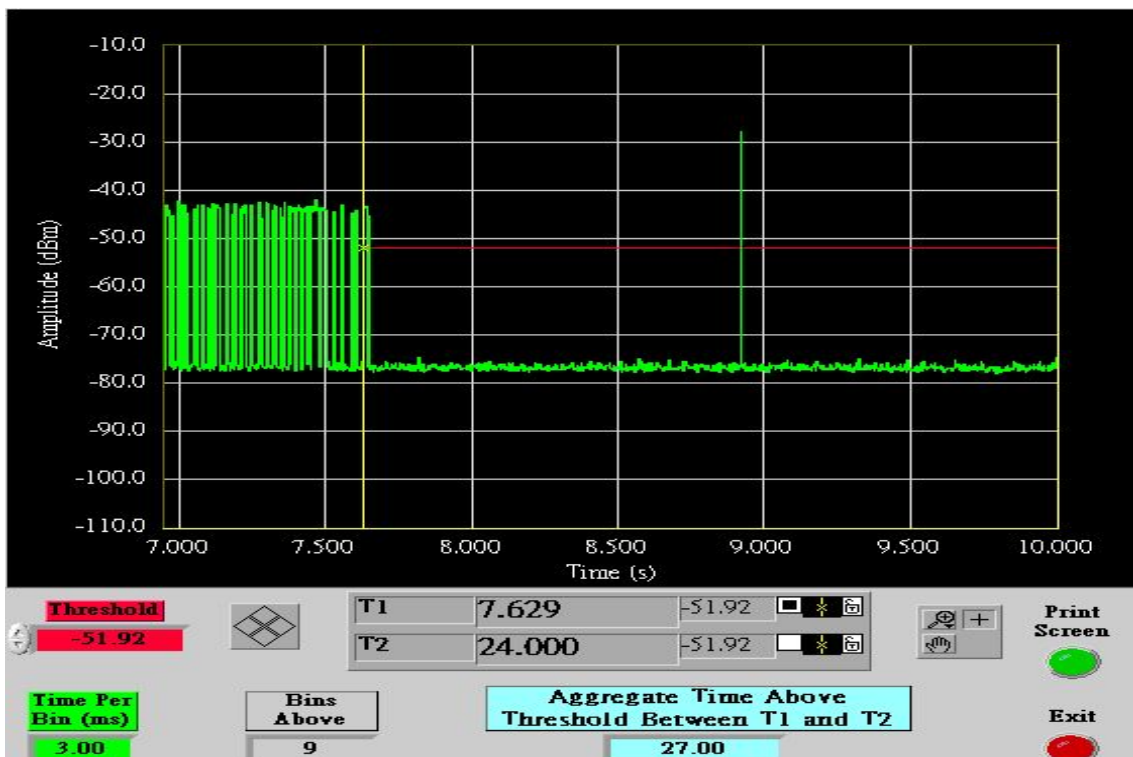
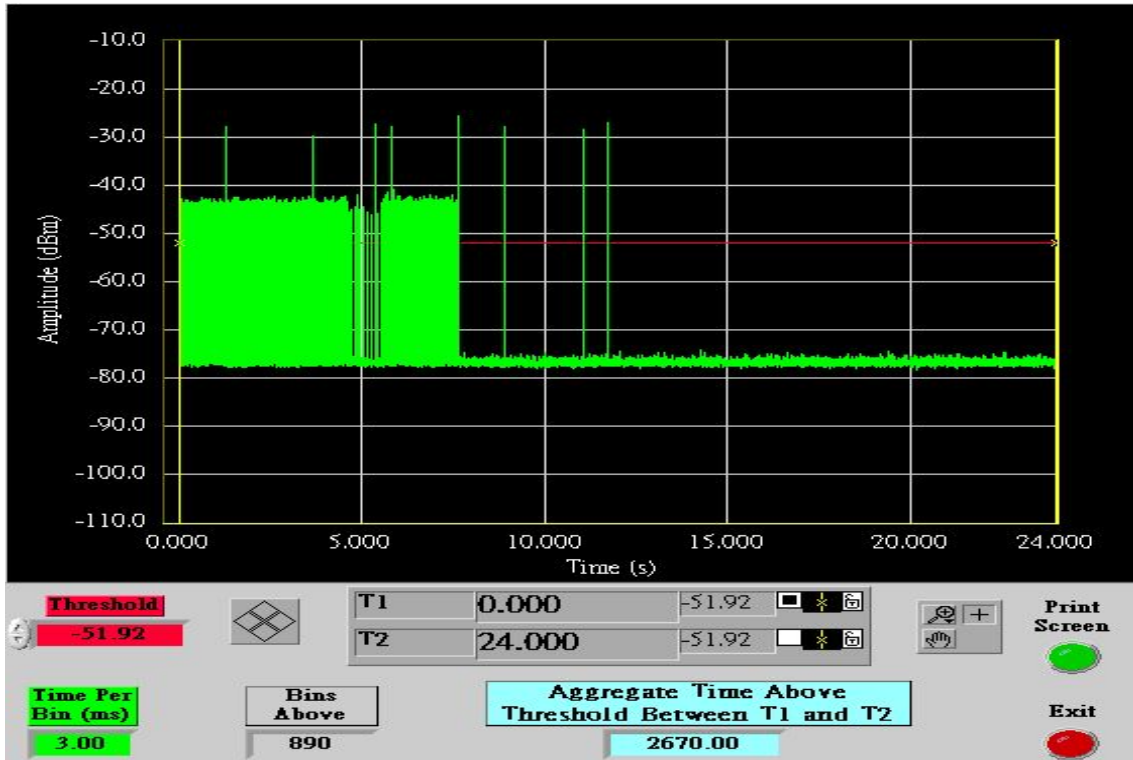

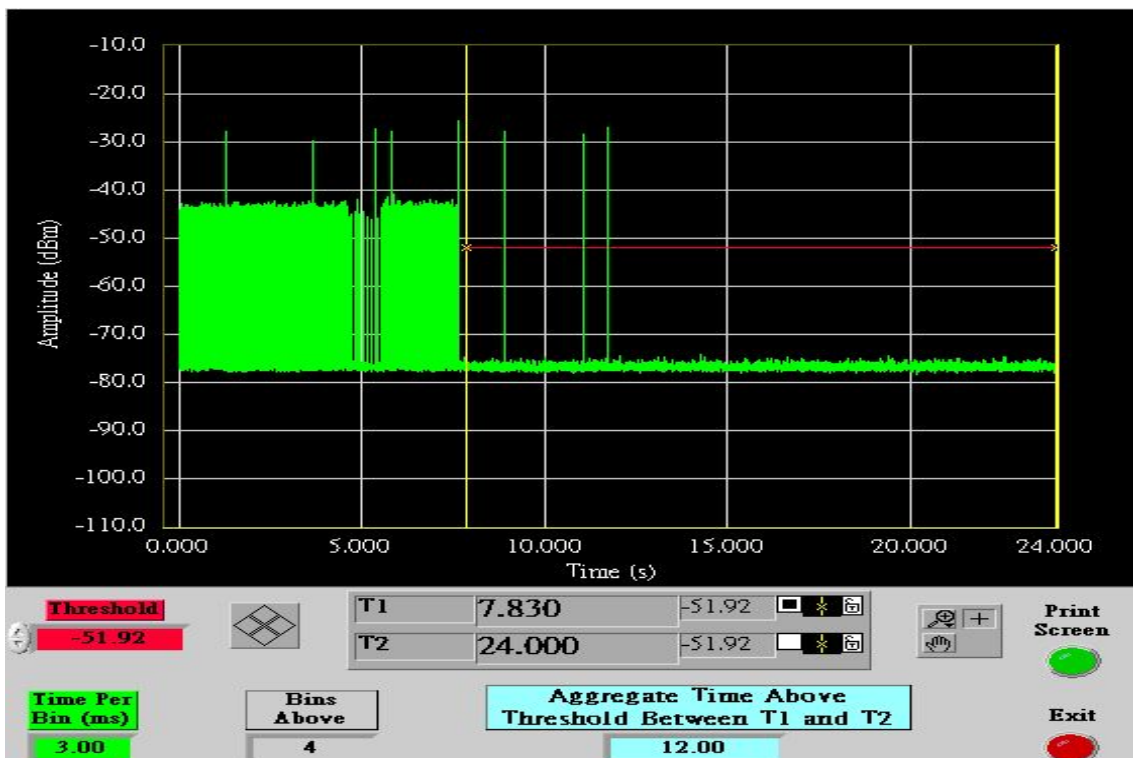
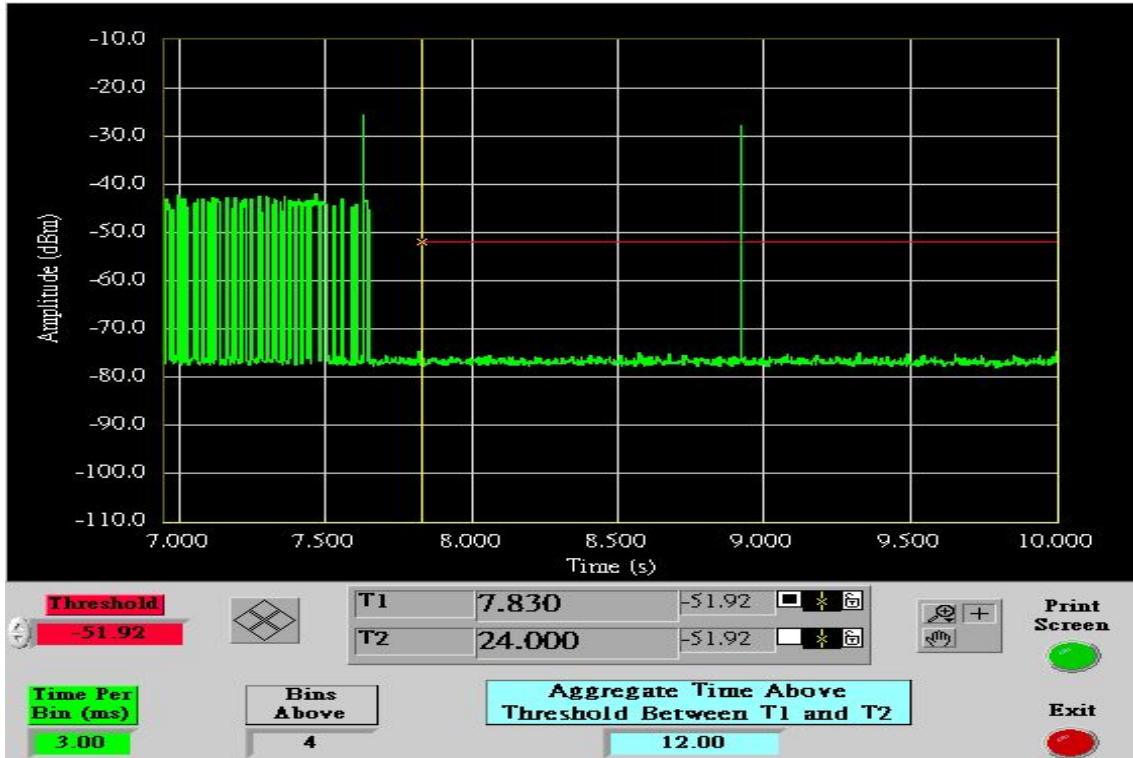



Non-Occupancy Period / Non-Occupancy Period is more than 30 min.

Type 1 Observation: (5250~5350MHz Band) of IEEE 802.11-5G (20MHz)

Agilent 14:43:40 Nov 22, 2012

R T

Δ Mkr1 1.8 ks

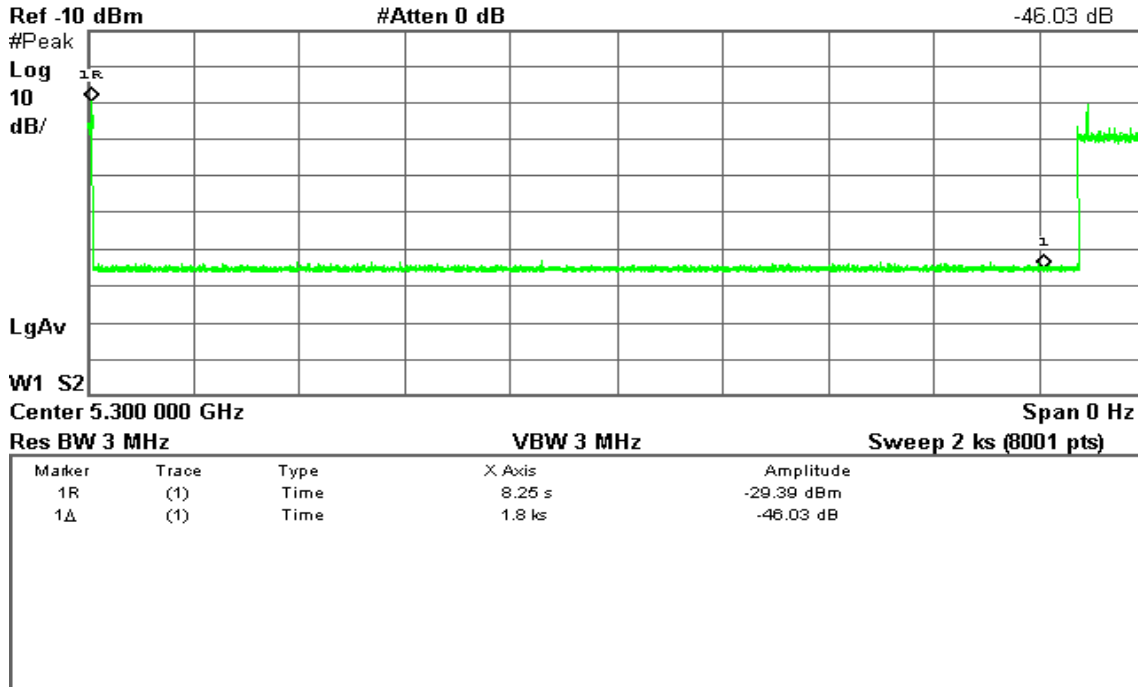

Type 5 Observation: (5250~5350MHz Band) of IEEE 802.11-5G (20MHz)

Agilent 06:54:22 Nov 22, 2012

T

Δ Mkr1 1.8 ks

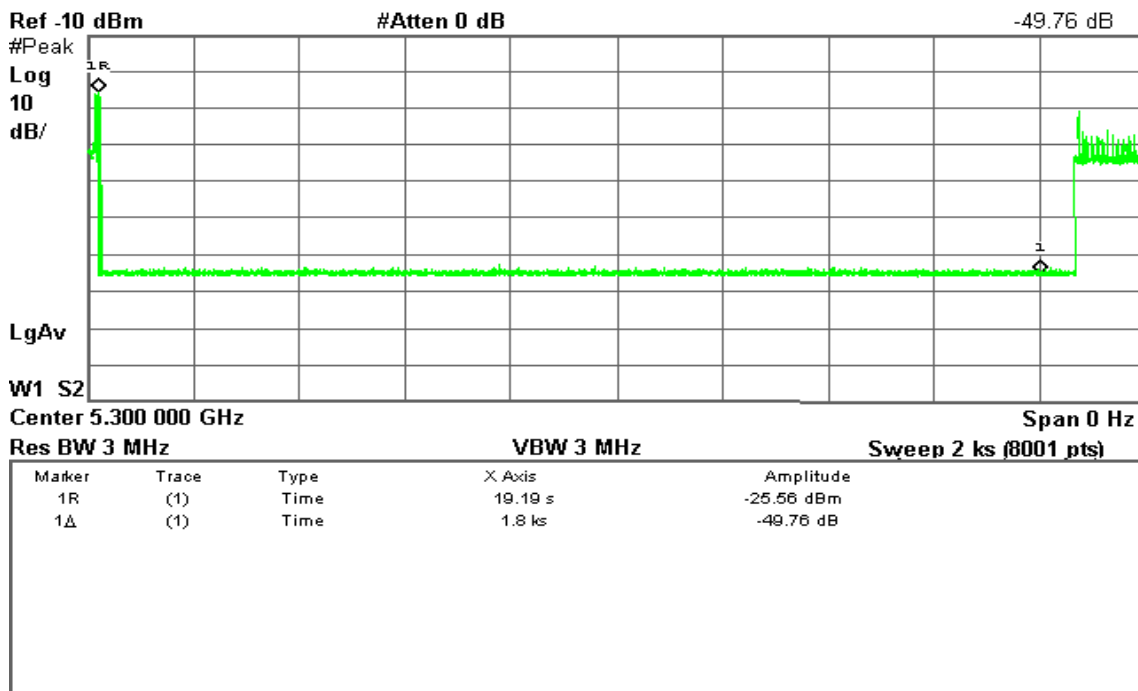



Observation: (5470~5725MHz Band) of IEEE 802.11-5G Ch 100(20MHz)

Type 1 Channel Move Time Results

No non-compliance noted.

Channel Move Time (s)	Limit (s)
1.164	10

Agilent 19:48:33 Nov 22, 2012

R T

Δ Mkr1 10 s

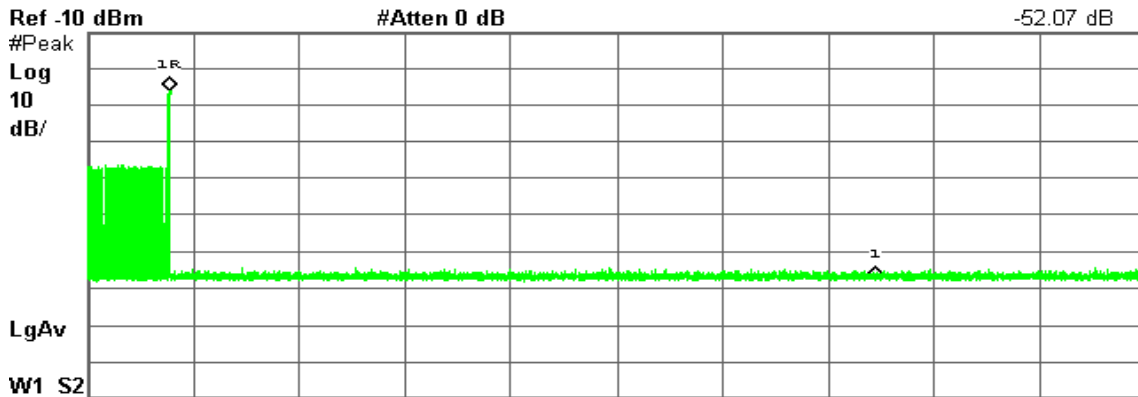

Center 5.500 000 GHz

Span 0 Hz

Res BW 3 MHz

VBW 3 MHz

Sweep 15 s (8001 pts)

Marker	Trace	Type	X Axis	Amplitude
1R	(1)	Time	1.164 s	-25.84 dBm
1Δ	(1)	Time	10 s	-52.07 dB



Type 5 Channel Move Time Results

No non-compliance noted.

Channel Move Time (s)	Limit (s)
2.583	10

Agilent 04:04:29 Nov 22, 2012

T

Δ Mkr2 2.583 s

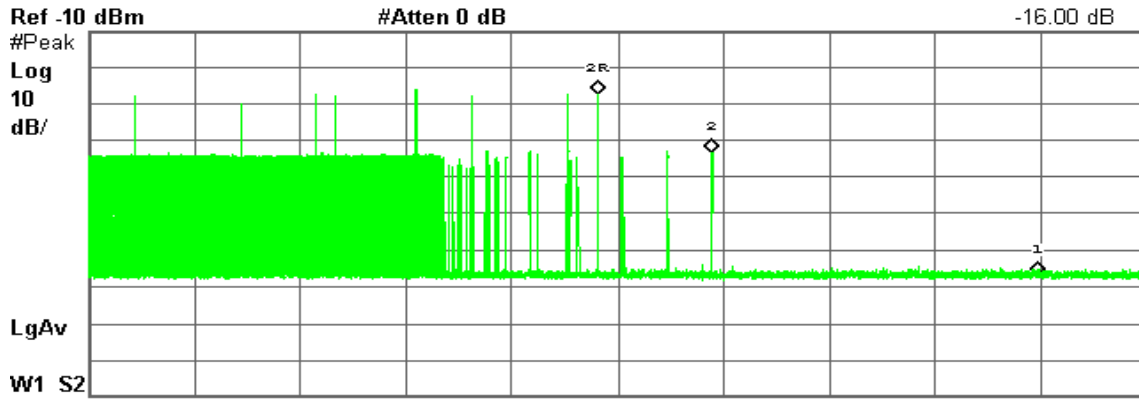

Ref -10 dBm #Atten 0 dB

Center 5.500 000 GHz Res BW 3 MHz VBW 3 MHz Sweep 24 s (8001 pts)

Marker	Trace	Type	X Axis	Amplitude
1R	(1)	Time	11.53 s	-27.27 dBm
1Δ	(1)	Time	10 s	-49.64 dB
2R	(1)	Time	11.53 s	-27.27 dBm
2Δ	(1)	Time	2.583 s	-16.00 dB



Observation: (5470~5725MHz Band) of IEEE 802.11-5G (20MHz) CH100

Type 1 Channel Closing Transmission Time Results

No non-compliance noted.

Channel Closing Transmission Time (ms)	Limit (ms)	Margin (ms)
0	60	-60

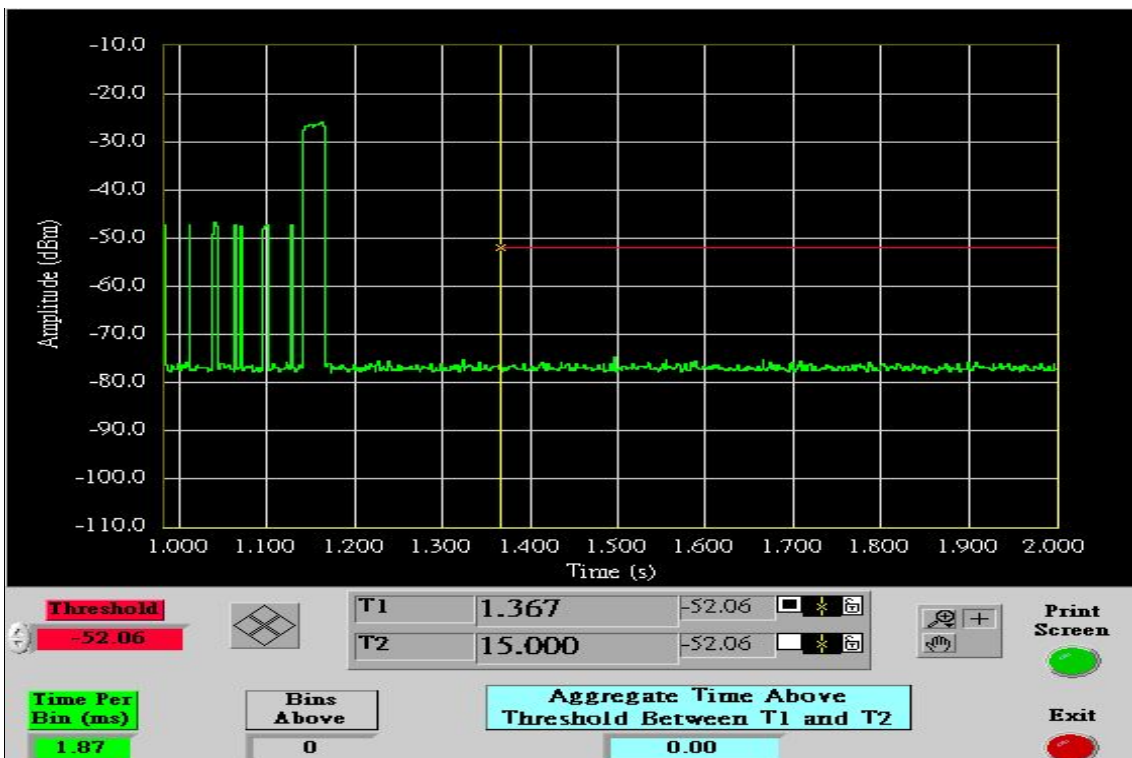
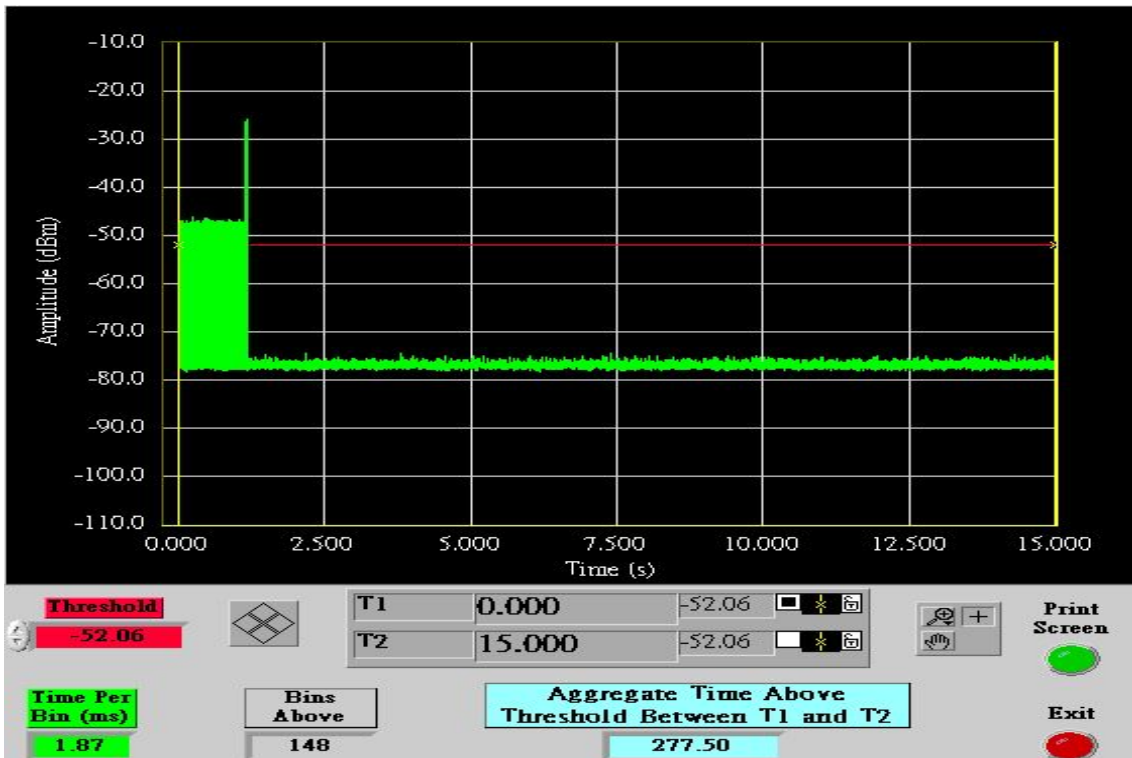

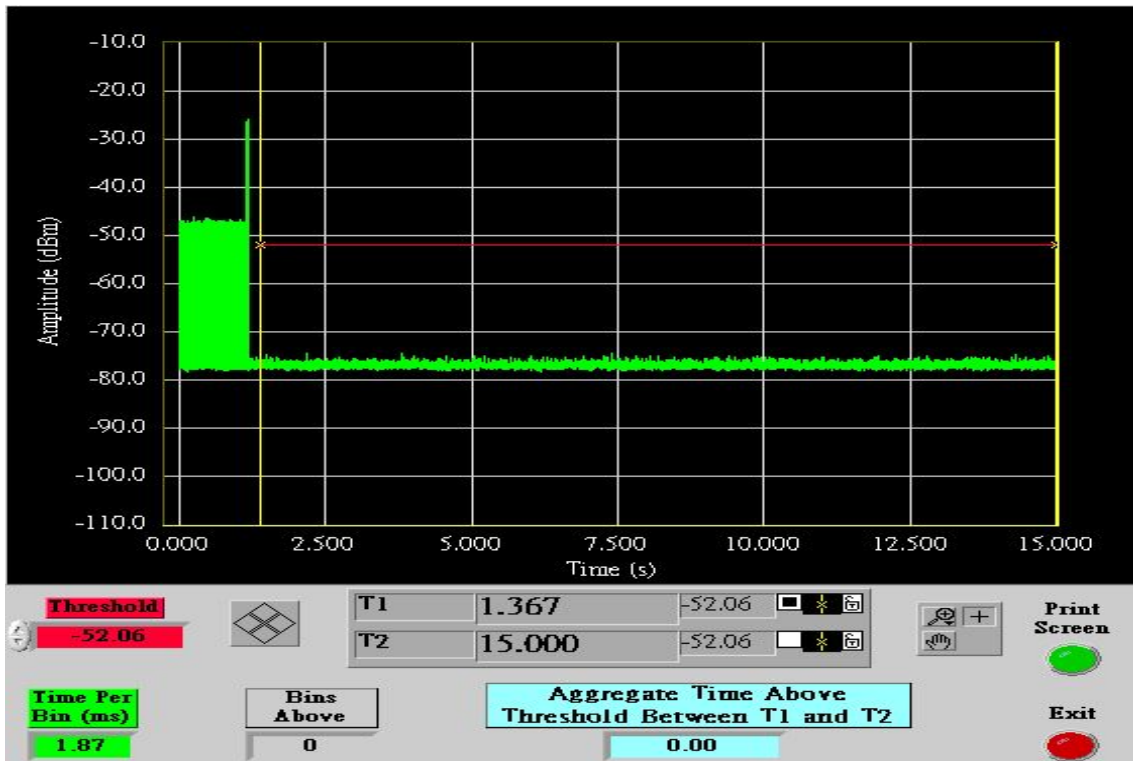



Type 5 Channel Closing Transmission Time Results

No non-compliance noted.

Channel Closing Transmission Time (ms)	Limit (ms)	Margin (ms)
39	60	-21

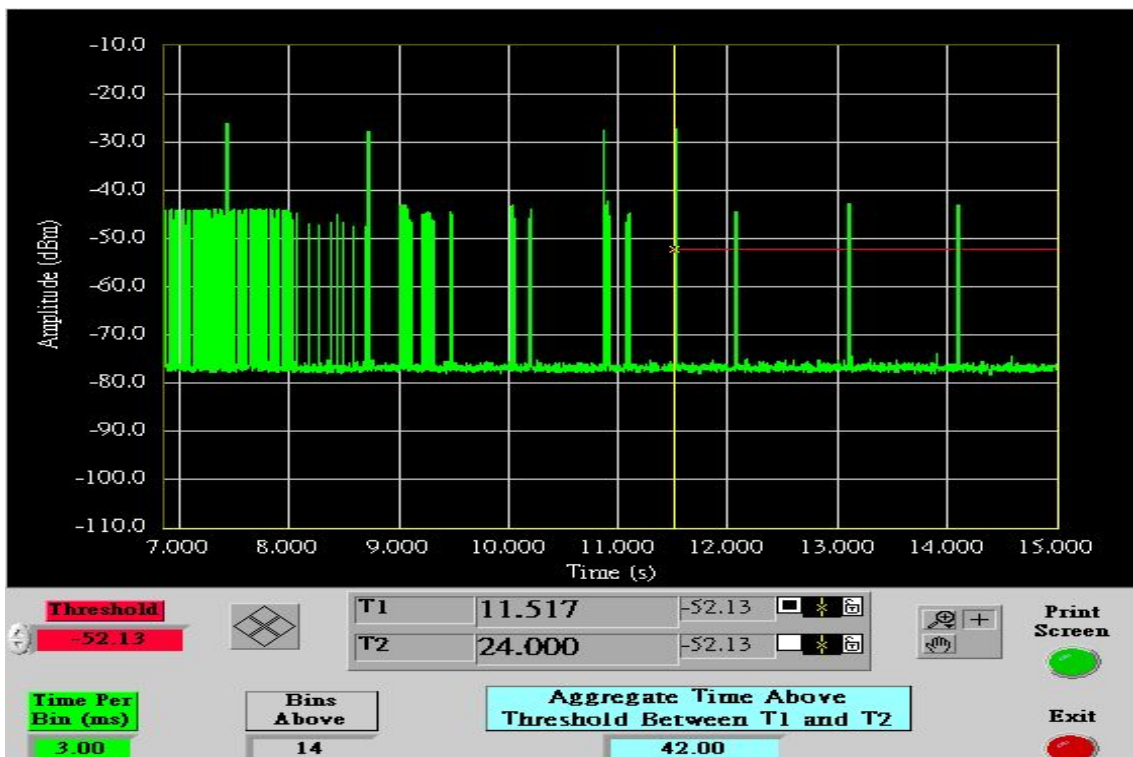
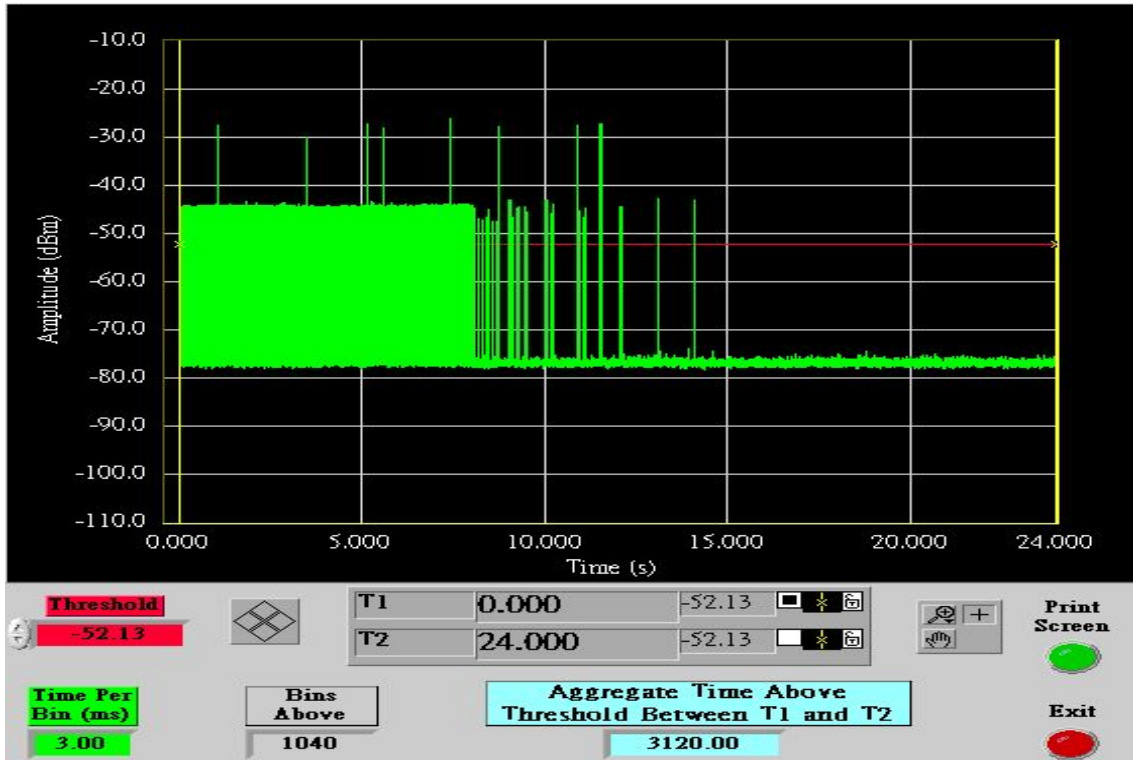

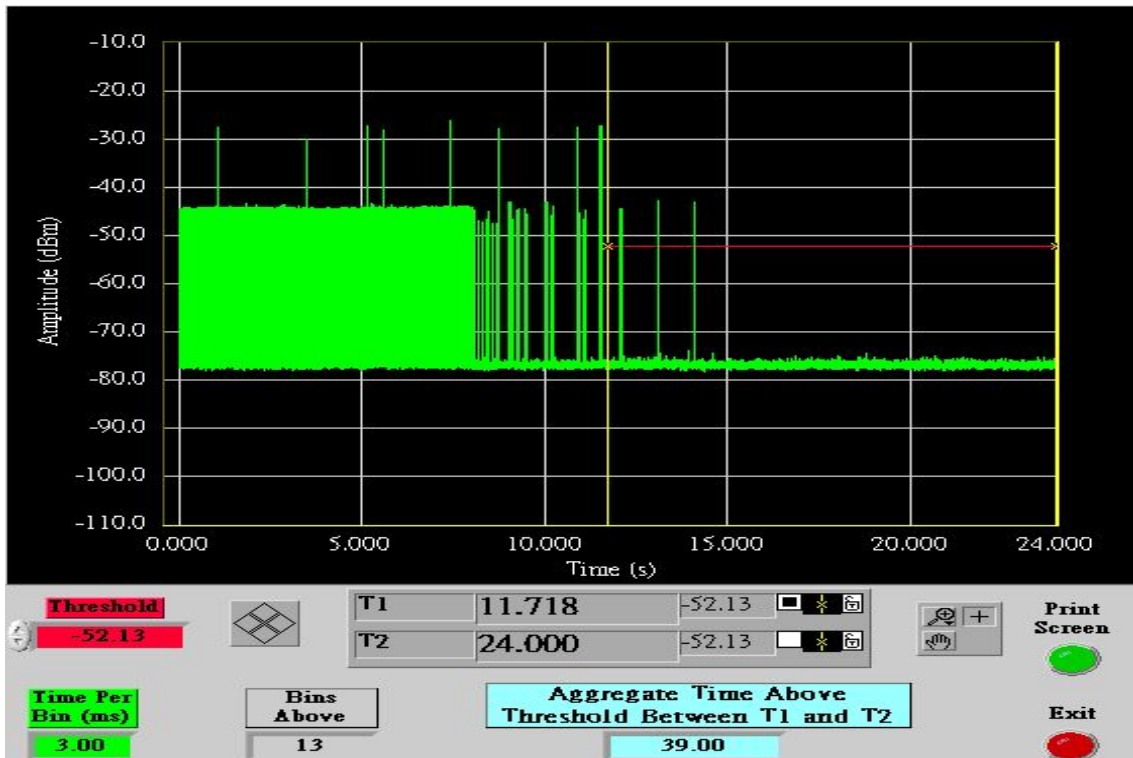
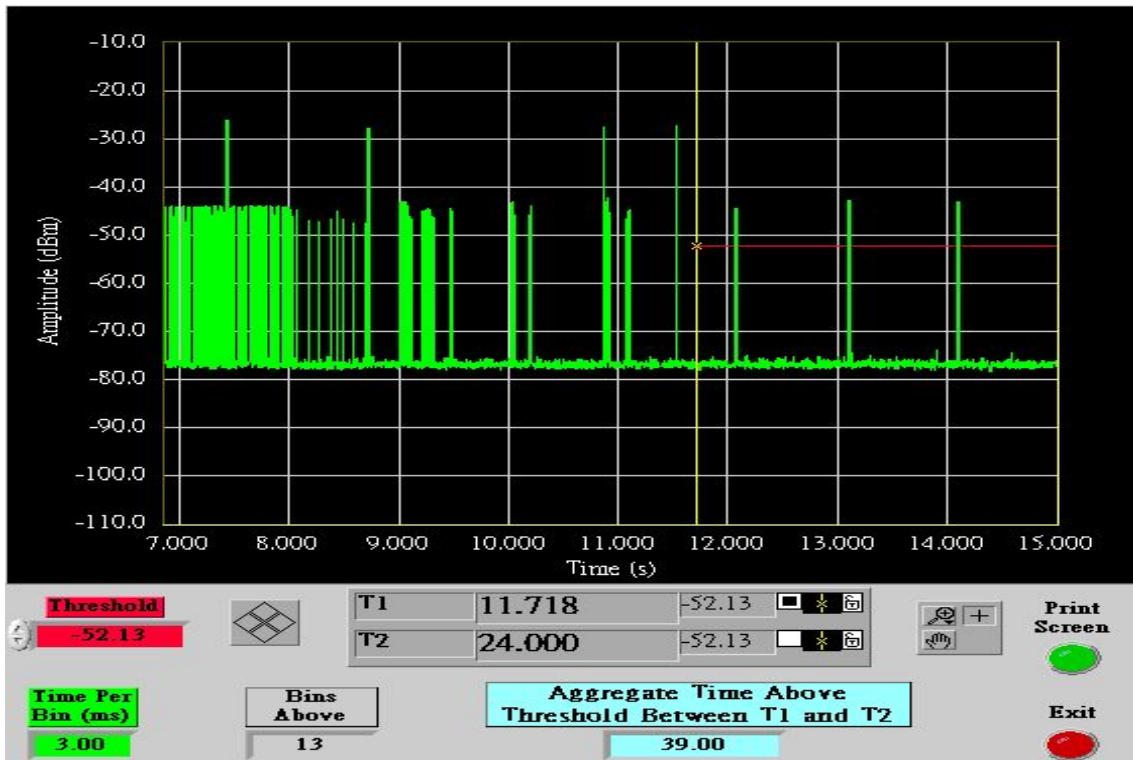



Non-Occupancy Period / Non-Occupancy Period is more than 30 min.

Type 1 Observation: (5470~5725MHz Band) of IEEE 802.11-5G (20MHz)

Agilent 15:29:07 Nov 22, 2012

R T

Δ Mkr1 1.8 ks
-45.85 dB

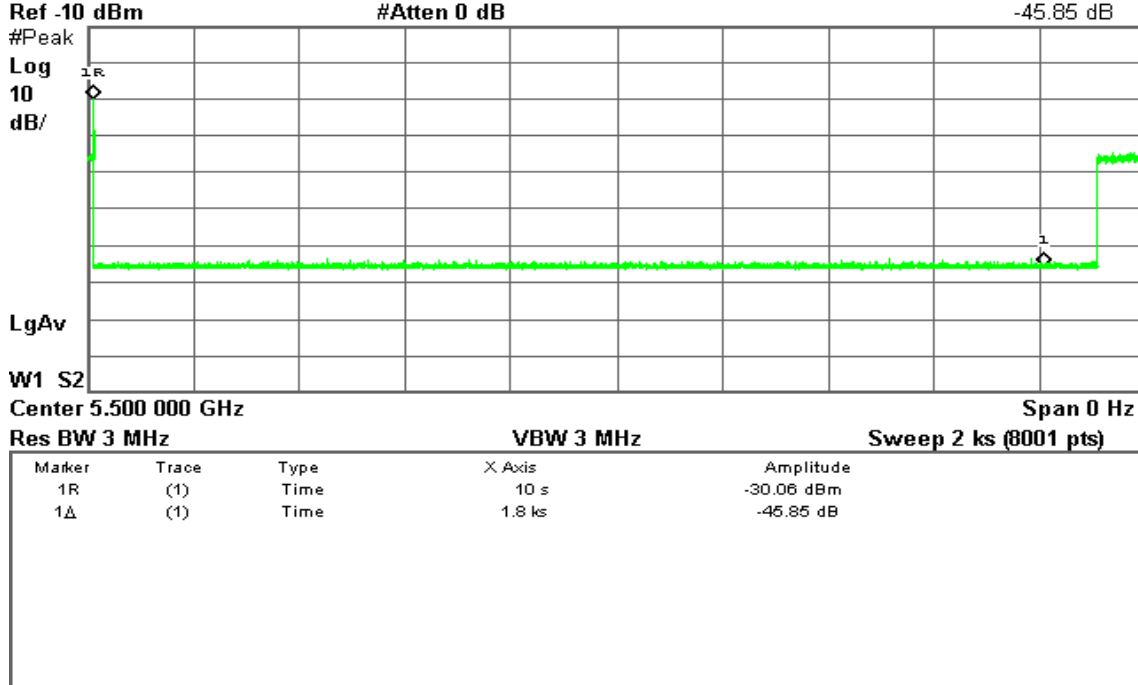

Type 5 Observation: (5470~5725MHz Band) of IEEE 802.11-5G (20MHz)

Agilent 05:46:26 Nov 22, 2012

T

Δ Mkr1 1.8 ks
-49.77 dB

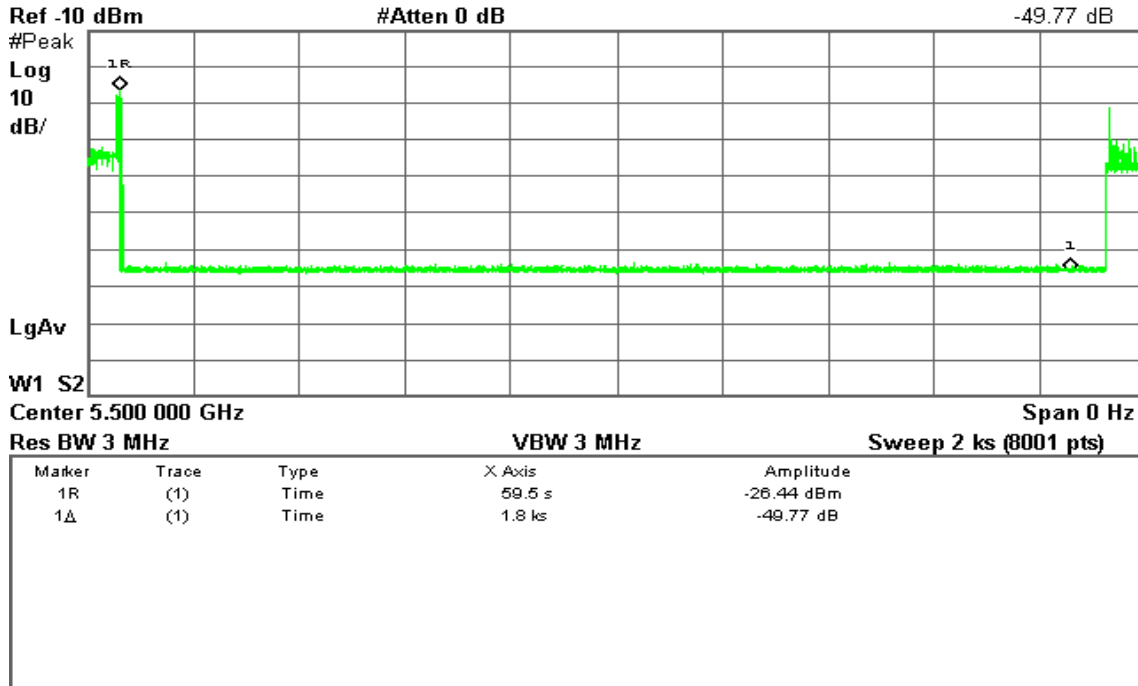



APPENDIX I RADIO FREQUENCY EXPOSURE

LIMIT

According to §15.407(f), U-NII devices are subject to the radio frequency radiation exposure requirements specified in §§ 1.1307(b), 2.1091 and 2.1093 of this chapter, as appropriate. All equipment shall be considered to operate in a "general population/uncontrolled" environment. Applications for equipment authorization of devices operating under this section must contain a statement confirming compliance with these requirements for both fundamental emissions and unwanted emissions. Technical information showing the basis for this statement must be submitted to the Commission upon request.

EUT Specification

EUT	Mobile Computer
Frequency band (Operating)	<input type="checkbox"/> WLAN: 2.412GHz ~ 2.462GHz <input checked="" type="checkbox"/> WLAN: 5.15GHz ~ 5.35GHz <input checked="" type="checkbox"/> WLAN: 5.5GHz ~ 5.7GHz <input type="checkbox"/> WLAN: 5.725GHz ~ 5.850GHz <input type="checkbox"/> Bluetooth: 2.402 GHz ~ 2.482 GHz <input type="checkbox"/> Others: _____
Device category	<input checked="" type="checkbox"/> Portable (<20cm separation) <input type="checkbox"/> Mobile (>20cm separation) <input type="checkbox"/> Others: _____
Exposure classification	General Population/Uncontrolled exposure ($S=1mW/cm^2$)
Antenna diversity	<input checked="" type="checkbox"/> Single antenna <input type="checkbox"/> Multiple antennas <ul style="list-style-type: none"> <input type="checkbox"/> Tx diversity <input type="checkbox"/> Rx diversity <input type="checkbox"/> Tx/Rx diversity
Max. output power	IEEE 802.11a mode / 5180 ~ 5240MHz: 12.05 dBm(16.03mW) IEEE 802.11n HT 20 MHz mode / 5180 ~ 5240MHz: 11.05dBm(12.73mW) IEEE 802.11a mode / 5260 ~ 5320MHz: 11.97 dBm(15.73mW) IEEE 802.11n HT 20 MHz mode / 5260 ~ 5320MHz: 11.04 dBm(12.70mW) IEEE 802.11a mode / 5500 ~ 5700MHz: 8.67 dBm(7.36mW) IEEE 802.11n HT 20 MHz mode / 5500 ~ 5700MHz: 7.98dBm(6.286mW)
Antenna gain (Max)	1.72 dBi (Numeric gain: 1.48)
Evaluation applied	<input type="checkbox"/> MPE Evaluation <input checked="" type="checkbox"/> SAR Evaluation* <input type="checkbox"/> N/A
Remark: The maximum output power is <u>12.05dBm (16.03mW)</u> at <u>5240MHz</u> (with <u>1.48 numeric antenna gain.</u>)	

TEST RESULTS

Remark: Please refer to the separated SAR report.