



FCC 47 CFR PART 27 SUBPART L

TEST REPORT

For

Mobile Computer

Trade Name: CIPHERLAB

Model: CP60G

Issued to

Cipherlab Co., Ltd.

12F, 333 Dunhua S. Rd., Sec.2, Taipei, Taiwan R.O.C.

Issued by

Compliance Certification Services Inc.

**No.11, Wugong 6th Rd., Wugu Dist.,
New Taipei City 24891, Taiwan. (R.O.C.)**

<http://www.ccsrf.com>

service@ccsrf.com

Issued Date: April 2, 2013



Note: This report shall not be reproduced except in full, without the written approval of Compliance Certification Services Inc. This document may be altered or revised by Compliance Certification Services Inc. personnel only, and shall be noted in the revision section of the document.



Revision History

Rev.	Issue Date	Revisions	Effect Page	Revised By
00	April 2, 2013	Initial Issue	ALL	Rachel Wu



TABLE OF CONTENTS

1. TEST RESULT CERTIFICATION.....	4
2. EUT DESCRIPTION	5
3. TEST METHODOLOGY	6
3.1 EUT CONFIGURATION	6
3.2 EUT EXERCISE	6
3.3 GENERAL TEST PROCEDURES	6
3.4 DESCRIPTION OF TEST MODES	7
4. INSTRUMENT CALIBRATION.....	8
4.1 MEASURING INSTRUMENT CALIBRATION	8
4.2 MEASUREMENT EQUIPMENT USED	8
4.3 MEASUREMENT UNCERTAINTY	9
5. FACILITIES AND ACCREDITATIONS	10
5.1 FACILITIES	10
5.2 EQUIPMENT	10
5.3 LABORATORY ACCREDITATIONS AND LISTING	10
5.4 TABLE OF ACCREDITATIONS AND LISTINGS	11
6. SETUP OF EQUIPMENT UNDER TEST	12
6.1 SETUP CONFIGURATION OF EUT	12
6.2 SUPPORT EQUIPMENT	12
7. FCC PART 27 REQUIREMENTS.....	13
7.1 PEAK POWER.....	13
7.2 AVERAGE POWER.....	15
7.3 OUT OF BAND EMISSION AT ANTENNA TERMINALS	17
7.4 ERP & EIRP MEASUREMENT	27
7.5 FIELD STRENGTH OF SPURIOUS RADIATION MEASUREMENT	30
7.6 FREQUENCY STABILITY V.S. TEMPERATURE MEASUREMENT	50
7.7 FREQUENCY STABILITY V.S. VOLTAGE MEASUREMENT	53
8. APPENDIX II PHOTOGRAPHS OF TEST SETUP	56



1. TEST RESULT CERTIFICATION

Applicant: Cipherlab Co., Ltd.
12F, 333 Dunhua S. Rd., Sec.2, Taipei, Taiwan R.O.C.

Equipment Under Test: Mobile Computer

Trade Name: CIPHERLAB

Model Number: CP60G

Date of Test: March 30 ~ April 1, 2013

APPLICABLE STANDARDS	
STANDARD	TEST RESULT
FCC 47 CFR PART 27 SUBPART L	No non-compliance noted

We hereby certify that:

The above equipment was tested by Compliance Certification Services Inc. The test data, data evaluation, test procedures, and equipment configurations shown in this report were made in accordance with the procedures given in TIA/EIA-603-C and the energy emitted by the sample EUT tested as described in this report is in compliance with radiated emission limits of FCC Rule FCC PART 27 Subpart L, IC RSS-139 Issue 2.

The test results of this report relate only to the tested sample identified in this report.

Approved by:

Reviewed by:

Miller Lee
Section Manager
Compliance Certification Services Inc.

Gina Lo
Section Manager
Compliance Certification Services Inc.



2. EUT DESCRIPTION

Product	Mobile Computer
Trade Name	CIPHERLAB
Model Number	CP60G
Received Date	March 21, 2013
Power Supply	1. Vdc from Power Adapter Brand: Adapter Technology Co., LTD., Model: STD-05040T I/P: 100-240V, 47-63Hz, 0.58A MAX O/P: 5V, 4A, 20W MAX 2. Vdc from Battery a). Model: BA-0064A4 Rating: 3.7V, 4400mAh, 16.28Wh b) Model: BA-0063A6 Rating: 3.7V, 3600mAh, 13.32Wh
Frequency Range	WCDMA / HSDPA / HSUPA Band IV: 1710-1755 MHz
Transmit Power (ERP & EIRP Power)	WCDMA Band IV: 22.75 dBm HSDPA Band IV: 23.14 dBm HSUPA Band IV: 23.76 dBm
Type of Emission	WCDMA Band IV: 4M14F9W HSDPA Band IV: 4M15F9W HSUPA Band IV: 4M15F9W
Cellular Phone Protocol	WCDMA: Quadrature Phase Shift Keying (QPSK) with Root-raised cosine pulse shaping filters (roll off = 0.22)
Antenna Specification	Gain: 5.2 dBi
Antenna Designation	FPC Antenna

Remark: The sample selected for test was engineering sample that approximated to production product and was provided by manufacturer.



3. TEST METHODOLOGY

Both conducted and radiated testing were performed according to the procedures document on chapter 13 of ANSI C63.4: 2009, TIA/EIA-603-C: 2004 and FCC CFR 47, Part 27 Subpart L.

The tests documented in this report were performed in accordance with IC RSS-132, SPSR503, RSS-133, SPSR510 and ANSI C63.4 and TIA/EIA-603-C.

3.1 EUT CONFIGURATION

The EUT configuration for testing is installed on RF field strength measurement to meet the Commissions requirement and operating in a manner that intends to maximize its emission characteristics in a continuous normal application.

3.2 EUT EXERCISE

The EUT was operated in the engineering mode to fix the TX frequency that was for the purpose of the measurements.

3.3 GENERAL TEST PROCEDURES

Conducted Emissions

The EUT is placed on the turntable, which is 0.8 m above ground plane. According to the requirements in Section 13.1.4.1 of ANSI C63.4: 2009. Conducted emissions from the EUT measured in the frequency range between 0.15 MHz and 30MHz using CISPR Quasi-peak and average detector modes.

Radiated Emissions

The EUT is placed on a turn table, which is 0.8 m above ground plane. The turntable shall rotate 360 degrees to determine the position of maximum emission level. EUT is set 3m away from the receiving antenna, which varied from 1m to 4m to find out the highest emission. And also, each emission was to be maximized by changing the polarization of receiving antenna both horizontal and vertical. In order to find out the maximum emissions, exploratory radiated emission measurements were made according to the requirements in Section 13.1.4.1 of ANSI C63.4: 2009.



3.4 DESCRIPTION OF TEST MODES

The EUT (model: CP60G) had been tested under operating condition.

EUT staying in continuous transmitting mode was programmed.

After verification, all tests were carried out with the worst case test modes as shown below except radiated spurious emission below 1GHz which worst case was in normal link mode only.

WCDMA Band IV:

Channel Low (CH1312), Channel Mid (CH1427) and Channel High (CH1513) were chosen for full testing.

WCDMA / HSDPA Band IV:

Channel Low (CH1312), Channel Mid (CH1427) and Channel High (CH1513) were chosen for full testing.

WCDMA / HSUPA Band IV:

Channel Low (CH1312), Channel Mid (CH1427) and Channel High (CH1513) were chosen for full testing.

The field strength of spurious emission was measured in the following position: EUT stand-up position (Z axis), lie-down position (X, Y axis).

The worst emission was found:

in lie-down (X axis) for WCDMA Band IV & WCDMA / HSDPA Band IV

in stand-up position (Z axis) for WCDMA / HSUPA Band IV



4. INSTRUMENT CALIBRATION

4.1 MEASURING INSTRUMENT CALIBRATION

The measuring equipment, which was utilized in performing the tests documented herein, has been calibrated in accordance with the manufacturer's recommendations for utilizing calibration equipment, which is traceable to recognized national standards.

4.2 MEASUREMENT EQUIPMENT USED

Equipment Used for Emissions Measurement

Remark: Each piece of equipment is scheduled for calibration once a year and Loop Antenna is scheduled for calibration once three years.

Conducted Emissions Test Site # A				
Name of Equipment	Manufacturer	Model	Serial Number	Calibration Due
EMI Test Receiver	R&S	ESCI	101203	09/13/2013
LISN	R&S	ESH3-Z5	848773/014	12/10/2013
ISN	FCC	FCC-TLISN-T8-02-09	101131	09/05/2013

Wugu 966 Chamber A				
Name of Equipment	Manufacturer	Model	Serial Number	Calibration Due
Spectrum Analyzer	Agilent	E4446A	US42510268	11/06/2013
Bilog Antenna	Sunol Sciences	JB3	A030105	10/02/2013
Horn Antenna	EMCO	3116	00026370	10/10/2013
Loop Antenna	EMCO	6502	8905/2356	06/10/2013
Turn Table	CCS	CC-T-1F	N/A	N.C.R
Antenna Tower	CCS	CC-A-1F	N/A	N.C.R
Controller	CCS	CC-C-1F	N/A	N.C.R
Test S/W	EZ-EMC (CCS-3A1RE)			



4.3 MEASUREMENT UNCERTAINTY

PARAMETER	UNCERTAINTY
Powerline Conducted Emission	+/- 1.2159
3M Semi Anechoic Chamber / 30M~200M	+/-4.0138
3M Semi Anechoic Chamber / 200M~1000M	+/-3.9483
3M Semi Anechoic Chamber / 1G~8G	+/-2.5975
3M Semi Anechoic Chamber / 8G~18G	+/-2.6112
3M Semi Anechoic Chamber / 18G~26G	+/-2.7389
3M Semi Anechoic Chamber / 26G~40G	+/-2.9683

Remark: This uncertainty represents an expanded uncertainty expressed at approximately the 95% confidence level using a coverage factor of $k=2$.



5. FACILITIES AND ACCREDITATIONS

5.1 FACILITIES

All measurement facilities used to collect the measurement data are located at

No.199, Chunghsen Road, Hsintien City, Taipei Hsien, Taiwan, R.O.C.
Tel: 886-2-2217-0894 / Fax: 886-2-2217-1029

No.11, Wugong 6th Rd., Wugu Dist., New Taipei City 24891, Taiwan. (R.O.C.)
Tel: 886-2-2299-9720 / Fax: 886-2-2298-4045

No.81-1, Lane 210, Bade 2nd Rd., Luchu Hsiang, Taoyuan Hsien 338, Taiwan
Tel: 886-3-324-0332 / Fax: 886-3-324-5235

The sites are constructed in conformance with the requirements of ANSI C63.7, ANSI C63.4: 2009 and CISPR Publication 22.

5.2 EQUIPMENT

Radiated emissions are measured with one or more of the following types of linearly polarized antennas: tuned dipole, biconical, log periodic, bi-log, and/or ridged waveguide, horn. Spectrum analyzers with pre-selectors and quasi-peak detectors are used to perform radiated measurements.

Conducted emissions are measured with Line Impedance Stabilization Networks and EMI Test Receivers.

Calibrated wideband preamplifiers, coaxial cables, and coaxial attenuators are also used for making measurements.



All receiving equipment conforms to CISPR Publication 16-1, "Radio Interference Measuring Apparatus and Measurement Methods."

5.3 LABORATORY ACCREDITATIONS AND LISTING

The test facilities used to perform radiated and conducted emissions tests are accredited by American Association for Laboratory Accreditation Program for the specific scope accreditation under Lab Code: 0824-01 to perform Electromagnetic Interference tests according to FCC Part 15 and CISPR 22 requirements. In addition, the test facilities are listed with Industry Canada, Certification and Engineering Bureau, IC 2324G-1 for 3M Semi Anechoic Chamber A, 2324G-2 for 3M Semi Anechoic Chamber B.



5.4 TABLE OF ACCREDITATIONS AND LISTINGS

Country	Agency	Scope of Accreditation	Logo
USA	FCC	3M Semi Anechoic Chamber (FCC MRA: TW1039) to perform FCC Part 15 measurements	 FCC MRA: TW1039
Taiwan	TAF	LP0002, RTTE01, FCC Method-47 CFR Part 15 Subpart C, D, E, RSS-210, RSS-310 IDA TS SRD, AS/NZS 4268, AS/NZS 4771, TS 12.1 & 12.2, ETSI EN 300 440-1, ETSI EN 300 440-2, ETSI EN 300 328, ETSI EN 300 220-1, ETSI EN 300 220-2, ETSI EN 301 893, ETSI EN 301 489-1/3/7/17 FCC OET Bulletin 65 + Supplement C, EN 50360, EN 50361, EN 50371, RSS 102, EN 50383, EN 50385, EN 50392, IEC 62209, CNS 14958-1, CNS 14959 FCC Method -47 CFR Part 15 Subpart B IEC / EN 61000-3-2, IEC / EN 61000-3-3, IEC / EN 61000-4-2/3/4/5/6/8/11	
Canada	Industry Canada	3M Semi Anechoic Chamber (IC 2324G-1 / IC 2324G-2) to perform	 IC 2324G-1 IC 2324G-2

** No part of this report may be used to claim or imply product endorsement by A2LA or any agency of the US Government.*



6. SETUP OF EQUIPMENT UNDER TEST

6.1 SETUP CONFIGURATION OF EUT

See test photographs attached in Appendix II for the actual connections between EUT and support equipment.

6.2 SUPPORT EQUIPMENT

No	Equipment	Brand	Model	Series No.	FCC ID	Data Cable	Power Cord
	N/A						



7. FCC PART 27 REQUIREMENTS

7.1 PEAK POWER

LIMIT

According to FCC §2.1046.

Test Configuration

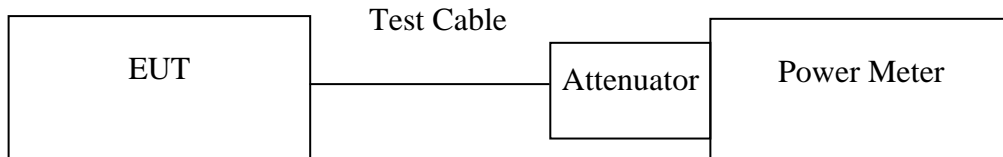

Remark: Measurement setup for testing on Antenna connector

TEST PROCEDURE

The transmitter output was connected to a calibrated attenuator, the other end of which was connected to a power meter. Transmitter output was read off the power meter in dBm. The power output at the transmitter antenna port was determined by adding the value of the attenuator to the power meter reading.

TEST RESULTS

No non-compliance noted.



Test Data

Test Mode	CH	Frequency (MHz)	Peak Power (dBm)	Peak Power (W)
WCDMA Band IV	1312	1712.40	26.36	0.43251
	1427	1735.40	26.10	0.40738
	1513	1752.60	26.74	*0.47206

Test Mode	CH	Frequency (MHz)	Peak Power (dBm)	Peak Power (W)
HSDPA Band IV	1312	1712.40	26.96	0.49659
	1427	1735.40	26.82	0.48084
	1513	1752.60	27.07	*0.50933

Test Mode	CH	Frequency (MHz)	Peak Power (dBm)	Peak Power (W)
HSUPA Band IV	1312	1712.40	26.95	0.49545
	1427	1735.40	26.80	0.47863
	1513	1752.60	27.07	*0.50933

Remark: The value of factor includes both the loss of cable and external attenuator



7.2 AVERAGE POWER

LIMIT

For reporting purposes only.

Test Configuration

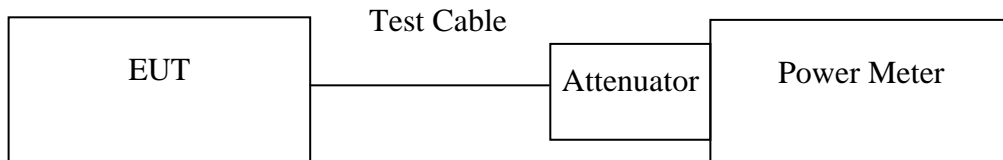

Remark: Measurement setup for testing on Antenna connector

TEST PROCEDURE

The transmitter output was connected to a calibrated attenuator, the other end of which was connected to a power meter. Transmitter output was read off the power meter in dBm. The power output at the transmitter antenna port was determined by adding the value of the attenuator to the power meter reading.

TEST RESULTS

No non-compliance noted.



Test Data

Test Mode	CH	Frequency (MHz)	Average Power (dBm)
WCDMA Band IV	1312	1712.40	23.40
	1427	1735.40	23.31
	1513	1752.60	23.34

Test Mode	CH	Frequency (MHz)	Average Power (dBm)
HSDPA Band IV	1312	1712.40	23.21
	1427	1735.40	23.04
	1513	1752.60	23.25

Test Mode	CH	Frequency (MHz)	Average Power (dBm)
HSUPA Band IV	1312	1712.40	23.24
	1427	1735.40	23.05
	1513	1752.60	23.26

Remark: The value of factor includes both the loss of cable and external attenuator



7.3 OUT OF BAND EMISSION AT ANTENNA TERMINALS

LIMIT

According to FCC §FCC 47 CFR PART 27 SUBPART L.

Out of Band Emissions: The mean power of emission must be attenuated below the mean power of the non-modulated carrier (P) on any frequency twice or more than twice the fundamental frequency by at least $43 + 10 \log P$ dB.

Mobile Emissions in Base Frequency Range: The mean power of any emissions appearing in the base station frequency range from cellular mobile transmitters operated must be attenuated to a level not exceed -80 dBm at the transmit antenna connector.

Band Edge Requirements: In the 1MHz bands immediately outside and adjacent to the frequency block, a resolution bandwidth of at least 1% of the emission bandwidth of the fundamental emission of the transmitter may be employed to measure the Out of band Emission

Test Configuration

Out of band emission at antenna terminals:

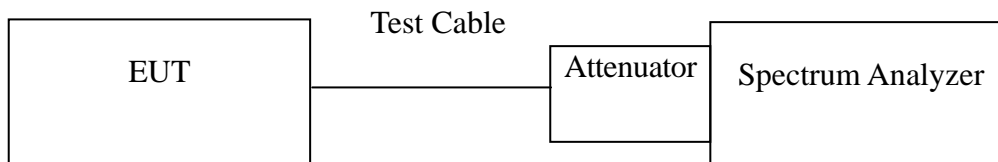

TEST PROCEDURE

The RF output of the transceiver was connected to a spectrum analyzer through appropriate attenuation. The resolution bandwidth of the spectrum analyzer was set at 1MHz, sufficient scans were taken to show the out of band Emissions if any up to 10th harmonic.

For the out of band: Set the RBW, VBW = 1MHz, Start=30MHz, Stop= 10 th harmonic. Limit = -13dBm

Band Edge Requirements (1710-1755 MHz): In the 1 MHz bands immediately outside and adjacent to the frequency block, a resolution bandwidth of at least 1 percent of the emission bandwidth of the fundamental emission of the transmitter may be employed to measure the out of band Emissions. Limit, -13dBm.

TEST RESULTS

No non-compliance noted.



Test Data

Mode	CH	Location	Description
WCDMA (Band IV)	1312	Figure 7-1	Conducted spurious emissions, 30MHz - 20GHz
	1427	Figure 7-2	Conducted spurious emissions, 30MHz - 20GHz
	1513	Figure 7-3	Conducted spurious emissions, 30MHz - 20GHz

Mode	CH	Location	Description
HSDPA WCDMA (Band IV)	1312	Figure 7-4	Conducted spurious emissions, 30MHz - 20GHz
	1427	Figure 7-5	Conducted spurious emissions, 30MHz - 20GHz
	1513	Figure 7-6	Conducted spurious emissions, 30MHz - 20GHz

Mode	CH	Location	Description
HSUPA WCDMA (Band IV)	1312	Figure 7-7	Conducted spurious emissions, 30MHz - 20GHz
	1427	Figure 7-8	Conducted spurious emissions, 30MHz - 20GHz
	1513	Figure 7-9	Conducted spurious emissions, 30MHz - 20GHz

Mode	CH	Location	Description
WCDMA (Band IV)	1312	Figure 8-1	Band Edge emissions
	1513	Figure 8-2	Band Edge emissions

Mode	CH	Location	Description
HSDPA WCDMA (Band IV)	1312	Figure 8-3	Band Edge emissions
	1513	Figure 8-4	Band Edge emissions

Mode	CH	Location	Description
HSUPA WCDMA (Band IV)	1312	Figure 8-5	Band Edge emissions
	1513	Figure 8-6	Band Edge emissions



Test Plot

WCDMA Band IV

Figure 7-1: Out of Band emission at antenna terminals – CH Low

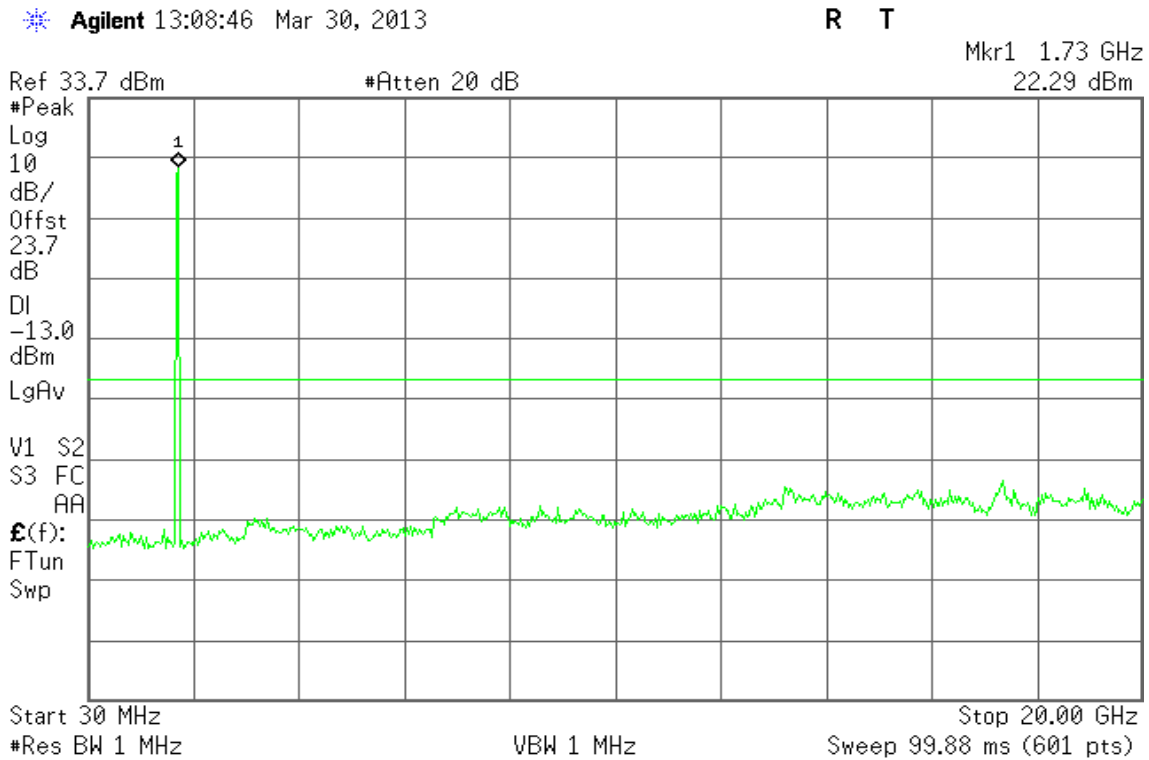

Figure 7-2: Out of Band emission at antenna terminals – CH Mid

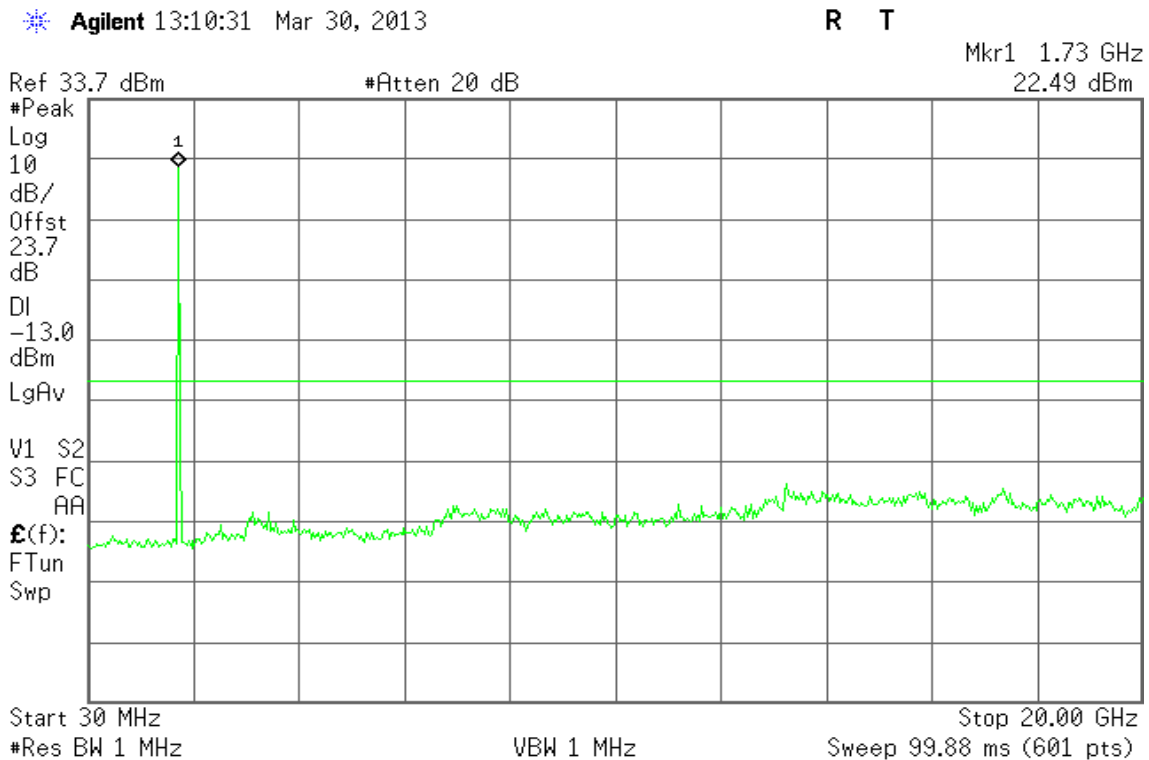
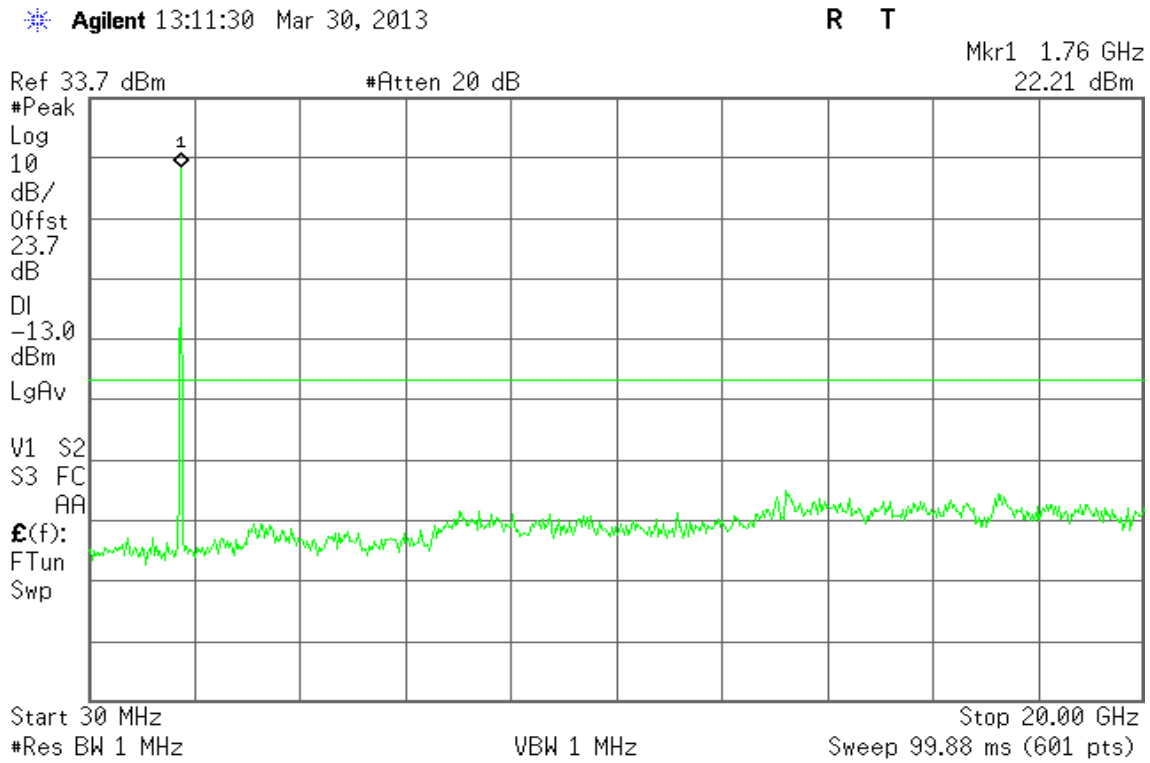



Figure 7-3: Out of Band emission at antenna terminals – CH High



HSDPA Band IV

Figure 7-4: Out of Band emission at antenna terminals – CH Low

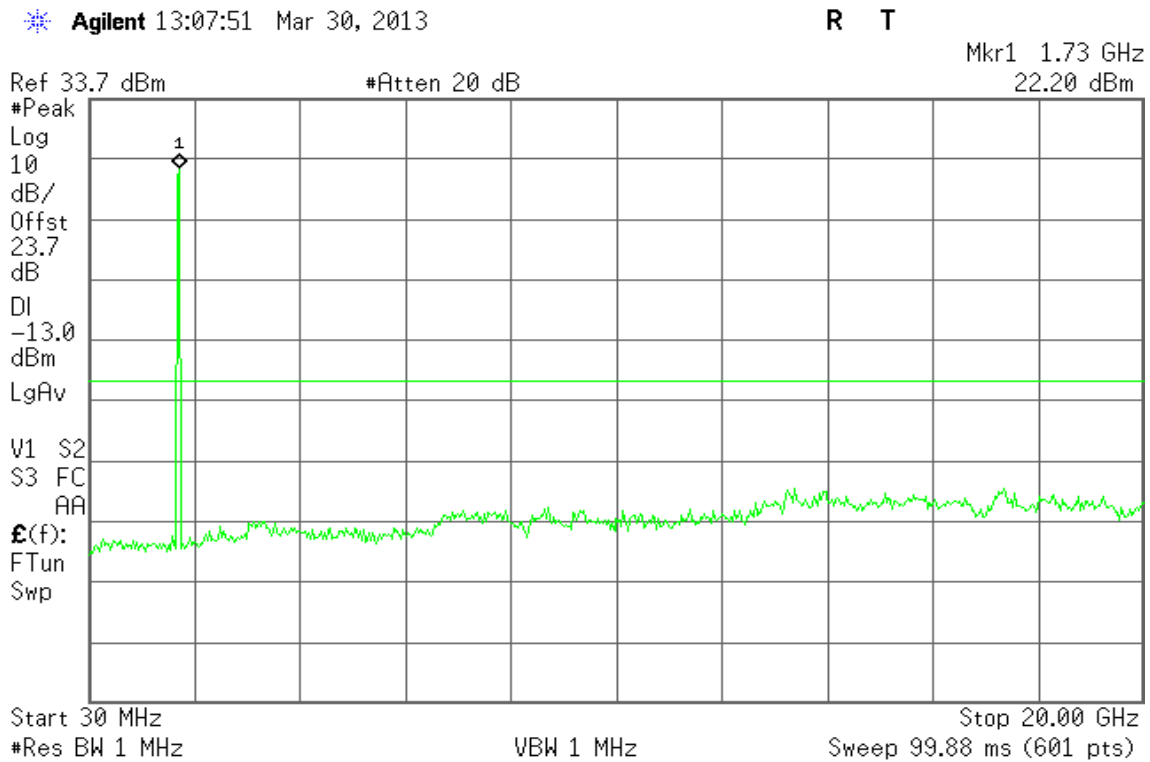



Figure 7-5: Out of Band emission at antenna terminals – CH Mid

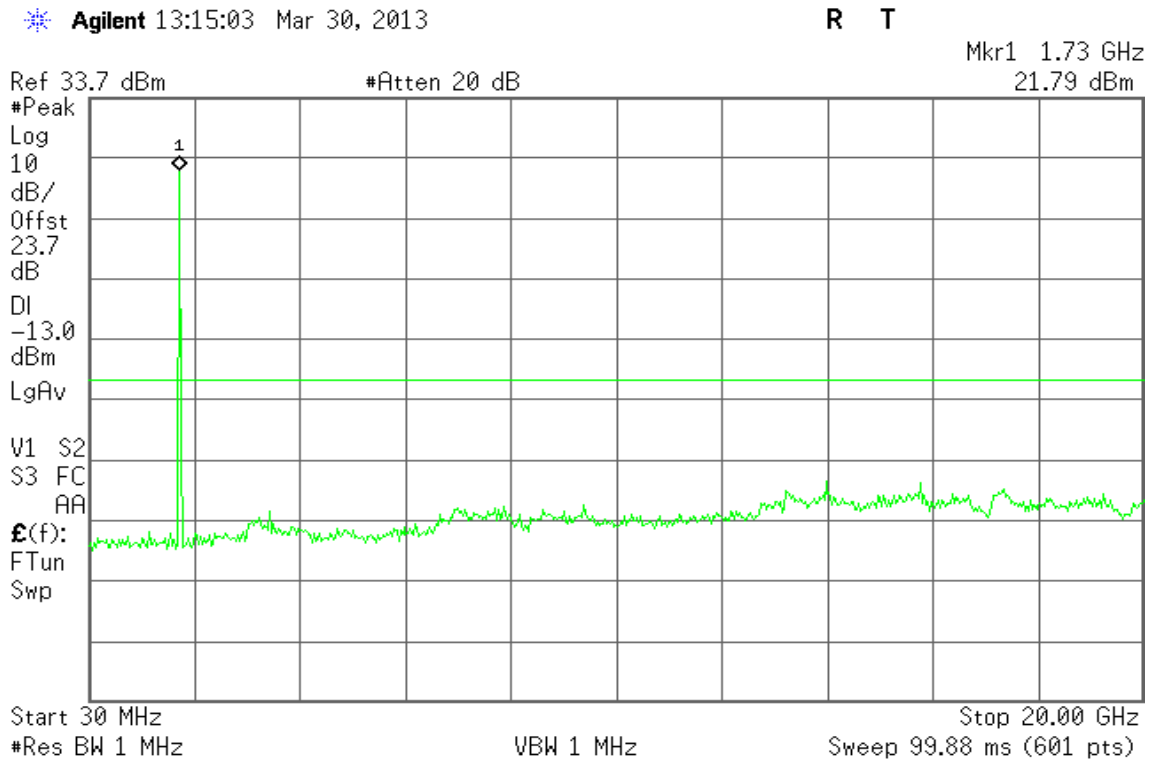
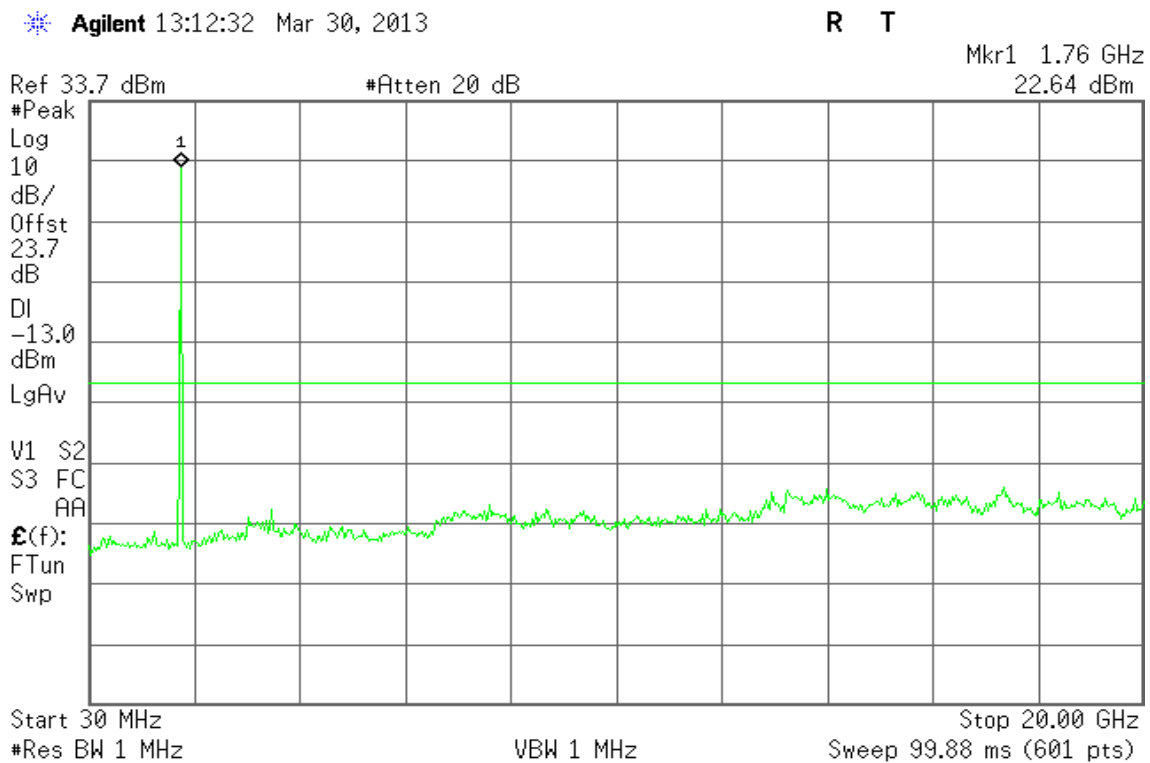

Figure 7-6: Out of Band emission at antenna terminals – CH High





HSUPA Band IV

Figure 7-7: Out of Band emission at antenna terminals – CH Low

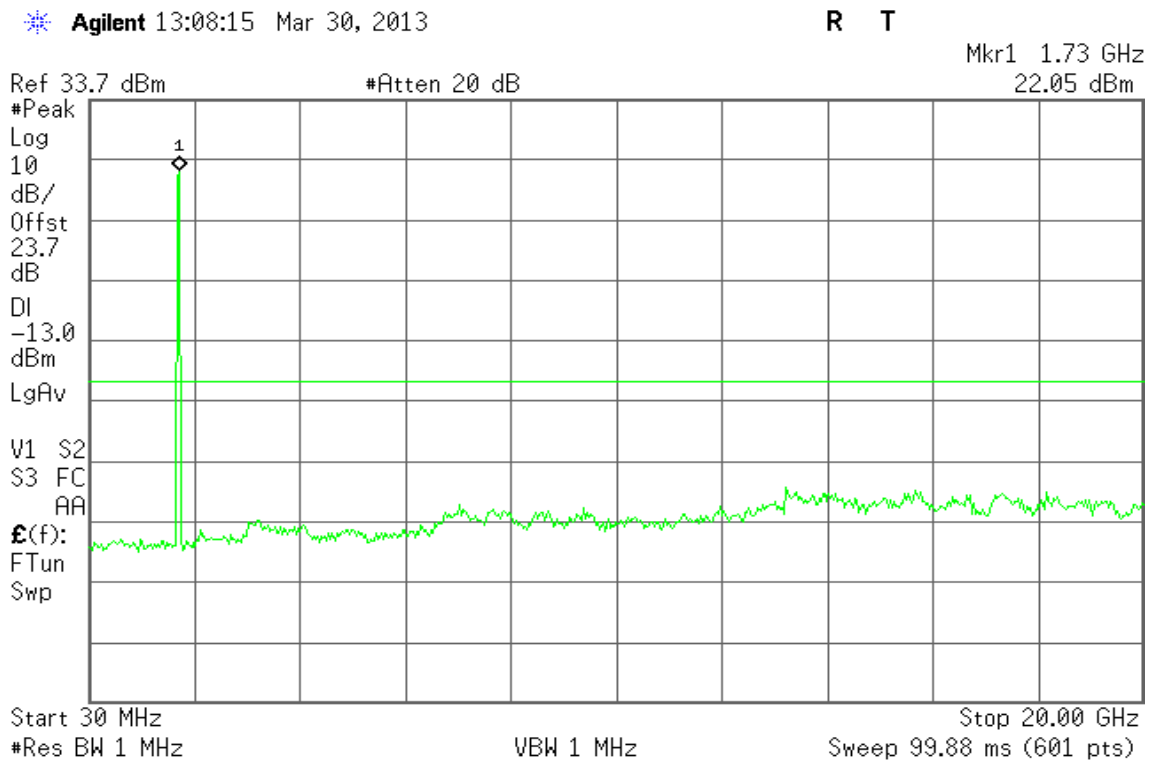

Figure 7-8: Out of Band emission at antenna terminals – CH Mid

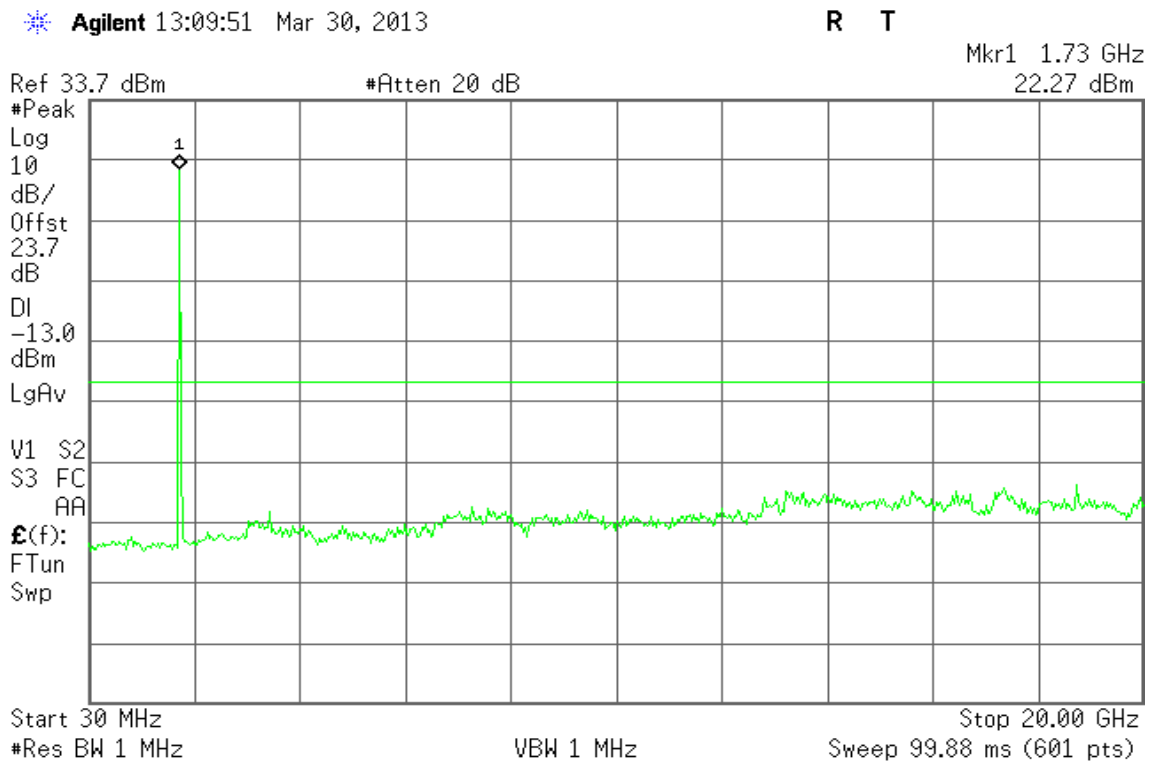

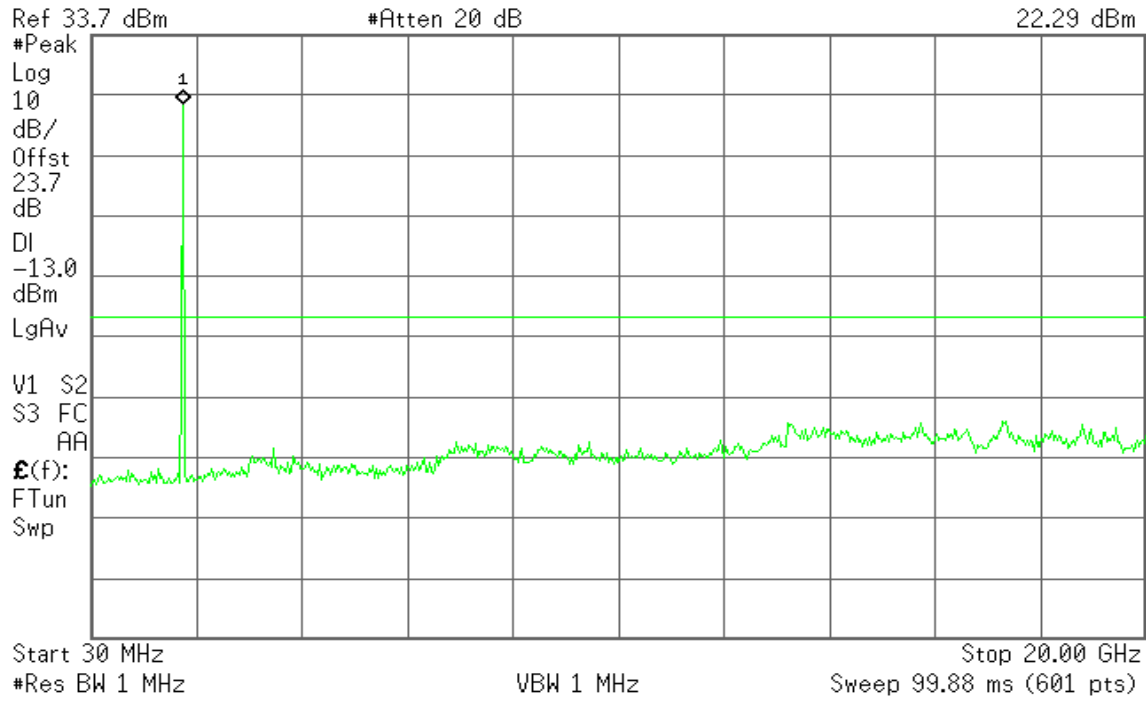

Figure 7-9: Out of Band emission at antenna terminals – CH High

Agilent 13:12:00 Mar 30, 2013

R T

Mkr1 1.76 GHz
22.29 dBm





WCDMA Band IV

Figure 8-1: Out of Band bandedge at antenna terminals – CH Low

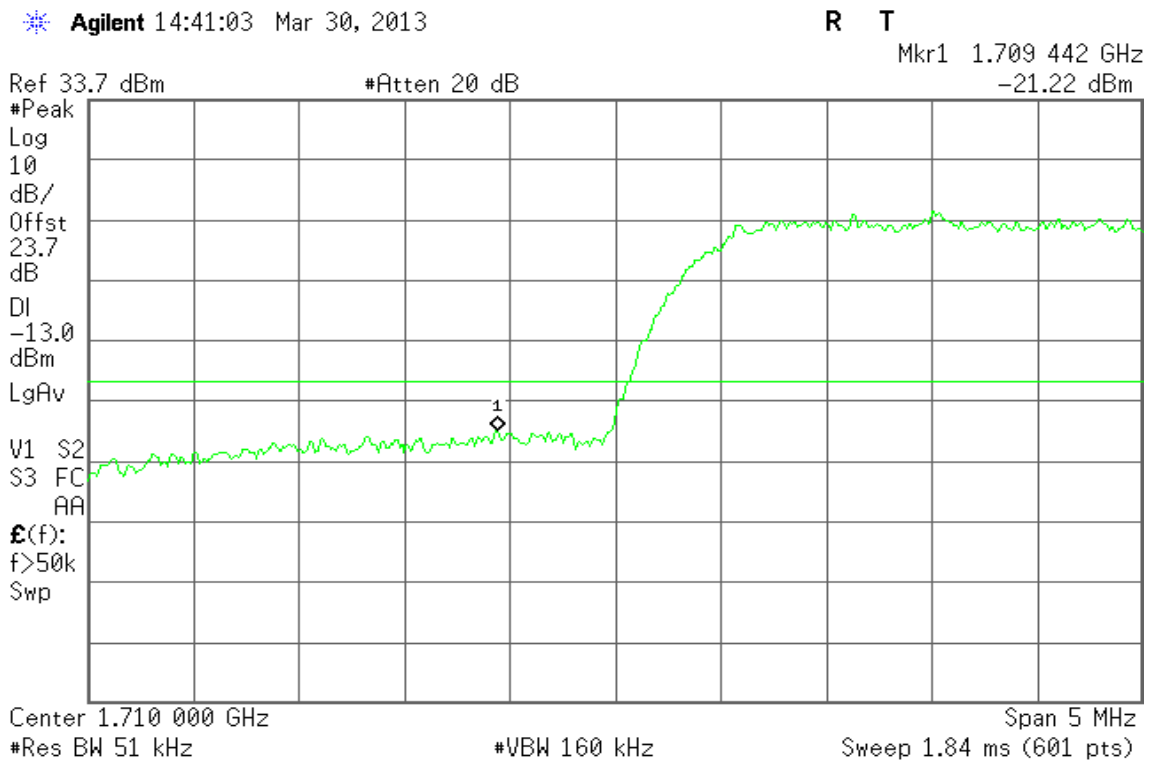
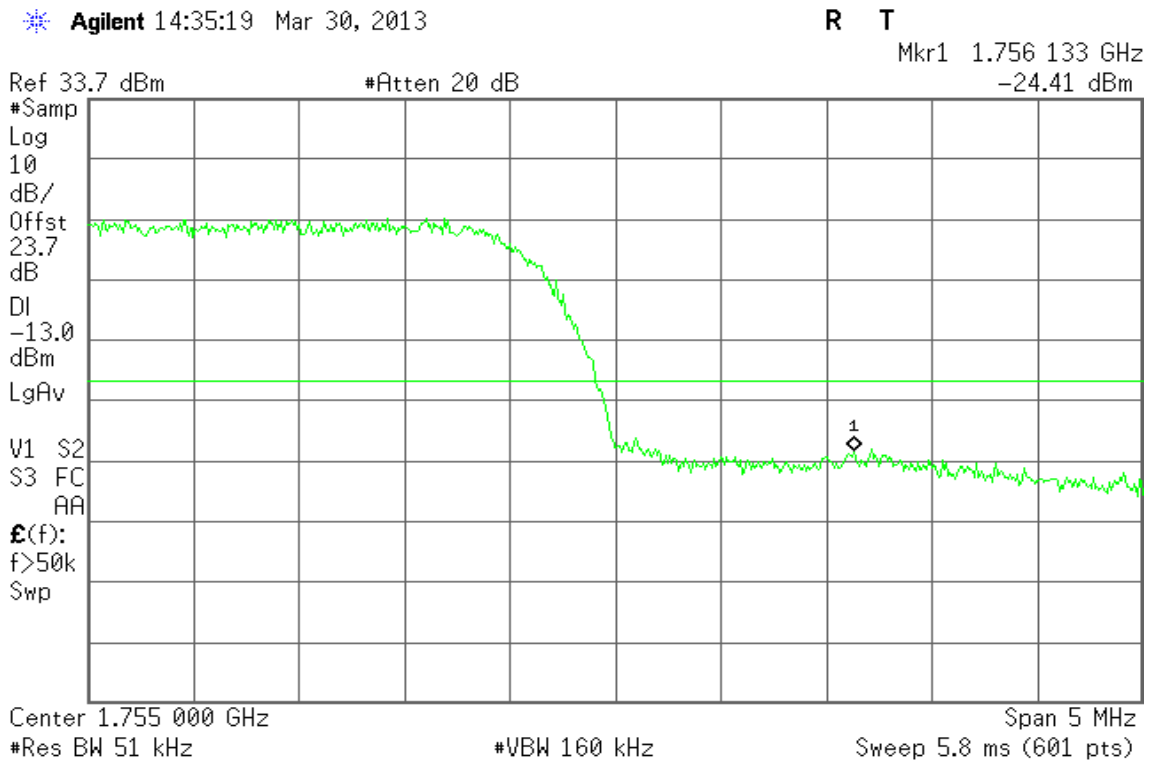

Figure 8-2: Out of Band bandedge at antenna terminals – CH High





HSDPA Band IV

Figure 8-3: Out of Band bandedge at antenna terminals – CH Low

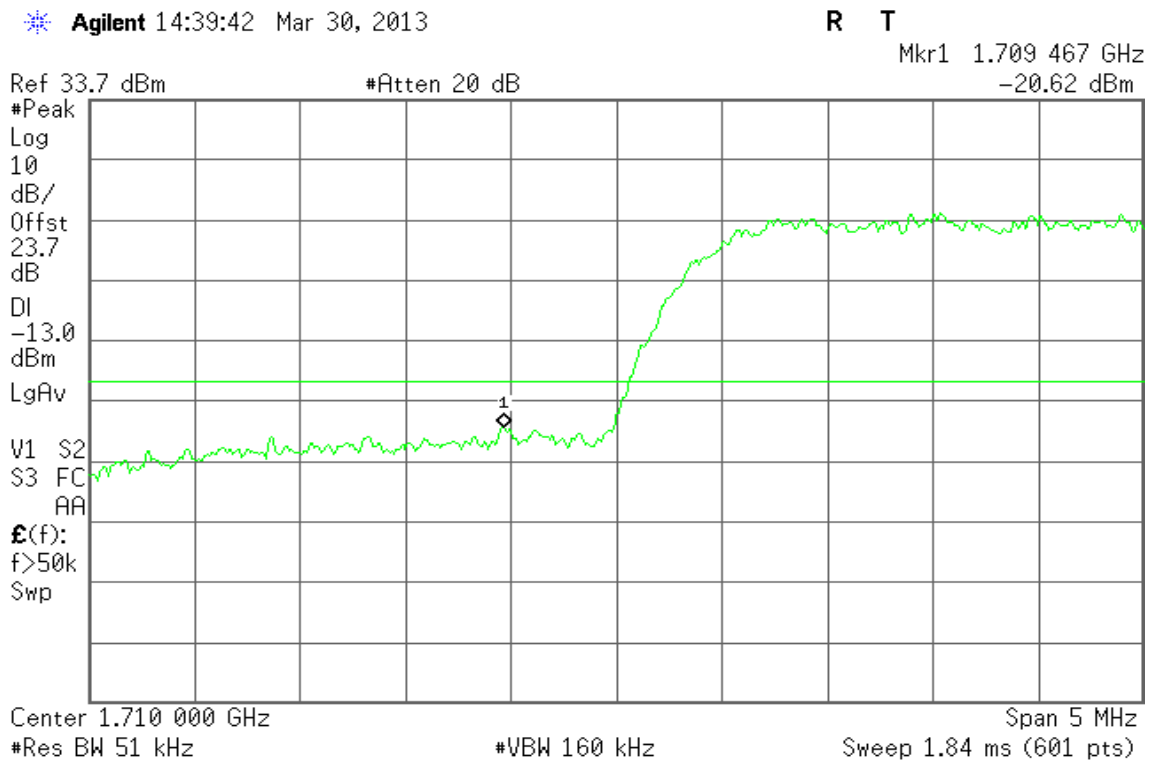
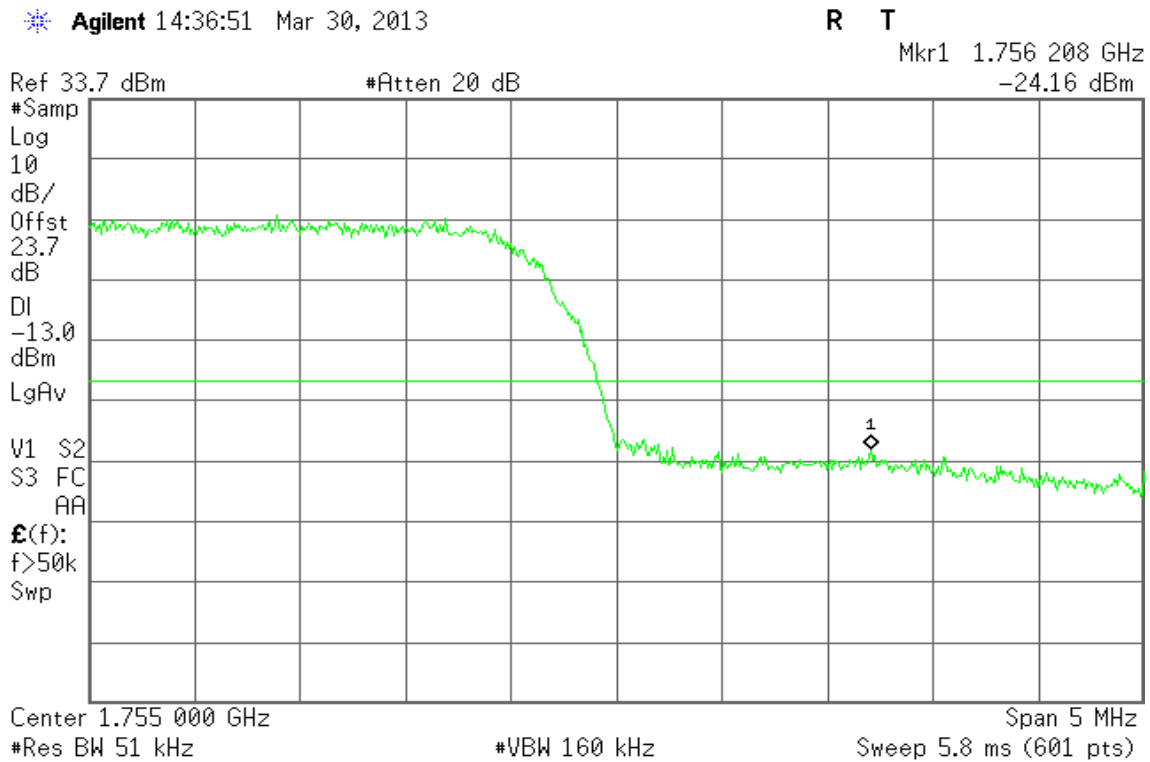

Figure 8-4: Out of Band bandedge at antenna terminals – CH High





HSUPA Band IV

Figure 8-5: Out of Band bandedge at antenna terminals – CH Low

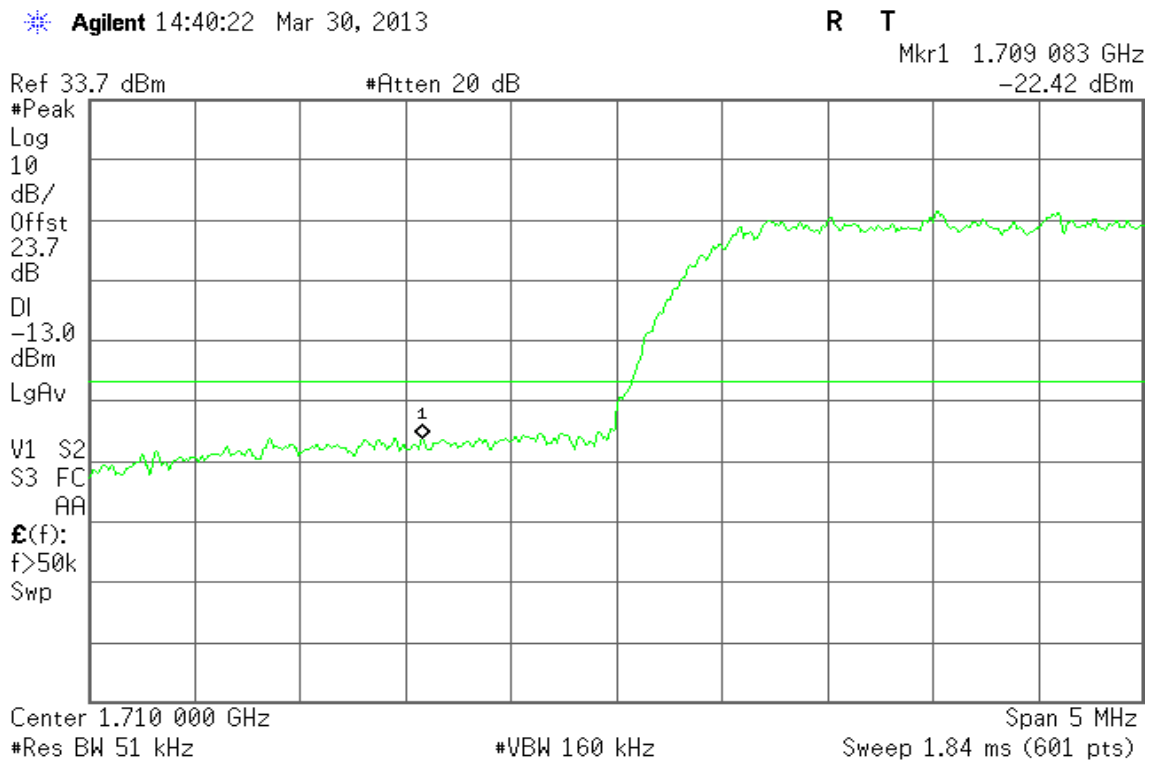
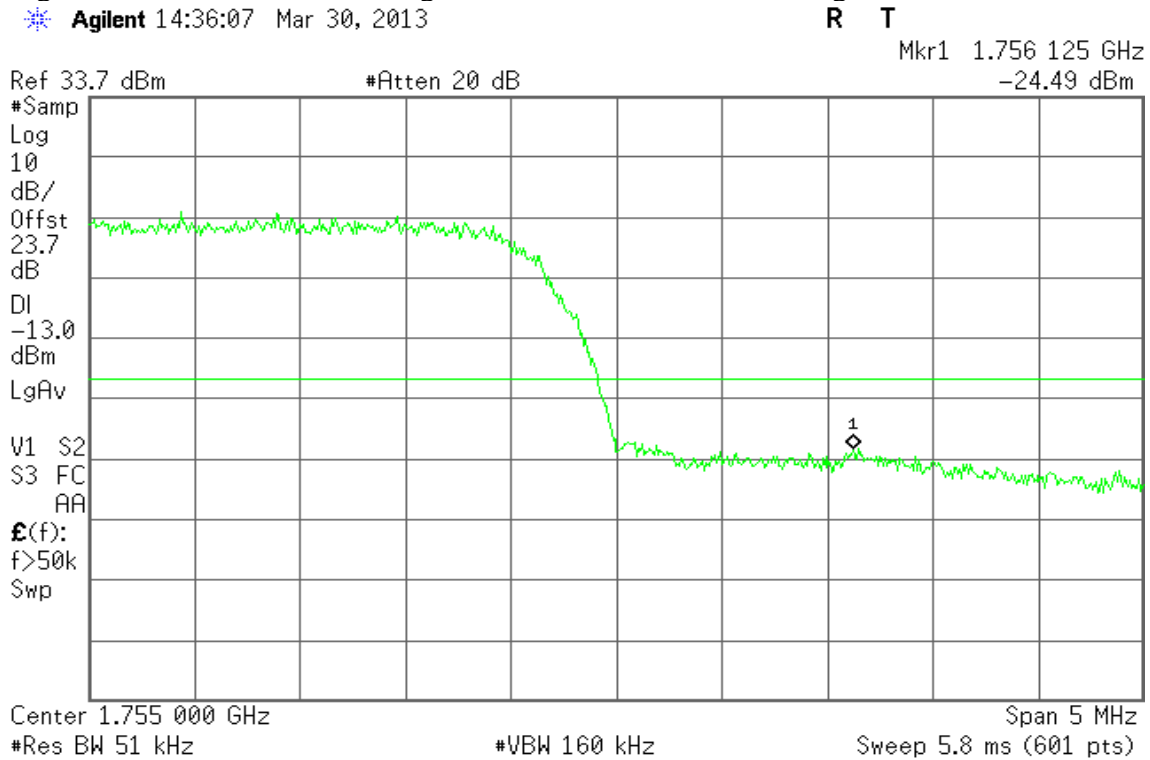

Figure 8-6: Out of Band bandedge at antenna terminals – CH High





7.4 ERP & EIRP MEASUREMENT

Test Configuration

Below 1 GHz

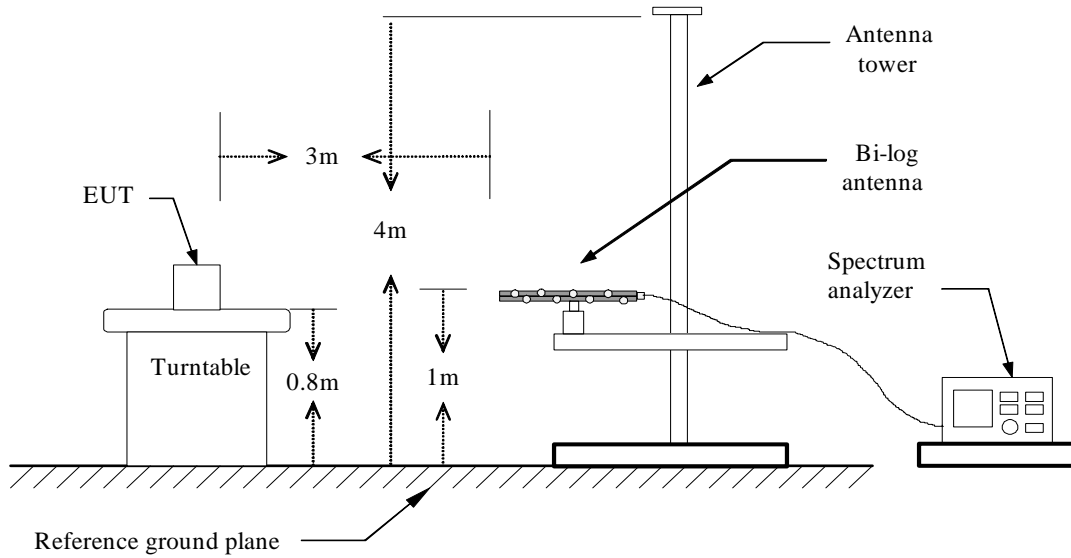

Above 1 GHz

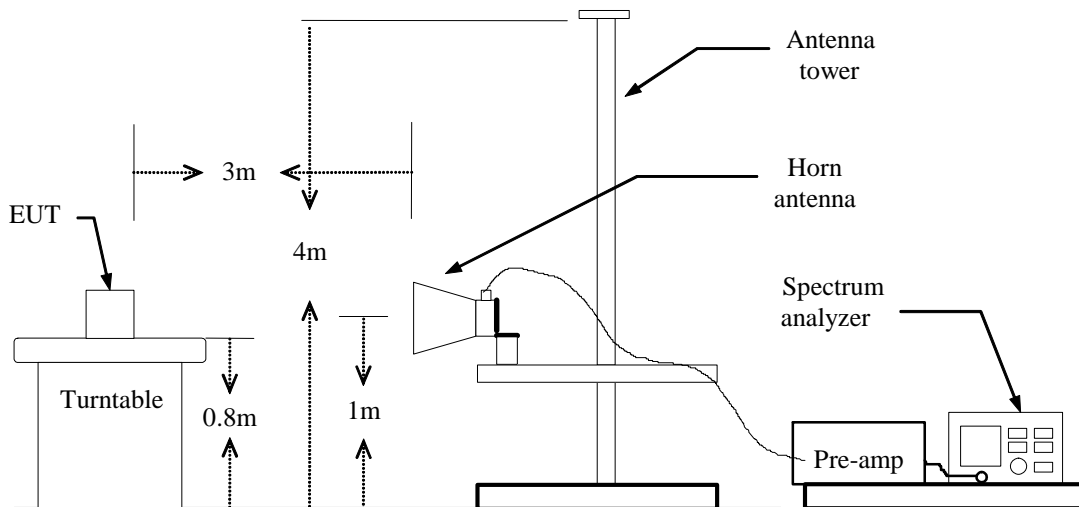



For Substituted Method Test Set-UP

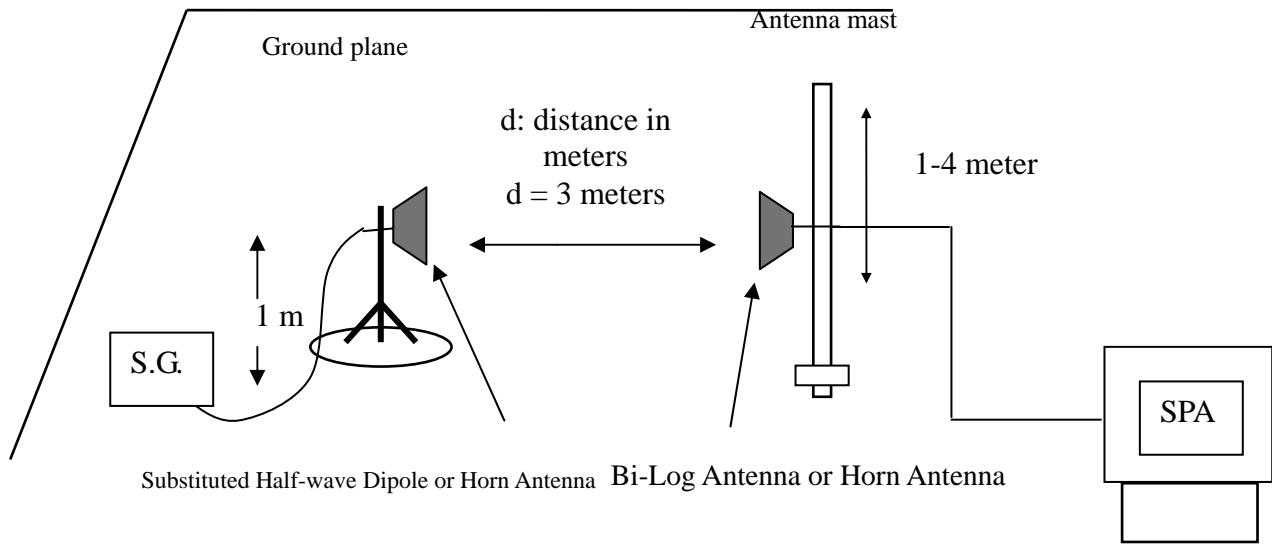

TEST PROCEDURE

The EUT was placed on a non-conductive turntable using a non-conductive support. The radiated emission at the fundamental frequency was measured at 3 m with a test antenna and EMI spectrum analyzer.

During the measurement of the EUT, the resolution bandwidth was set to 3MHz and the average bandwidth was set to 3MHz. The highest emission was recorded with the rotation of the turntable and the lowering of the test antenna. The reading was recorded and the field strength (E in dBuV/m) was calculated.

ERP in frequency band 824-849MHz, and EIRP in frequency band 1851.25 –1910MHz were measured using a substitution method. The EUT was replaced by half-wave dipole (824-849MHz) or horn antenna (1851.25-1910MHz) connected to a signal generator. The spectrum analyzer reading was recorded and ERP/EIRP was calculated as follows:

$$\text{ERP} = \text{S.G. output (dBm)} + \text{Antenna Gain (dBd)} - \text{Cable (dB)}$$

$$\text{EIRP} = \text{S.G. output (dBm)} + \text{Antenna Gain (dBi)} - \text{Cable (dB)}$$

TEST RESULTS

No non-compliance noted.

**WCDMA BAND IV Test Data**

Channel	Frequency (MHz)	Antenna Pol.	S.G. (dBm)	Cable loss (dB)	Ant.Gain (dBi)	Emission level (dBm)	Limit (dBm)	Margin (dB)
1312	1712.40	V	17.32	5.13	5.92	18.11	33.00	-14.89
	1712.40	H	19.33	5.13	5.92	20.12	33.00	-12.88
1427	1735.40	V	17.57	5.17	5.88	18.28	33.00	-14.72
	1735.40	H	22.04	5.17	5.88	*22.75	33.00	-10.25
1513	1752.60	V	18.33	5.2	5.85	18.98	33.00	-14.02
	1752.60	H	20.69	5.2	5.85	21.34	33.00	-11.66

HSDPA BAND IV Test Data

Channel	Frequency (MHz)	Antenna Pol.	S.G. (dBm)	Cable loss (dB)	Ant.Gain (dBi)	Emission level (dBm)	Limit (dBm)	Margin (dB)
1312	1712.40	V	22.35	5.13	5.92	*23.14	33.00	-9.86
	1712.40	H	17.78	5.13	5.92	18.57	33.00	-14.43
1427	1735.40	V	22.12	5.17	5.88	22.83	33.00	-10.17
	1735.40	H	18.52	5.17	5.88	19.23	33.00	-13.77
1513	1752.60	V	20.8	5.2	5.85	21.45	33.00	-11.55
	1752.60	H	18.9	5.21	5.84	19.53	33.00	-13.47

HSUPA BAND IV Test Data

Channel	Frequency (MHz)	Antenna Pol.	S.G. (dBm)	Cable loss (dB)	Ant.Gain (dBi)	Emission level (dBm)	Limit (dBm)	Margin (dB)
1312	1712.40	V	17.88	5.13	5.92	18.67	33.00	-14.33
	1712.40	H	22.73	5.13	5.92	23.52	33.00	-9.48
1427	1735.40	V	19.47	5.17	5.88	20.18	33.00	-12.82
	1735.40	H	23.05	5.17	5.88	*23.76	33.00	-9.24
1513	1752.60	V	19.79	5.2	5.85	20.44	33.00	-12.56
	1752.60	H	22.14	5.2	5.85	22.79	33.00	-10.21



7.5 FIELD STRENGTH OF SPURIOUS RADIATION MEASUREMENT

LIMIT

§27.53 (g) For operations in the 1710–1755MHz and 2110–2155 MHz bands, the power of any emission outside a licensee’s frequency block shall be attenuated below the transmitter power (P) by at least $43 + 10 \log_{10} (P)$ dB.

Test Configuration

Below 1 GHz

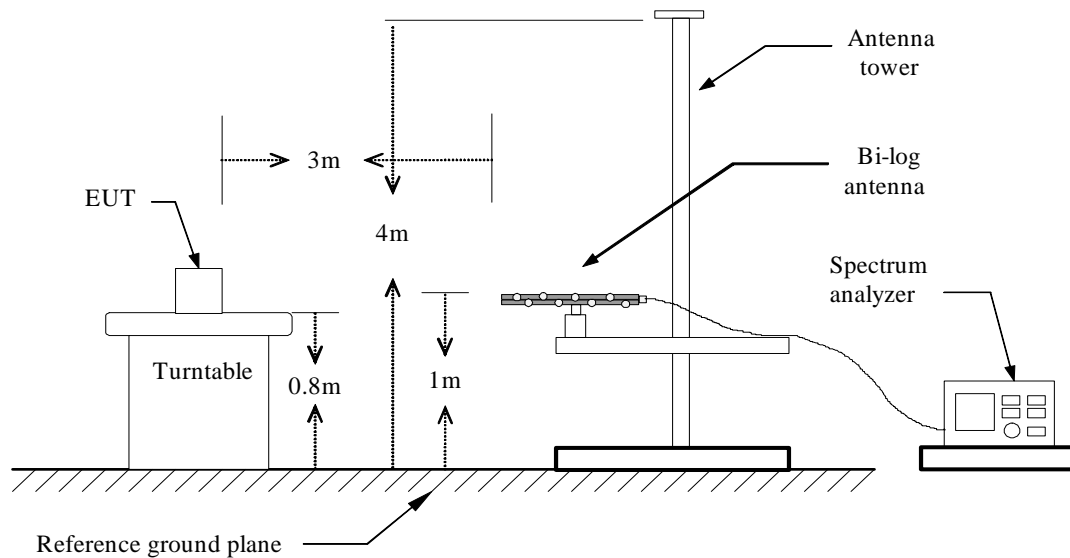

Above 1 GHz

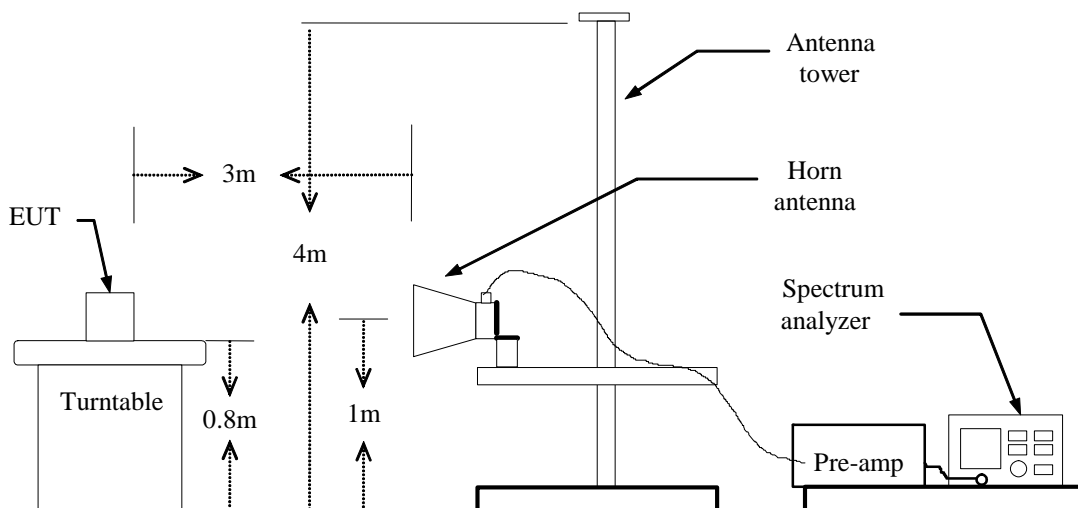



Substituted Method Test Set-up

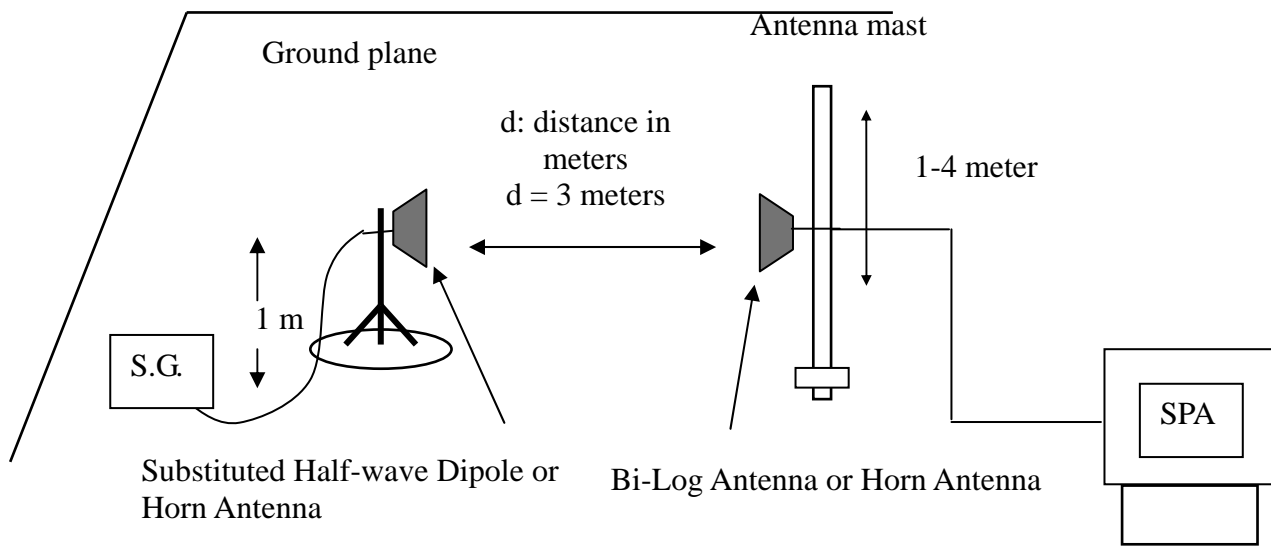

TEST PROCEDURE

The EUT was placed on a non-conductive, the measurement antenna was placed at a distance of 3 meters from the EUT. During the tests, the antenna height and the EUT azimuth were varied in order to identify the maximum level of emissions from the EUT. This maximization process was repeated with the EUT positioned in each of its three orthogonal orientations.

The frequency range up to tenth harmonic was investigated for each of three fundamental frequency (low, middle and high channels). Once spurious emission were identified, the power of the emission was determined using the substitution method.

The spurious emissions attenuation was calculated as the difference between radiated power at the fundamental frequency and the spurious emissions frequency.

$$\text{ERP} = \text{S.G. output (dBm)} + \text{Antenna Gain (dBd)} - \text{Cable (dB)}$$

$$\text{EIRP} = \text{S.G. output (dBm)} + \text{Antenna Gain (dBi)} - \text{Cable (dB)}$$

TEST RESULTS

Refer to the attached tabular data sheets.

**Below 1GHz****Operation Mode:** WCDMA Band IV / TX / CH 1312**Test Date:** April 1, 2013**Temperature:** 26°C**Tested by:** Wayne Tsai**Humidity:** 60 % RH**Polarity:** Ver. / Hor.

Frequency (MHz)	S.G. (dBm)	Cable loss (dB)	Ant.Gain (dBi)	Emission level (dBm)	Limit (dBm)	Margin (dB)	Antenna Polarization (V/H)
95.9600	-70.96	1.13	0.26	-71.83	-13.00	-58.83	V
208.4800	-77.48	1.67	5.2	-73.95	-13.00	-60.95	V
263.7700	-80.71	1.93	5.41	-77.23	-13.00	-64.23	V
668.2600	-70.17	3.07	6.3	-66.94	-13.00	-53.94	V
883.6000	-74.57	3.48	6.7	-71.35	-13.00	-58.35	V
935.9800	-73.02	3.6	6.4	-70.22	-13.00	-57.22	V
120.2100	-61.29	1.27	-2.06	-64.62	-13.00	-51.62	H
207.5100	-74.83	1.67	4.95	-71.55	-13.00	-58.55	H
603.2700	-64.76	2.91	6.37	-61.30	-13.00	-48.30	H
670.2000	-68.13	3.07	6.3	-64.90	-13.00	-51.90	H
883.6000	-68.41	3.48	6.7	-65.19	-13.00	-52.19	H
935.9800	-67.05	3.6	6.4	-64.25	-13.00	-51.25	H

Remark:

1. *Measuring frequencies from 1 GHz to the 10th harmonic of highest fundamental frequency.*
2. *Measurements above show only up to 6 maximum emissions noted, or would be lesser, with " N/A " remark, if no specific emissions from the EUT are recorded (ie: margin > 20dB from the applicable limit) and considered that's already beyond the background noise floor.*



Operation Mode: WCDMA Band IV / TX / CH 1427

Test Date: April 1, 2013

Temperature: 26°C

Tested by: Wayne Tsai

Humidity: 60 % RH

Polarity: Ver. / Hor.

Frequency (MHz)	S.G. (dBm)	Cable loss (dB)	Ant.Gain (dBi)	Emission level (dBm)	Limit (dBm)	Margin (dB)	Antenna Polarization (V/H)
52.3100	-66.29	0.82	-4.22	-71.33	-13.00	-58.33	V
208.4800	-76.6	1.67	5.2	-73.07	-13.00	-60.07	V
263.7700	-80.1	1.93	5.41	-76.62	-13.00	-63.62	V
672.1400	-70.96	3.07	6.34	-67.69	-13.00	-54.69	V
883.6000	-73.9	3.48	6.7	-70.68	-13.00	-57.68	V
935.9800	-72.21	3.6	6.4	-69.41	-13.00	-56.41	V
120.2100	-61.62	1.27	-2.06	-64.95	-13.00	-51.95	H
207.5100	-74.12	1.67	4.95	-70.84	-13.00	-57.84	H
408.3000	-75.85	2.44	5.92	-72.37	-13.00	-59.37	H
599.3900	-64.52	2.9	6.39	-61.03	-13.00	-48.03	H
883.6000	-68.42	3.48	6.7	-65.20	-13.00	-52.20	H
935.9800	-66.16	3.6	6.4	-63.36	-13.00	-50.36	H

Remark:

1. *Measuring frequencies from 1 GHz to the 10th harmonic of highest fundamental frequency.*
2. *Measurements above show only up to 6 maximum emissions noted, or would be lesser, with " N/A " remark, if no specific emissions from the EUT are recorded (ie: margin > 20dB from the applicable limit) and considered that's already beyond the background noise floor.*

**Operation Mode:** WCDMA Band IV / TX / CH 1513**Test Date:** April 1, 2013**Temperature:** 26°C**Tested by:** Wayne Tsai**Humidity:** 60 % RH**Polarity:** Ver. / Hor.

Frequency (MHz)	S.G. (dBm)	Cable loss (dB)	Ant.Gain (dBi)	Emission level (dBm)	Limit (dBm)	Margin (dB)	Antenna Polarization (V/H)
51.3400	-64.18	0.81	-4.51	-69.50	-13.00	-56.50	V
207.5100	-76.32	1.67	4.95	-73.04	-13.00	-60.04	V
263.7700	-77.78	1.93	5.41	-74.30	-13.00	-61.30	V
672.1400	-71.26	3.07	6.34	-67.99	-13.00	-54.99	V
883.6000	-72.94	3.48	6.7	-69.72	-13.00	-56.72	V
935.9800	-71.83	3.6	6.4	-69.03	-13.00	-56.03	V
124.0900	-61.46	1.3	-1.81	-64.57	-13.00	-51.57	H
208.4800	-75.45	1.67	5.2	-71.92	-13.00	-58.92	H
411.2100	-74.72	2.45	5.9	-71.27	-13.00	-58.27	H
599.3900	-64.55	2.9	6.39	-61.06	-13.00	-48.06	H
883.6000	-68.88	3.48	6.7	-65.66	-13.00	-52.66	H
935.9800	-66.83	3.6	6.4	-64.03	-13.00	-51.03	H

Remark:

1. *Measuring frequencies from 1 GHz to the 10th harmonic of highest fundamental frequency.*
2. *Measurements above show only up to 6 maximum emissions noted, or would be lesser, with " N/A " remark, if no specific emissions from the EUT are recorded (ie: margin > 20dB from the applicable limit) and considered that's already beyond the background noise floor.*



Operation Mode: WCDMA / HSDPA Band IV /
TX / CH 1312

Test Date: April 1, 2013

Temperature: 26°C

Tested by: Wayne Tsai

Humidity: 60 % RH

Polarity: Ver. / Hor.

Frequency (MHz)	S.G. (dBm)	Cable loss (dB)	Ant.Gain (dBi)	Emission level (dBm)	Limit (dBm)	Margin (dB)	Antenna Polarization (V/H)
51.3400	-65.08	0.81	-4.51	-70.40	-13.00	-57.40	V
95.9600	-71.67	1.13	0.26	-72.54	-13.00	-59.54	V
207.5100	-76.9	1.67	4.95	-73.62	-13.00	-60.62	V
610.0600	-72.65	2.94	6.29	-69.30	-13.00	-56.30	V
673.1100	-71.19	3.08	6.36	-67.91	-13.00	-54.91	V
935.9800	-72.63	3.6	6.4	-69.83	-13.00	-56.83	V
124.0900	-61.18	1.3	-1.81	-64.29	-13.00	-51.29	H
207.5100	-74.88	1.67	4.95	-71.60	-13.00	-58.60	H
312.2700	-78.38	2.14	5.76	-74.76	-13.00	-61.76	H
607.1500	-65.05	2.93	6.33	-61.65	-13.00	-48.65	H
883.6000	-67.98	3.48	6.7	-64.76	-13.00	-51.76	H
935.9800	-66.88	3.6	6.4	-64.08	-13.00	-51.08	H

Remark:

1. Measuring frequencies from 1 GHz to the 10th harmonic of highest fundamental frequency.
2. Measurements above show only up to 6 maximum emissions noted, or would be lesser, with " N/A " remark, if no specific emissions from the EUT are recorded (ie: margin>20dB from the applicable limit) and considered that's already beyond the background noise floor.



Operation Mode: WCDMA / HSDPA Band IV /
TX / CH 1427

Test Date: April 1, 2013

Temperature: 26°C

Tested by: Wayne Tsai

Humidity: 60 % RH

Polarity: Ver. / Hor.

Frequency (MHz)	S.G. (dBm)	Cable loss (dB)	Ant.Gain (dBi)	Emission level (dBm)	Limit (dBm)	Margin (dB)	Antenna Polarization (V/H)
51.3400	-64.63	0.81	-4.51	-69.95	-13.00	-56.95	V
95.9600	-71.3	1.13	0.26	-72.17	-13.00	-59.17	V
208.4800	-77.1	1.67	5.2	-73.57	-13.00	-60.57	V
672.1400	-70.67	3.07	6.34	-67.40	-13.00	-54.40	V
883.6000	-73.76	3.48	6.7	-70.54	-13.00	-57.54	V
935.9800	-72.75	3.6	6.4	-69.95	-13.00	-56.95	V
48.4300	-63.61	0.79	-5.83	-70.23	-13.00	-57.23	H
123.1200	-61.45	1.29	-1.87	-64.61	-13.00	-51.61	H
207.5100	-73.66	1.67	4.95	-70.38	-13.00	-57.38	H
608.1200	-64.97	2.93	6.32	-61.58	-13.00	-48.58	H
883.6000	-68.03	3.48	6.7	-64.81	-13.00	-51.81	H
935.9800	-66.97	3.6	6.4	-64.17	-13.00	-51.17	H

Remark:

1. Measuring frequencies from 1 GHz to the 10th harmonic of highest fundamental frequency.
2. Measurements above show only up to 6 maximum emissions noted, or would be lesser, with " N/A " remark, if no specific emissions from the EUT are recorded (ie: margin > 20dB from the applicable limit) and considered that's already beyond the background noise floor.



Operation Mode: WCDMA / HSDPA Band IV /
TX / CH 1513

Test Date: April 1, 2013

Temperature: 26°C

Tested by: Wayne Tsai

Humidity: 60 % RH

Polarity: Ver. / Hor.

Frequency (MHz)	S.G. (dBm)	Cable loss (dB)	Ant.Gain (dBi)	Emission level (dBm)	Limit (dBm)	Margin (dB)	Antenna Polarization (V/H)
51.3400	-65.51	0.81	-4.51	-70.83	-13.00	-57.83	V
95.9600	-71.8	1.13	0.26	-72.67	-13.00	-59.67	V
207.5100	-77.1	1.67	4.95	-73.82	-13.00	-60.82	V
263.7700	-78.7	1.93	5.41	-75.22	-13.00	-62.22	V
665.3500	-70.68	3.06	6.3	-67.44	-13.00	-54.44	V
883.6000	-73.77	3.48	6.7	-70.55	-13.00	-57.55	V
120.2100	-61.91	1.27	-2.06	-65.24	-13.00	-52.24	H
263.7700	-76.5	1.93	5.41	-73.02	-13.00	-60.02	H
359.8000	-75.38	2.27	5.7	-71.95	-13.00	-58.95	H
603.2700	-65.24	2.91	6.37	-61.78	-13.00	-48.78	H
883.6000	-68.55	3.48	6.7	-65.33	-13.00	-52.33	H
935.9800	-66.22	3.6	6.4	-63.42	-13.00	-50.42	H

Remark:

1. Measuring frequencies from 1 GHz to the 10th harmonic of highest fundamental frequency.
2. Measurements above show only up to 6 maximum emissions noted, or would be lesser, with " N/A " remark, if no specific emissions from the EUT are recorded (ie: margin>20dB from the applicable limit) and considered that's already beyond the background noise floor.



Operation Mode: WCDMA / HSUPA Band IV / TX / CH 1312 **Test Date:** April 1, 2013
Temperature: 26°C **Tested by:** Wayne Tsai
Humidity: 60 % RH **Polarity:** Ver. / Hor.

Frequency (MHz)	S.G. (dBm)	Cable loss (dB)	Ant.Gain (dBi)	Emission level (dBm)	Limit (dBm)	Margin (dB)	Antenna Polarization (V/H)
51.3400	-64.84	0.81	-4.51	-70.16	-13.00	-57.16	V
95.9600	-71.16	1.13	0.26	-72.03	-13.00	-59.03	V
154.1600	-74.59	1.45	1.01	-75.03	-13.00	-62.03	V
207.5100	-77.14	1.67	4.95	-73.86	-13.00	-60.86	V
673.1100	-70.64	3.08	6.36	-67.36	-13.00	-54.36	V
883.6000	-73.99	3.48	6.7	-70.77	-13.00	-57.77	V
935.9800	-73.5	3.6	6.4	-70.70	-13.00	-57.70	V
48.4300	-63.4	0.79	-5.83	-70.02	-13.00	-57.02	H
120.2100	-60.57	1.27	-2.06	-63.90	-13.00	-50.90	H
207.5100	-75.25	1.67	4.95	-71.97	-13.00	-58.97	H
300.6300	-78.95	2.1	5.61	-75.44	-13.00	-62.44	H
608.1200	-64.43	2.93	6.32	-61.04	-13.00	-48.04	H
935.9800	-66.88	3.6	6.4	-64.08	-13.00	-51.08	H

Remark:

1. *Measuring frequencies from 1 GHz to the 10th harmonic of highest fundamental frequency.*
2. *Measurements above show only up to 6 maximum emissions noted, or would be lesser, with " N/A " remark, if no specific emissions from the EUT are recorded (ie: margin > 20dB from the applicable limit) and considered that's already beyond the background noise floor.*



Operation Mode: WCDMA / HSUPA Band IV / TX / CH 1427 **Test Date:** April 1, 2013

Temperature: 26°C **Tested by:** Wayne Tsai

Humidity: 60 % RH **Polarity:** Ver. / Hor.

Frequency (MHz)	S.G. (dBm)	Cable loss (dB)	Ant.Gain (dBi)	Emission level (dBm)	Limit (dBm)	Margin (dB)	Antenna Polarization (V/H)
51.3400	-64.57	0.81	-4.51	-69.89	-13.00	-56.89	V
95.9600	-70.86	1.13	0.26	-71.73	-13.00	-58.73	V
207.5100	-76.46	1.67	4.95	-73.18	-13.00	-60.18	V
263.7700	-78.32	1.93	5.41	-74.84	-13.00	-61.84	V
675.0500	-70.47	3.08	6.4	-67.15	-13.00	-54.15	V
883.6000	-73.42	3.48	6.7	-70.20	-13.00	-57.20	V
124.0900	-62.08	1.3	-1.81	-65.19	-13.00	-52.19	H
208.4800	-75.48	1.67	5.2	-71.95	-13.00	-58.95	H
384.0500	-77.23	2.31	5.99	-73.55	-13.00	-60.55	H
606.1800	-64.91	2.93	6.34	-61.50	-13.00	-48.50	H
883.6000	-68.14	3.48	6.7	-64.92	-13.00	-51.92	H
935.9800	-66.47	3.6	6.4	-63.67	-13.00	-50.67	H

Remark:

1. *Measuring frequencies from 1 GHz to the 10th harmonic of highest fundamental frequency.*
2. *Measurements above show only up to 6 maximum emissions noted, or would be lesser, with " N/A " remark, if no specific emissions from the EUT are recorded (ie: margin > 20dB from the applicable limit) and considered that's already beyond the background noise floor.*



Operation Mode: WCDMA / HSUPA Band IV / TX / CH 1513 **Test Date:** April 1, 2013

Temperature: 26°C **Tested by:** Wayne Tsai

Humidity: 60 % RH **Polarity:** Ver. / Hor.

Frequency (MHz)	S.G. (dBm)	Cable loss (dB)	Ant.Gain (dBi)	Emission level (dBm)	Limit (dBm)	Margin (dB)	Antenna Polarization (V/H)
95.9600	-70.84	1.13	0.26	-71.71	-13.00	-58.71	V
154.1600	-74.56	1.45	1.01	-75.00	-13.00	-62.00	V
207.5100	-76.07	1.67	4.95	-72.79	-13.00	-59.79	V
263.7700	-78.95	1.93	5.41	-75.47	-13.00	-62.47	V
672.1400	-71.06	3.07	6.34	-67.79	-13.00	-54.79	V
883.6000	-73.13	3.48	6.7	-69.91	-13.00	-56.91	V
47.4600	-62.86	0.78	-6.58	-70.22	-13.00	-57.22	H
120.2100	-60.62	1.27	-2.06	-63.95	-13.00	-50.95	H
208.4800	-75.46	1.67	5.2	-71.93	-13.00	-58.93	H
602.3000	-64.63	2.91	6.38	-61.16	-13.00	-48.16	H
883.6000	-68.25	3.48	6.7	-65.03	-13.00	-52.03	H
935.9800	-65.54	3.6	6.4	-62.74	-13.00	-49.74	H

Remark:

1. *Measuring frequencies from 1 GHz to the 10th harmonic of highest fundamental frequency.*
2. *Measurements above show only up to 6 maximum emissions noted, or would be lesser, with " N/A " remark, if no specific emissions from the EUT are recorded (ie: margin > 20dB from the applicable limit) and considered that's already beyond the background noise floor.*



Above 1GHz

Operation Mode: WCDMA Band IV / TX / CH 1312

Test Date: April 1, 2013

Temperature: 26°C

Tested by: Wayne Tsai

Humidity: 60 % RH

Polarity: Ver. / Hor.

Frequency (MHz)	S.G. (dBm)	Cable loss (dB)	Ant.Gain (dBi)	Emission level (dBm)	Limit (dBm)	Margin (dB)	Antenna Polarization (V/H)
5144.000	-50.07	9.5	10.66	-48.91	-13.00	-35.91	V
6929.000	-44.15	11.53	11.81	-43.87	-13.00	-30.87	V
N/A							
5165.000	-49.1	9.52	10.67	-47.95	-13.00	-34.95	H
6215.000	-46.46	11.15	11.07	-46.54	-13.00	-33.54	H
N/A							

Remark:

1. *Measuring frequencies from 1 GHz to the 10th harmonic of highest fundamental frequency.*
2. *Measurements above show only up to 6 maximum emissions noted, or would be lesser, with " N/A " remark, if no specific emissions from the EUT are recorded (ie: margin>20dB from the applicable limit) and considered that's already beyond the background noise floor.*



Operation Mode: WCDMA Band IV / TX / CH 1427

Test Date: April 1, 2013

Temperature: 26°C

Tested by: Wayne Tsai

Humidity: 60 % RH

Polarity: Ver. / Hor.

Frequency (MHz)	S.G. (dBm)	Cable loss (dB)	Ant.Gain (dBi)	Emission level (dBm)	Limit (dBm)	Margin (dB)	Antenna Polarization (V/H)
3996.000	-50.82	8.35	9.4	-49.77	-13.00	-36.77	V
5200.000	-50.3	9.56	10.68	-49.18	-13.00	-36.18	V
N/A							
3989.000	-49.52	8.35	9.39	-48.48	-13.00	-35.48	H
5606.000	-49.65	10.19	10.82	-49.02	-13.00	-36.02	H
N/A							

Remark:

1. *Measuring frequencies from 1 GHz to the 10th harmonic of highest fundamental frequency.*
2. *Measurements above show only up to 6 maximum emissions noted, or would be lesser, with " N/A " remark, if no specific emissions from the EUT are recorded (ie: margin > 20dB from the applicable limit) and considered that's already beyond the background noise floor.*



Operation Mode: WCDMA Band IV / TX / CH 1513

Test Date: April 1, 2013

Temperature: 26°C

Tested by: Wayne Tsai

Humidity: 60 % RH

Polarity: Ver. / Hor.

Frequency (MHz)	S.G. (dBm)	Cable loss (dB)	Ant.Gain (dBi)	Emission level (dBm)	Limit (dBm)	Margin (dB)	Antenna Polarization (V/H)
4003.000	-50.27	8.35	9.4	-49.22	-13.00	-36.22	V
6173.000	-48.12	11.06	11.04	-48.14	-13.00	-35.14	V
N/A							
3632.000	-49.84	8.14	9.03	-48.95	-13.00	-35.95	H
6159.000	-47.42	10.97	11.03	-47.36	-13.00	-34.36	H
N/A							

Remark:

1. *Measuring frequencies from 1 GHz to the 10th harmonic of highest fundamental frequency.*
2. *Measurements above show only up to 6 maximum emissions noted, or would be lesser, with " N/A " remark, if no specific emissions from the EUT are recorded (ie: margin > 20dB from the applicable limit) and considered that's already beyond the background noise floor.*



Operation Mode: WCDMA / HSDPA Band IV / TX / CH 1312

Test Date: April 1, 2013

Temperature: 26°C

Tested by: Wayne Tsai

Humidity: 60 % RH

Polarity: Ver. / Hor.

Frequency (MHz)	S.G. (dBm)	Cable loss (dB)	Ant.Gain (dBi)	Emission level (dBm)	Limit (dBm)	Margin (dB)	Antenna Polarization (V/H)
4808.000	-50.23	9.32	10.29	-49.26	-13.00	-36.26	V
6747.000	-47.03	11.3	11.6	-46.73	-13.00	-33.73	V
N/A							
4787.000	-49.21	9.3	10.26	-48.25	-13.00	-35.25	H
6201.000	-47.8	11.22	11.06	-47.96	-13.00	-34.96	H
N/A							

Remark:

1. Measuring frequencies from 1 GHz to the 10th harmonic of highest fundamental frequency.
2. Measurements above show only up to 6 maximum emissions noted, or would be lesser, with " N/A " remark, if no specific emissions from the EUT are recorded (ie: margin>20dB from the applicable limit) and considered that's already beyond the background noise floor.



Operation Mode: WCDMA / HSDPA Band IV /
TX / CH 1427

Test Date: April 1, 2013

Temperature: 26°C

Tested by: Wayne Tsai

Humidity: 60 % RH

Polarity: Ver. / Hor.

Frequency (MHz)	S.G. (dBm)	Cable loss (dB)	Ant.Gain (dBi)	Emission level (dBm)	Limit (dBm)	Margin (dB)	Antenna Polarization (V/H)
3975.000	-50.11	8.36	9.38	-49.09	-13.00	-36.09	V
5158.000	-50.75	9.51	10.66	-49.60	-13.00	-36.60	V
N/A							
4255.000	-49.89	8.55	9.6	-48.84	-13.00	-35.84	H
6516.000	-46.29	11.07	11.32	-46.04	-13.00	-33.04	H
N/A							

Remark:

1. Measuring frequencies from 1 GHz to the 10th harmonic of highest fundamental frequency.
2. Measurements above show only up to 6 maximum emissions noted, or would be lesser, with " N/A " remark, if no specific emissions from the EUT are recorded (ie: margin > 20dB from the applicable limit) and considered that's already beyond the background noise floor.



Operation Mode: WCDMA / HSDPA Band IV /
TX / CH 1513

Test Date: April 1, 2013

Temperature: 26°C

Tested by: Wayne Tsai

Humidity: 60 % RH

Polarity: Ver. / Hor.

Frequency (MHz)	S.G. (dBm)	Cable loss (dB)	Ant.Gain (dBi)	Emission level (dBm)	Limit (dBm)	Margin (dB)	Antenna Polarization (V/H)
3870.000	-50.37	8.35	9.27	-49.45	-13.00	-36.45	V
4619.000	-50.23	9.13	9.99	-49.37	-13.00	-36.37	V
N/A							
2995.000	-50.74	7.02	7.39	-50.37	-13.00	-37.37	H
4885.000	-50.32	9.27	10.42	-49.17	-13.00	-36.17	H
N/A							

Remark:

1. Measuring frequencies from 1 GHz to the 10th harmonic of highest fundamental frequency.
2. Measurements above show only up to 6 maximum emissions noted, or would be lesser, with " N/A " remark, if no specific emissions from the EUT are recorded (ie: margin>20dB from the applicable limit) and considered that's already beyond the background noise floor.



Operation Mode: WCDMA / HSUPA Band IV / TX / CH 1312 **Test Date:** April 1, 2013

Temperature: 26°C **Tested by:** Wayne Tsai

Humidity: 60 % RH **Polarity:** Ver. / Hor.

Frequency (MHz)	S.G. (dBm)	Cable loss (dB)	Ant.Gain (dBi)	Emission level (dBm)	Limit (dBm)	Margin (dB)	Antenna Polarization (V/H)
3457.000	-51.49	7.74	8.77	-50.46	-13.00	-37.46	V
5039.000	-51.19	9.43	10.62	-50.00	-13.00	-37.00	V
N/A							
5732.000	-49.63	10.24	10.85	-49.02	-13.00	-36.02	H
6929.000	-43.97	11.53	11.81	-43.69	-13.00	-30.69	H
N/A							

Remark:

1. Measuring frequencies from 1 GHz to the 10th harmonic of highest fundamental frequency.
2. Measurements above show only up to 6 maximum emissions noted, or would be lesser, with " N/A " remark, if no specific emissions from the EUT are recorded (ie: margin>20dB from the applicable limit) and considered that's already beyond the background noise floor.



Operation Mode: WCDMA / HSUPA Band IV / TX / CH 1427 **Test Date:** April 1, 2013

Temperature: 26°C **Tested by:** Wayne Tsai

Humidity: 60 % RH **Polarity:** Ver. / Hor.

Frequency (MHz)	S.G. (dBm)	Cable loss (dB)	Ant.Gain (dBi)	Emission level (dBm)	Limit (dBm)	Margin (dB)	Antenna Polarization (V/H)
4248.000	-50.44	8.54	9.6	-49.38	-13.00	-36.38	V
5424.000	-50.72	9.85	10.77	-49.80	-13.00	-36.80	V
N/A							
5207.000	-48.98	9.57	10.68	-47.87	-13.00	-34.87	H
5963.000	-49.29	10.67	10.89	-49.07	-13.00	-36.07	H
N/A							

Remark:

1. *Measuring frequencies from 1 GHz to the 10th harmonic of highest fundamental frequency.*
2. *Measurements above show only up to 6 maximum emissions noted, or would be lesser, with " N/A " remark, if no specific emissions from the EUT are recorded (ie: margin > 20dB from the applicable limit) and considered that's already beyond the background noise floor.*



Operation Mode: WCDMA / HSUPA Band IV / TX / CH 1513 **Test Date:** April 1, 2013

Temperature: 26°C **Tested by:** Wayne Tsai

Humidity: 60 % RH **Polarity:** Ver. / Hor.

Frequency (MHz)	S.G. (dBm)	Cable loss (dB)	Ant.Gain (dBi)	Emission level (dBm)	Limit (dBm)	Margin (dB)	Antenna Polarization (V/H)
5879.000	-50.09	10.4	10.88	-49.61	-13.00	-36.61	V
7356.000	-41.65	12.07	12.47	-41.25	-13.00	-28.25	V
N/A							
5067.000	-50.16	9.44	10.63	-48.97	-13.00	-35.97	H
6285.000	-47.28	10.82	11.13	-46.97	-13.00	-33.97	H
N/A							

Remark:

1. *Measuring frequencies from 1 GHz to the 10th harmonic of highest fundamental frequency.*
2. *Measurements above show only up to 6 maximum emissions noted, or would be lesser, with " N/A " remark, if no specific emissions from the EUT are recorded (ie: margin>20dB from the applicable limit) and considered that's already beyond the background noise floor.*



7.6 FREQUENCY STABILITY V.S. TEMPERATURE MEASUREMENT

LIMIT

According to FCC §27.54.

Frequency Tolerance: 2.5 ppm

Test Configuration

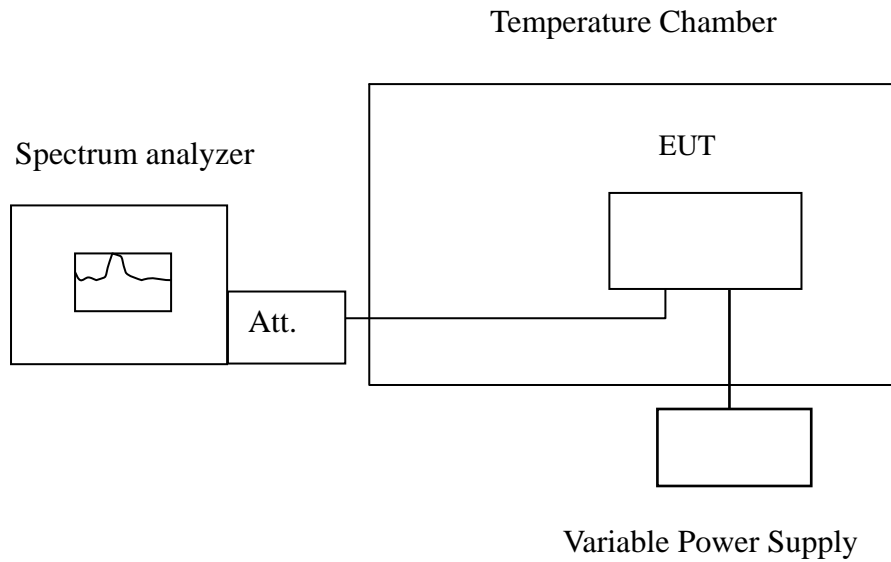

Remark: Measurement setup for testing on Antenna connector.



TEST PROCEDURE

The equipment under test was connected to an external AC or DC power supply and input rated voltage. RF output was connected to a frequency counter or spectrum analyzer via feed through attenuators. The EUT was placed inside the temperature chamber. Set the spectrum analyzer RBW low enough to obtain the desired frequency resolution and measure EUT 20°C operating frequency as reference frequency. Turn EUT off and set the chamber temperature to -30°C. After the temperature stabilized for approximately 30 minutes recorded the frequency. Repeat step measure with 10°C increased per stage until the highest temperature of +50°C reached.

TEST RESULTS

No non-compliance noted.

Reference Frequency: WCDMA Band IV Mid Channel 1735.40 MHz @ 20°C				
Limit: ± 2.5 ppm = 4338Hz				
Power Supply Vdc	Environment Temperature (°C)	Frequency (Hz)	Delta (Hz)	Limit (Hz)
3.7	50	1735399997	-9	4338
	40	1735399995	-11	
	30	1735399993	-13	
	20	1735400006	0	
	10	1735399992	-14	
	0	1735399989	-17	
	-10	1735399988	-18	
	-20	1735399988	-18	
	-30	1735399989	-17	

Reference Frequency: HSDPA Band IV Mid Channel 1735.40 MHz @ 20°C				
Limit: ± 2.5 ppm = 4338Hz				
Power Supply Vdc	Environment Temperature (°C)	Frequency (Hz)	Delta (Hz)	Limit (Hz)
3.7	50	1735399998	-12	4338
	40	1735399995	-13	
	30	1735399993	-14	
	20	1735400003	0	
	10	1735399995	-20	
	0	1735399993	-10	
	-10	1735399995	-14	
	-20	1735399991	-17	
	-30	1735399996	-18	



Reference Frequency: HSUPA Band IV Mid Channel 1735.40 MHz @ 20°C				
Limit: ± 2.5 ppm = 4338Hz				
Power Supply Vdc	Environment Temperature (°C)	Frequency (Hz)	Delta (Hz)	Limit (Hz)
3.7	50	1735399998	-5	4338
	40	1735399995	-8	
	30	1735399993	-10	
	20	1735400003	0	
	10	1735399995	-8	
	0	1735399993	-10	
	-10	1735399995	-8	
	-20	1735399991	-12	
	-30	1735399996	-7	



7.7 FREQUENCY STABILITY V.S. VOLTAGE MEASUREMENT

LIMIT

According to FCC §27.54.

Frequency Tolerance: 2.5 ppm.

Test Configuration

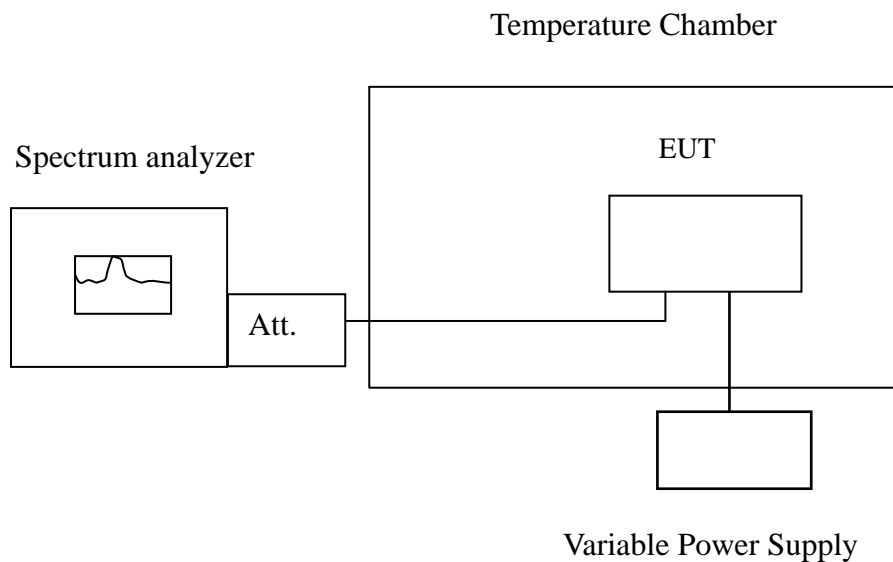

Remark: Measurement setup for testing on Antenna connector.



TEST PROCEDURE

Set chamber temperature to 20°C. Use a variable AC power supply / DC power source to power the EUT and set the voltage to rated voltage. Set the spectrum analyzer RBW low enough to obtain the desired frequency resolution and recorded the frequency.

Reduce the input voltage to specify extreme voltage variation ($\pm 15\%$) and endpoint, record the maximum frequency change.



TEST RESULTS

No non-compliance noted.

Reference Frequency: WCDMA Band IV Mid Channel 1735.40 MHz @ 20°C				
Limit: ± 2.5 ppm = 4338Hz				
Power Supply Vdc	Environment Temperature (°C)	Frequency (Hz)	Delta (Hz)	Limit (Hz)
4.255	20	1735400008	2	4338
3.7		1735400006	0	
3.145		1735400004	-2	
3END		1735400004	-2	

Reference Frequency: HSDPA Band IV Mid Channel 1735.40 MHz @ 20°C				
Limit: ± 2.5 ppm = 4338Hz				
Power Supply Vdc	Environment Temperature (°C)	Frequency (Hz)	Delta (Hz)	Limit (Hz)
4.255	20	1735400008	-1	4338
3.7		1735400006	0	
3.145		1735400004	-2	
3END		1735400004	-4	

Reference Frequency: HSUPA Band IV Mid Channel 1735.40 MHz @ 20°C				
Limit: ± 2.5 ppm = 4338Hz				
Power Supply Vdc	Environment Temperature (°C)	Frequency (Hz)	Delta (Hz)	Limit (Hz)
4.255	20	1735400002	-1	4338
3.7		1735400003	0	
3.145		1735400006	3	
3END		1735400002	-1	