

PCS Ch.
661

TRP		
Total Rad. Pow.	22.64	dBm
Ant. Port Inp. Pow	30	dBm
Peak EIRP	27	dBm
Directivity	4.36	dBi
Efficiency	-7.36	dB
Efficiency	18.37	%
Gain	-3	dBi
NHPRP +/-30	16.65	dBm
NHPRP +/-45	18.25	dBm

Maximum H Valu	26.62	dBm
Maximum H @ T	60	deg.
Maximum H @ P	300	deg.
Minimum H Valu	6.64	dBm
Minimum H @ T	120	deg.
Minimum H @ P	240	deg.
Maximum V Valu	26.58	dBm
Maximum V @ T	120	deg.
Maximum V @ P	0	deg.
Minimum V Valu	1.85	dBm
Minimum V @ T	60	deg.
Minimum V @ P	180	deg.
Maximum H+V V	27	dBm
Maximum H+V @	150	deg.
Maximum H+V @	0	deg.
Minimum H+V V	8.75	dBm
Minimum H+V @	60	deg.
Minimum H+V @	180	deg.

Test Data

Horizontal

	0	30	60	90	120	150	180	210	240	270	300	330
30	9.37	16.36	19.11	19.66	19.36	18.19	12.97	9.11	17.12	19.86	19.39	15.46
60	16.14	19.98	20.61	17.55	13.8	12.7	7.76	17.99	23.99	26.19	26.62	24.47
90	11.28	15.87	14.2	8.82	7.04	9.73	16.5	16.29	7	11.24	14.84	11.54
120	11.51	16.13	14.14	8.83	6.65	9.62	16.61	16.32	6.64	11.1	14.76	11.49
150	20.44	22.3	22.1	20.32	19.65	20.86	21.43	20.67	20.07	19.53	18.4	18.02

Vertical

	0	30	60	90	120	150	180	210	240	270	300	330
30	19.09	18.52	14.86	10.88	11.56	17.68	21.87	22.39	19.54	10.19	8.9	16.78
60	15.11	13.18	17.18	14.81	10.68	9.92	1.85	15.15	17.16	12.76	3	14.78
90	26.46	22.3	9.25	16.11	20.21	21.98	23.35	24.53	22.49	13.67	17.71	25.13
120	26.58	21.47	9.33	16.14	20.38	22.12	23.51	24.67	22.62	13.88	18.52	25.12
150	25.91	23.91	17.11	9.98	17.79	22.28	24.49	24.17	20.4	6.99	17.95	24.34

**Horizontal +
Vertical**

	0	30	60	90	120	150	180	210	240	270	300	330
30	19.53	20.58	20.49	20.2	20.03	20.95	22.39	22.59	21.5	20.31	19.76	19.18
60	18.66	20.8	22.24	19.4	15.53	14.54	8.75	19.81	24.81	26.38	26.64	24.91
90	26.58	23.19	15.41	16.85	20.42	22.23	24.17	25.13	22.61	15.63	19.52	25.31
120	26.71	22.59	15.38	16.88	20.56	22.36	24.32	25.26	22.73	15.72	20.04	25.31
150	27	26.19	23.3	20.71	21.83	24.64	26.23	25.77	23.25	19.76	21.19	25.25

PCS Ch. 661Up
View
3D Graph Excel

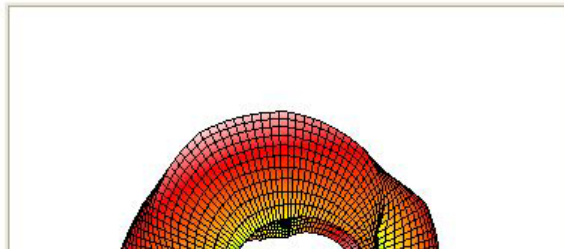

PCS Ch.
661Down View
3D Graph Excel

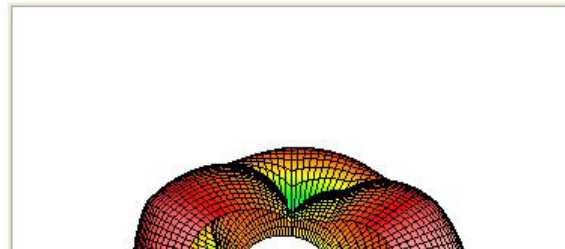

PCS Ch.
661Front View
3D Graph Excel

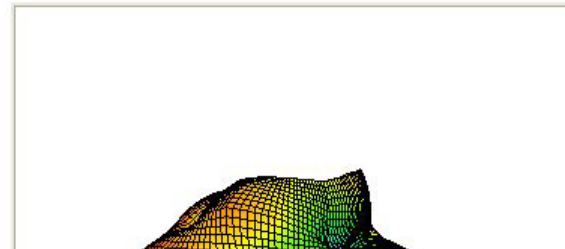

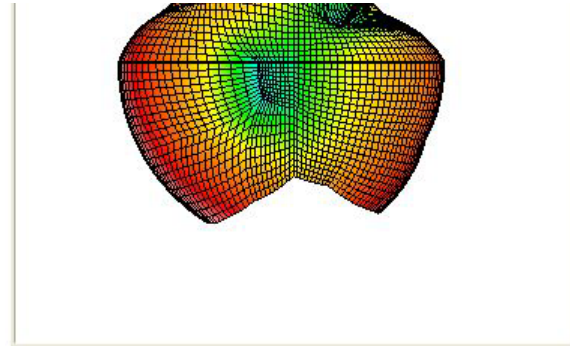
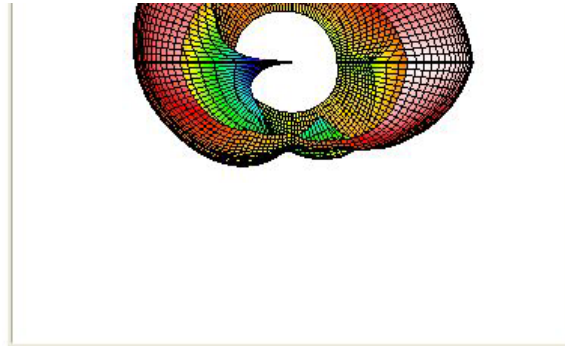
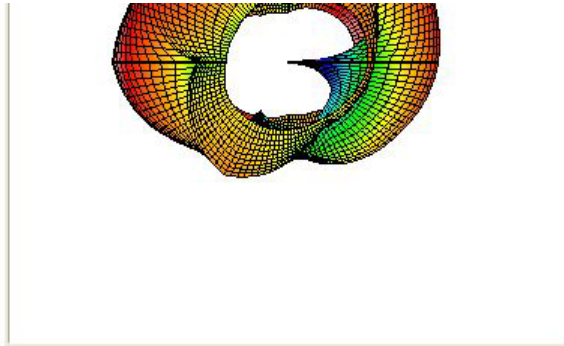

PCS Ch.
661@Theta 30.0
Horizontal
Excel XY Plot

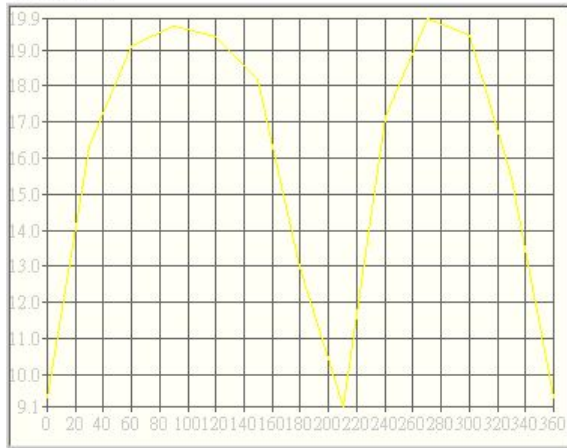

PCS Ch.
661@Theta 30.0
Vertical
Excel XY Plot

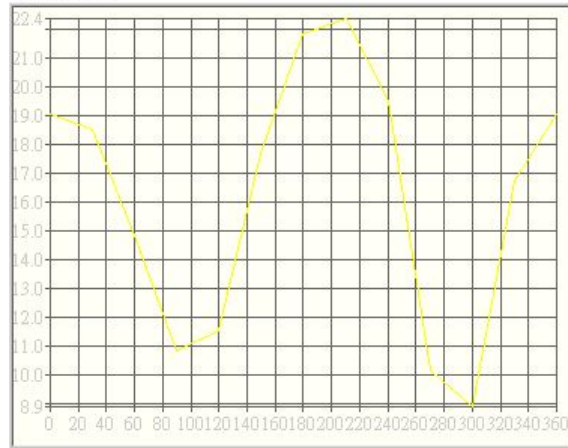

PCS Ch.
661@Theta 30.0
Total
Excel XY Plot



PCS Ch.
661@Theta 60.0
Horizontal
Excel XY Plot



PCS Ch.
661@Theta 60.0
Vertical
Excel XY Plot



PCS Ch.
661@Theta 60.0
Total
Excel XY Plot

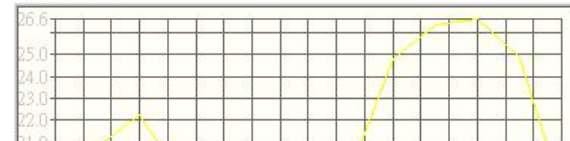



PCS Ch.
661@Theta 90.0
Horizontal
Excel XY Plot



PCS Ch.
661@Theta 90.0
Vertical
Excel XY Plot



PCS Ch.
661@Theta 90.0
Total
Excel XY Plot



PCS Ch.
661@Theta
120.0
Horizontal
Excel XY Plot

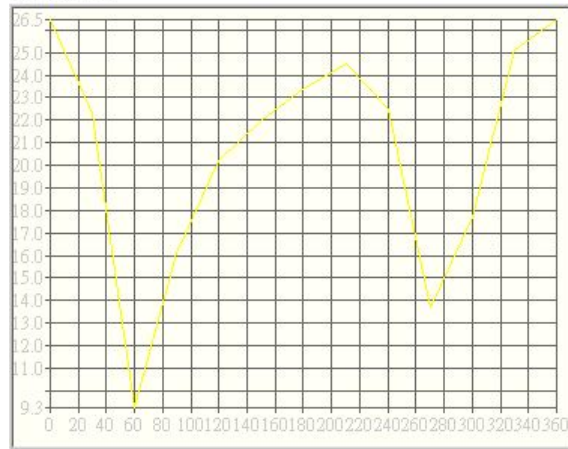

PCS Ch.
661@Theta
120.0
Vertical
Excel XY Plot

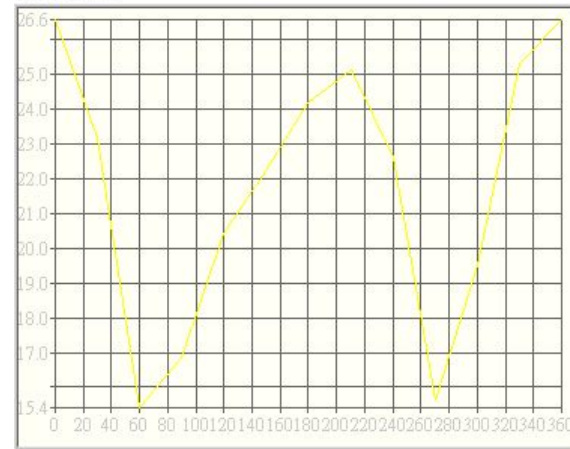

PCS Ch.
661@Theta
120.0
Total
Excel XY Plot

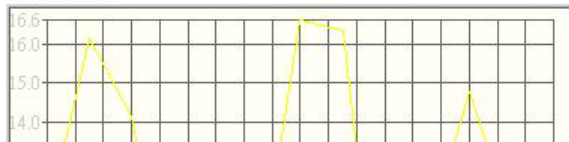



PCS Ch.
661@Theta
150.0
Horizontal
Excel XY Plot

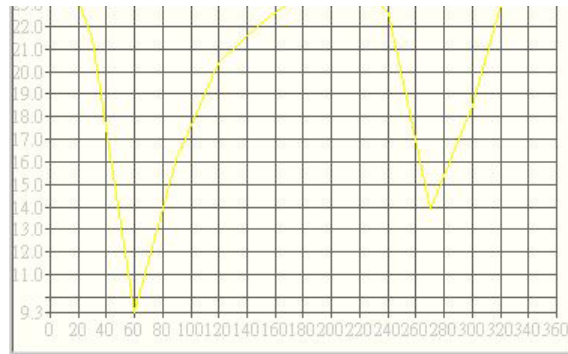

PCS Ch.
661@Theta
150.0
Vertical
Excel XY Plot



PCS Ch.
661@Theta
150.0
Total
Excel XY Plot

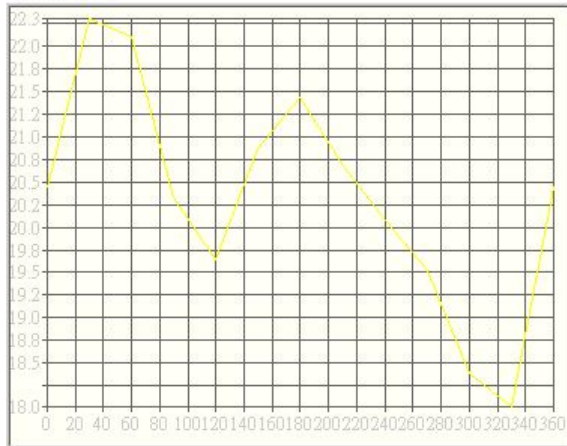

PCS Ch.
661@Theta 30.0
Horizontal
Excel XY Plot

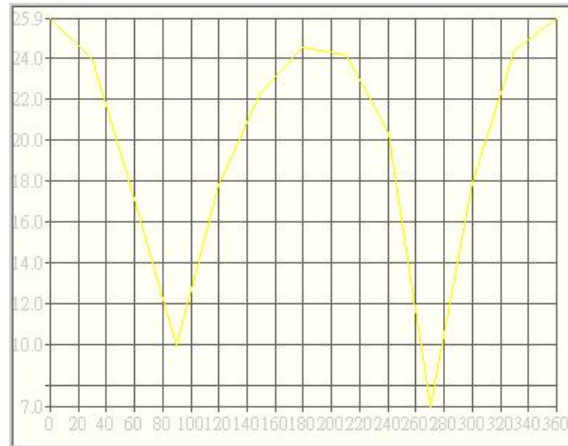

PCS Ch.
661@Theta 30.0
Vertical
Excel XY Plot

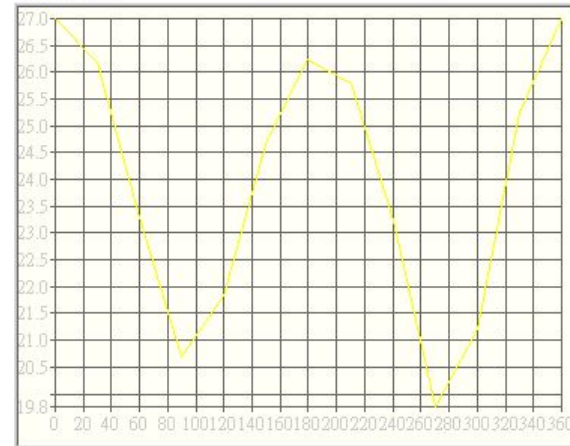

PCS Ch.
661@Theta 30.0
Total
Excel XY Plot

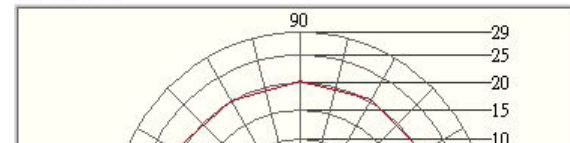
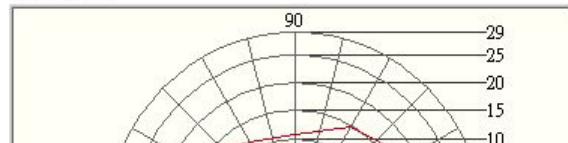
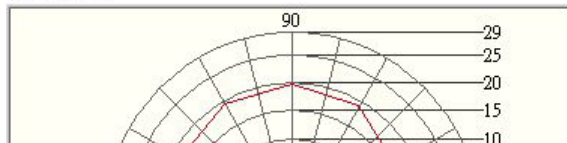

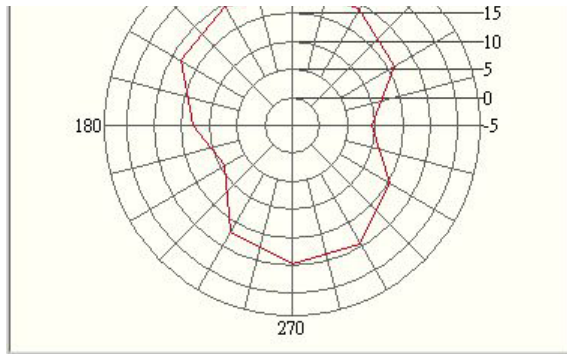

PCS Ch.
661@Theta 60.0
Horizontal
Excel XY Plot

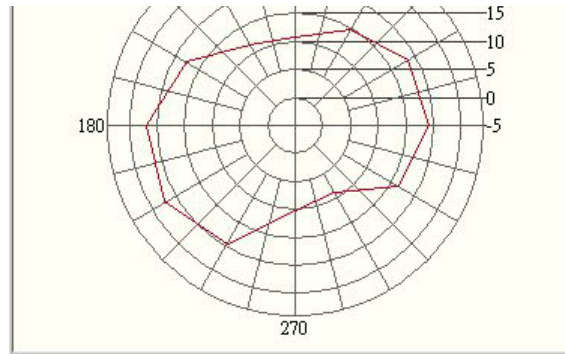

PCS Ch.
661@Theta 60.0
Vertical
Excel XY Plot

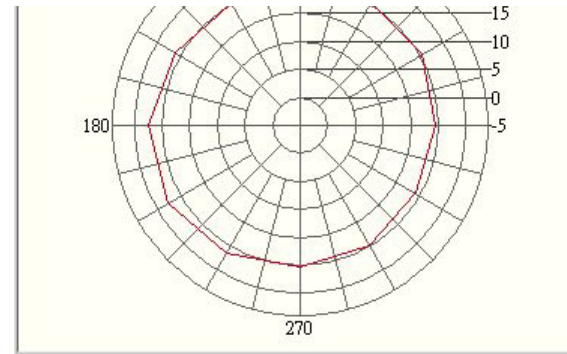

PCS Ch.
661@Theta 60.0
Total
Excel XY Plot

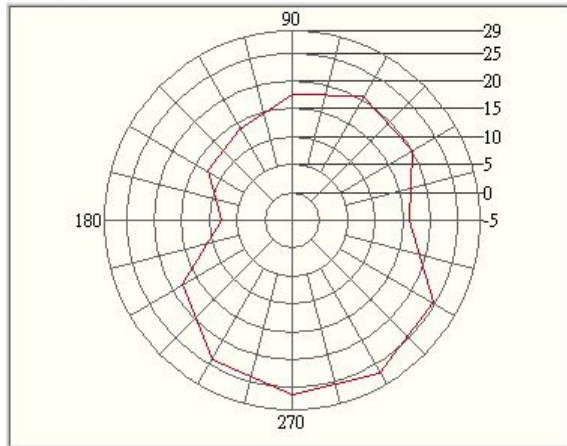

PCS Ch.
661@Theta 90.0
Horizontal
Excel XY Plot

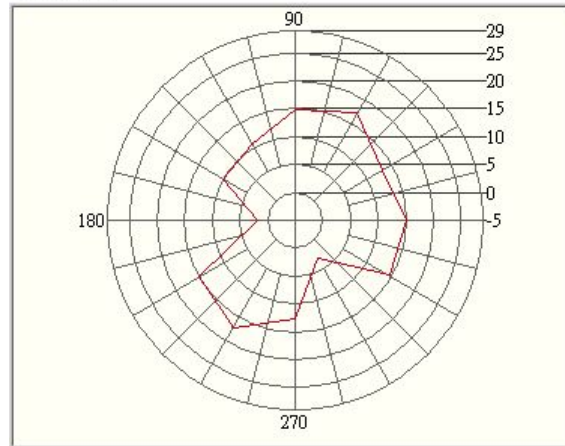

PCS Ch.
661@Theta 90.0
Vertical
Excel XY Plot

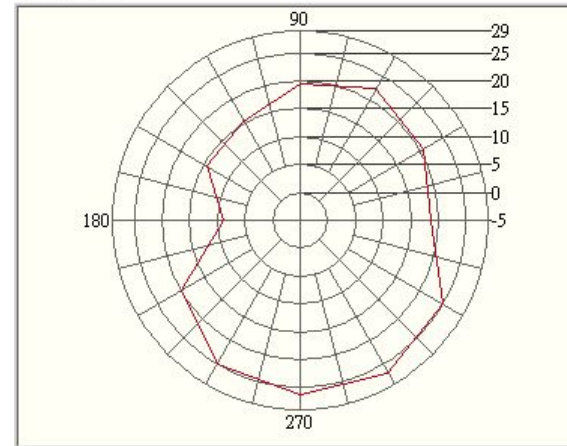

PCS Ch.
661@Theta 90.0
Total
Excel XY Plot

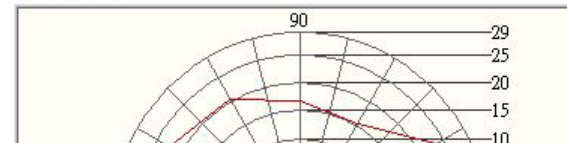
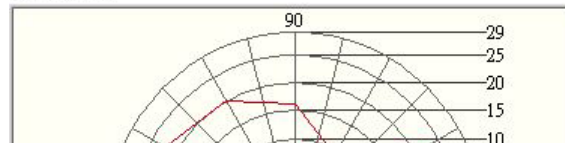
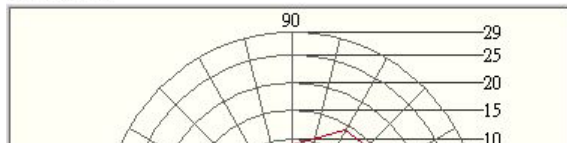

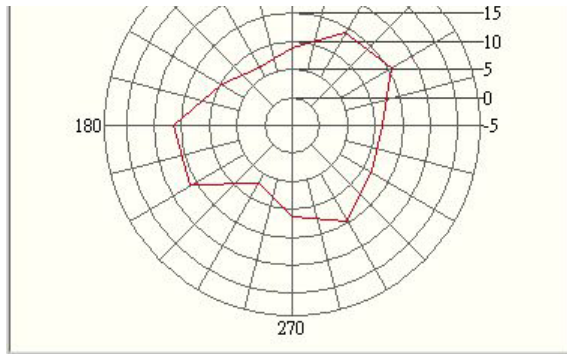

PCS Ch.
661@Theta
120.0
Worksheet1
Excel XY Plot

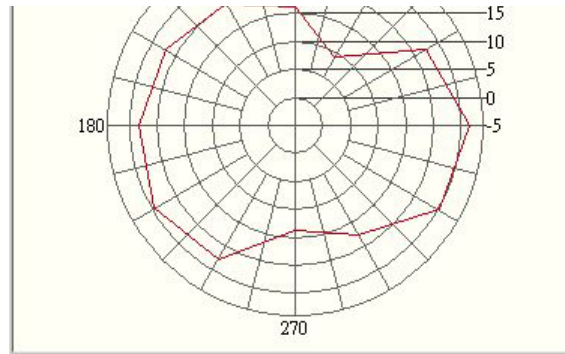

PCS Ch.
661@Theta
120.0
Worksheet1
Excel XY Plot

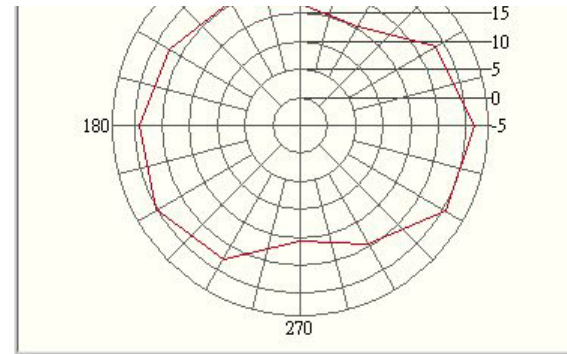

PCS Ch.
661@Theta
120.0
Worksheet1
Excel XY Plot

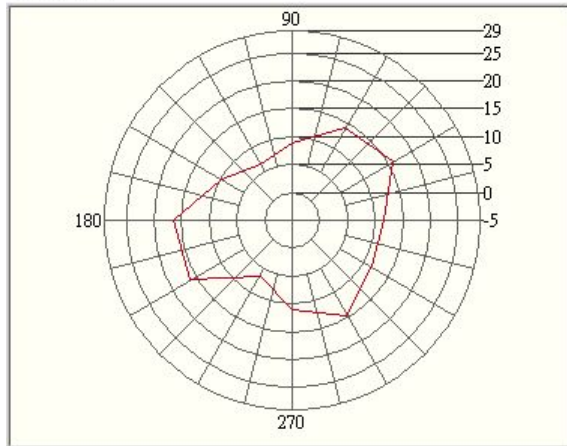

PCS Ch.
661@Theta
150.0
Worksheet1
Excel XY Plot

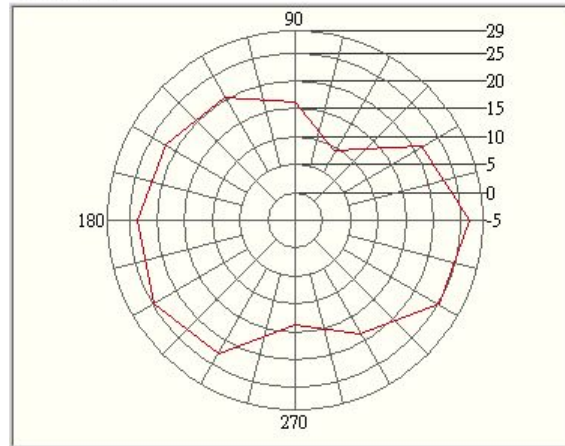

PCS Ch.
661@Theta
150.0
Worksheet1
Excel XY Plot

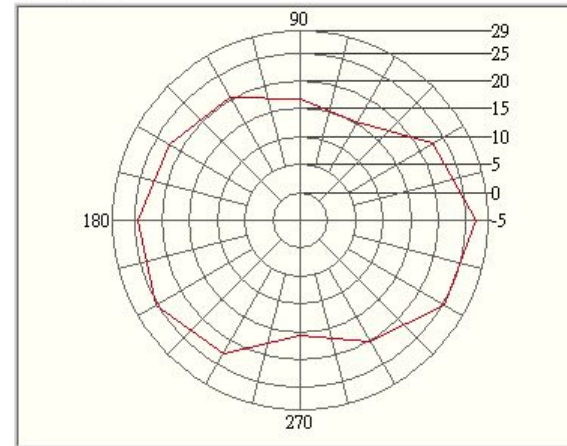

PCS Ch.
661@Theta
150.0
Worksheet1
Excel XY Plot

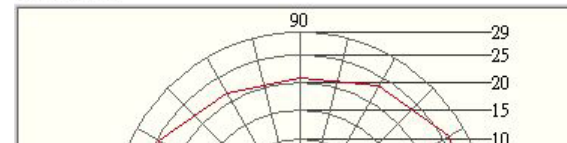
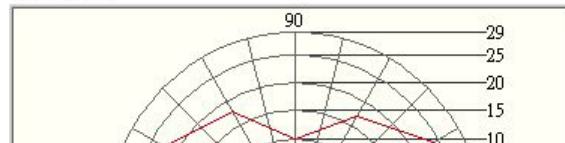
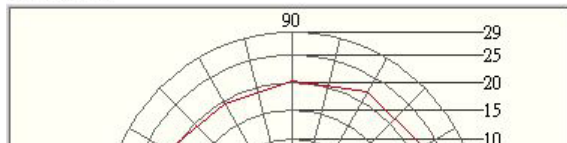

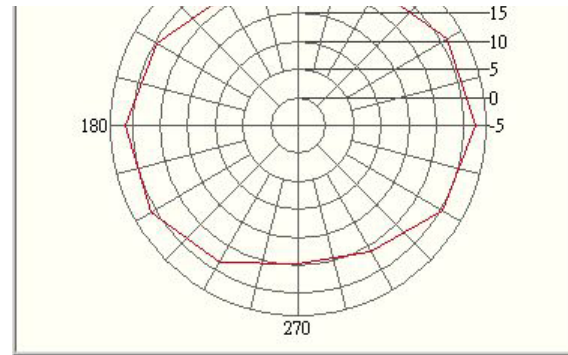
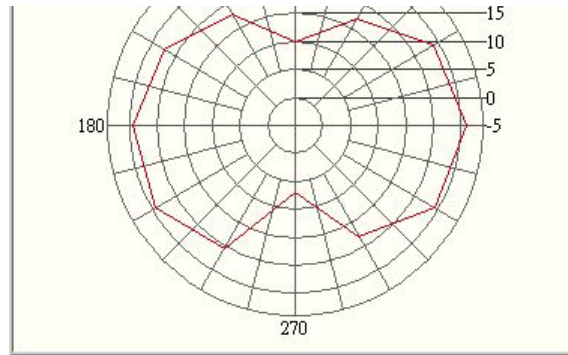
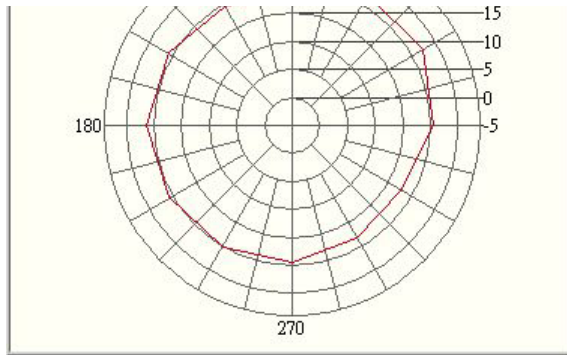

PCS Ch.
810

TRP		
Total Rad. Pow.	23.04	dBm
Ant. Port Inp. Pow	30	dBm
Peak EIRP	27.29	dBm
Directivity	4.25	dBi
Efficiency	-6.96	dB
Efficiency	20.14	%
Gain	-2.71	dBi
NHPRP +/-30	17.09	dBm
NHPRP +/-45	18.66	dBm

Maximum H Valu	26.69	dBm
Maximum H @ T	60	deg.
Maximum H @ P	300	deg.
Minimum H Valu	4.92	dBm
Minimum H @ T	60	deg.
Minimum H @ P	180	deg.
Maximum V Valu	26.67	dBm
Maximum V @ T	120	deg.
Maximum V @ P	0	deg.
Minimum V Valu	4.8	dBm
Minimum V @ T	60	deg.
Minimum V @ P	300	deg.
Maximum H+V V	27.29	dBm
Maximum H+V @	150	deg.
Maximum H+V @	0	deg.
Minimum H+V V	8.32	dBm
Minimum H+V @	60	deg.
Minimum H+V @	180	deg.

Test Data

Horizontal

	0	30	60	90	120	150	180	210	240	270	300	330
30	10.35	16.17	19.3	19.58	19.07	17.3	11.2	12.66	18.88	20.88	20.72	17.6
60	18.27	21.31	21.83	18.76	14.35	10.5	4.92	18.38	24.06	26.3	26.69	24.79
90	15.4	19.33	18.69	14.59	11.25	14.38	18.07	16.21	8.37	14.52	16.92	14.59
120	15.62	19.71	18.7	14.64	11.07	14.42	18.2	16.17	7.95	14.43	16.91	14.51
150	21.23	23.54	23.09	20.91	19.5	20.68	21.91	21.62	20.17	18.49	16.71	17.12

Vertical

	0	30	60	90	120	150	180	210	240	270	300	330
30	21.1	20.53	16.89	12.34	12.37	17.4	21.15	21.5	18.49	8	10.86	18.38
60	16.76	16.05	18.18	16.52	8.48	5.98	5.68	14.09	16.26	11.28	4.8	15.4
90	26.57	21.78	7.72	16.81	20.55	22.17	23.03	24.28	22.3	13.25	18.53	25.52
120	26.67	20.84	8.38	16.85	20.73	22.32	23.22	24.46	22.43	13.39	19.38	25.49
150	26.06	23.82	16.28	10.49	18.27	22.45	24.5	24.16	20.75	9.94	18.15	24.53

**Horizontal +
Vertical**

	0	30	60	90	120	150	180	210	240	270	300	330
30	21.45	21.89	21.27	20.33	19.91	20.36	21.57	22.03	21.7	21.1	21.15	21.02
60	20.59	22.44	23.39	20.8	15.35	11.81	8.32	19.76	24.73	26.44	26.72	25.26
90	26.89	23.74	19.02	18.85	21.04	22.84	24.23	24.91	22.47	16.94	20.81	25.86
120	27	23.32	19.09	18.89	21.17	22.97	24.41	25.06	22.58	16.95	21.32	25.83
150	27.29	26.69	23.92	21.29	21.94	24.67	26.4	26.08	23.48	19.06	20.5	25.25

PCS Ch. 810Up
View
3D Graph Excel

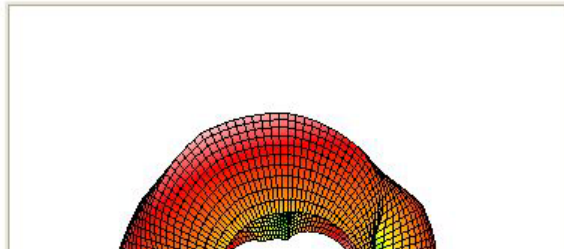

PCS Ch.
810Down View
3D Graph Excel

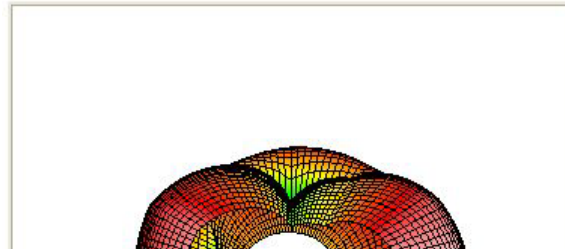

PCS Ch.
810Front View
3D Graph Excel

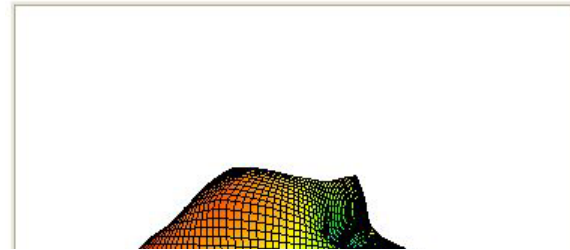

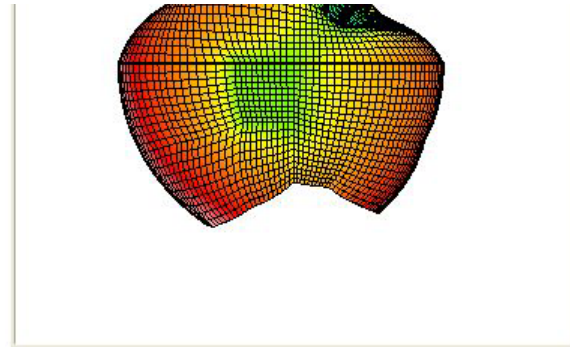
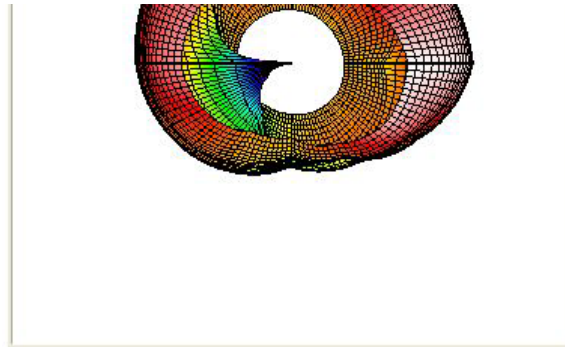
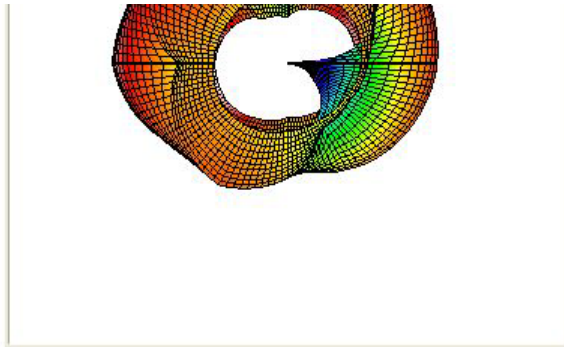

PCS Ch.
810@Theta 30.0
Horizontal
Excel XY Plot

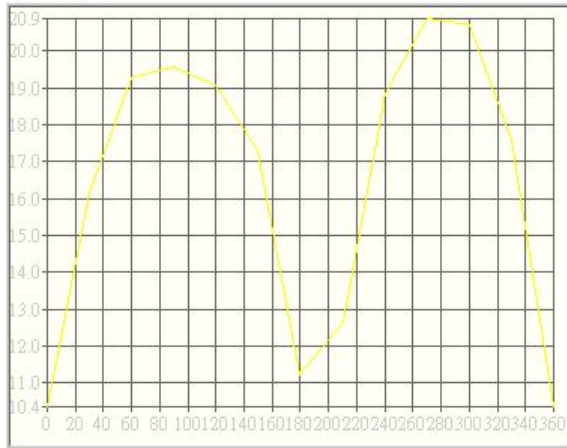

PCS Ch.
810@Theta 30.0
Vertical
Excel XY Plot

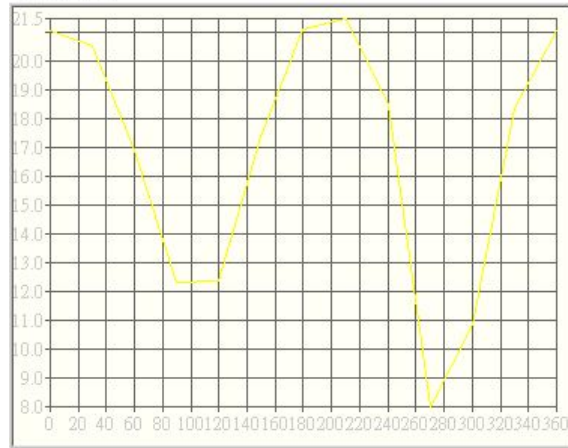

PCS Ch.
810@Theta 30.0
Total
Excel XY Plot



PCS Ch.
810@Theta 60.0
Horizontal
Excel XY Plot

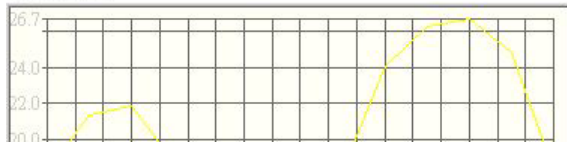

PCS Ch.
810@Theta 60.0
Vertical
Excel XY Plot



PCS Ch.
810@Theta 60.0
Total
Excel XY Plot





PCS Ch.
810@Theta 90.0
Horizontal
Excel XY Plot

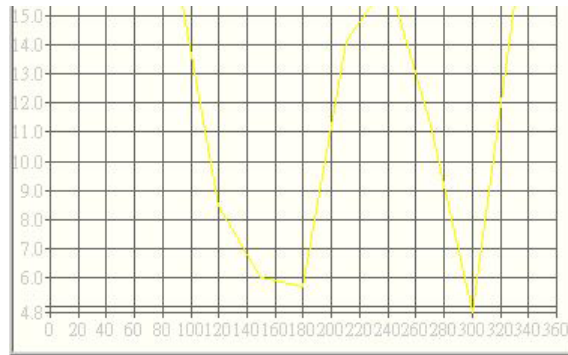

PCS Ch.
810@Theta 90.0
Vertical
Excel XY Plot



PCS Ch.
810@Theta 90.0
Total
Excel XY Plot

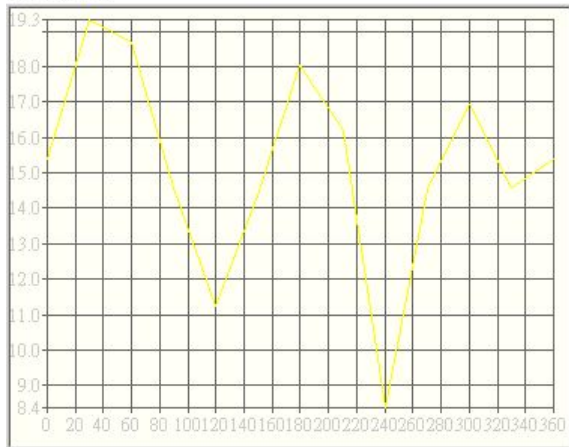

PCS Ch.
810@Theta
120.0
Horizontal
Excel XY Plot

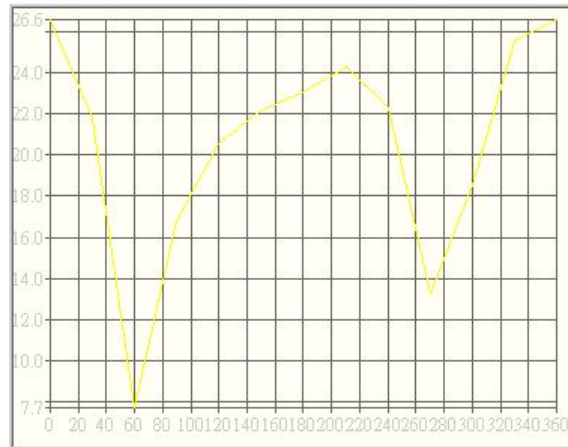

PCS Ch.
810@Theta
120.0
Vertical
Excel XY Plot



PCS Ch.
810@Theta
120.0
Total
Excel XY Plot

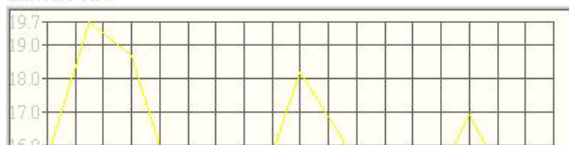



PCS Ch.
810@Theta
150.0
Horizontal
Excel XY Plot



PCS Ch.
810@Theta
150.0
Vertical
Excel XY Plot



PCS Ch.
810@Theta
150.0
Total
Excel XY Plot



PCS Ch.
810@Theta 30.0
Horizontal
Excel XY Plot

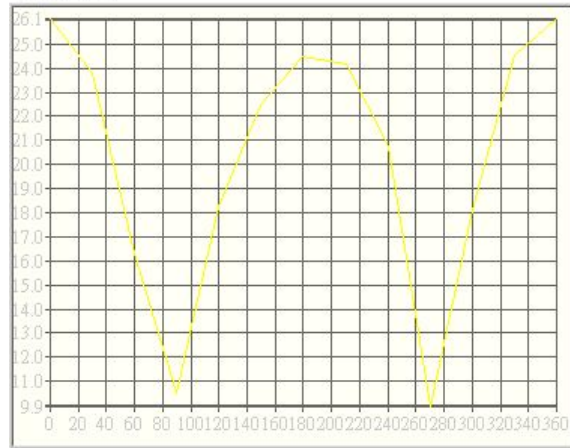

PCS Ch.
810@Theta 30.0
Vertical
Excel XY Plot

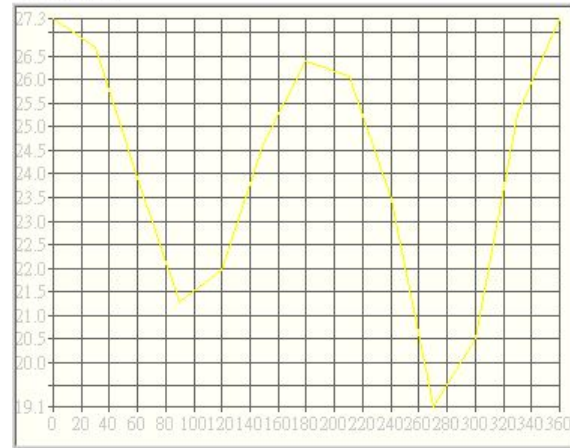

PCS Ch.
810@Theta 30.0
Total
Excel XY Plot

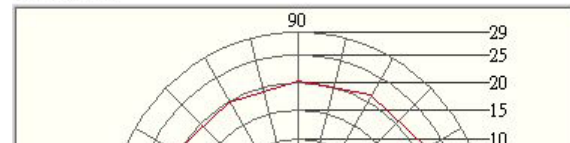
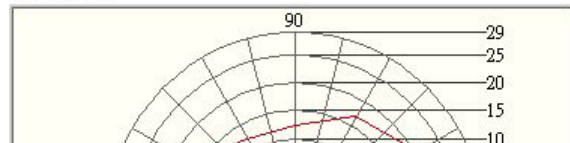
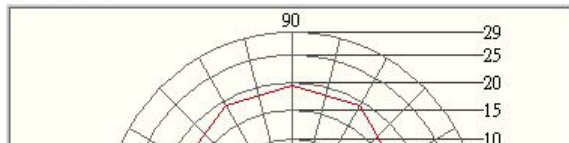

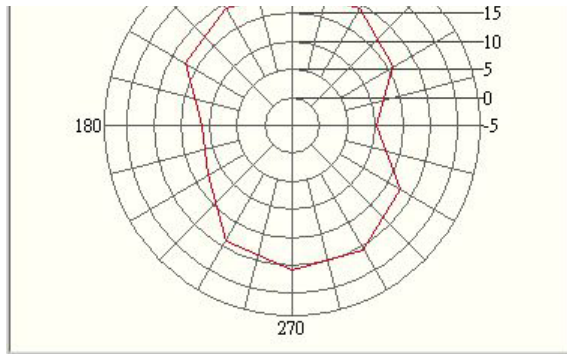

PCS Ch.
810@Theta 60.0
Horizontal
Excel XY Plot

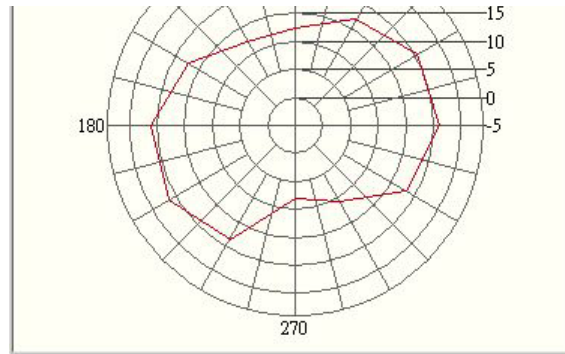

PCS Ch.
810@Theta 60.0
Vertical
Excel XY Plot

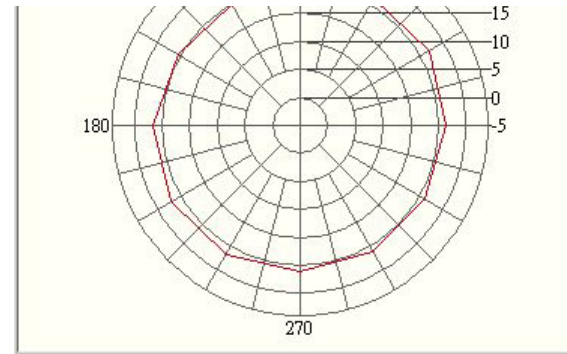

PCS Ch.
810@Theta 60.0
Total
Excel XY Plot

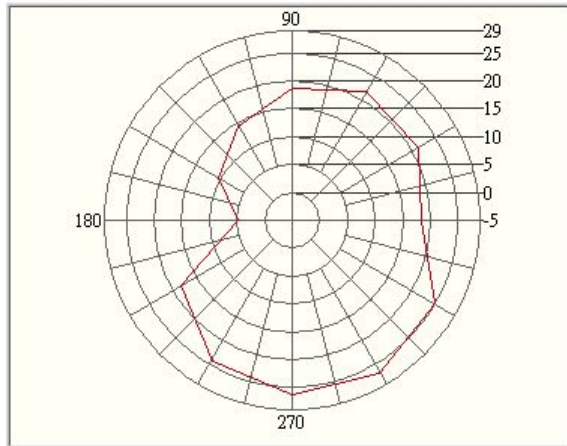

PCS Ch.
810@Theta 90.0
Horizontal
Excel XY Plot

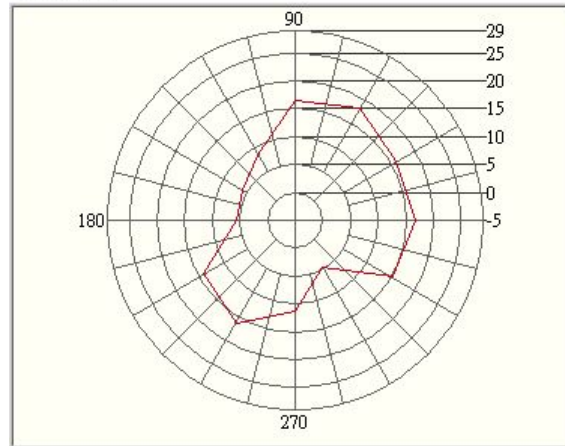

PCS Ch.
810@Theta 90.0
Vertical
Excel XY Plot

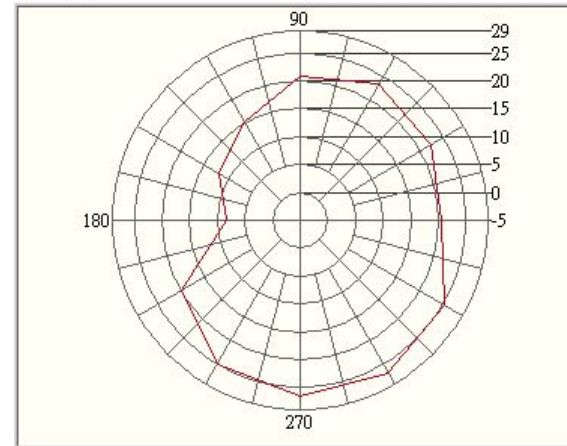

PCS Ch.
810@Theta 90.0
Total
Excel XY Plot

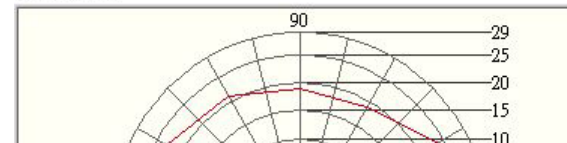
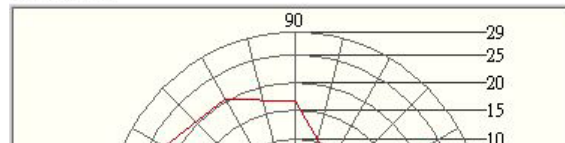
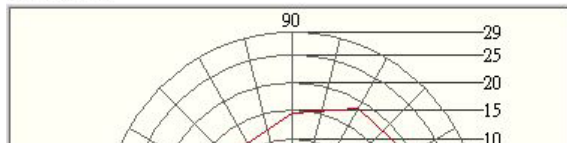

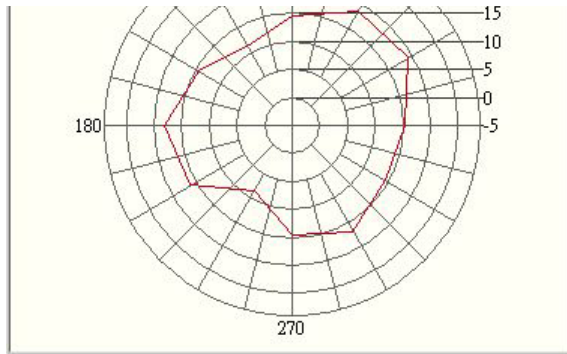

PCS Ch.
810@Theta
120.0
Worksheet1
Excel XY Plot

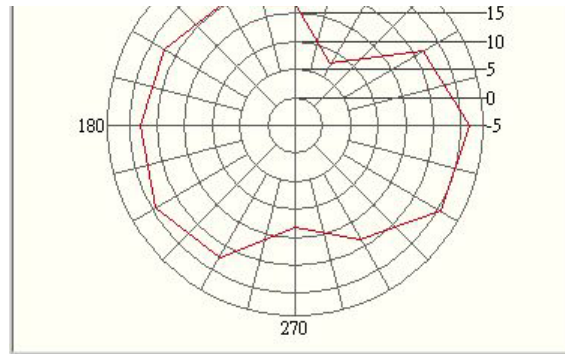

PCS Ch.
810@Theta
120.0
Worksheet1
Excel XY Plot

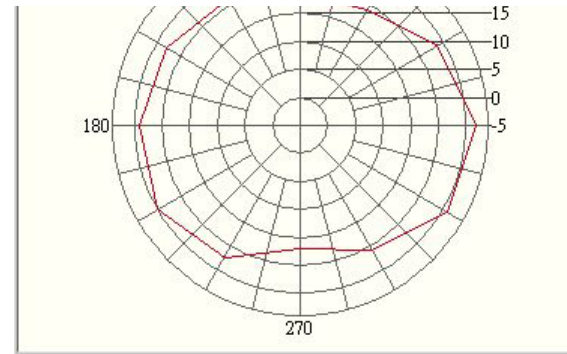

PCS Ch.
810@Theta
120.0
Worksheet1
Excel XY Plot

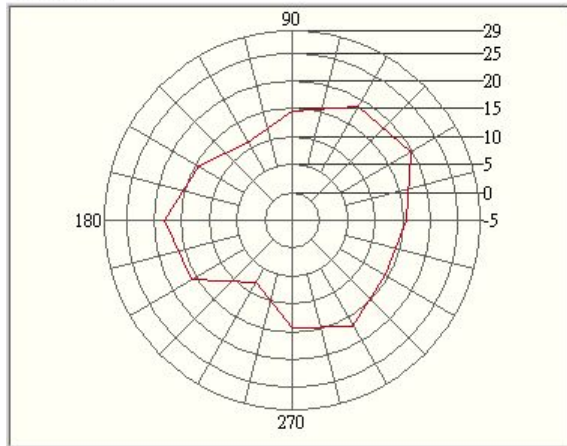

PCS Ch.
810@Theta
150.0
Worksheet1
Excel XY Plot

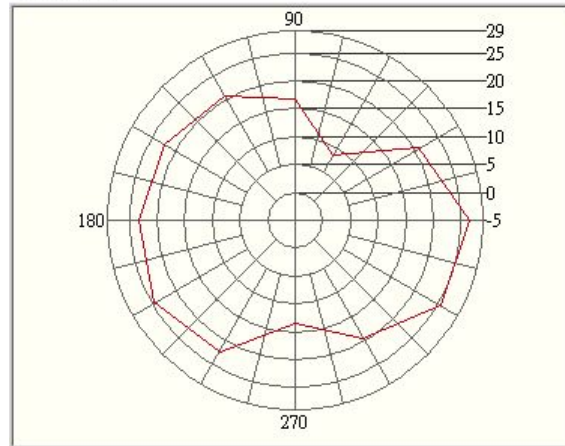

PCS Ch.
810@Theta
150.0
Worksheet1
Excel XY Plot

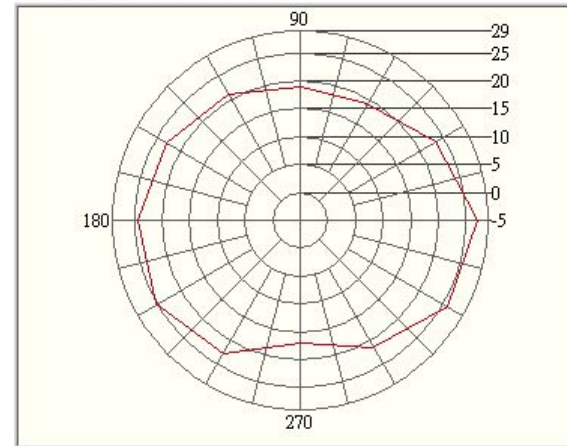

PCS Ch.
810@Theta
150.0
Worksheet1
Excel XY Plot

