



# Radio Test Report

## FCC ID: Q3N-3656

This report concerns (check one) :  Original Grant  Class II Change

Issued Date : Jul. 02, 2009

Project No. : R0906004

Equipment : BT Cradle

Model Name : 3656

Applicant : CIPHERLAB CO., LTD.

Address : 12F, 333, Dunhua S. Rd., Sec. 2, Taipei,  
Taiwan

**Tested by:**

Neutron Engineering Inc. EMC Laboratory

**Date of Test:**

Jun. 10, 2009 ~ Jun. 30, 2009

Testing Engineer: Rush Kao  
(Rush Kao)

Technical Manager: Jeff Yang  
(Jeff Yang)

Authorized Signatory: Andy Chiu  
(Andy Chiu)

**Neutron Engineering Inc.**

B1, No. 37, Lane 365, YangGuang St.

NeiHu District 114, Taipei, Taiwan.

TEL: +886-2-2657-3299

FAX: +886-2-2657-3331



R-2669 R-2829  
C-2918



### **Declaration**

**Neutron** represents to the client that testing is done in accordance with standard procedures as applicable and that test instruments used has been calibrated with the standards traceable to National Measurement Laboratory (NML) of R.O.C., or National Institute of Standards and Technology (NIST) of U.S.A.

**Neutron's** reports apply only to the specific samples tested under conditions. It is manufacture's responsibility to ensure that additional production units of this model are manufactured with the identical electrical and mechanical components. **Neutron** shall have no liability for any declarations, inferences or generalizations drawn by the client or others from **Neutron** issued reports.

**Neutron's** reports must not be used by the client to claim product endorsement by the authorities or any agency of the Government.

This report is the confidential property of the client. As a mutual protection to the clients, the public and **Neutron-self**, extracts from the test report shall not be reproduced except in full with **Neutron's** authorized written approval.

**Neutron's** laboratory quality assurance procedures are in compliance with the **ISO Guide 17025** requirements, and accredited by the conformity assessment authorities listed in this test report.

### **Limitation**

For the use of the authority's logo is limited unless the Test Standard(s)/Scope(s)/Item(s) mentioned in this test report is (are) included in the conformity assessment authorities acceptance respective.



<b>Table of Contents</b>	<b>Page</b>
<b>1 . CERTIFICATION</b>	<b>6</b>
<b>2 . SUMMARY OF TEST RESULTS</b>	<b>7</b>
2.1 TEST FACILITY	8
2.2 MEASUREMENT UNCERTAINTY	8
<b>3 . GENERAL INFORMATION</b>	<b>9</b>
3.1 GENERAL DESCRIPTION OF EUT	9
3.2 DESCRIPTION OF TEST MODES	11
3.3 TABLE OF PARAMETERS OF TEXT SOFTWARE SETTING	11
3.4 BLOCK DIAGRAM SHOWING THE CONFIGURATION OF SYSTEM TESTED	12
3.5 DESCRIPTION OF SUPPORT UNITS	13
<b>4 . EMC EMISSION TEST</b>	<b>14</b>
4.1 CONDUCTED EMISSION MEASUREMENT	14
4.1.1 POWER LINE CONDUCTED EMISSION	14
4.1.2 MEASUREMENT INSTRUMENTS LIST	14
4.1.3 TEST PROCEDURE	15
4.1.4 DEVIATION FROM TEST STANDARD	15
4.1.5 TEST SETUP	15
4.1.6 EUT OPERATING CONDITIONS	16
4.1.7 TEST RESULTS	17
4.2 RADIATED EMISSION MEASUREMENT	19
4.2.1 RADIATED EMISSION LIMITS	19
4.2.2 MEASUREMENT INSTRUMENTS LIST AND SETTING	20
4.2.3 TEST PROCEDURE	21
4.2.4 DEVIATION FROM TEST STANDARD	21
4.2.5 TEST SETUP	22
4.2.6 EUT OPERATING CONDITIONS	22
4.2.7 TEST RESULTS-BETWEEN 30MHZ – 1000MHZ	23
4.2.8 TEST RESULTS-ABOVE 1000MHZ	25
4.2.9 TEST RESULTS-RESTRICTED BANDS REQUIREMENTS	37
<b>5 . NUMBER OF HOPPING CHANNEL</b>	<b>41</b>
5.1 APPLIED PROCEDURES / LIMIT	41
5.1.1 MEASUREMENT INSTRUMENTS LIST AND SETTING	41
5.1.2 TEST PROCEDURE	41
5.1.3 DEVIATION FROM STANDARD	41
5.1.4 TEST SETUP	41
5.1.5 EUT OPERATION CONDITIONS	41



<b>Table of Contents</b>	<b>Page</b>
5.1.6 TEST RESULTS	42
<b>6 . AVERAGE TIME OF OCCUPANCY</b>	<b>43</b>
6.1 APPLIED PROCEDURES / LIMIT	43
6.1.1 MEASUREMENT INSTRUMENTS LIST	43
6.1.2 TEST PROCEDURE	43
6.1.3 DEVIATION FROM STANDARD	43
6.1.4 TEST SETUP	44
6.1.5 EUT OPERATION CONDITIONS	44
6.1.6 TEST RESULTS	45
<b>7 . HOPPING CHANNEL SEPARATION MEASUREMENT</b>	<b>51</b>
7.1 APPLIED PROCEDURES / LIMIT	51
7.1.1 MEASUREMENT INSTRUMENTS LIST AND SETTING	51
7.1.2 TEST PROCEDURE	51
7.1.3 DEVIATION FROM STANDARD	51
7.1.4 TEST SETUP	51
7.1.5 EUT OPERATION CONDITIONS	51
7.1.6 TEST RESULTS	52
<b>8 . BANDWITH TEST</b>	<b>54</b>
8.1 APPLIED PROCEDURES / LIMIT	54
8.1.1 MEASUREMENT INSTRUMENTS LIST AND SETTING	54
8.1.2 TEST PROCEDURE	54
8.1.3 DEVIATION FROM STANDARD	54
8.1.4 TEST SETUP	54
8.1.5 EUT OPERATION CONDITIONS	54
8.1.6 TEST RESULTS	55
<b>9 . PEAK OUTPUT POWER TEST</b>	<b>57</b>
9.1 APPLIED PROCEDURES / LIMIT	57
9.1.1 MEASUREMENT INSTRUMENTS LIST AND SETTING	57
9.1.2 TEST PROCEDURE	57
9.1.3 DEVIATION FROM STANDARD	57
9.1.4 TEST SETUP	57
9.1.5 EUT OPERATION CONDITIONS	57
9.1.6 TEST RESULTS	58
<b>10 . ANTENNA CONDUCTED SPURIOUS EMISSION</b>	<b>60</b>
10.1 APPLIED PROCEDURES / LIMIT	60
10.1.1 MEASUREMENT INSTRUMENTS LIST AND SETTING	60
10.1.2 TEST PROCEDURE	60
10.1.3 DEVIATION FROM STANDARD	60
10.1.4 TEST SETUP	61



<b>Table of Contents</b>	<b>Page</b>
10.1.5 EUT OPERATION CONDITIONS	61
10.1.6 TEST RESULTS	62
<b>11 . RF EXPOSURE TEST</b>	<b>64</b>
11.1 APPLIED PROCEDURES / LIMIT	64
11.1.1 MEASUREMENT INSTRUMENTS LIST	64
11.1.2 MPE CALCULATION METHOD	64
11.1.3 DEVIATION FROM STANDARD	65
11.1.4 TEST SETUP	65
11.1.5 EUT OPERATION CONDITIONS	65
11.1.6 TEST RESULTS	66
<b>12 . EUT TEST PHOTO</b>	<b>67</b>



## 1. CERTIFICATION

Equipment: BT Cradle  
Brand Name: CIPHERLAB  
Model Name: 3656  
Applicant: CIPHERLAB CO., LTD.  
Date of Test: Jun. 10, 2009 ~ Jun. 30, 2009  
Standards: FCC Part15, Subpart C / ANSI C63.4 : 2003

The above equipment has been tested and found compliance with the requirement of the relative standards by Neutron Engineering Inc. EMC Laboratory.

The test data, data evaluation, and equipment configuration contained in our test report (Ref No. NEI-FCCP-1-R0906004) were obtained utilizing the test procedures, test instruments, test sites that has been accredited by the Authority of NVLAP and TAF according to the ISO-17025 quality assessment standard and technical standard(s).



**2. SUMMARY OF TEST RESULTS**

Test procedures according to the technical standards:

<b>FCC Part15 (15.247) , Subpart C</b>			
<b>Standard Section</b>	<b>Test Item</b>	<b>Judgment</b>	<b>Remark</b>
15.207	Conducted Emission	PASS	
15.247 (c)	Antenna conducted Spurious Emission	PASS	
15.247 (a)(1)	Hopping Channel Separation	PASS	
15.247 (b)(1)	Peak Output Power	PASS	
15.247 (c)	Radiated Spurious Emission	PASS	
15.247 (b)(1)	Number of Hopping Frequency	PASS	
15.247 (a)(1)	Dwell Time	PASS	
15.205	Restricted Bands	PASS	
15.203	Antenna Requirement	PASS	
1.1307 1.1310 2.1091 2.1093	RF Exposure Compliance	PASS	

**NOTE:**

(1) "N/A" denotes test is not applicable in this Test Report.



**2.1 TEST FACILITY**

The test facilities used to collect the test data in this report is **C01/CB07(FCC R.N.: 95335)** at the location of No.132-1, Lane 329, Sec. 2, Palian Road, Shijr City, Taipei, Taiwan.

**2.2 MEASUREMENT UNCERTAINTY**

The reported uncertainty of measurement  $y \pm U$ , where expended uncertainty **U** is based on a standard uncertainty multiplied by a coverage factor of **k=2**, providing a level of confidence of approximately **95 %**.

A. Conducted Measurement :

Test Site	Method	Measurement Frequency Range	U , (dB)	NOTE
C01	ANSI	150 KHz ~ 30MHz	1.94	

B. Radiated Measurement :

Test Site	Method	Measurement Frequency Range	Ant. H / V	U , (dB)	NOTE
OS-01	ANSI	30MHz ~ 200MHz	V	2.86	
		30MHz ~ 200MHz	H	2.56	
		200MHz ~ 1,000MHz	V	2.88	
		200MHz ~ 1,000MHz	H	2.98	
OS-02	ANSI	30MHz ~ 200MHz	V	2.48	
		30MHz ~ 200MHz	H	2.16	
		200MHz ~ 1,000MHz	V	2.50	
		200MHz ~ 1,000MHz	H	2.66	





**3. GENERAL INFORMATION**

**3.1 GENERAL DESCRIPTION OF EUT**

Equipment	BT Cradle
Brand Name	CIPHERLAB
Model Name	3656
OEM Brand/Model Name	N/A
Model Difference	N/A
Product Description	The EUT is a BT Cradle.
	Operation Frequency: 2402~2480 MHz
	Modulation Type: FHSS(GFSK)
	Bit Rate of Transmitter 1Mbps
	Number Of Channel 79CH
	Antenna Designation: Please see Note 3.
	Antenna Gain(Peak) Please see Note 3.
	Output Power: 2.22 dBm (Max.)
Based on the application, features, or specification exhibited in User's Manual, the EUT is considered as an ITE/Computing Device. More details of EUT technical specification, please refer to the User's Manual.	
Channel List	Please refer to the Note 2.
Power Source	DC Voltage supplied from AC/DC ADAPTER.
Power Rating	I/P: AC 100-240V 50-60Hz 0.5A / O/P: DC 5V 2A
Connecting I/O Port(s)	Please refer to the User's Manual
Products Covered	AC/DC ADAPTER: GPSS-0500200

**Note:**

1. For a more detailed features description, please refer to the manufacturer's specifications or the User's Manual.



2.

Channel List					
Channel	Frequency (MHz)	Channel	Frequency (MHz)	Channel	Frequency (MHz)
00	2402	27	2429	54	2456
01	2403	28	2430	55	2457
02	2404	29	2431	56	2458
03	2405	30	2432	57	2459
04	2406	31	2433	58	2460
05	2407	32	2434	59	2461
06	2408	33	2435	60	2462
07	2409	34	2436	61	2463
08	2410	35	2437	62	2464
09	2411	36	2438	63	2465
10	2412	37	2439	64	2466
11	2413	38	2440	65	2467
12	2414	39	2441	66	2468
13	2415	40	2442	67	2469
14	2416	41	2443	68	2470
15	2417	42	2444	69	2471
16	2418	43	2445	70	2472
17	2419	44	2446	71	2473
18	2420	45	2447	72	2474
19	2421	46	2448	73	2475
20	2422	47	2449	74	2476
21	2423	48	2450	75	2477
22	2424	49	2451	76	2478
23	2425	50	2452	77	2479
24	2426	51	2453	78	2480
25	2427	52	2454		
26	2428	53	2455		

3. Table for Filed Antenna

Ant.	Brand	Model Name	Antenna Type	Connector	Gain (dBi)
1	ACX	AT9520-B2R4HA A	Chip	U.FL	3.0



**3.2 DESCRIPTION OF TEST MODES**

To investigate the maximum EMI emission characteristics generates from EUT, the test system was pre-scanning tested base on the consideration of following EUT operation mode or test configuration mode which possible have effect on EMI emission level. Each of these EUT operation mode(s) or test configuration mode(s) mentioned above was evaluated respectively.

Pretest Test Mode	Description
Mode 1	CH00
Mode 2	CH39
Mode 3	CH78

For Conducted Test	
Final Test Mode	Description
Mode 2	CH39

For Radiated Emission	
Final Test Mode	Description
Mode 1	CH00
Mode 2	CH39
Mode 3	CH78

Note:

- (1) The measurements are performed at the highest, middle, lowest available channels.
- (2) The EUT is considered a portable unit; it was pre-tested on the positioned of each 3 axis. The worst case was found positioned on Y-plane. Therefore only the test data of this Y-plane was used for radiated emission measurement test. Test data of Charge mode was used for conduction emission measurement test.

**3.3 TABLE OF PARAMETERS OF TEXT SOFTWARE SETTING**

During testing channel & power controlling software provided by the customer was used to control the operating channel as well as the output power level. The RF output power selection is for the setting of RF output power expected by the customer and is going to be fixed on the firmware of the final end product power parameters of FHSS

Test software Version	Terminal		
Frequency	2402 MHz	2441 MHz	2480 MHz
Power Parameters	N/A	N/A	N/A



**3.4 BLOCK DIAGRAM SHOWING THE CONFIGURATION OF SYSTEM TESTED**

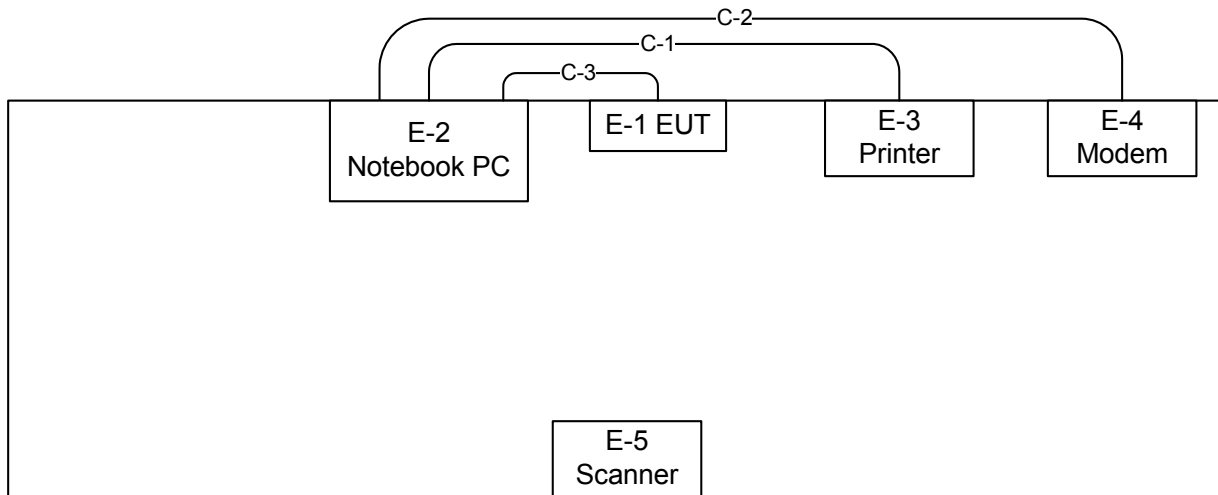

C-1 Parallel Cable  
C-2 RS-232 Cable  
C-3 USB Cable



**3.5 DESCRIPTION OF SUPPORT UNITS**

The EUT has been tested as an independent unit together with other necessary accessories or support units. The following support units or accessories were used to form a representative test configuration during the tests.

Item	Equipment	Mfr/Brand	Model/Type No.	FCC ID	Series No.	Note
E-1	BT Cradle	CIPHERLAB	3656	Q3N-3656	N/A	EUT
E-2	Notebook PC	DELL	D600	DOC	7T390 A03	
E-3	Printer	SII	DPU-414	DOC	1045105A	
E-4	Modem	ACEEX	DM-1414V	DOC	8041708	
E-5	BT BARCODE SCANNER	CIPHERLAB	1560	N/A	N/A	

Item	Shielded Type	Ferrite Core	Length	Note
C-1	YES	NO	1.7M	
C-2	YES	NO	1.8M	
C-3	YES	YES	1.2M	

Note:

- (1) The support equipment was authorized by Declaration of Confirmation.
- (2) For detachable type I/O cable should be specified the length in cm in 『Length』 column.



**4. EMC EMISSION TEST**

**4.1 CONDUCTED EMISSION MEASUREMENT**

**4.1.1 POWER LINE CONDUCTED EMISSION (Frequency Range 150KHz-30MHz)**

FREQUENCY (MHz)	Class A (dBuV)		Class B (dBuV)	
	Quasi-peak	Average	Quasi-peak	Average
0.15 -0.5	79.00	66.00	66 - 56 *	56 - 46 *
0.50 -5.0	73.00	60.00	56.00	46.00
5.0 -30.0	73.00	60.00	60.00	50.00

Note:

- (1) The tighter limit applies at the band edges.
- (2) The limit of " \* " marked band means the limitation decreases linearly with the logarithm of the frequency in the range.

**4.1.2 MEASUREMENT INSTRUMENTS LIST**

Item	Kind of Equipment	Manufacturer	Type No.	Serial No.	Calibrated until
1	Test Cable	N/A	SR03_C_01 &02	N/A	Aug. 19, 2009
2	LISN	EMCO	3816/2	00042991	Jan. 21, 2010
3	Pulse Limiter	Electro-Metrics	EM-7600	112647	Dec. 15, 2009
4	50Ω Terminator	N/A	N/A	N/A	May 25, 2011
5	EMI Test Receiver	R&S	ESCI	100082	Mar. 17, 2010
6	LISN	EMCO	4825/2	00028234	Jul. 09, 2009

Remark: " N/A" denotes No Model No. , Serial No. or No Calibration specified.

#### 4.1.3 TEST PROCEDURE

- The EUT was placed 0.8 meters from the horizontal ground plane with EUT being connected to the power mains through a line impedance stabilization network (LISN). All other support equipments powered from additional LISN(s). The LISN provide 50 Ohm/ 50uH of coupling impedance for the measuring instrument.
- Interconnecting cables that hang closer than 40 cm to the ground plane shall be folded back and forth in the center forming a bundle 30 to 40 cm long.
- I/O cables that are not connected to a peripheral shall be bundled in the center. The end of the cable may be terminated, if required, using the correct terminating impedance. The overall length shall not exceed 1 m.
- LISN at least 80 cm from nearest part of EUT chassis.
- For the actual test configuration, please refer to the related Item –EUT Test Photos.

#### 4.1.4 DEVIATION FROM TEST STANDARD

No deviation

#### 4.1.5 TEST SETUP

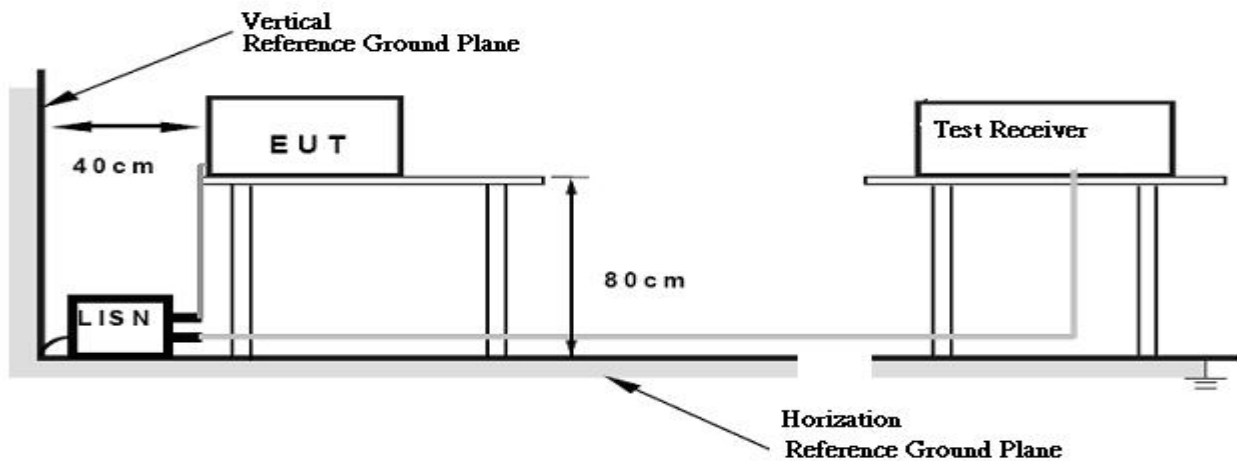



**4.1.6 EUT OPERATING CONDITIONS**

The EUT was configured for testing in a typical fashion (as a customer would normally use it). The EUT has been programmed to continuously transmit during test. This operating condition was tested and used to collect the included data.





**4.1.7 TEST RESULTS**

E.U.T :	BT Cradle	Model Name :	3656
Temperature :	28 °C	Relative Humidity :	49%
Test Voltage :	AC 120V/60Hz		
Test Mode :	CH39		

Freq. (MHz)	Terminal L/N	Measured(dBuV)		Limits(dBuV)		Margin (dB)	Note
		QP-Mode	AV-Mode	QP-Mode	AV-Mode		
0.16	Line	35.48	*	65.22	55.22	-29.74	(QP)
0.37	Line	39.85	*	58.49	48.49	-18.64	(QP)
0.74	Line	32.35	*	56.00	46.00	-23.65	(QP)
1.11	Line	32.70	*	56.00	46.00	-23.30	(QP)
14.35	Line	34.22	*	60.00	50.00	-25.78	(QP)
24.05	Line	34.99	*	60.00	50.00	-25.01	(QP)

**Remark**

- (1) Reading in which marked as QP means measurements by using are Quasi-Peak Mode with Detector BW=9KHz ; SPA setting in RBW=10KHz,VBW =10KHz, Swp. Time = 0.2 sec./MHz ◦ Reading in which marked as AV means measurements by using are Average Mode with instrument setting in RBW=10KHz,VBW=10KHz, Swp. Time =0.2 sec./MHz ◦
- (2) All readings are QP Mode value unless otherwise stated AVG in column of 『Note 』. If the QP Mode Measured value compliance with the QP Limits and lower than AVG Limits, the EUT shall be deemed to meet both QP & AVG Limits and then only QP Mode was measured, but AVG Mode didn't perform ◦ In this case, a “ \* ” marked in AVG Mode column of Interference Voltage Measured ◦
- (3) Measuring frequency range from 150KHz to 30MHz ◦

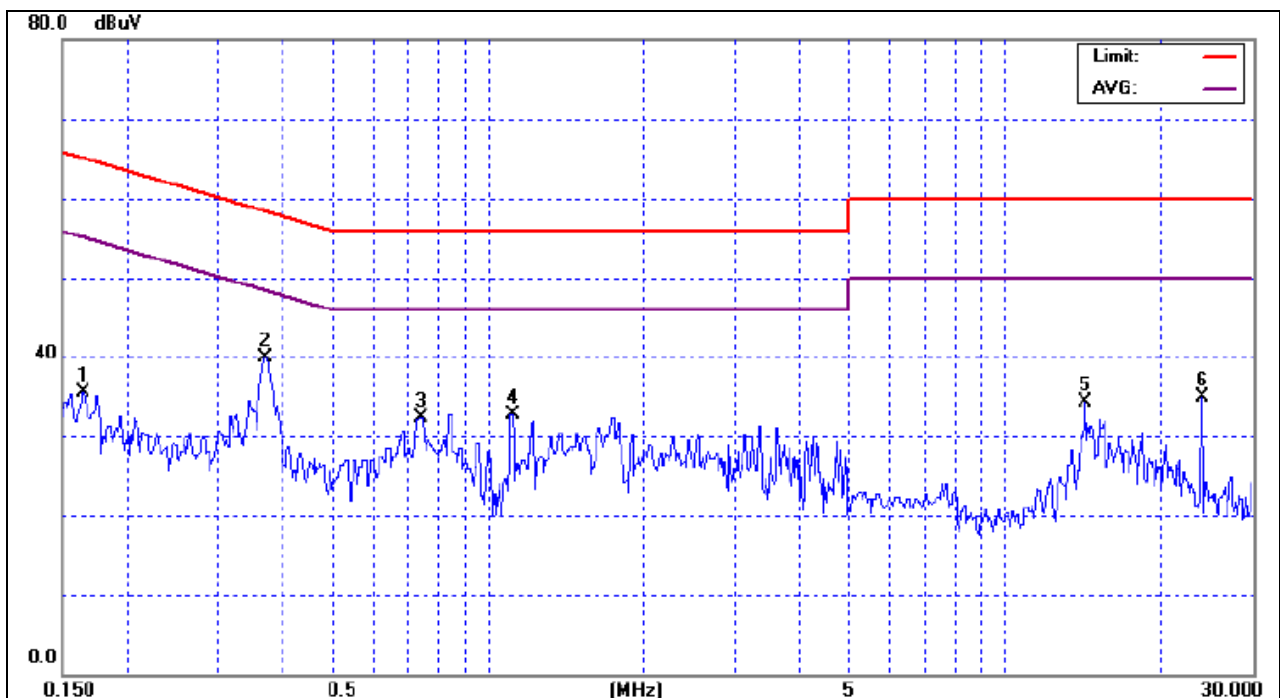



E.U.T :	BT Cradle	Model Name :	3656
Temperature :	28 °C	Relative Humidity :	49%
Test Voltage :	AC 120V/60Hz		
Test Mode :	CH39		

Freq. (MHz)	Terminal L/N	Measured(dBuV)		Limits(dBuV)		Margin (dB)	Note
		QP-Mode	AV-Mode	QP-Mode	AV-Mode		
0.15	Neutral	36.20	*	66.00	56.00	-29.80	(QP)
0.37	Neutral	36.68	*	58.55	48.55	-21.87	(QP)
0.48	Neutral	34.88	*	56.37	46.37	-21.49	(QP)
0.85	Neutral	30.64	*	56.00	46.00	-25.36	(QP)
12.25	Neutral	31.16	*	60.00	50.00	-28.84	(QP)
24.05	Neutral	27.86	*	60.00	50.00	-32.14	(QP)

**Remark**

- (1) Reading in which marked as QP means measurements by using are Quasi-Peak Mode with Detector BW=9KHz ; SPA setting in RBW=10KHz,VBW =10KHz, Swp. Time = 0.2 sec./MHz ◦ Reading in which marked as AV means measurements by using are Average Mode with instrument setting in RBW=10KHz,VBW=10KHz, Swp. Time =0.2 sec./MHz ◦
- (2) All readings are QP Mode value unless otherwise stated AVG in column of 'Note'. If the QP Mode Measured value compliance with the QP Limits and lower than AVG Limits, the EUT shall be deemed to meet both QP & AVG Limits and then only QP Mode was measured, but AVG Mode didn't perform ◦ In this case, a " \* " marked in AVG Mode column of Interference Voltage Measured ◦
- (3) Measuring frequency range from 150KHz to 30MHz ◦

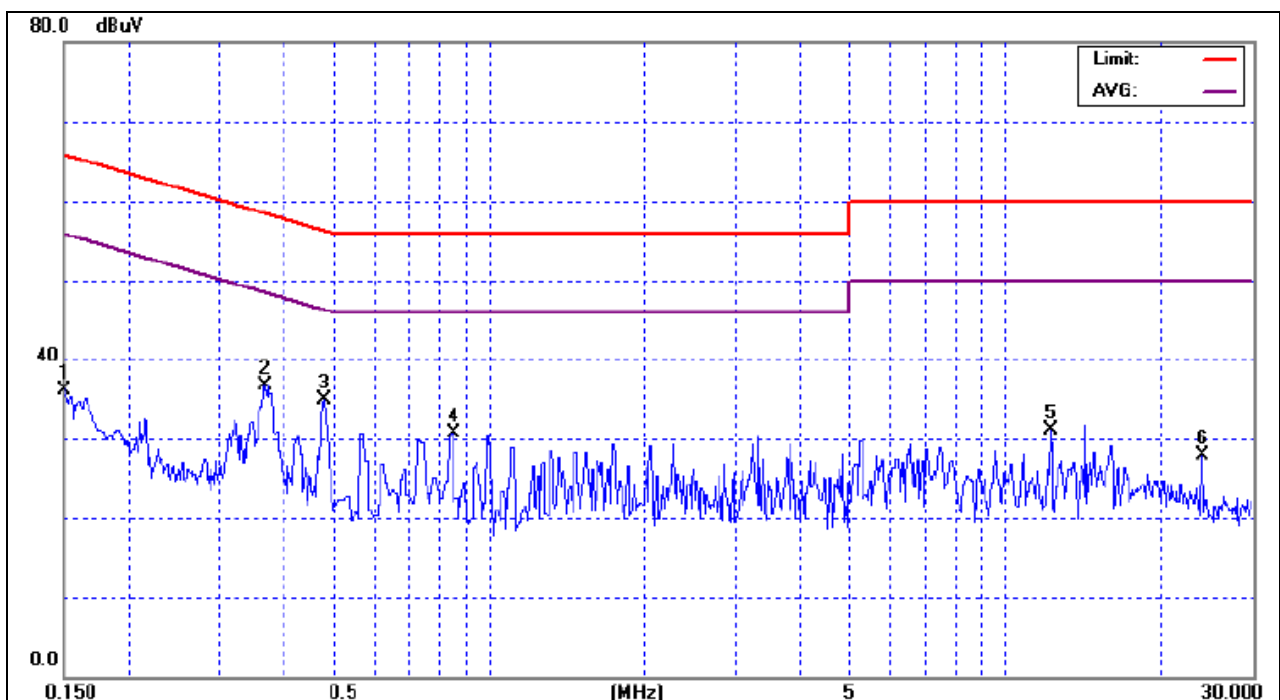



**4.2 RADIATED EMISSION MEASUREMENT**

**4.2.1 RADIATED EMISSION LIMITS (Frequency Range 9kHz-1000MHz)**

20dBc in any 100 kHz bandwidth outside the operating frequency band. In case the emission fall within the restricted band specified on 15.205(a), then the 15.209(a) limit in the table below has to be followed.

Frequencies (MHz)	Field Strength (micorvolts/meter)	Measurement Distance (meters)
0.009~0.490	2400/F(KHz)	300
0.490~1.705	24000/F(KHz)	30
1.705~30.0	30	30
30~88	100	3
88~216	150	3
216~960	200	3
Above 960	500	3

LIMITS OF RADIATED EMISSION MEASUREMENT (Above 1000MHz)

FREQUENCY (MHz)	Class A (dBuV/m) (at 3m)		Class B (dBuV/m) (at 3m)	
	PEAK	AVERAGE	PEAK	AVERAGE
Above 1000	80	60	74	54

Notes:

- (1) The limit for radiated test was performed according to FCC PART 15B.
- (2) The tighter limit applies at the band edges.
- (3) Emission level (dBuV/m)=20log Emission level (uV/m).



**4.2.2 MEASUREMENT INSTRUMENTS LIST AND SETTING**

Item	Kind of Equipment	Manufacturer	Type No.	Serial No.	Calibrated until
1	Log-Bicon Antenna	Schwarzbeck	VULB 9160	3176	Jul. 24, 2009
2	Test Cable	N/A	LMR-400	N/A	Jan. 05, 2010
3	Test Cable	N/A	3M_OS01	N/A	Oct. 08, 2009
4	Test Cable	N/A	OS01-1/-2	N/A	Oct. 08, 2009
5	RF Switch	Anritsu	MP59B	M65982	Aug. 25, 2009
6	Pre-Amplifier	Anritsu	MH648A	M09961	Dec. 29, 2009
7	Positioning Controller (OS01)	MF	MF7802	N/A	N/A
8	Turn Table	Chance Most	CMTB-1.5	N/A	N/A
9	Spectrum Analyzer	HP	8591EM	3536A00687	Mar. 13, 2010
10	EMI Measuring Receiver	SHCAFFNER	SCR 3501	408	Nov. 24, 2009
11	Spectrum Analyzer	R&S	FSP-40	100129	Sep. 09, 2010
12	Horn Antenna	Schwarzbeck	BBHA 9120 D	546	May 19, 2010
13	Microwave Pre-amplifier	Agilent	8449B	3008A02331	Jan. 19, 2010
14	Microflex Cable	NA	NA	1m	May. 20, 2010
15	Microflex Cable	NA	NA	10M	Mar. 04, 2010

Remark: " N/A" denotes No Model Name / Serial No. and No Calibration specified.

Spectrum Parameter	Setting
Attenuation	Auto
Start Frequency	1000 MHz
Stop Frequency	10th carrier harmonic
RB / VB (emission in restricted band)	1MHz / 1MHz for Peak, 1 MHz / 10Hz for Average
RB / VB (other emission)	100KHz / 100KHz for peak

Receiver Parameter	Setting
Attenuation	Auto
Start ~ Stop Frequency	9kHz~150kHz / RB 200Hz for QP
Start ~ Stop Frequency	150kHz~30MHz / RB 9kHz for QP
Start ~ Stop Frequency	30MHz~1000MHz / RB 120kHz for QP



#### **4.2.3 TEST PROCEDURE**

- a. The measuring distance of at 3 m shall be used for measurements at frequency up to 1GHz. For frequencies above 1GHz, any suitable measuring distance may be used.
- b. The EUT was placed on the top of a rotating table 0.8 meters above the ground at a 3 meter open area test site. The table was rotated 360 degrees to determine the position of the highest radiation.
- c. The height of the equipment or of the substitution antenna shall be 0.8 m; the height of the test antenna shall vary between 1 m to 4 m. Both horizontal and vertical polarizations of the antenna are set to make the measurement.
- d. The initial step in collecting conducted emission data is a spectrum analyzer peak detector mode pre-scanning the measurement frequency range. Significant peaks are then marked and then Quasi Peak detector mode re-measured.
- e. If the Peak Mode measured value compliance with and lower than Quasi Peak Mode Limit, the EUT shall be deemed to meet QP Limits and then no additional QP Mode measurement performed.
- f. For the actual test configuration, please refer to the related Item –EUT Test Photos.

#### **4.2.4 DEVIATION FROM TEST STANDARD**

No deviation

**4.2.5 TEST SETUP**

(A) Radiated Emission Test Set-Up, Frequency Below 1000MHz

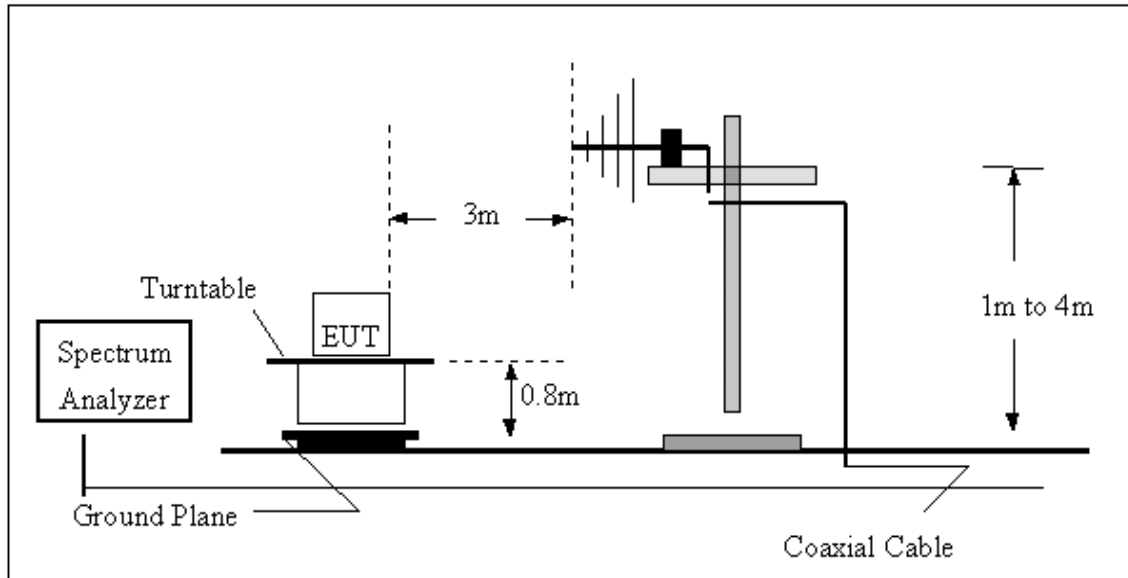

(B) Radiated Emission Test Set-Up Frequency Above 1 GHz

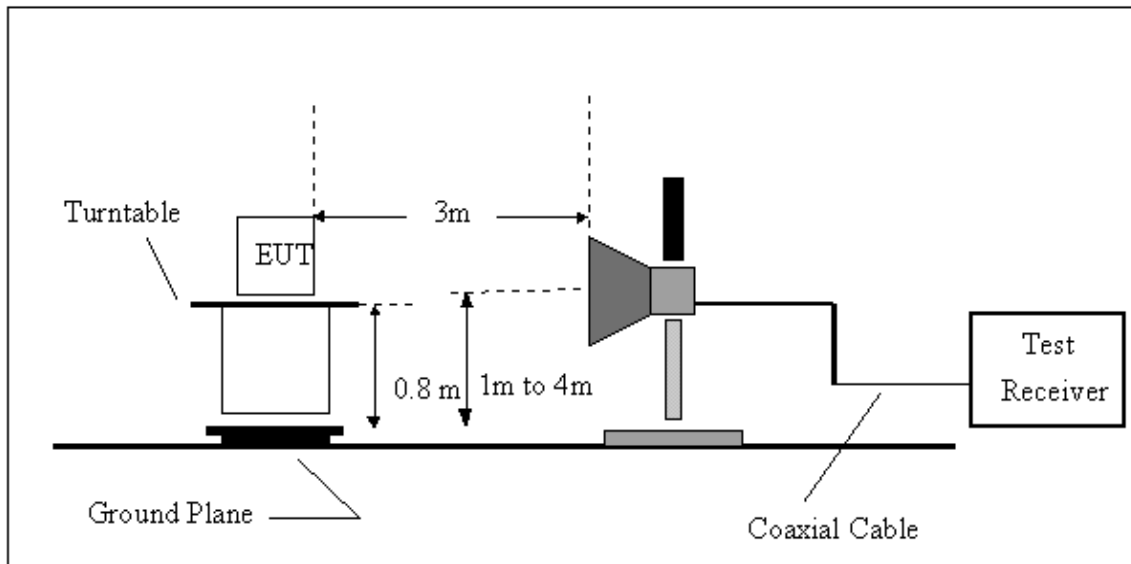

**4.2.6 EUT OPERATING CONDITIONS**

The EUT was configured for testing in a typical fashion (as a customer would normally use it). The EUT has been programmed to continuously transmit during test. This operating condition was tested and used to collect the included data.



**4.2.7 TEST RESULTS-BETWEEN 30MHZ – 1000MHZ**

EUT :	BT Cradle	Model Name :	3656
Temperature :	22 °C	Relative Humidity :	44%
Test Voltage :	AC 120V/60Hz	EUT Orthogonal Axis :	X
Test Mode :	CH39		

Freq. (MHz)	Ant. H/V	Reading(RA) (dBuV)	Corr.Factor(CF) (dB)	Measured(FS) (dBuV/m)	Limits(QP) (dBuV/m)	Margin (dB)	Note
45.52	V	56.10	-20.52	35.58	40.00	- 4.42	
336.52	V	52.21	-19.71	32.50	46.00	- 13.50	
365.62	V	53.21	-19.09	34.12	46.00	- 11.88	
499.48	V	52.58	-16.30	36.28	46.00	- 9.72	
528.58	V	51.62	-15.70	35.92	46.00	- 10.08	
567.38	V	49.15	-14.88	34.27	46.00	- 11.73	

**Remark :**

- (1) All readings are Peak unless otherwise stated QP in column of 『Note』 . Peak denotes that the Peak reading compliance with the QP Limits and then QP Mode measurement didn't perform ◦
- (2) EUT Orthogonal Axis :  
 "X" - denotes Laid on Table ; "Y" - denotes Vertical Stand ; "Z" - denotes Side Stand
- (3) Radiated emissions measured in frequency range from 30 MHz to 1000 MHz were made with an instrument using Peak detector mode or QP detector mode of the emission ◦
- (4) Data of measurement within this frequency range shown " - " in the table above means the reading of emissions are attenuated more than 20dB below the permissible limits or the field strength is too small to be measured.





EUT :	BT Cradle	Model Name :	3656
Temperature :	22 °C	Relative Humidity :	44%
Test Voltage :	AC 120V/60Hz	EUT Orthogonal Axis :	X
Test Mode :	CH39		

Freq. (MHz)	Ant. H/V	Reading(RA) (dBuV)	Corr.Factor(CF) (dB)	Measured(FS) (dBuV/m)	Limits(QP) (dBuV/m)	Margin (dB)	Note
144.46	H	51.45	-20.06	31.39	43.50	- 12.11	(QP)
239.52	H	58.45	-22.22	36.23	46.00	- 9.77	(QP)
299.66	H	57.22	-20.51	36.71	46.00	- 9.29	(QP)
336.52	H	62.22	-19.71	42.51	46.00	- 3.49	(QP)
499.48	H	53.50	-16.30	37.20	46.00	- 8.80	(QP)
528.58	H	50.38	-15.70	34.68	46.00	- 11.32	(QP)

**Remark :**

- (1) All readings are Peak unless otherwise stated QP in column of 『Note』 . Peak denotes that the Peak reading compliance with the QP Limits and then QP Mode measurement didn't perform ◦
- (2) EUT Orthogonal Axis :  
 "X" - denotes Laid on Table ; "Y" - denotes Vertical Stand ; "Z" - denotes Side Stand
- (3) Radiated emissions measured in frequency range from 30 MHz to 1000 MHz were made with an instrument using Peak detector mode or QP detector mode of the emission ◦
- (4) Data of measurement within this frequency range shown " - " in the table above means the reading of emissions are attenuated more than 20dB below the permissible limits or the field strength is too small to be measured.

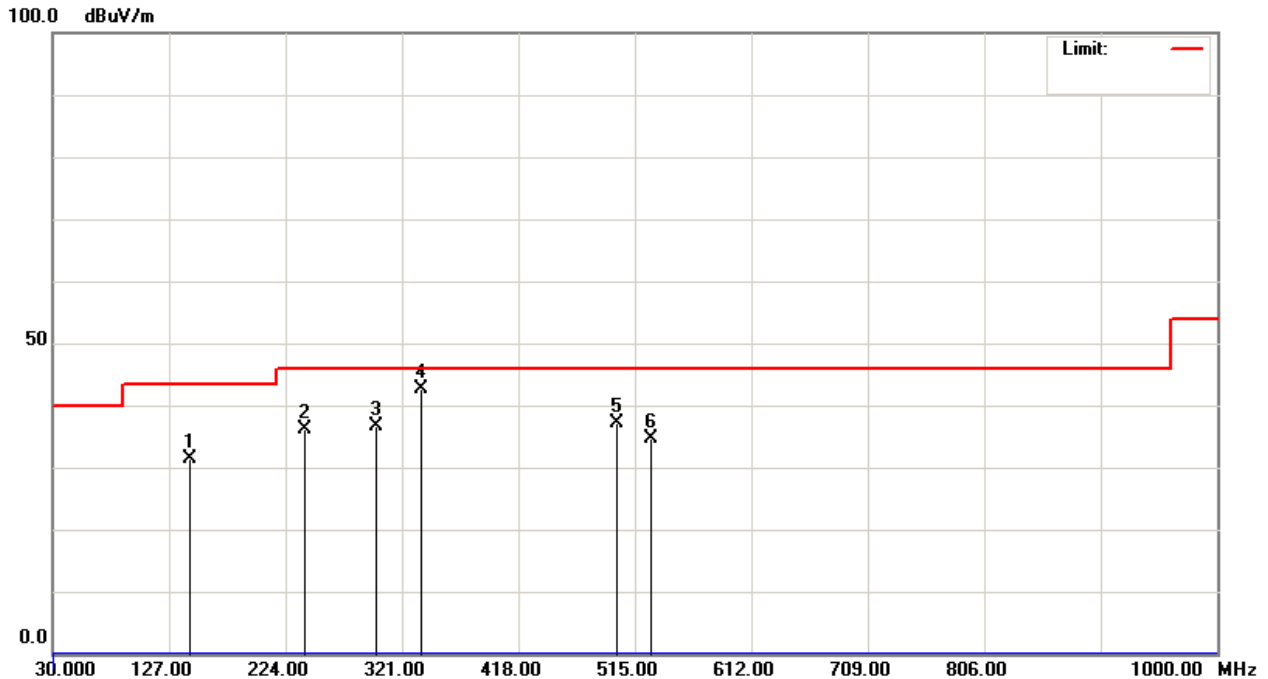





**4.2.8 TEST RESULTS-ABOVE 1000MHZ**

EUT :	BT Cradle	Model Name :	3656
Temperature :	22 °C	Relative Humidity :	44%
Test Voltage :	AC 120V/60Hz	EUT Orthogonal Axis :	X
Test Mode :	CH00		

Freq. (MHz)	Ant.Pol. H/V	Reading		Ant./CF CF(dB)	Act.		Limit		Note
		Peak (dBuV)	AV (dBuV)		Peak (dBuV/m)	AV (dBuV/m)	Peak (dBuV/m)	AV (dBuV/m)	
2390.00	V	21.57	11.73	32.38	53.95	44.11	74.00	54.00	Y/E
2402.00	V	64.52	52.68	32.43	96.95	85.11			Y/F
4803.80	V	45.18	41.36	4.39	49.57	45.75	74.00	54.00	Y/H

**Remark :**

- (1) All readings are Peak unless otherwise stated QP in column of 『Note』 . Peak denotes that the Peak reading compliance with the QP Limits and then QP Mode measurement didn't perform ◦
- (2) Measuring frequency range from 30MHz to 1000MHz or the 10th harmonic of highest fundamental frequency ◦“F” denotes fundamental frequency; “H” denotes spurious frequency. “E” denotes band edge frequency. (This judgment method includes the Band Edge Requirement.)
- (3) Radiated emissions measured in frequency range above 1000MHz were made with an instrument using Peak detector mode and AV detector mode of the emission ◦
- (4) Data of measurement within this frequency range shown “ \* ” in the table above means the reading of emissions are attenuated more than 20dB below the permissible limits or the field strength is too small to be measured.
- (5) A preamp and high pass filter were used for this test in order to provide sufficient measurement sensitivity.
- (6) EUT Orthogonal Axis :  
“X” - denotes Laid on Table ; “Y” - denotes Vertical Stand ; “Z” - denotes Side Stand
- (7) During the measurements above 1 GHz it is taken care of that the EUT is always within the 3 dB cone of radiation BW of the used antenna



Orthogonal Axis : X  
CH00(Above 1000 MHz, Vertical)

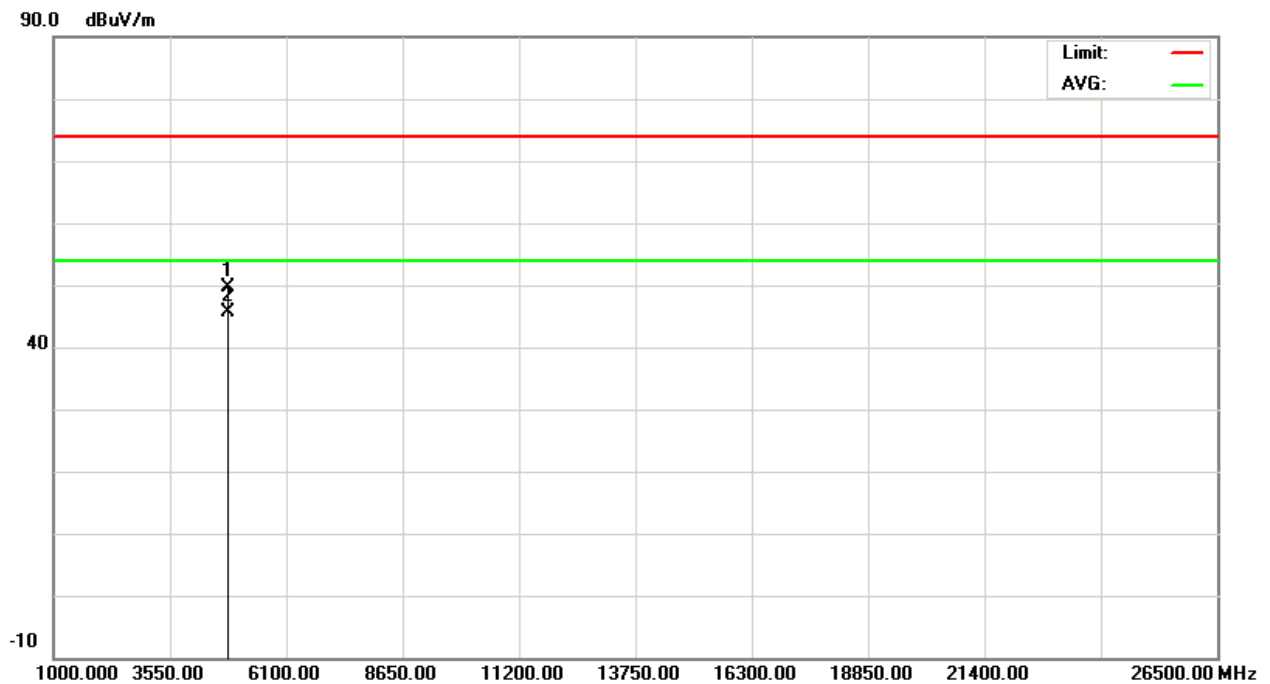
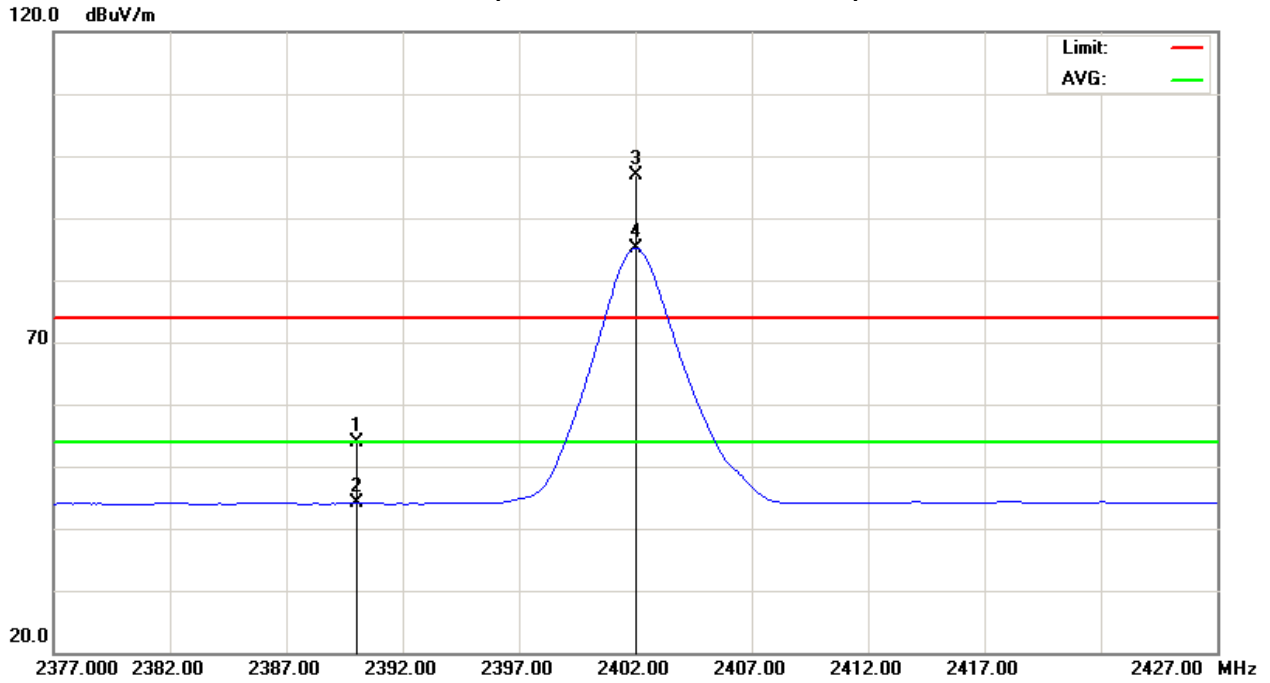



EUT :	BT Cradle	Model Name :	3656
Temperature :	22 °C	Relative Humidity :	44%
Test Voltage :	AC 120V/60Hz	EUT Orthogonal Axis :	X
Test Mode :	CH00		

Freq. (MHz)	Ant. Pol. H/V	Reading		Ant./CF CF(dB)	Act.		Limit		Note
		Peak (dBuV)	AV (dBuV)		Peak (dBuV/m)	AV (dBuV/m)	Peak (dBuV/m)	AV (dBuV/m)	
2390.00	H	21.28	11.77	32.38	53.66	44.15	74.00	54.00	Y/E
2402.00	H	64.19	52.71	32.43	96.62	85.14			Y/F
4803.96	H	38.52	34.69	4.39	42.91	39.08	74.00	54.00	Y/H

**Remark :**

- (1) All readings are Peak unless otherwise stated QP in column of 『Note』 . Peak denotes that the Peak reading compliance with the QP Limits and then QP Mode measurement didn't perform ◦
- (2) Measuring frequency range from 30MHz to 1000MHz or the 10th harmonic of highest fundamental frequency ◦ "F" denotes fundamental frequency; "H" denotes spurious frequency. "E" denotes band edge frequency. (This judgment method includes the Band Edge Requirement.)
- (3) Radiated emissions measured in frequency range above 1000MHz were made with an instrument using Peak detector mode and AV detector mode of the emission ◦
- (4) Data of measurement within this frequency range shown " \* " in the table above means the reading of emissions are attenuated more than 20dB below the permissible limits or the field strength is too small to be measured.
- (5) A preamp and high pass filter were used for this test in order to provide sufficient measurement sensitivity.
- (6) EUT Orthogonal Axis :  
"X" - denotes Laid on Table ; "Y" - denotes Vertical Stand ; "Z" - denotes Side Stand
- (7) During the measurements above 1 GHz it is taken care of that the EUT is always within the 3 dB cone of radiation BW of the used antenna



Orthogonal Axis : X  
CH00(Above 1000 MHz, Horizontal)

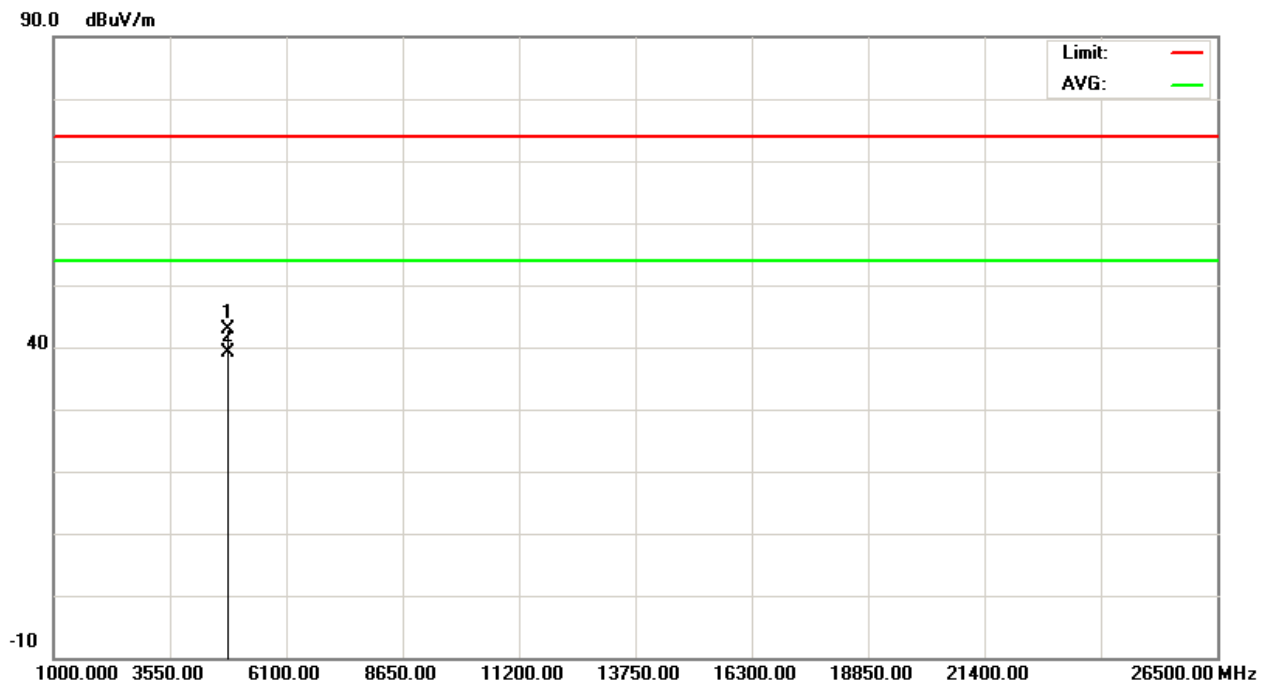
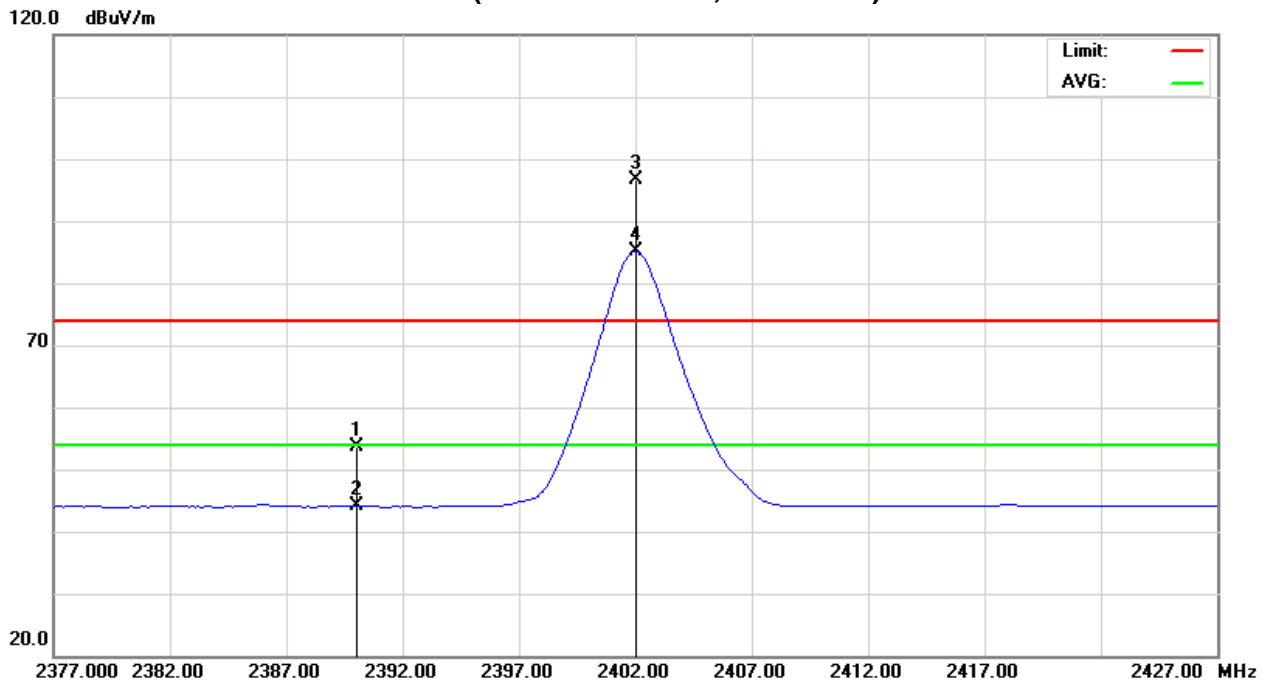



EUT :	BT Cradle	Model Name :	3656
Temperature :	22 ° C	Relative Humidity :	44%
Test Voltage :	AC 120V/60Hz	EUT Orthogonal Axis :	X
Test Mode :	CH39		

Freq. (MHz)	Ant.Pol. H/V	Reading		Ant./CF CF(dB)	Act.		Limit		Note
		Peak (dBuV)	AV (dBuV)		Peak (dBuV/m)	AV (dBuV/m)	Peak (dBuV/m)	AV (dBuV/m)	
2441.00	V	64.80	53.22	32.58	97.38	85.80			Y/F
4881.94	V	47.78	41.00	4.59	52.37	45.59	74.00	54.00	Y/H

Remark :

- (1) All readings are Peak unless otherwise stated QP in column of 『Note』 . Peak denotes that the Peak reading compliance with the QP Limits and then QP Mode measurement didn't perform ◦
- (2) Measuring frequency range from 30MHz to 1000MHz or the 10th harmonic of highest fundamental frequency ◦ "F" denotes fundamental frequency; "H" denotes spurious frequency. "E" denotes band edge frequency. (This judgment method includes the Band Edge Requirement.)
- (3) Radiated emissions measured in frequency range above 1000MHz were made with an instrument using Peak detector mode and AV detector mode of the emission ◦
- (4) Data of measurement within this frequency range shown " \* " in the table above means the reading of emissions are attenuated more than 20dB below the permissible limits or the field strength is too small to be measured.
- (5) A preamp and high pass filter were used for this test in order to provide sufficient measurement sensitivity.
- (6) EUT Orthogonal Axis :  
"X" - denotes Laid on Table ; "Y" - denotes Vertical Stand ; "Z" - denotes Side Stand
- (7) During the measurements above 1 GHz it is taken care of that the EUT is always within the 3 dB cone of radiation BW of the used antenna



Orthogonal Axis : X  
CH39 (Above 1000 MHz, Vertical)

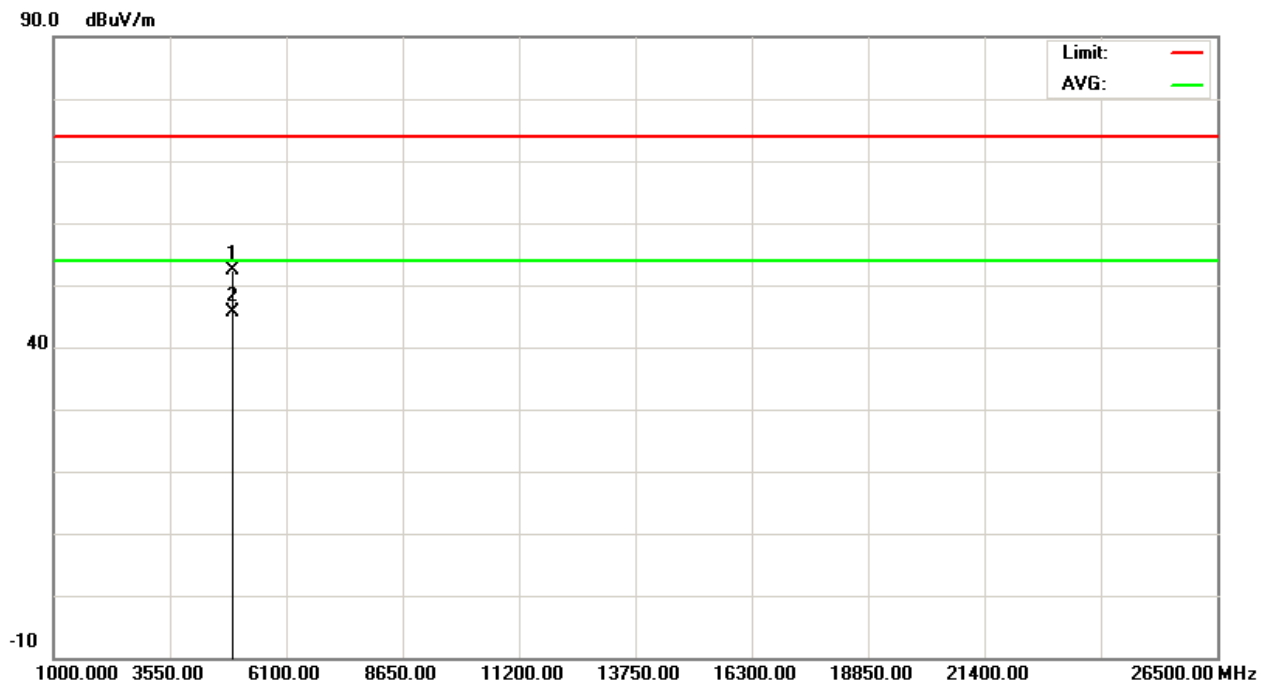
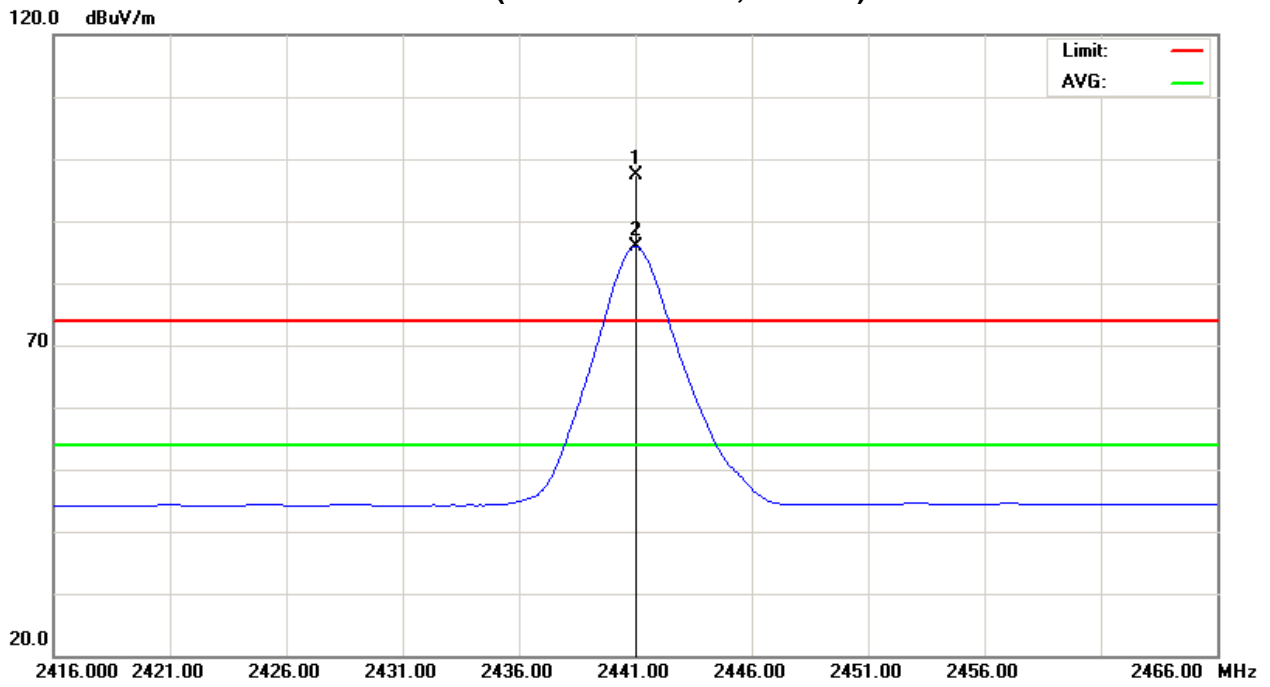



EUT :	BT Cradle	Model Name :	3656
Temperature :	22 °C	Relative Humidity :	44%
Test Voltage :	AC 120V/60Hz	EUT Orthogonal Axis :	X
Test Mode :	CH39		

Freq. (MHz)	Ant.Pol. H/V	Reading		Ant./CF CF(dB)	Act.		Limit		Note
		Peak (dBuV)	AV (dBuV)		Peak (dBuV/m)	AV (dBuV/m)	Peak (dBuV/m)	AV (dBuV/m)	
2441.00	H	62.48	51.25	32.58	95.06	83.83			Y/F
4882.04	H	40.19	31.66	4.59	44.78	36.25	74.00	54.00	Y/H

**Remark :**

- (1) All readings are Peak unless otherwise stated QP in column of 『Note』 . Peak denotes that the Peak reading compliance with the QP Limits and then QP Mode measurement didn't perform ◦
- (2) Measuring frequency range from 30MHz to 1000MHz or the 10th harmonic of highest fundamental frequency ◦ "F" denotes fundamental frequency; "H" denotes spurious frequency. "E" denotes band edge frequency. (This judgment method includes the Band Edge Requirement.)
- (3) Radiated emissions measured in frequency range above 1000MHz were made with an instrument using Peak detector mode and AV detector mode of the emission ◦
- (4) Data of measurement within this frequency range shown " \* " in the table above means the reading of emissions are attenuated more than 20dB below the permissible limits or the field strength is too small to be measured.
- (5) A preamp and high pass filter were used for this test in order to provide sufficient measurement sensitivity.
- (6) EUT Orthogonal Axis :  
"X" - denotes Laid on Table ; "Y" - denotes Vertical Stand ; "Z" - denotes Side Stand
- (7) During the measurements above 1 GHz it is taken care of that the EUT is always within the 3 dB cone of radiation BW of the used antenna



Orthogonal Axis : X  
CH39 (Above 1000 MHz, Horizontal)

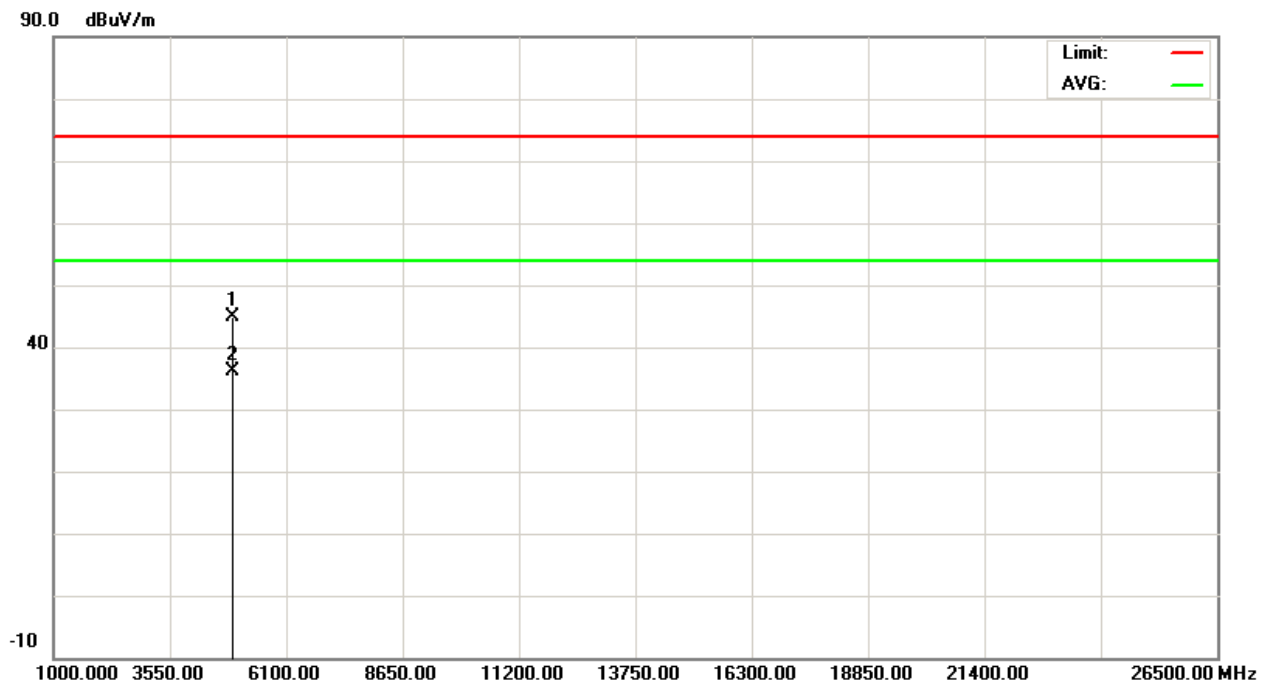
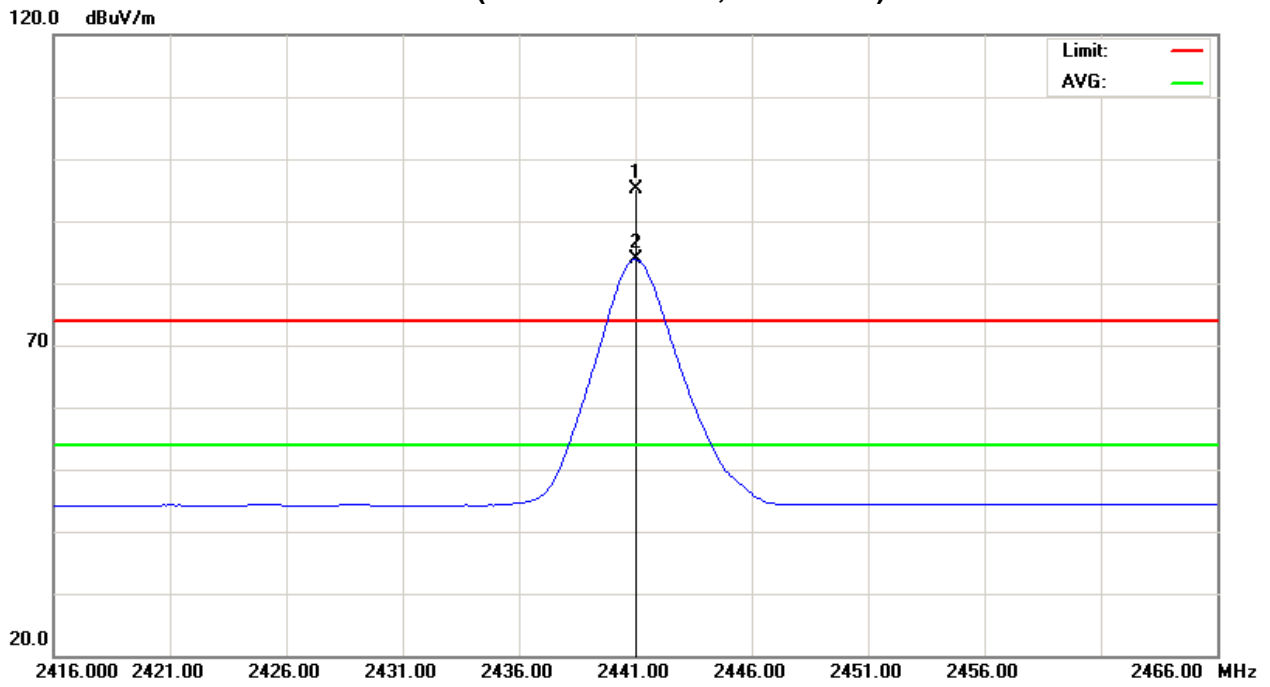





EUT :	BT Cradle	Model Name :	3656
Temperature :	22 °C	Relative Humidity :	44%
Test Voltage :	AC 120V/60Hz	EUT Orthogonal Axis :	X
Test Mode :	CH78		

Freq. (MHz)	Ant. Pol. H/V	Reading		Ant./CF CF(dB)	Act.		Limit		Note
		Peak (dBuV)	AV (dBuV)		Peak (dBuV/m)	AV (dBuV/m)	Peak (dBuV/m)	AV (dBuV/m)	
2479.80	V	64.50	53.00	32.72	97.22	85.72			Y/F
2483.50	V	27.72	20.83	32.74	60.46	53.57	74.00	54.00	Y/E
4959.90	V	45.07	41.00	4.80	49.87	45.80	74.00	54.00	Y/H

**Remark :**

- (1) All readings are Peak unless otherwise stated QP in column of 『Note』 . Peak denotes that the Peak reading compliance with the QP Limits and then QP Mode measurement didn't perform ◦
- (2) Measuring frequency range from 30MHz to 1000MHz or the 10th harmonic of highest fundamental frequency ◦ "F" denotes fundamental frequency; "H" denotes spurious frequency. "E" denotes band edge frequency. (This judgment method includes the Band Edge Requirement.)
- (3) Radiated emissions measured in frequency range above 1000MHz were made with an instrument using Peak detector mode and AV detector mode of the emission ◦
- (4) Data of measurement within this frequency range shown " \* " in the table above means the reading of emissions are attenuated more than 20dB below the permissible limits or the field strength is too small to be measured.
- (5) A preamp and high pass filter were used for this test in order to provide sufficient measurement sensitivity.
- (6) EUT Orthogonal Axis :  
"X" - denotes Laid on Table ; "Y" - denotes Vertical Stand ; "Z" - denotes Side Stand
- (7) During the measurements above 1 GHz it is taken care of that the EUT is always within the 3 dB cone of radiation BW of the used antenna



Orthogonal Axis : X  
CH78 (Above 1000 MHz, Vertical)

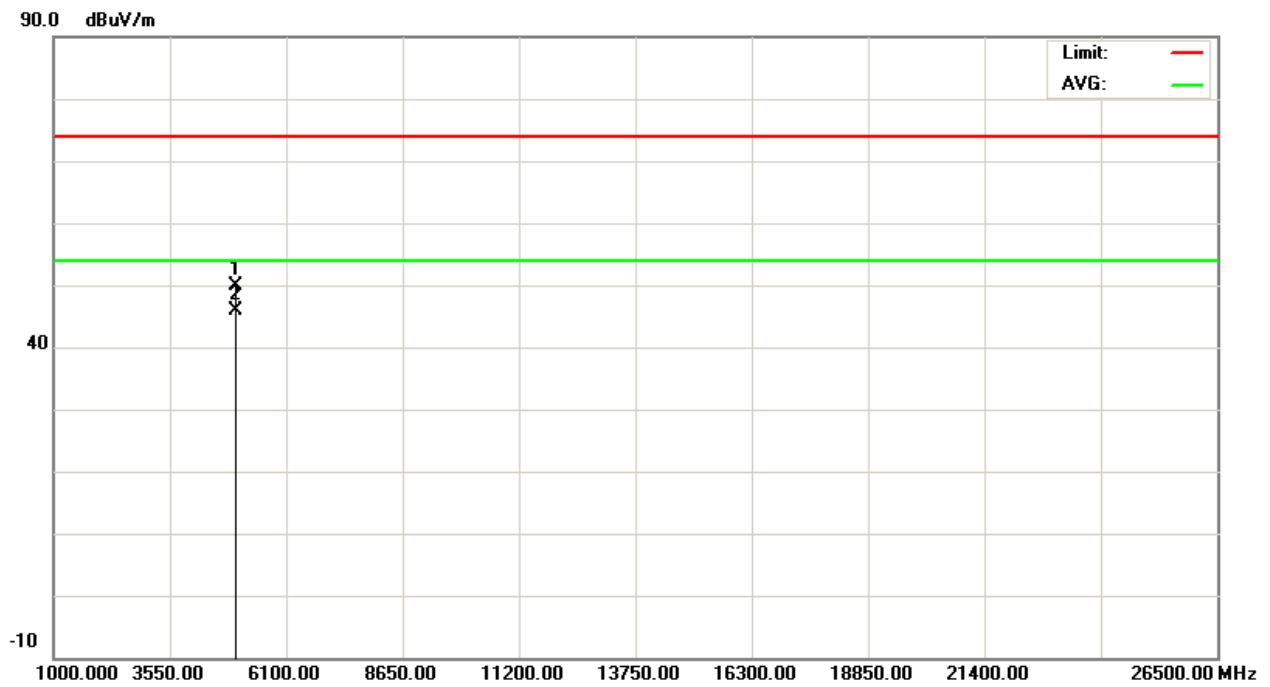
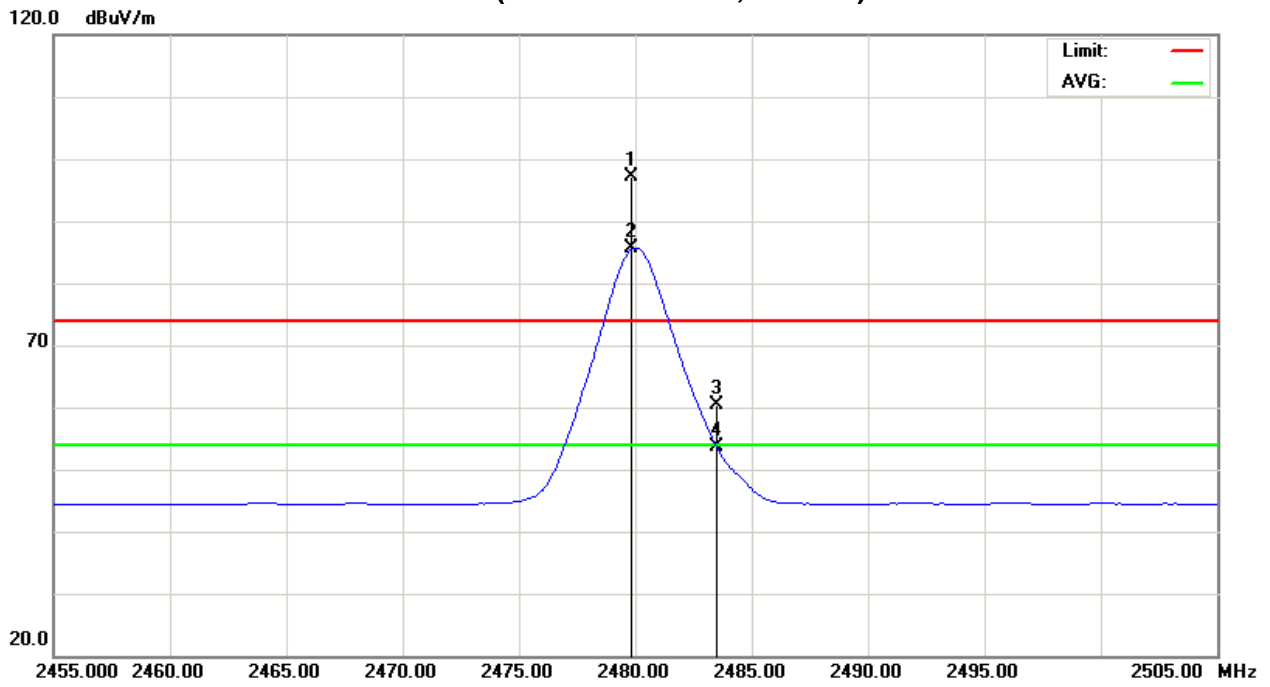



EUT :	BT Cradle	Model Name :	3656
Temperature :	22 ° C	Relative Humidity :	44%
Test Voltage :	AC 120V/60Hz	EUT Orthogonal Axis :	X
Test Mode :	CH78		

Freq. (MHz)	Ant. Pol. H/V	Reading		Ant./CF CF(dB)	Act.		Limit		Note
		Peak (dBuV)	AV (dBuV)		Peak (dBuV/m)	AV (dBuV/m)	Peak (dBuV/m)	AV (dBuV/m)	
2479.80	H	62.31	51.34	32.72	95.03	84.06			Y/F
2483.50	H	23.90	19.38	32.74	56.64	52.12	74.00	54.00	Y/E
4959.98	H	42.48	33.47	4.80	47.28	38.27	74.00	54.00	Y/H

**Remark :**

- (1) All readings are Peak unless otherwise stated QP in column of 『Note』 . Peak denotes that the Peak reading compliance with the QP Limits and then QP Mode measurement didn't perform ◦
- (2) Measuring frequency range from 30MHz to 1000MHz or the 10th harmonic of highest fundamental frequency ◦ “F” denotes fundamental frequency; “H” denotes spurious frequency. “E” denotes band edge frequency. (This judgment method includes the Band Edge Requirement.)
- (3) Radiated emissions measured in frequency range above 1000MHz were made with an instrument using Peak detector mode and AV detector mode of the emission ◦
- (4) Data of measurement within this frequency range shown “ \* ” in the table above means the reading of emissions are attenuated more than 20dB below the permissible limits or the field strength is too small to be measured.
- (5) A preamp and high pass filter were used for this test in order to provide sufficient measurement sensitivity.
- (6) EUT Orthogonal Axis :  
“X” - denotes Laid on Table ; “Y” - denotes Vertical Stand ; “Z” - denotes Side Stand
- (7) During the measurements above 1 GHz it is taken care of that the EUT is always within the 3 dB cone of radiation BW of the used antenna



Orthogonal Axis : X  
CH78 (Above 1000 MHz, Horizontal)

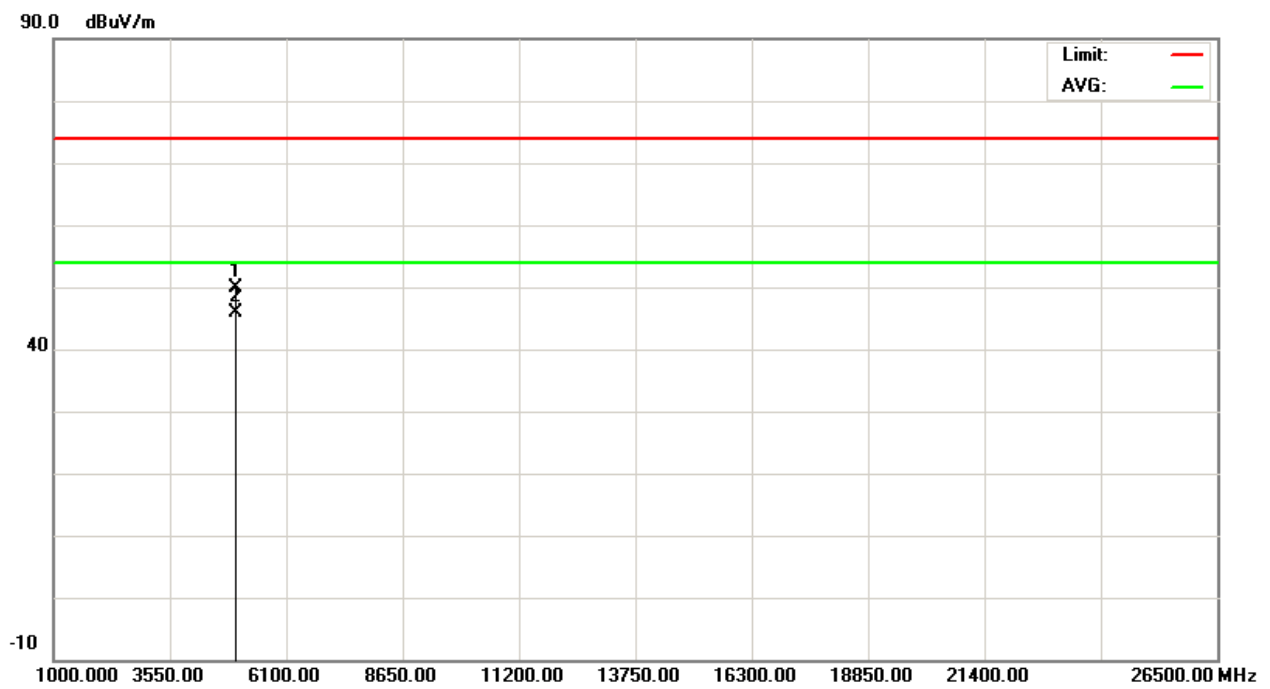
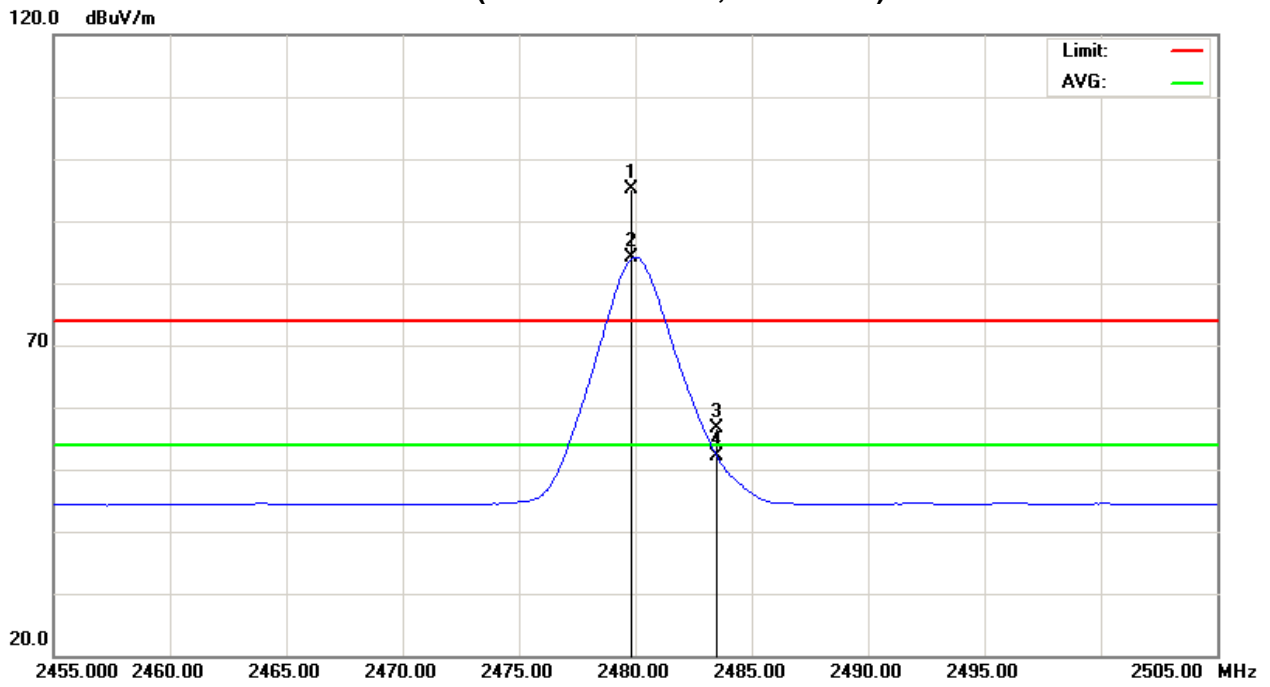



**4.2.9 TEST RESULTS-RESTRICTED BANDS REQUIREMENTS**

EUT :	BT Cradle	Model Name :	3656
Temperature :	22 ° C	Relative Humidity :	44%
Test Voltage :	AC 120V/60Hz		
Test Mode :	Vertical		
Note :	1. The transmitter was setup to transmit at the lowest channel (CH00). Then the field strength was measured at 2310-2390 MHz. 2. The transmitter was setup to transmit at the highest channel (CH78). Then the field strength was measured at 2483.5-2500 MHz.		

Freq. (MHz)	Ant.Pol. H/V	Reading		Ant./CF CF(dB)	Act.		Limit		Note
		Peak (dBuV)	AV (dBuV)		Peak (dBuV/m)	AV (dBuV/m)	Peak (dBuV/m)	AV (dBuV/m)	
2390.00	V	21.57	11.73	32.38	53.95	44.11	74.00	54.00	CH00
2483.50	V	27.72	20.83	32.74	60.46	53.57	74.00	54.00	CH78

**Remark :**

- (1) Radiated emissions measured in frequency range above 1000MHz were made with an instrument using Peak detector mode and AV detector mode of the emission ◦
- (2) EUT Orthogonal Axis :  
 "X" - denotes Laid on Table ; "Y" - denotes Vertical Stand ; "Z" - denotes Side Stand



### Restricted Bands Requirements, Vertical CH00

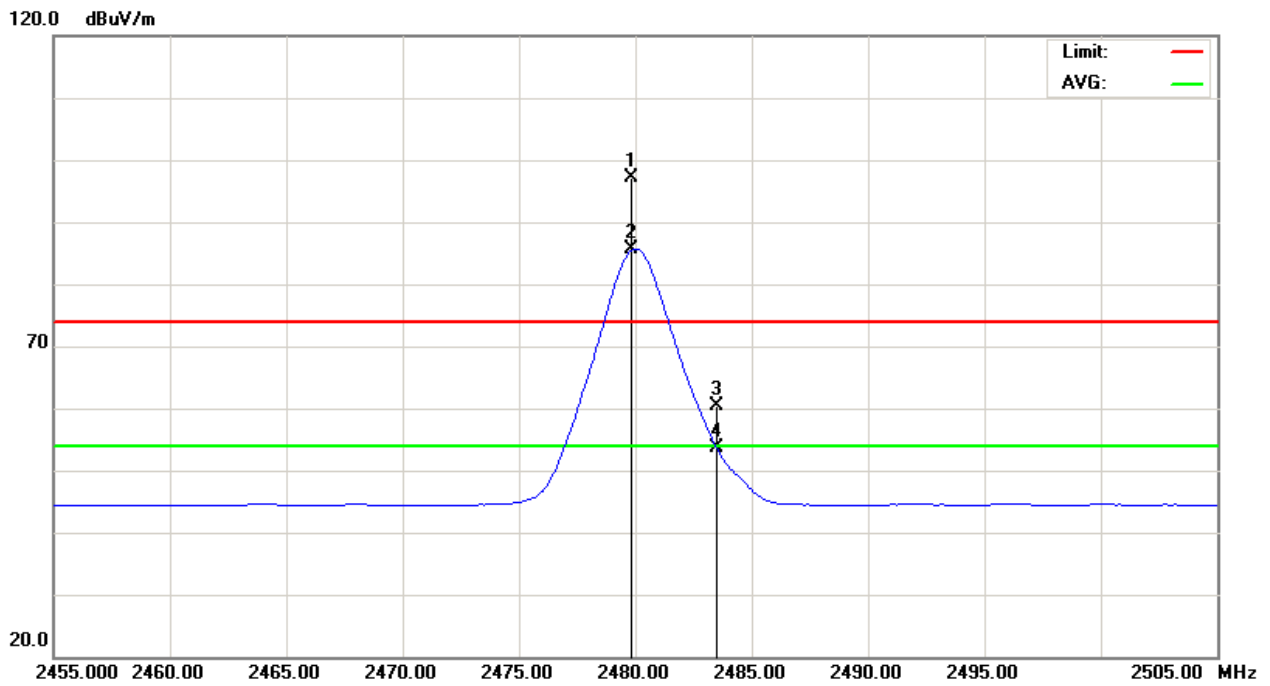
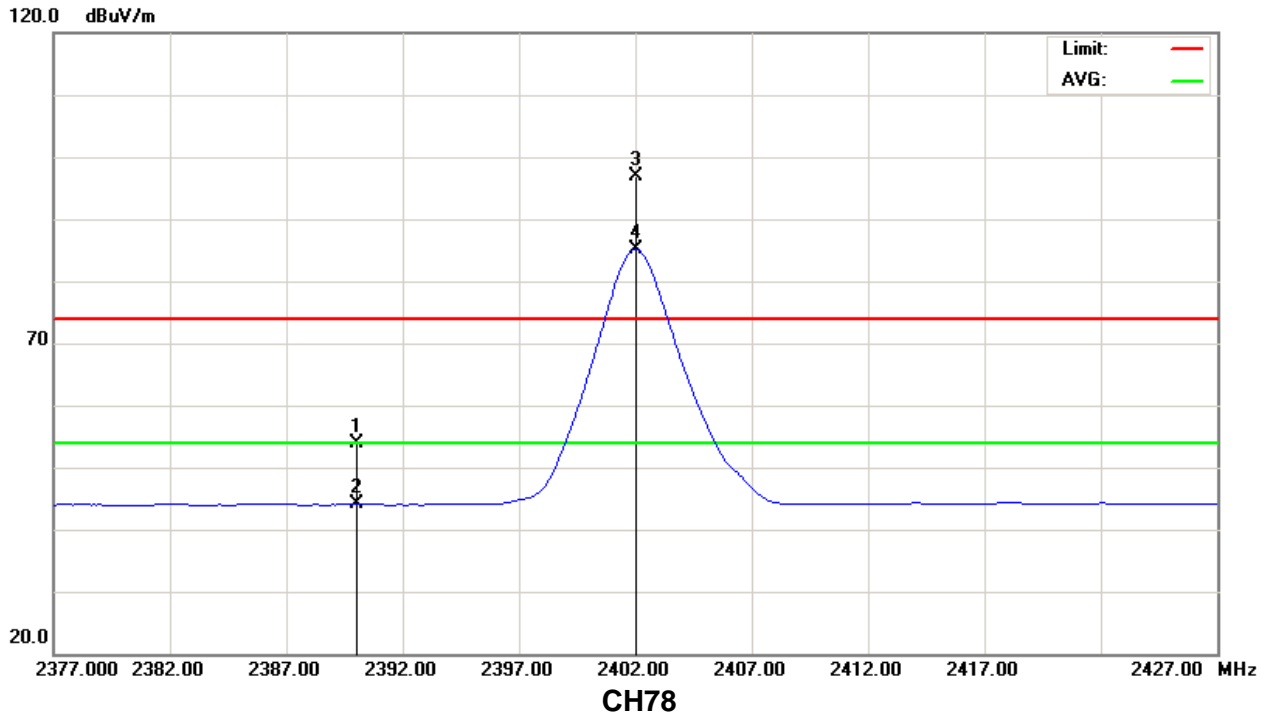



EUT :	BT Cradle	Model Name :	3656
Temperature :	22 °C	Relative Humidity :	44%
Test Voltage :	AC 120V/60Hz		
Test Mode :	Horizontal		
Note :	1. The transmitter was setup to transmit at the lowest channel (CH00). Then the field strength was measured at 2310-2390 MHz. 2. The transmitter was setup to transmit at the highest channel (CH78). Then the field strength was measured at 2483.5-2500 MHz.		

Freq. (MHz)	Ant.Pol. H/V	Reading		Ant./CF CF(dB)	Act.		Limit		Note
		Peak (dBuV)	AV (dBuV)		Peak (dBuV/m)	AV (dBuV/m)	Peak (dBuV/m)	AV (dBuV/m)	
2390.00	H	21.28	11.77	32.38	53.66	44.15	74.00	54.00	CH00
2483.50	H	23.90	19.38	32.74	56.64	52.12	74.00	54.00	CH78

Remark :

- (1) Radiated emissions measured in frequency range above 1000MHz were made with an instrument using Peak detector mode and AV detector mode of the emission ◦
- (2) EUT Orthogonal Axis :  
 "X" - denotes Laid on Table ; "Y" - denotes Vertical Stand ; "Z" - denotes Side Stand



### Restricted Bands Requirements, Horizontal CH00

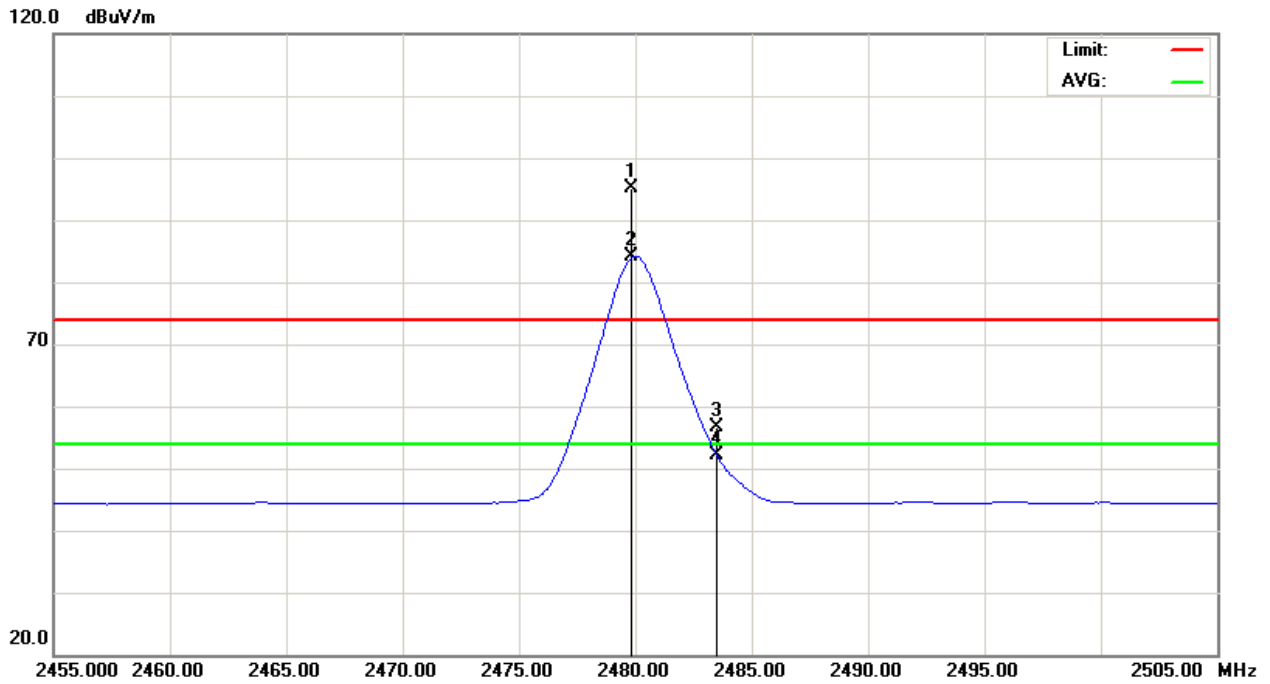
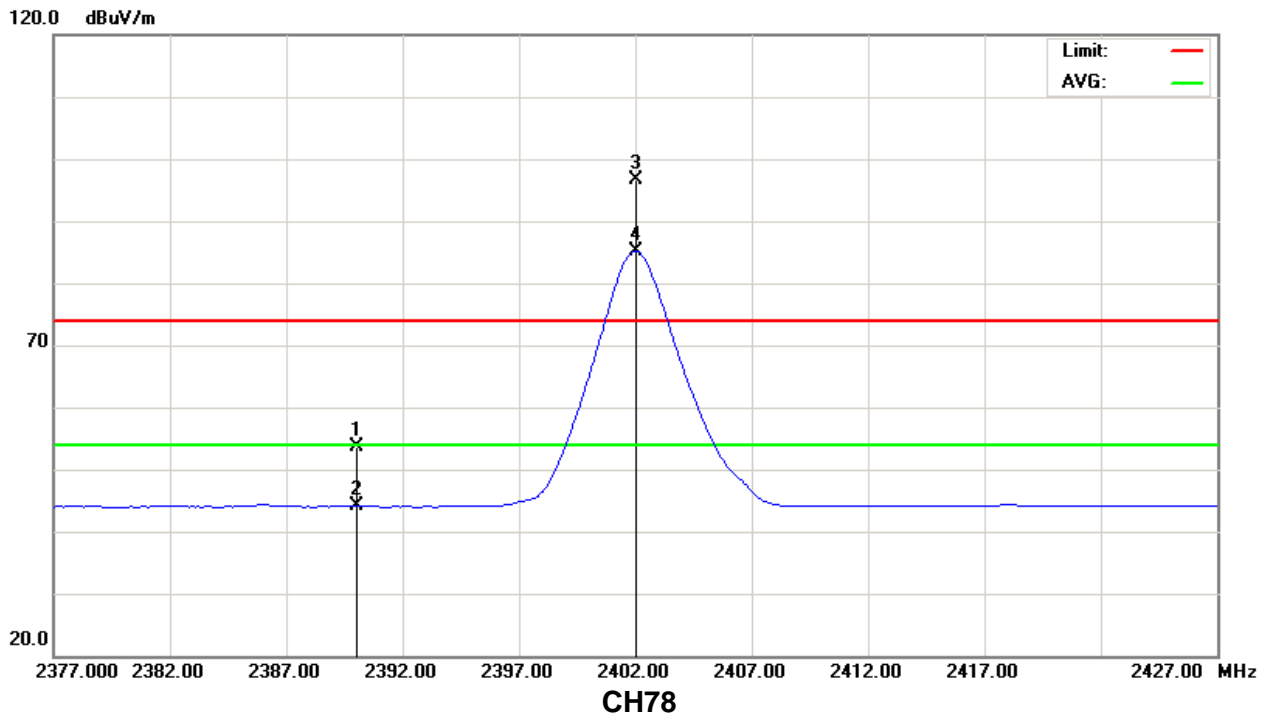





**5. NUMBER OF HOPPING CHANNEL**

**5.1 APPLIED PROCEDURES / LIMIT**

FCC Part15 (15.247) , Subpart C			
Section	Test Item	Frequency Range (MHz)	Result
15.247 (a)(1)(ii)	Number of Hopping Channel	2400-2483.5	PASS

**5.1.1 MEASUREMENT INSTRUMENTS LIST AND SETTING**

Item	Kind of Equipment	Manufacturer	Type No.	Serial No.	Calibrated until
1	Spectrum Analyzer	R&S	FSP-40	100129	Sep. 09, 2010

Remark: " N/A" denotes No Model Name, Serial No. or No Calibration specified.

Spectrum Parameters	Setting
Attenuation	Auto
Span Frequency	> Operating Frequency Range
RB	100 kHz
VB	100 kHz
Detector	Peak
Trace	Max Hold
Sweep Time	Auto

**5.1.2 TEST PROCEDURE**

- a. The EUT was directly connected to the spectrum analyzer and antenna output port as show in the block diagram below,
- b. Spectrum Setting : RBW= 100KHz, VBW=100KHz, Sweep time = Auto.

**5.1.3 DEVIATION FROM STANDARD**

No deviation.

**5.1.4 TEST SETUP**

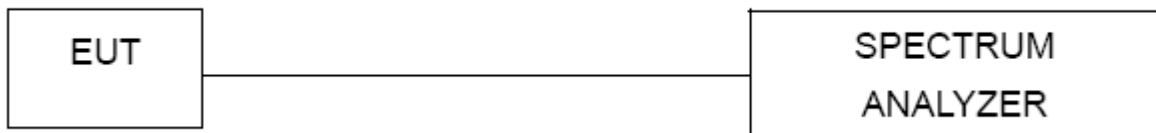

**5.1.5 EUT OPERATION CONDITIONS**

The EUT tested system was configured as the statements of 4.1.6 Unless otherwise a special operating condition is specified in the follows during the testing.



**5.1.6 TEST RESULTS**

EUT :	BT Cradle	Model Name :	3656
Temperature :	25 °C	Relative Humidity :	68 %
Test Voltage :	AC 120V/60Hz		
Test Mode :	Hopping Mode		

Number of Hopping Channel	79
---------------------------	----

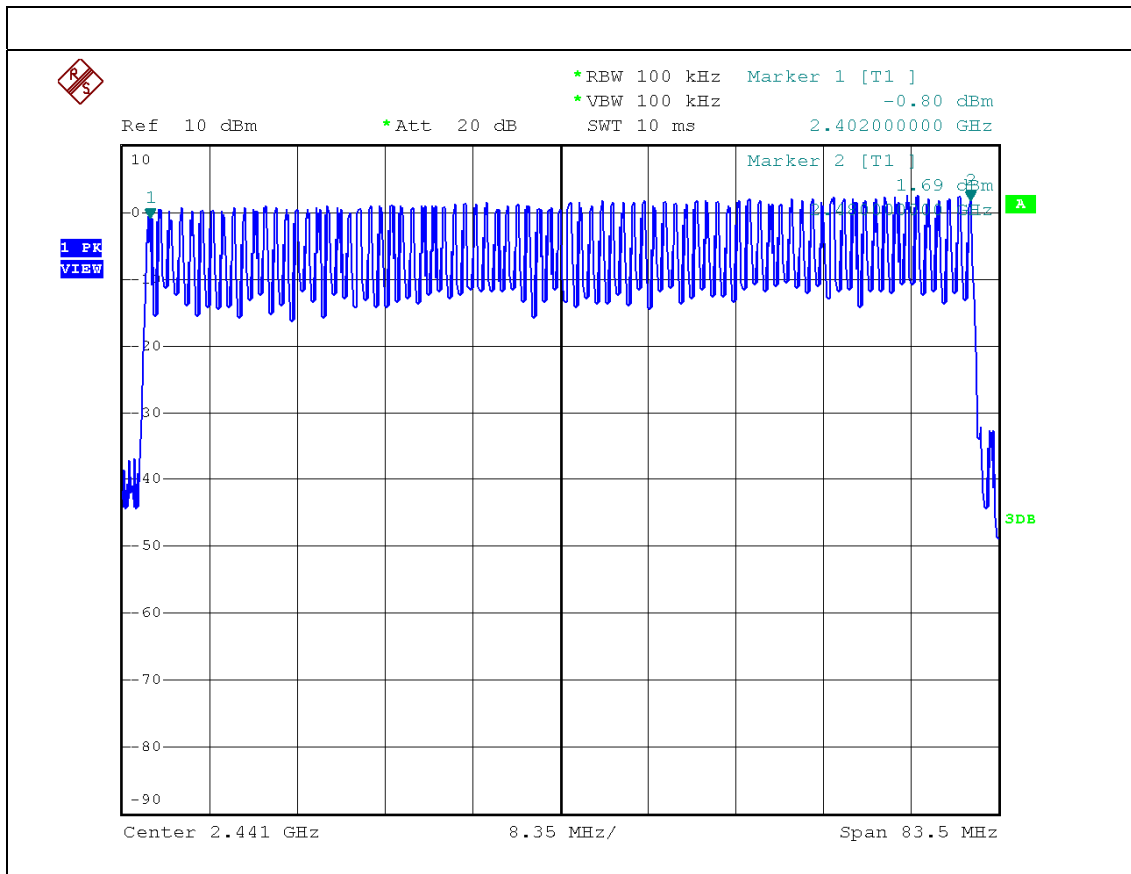



**6. AVERAGE TIME OF OCCUPANCY**

**6.1 APPLIED PROCEDURES / LIMIT**

FCC Part15 (15.247) , Subpart C				
Section	Test Item	Limit	Frequency Range (MHz)	Result
15.247 (a)(1)(ii)	Average Time of Occupancy	< = 0.4 sec (a 30 second period)	2400-2483.5	PASS

**6.1.1 MEASUREMENT INSTRUMENTS LIST**

Item	Kind of Equipment	Manufacturer	Type No.	Serial No.	Calibrated until
1	Spectrum Analyzer	R&S	FSP-40	100129	Sep. 09, 2010

Remark: " N/A" denotes No Model Name , Serial No. or No Calibration specified.

**6.1.2 TEST PROCEDURE**

- a. The transmitter output (antenna port) was connected to the spectrum analyser
- b. Set RBW of spectrum analyzer to 100kHz and VBW to 100kHz.
- c. Use a video trigger with the trigger level set to enable triggering only on full pulses.
- d. Sweep Time is more than once pulse time.
- e. Set the center frequency on any frequency would be measure and set the frequency span to zero span.
- f. Measure the maximum time duration of one single pulse.
- g. Set the EUT for DH5, DH3 and DH1 packet transmitting.
- h. Measure the maximum time duration of one single pulse.
- i. DH5 Packet permit maximum  $1600 / 79 / 6 = 3.37$  hops per second in each channel (5 time slots RX, 1 time slot TX). So, the dwell time is the time duration of the pulse times  $3.37 \times 31.6 = 106.6$  within 31.6 seconds.
- j. DH3 Packet permit maximum  $1600 / 79 / 4 = 5.06$  hops per second in each channel (3 time slots RX, 1 time slot TX). So, the dwell time is the time duration of the pulse times  $5.06 \times 31.6 = 160$  within 31.6 seconds.
- k. DH1 Packet permit maximum  $1600 / 79 / 2 = 10.12$  hops per second in each channel (1 time slot RX, 1 time slot TX). So, the dwell time is the time duration of the pulse times  $10.12 \times 31.6 = 320$  within 31.6 seconds.

**6.1.3 DEVIATION FROM STANDARD**

No deviation.



#### 6.1.4 TEST SETUP

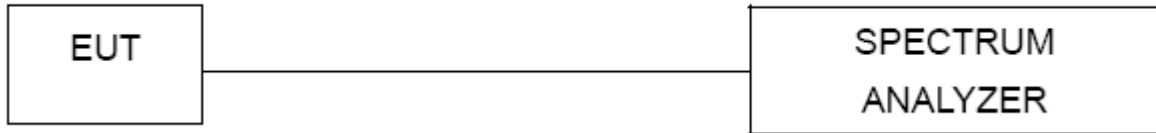

#### 6.1.5 EUT OPERATION CONDITIONS

The EUT tested system was configured as the statements of 4.1.6 Unless otherwise a special operating condition is specified in the follows during the testing.



**6.1.6 TEST RESULTS**

EUT :	BT Cradle	Model Name :	3656
Temperature :	25 °C	Relative Humidity :	68 %
Test Voltage :	AC 120V/60Hz		
Test Mode :	CH00-DH1/DH3/DH5		

Data Packet	Frequency	Pulse Duration (ms)	Dwell Time (s)	Limits (s)
DH1	2402 MHz	0.4600	0.1472	0.4000
DH3	2402 MHz	1.7100	0.2736	0.4000
DH5	2402 MHz	2.9700	0.3168	0.4000

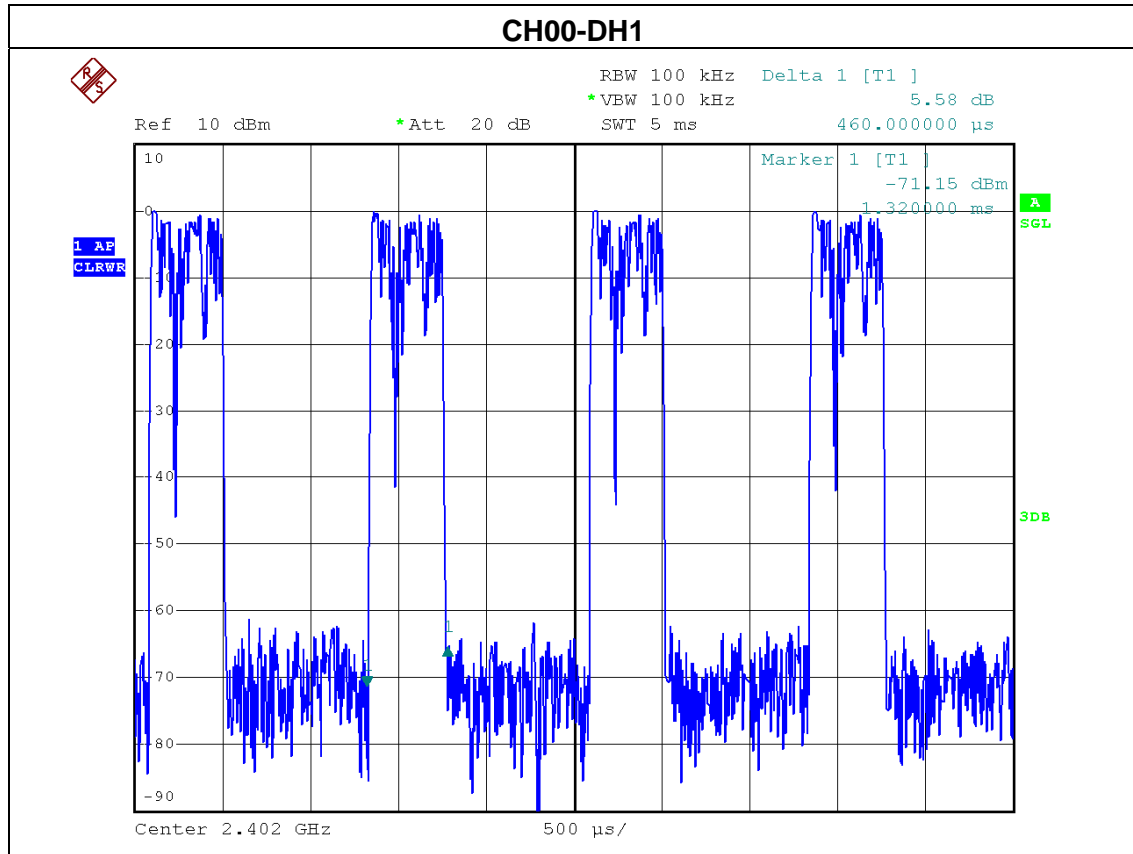

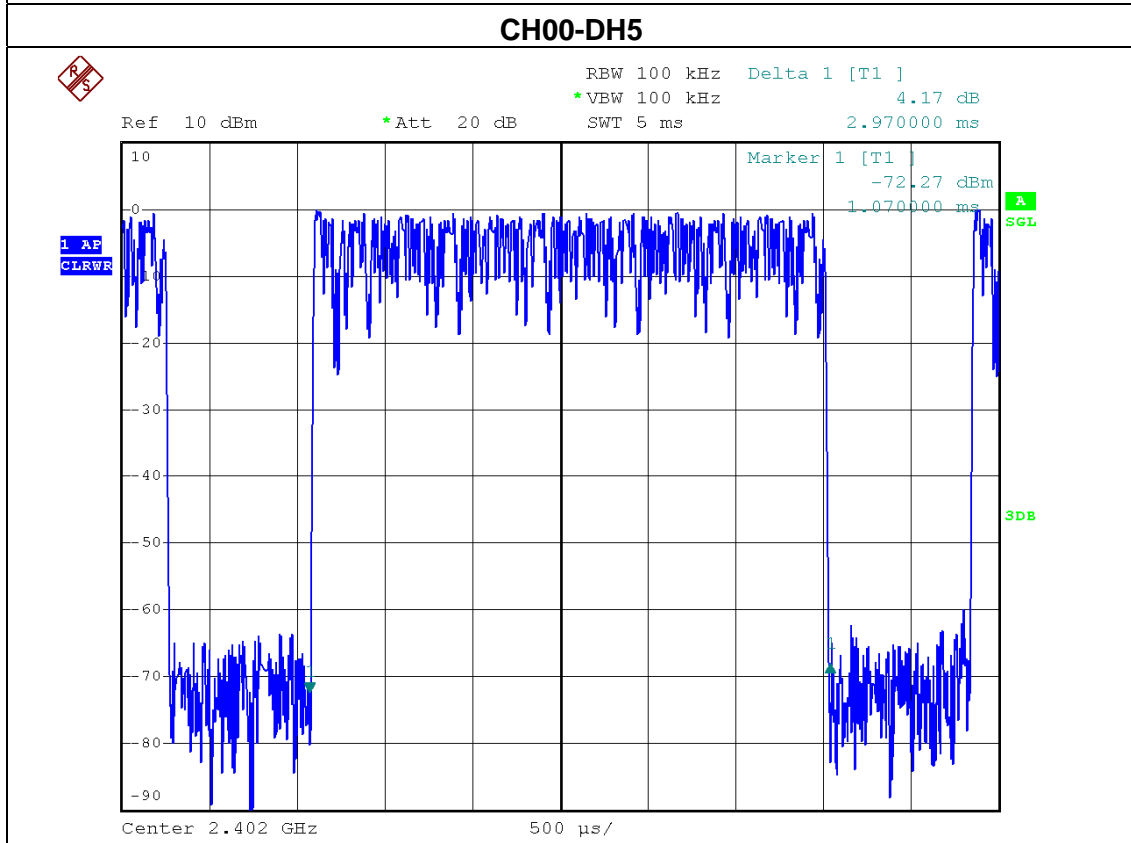
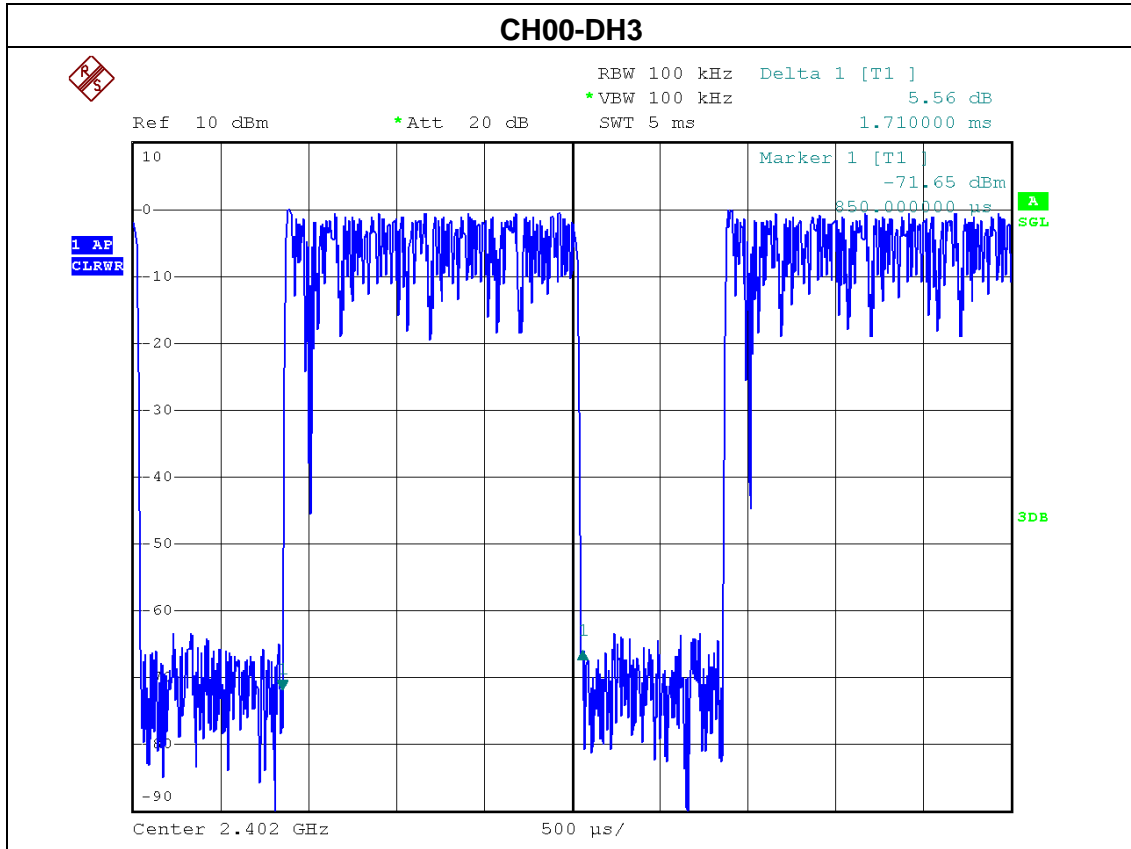



EUT :	BT Cradle	Model Name :	3656
Temperature :	25 °C	Relative Humidity :	68 %
Test Voltage :	AC 120V/60Hz		
Test Mode :	CH39 -DH1/DH3/DH5		

Data Packet	Frequency	Pulse Duration (ms)	Dwell Time (s)	Limits (s)
DH1	2441 MHz	0.4500	0.1440	0.4000
DH3	2441 MHz	1.7100	0.2736	0.4000
DH5	2441 MHz	2.9700	0.3168	0.4000

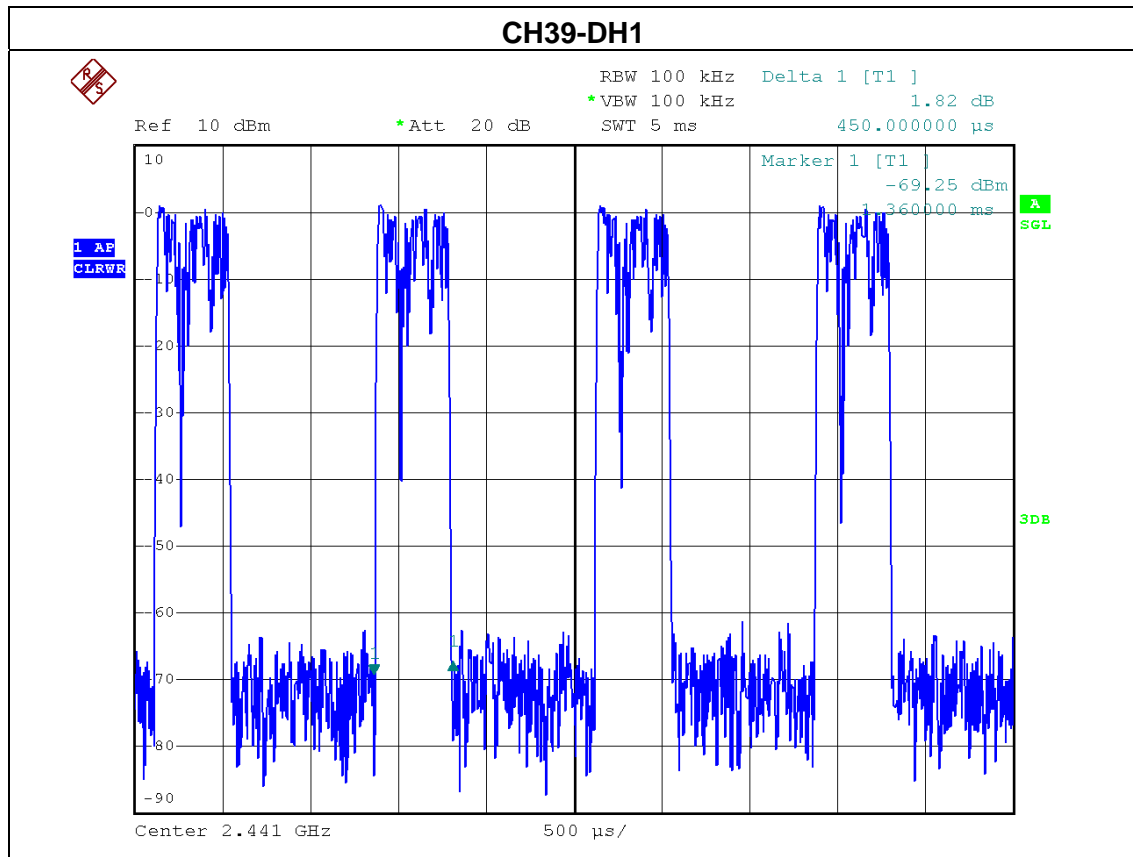

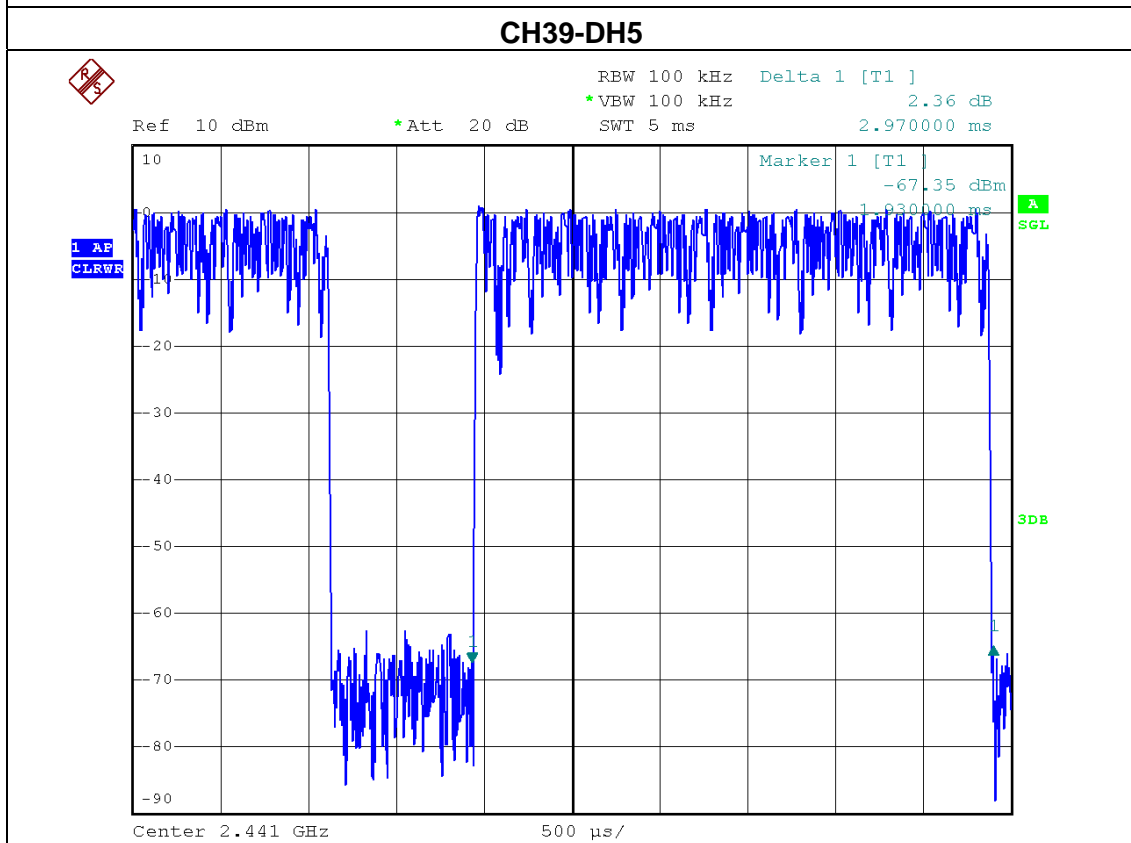
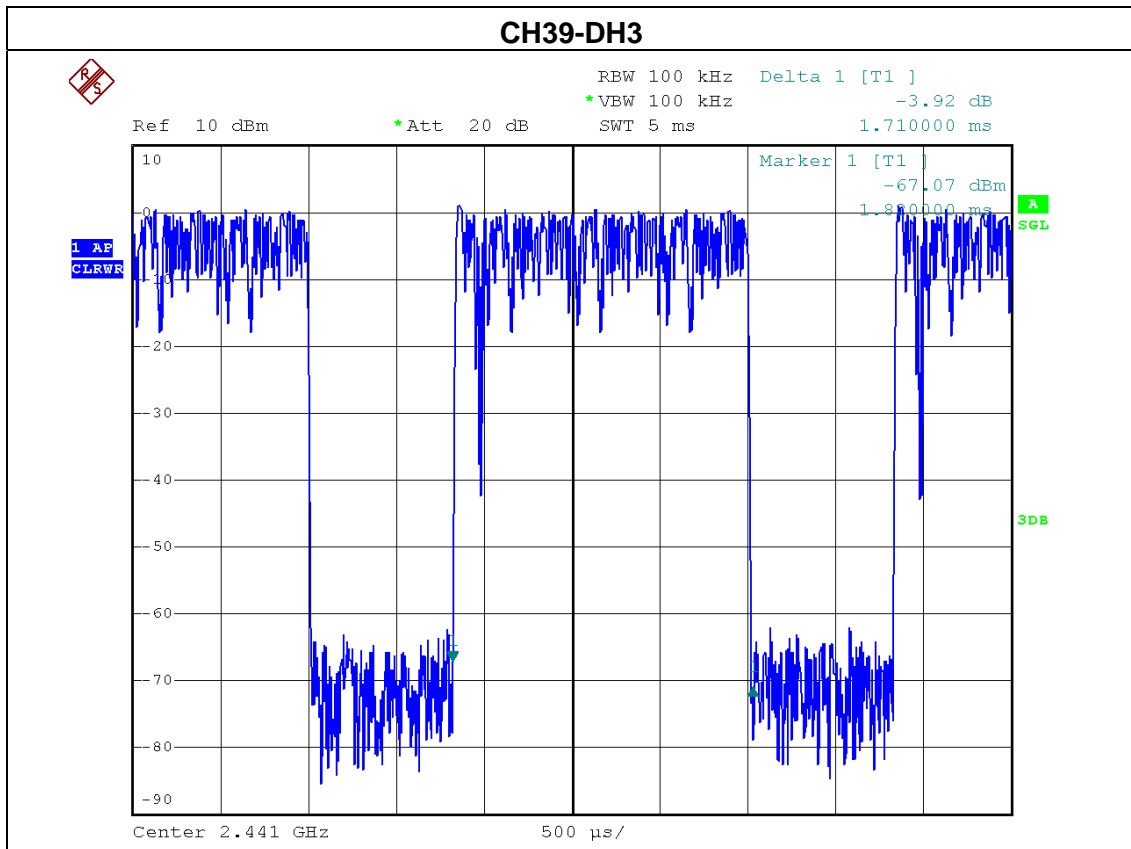





EUT :	BT Cradle	Model Name :	3656
Temperature :	25 °C	Relative Humidity :	68 %
Test Voltage :	AC 120V/60Hz		
Test Mode :	CH78 -DH1/DH3/DH5		

Data Packet	Frequency	Pulse Duration (ms)	Dwell Time (s)	Limits (s)
DH1	2480 MHz	0.4600	0.1472	0.4000
DH3	2480 MHz	1.7200	0.2752	0.4000
DH5	2480 MHz	2.9700	0.3168	0.4000

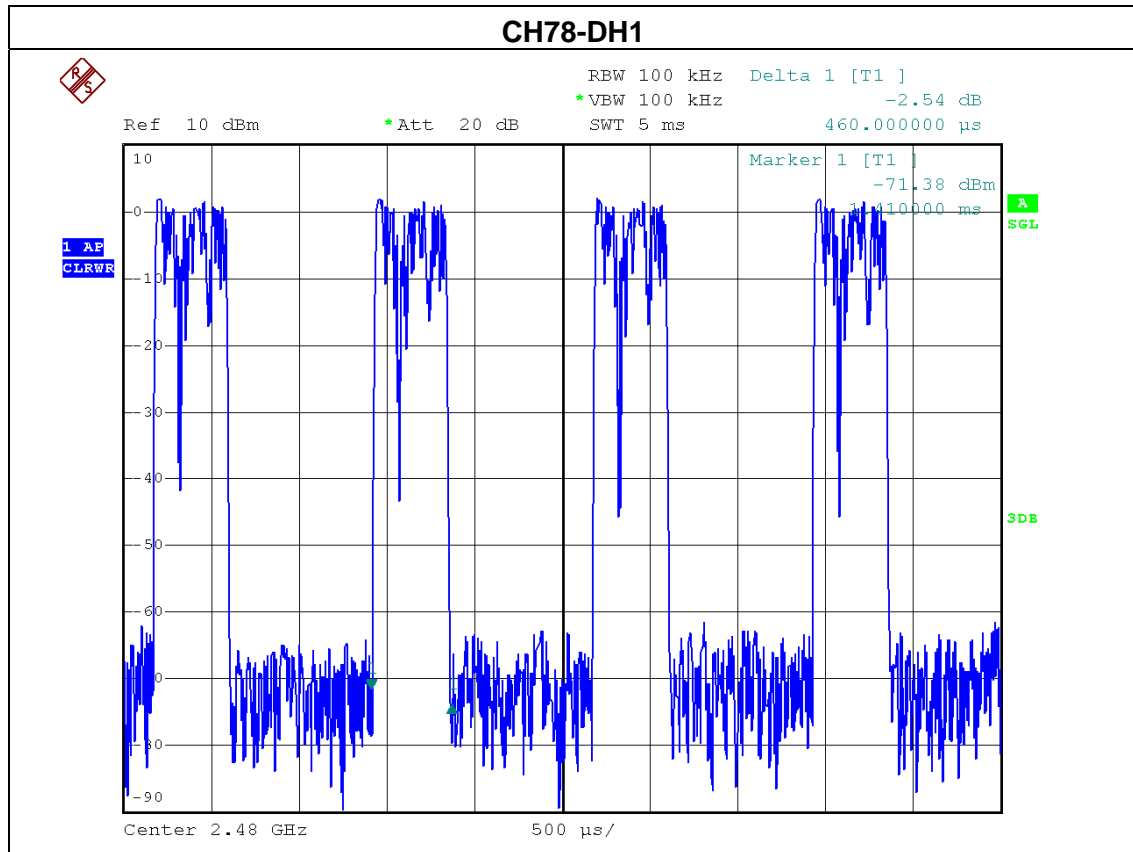

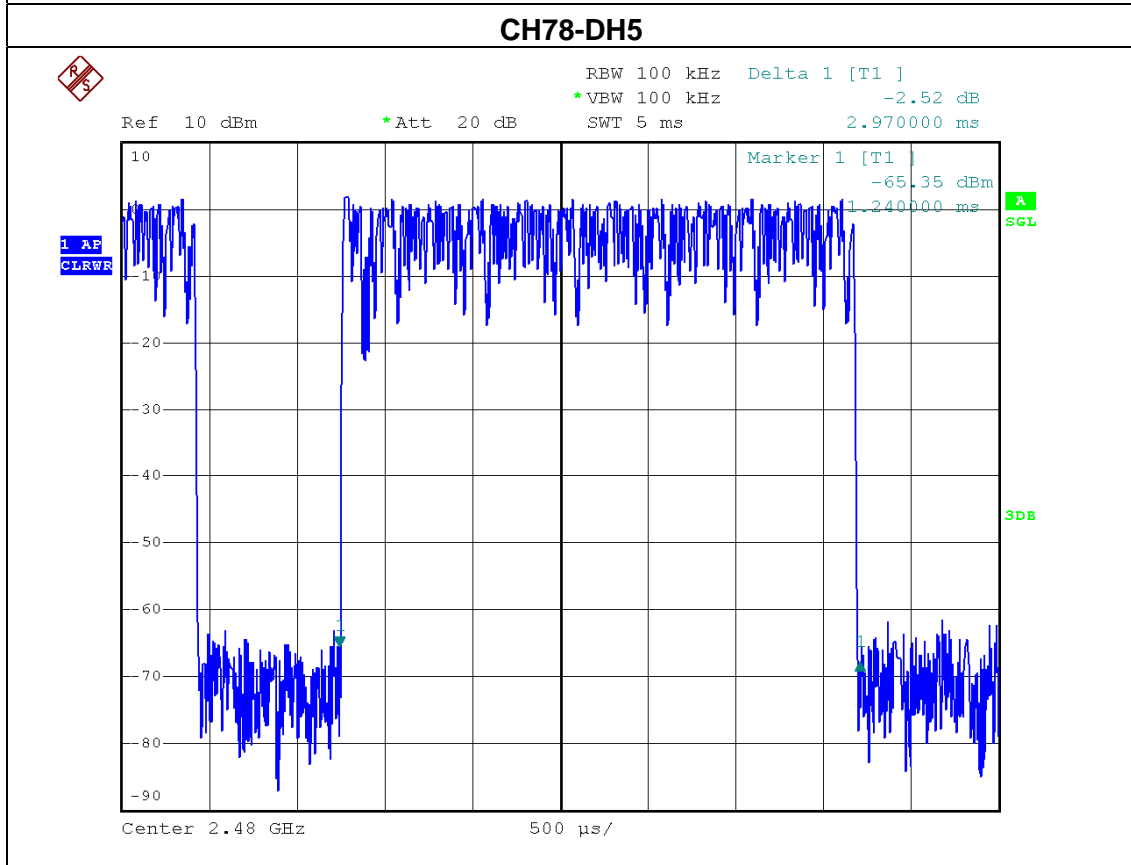
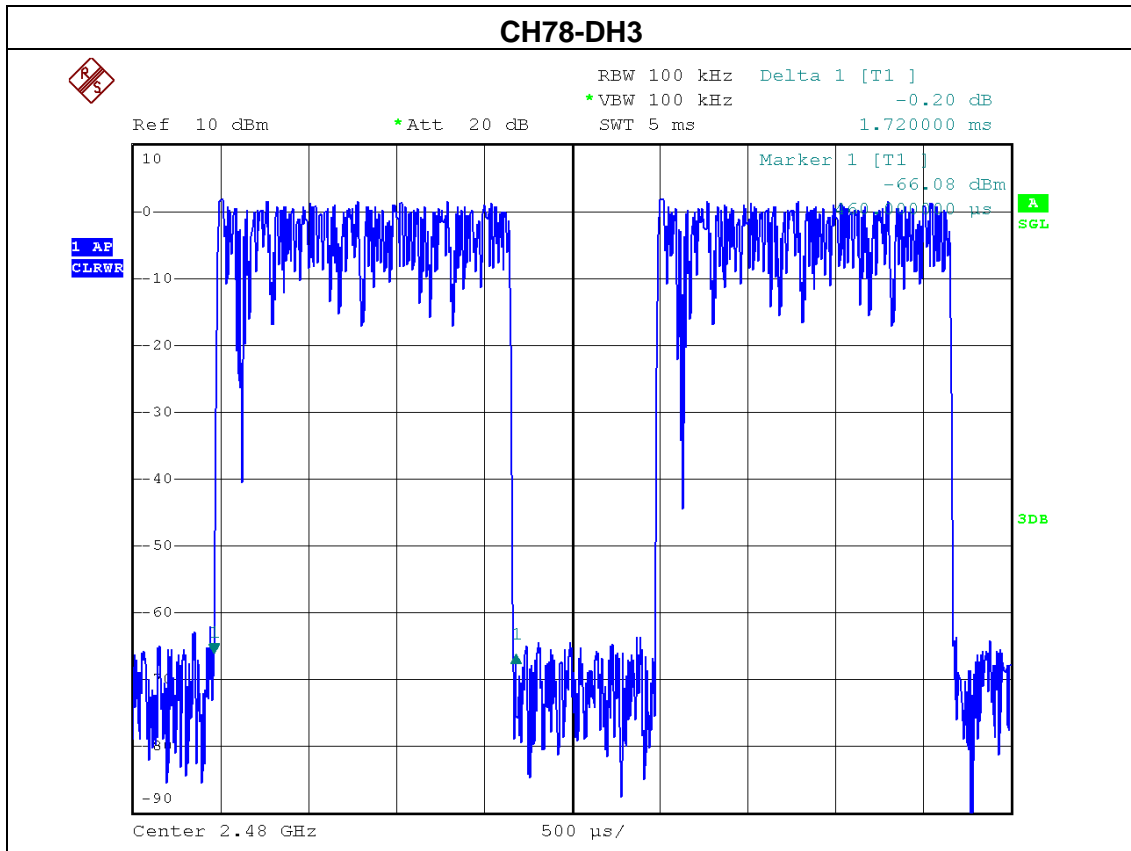



**7. HOPPING CHANNEL SEPARATION MEASUREMENT**

**7.1 APPLIED PROCEDURES / LIMIT**

Frequency hopping systems operating in the 2400-2483.5 MHz band may have hopping channel carrier frequencies that are separated by 25 kHz or two-thirds of the 20 dB bandwidth of the hopping channel, whichever is greater.

**7.1.1 MEASUREMENT INSTRUMENTS LIST AND SETTING**

Item	Kind of Equipment	Manufacturer	Type No.	Serial No.	Calibrated until
1	Spectrum Analyzer	R&S	FSP-40	100129	Sep. 09, 2010

Remark: " N/A" denotes No Model Name , Serial No. or No Calibration specified.

Spectrum Parameter	Setting
Attenuation	Auto
Span Frequency	> Measurement Bandwidth or Channel Separation
RB	30 kHz (20dB Bandwidth) / 100 kHz (Channel Separation)
VB	100 kHz (20dB Bandwidth) / 300 kHz (Channel Separation)
Detector	Peak
Trace	Max Hold
Sweep Time	Auto

**7.1.2 TEST PROCEDURE**

- a. The transmitter output (antenna port) was connected to the spectrum analyser in peak hold mode.
- b. The resolution bandwidth of 30 kHz and the video bandwidth of 100 kHz were utilised for 20 dB bandwidth measurement.
- c. The resolution bandwidth of 100 kHz and the video bandwidth of 300 kHz were utilised for channel separation measurement.

**7.1.3 DEVIATION FROM STANDARD**

No deviation.

**7.1.4 TEST SETUP**



**7.1.5 EUT OPERATION CONDITIONS**

The EUT tested system was configured as the statements of 4.1.6 Unless otherwise a special operating condition is specified in the follows during the testing.



**7.1.6 TEST RESULTS**

EUT :	BT Cradle	Model Name :	3656
Temperature :	25 °C	Relative Humidity :	68 %
Test Voltage :	AC 120V/60Hz		
Test Mode :	CH00 / CH39 / CH78		

Frequency	Ch. Separation (MHz)	20dB Bandwidth (MHz)	Result
2402 MHz	1	0.63	Complies
2441 MHz	1	0.63	Complies
2480 MHz	1	0.63	Complies

**Ch. Separation Limits: >20dB bandwidth or >2/3 of 20dB bandwidth**

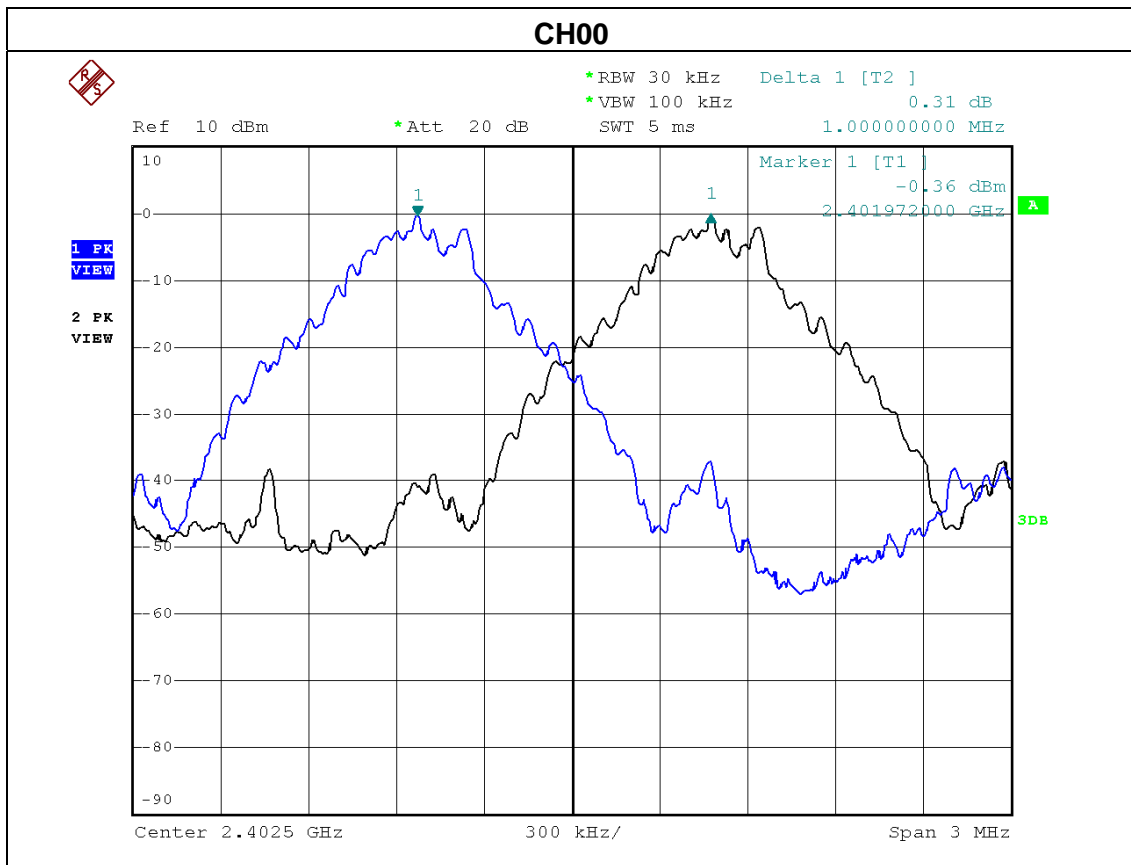

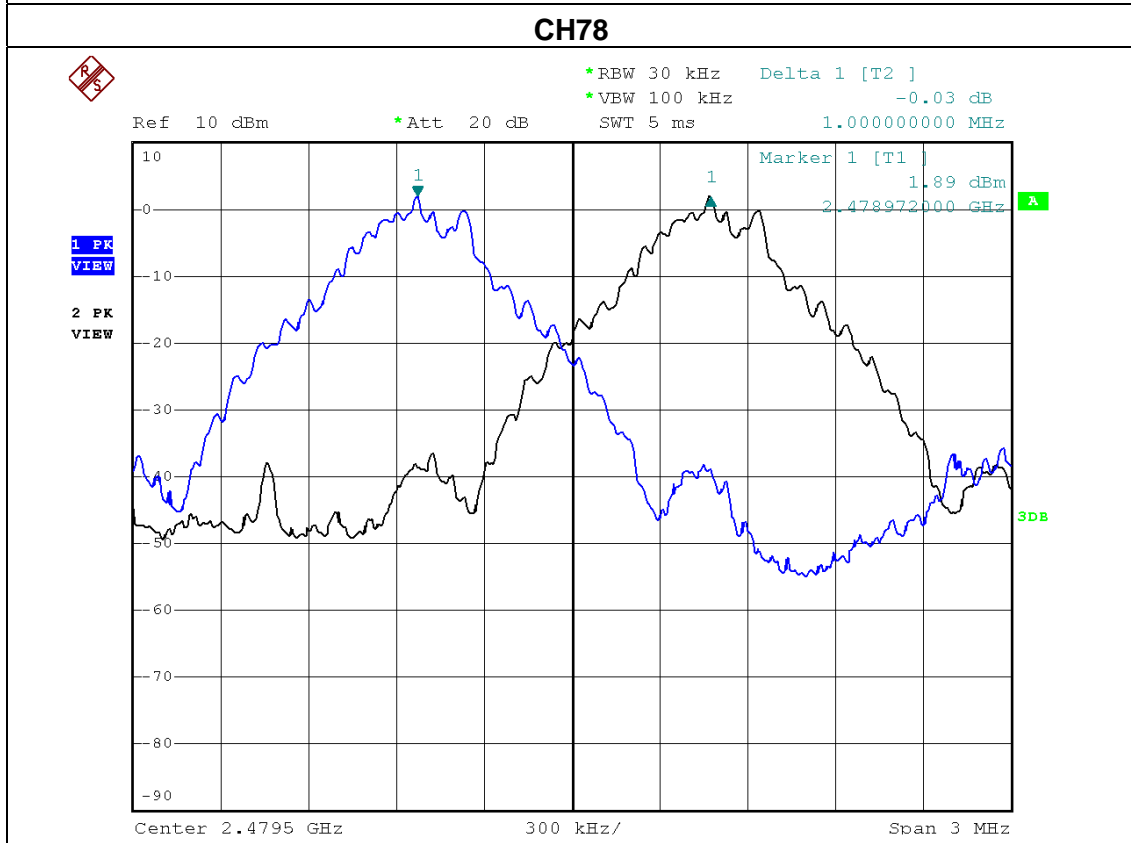
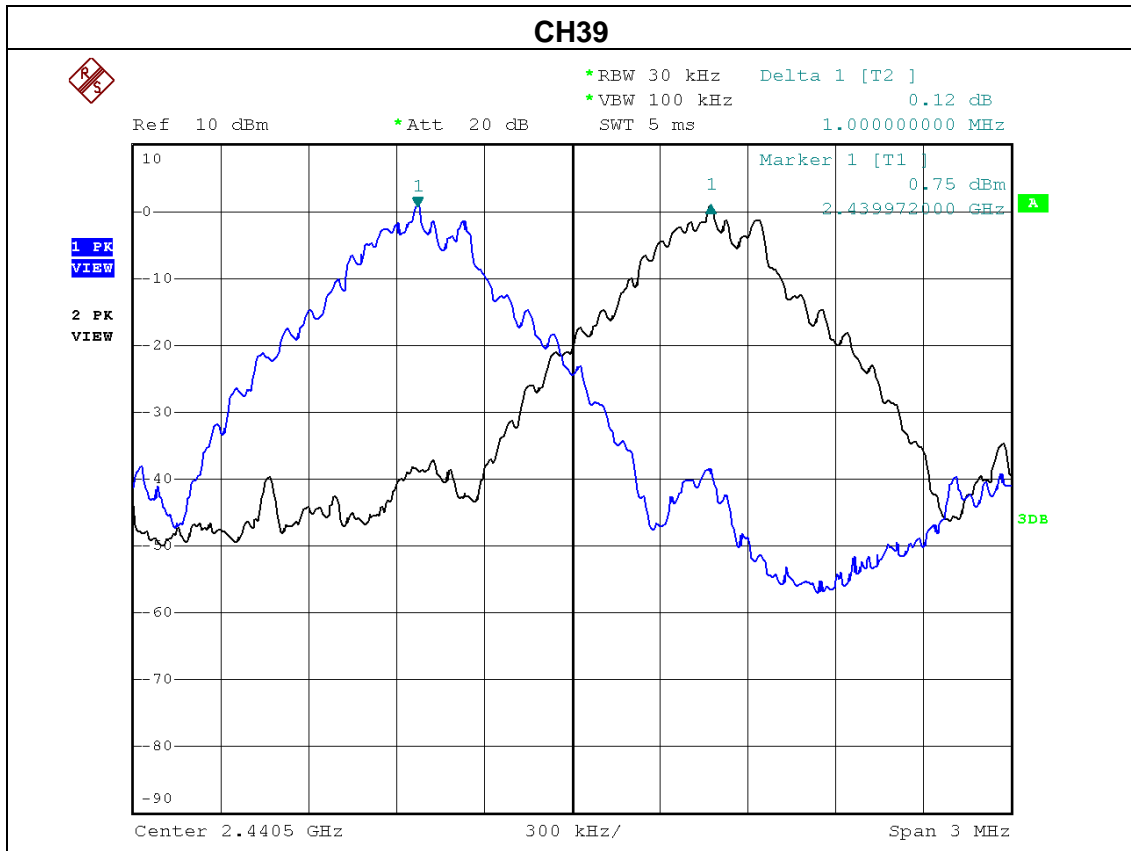



**8. BANDWIDTH TEST**

**8.1 APPLIED PROCEDURES / LIMIT**

FCC Part15 (15.247) , Subpart C				
Section	Test Item	Limit	Frequency Range (MHz)	Result
15.247 (a)(2)	Bandwidth	<= 1 MHz (20dB bandwidth)	2400-2483.5	PASS

**8.1.1 MEASUREMENT INSTRUMENTS LIST AND SETTING**

Item	Kind of Equipment	Manufacturer	Type No.	Serial No.	Calibrated until
1	Spectrum Analyzer	R&S	FSP-40	100129	Sep. 09, 2010

Remark: " N/A" denotes No Model Name , Serial No. or No Calibration specified.

Spectrum Parameter	Setting
Attenuation	Auto
Span Frequency	> Measurement Bandwidth or Channel Separation
RB	30 kHz (20dB Bandwidth) / 100 kHz (Channel Separation)
VB	100 kHz (20dB Bandwidth) / 300 kHz (Channel Separation)
Detector	Peak
Trace	Max Hold
Sweep Time	Auto

**8.1.2 TEST PROCEDURE**

- a. The EUT was directly connected to the spectrum analyzer and antenna output port as show in the block diagram below,
- b. Spectrum Setting : RBW= 100KHz, VBW=100KHz, Sweep time = Auto.

**8.1.3 DEVIATION FROM STANDARD**

No deviation.

**8.1.4 TEST SETUP**

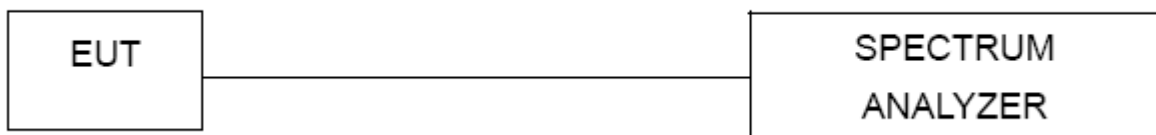

**8.1.5 EUT OPERATION CONDITIONS**

The EUT tested system was configured as the statements of 4.1.6 Unless otherwise a special operating condition is specified in the follows during the testing.



**8.1.6 TEST RESULTS**

EUT :	BT Cradle	Model Name :	3656
Temperature :	23.5 °C	Relative Humidity :	75 %
Test Voltage :	AC 120V/60Hz		
Test Mode :	CH00 / CH39 / CH78		

Frequency	20dB Bandwidth (MHz)	Channel Separation (MHz)	Result
2402 MHz	0.952	<= 1MHz	<b>PASS</b>
2441 MHz	0.952	<= 1MHz	<b>PASS</b>
2480 MHz	0.944	<= 1MHz	<b>PASS</b>

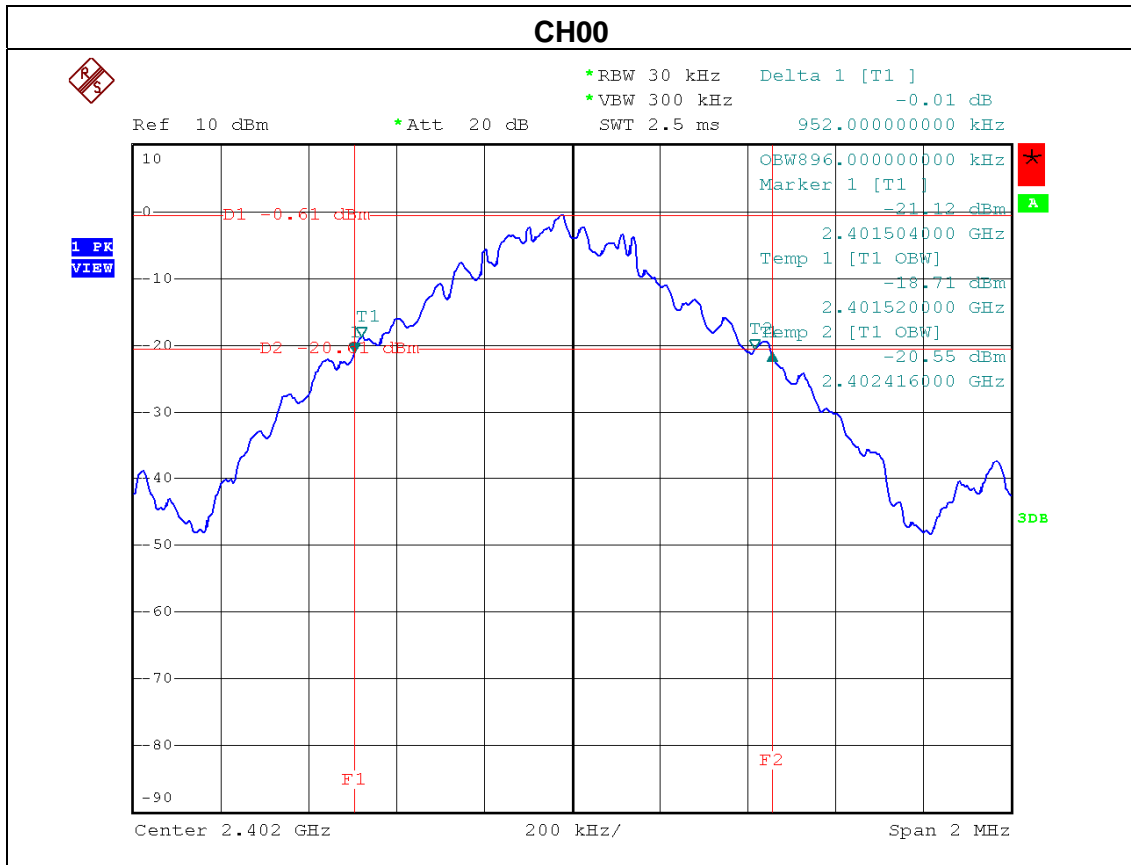

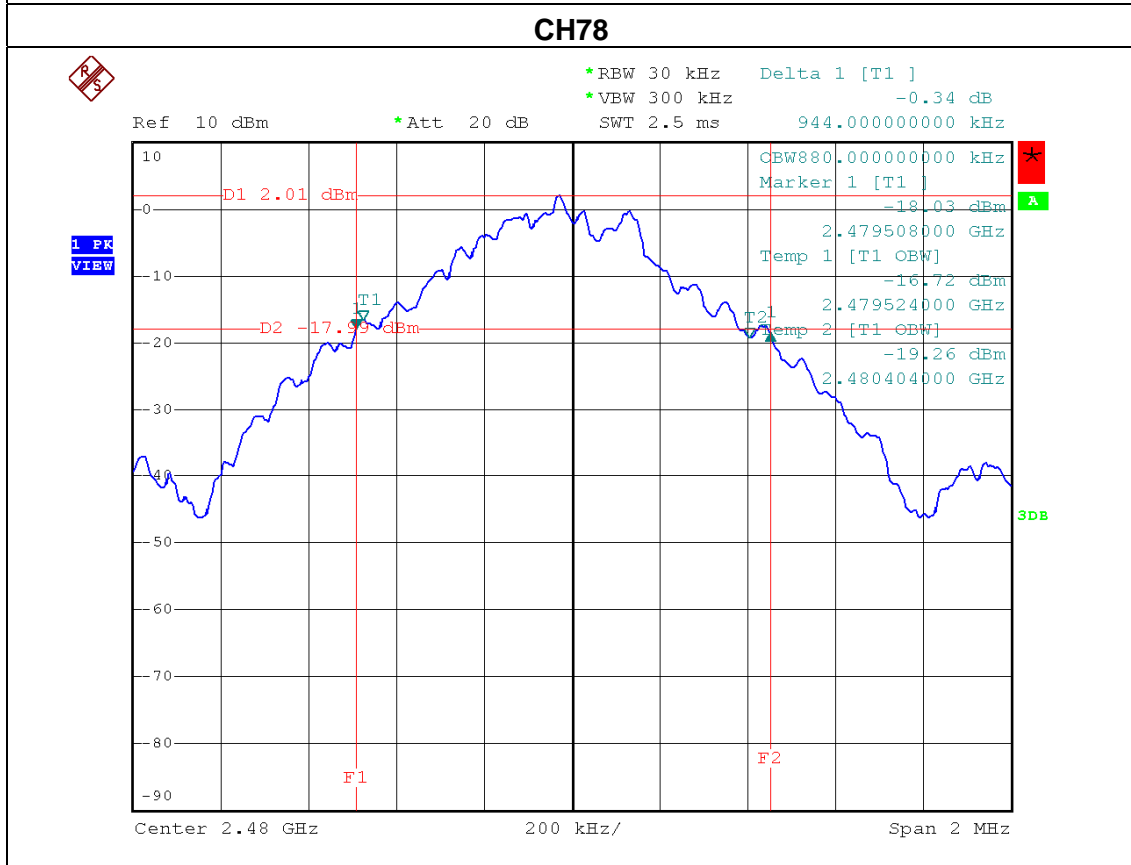
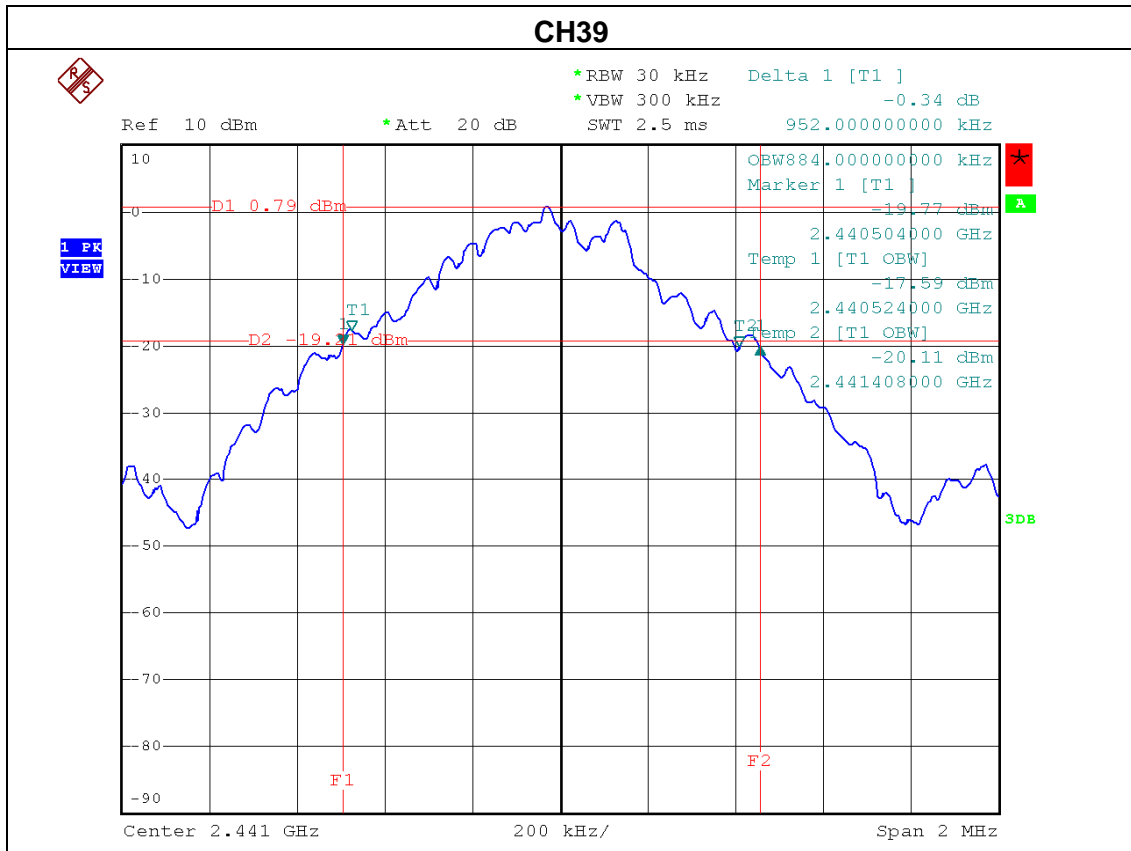





**9. PEAK OUTPUT POWER TEST**

**9.1 APPLIED PROCEDURES / LIMIT**

FCC Part15 (15.247) , Subpart C				
Section	Test Item	Limit	Frequency Range (MHz)	Result
15.247 (b)(1)	Peak Output Power	1 watt or 30dBm	2400-2483.5	PASS

**9.1.1 MEASUREMENT INSTRUMENTS LIST AND SETTING**

Item	Kind of Equipment	Manufacturer	Type No.	Serial No.	Calibrated until
1	Spectrum Analyzer	R&S	FSP-40	100129	Sep. 09, 2010

Remark: " N/A" denotes No Model Name , Serial No. or No Calibration specified.

**9.1.2 TEST PROCEDURE**

- a. The EUT was directly connected to the spectrum analyzer and antenna output port as show in the block diagram below,
- b. Spectrum Setting : RBW= 3MHz, VBW= 3MHz, Sweep time = Auto.

**9.1.3 DEVIATION FROM STANDARD**

No deviation.

**9.1.4 TEST SETUP**

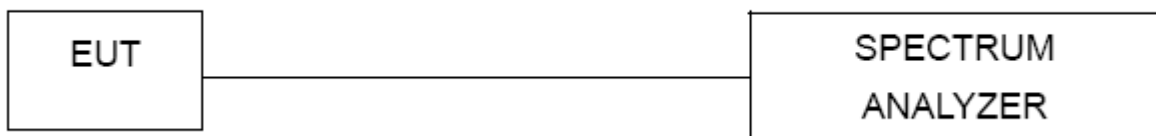

**9.1.5 EUT OPERATION CONDITIONS**

The EUT tested system was configured as the statements of 4.1.6 Unless otherwise a special operating condition is specified in the follows during the testing.



**9.1.6 TEST RESULTS**

EUT :	BT Cradle	Model Name :	3656
Temperature :	23.5 °C	Relative Humidity :	75 %
Test Voltage :	AC 120V/60Hz		
Test Mode :	CH00 / CH39 / CH78		

Frequency (MHz)	Peak Output Power (dBm)	LIMIT (dBm)	LIMIT (W)
2402	0.23	30	1
2441	1.13	30	1
2480	2.22	30	1

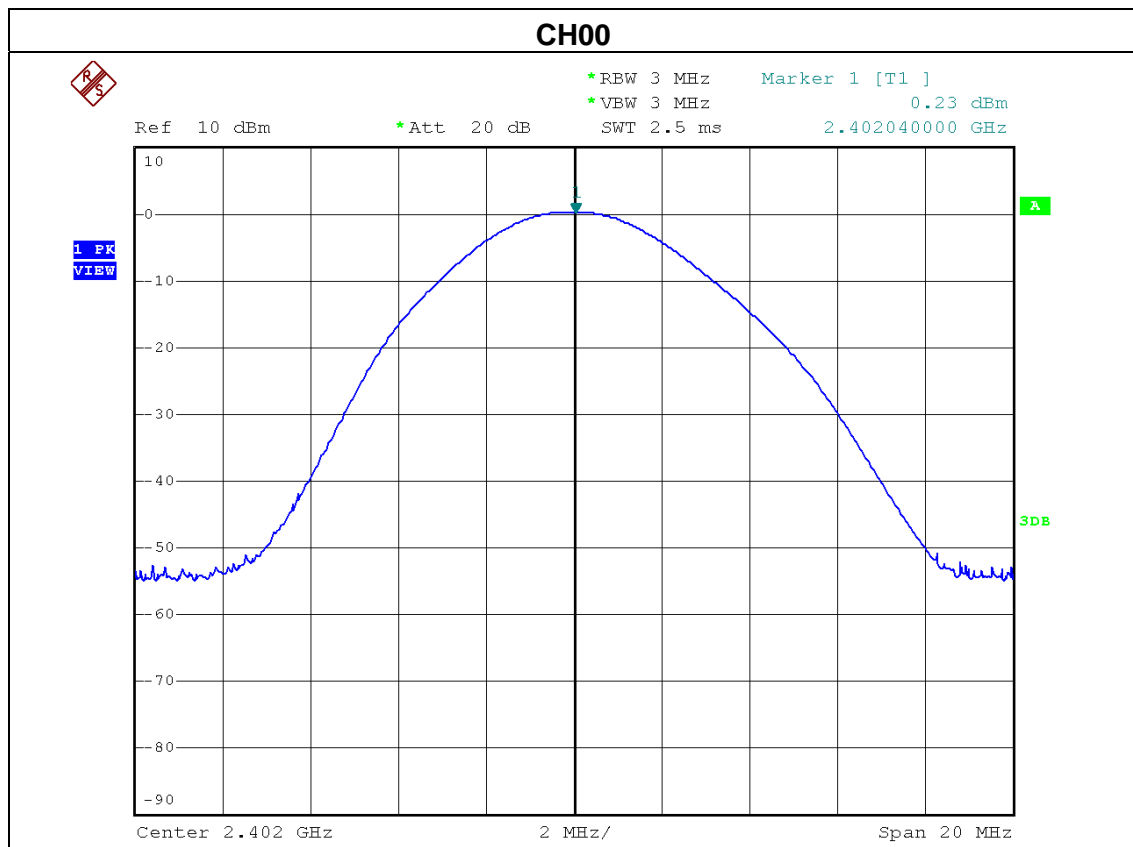

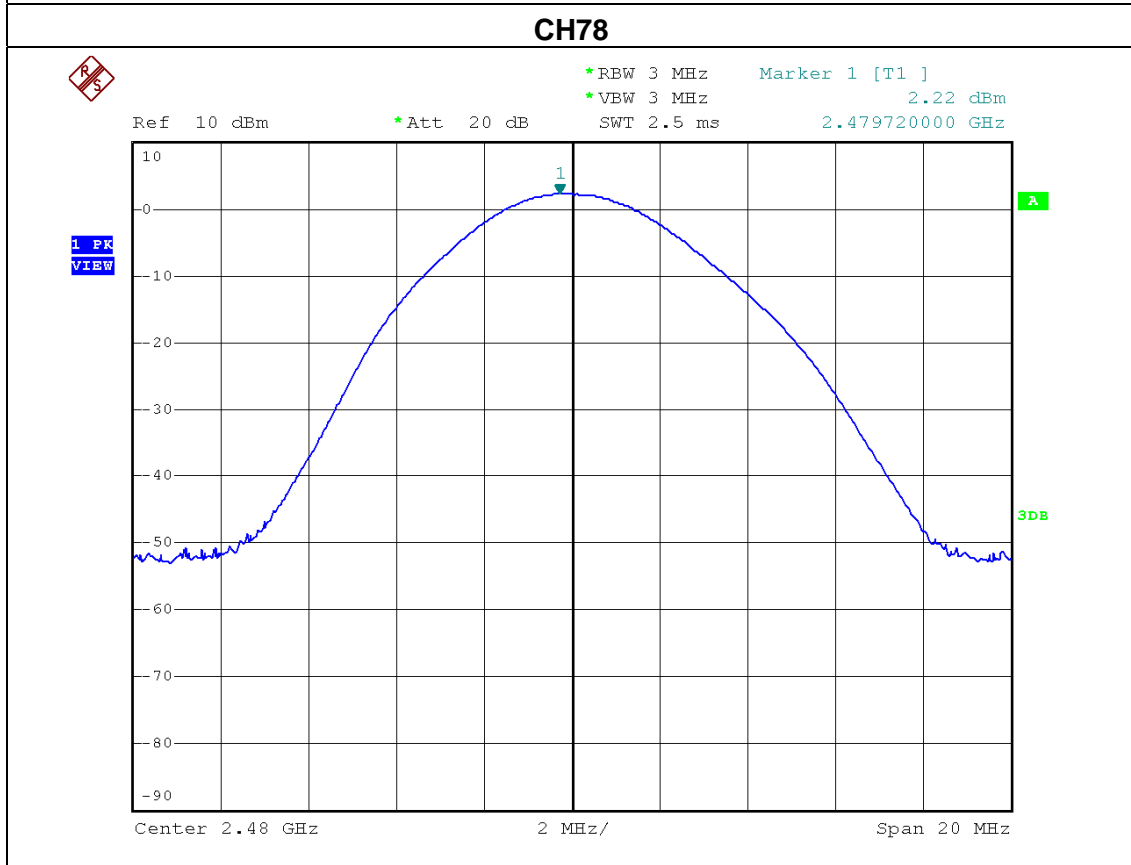
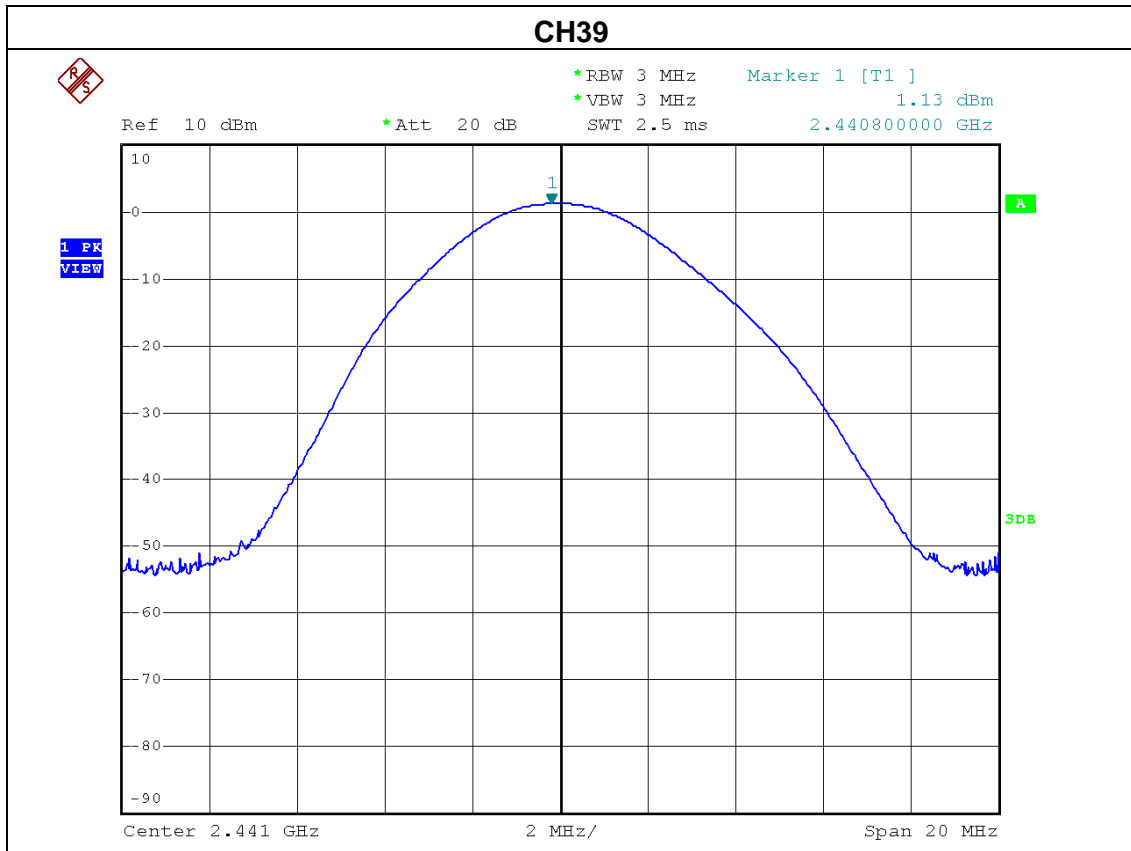



**10. ANTENNA CONDUCTED SPURIOUS EMISSION**

**10.1 APPLIED PROCEDURES / LIMIT**

20dBc in any 100 kHz bandwidth outside the operating frequency band. In case the emission fall within the restricted band specified on 15.205(a), then the 15.209(a) limit in the table below has to be followed.

Frequencies (MHz)	Field Strength (micorvolts/meter)	Measurement Distance (meters)
0.009~0.490	2400/F(KHz)	300
0.490~1.705	24000/F(KHz)	30
1.705~30.0	30	30
30~88	100	3
88~216	150	3
216~960	200	3
Above 960	500	3

**10.1.1 MEASUREMENT INSTRUMENTS LIST AND SETTING**

Item	Kind of Equipment	Manufacturer	Type No.	Serial No.	Calibrated until
1	Spectrum Analyzer	R&S	FSP-40	100129	Sep. 09, 2010

Remark: " N/A" denotes No Model Name , Serial No. or No Calibration specified.

The following table is the setting of the spectrum analyzer.

Spectrum Parameter	Setting
Attenuation	Auto
Span Frequency	100 MHz
RB / VB (emission in restricted band)	1MHz / 1MHz for Peak, 1 MHz / 10Hz for Average
RB / VB (other emission)	100 KHz /100 KHz for Peak

**10.1.2 TEST PROCEDURE**

- a. The EUT was directly connected to the spectrum analyzer and antenna output port as show in the block diagram below,
- b. Spectrum Setting : RBW= 100KHz, VBW=100KHz, Sweep time = Auto.

**10.1.3 DEVIATION FROM STANDARD**

No deviation.



#### **10.1.4 TEST SETUP**



#### **10.1.5 EUT OPERATION CONDITIONS**

The EUT tested system was configured as the statements of 4.1.6 Unless otherwise a special operating condition is specified in the follows during the testing.



**10.1.6 TEST RESULTS**

EUT :	BT Cradle	Model Name :	3656
Temperature :	25 °C	Relative Humidity :	68 %
Test Voltage :	AC 120V/60Hz		
Test Mode :	CH00 / CH39 / CH78		

The max. radio frequency power in any 100kHz bandwidth outside the frequency band		The max. radio frequency power in any 100 kHz bandwidth within the frequency band.	
FREQUENCY(MHz)	POWER(dBm)	FREQUENCY(MHz)	POWER(dBm)
2385.992	-56.29	2484.001	-43.03

**Result**

In any 100kHz bandwidth outside the frequency band, the radio frequency power is at least 20dB below that in the 100kHz bandwidth within the band that contains the highest level of the desired power.



CH00 (Lower)

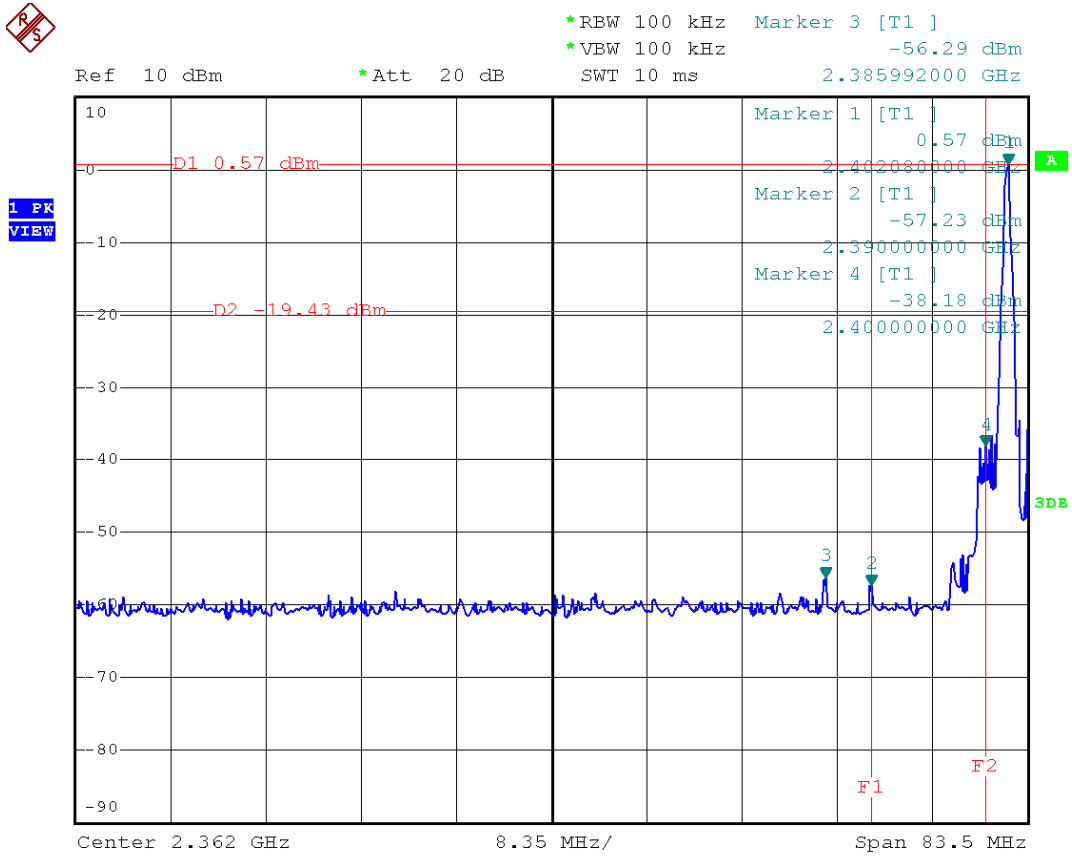

CH 78 (Upper)

