

CipherLab User Guide

1560/1562 BT Barcode Scanner

Setup labels included.

Version 1.01



Copyright © 2009 CIPHERLAB CO., LTD.
All rights reserved

The software contains proprietary information of CIPHERLAB CO., LTD.; it is provided under a license agreement containing restrictions on use and disclosure and is also protected by copyright law. Reverse engineering of the software is prohibited.

Due to continued product development this information may change without notice. The information and intellectual property contained herein is confidential between CIPHERLAB and the client and remains the exclusive property of CIPHERLAB CO., LTD. If you find any problems in the documentation, please report them to us in writing. CIPHERLAB does not warrant that this document is error-free.

No part of this publication may be reproduced, stored in a retrieval system, or transmitted in any form or by any means, electronic, mechanical, photocopying, recording or otherwise without the prior written permission of CIPHERLAB CO., LTD.

For product consultancy and technical support, please contact your local sales representative. Also, you may visit our web site for more information.

The CipherLab logo is a registered trademark of CIPHERLAB CO., LTD.

All brand, product and service, and trademark names are the property of their registered owners.

The editorial use of these names is for identification as well as to the benefit of the owners, with no intention of infringement.

CIPHERLAB CO., LTD.

Website: <http://www.cipherlab.com>

IMPORTANT NOTICES

FOR USA

This equipment has been tested and found to comply with the limits for a **Class B** digital device, pursuant to Part 15 of the FCC Rules. These limits are designed to provide reasonable protection against harmful interference in a residential installation. This equipment generates, uses and can radiate radio frequency energy and, if not installed and used in accordance with the instructions, may cause harmful interference to radio communications. However, there is no guarantee that interference will not occur in a particular installation. If this equipment does cause harmful interference to radio or television reception, which can be determined by turning the equipment off and on, the user is encouraged to try to correct the interference by one or more of the following measures:

- ▶ Reorient or relocate the receiving antenna.
- ▶ Increase the separation between the equipment and receiver.
- ▶ Connect the equipment into an outlet on a circuit different from that to which the receiver is connected.
- ▶ Consult the dealer or an experienced radio/TV technician for help.

This device complies with Part 15 of the FCC Rules. Operation is subject to the following two conditions: (1) This device may not cause harmful interference, and (2) this device must accept any interference received, including interference that may cause undesired operation.

FOR CANADA

This digital apparatus does not exceed the Class B limits for radio noise emissions from digital apparatus as set out in the interference-causing equipment standard entitled "Digital Apparatus," ICES-003 of Industry Canada. This device complies with Part 15 of the FCC Rules. Operation is subject to the following two conditions: (1) This device may not cause harmful interference, and (2) this device must accept any interference received, including interference that may cause undesired operation.

Cet appareil numérique respecte les limites de bruits radioélectriques applicables aux appareils numériques de Classe B prescrites dans la norme sur le matériel brouilleur: "Appareils Numériques," NMB-003 édictée par l'Industrie.

FOR HAND-HELD PRODUCT WITH RF FUNCTIONS

The 1560/1562 unit (FCC ID: Q3N-1560) complies with FCC radiation exposure limits set forth for uncontrolled environment and meets the FCC radio frequency (RF) Exposure Guidelines in Supplement C to OET65. The 1560 unit has very low level of RF energy that it is deemed to comply without testing of specific absorption ratio (SAR).

The 3656 unit (FCC ID: Q3N-3656) complies with FCC radiation exposure limits set forth for an uncontrolled environment. This equipment should be installed and operated with minimum distance 20 cm between the radiator & your body. It only operated in hand-held used. If you only transfer data to Host wirelessly, please keep the minimum distance 20 cm between machine & your body.

FOR PRODUCT WITH LASER

Per FDA and IEC standards, the scan engines described in this manual are not given a laser classification. However, the following precautions should be observed:



CAUTION

This laser component emits FDA / IEC Class 2 laser light at the exit port. Do not stare into beam.

SAFETY PRECAUTIONS

RISK OF EXPLOSION IF BATTERY IS REPLACED BY AN INCORRECT TYPE. DISPOSE OF USED BATTERIES ACCORDING TO THE INSTRUCTIONS.

- ▶ The use of any batteries or charging devices, which are not originally sold or manufactured by CipherLab, will void your warranty and may cause damage to human body or the product itself.
- ▶ DO NOT disassemble, incinerate or short circuit the battery.
- ▶ DO NOT expose the scanner or the battery to any flammable sources.
- ▶ For green-environment issue, it's important that batteries should be recycled in a proper way.
- ▶ Under no circumstances, internal components are self-serviceable.
- ▶ The charging and communication cradle uses an AC power adaptor. A socket outlet shall be installed near the equipment and shall be easily accessible. Make sure there is stable power supply for the mobile computer or its peripherals to operate properly.

CARE & MAINTENANCE

- ▶ Use a clean cloth to wipe dust off the scanning window and the body of the scanner as well as the cradle. DO NOT use/mix any bleach or cleaner.
- ▶ If you want to put away the scanner for a period of time, download the collected data to a host computer when in the memory mode, and then take out the battery. Store the scanner and battery separately.
- ▶ When the scanner resumes its work, make sure the battery is fully charged before use.
- ▶ If you shall find the scanner malfunctioning, write down the specific scenario and consult your local sales representative.

RELEASE NOTES

Version	Date	Notes
1.01	June 3, 2009	<ul style="list-style-type: none">▶ Modified: 1.10 Auto-Sense Mode — Power supply cord is required.▶ Modified: Appendix II Host Serial Commands
1.00	Apr. 29, 2009	Initial release

CONTENTS

- IMPORTANT NOTICES - 3 -**
 - For USA - 3 -
 - For Canada - 3 -
 - For Hand-held Product with RF Functions - 3 -
 - For Product with Laser - 4 -
 - Safety Precautions - 4 -
 - Care & Maintenance - 4 -

- RELEASE NOTES - 5 -**

- INTRODUCTION 1**
 - Getting Familiarized with 1560/1562 and 3656 2
 - Installing the Battery to 1560/1562 2
 - Setting up 3656 3
 - Charging the Battery via 3656 5
 - Inside the Package 6
 - Product Highlights 6

- QUICK START 7**
 - Enter Configuration Mode 9
 - Exit Configuration Mode 9
 - Default Settings 10
 - Save User Settings as Defaults 10
 - Restore User Defaults 10
 - Restore System Defaults 10
 - Read a Setup Label 11
 - Configure Parameters 11
 - List the Current Settings 15

- UNDERSTANDING THE BARCODE SCANNER 17**
 - 1.1 Battery 17
 - 1.1.1 How to Operate the Scanner 17
 - 1.1.2 Auto Power Off 18
 - 1.2 Memory 19
 - 1.2.1 Transmit Buffer 19
 - 1.2.2 Memory Mode 20
 - 1.3 LED Indicator 22
 - 1.3.1 Good Read LED 23
 - 1.3.2 Good Read LED Duration 23
 - 1.4 Beeper 24
 - 1.4.1 Beeper Volume 25
 - 1.4.2 Good Read Beep 26
 - 1.4.3 Low Battery Alarm 27
 - 1.5 Send “NR” to Host 28

1.6 Scan Modes	29
1.6.1 Continuous Mode	30
1.6.2 Test Mode	31
1.6.3 Laser Mode	31
1.6.4 Auto Off Mode	31
1.6.5 Auto Power Off Mode	32
1.6.6 Aiming Mode	32
1.6.7 Multi-Barcode Mode	33
1.6.8 Alternate Mode	33
1.7 Scanning Timeout	34
1.8 Delay between Re-read	35
1.9 Effective Decoding Area	36
1.9.1 Positioning Window	36
1.9.2 Adjusting Window	36
1.10 Auto-Sense Mode (1560 Only)	38
1.11 CCD Sensor Always Active (1560 Only)	39
1.12 Negative Barcodes	39
1.13 Symbologies Supported	40
1.13.1 Read Redundancy for All Symbologies	41
1.13.2 Addon Security for UPC/EAN Barcodes	42
SELECTING OUTPUT INTERFACE	43
2.1 BT HID	44
2.1.1 Activate BT HID & Select Keyboard Type	44
2.1.2 Reset Connection	45
2.1.3 Keyboard Settings	46
2.1.4 Inter-Function Delay	50
2.2 BT SPP	51
2.2.1 Activate BT SPP	51
2.2.2 Inter-Function Delay	51
2.2.3 ACK/NAK Timeout	52
2.3 Keyboard Wedge via 3656	53
2.3.1 Activate Keyboard Wedge & Select Keyboard Type	53
2.3.2 Keyboard Settings	54
2.3.3 Inter-Character Delay	60
2.3.4 Inter-Function Delay	60
2.4 RS-232 via 3656	61
2.4.1 Activate RS-232 Interface	61
2.4.2 Baud Rate	61
2.4.3 Data Bits	62
2.4.4 Parity	62
2.4.5 Stop Bit	63
2.4.6 Flow Control	63
2.4.7 Inter-Character Delay	64
2.4.8 Inter-Function Delay	64
2.4.9 ACK/NAK Timeout	65
2.5 USB HID via 3656	66
2.5.1 Activate USB HID & Select Keyboard Type	66
2.5.2 Keyboard Settings	68
2.5.3 Inter-Function Delay	72

2.6 USB Virtual COM via 3656	73
2.6.1 Activate USB Virtual COM	73
2.6.2 Inter-Function Delay	73
2.6.3 ACK/NAK Timeout	74
SETTING UP A WPAN CONNECTION	75
3.1 Connecting via 3656	76
3.1.1 Connect to 3656	76
3.1.2 Change Interface	77
3.2 Connecting via <i>Bluetooth</i> [®] Dongle	78
3.2.1 Change Interface	78
3.2.2 Configure Related Settings	79
3.2.3 Connect to Dongle	82
CHANGING SYMBOLOGY SETTINGS	89
4.1 Codabar	90
4.1.1 Start/Stop Characters Selection	90
4.1.2 Start/Stop Transmission	91
4.1.3 CLSI Conversion	91
4.2 Code 25 - Industrial 25	92
4.2.1 Start/Stop Pattern Selection	92
4.2.2 Checksum Verification	93
4.2.3 Checksum Transmission	93
4.2.4 Code Length Qualification	94
4.3 Code 25 - Interleaved 25	95
4.3.1 Start/Stop Pattern Selection	95
4.3.2 Checksum Verification	96
4.3.3 Checksum Transmission	96
4.3.4 Code Length Qualification	97
4.4 Code 25 - Matrix 25	98
4.4.1 Start/Stop Pattern Selection	98
4.4.2 Checksum Verification	99
4.4.3 Checksum Transmission	99
4.4.4 Code Length Qualification	100
4.5 Code 39	101
4.5.1 Start/Stop Transmission	101
4.5.2 Checksum Verification	101
4.5.3 Checksum Transmission	102
4.5.4 Standard/Full ASCII Code 39	102
4.6 Code 93	103
4.7 Code 128	103
4.8 EAN-8	104
4.8.1 Convert to EAN-13	105
4.8.2 Checksum Transmission	105
4.9 EAN-13	106
4.9.1 ISBN Conversion	107
4.9.2 ISSN Conversion	107
4.9.3 Checksum Transmission	107
4.10 GS1-128 (EAN-128)	108
4.10.1 Code ID Transmission	108

4.10.2 Field Separator (GS Character).....	108
4.11 ISBT 128.....	109
4.12 MSI.....	110
4.12.1 Checksum Verification.....	110
4.12.2 Checksum Transmission.....	111
4.12.3 Code Length Qualification.....	112
4.13 French Pharmacode.....	113
4.13.1 Checksum Transmission.....	113
4.14 Italian Pharmacode.....	114
4.14.1 Checksum Transmission.....	114
4.15 Plessey.....	115
4.15.1 Convert to UK Plessey.....	115
4.15.2 Checksum Transmission.....	115
4.16 GS1 DataBar (RSS Family).....	116
4.16.1 Code ID Selection.....	116
4.16.2 GS1 DataBar Omnidirectional (RSS-14).....	116
4.16.3 GS1 DataBar Expanded (RSS Expanded).....	117
4.16.4 GS1 DataBar Limited (RSS Limited).....	118
4.17 Telepen.....	120
4.17.1 Telepen Output – Full ASCII/Numeric.....	120
4.18 UPC-A.....	121
4.18.1 Convert to EAN-13.....	122
4.18.2 System Number Transmission.....	122
4.18.3 Checksum Transmission.....	122
4.19 UPC-E.....	123
4.19.1 System Number Selection.....	124
4.19.2 Convert to UPC-A.....	124
4.19.3 System Number Transmission.....	125
4.19.4 Checksum Transmission.....	125
DEFINING OUTPUT FORMAT.....	127
5.1 Letter Case.....	127
5.2 Character Substitution.....	128
5.2.1 Select a Set for Character Substitution.....	128
5.2.2 Symbolologies for Character Substitution (All 3 Sets).....	129
5.3 Prefix/Suffix Code.....	134
5.4 Code ID.....	135
5.4.1 Select Pre-defined Code ID.....	135
5.4.2 Change Code ID.....	136
5.4.3 Clear Code ID Settings.....	138
5.5 Length Code.....	139
5.6 Multi-Barcode Editor.....	142
5.6.1 Edit a Concatenation of Barcodes.....	143
5.6.2 Activate the Concatenation of Barcodes.....	144
5.7 Removal of Special Character.....	145
APPLYING FORMATS FOR DATA EDITING.....	147
6.1 Format Selection.....	148

6.1.1 Activate Editing Formats.....	148
6.1.2 Exclusive Data Editing.....	149
6.2 Editing Format.....	150
6.2.1 Select Format to Configure.....	151
6.2.2 Restore Default Format.....	152
6.2.3 Define Data Criteria.....	153
6.2.4 Divide Data into Fields.....	156
6.2.5 Field Settings.....	158
6.2.6 Field Transmission Sequence.....	164
6.3 Programming Examples.....	166
6.3.1 Example I.....	166
6.3.2 Example II.....	167
SPECIFICATIONS.....	169
FIRMWARE UPGRADE.....	171
How to Upgrade 1560/1562 Firmware.....	171
Using 3656.....	171
Using a Generic Dongle.....	173
How to Upgrade 3656 Firmware.....	175
Upgrading 3656 CPU Firmware.....	175
Upgrading 3656 USB Bridge Firmware.....	177
HOST SERIAL COMMANDS.....	179
1560/1562 Serial Commands.....	179
Example.....	180
3656 Serial Commands.....	181
Example.....	184
KEYBOARD WEDGE TABLE.....	185
Key Type.....	185
Key Status.....	186
User-defined Scan Code.....	186
NUMERAL SYSTEMS.....	187
Decimal System.....	187
Hexadecimal System.....	188
ASCII Table.....	189
Entering PIN Code for Authentication.....	190
Use Preset PIN.....	190
Disable Authentication or Use Random PIN.....	191

INTRODUCTION

CipherLab's 1560 Series Barcode Scanners are specifically designed to answer your mobile demands. The versatile scanners are designed to help accelerate productivity while lowering the total cost of ownership. Intensive data collection jobs are made easier with fast, accurate barcode scanning in various working environments, especially in small businesses. Integrating short-distance wireless technology to small-form-factor scanners, the 1560/1562 scanners are ideal for carrying around, and thus give workers tether-free mobility anytime anywhere and get job done more efficiently. This line of scanners deliver data over a wireless personal network at a range of up to 90 meters and a prolonged battery life to keep business running.

Owing to the slim, ergonomic design, extremely low power consumption, and powerful decoding capability, the 1560 Series Barcode Scanners are the best choice for the following applications –

- ▶ Receiving in Retail
- ▶ Product labeling & Tracking
- ▶ Shelf Product Replenishment
- ▶ Mobile Point of Sale (POS)
- ▶ Mobile Inventory Management
- ▶ Order Picking & Staging
- ▶ Work-In-Process Tracking
- ▶ Material Flow Control
- ▶ Transportation & Distribution
- ▶ Warehousing
- ▶ Asset Management

This manual contains information on operating the scanner and using its features. We recommend you to keep one copy of the manual at hand for quick reference or maintenance purposes. To avoid any improper disposal or operation, please read the manual thoroughly before use.

Thank you for choosing CipherLab products!



GETTING FAMILIARIZED WITH 1560/1562 AND 3656

INSTALLING THE BATTERY TO 1560/1562

When you first receive the package, the rechargeable battery is stored separately from the scanner. Insert the battery into the scanner first so that it can be charged when sitting in the Auto-Sense stand.

Note: Any improper handling may reduce the battery life.

- 1) Hold the scanner still and insert the battery into the battery compartment at the bottom of the scanner.
- 2) Slide the battery latch to lock the battery in the compartment.
- 3) Hold down the trigger about 2 seconds to turn on the scanner.

The scanner will respond with a long beep and its LED will come on and off shortly.

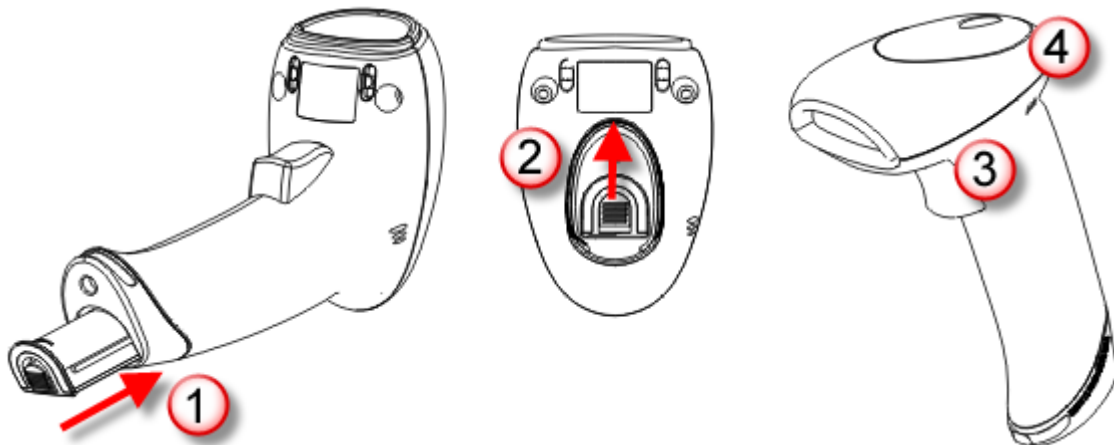

Note: (1) To turn off the scanner, remove the battery. Refer to settings of "[Auto Power Off](#)".

(2) For shipping and storage purposes, save the scanner and the battery separately. This will keep the battery in good condition for future use.

(3) When the battery charge becomes low, you will find the scanner cannot emit scan beam and its power-on beep sounds differently.



SETTING UP 3656

Capable of charging 1560/1562, the 3656 stand is specifically designed for the scanner to communicate with a host computer wirelessly. The connection between the scanners and 3656 is made easy and reliable. Refer to [3.1.1 Connect to 3656](#). The 3656 stand is also an Auto-Sense stand when used with the scanner set to Auto-Sense mode.

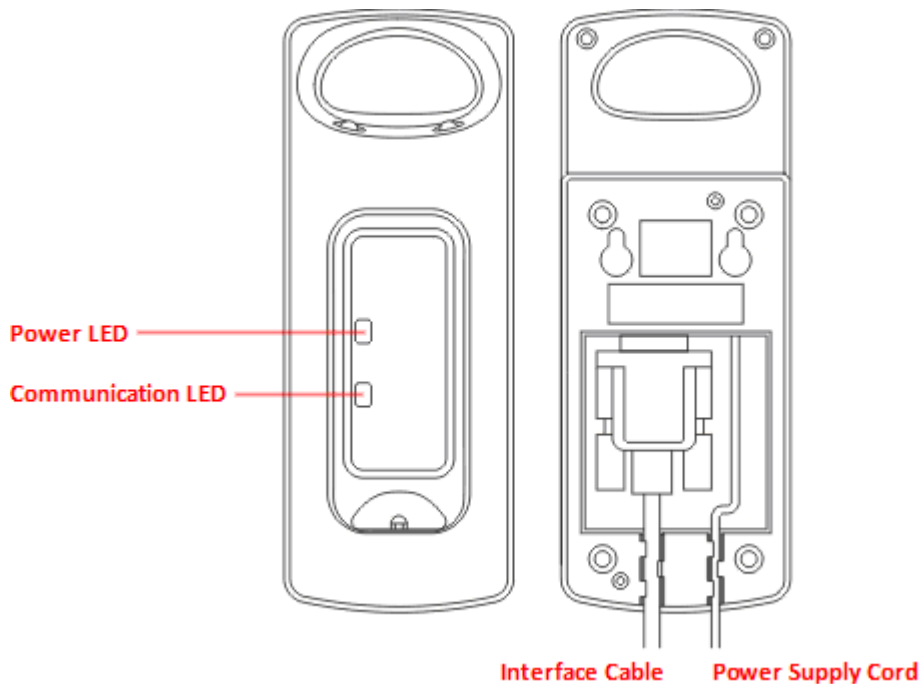

Two LED indicators are provided for communications status and battery charging status.

Power LED		Meaning
Red, solid		Power ON
---		Power OFF
Communication LED		Meaning
---	Blue, solid	Initialize
Red, solid	---	Failed to establish a USB connection
Red, solid	Blue, flashing	Serial command mode with USB Virtual COM or RS-232: wait 3 seconds for starting a serial command
Red, flashing	Blue, flashing	Serial command mode with USB HID: wait 3 seconds for pressing [NumLock] or [CapsLock] 5 times via keyboard
---	Blue, flashing	Wait for connection request from the scanner (Slow flash at 0.5 Hz)



---	Blue, flashing	Connected with the scanner (Fast flash at 1 Hz)
Red, solid	Blue, flashing	Failed to send data to host via USB Virtual COM (Fast flash at 1 Hz)
Red, flashing	---	Enter Download Mode



CHARGING THE BATTERY VIA 3656

The battery may not be charged to full for shipment. When you first receive the package, you will need to charge the battery to full before using the scanner.

Note: It takes approximately 3 hours to charge the battery to full (from the power adaptor). If the two pivot bolts are not tightened properly, charging error may occur.

- 1) Install the battery to the scanner.
- 2) Seat the scanner in the 3656 stand.
- 3) Connect the 3656 stand to your computer or notebook via the USB or RS-232 cable.
If using the RS-232 cable, it is necessary to connect the power supply cord.
- 4) The LED for power indication on 3656 will become solid red.
- 5) The scanner LED will be flashing red during charging. When the charging is done, the LED will turn off. When charging error occurs, the LED will turn solid red.
- 6) The LED for communications on 3656 will first become solid blue while initializing. Refer to the table above for details on different stage of communications.

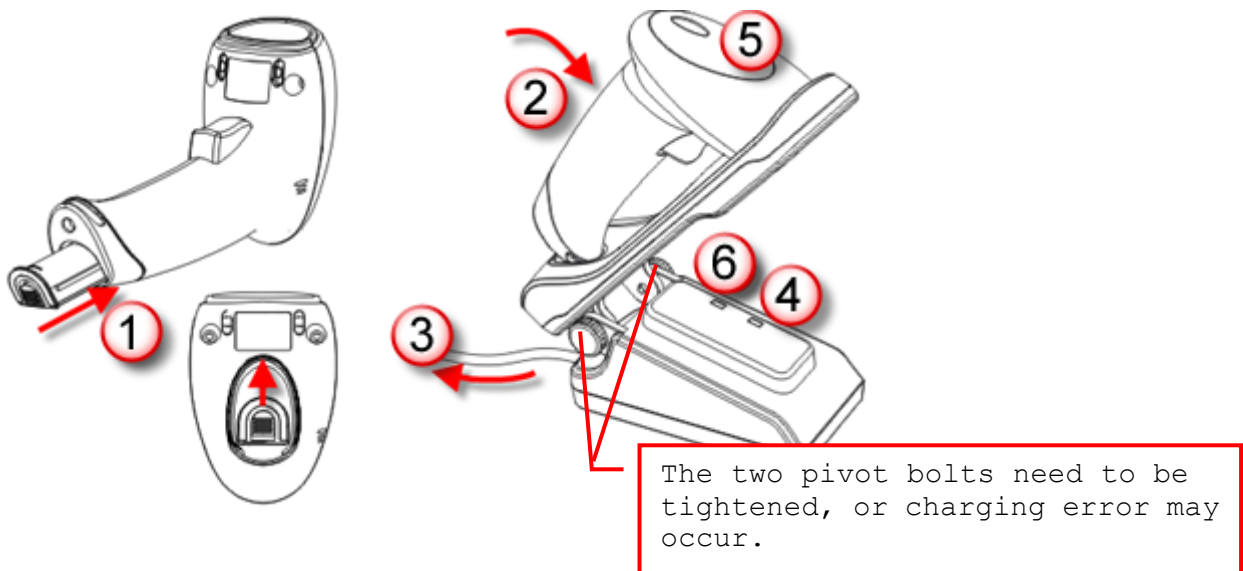

Warning: It is recommended that the charging devices be operated at room temperature (18°C to 25°C) for optimal performance. The charging devices will not charge the battery when the temperature exceeds 40°C.



INSIDE THE PACKAGE

The items included in the package may be different, depending on your order. Save the box and packaging material for future use in case you need to store or ship the scanner.

- ▶ Barcode Scanner (1560 or 1562)
- ▶ BT Base (3656)
- ▶ Rechargeable Li-ion battery
- ▶ Product CD

Note: The CD-ROM includes this manual and Windows-based *ScanMaster* software for configuration.

PRODUCT HIGHLIGHTS

- ▶ Small-form-factor and built tough to survive drop test
- ▶ Extremely low power consumption
- ▶ Firmware upgradeable
- ▶ Supports most popular barcode symbologies, including GS1-128 (EAN-128), GS1 DataBar (RSS), etc.
- ▶ Supports negative barcodes
- ▶ Supports different scan modes, including Aiming Mode and Multi-Barcode Mode
- ▶ User feedback via LED indicator and beeper
- ▶ Beeping tone and duration programmable for Good Read
- ▶ 512 KB flash memory for Memory Mode operation, storing up to 32,768 scans based on EAN-13 barcodes
- ▶ Provides up to 4 KB SRAM for reserve buffer while getting out of range over a wireless personal area network (WPAN), storing up to 256 scans based on EAN-13 barcodes
- ▶ Capable of transmitting scanned data, emulating a serial cable (BT SPP) or as keyboard input (BT HID), to a notebook computer or PDA with *Bluetooth*® wireless technology
- ▶ Programmable parameters include data output format, editing format, symbologies, etc.



QUICK START

The configuration of the scanner can be done by reading the setup labels contained in this manual or via the *ScanMaster* software. This section describes the procedure of configuring the scanner by reading the setup barcodes and provides some examples for demonstration.

Configuration Mode

1. Hold down the trigger about 2 seconds to turn on the scanner. It will respond with a long beep and its LED will come on and off shortly.
2. Have the scanner read the "Enter Setup" label. It will respond with six beeps and its LED indicator will become flashing red after reading the label.
3. Have the scanner read more setup barcodes... Most of the setup barcodes are normal labels. The scanner will respond with two beeps (low-high tone). For special labels, it requires reading more than one setup barcode to complete the setting.
4. Have the scanner read the "Update" or "Abort" label. It will respond with six beeps and its LED indicator will become flashing red after reading the label.
5. The scanner will restart automatically upon reading the "Update" or "Abort" label. It will respond with a long beep and its LED will come on and off shortly.



Note: Refer to [Appendix II Host Serial Commands](#) for how to configure the 3656 stand by having the scanner read 3656-related setup labels or using serial commands.



Update

Working Mode

Upon powering up, the 1560/1562 scanner will try to establish a connection with 3656 or a computer with *Bluetooth*[®] wireless technology. Refer to [Chapter 3 – Setting up a WPAN Connection](#) for details. The connection between the scanners and 3656 is made easy and reliable.

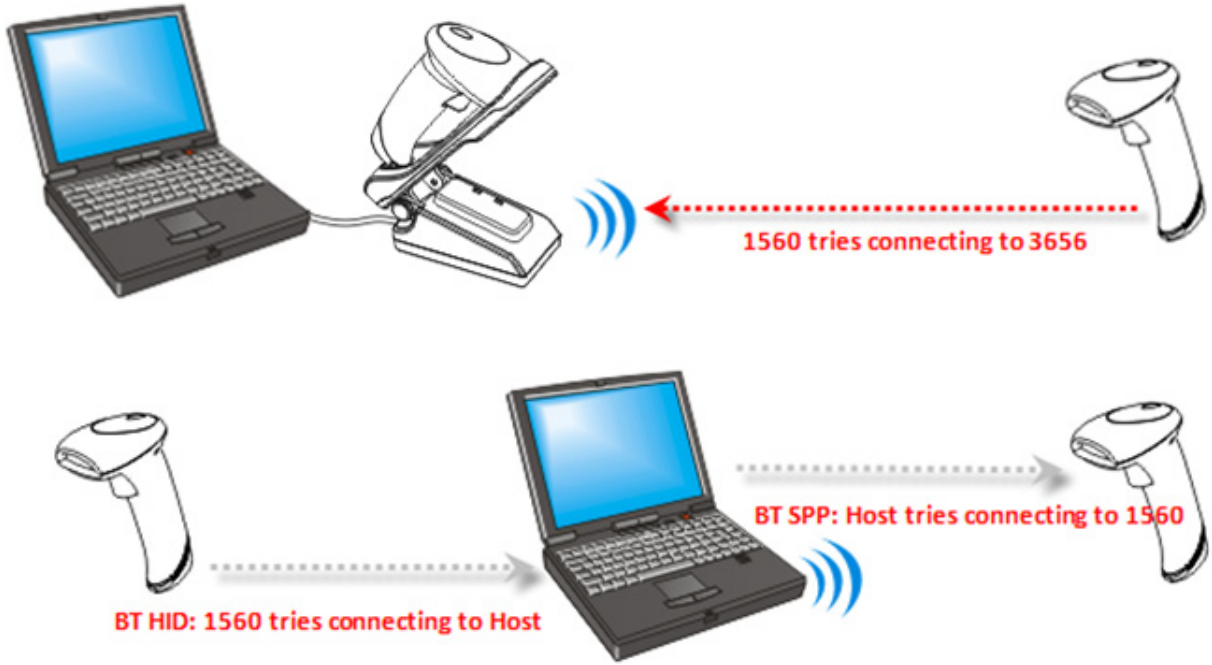

Note: If RS-232, USB Virtual COM or BT SPP is selected for output interface, the host can directly send serial commands to configure the scanner. For example, run HyperTerminal.exe and type the 6-digit command located under each setup label. Refer to [Appendix II Host Serial Commands](#).



ENTER CONFIGURATION MODE

For the scanner to enter the configuration mode, you must have it read the "Enter Setup" label, which can be located at the bottom of almost every even page of this manual.

- ▶ The scanner will respond with six beeps and its LED indicator will become flashing red after reading the label.



For configuring scanner parameters, see "Read a Setup Label" below.

EXIT CONFIGURATION MODE

For the scanner to exit the configuration mode, you must have it read the "Update" label, which can be located at the bottom of almost every odd page of this manual. If you want to exit the configuration mode without saving any changes, have the scanner read the "Abort" label instead.

- ▶ Just like reading the "Enter Setup" label, the scanner will respond with six beeps and its LED indicator will become flashing red after reading the label. Wait for a few seconds for the scanner to restart itself.



Update

DEFAULT SETTINGS

SAVE USER SETTINGS AS DEFAULTS

For the scanner to keep the customized settings as user defaults, you must have it read the "Save as User Defaults" label. This is a normal label, and the scanner will respond with two beeps (low-high tone).

- ▶ After reading the "Update" label, the current settings will be saved as user defaults.



RESTORE USER DEFAULTS

For the scanner to restore the user defaults, which you have saved earlier, you must have it read the "Restore User Defaults" label. This is a normal label, and the scanner will respond with two beeps (low-high tone).

- ▶ After reading the "Update" label, all the parameters of the scanner will return to their customized values.



RESTORE SYSTEM DEFAULTS

For the scanner to restore the factory defaults, you must have it read the "Restore System Defaults" label. This is a normal label, and the scanner will respond with two beeps (low-high tone).

- ▶ After reading the "Update" label, all the parameters of the scanner will return to their default values. The current connection record will be cleared as well.



Note: The system default value (if there is) for each setting is indicated by an asterisk "*".



READ A SETUP LABEL

CONFIGURE PARAMETERS

For most of the scanner parameters, only one read is required to set them to new values. The scanner will respond with two beeps when each parameter is set successfully.



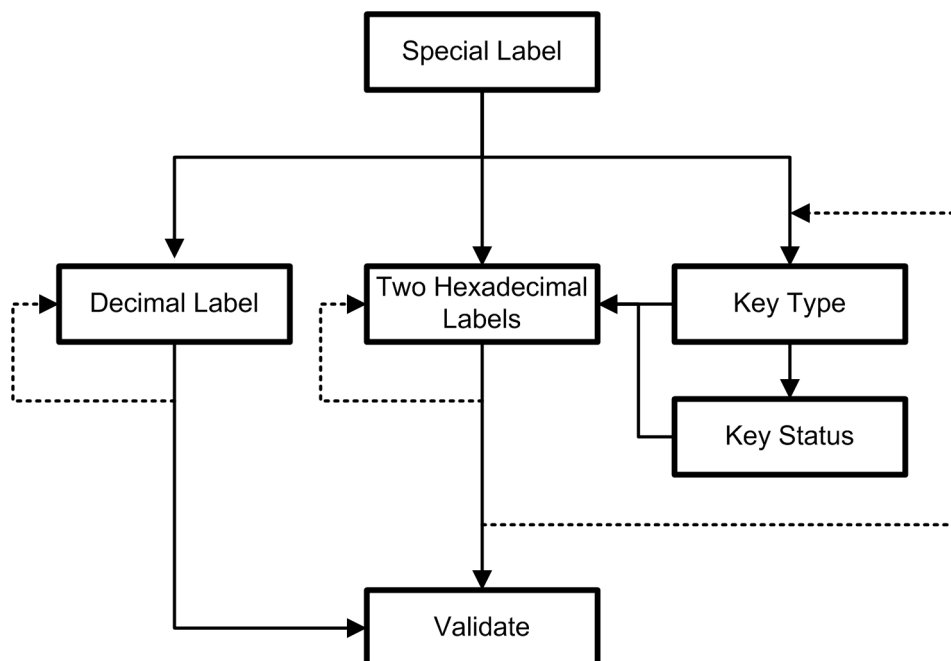

But for a number of special parameters, multiple reads are required to complete the setting. In this case, the scanner will respond with a short beep to indicate it needs to read more setup labels. These special parameters may require reading one or more setup labels, such as

- ▶ Numeric labels, say, for keyboard type, inter-character delay, length qualification
- ▶ Hexadecimal labels, say, for character strings as prefix, suffix, etc.
- ▶ When "BT HID", "USB HID" or "Keyboard Wedge" is configured for interface, Key Type and Key Status will then become applicable. You may decide whether or not to change key status when "Normal Key" is selected for Key Type.

To complete the configuration of these special parameters, it requires reading the "Validate" label, and the scanner will respond with two beeps (low-high tone) to indicate the input values are validated.









The example below shows how to save your settings as "User Default" so that you may restore user defaults at a later time:

Steps	Action	User Feedback if Successful
1	Power on the scanner...	The scanner will respond with a long beep (high tone) and its LED indicator will become solid red and go off quickly.
2	Enter the Configuration Mode... <div style="text-align: center;"> <p data-bbox="496 524 647 551">Enter Setup</p>  </div>	The scanner will respond with six beeps (high-low tone repeats three times), and its LED indicator will be flashing red.
3	Read a Setup label... For example, <div style="text-align: center;"> <p data-bbox="432 730 711 757">*Enable Industrial 25</p>  <p data-bbox="544 828 600 855">100307</p> <p data-bbox="432 873 703 900">Save as User Default</p>  <p data-bbox="536 972 600 999">109986</p> </div>	The scanner will respond with two beeps (low-high tone) if reading a normal label.
4	Exit the Configuration Mode... <div style="text-align: center;"> <p data-bbox="384 1048 472 1075">Update</p>  <p data-bbox="400 1146 464 1173">109989</p> <p data-bbox="544 1146 584 1173">OR</p> <p data-bbox="679 1048 751 1075">Abort</p>  <p data-bbox="687 1146 751 1173">109998</p> </div>	Same as for <i>Enter the Configuration Mode</i> .
5	The scanner will automatically restart itself...	Same as for <i>Power on the scanner</i> .
*	When any configuration error occurs...	The scanner will respond with one long beep (low tone).









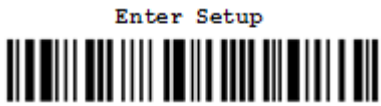

The example below shows how to set numeric parameters:

Steps	Action	User Feedback if Successful
1	Power on the scanner...	The scanner will respond with a long beep (high tone) and its LED indicator will become solid red and go off quickly.
2	Enter the Configuration Mode...	The scanner will respond with six beeps (high-low tone repeats three times), and its LED indicator will become flashing red.
3	Read a Setup label... For example,	The scanner will respond with two beeps (low-high tone) if reading a normal label.
<div style="border: 1px solid red; padding: 2px; display: inline-block;">Normal label</div>	<p style="text-align: center;">*Enable Interleaved 25</p>  <p style="text-align: center;">100309</p>	
	<div style="border: 1px solid red; padding: 2px; display: inline-block;">Normal label</div>	<p style="text-align: center;">Enable Fixed Length(s) ...</p>  <p style="text-align: center;">100604</p>
<div style="border: 1px solid red; padding: 2px; display: inline-block;">Special label</div>		<p style="text-align: center;">Max. Length (*126) Or Fixed Length 1</p>  <p style="text-align: center;">100606</p>
	<div style="border: 1px solid red; padding: 2px; display: inline-block;">Decimal label or labels</div>	<p style="text-align: center;">1</p>  <p style="text-align: center;">109901</p>
<p style="text-align: center;">5</p>  <p style="text-align: center;">109905</p>		
<p style="text-align: center;">Validate</p>  <p style="text-align: center;">109994</p>		The scanner will respond with two beeps (low-high tone) when the input values are validated.
4	Exit the Configuration Mode...	Same as for <i>Enter the Configuration Mode.</i>
5	The scanner will automatically restart itself...	Same as for <i>Power on the scanner.</i>



The example below shows how to set string parameters:

Steps	Action	User Feedback if Successful
1	Power on the scanner...	The scanner will respond with a long beep (high tone) and its LED indicator will become solid red and go off quickly.
2	Enter the Configuration Mode... 	The scanner will respond with six beeps (high-low tone repeats three times), and its LED indicator will become flashing red.
3	Read a Setup label... For example,	The scanner will respond with one short beep if reading a special label such as "Prefix Code", indicating the setup requires reading more labels.
	<div style="border: 1px solid red; padding: 2px; display: inline-block; margin-right: 10px;">Special label</div>   	<p>When "BT HID", "USB HID" or "Keyboard Wedge" is configured for interface, Key Type and Key Status will then become applicable. You may decide whether or not to change key status when "Normal Key" is selected for Key Type.</p> <p>▶ Refer to Appendix III</p>
	<div style="border: 1px solid red; padding: 2px; display: inline-block; margin-right: 10px;">Hexadecimal labels</div>   	<p>Read the "Hexadecimal Value" labels for the desired character string. For example, read "2" and "B" for the scanner to prefix the character "+".</p> <p>▶ Refer to Appendix IV "Hexadecimal System"</p>
4	Exit the Configuration Mode...  OR 	Same as for <i>Enter the Configuration Mode</i> .
5	The scanner will automatically restart itself...	Same as for <i>Power on the scanner</i> .



LIST THE CURRENT SETTINGS

The current settings of all scanner parameters can be sent to the host computer for user inspection. The listing includes ten pages as shown below. You can select the page of interest by having the scanner read the "List Page x" label. The scanner will respond with two beeps (low-high tone) and send the selected page to the host immediately.

List Page 1



109950

List settings regarding Firmware Version, Serial Number, Interface, Buzzer, and Other Scanner Parameters

List Page 2



109951

List settings regarding Prefix, Postfix, and Length Code Setting

List Page 3



109952

List settings regarding Code ID

List Page 4



109953

List settings regarding: Readable Symbologies

List Page 5



109954

List settings regarding Symbology Parameters (1/3)

List Page 6



109955

List settings regarding Symbology Parameters (2/3)

List Page 7



109956

List settings regarding Symbology Parameters (3/3)



List Page 8



109957

List settings regarding Editing Format 1

List Page 9



109958

List settings regarding Editing Format 2

List Page 10



109959

List settings regarding Editing Format 3

List Page 11



109937

List settings regarding Editing Format 4

List Page 12



109938

List settings regarding Editing Format 5



Enter Setup

UNDERSTANDING THE BARCODE SCANNER

This chapter explains the features and usage of the barcode scanner.

IN THIS CHAPTER

1.1 Battery.....	17
1.2 Memory.....	19
1.3 LED Indicator.....	22
1.4 Beeper.....	24
1.5 Send "NR" to Host.....	28
1.6 Scan Modes.....	29
1.7 Scanner Time-out.....	34
1.8 Delay between Re-read.....	35
1.9 Effective Decoding Area.....	36
1.10 Auto-Sense Mode (1560 Only).....	38
1.11 CCD Sensor Always Active (1560 Only).....	39
1.12 Negative Barcodes.....	39
1.13 Symbologies Supported.....	40

1.1 BATTERY

The scanner is powered by a rechargeable 3.7 V/800 mAh Li-ion battery, and it takes approximately 3 hours to charge the battery to full (from the power adaptor). However, the charging time may vary by working condition. For intensive data collection, you may purchase a spare battery for non-stop operation.

Note: The scanner can be configured to save battery power. Refer to settings of "[Auto Power Off](#)", "[CCD Sensor Always Active](#)", "[Sniff Mode](#)", as well as "[Low Battery Alarm](#)".

1.1.1 HOW TO OPERATE THE SCANNER

Turn on the scanner...

After installing the battery, hold down the trigger for about 2 seconds. The scanner will respond with a long beep (high tone), and its LED will become solid red and go off quickly.

Turn off the scanner...

Remove the battery directly or let it turn off automatically in specific circumstances.



1.1.2 AUTO POWER OFF

Specify the time interval (1~254 min.; 0= Disable) for the scanner to automatically turn off in the following circumstances. By default, it is set to 10 minutes. If this feature is not desired, set it to 0.

Auto Power Off before establishing a WPAN connection successfully...

1. The scanner will stay active for 2 minutes for the following scenarios. Its CPU is running at full speed, and the LED is flashing blue (On/Off ratio 0.5 s: 0.5 s).
 - (a) waiting for a connection request from the host (BT SPP)
 - (b) trying to connect to the host (BT HID)
 - (c) trying to connect to 3656
2. If it fails to connect within 2 minutes, the scanner will become inactive to save power for the remaining period of time (the specified value minus 2 minutes). Its CPU is running at low speed, and the LED is flashing red (On/Off ratio 0.3 s: 2.5 s).

Press the trigger to wake up the scanner when it becomes inactive, and the scanner will stay active for 2 minutes again.

3. If it fails to connect again and again, and finally stays inactive until the specified time interval has elapsed, the scanner will automatically turn off in order to conserve battery power.

Hold down the trigger for about 2 seconds to turn it on. For scenarios (a) and (b) in step 1, on your computer you will have to search for the scanner again.

Auto Power Off after establishing a WPAN connection successfully...

Once a WPAN connection is established successfully, the LED is flashing blue (On/Off ratio 0.02 s: 3 s). If the scanner is idle during the specified time interval for Auto Power Off, it will automatically turn off when the time is up. You will hear three short beeps, tone descending from high to low. For BT HID or SPP, there is no transition from full CPU speed to low CPU speed. However, when connecting with 3656, the scanner will go through the transition in order to save power.

- ▶ For BT HID, the scanner will resume connection with the host upon powering on again, as long as the host application is running. You will hear three short beeps, tone ascending from low to high. If the scanner fails to resume connection, it will try every 5 seconds to re-connect to the host unless you have the scanner read the "Reset Connection" label.
- ▶ For BT SPP, the scanner must wait for the host to re-connect.
- ▶ With the use of 3656, the scanner will try re-connecting to 3656 unless you turn off the scanner.

Auto Off after 0~254 minutes (*10)



101000

- 1) Read the label above to specify the time interval before the scanner automatically turns off.
- 2) Read the "[Decimal Value](#)" label on page 187. For example, read "1" and "5" for the scanner to automatically turn off after being idle for 15 minutes.
- 3) Read the "Validate" label on the same page to complete this setting.



1.2 MEMORY

The collected data can be sent back to a host computer one by one via the WPAN connection or stored in flash memory when the scanner is set to Memory mode.

1.2.1 TRANSMIT BUFFER

By default, transmit buffer is enabled and for use when the scanner is out of range. Upon reading a barcode successfully within range, the scanner responds with one short beep (high tone) and its LED indicator becomes solid green and goes off quickly. However, the host computer may not receive the data immediately if getting out of range. With the 4 KB transmit buffer, the scanner can ignore the transmission status and keep on reading barcodes until the buffer is full.

- ▶ When transmit buffer is enabled and the scanner is out of range, the scanner will respond with two short beeps, high-low tone, upon reading a barcode successfully.

When transmit buffer is full, the scanner will respond with one long beep (low tone) and its LED indicator will become solid red and go off quickly. You are advised to get back to range.

- ▶ When transmit buffer is disabled and the scanner is out of range, the scanner will respond with one long beep (low tone) and its LED indicator will become solid red and go off quickly. You are advised to get back to range.

Enable Transmit Buffer*



Disable Transmit Buffer



Note: The 4 KB transmit buffer on the scanner can hold as many as 256 scans based on EAN-13 barcodes. Data will be cleared out once the scanner is turned off or running out of battery power!



1.2.2 MEMORY MODE

The scanner keeps 512 KB flash memory for memory mode operation. When the scanner is in memory mode, it means a WPAN connection is disabled.

Enable Memory Mode



*Disable Memory Mode



Warning: No WPAN connection is allowed unless the memory mode is disabled.

Memory Data Delay

You may set a delay between each data record while transmitting data back to the server.

*None



250 ms



500 ms



1 sec



2 sec





Send Data

The 512 KB flash memory on the scanner can store up to 32,768 scans based on EAN-13 barcodes. When it is used up, the scanner will respond with two short beeps (high-low tone) as a warning. You are advised to send data to the server immediately by having the scanner read the label below.



Clear Data & Confirm

Even though data has been sent back to the server, the flash memory is still occupied unless you erase the memory by having the scanner read two labels – "Clear Data" and "Confirm".

1. Read the "Clear Data" label to clear the flash memory.
2. Read the "Confirm" label to confirm the action.



1.3 LED INDICATOR

The triple-color LED on top of the scanner is used to provide user feedback. For example, the LED becomes solid red and goes off quickly upon powering on or running out of transmit buffer. You may tell the difference by the beeps – you will hear a long beep of high tone when powering on the scanner, and a long beep of low tone when the transmit buffer becomes full.

Scanner LED			Meaning
Red, flashing			Charging (On/Off ratio 0.5 s: 0.5 s)
Red, solid			Charging error
Red, on-off			<ul style="list-style-type: none"> ▶ Power on, with one long beep (high tone, LED on for 1 second) ▶ Data saved to buffer when transmit buffer is enabled and the scanner is out of range, with two short beeps (high-low tone) ▶ Transmit buffer full, with one long beep (low tone) ▶ Transmit buffer disabled, with one long beep (low tone) ▶ Memory full in memory mode, with two short beeps (high-low tone)
		Green, on-off	Good Read, with one short beep (high tone) and beeper pitch and duration programmable
	Blue, flashing		<p>First, flashing blue (On/Off ratio 0.5 s: 0.5 s) for two minutes indicates the scanner is waiting for connection, and goes off if no connection is established, then flashing red (On/Off ratio 0.3 s: 2.5 s) indicates the scanner is inactive.</p> <p>It is ready for connection only while the LED is flashing blue —</p> <ul style="list-style-type: none"> ▶ SPP: waiting host to connect ▶ HID: trying to connect to host ▶ Using 3656: trying to connect to 3656
Red, flashing			<p>Flashing red (On/Off ratio 0.3 s: 2.5 s) indicates the scanner is inactive and its CPU running at low speed to save power —</p> <ul style="list-style-type: none"> ▶ No WPAN connection is established after waiting for two minutes
	Blue, flashing		Flashing blue (On/Off ratio 0.1 s: 0.1 s) indicates the scanner receives a PIN code request from host (flashing more quickly than waiting connection).
	Blue, flashing		Flashing blue (On/Off ratio 0.02 s: 3 s) indicates the scanner has established a WPAN connection successfully.
	Blue, flashing	Green, flashing	Flashing blue and green (On/Off ratio 0.1 s: 0.1 s) indicates an error occurs while entering the PIN code. Press the trigger to get ready for re-connecting.
Red, flashing			Configuration Mode (On/Off ratio 0.5 s: 0.5 s)



1.3.1 GOOD READ LED

*Enable Good Read LED



Disable Good Read LED



1.3.2 GOOD READ LED DURATION

By default, the Good Read LED stays on for 40 milliseconds. Specify a value, ranging from 1 to 254 in units of 10 milliseconds.

Good Read LED Time-Out after
0.01~2.54 seconds (*40 ms)



- 1) Read the label above to specify the time interval before the Good Read LED goes off.
- 2) Read the "[Decimal Value](#)" label on page 187. For example, read "1" and "5" for the Good Read LED to go off after 150 milliseconds.
- 3) Read the "Validate" label on the same page to complete this setting.



1.4 BEEPER

The scanner has a buzzer to provide user feedback in various operating conditions.

Beeping	Meaning
One long beep, high tone	Power on, with red LED on (1 second) and off quickly
One short beep, high tone (programmable, default to 4 KHz)	Good Read, with green LED on and off quickly
Six short beeps, high-low tone repeats three times	<ul style="list-style-type: none"> ▶ Enter Configuration Mode, with red LED flashing ▶ Exit Configuration Mode
Two short beeps, low-high tone	Setup label read successfully
One short beep, high tone	<ul style="list-style-type: none"> ▶ More setup label required ▶ Input PIN code ▶ Clear PIN code
One short beep, low tone	More barcodes required to complete the "output sequence" requirements of Multi-Barcode Editor, with green LED on and off quickly (Upon completion, same as Good Read.)
One long beep, low tone	<ul style="list-style-type: none"> ▶ Transmit buffer full, with red LED on and off quickly ▶ Transmit buffer disabled, with red LED on and off quickly ▶ Configuration error (Wrong label...) ▶ PIN code input error ▶ Reject random PIN request ▶ Fail to send data in memory mode
Two short beeps, high-low tone	<ul style="list-style-type: none"> ▶ Data saved to buffer when transmit buffer is enabled and the scanner is out of range, with red LED on and off quickly ▶ Memory Mode – Memory full, with red LED on and off quickly
Two long beeps, high-low tone	Multi-Barcode Mode – Buffer full
Three short beeps, tone ascending from low to high	<ul style="list-style-type: none"> ▶ WPAN connection established, with blue LED flashing ▶ WPAN connection resumed, with blue LED flashing
Three short beeps, tone ascending from high to low	WPAN connection out of range or suspended



1.4.1 BEEPER VOLUME



1.4.2 GOOD READ BEEP

Frequency



Duration



1.4.3 LOW BATTERY ALARM

By default, it will activate the beeper to give a warning when the battery charge gets low.



1.5 SEND "NR" TO HOST

The scanner can send the "NR" string to the host to notify the No Read event.



1.6 SCAN MODES

Different scan modes are supported – select the scan mode that best suits the requirements of a specific application. Refer to the comparison table below.

Scan Mode	Start to Scan				Stop Scanning			
	<i>Always</i>	<i>Press trigger once</i>	<i>Hold trigger</i>	<i>Press trigger twice</i>	<i>Release trigger</i>	<i>Press trigger once</i>	<i>Barcode being read</i>	<i>Timeout</i>
Continuous mode	✓							
Test mode	✓							
Laser mode			✓		✓		✓	✓
Auto Off mode		✓					✓	✓
Auto Power Off mode		✓						✓
Aiming mode				✓			✓	✓
Multi-Barcode mode			✓		✓			
Alternate mode		✓				✓		

Note: By default, the scan mode is set to Laser mode.



1.6.1 CONTINUOUS MODE

The scanner is always scanning.

- ▶ After a successful decoding, the removal of barcode is required. It is not allowed to proceed to decode until the decoding delay time has passed.
- ▶ To decode the same barcode repeatedly, move away the barcode and put it back again and again for scanning.

Note: Refer to "Delay between Re-read".



Decoding Delay

Set the time interval between each decoding.



1.6.2 TEST MODE

The scanner is always scanning.

- ▶ Capable of decoding the same barcode repeatedly without removing it, for testing purpose.



1.6.3 LASER MODE

The scanner will start scanning once the trigger is hold down.

- ▶ The scanning won't stop until (1) a barcode is decoded, (2) the pre-set timeout expires, or (3) you release the trigger.

Note: Refer to "Scanning Timeout".



1.6.4 AUTO OFF MODE

The scanner will start scanning once the trigger is pressed.

- ▶ The scanning won't stop until (1) a barcode is decoded, and (2) the pre-set timeout expires.

Note: Refer to "Scanning Timeout".



1.6.5 AUTO POWER OFF MODE

The scanner will start scanning once the trigger is pressed.

- ▶ The scanning won't stop until the pre-set timeout expires, and, the pre-set timeout period re-counts after each successful decoding.

Note: Refer to "Delay between Re-read" and "Scanning Timeout".

Auto Power Off Mode



100202

1.6.6 AIMING MODE

The scanner will aim at a barcode once the trigger is pressed, and start scanning when the trigger is pressed again within one second.

- ▶ The scanning won't stop until (1) a barcode is decoded, and (2) the pre-set timeout expires.

Aiming Mode



100208

Aiming Timeout

You can limit the aiming time interval (1~15). By default, the scanner time-out is set to 1 second.

Aiming Time-Out after 1~15 seconds (*1)



100226

1. Read the label above to specify the time interval before aiming ends. (It is set to 1 by default.)
2. Read the "[Decimal Value](#)" label on page 187. For example, read "1" and "0" for the scanner to automatically shut down after being idle for 10 seconds.
3. Read the "Validate" label on the same page to complete this setting.



1.6.7 MULTI-BARCODE MODE

The scanner will be scanning as long as the trigger is held down, capable of decoding not only one single barcode but a concatenation of unique barcodes.

- ▶ The scanning won't stop until you release the trigger.



Note: (1) A barcode is considered unique when its Code Type or data is different from others.
(2) Multi-Barcode Mode has nothing to do with the [Multi-Barcode Editor](#).

1.6.8 ALTERNATE MODE

The scanner will start scanning once the trigger is pressed

- ▶ The scanning won't stop until you press the trigger again.



1.7 SCANNING TIMEOUT

Specify the scanning time interval (1~254 sec.; 0= Disable) when the scan mode is set to any of the following –

- ▶ Laser mode
- ▶ Auto Off mode
- ▶ Auto Power Off mode
- ▶ Aiming mode

Scanner Time-Out after 0~254 seconds (*10)



- 1) Read the label above to specify the time interval before the scan engine times out.
- 2) Read the "[Decimal Value](#)" label on page 187. For example, read "1" and "5" for the scanner to automatically shut down after being idle for 15 seconds.
- 3) Read the "Validate" label on the same page to complete this setting.



1.8 DELAY BETWEEN RE-READ

This is also referred to as the “Blocking Time”, which is used to prevent the scanner from accidentally reading the same barcode twice when the scan mode is set to any of the following –

- ▶ Continuous mode
- ▶ Auto Power Off mode
- ▶ Alternate mode



1.9 EFFECTIVE DECODING AREA

By default, the effective decoding area is 100% covered by the scanned area. However, you may narrow down the decoding area to prevent reading the wrong barcode when a number of barcodes are printed closely. The scanner will only read barcodes that appear in the effective decoding area.

Read the label "Centering On" and specify the percentage to narrow down the decoding area. For example, read "Left 10%" and then "Right 30%" for the scanner to decode barcode "A" only.

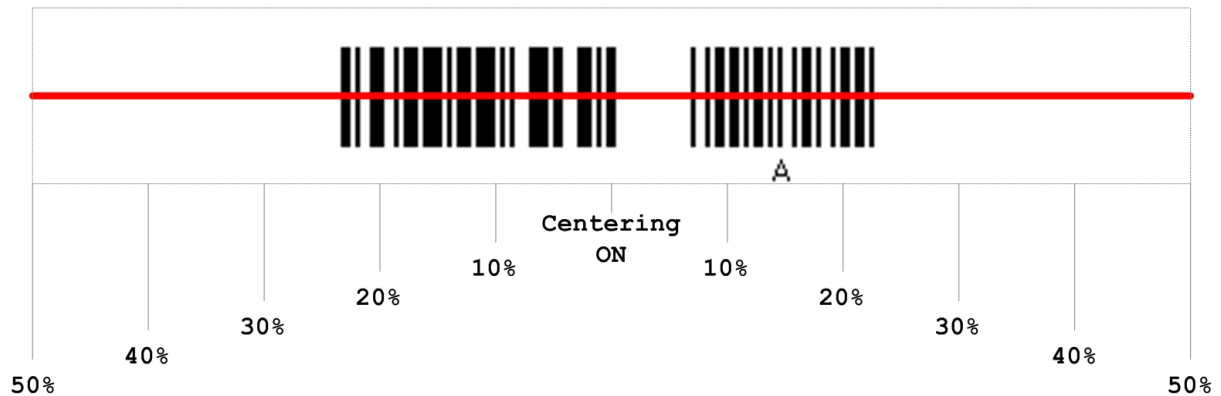

1.9.1 POSITIONING WINDOW



1.9.2 ADJUSTING WINDOW

Percentage for Left Half





Percentage for Right Half



1.10 AUTO-SENSE MODE (1560 ONLY)

This mode is only available when you want to seat the scanner in the Auto-Sense Stand. When you enable this mode, it will force the scanner to apply Laser mode as the scan mode. However, it works differently from the original Laser mode. Now the scanner will be scanning as long as it is seated in the Auto-Sense Stand, as shown below. Whenever a barcode is brought within range, the scanner will be able to decode it.

Warning: When you disable this mode later, the scan mode remains unchanged. If Laser mode is not desired, proceed to select a scan mode best suits your application.

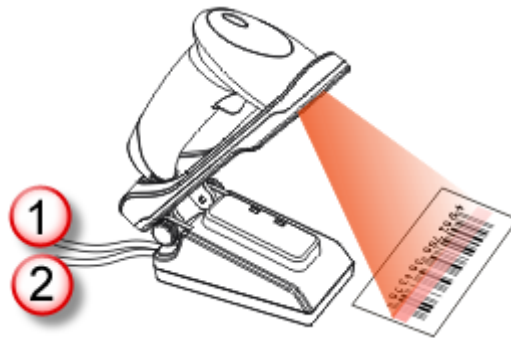

Note: For Auto-Sense mode to work, you must connect (1) the power supply cord and (2) the interface cable to the Auto-Sense Stand. USB power is insufficient.



When the ambient light is too dim to activate the sensor, you may have the scanner read the "High Sensitivity" label to improve performance.



1.11 CCD SENSOR ALWAYS ACTIVE (1560 ONLY)

This feature is used to keep the CCD sensor always active so that the scanner can decode more efficiently. However, you may disable it in order to save battery power.



1.12 NEGATIVE BARCODES

Normally, barcodes are printed with the color of the bars darker than that of the spaces. But for negative barcodes, they are printed in the opposite sense just like negative films. The spaces of negative barcodes are printed with a color darker than that of the bars. You can configure the scanner to be able to read negative barcodes.



1.13 SYMBOLOGIES SUPPORTED

Most of the popular barcode symbologies are supported, as listed below. Each can be individually enabled or disabled. The scanner will automatically discriminate and recognize all the symbologies that are enabled. Refer to [Chapter 4 Changing Symbology Settings](#) for details of each symbology.

Symbologies Supported: Enable/Disable		CCD Scan Engine
Codabar		Enabled
Code 93		Enabled
MSI		Disabled
Plessey		Disabled
Telepen		Disabled
Code 128	Code 128	Enabled
	GS1-128 (EAN-128)	Disabled
	ISBT-128	Disabled
Code 2 of 5	Industrial 25	Enabled
	Interleaved 25	Enabled
	Matrix 25	Disabled
Code 3 of 9	Code 39	Enabled
	Italian Pharmacode	Disabled
	French Pharmacode	Disabled
EAN/UPC	EAN-8	Enabled
	EAN-8 Addon 2	Disabled
	EAN-8 Addon 5	Disabled
	EAN-13	Enabled
	EAN-13 & UPC-A Addon 2	Disabled
	EAN-13 & UPC-A Addon 5	Disabled
	ISBN	Disabled
	UPC-E0	Enabled
	UPC-E1	Disabled
	UPC-E Addon 2	Disabled
	UPC-E Addon 5	Disabled
	UPC-A	Enabled
GS1 DataBar (RSS)	GS1 DataBar Omnidirectional (RSS-14)	Disabled
	GS1 DataBar Limited (RSS Limited)	Disabled
	GS1 DataBar Expanded (RSS Expanded)	Disabled



1.13.1 READ REDUNDANCY FOR ALL SYMBLOGIES

Select the level of reading security. For example,

- ▶ If "No Redundancy" is selected, one successful decoding will make the reading valid and induce the "READER Event".
- ▶ If "Three Times" is selected, it will take a total of four consecutive successful decodings of the same barcode to make the reading valid. The higher the reading security is (that is, the more redundancy the user selects), the slower the reading speed gets.

It is obvious that the more redundancy you select, the higher the reading security is, and thus, the slower the reading speed becomes. You will have to compromise between reading security and decoding speed.

*No Redundancy



100262

One Time



100263

Two Times



100264

Three Times



100265



1.13.2 ADDON SECURITY FOR UPC/EAN BARCODES

You may like to enforce read redundancy (0~30 times) on UPC/EAN barcodes with addons only.

Note: UPC/EAN Addon 2 and Addon 5 must be enabled individually for this setting to take effect.

Addon Security Level (*0 ~ 30)



- 1) Read the label above to specify the read redundancy when missing add-ons while scanning UPC/EAN barcodes. (It is set to 0 by default.)
- 2) Read the "[Decimal Value](#)" label on page 187. For example, read "1" and "2" for the scanner to re-read the barcode for 12 times.
- 3) Read the "Validate" label on the same page to complete this setting.



SELECTING OUTPUT INTERFACE

In order to establish a proper connection between your computer and the scanner, we suggest that you follow these instructions –

- 1) Install batteries and hold down the trigger for about 2 seconds to turn on the scanner.
- 2) Have the scanner read the “Enter Setup” label to enter the configuration mode.
- 3) Have the scanner read the associated label to activate the desired interface.
See the following sections for output interfaces supported.
- 4) Have the scanner read the labels for related settings.
- 5) Have the scanner read the “Update” label to exit the configuration mode.
- 6) Turn on your computer or laptop and establish a WPAN connection with the scanner.
Refer to [Chapter 3 – Setting up a WPAN Connection](#).

Note: By default, the output interface is set to “BT HID”.

IN THIS CHAPTER

2.1 BT HID	44
2.2 BT SPP	51
2.3 Keyboard Wedge via 3656	53
2.4 RS-232 via 3656.....	61
2.5 USB HID via 3656	66
2.6 USB Virtual COM via 3656.....	73



2.1 BT HID

For BT HID, refer to [Chapter 3 – Setting up a WPAN Connection](#) for related connection settings. Run any text editor on your computer, and the scanned data will be transmitted to the computer.

HID Settings	Defaults
Keyboard Type	PCAT (US)
Digits Layout	Normal
Capital Lock Type	Normal
Capital Lock State	Off
Alphabets Transmission	Case-sensitive
Digits Transmission	Alphanumeric keypad
Inter-Function Delay	0 (ms)
Send "NR" to Host	Disable

2.1.1 ACTIVATE BT HID & SELECT KEYBOARD TYPE

When BT HID interface is activated, you will have to select a keyboard type to complete this setting. By default, BT HID is activated on the scanner, and the keyboard type is set to PCAT (US).

Activate BT HID & Select Keyboard Type ...



- 1) Read the label above to activate BT HID and select a keyboard type.
- 2) Read the "Decimal Value" label on page 187. Refer to the table below for the number of desired keyboard type.
- 3) Read the "Validate" label on the same page to complete this setting.



BT HID

By default, the keyboard type is set to PCAT (US). The following keyboard types are supported for BT HID or USB HID when using 3656 with the USB cable provided —

No.	Keyboard Type	No.	Keyboard Type
64	PCAT (US)	70	PCAT (UK)
65	PCAT (French)	71	PCAT (Belgium)
66	PCAT (German)	72	PCAT (Spanish)
67	PCAT (Italy)	73	PCAT (Portuguese)
68	PCAT (Swedish)	74	PS55 A01-2 (Japanese)
69	PCAT (Norwegian)	75	User-defined table

2.1.2 RESET CONNECTION

For BT HID, you can only have the scanner connected to one computer at a time. If you want to connect the scanner to another host, you must have it read the “Reset Connection” label so that the current connection record will be cleared. Then, the scanner will restart itself automatically. Go through the whole process in [3.2.3 Connect to Dongle](#) to establish a new connection.

Reset Connection



109919

Note: The “Restore System Defaults” label will have the current connection record cleared as well.



2.1.3 KEYBOARD SETTINGS

- ▶ Digits Layout
- ▶ Capital Lock Type
- ▶ Capital Lock Setting
- ▶ Alphabets Transmission
- ▶ Digits Transmission

Note: BT HID does not support these functions on PDAs – (1) Capital Lock Setting: Auto Detection (2) Digits Transmission: Numeric Key

Digits Layout

Select a proper layout that matches the alphabets layout. The scanner will make adjustments according to this setting.

Options	Description
Normal	Depends on the [Shift] key or [Shift Lock] setting
Lower Row	For QWERTY or QWERTZ keyboard
Upper Row	For AZERTY keyboard



Note: This setting is to be used with the Character Substitution setting when support to certain keyboard types (languages) is unavailable but required.

Capital Lock Type & Setting

In order to send the alphabets with correct case, the scanner needs to know the status of Caps Lock on the keyboard. Incorrect settings may result in reversed case of the alphabets being transmitted.



Cap Lock Type	Description
Normal	Normal type
Capital Lock	When enabled, the keys of alphabetic characters will be interpreted as capital letters. However, this does not affect the number or punctuation keys.
Shift Lock	When enabled, the keys of alphabetic characters will be interpreted as capital letters. In addition, this affects the number or punctuation keys.



Capital Lock State	Description
Capital Lock OFF	Assuming that the status of Caps Lock on the keyboard is OFF, transmitted characters are exactly the same as in the barcode (when "case-sensitive" is selected for Alphabets Transmission).
Capital Lock ON	Assuming that the status of Caps Lock on the keyboard is ON, transmitted characters are exactly the same as in the barcode (when "case-sensitive" is selected for Alphabets Transmission). <ul style="list-style-type: none"> ▶ Refer to the Capital Lock Type above.
Auto Detection	The scanner will automatically detect the status of Caps Lock on the keyboard before data is transmitted; transmitted characters are exactly the same as in the barcode (when "case-sensitive" is selected for Alphabets Transmission). <ul style="list-style-type: none"> ▶ This setting is not supported on PDAs.





Alphabets Transmission

By default, the alphabets transmission is case-sensitive, meaning that the alphabets will be transmitted according to their original case, the status of Caps Lock on the keyboard, as well as the Capital Lock setting. Select [Ignore Case] to have alphabets transmitted according to the status of Caps Lock on the keyboard only.

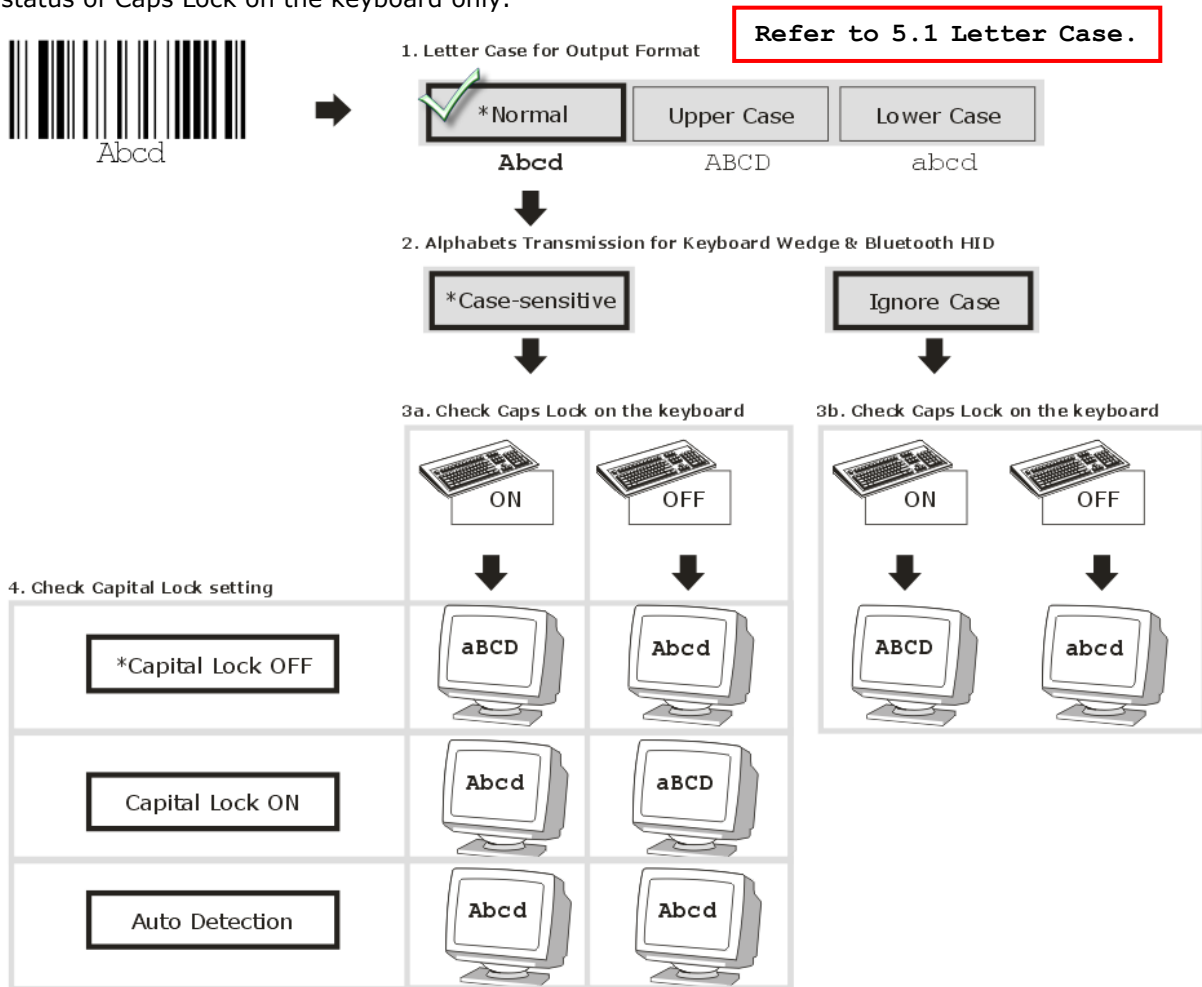

1. Letter Case for Output Format

✓ *Normal Abcd	Upper Case ABCD	Lower Case abcd
----------------------	--------------------	--------------------

2. Alphabets Transmission for Keyboard Wedge & Bluetooth HID

*Case-sensitive	Ignore Case
-----------------	-------------

3a. Check Caps Lock on the keyboard

ON	OFF
↓	↓
*Capital Lock OFF aBCD	Abcd
Capital Lock ON Abcd	aBCD
Auto Detection Abcd	Abcd

3b. Check Caps Lock on the keyboard

ON	OFF
↓	↓
ABCD	abcd

4. Check Capital Lock setting

*Capital Lock OFF	aBCD	Abcd
Capital Lock ON	Abcd	aBCD
Auto Detection	Abcd	Abcd



*Case-sensitive



Ignore Case



Digits Transmission

By default, the alphanumeric keypad is used for transmitting digits. Select "Numeric Keypad" if you wish to use the keys on the numeric keypad.

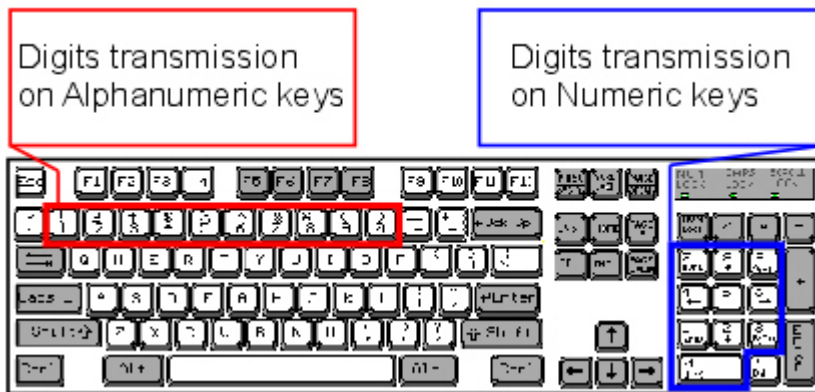

*Alphanumeric Key



Numeric Key



Note: If you select "Numeric Keypad", the Num Lock status of the physical keyboard should be "ON". This setting is not supported on PDAs.



2.1.4 INTER-FUNCTION DELAY

By default, the inter-function delay is set to zero. Specify a value, ranging from 0 to 254, to match the computer response time of the keyboard interface. Such delay time is inserted between every function code (0x01 ~ 0x1F) being transmitted. The longer the delay time is, the slower the transmission speed will be.

Value	Delay Time	Value	Delay Time
0	Disable	195 ~ 204	200 millisecond
1 ~ 14	10 millisecond	205 ~ 214	210 millisecond
15 ~ 24	20 millisecond	215 ~ 224	220 millisecond
25 ~ 34	30 millisecond	225 ~ 234	230 millisecond
35 ~ 44	40 millisecond	235 ~ 244	240 millisecond
45 ~ 54	50 millisecond	245 ~ 254	250 millisecond
...	...		

Inter-Function Delay ... (*0 ~ 254)



100012

- 1) Read the label above to specify the inter-function delay.
- 2) Read the "[Decimal Value](#)" label on page 187 for the desired inter-function delay (millisecond).
- 3) Read the "Validate" label on the same page to complete this setting.



2.2 BT SPP

For BT SPP, refer to [Chapter 3 – Setting up a WPAN Connection](#) for related connection settings. For example, run HyperTerminal.exe on your computer, and the scanned data will be transmitted to the computer.

2.2.1 ACTIVATE BT SPP

Activate Bluetooth SPP



100003

2.2.2 INTER-FUNCTION DELAY

By default, the inter-function delay is set to zero. Specify a value, ranging from 0 to 254, to match the computer response time of the keyboard interface. Such delay time is inserted between every function code (0x01 ~ 0x1F) being transmitted. The longer the delay time is, the slower the transmission speed will be.

Value	Delay Time	Value	Delay Time
0	Disable	195 ~ 204	200 millisecond
1 ~ 14	10 millisecond	205 ~ 214	210 millisecond
15 ~ 24	20 millisecond	215 ~ 224	220 millisecond
25 ~ 34	30 millisecond	225 ~ 234	230 millisecond
35 ~ 44	40 millisecond	235 ~ 244	240 millisecond
45 ~ 54	50 millisecond	245 ~ 254	250 millisecond
...	...		

Inter-Function Delay ... (*0 ~ 254)



100012

- 1) Read the label above to specify the inter-function delay.
- 2) Read the "[Decimal Value](#)" label on page 187 for the desired inter-function delay (millisecond).
- 3) Read the "Validate" label on the same page to complete this setting.



2.2.3 ACK/NAK TIMEOUT

By default, the scanner sends data to the host without waiting for an ACK/NAK response before sending more data. Specify a value, ranging from 1 to 99 in units of 0.1 second. If no response within the specified period of time, the scanner will attempt to send the same data three more times. If all the attempts fail without any notification, data loss will occur.

ACK/NAK Time-Out after ... (*0 ~ 99)



100013

- 1) Read the label above to specify the time interval for the scanner to send data and wait for a response from the host.
- 2) Read the "[Decimal Value](#)" label on page 187. For example, read "1" and "0" for the scanner to automatically shut down after being idle for 1 second.
- 3) Read the "Validate" label on the same page to complete this setting.

ACK/NAK Error Beep

Enable Error Beep



100015

*Disable Error Beep



100014

Note: We suggest you to enable the error beep so that you will be notified of such data loss and have the scanner re-read data.



2.3 KEYBOARD WEDGE VIA 3656

The Y cable allows you to connect the scanner via 3656 to the keyboard input port of PC and you may join the keyboard as well. The scanned data will be transmitted to the host keyboard port as if it is manually entered via the keyboard. For example, run a text editor on your computer to receive the data.

Keyboard Wedge Settings	Defaults
Keyboard Type	PCAT (US)
Alphabets Layout	Normal
Digits Layout	Normal
Capital Lock Type	Normal
Capital Lock State	Off
Alphabets Transmission	Case-sensitive
Digits Transmission	Alphanumeric keypad
Alternate Composing	No
Inter-Character Delay	0 (ms)
Inter-Function Delay	0 (ms)
Send "NR" to Host	Disable
Laptop Support	Disable

2.3.1 ACTIVATE KEYBOARD WEDGE & SELECT KEYBOARD TYPE

When Keyboard Wedge interface is activated, you will have to select a keyboard type to complete this setting.

Activate & Select Keyboard Type ...



100000

- 1) Read this label above to activate Keyboard Wedge and select a keyboard type.
- 2) Read the "[Decimal Value](#)" label on page 187. Refer to the table below for the number of desired keyboard type.
- 3) Read the "Validate" label on the same page to complete this setting.



Keyboard Wedge via 3656

By default, the keyboard type is set to PCAT (US). The following keyboard types are supported when using 3656 with the keyboard wedge cable provided —

No.	Keyboard Type	No.	Keyboard Type
1	PCAT (US)	16	PS55 001-2
2	PCAT (French)	17	PS55 001-82
3	PCAT (German)	18	PS55 001-3
4	PCAT (Italian)	19	PS55 001-8A
5	PCAT (Swedish)	20	PS55 002-1, 003-1
6	PCAT (Norwegian)	21	PS55 002-81, 003-81
7	PCAT (UK)	22	PS55 002-2, 003-2
8	PCAT (Belgium)	23	PS55 002-82, 003-82
9	PCAT (Spanish)	24	PS55 002-3, 003-3
10	PCAT (Portuguese)	25	PS55 002-8A, 003-8A
11	PS55 A01-1	26	IBM 3477 Type 4 (Japanese)
12	PS55 A01-2 (Japanese)	27	PS2-30
13	PS55 A01-3	28	IBM 34XX/319X, Memorex Telex 122 Keys
14	PS55 001-1	29	User-defined table
15	PS55 001-81		

2.3.2 KEYBOARD SETTINGS

Alphabets Layout

By default, the alphabets layout is set to normal mode, also known as the standard English layout. Select French or German keyboard layout if necessary. The scanner will make adjustments when sending the "A", "Q", "W", "Z", "Y", and "M" characters according to this setting.



US Keyboard Style – Normal

QWERTY layout, which is normally used in western countries.

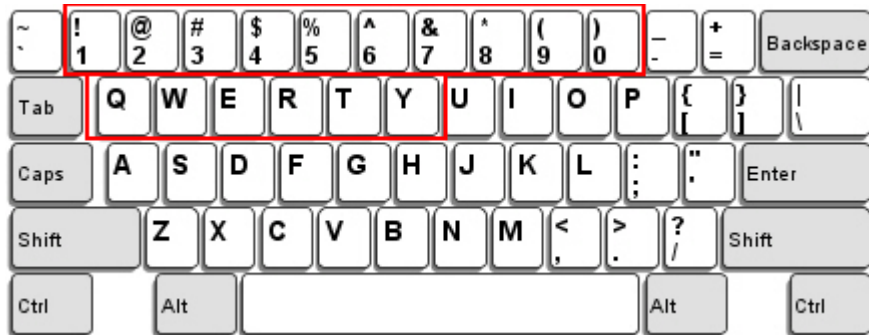

- ▶ Select "Lower Row" for the "Digits Layout" setting for the upper row is for special characters.

French Keyboard Style – AZERTY

French layout; see below for French Keyboard Style.

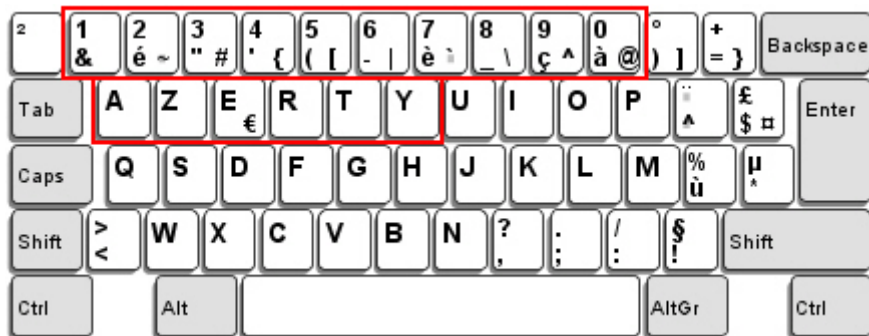

- ▶ Select "Upper Row" for the "Digits Layout" setting for the lower row is for special characters.

German Keyboard Layout – QWERTZ

German layout; see below for German Keyboard Style.

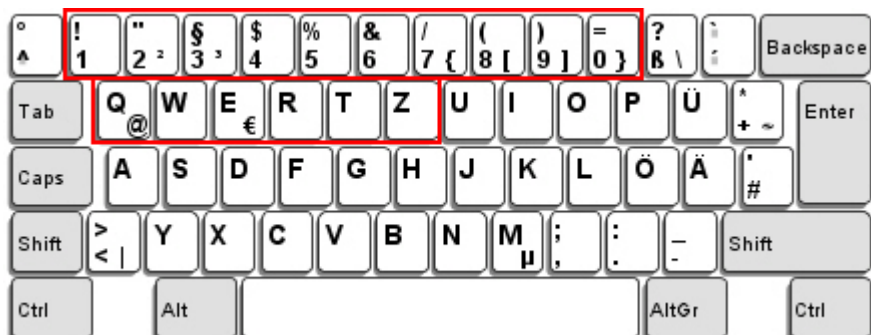

- ▶ Select "Lower Row" for the "Digits Layout" setting for the upper row is for special characters.



Note: This setting only works when the keyboard type selected is US keyboard, such as PCAT (US). The Alphabets Layout and Digits Layout setting must match your keyboard.

Digits Layout

Select a proper layout that matches the alphabets layout. The scanner will make adjustments according to this setting.

Options	Description
<i>Normal</i>	Depends on the [Shift] key or [Shift Lock] setting
<i>Lower Row</i>	For QWERTY or QWERTZ keyboard
<i>Upper Row</i>	For AZERTY keyboard



Note: This setting is meant to be used with the Alphabets Layout; and perhaps with the Character Substitution setting when support to certain keyboard types (languages) is unavailable but required.

Capital Lock Type & Setting

In order to send the alphabets with correct case, the scanner needs to know the status of Caps Lock on the keyboard. Incorrect settings may result in reversed case of the alphabets being transmitted.

Cap Lock Type	Description
Normal	Normal type
Capital Lock	When enabled, the keys of alphabetic characters will be interpreted as capital letters. However, this does not affect the number or punctuation keys.
Shift Lock	When enabled, the keys of alphabetic characters will be interpreted as capital letters. In addition, this affects the number or punctuation keys.





Capital Lock State	Description
Capital Lock OFF	Assuming that the status of Caps Lock on the keyboard is OFF, transmitted characters are exactly the same as in the barcode (when "case-sensitive" is selected for Alphabets Transmission).
Capital Lock ON	Assuming that the status of Caps Lock on the keyboard is ON, transmitted characters are exactly the same as in the barcode (when "case-sensitive" is selected for Alphabets Transmission). ▶ Refer to the Capital Lock Type above.
Auto Detection	The scanner will automatically detect the status of Caps Lock on the keyboard before data is transmitted; transmitted characters are exactly the same as in the barcode (when "case-sensitive" is selected for Alphabets Transmission).



Alphabets Transmission

By default, the alphabets transmission is case-sensitive, meaning that the alphabets will be transmitted according to their original case, the status of Caps Lock on the keyboard, as well as the Capital Lock setting. Select [Ignore Case] to have alphabets transmitted according to the status of Caps Lock on the keyboard only.

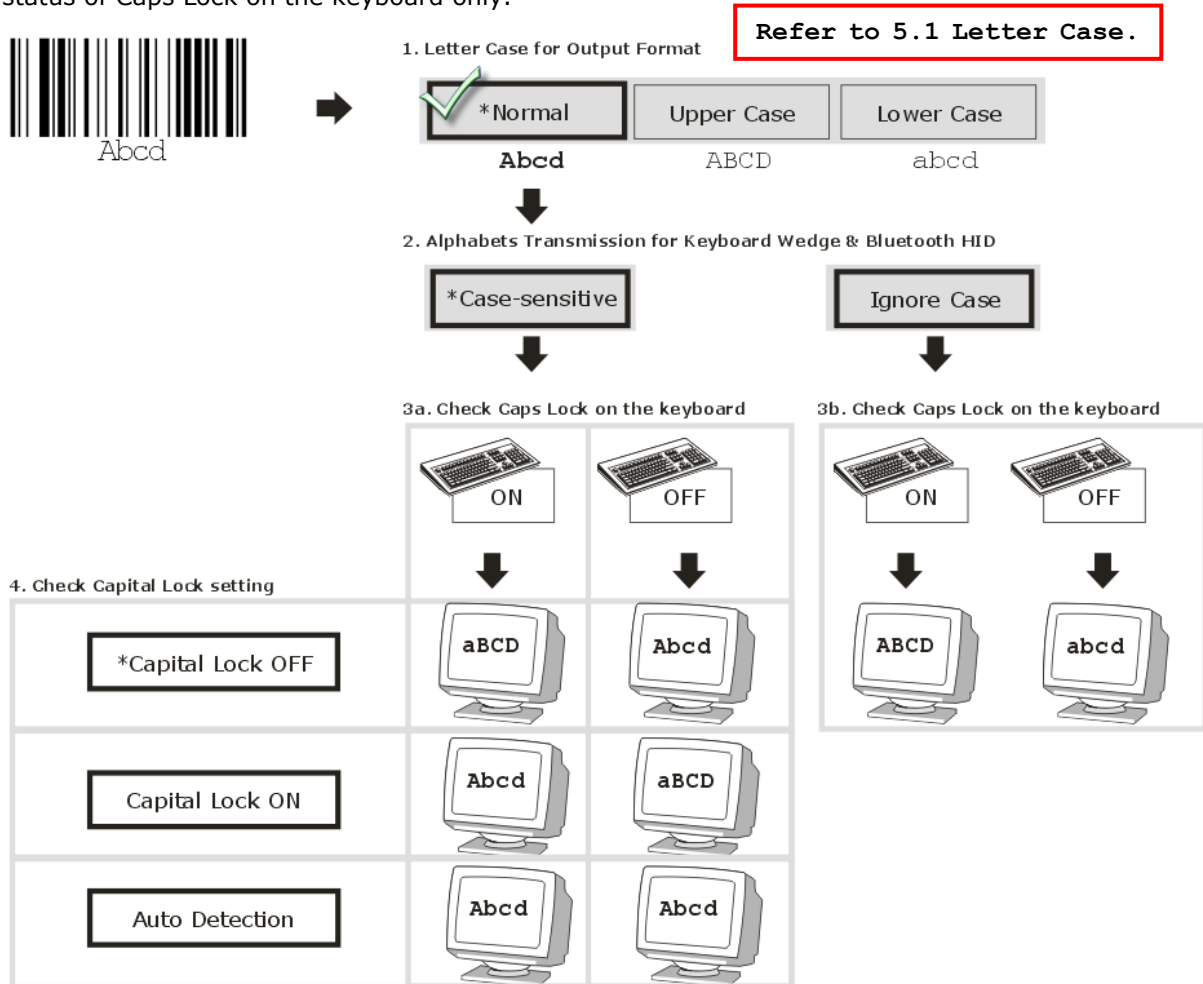

Digits Transmission

By default, the alphanumeric keypad is used for transmitting digits. Select "Numeric Keypad" if you wish to use the keys on the numeric keypad.

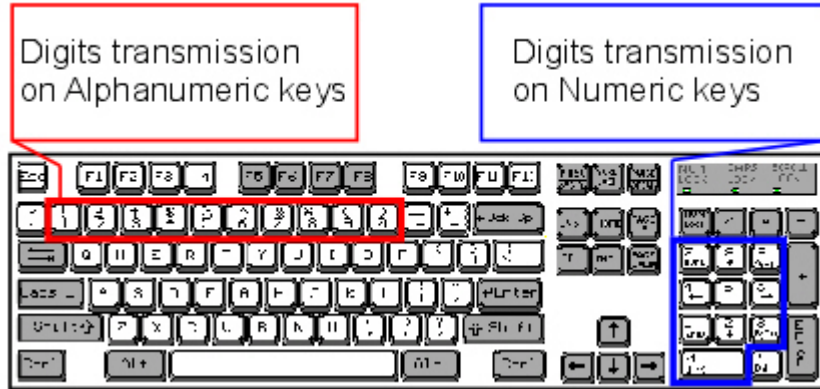

*Alphanumeric Key



Numeric Key



Note: If you select "Numeric Keypad", the Num Lock status of the physical keyboard should be "ON".

ALT Composing

By default, Alternate key composing is disabled. Select [Yes] to allow emulating Alternate key code of a specific keyboard character. For example, [Alt] + [065] will be sent to host for the character "A" regardless the keyboard type you are using.

Yes



*No



Laptop Support

By default, laptop support is disabled. It is suggested to enable this feature if you connect the wedge cable to a laptop without an external keyboard being inter-connected.





2.3.3 INTER-CHARACTER DELAY

By default, the inter-character delay is set to zero. Specify a value, ranging from 0 to 254 in units of millisecond, to match the computer response time of the keyboard interface. Such delay time is inserted between every character being transmitted. The longer the delay time is, the slower the transmission speed will be.

Inter-Character Delay ... (*0 ~ 254)



- 1) Read the label above to specify the inter-character delay.
- 2) Read the "[Decimal Value](#)" label on page 187 for the desired inter-character delay (millisecond).
- 3) Read the "Validate" label on the same page to complete this setting.

2.3.4 INTER-FUNCTION DELAY

By default, the inter-function delay is set to zero. Specify a value, ranging from 0 to 254 in units of millisecond, to match the computer response time of the keyboard interface. Such delay time is inserted between every function code (0x01 ~ 0x1F) being transmitted. The longer the delay time is, the slower the transmission speed will be.

Inter-Function Delay ... (*0 ~ 254)



- 1) Read the label above to specify the inter-function delay.
- 2) Read the "[Decimal Value](#)" label on page 187 for the desired inter-function delay (millisecond).
- 3) Read the "Validate" label on the same page to complete this setting.



2.4 RS-232 VIA 3656

Use the RS-232 cable to connect the scanner via 3656 to the serial port of PC, and connect the power supply cord. The associated RS-232 parameters must match those configured on the computer. You may run HyperTerminal.exe on your computer, and the scanned data will be transmitted to the computer.

RS-232 Settings	Defaults
Baud Rate, Data Bit, Parity, Stop Bit	9600 bps, 8 bits, No parity, 1 stop bit
Flow Control	None
Inter-Character Delay	0 (ms)
Inter-Function Delay	0 (ms)
Send "NR" to Host	Disable
ACK/NAK Timeout	0
ACK/NAK Beep	Disable

2.4.1 ACTIVATE RS-232 INTERFACE

Activate RS-232 Interface



2.4.2 BAUD RATE





2.4.3 DATA BITS



2.4.4 PARITY





2.4.5 STOP BIT



2.4.6 FLOW CONTROL

By default, there is no flow control in use. Select the flow control (handshake) method.

Options	Description
No	No flow control
Scanner Ready	The scanner will activate the RTS signal upon powering on. After each good read, the scanner will then wait for the CTS signal to become active. Data will not be sent until the CTS signal becomes active.
Data Ready	The RTS signal will be activated after each good read. The scanner will then wait for the CTS signal to become active. Data will not be sent until the CTS signal becomes active.
Inverted Data Ready	It works the same as the Data Ready flow control, except that the RTS signal level is inverted.





2.4.7 INTER-CHARACTER DELAY

By default, the inter-character delay is zero. Specify a value, ranging from 0 to 254 in units of millisecond, to match the computer response time. Such delay time is inserted between every character being transmitted. The longer the delay time is, the slower the transmission speed will be.



- 1) Read the label above to specify the inter-character delay.
- 2) Read the "[Decimal Value](#)" label on page 187 for the desired inter-character delay (millisecond).
- 3) Read the "Validate" label on the same page to complete this setting.

2.4.8 INTER-FUNCTION DELAY

By default, the inter-function delay is set to zero. Specify a value, ranging from 0 to 254 in units of millisecond, to match the computer response time of the keyboard interface. Such delay time is inserted between every function code (0x01 ~ 0x1F) being transmitted. The longer the delay time is, the slower the transmission speed will be.



- 1) Read this label above to specify the inter-function delay.
- 2) Read the "[Decimal Value](#)" label on page 187 for the desired inter-function delay (millisecond).
- 3) Read the "Validate" label on the same page to complete this setting.



2.4.9 ACK/NAK TIMEOUT

By default, the scanner sends data to the host without waiting for an ACK/NAK response before sending more data. Specify a value, ranging from 1 to 99 in units of 0.1 second. If no response within the specified period of time, the scanner will attempt to send the same data three more times. If all the attempts fail without any notification, data loss will occur.

ACK/NAK Time-Out after ... (*0 ~ 99)



100013

- 1) Read the label above to specify the time interval for the scanner to send data and wait for a response from the host.
- 2) Read the "[Decimal Value](#)" label on page 187. For example, read "1" and "0" for the scanner to automatically shut down after being idle for 1 second.
- 3) Read the "Validate" label on the same page to complete this setting.

ACK/NAK Error Beep

Enable Error Beep



100015

*Disable Error Beep



100014

Note: We suggest you to enable the error beep so that you will be notified of such data loss and have the scanner re-read data.



2.5 USB HID VIA 3656

For USB HID, use the USB cable to connect the scanner via 3656 to the USB port of PC and connect the power supply cord if necessary. Run any text editor on your computer, and the scanned data will be transmitted to the computer.

HID Settings	Defaults
Keyboard Type	PCAT (US)
Digits Layout	Normal
Capital Lock Type	Normal
Capital Lock State	Off
Alphabets Transmission	Case-sensitive
Digits Transmission	Alphanumeric keypad
Inter-Function Delay	0 (ms)
Send "NR" to Host	Disable

2.5.1 ACTIVATE USB HID & SELECT KEYBOARD TYPE

When USB HID interface is activated, you will have to select a keyboard type to complete this setting. By default, BT HID is activated on the scanner, and the keyboard type is set to PCAT (US).

Activate USB HID & Select Keyboard Type ...



100005

- 1) Read the label above to activate USB HID and select a keyboard type.
- 2) Read the "Decimal Value" label on page 187. Refer to the table below for the number of desired keyboard type.
- 3) Read the "Validate" label on the same page to complete this setting.



USB HID via 3656

By default, the keyboard type is set to PCAT (US). The following keyboard types are supported for BT HID or USB HID when using 3656 with the USB cable provided —

No.	Keyboard Type	No.	Keyboard Type
64	PCAT (US)	70	PCAT (UK)
65	PCAT (French)	71	PCAT (Belgium)
66	PCAT (German)	72	PCAT (Spanish)
67	PCAT (Italy)	73	PCAT (Portuguese)
68	PCAT (Swedish)	74	PS55 A01-2 (Japanese)
69	PCAT (Norwegian)	75	User-defined table



2.5.2 KEYBOARD SETTINGS

- ▶ Digits Layout
- ▶ Capital Lock Type
- ▶ Capital Lock Setting
- ▶ Alphabets Transmission
- ▶ Digits Transmission

Digits Layout

Select a proper layout that matches the alphabets layout. The scanner will make adjustments according to this setting.

Options	Description
Normal	Depends on the [Shift] key or [Shift Lock] setting
Lower Row	For QWERTY or QWERTZ keyboard
Upper Row	For AZERTY keyboard



Note: This setting is to be used with the Character Substitution setting when support to certain keyboard types (languages) is unavailable but required.

Capital Lock Type & Setting

In order to send the alphabets with correct case, the scanner needs to know the status of Caps Lock on the keyboard. Incorrect settings may result in reversed case of the alphabets being transmitted.

Cap Lock Type	Description
Normal	Normal type



Capital Lock	When enabled, the keys of alphabetic characters will be interpreted as capital letters. However, this does not affect the number or punctuation keys.
Shift Lock	When enabled, the keys of alphabetic characters will be interpreted as capital letters. In addition, this affects the number or punctuation keys.



Capital Lock State	Description
Capital Lock OFF	Assuming that the status of Caps Lock on the keyboard is OFF, transmitted characters are exactly the same as in the barcode (when "case-sensitive" is selected for Alphabets Transmission).
Capital Lock ON	Assuming that the status of Caps Lock on the keyboard is ON, transmitted characters are exactly the same as in the barcode (when "case-sensitive" is selected for Alphabets Transmission). ▶ Refer to the Capital Lock Type above.
Auto Detection	The scanner will automatically detect the status of Caps Lock on the keyboard before data is transmitted; transmitted characters are exactly the same as in the barcode (when "case-sensitive" is selected for Alphabets Transmission).





Alphabets Transmission

By default, the alphabets transmission is case-sensitive, meaning that the alphabets will be transmitted according to their original case, the status of Caps Lock on the keyboard, as well as the Capital Lock setting. Select [Ignore Case] to have alphabets transmitted according to the status of Caps Lock on the keyboard only.

Refer to 5.1 Letter Case.

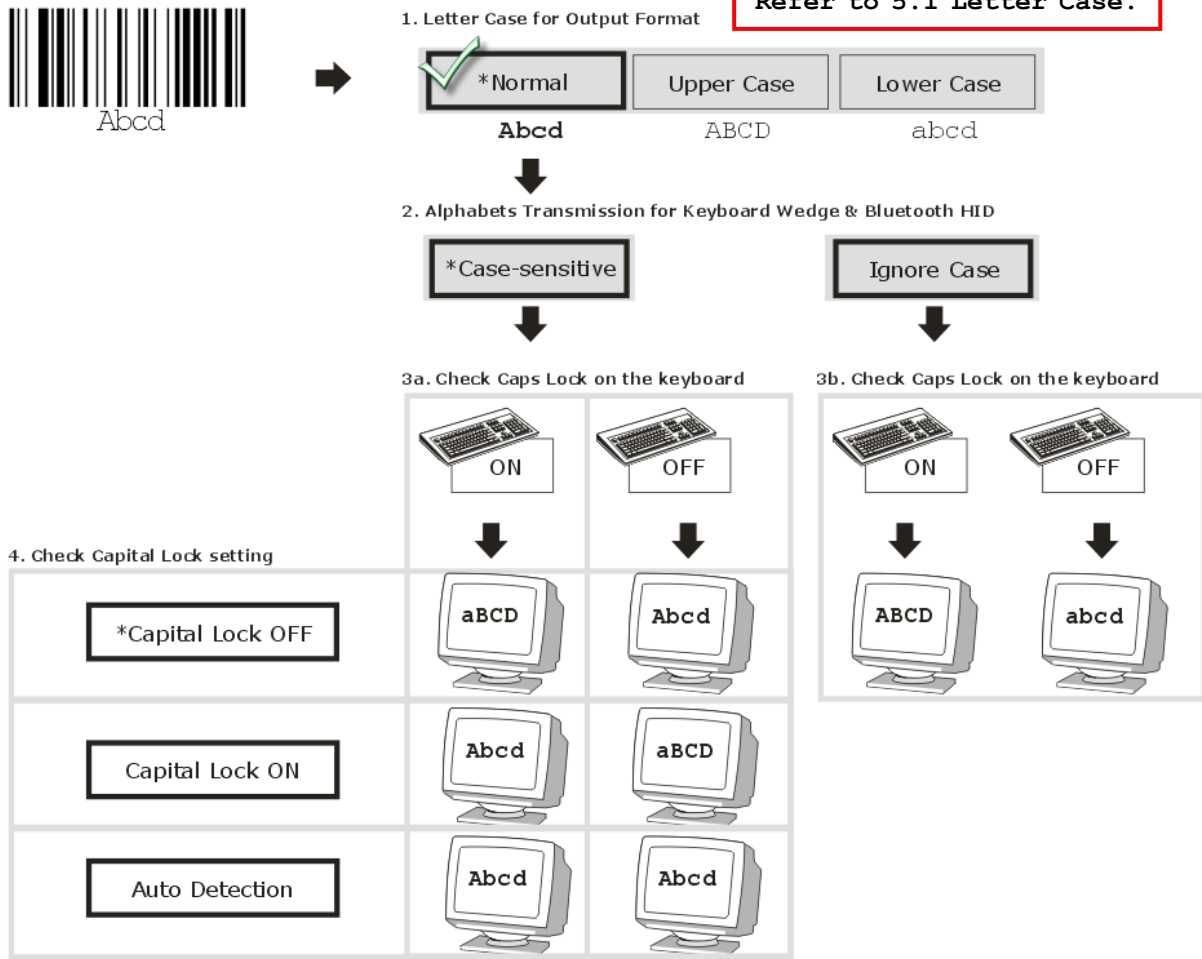



Digits Transmission

By default, the alphanumeric keypad is used for transmitting digits. Select "Numeric Keypad" if you wish to use the keys on the numeric keypad.

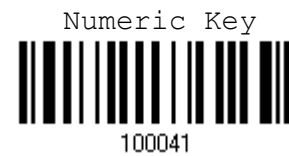
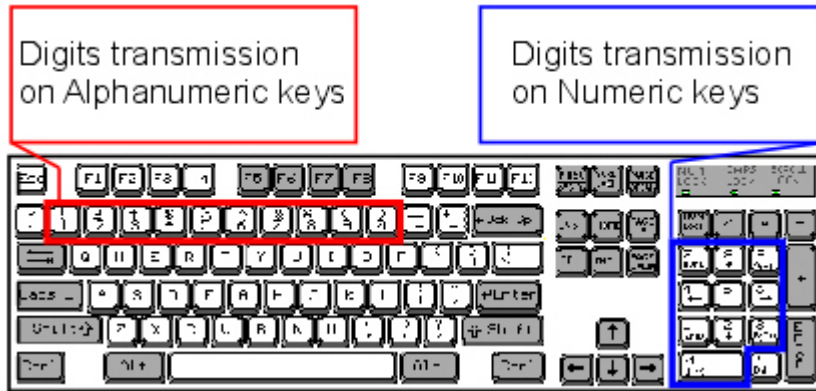

Note: If you select "Numeric Keypad", the Num Lock status of the physical keyboard should be "ON".



2.5.3 INTER-FUNCTION DELAY

By default, the inter-function delay is set to zero. Specify a value, ranging from 0 to 254, to match the computer response time of the keyboard interface. Such delay time is inserted between every function code (0x01 ~ 0x1F) being transmitted. The longer the delay time is, the slower the transmission speed will be.

Value	Delay Time	Value	Delay Time
0	Disable	195 ~ 204	200 millisecond
1 ~ 14	10 millisecond	205 ~ 214	210 millisecond
15 ~ 24	20 millisecond	215 ~ 224	220 millisecond
25 ~ 34	30 millisecond	225 ~ 234	230 millisecond
35 ~ 44	40 millisecond	235 ~ 244	240 millisecond
45 ~ 54	50 millisecond	245 ~ 254	250 millisecond
...	...		

Inter-Function Delay ... (*0 ~ 254)



100012

- 1) Read the label above to specify the inter-function delay.
- 2) Read the "[Decimal Value](#)" label on page 187 for the desired inter-function delay (millisecond).
- 3) Read the "Validate" label on the same page to complete this setting.



2.6 USB VIRTUAL COM VIA 3656

Use the USB cable to connect the scanner via 3656 to the USB port of PC and connect the power supply cord if necessary. You may run HyperTerminal.exe on your computer, and the scanned data will be transmitted to the computer.

Note: If you are using USB Virtual COM for the first time, you must install its driver from the CD-ROM. Driver version 5.3 or later is required. Please remove older versions!

2.6.1 ACTIVATE USB VIRTUAL COM

Activate USB Virtual COM



100004

2.6.2 INTER-FUNCTION DELAY

By default, the inter-function delay is set to zero. Specify a value, ranging from 0 to 254, to match the computer response time of the keyboard interface. Such delay time is inserted between every function code (0x01 ~ 0x1F) being transmitted. The longer the delay time is, the slower the transmission speed will be.

Value	Delay Time	Value	Delay Time
0	Disable	195 ~ 204	200 millisecond
1 ~ 14	10 millisecond	205 ~ 214	210 millisecond
15 ~ 24	20 millisecond	215 ~ 224	220 millisecond
25 ~ 34	30 millisecond	225 ~ 234	230 millisecond
35 ~ 44	40 millisecond	235 ~ 244	240 millisecond
45 ~ 54	50 millisecond	245 ~ 254	250 millisecond
...	...		

Inter-Function Delay ... (*0 ~ 254)



100012

- 1) Read the label above to specify the inter-function delay.
- 2) Read the "[Decimal Value](#)" label on page 187 for the desired inter-function delay (millisecond).
- 3) Read the "Validate" label on the same page to complete this setting.



2.6.3 ACK/NAK TIMEOUT

By default, the scanner sends data to the host without waiting for an ACK/NAK response before sending more data. Specify a value, ranging from 1 to 99 in units of 0.1 second. If no response within the specified period of time, the scanner will attempt to send the same data three more times. If all the attempts fail without any notification, data loss will occur.

ACK/NAK Time-Out after ... (*0 ~ 99)



100013

- 1) Read the label above to specify the time interval for the scanner to send data and wait for a response from the host.
- 2) Read the "[Decimal Value](#)" label on page 187. For example, read "1" and "0" for the scanner to automatically shut down after being idle for 1 second.
- 3) Read the "Validate" label on the same page to complete this setting.

ACK/NAK Error Beep

Enable Error Beep



100015

*Disable Error Beep



100014

Note: We suggest you to enable the error beep so that you will be notified of such data loss and have the scanner re-read data.



SETTING UP A WPAN CONNECTION

The 1560/1562 scanner can be configured to send data to a host computer wirelessly via the 3656 stand, or to a notebook computer or PDA with *Bluetooth*[®] wireless technology. Upon powering up, the scanner will be ready for establishing a WPAN connection.

To establish a connection via 3656 after reading “Set Connection” and “Serial No.” labels ...



Cable Type	Interface Option	Reference
Keyboard Wedge Cable	Keyboard Wedge	Section 2.3
RS-232 Cable	RS-232	Section 2.4
USB Cable	USB HID	Section 2.5
	USB Virtual COM	Section 2.6

To establish a connection via a generic *Bluetooth*[®] dongle after pairing...



Interface Option	Reference
BT HID	Section 2.1
BT SPP	Section 2.2

IN THIS CHAPTER

3.1 Connecting via 3656	76
3.2 Connecting via <i>Bluetooth</i> [®] Dongle	78



3.1 CONNECTING VIA 3656

Use the interface cable to connect the scanner via 3656 to PC. You can have up to seven scanners connected to one computer at the same time.

Note: If you are using USB Virtual COM for the first time, you must install its driver from the CD-ROM. Driver version 5.3 or later is required. Please remove older versions!

3.1.1 CONNECT TO 3656

By default, the interface of 3656 is set to "USB HID". You can connect any scanner to 3656 by having the scanner read the two labels at the back of 3656. The scanner will respond with one beep upon reading each of the labels.

- ▶ "Set Connection" label
- ▶ "Serial Number" label

After reading these labels, the scanner will stay active for 2 minutes trying to connect to the 3656 stand while its LED is flashing blue (On/Off ratio 0.5 s: 0.5 s). Once connected, the scanner will respond with three beeps (tone ascending from low to high), and the LED becomes flashing blue (On/Off ratio 0.02 s: 3 s). When getting out of range, the scanner will respond with three short beeps (tone descending from high to low).

Read the "Set Connection" label first, and then the "Serial Number" label. If the "Set Connection" label on 3656 is illegible, try this one —



Note: The 3656 settings will overwrite the interface-related settings on the scanners that are currently connected to 3656.



3.1.2 CHANGE INTERFACE

If you want to change the interface cable of 3656, use one of the scanners to configure the interface-related settings and it will pass the new settings to 3656, which will then initialize and pass the settings to any other connected scanners.

- 1) Have the scanner read the "Set Connection" and "Serial Number" labels at the back of 3656.
- 2) Within two minutes, connect the interface cable, Keyboard Wedge, RS-232 or USB, between 3656 and your computer. For USB Virtual COM, you may need to install its driver first!
- 3) The scanners will connect to your computer via 3656.
- 4) Have one scanner read the "Enter Setup" label to enter the configuration mode.
- 5) Have the scanner read the desired interface label and configure its related settings –
 - ▶ "Activate Keyboard Wedge & Select Keyboard Type"
 - ▶ "Activate RS-232"
 - ▶ "Activate USB HID & Select Keyboard Type"
 - ▶ "Activate USB Virtual COM"
- 6) Have the scanner read the "Update" label to exit the configuration mode.
- 7) After the scanner resumes connection with 3656, it will pass the interface-related settings to 3656.
- 8) Upon receipt of the new settings, 3656 will initialize itself.
- 9) Updated with new settings, 3656 will pass the settings to other connected scanners.

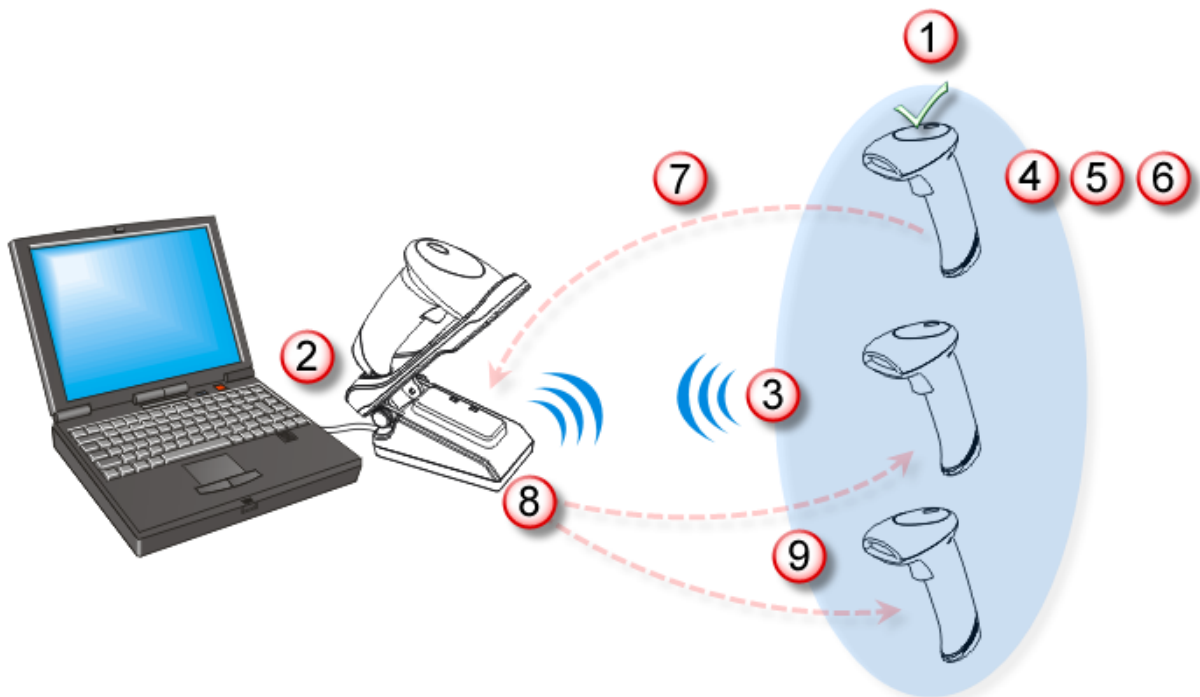

3.2 CONNECTING VIA *BLUETOOTH*[®] DONGLE

3.2.1 CHANGE INTERFACE

Below is the procedure to configure the scanner before establishing a WPAN connection via a generic *Bluetooth*[®] dongle.

- 1) Have the scanner read the "Enter Setup" label to enter the configuration mode.
- 2) Have the scanner read the desired interface label –
 - ▶ "Activate BT HID & Select Keyboard Type"
 - ▶ "Activate BT SPP"
- 3) Have the scanner read the labels related to WPAN settings, such as Device Name Broadcasting, Authentication & PIN Code, etc.
- 4) Have the scanner read the "Update" label to exit the configuration mode.
- 5) The scanner will stay active for 2 minutes waiting for a connection request from the host (SPP) or trying to connect to the host (HID). Its CPU is running at full speed, and the LED is flashing blue (On/Off ratio 0.5 s: 0.5 s).

Once connected, when getting out of range, the scanner will respond with three short beeps (tone descending from high to low).



3.2.2 CONFIGURE RELATED SETTINGS

Sniff Mode (Power-saving)

By default, this feature is enabled, meaning the scanner will listen to the wireless network at a reduced rate.



Note: When connecting more than two scanners to a notebook computer or PDA with *Bluetooth*[®] wireless technology, we suggest you to disable the power-saving setting for a more reliable connection.

Device Name Broadcasting

The scanner can be configured to hide itself from other devices equipped with *Bluetooth*[®] wireless technology. Simply disable the device name broadcasting setting so that it won't be discovered by any other computer or PDA. However, broadcasting must be enabled for establishing an initial connection with the scanner. For example, you can disable device name broadcasting after successfully connecting the scanner to WorkStation1. Such connection will be maintained automatically unless the scanner is removed from the paired device list (called unpairing) by WorkStation1 or any changes made to authentication and the PIN code. If you want WorkStation2 to connect to the scanner, you will have to enable device name broadcasting first.



Note: By default, device name broadcasting is enabled (which is required for initial connection).



Authentication

For security concerns, it is suggested that you enable authentication and specify a unique PIN code, also known as the passkey used to pair two devices before establishing a WPA connection. When any changes are made to authentication and PIN code on the scanner side, you will have to remove the scanner from the paired device list (called unpairing) and go through the whole process to re-establish the connection.

The scanner allows up to 16 characters for a PIN code and provides two options for authentication:

Enable Authentication with Preset PIN

Have the scanner read the "Use preset PIN" label, and change the preset PIN if necessary. This means you will have to enter exactly the same string for your computer or PDA to connect to the scanner. If the PIN or passkey is incorrect, any connection attempt will be turned down by the scanner. See step 8 in [3.2.3 Connect to Dongle](#).



Enable Authentication with Random PIN or No Authentication

By default, it is set to "No PIN or use random PIN", which depends on the setting of the target device. (No PIN = No authentication.)



Use random PIN

No PIN required

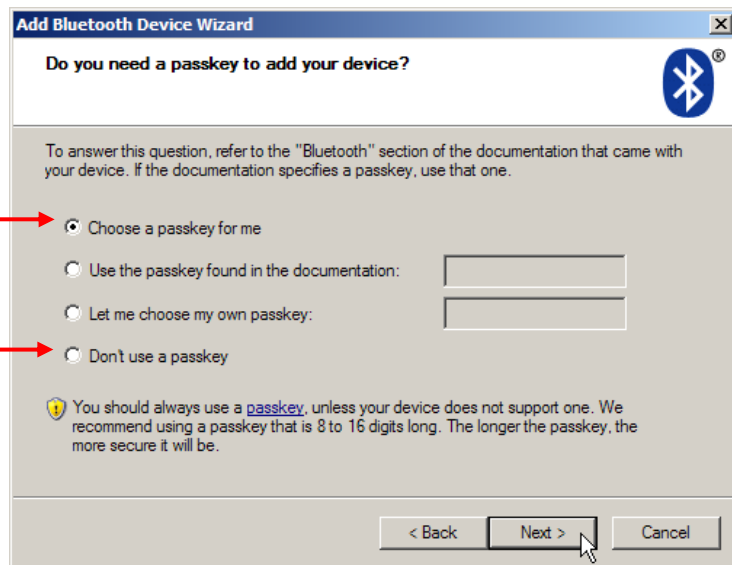

Note: When using BT HID, some device driver may not support pre-defined PIN code for authentication. In this case, make sure you have the scanner set to "No PIN or use random PIN" before pairing. While pairing, the host PIN code will be displayed on the computer screen. Have the scanner read the setup barcode "Enter PIN Code in Decimal" or "Enter PIN Code in Hexadecimal" to input the matching PIN code.



Entering preset PIN code...

1. Read the "Use preset PIN" label to enable authentication with a preset PIN.



2. Read one of the labels to specify the PIN code, in decimal or hexadecimal.

By default, the PIN code is set to "0000". Maximum 16 characters are allowed.

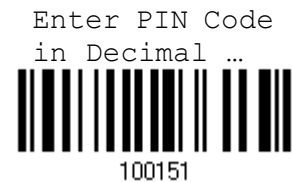

3. Read the "[Decimal Value](#)" label on page 187 or the "[Hexadecimal Value](#)" label on page 188 for the desired digits or character string.

Read the "Clear PIN Code" label first if you need to re-input the PIN code.



4. Read the "Validate" label to complete this setting.



3.2.3 CONNECT TO DONGLE

The procedure goes through associating devices for establishing a WPAN connection, which is pretty much the same except for the software you are using. If your computer is running Microsoft® Windows® XP Service Pack 3 (SP3) or Windows Vista® Service Pack 1 (SP1), you can use the generic software support that Windows® includes, or you can use the driver that the device manufacturer provides. Now, let's try using the generic software support that Windows® XP Service Pack 2 includes.

BT HID Procedure

By default, BT HID is activated on the scanner, and the keyboard type is set to PCAT (US). When BT HID is re-activated, you will have to select a keyboard type to complete this setting.

The procedure is the same as for BT SPP. Refer to steps 1~11 below.

BT SPP Procedure

1. Turn on the *Bluetooth*® function on your computer, running Windows XP SP2.

2. Double-click the *Bluetooth*® icon from the lower right of the taskbar. 

Alternatively, you may go to **Control Panel > Bluetooth Devices**.

3. Click [Add] to search devices nearby.

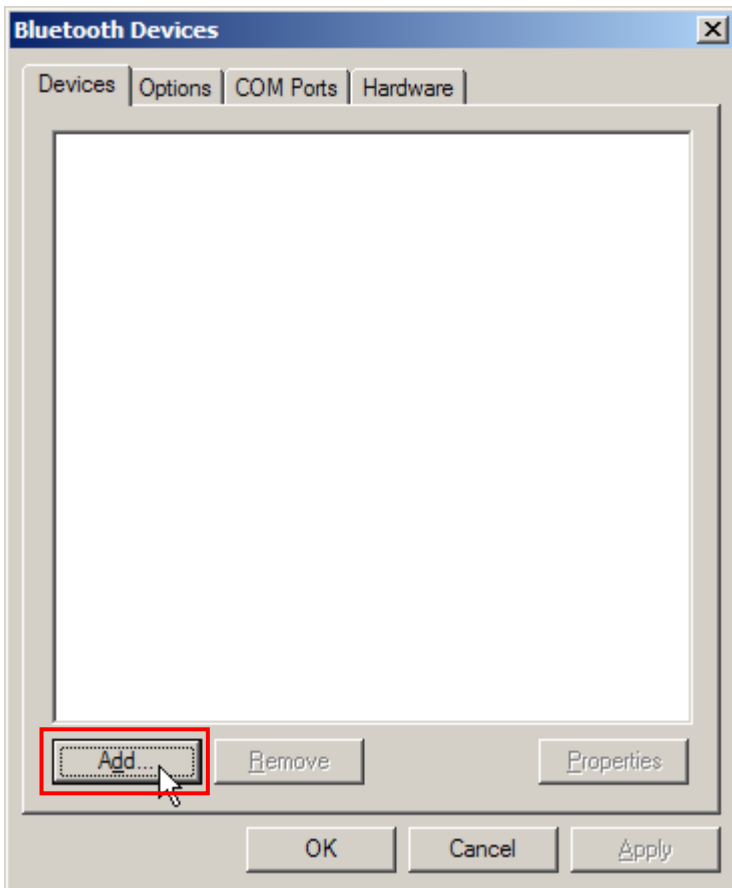

4. Turn on the scanner with correct WPAN settings, such as select BT SPP or BT HID, broadcasting enabled, authentication enabled, and PIN code specified, etc. Select the check box of [My device is set up and ready to be found] on your computer.
5. Click [Next].



6. Wait for a few seconds for the Wizard to search available devices nearby.

The scanner will appear with its "serial number" as the device name. You may double-check the "Serial Number" label on the scanner to ensure connecting with the correct scanner. Select the target scanner. If the target scanner does not appear on the list, click [Search Again] to refresh the list. The scanner might enter Suspend Mode now, and you can press the trigger to have it active again (=discoverable). It will then stay active for 2 minutes and wait for PC to establish a connection.

7. Click [Next].

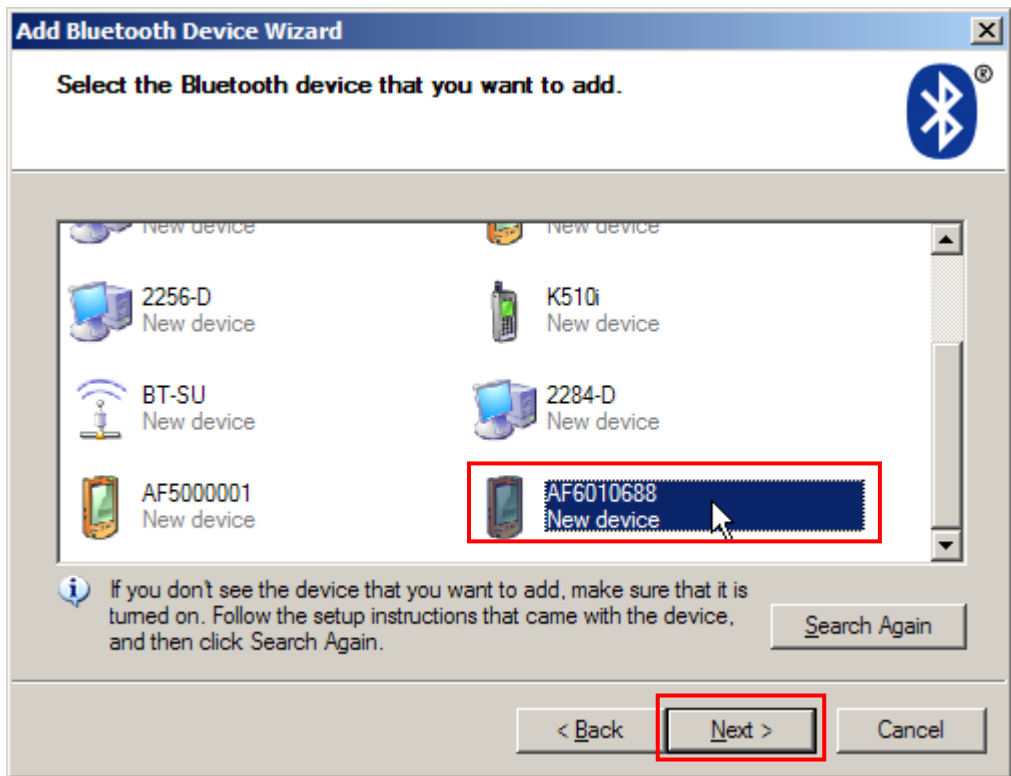

8. Enter the passkey for authentication, which must be exactly the same as configured for the scanner.
9. Click [Next].

Wait for a few seconds for Windows to exchange passkeys.

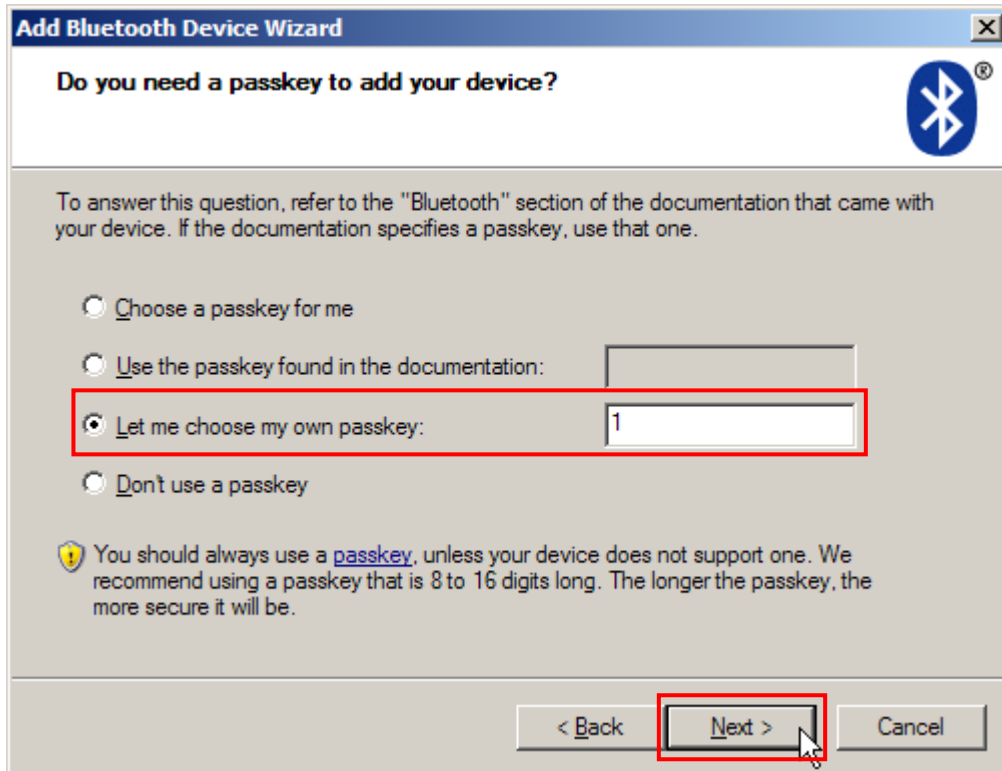

10. Click [Finish].

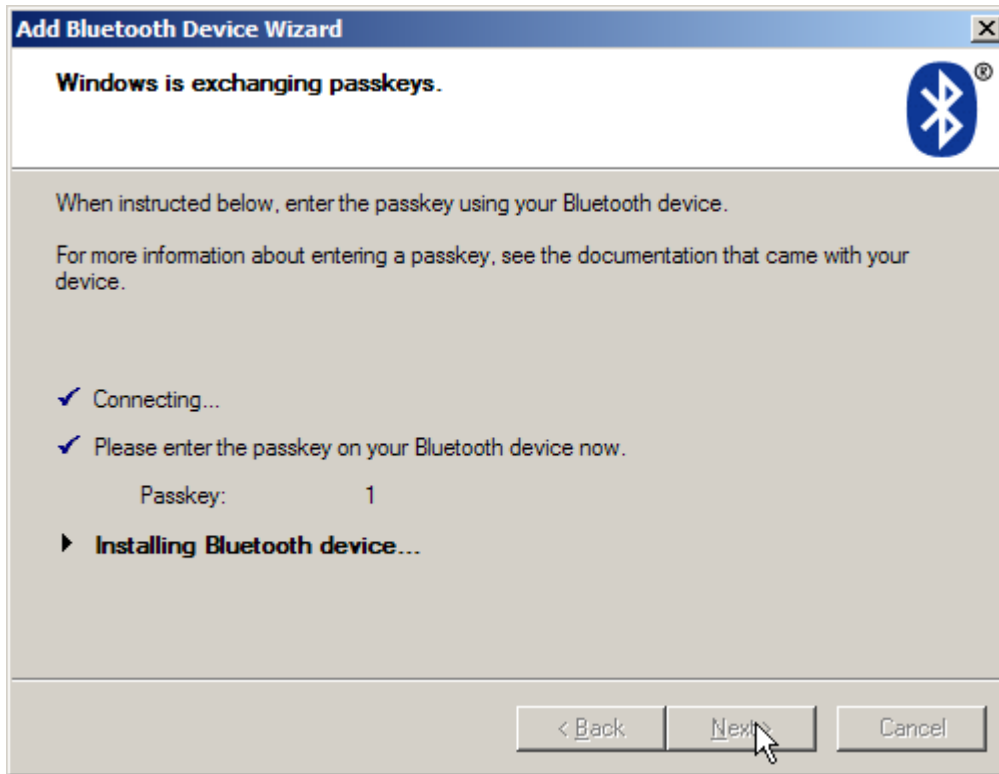

11. Now the target scanner will be listed as shown below.

You can have up to seven scanners connected to one computer at the same time.

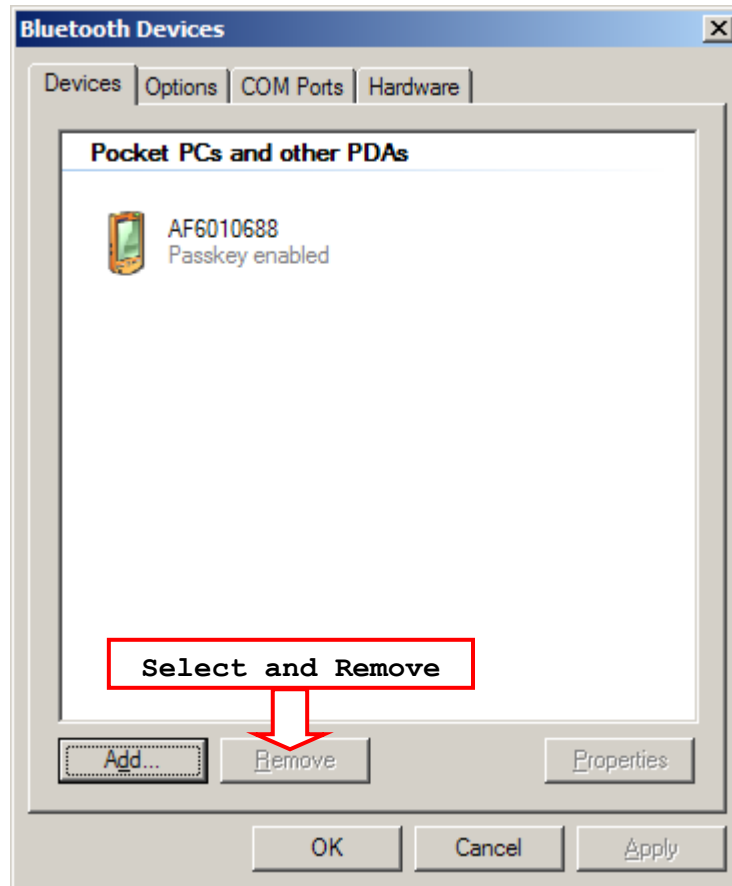

Note: When any changes are made to authentication and PIN code on the scanner side, or you want to change to use BT HID, it is suggested that you remove the scanner from the paired device list (called unpairing) and go through the whole process to re-establish the connection.



- Run the desired application on your computer, such as HyperTerminal.exe if using BT SPP or Notepad.exe if using BT HID.

The status of the scanner listed on the device list will be updated to "Connected", indicating the WPAN connection is established successfully via the outgoing COM port if using BT SPP.

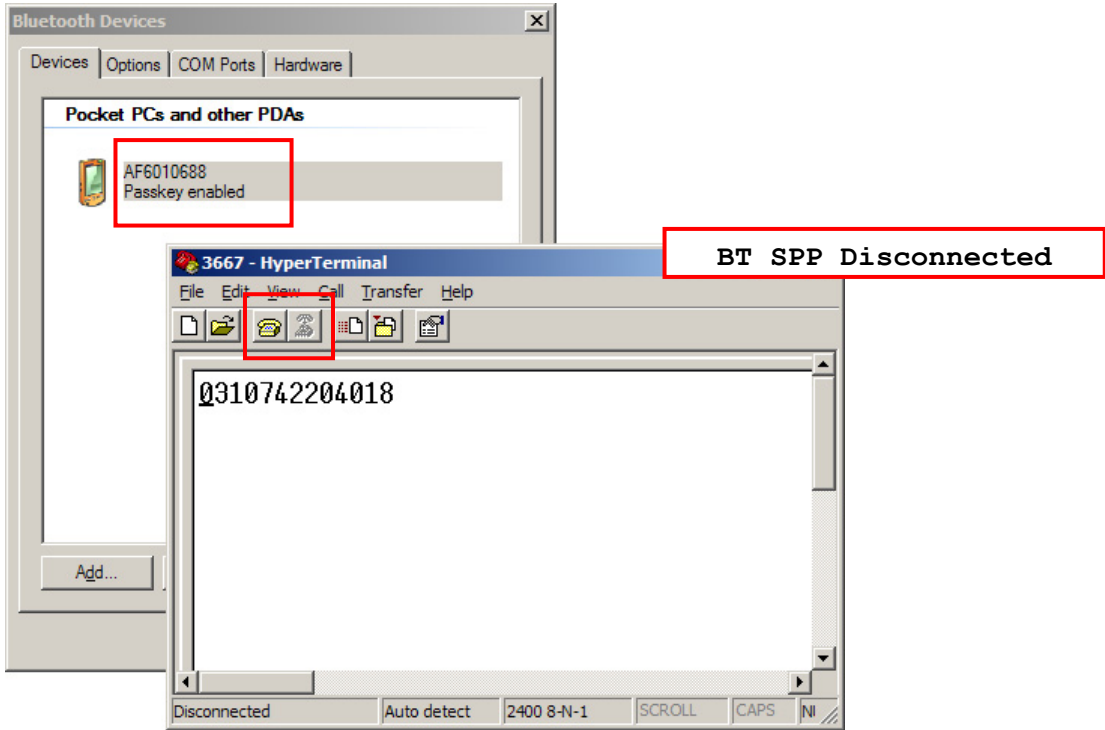
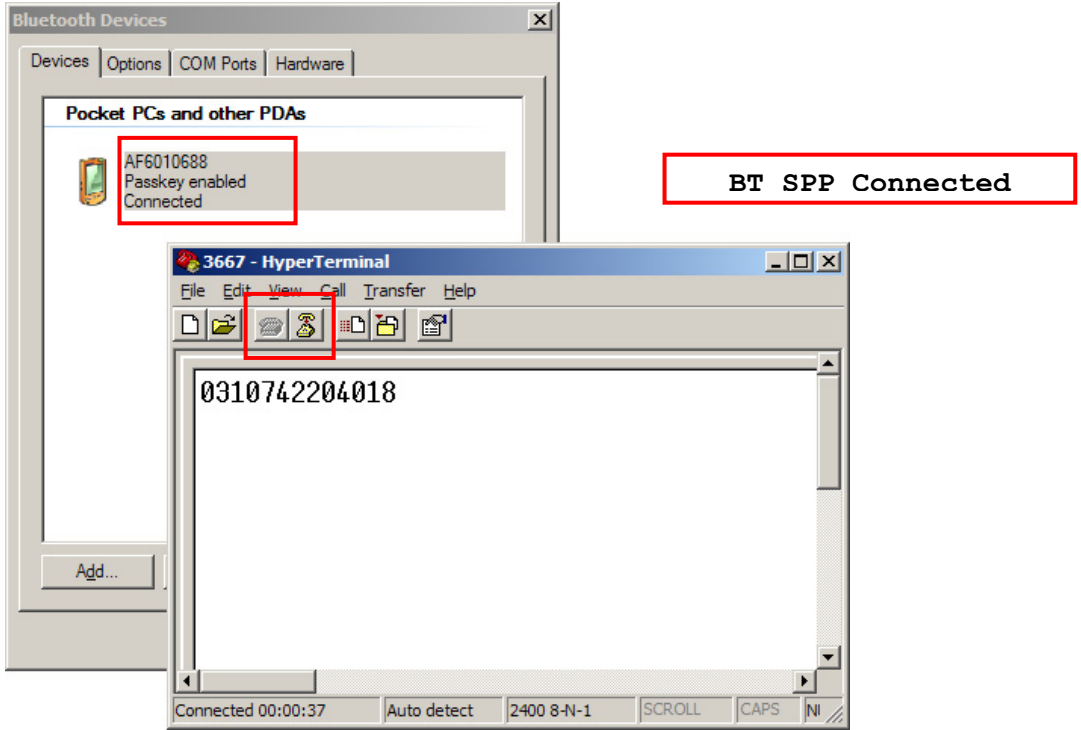

CHANGING SYMBOLOGY SETTINGS

In this chapter, a brief on the symbology settings is provided for your reference.

IN THIS CHAPTER

4.1 Codabar	90
4.2 Code 25 - Industrial 25.....	92
4.3 Code 25 - Interleaved 25	95
4.4 Code 25 - Matrix 25	98
4.5 Code 39	101
4.6 Code 93	103
4.7 Code 128.....	103
4.8 EAN-8	104
4.9 EAN-13	106
4.10 GS1-128 (EAN-128)	108
4.11 ISBT 128	109
4.12 MSI.....	110
4.13 French Pharmacode.....	113
4.14 Italian Pharmacode	114
4.15 Plessey	115
4.16 GS1 DataBar (RSS Family)	116
4.17 Telepen	120
4.18 UPC-A	121
4.19 UPC-E	123



4.1 CODABAR

*Enable Codabar



100313

Disable Codabar



100312

4.1.1 START/STOP CHARACTERS SELECTION

Select one of the four different start/stop character pairs –

* abcd/abcd



100436

abcd/tn*e



100437

ABCD/ABCD



100438

ABCD/TN*E



100439



4.1.2 START/STOP TRANSMISSION

Decide whether or not to include the start/stop characters in the data being transmitted.

Transmit Codabar
Start/Stop Characters



*Do Not Transmit



4.1.3 CLSI CONVERSION

When enabled, the CLSI editing strips the start/stop characters and inserts a space after the first, fifth, and tenth characters of a 14-character Codabar barcode.

Apply CLSI Editing



*Do Not Apply



Note: The 14-character barcode length does not include start/stop characters.



4.2 CODE 25 – INDUSTRIAL 25

*Enable Industrial 25



Disable Industrial 25



4.2.1 START/STOP PATTERN SELECTION

This decides the readability of all 2 of 5 symbology variants. For example, flight tickets actually use an Industrial 2 of 5 barcode but with Interleaved 2 of 5 start/stop pattern. In order to read this barcode, the start/stop pattern selection parameter of Industrial 2 of 5 should be set to "Interleaved 25".

*Industrial 25
Start/Stop Pattern



Interleaved 25
Start/Stop Pattern



Matrix 25
Start/Stop Pattern



4.2.2 CHECKSUM VERIFICATION

Decide whether to verify the checksum. If the checksum is incorrect, the barcode will not be accepted.

Verify Industrial 25



*Do Not Verify



4.2.3 CHECKSUM TRANSMISSION

Decide whether to include the checksum in the data being transmitted.

*Transmit Industrial

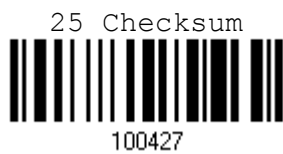

Do Not Transmit



4.2.4 CODE LENGTH QUALIFICATION

Because of the weak structure of the 2 of 5 symbologies, it is possible to make a "short scan" error. To prevent the "short scan" error, define the "Length Qualification" settings to ensure that the correct barcode is read by qualifying the allowable code length.

- ▶ If "Max/Min Length" is selected, the maximum length and the minimum length must be specified. It only accepts those barcodes with lengths that fall between max/min lengths specified.
- ▶ If "Fixed Length" is selected, up to 2 fixed lengths can be specified.

- 1) Read the label to enable either Max. /Min. Length qualification or Fixed Length(s) qualification.

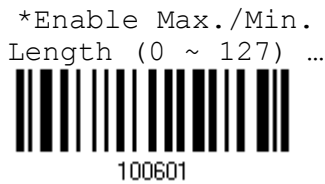

- 2) Read the label for Max. Length or Fixed Length 1, and follow steps 3~4.
Repeat steps 2~4 for Min. Length or Fixed Length 2.



- 3) Read the "[Decimal Value](#)" label on page 187 for the desired length.
- 4) Read the "Validate" label on the same page to complete this setting.



4.3 CODE 25 – INTERLEAVED 25

*Enable Interleaved 25



Disable Interleaved 25



4.3.1 START/STOP PATTERN SELECTION

This decides the readability of all 2 of 5 symbology variants. For example, flight tickets actually use an Industrial 2 of 5 barcode but with Interleaved 2 of 5 start/stop pattern. In order to read this barcode, the start/stop pattern selection parameter of Industrial 2 of 5 should be set to "Interleaved 25".

Industrial 25
Start/Stop Pattern



*Interleaved 25
Start/Stop Pattern



Matrix 25
Start/Stop Pattern



4.3.2 CHECKSUM VERIFICATION

Decide whether to verify the checksum. If the checksum is incorrect, the barcode will not be accepted.

Verify Interleaved 25
Checksum



*Do Not Verify



4.3.3 CHECKSUM TRANSMISSION

Decide whether to include the checksum in the data being transmitted.

*Transmit Interleaved
25 Checksum



Do Not Transmit



4.3.4 CODE LENGTH QUALIFICATION

Because of the weak structure of the 2 of 5 symbologies, it is possible to make a "short scan" error. To prevent the "short scan" error, define the "Length Qualification" settings to ensure that the correct barcode is read by qualifying the allowable code length.

- ▶ If "Max/Min Length" is selected, the maximum length and the minimum length must be specified. It only accepts those barcodes with lengths that fall between max/min lengths specified.
- ▶ If "Fixed Length" is selected, up to 2 fixed lengths can be specified.

- 1) Read the label to enable either Max. /Min. Length qualification or Fixed Length(s) qualification.

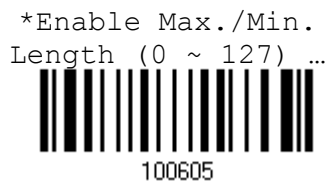

- 2) Read the label for Max. Length or Fixed Length 1, and follow steps 3~4.
Repeat steps 2~4 for Min. Length or Fixed Length 2.



- 3) Read the "[Decimal Value](#)" label on page 187 for the desired length.
- 4) Read the "Validate" label on the same page to complete this setting.



4.4 CODE 25 – MATRIX 25

Enable Matrix 25



100311

*Disable Matrix 25



100310

4.4.1 START/STOP PATTERN SELECTION

This decides the readability of all 2 of 5 symbology variants. For example, flight tickets actually use an Industrial 2 of 5 barcode but with Interleaved 2 of 5 start/stop pattern. In order to read this barcode, the start/stop pattern selection parameter of Industrial 2 of 5 should be set to "Interleaved 25".

Industrial 25
Start/Stop Pattern



100420

Interleaved 25
Start/Stop Pattern



100421

*Matrix 25
Start/Stop Pattern



100422



4.4.2 CHECKSUM VERIFICATION

Decide whether to verify the checksum. If the checksum is incorrect, the barcode will not be accepted.

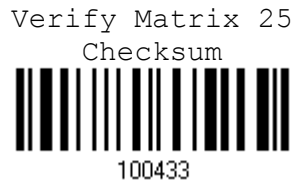

4.4.3 CHECKSUM TRANSMISSION

Decide whether to include the checksum in the data being transmitted.



4.4.4 CODE LENGTH QUALIFICATION

Because of the weak structure of the 2 of 5 symbologies, it is possible to make a "short scan" error. To prevent the "short scan" error, define the "Length Qualification" settings to ensure that the correct barcode is read by qualifying the allowable code length.

- ▶ If "Max/Min Length" is selected, the maximum length and the minimum length must be specified. It only accepts those barcodes with lengths that fall between max/min lengths specified.
- ▶ If "Fixed Length" is selected, up to 2 fixed lengths can be specified.

- 1) Read the label to enable either Max. /Min. Length qualification or Fixed Length(s) qualification.

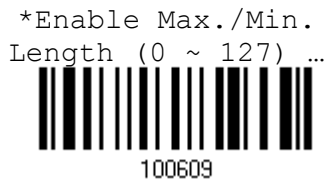

- 2) Read the label for Max. Length or Fixed Length 1, and follow steps 3~4.
Repeat steps 2~4 for Min. Length or Fixed Length 2.



- 3) Read the "[Decimal Value](#)" label on page 187 for the desired length.
- 4) Read the "Validate" label on the same page to complete this setting.



4.5 CODE 39

*Enable Code 39



Disable Code 39



4.5.1 START/STOP TRANSMISSION

Decide whether or not to include the start/stop characters in the data being transmitted.

Transmit Code 39
Start/Stop Characters



*Do Not Transmit



4.5.2 CHECKSUM VERIFICATION

Decide whether or not to perform checksum verification when decoding barcodes.

- ▶ If enabled and the checksum found incorrect, the barcode will not be accepted.

Verify Code 39 Checksum



*Do Not Verify



4.5.3 CHECKSUM TRANSMISSION

Decide whether or not to include the checksum character in the data being transmitted.

*Transmit Code 39
Checksum



Do Not Transmit



4.5.4 STANDARD/FULL ASCII CODE 39

Decide whether or not to support Code 39 Full ASCII that includes all the alphanumeric and special characters.

Code 39 Full ASCII



*Standard Code 39



4.6 CODE 93

You can only configure the scanner to read this symbology or not.

*Enable Code 93



Disable Code 93



4.7 CODE 128

You can only configure the scanner to read this symbology or not.

*Enable Code 128



Disable Code 128



4.8 EAN-8

*Enable EAN-8
(No Addon)



Disable EAN-8
(No Addon)



Enable EAN-8
Addon 2



*Disable EAN-8
Addon 2



Enable EAN-8
Addon 5



*Disable EAN-8
Addon 5



4.8.1 CONVERT TO EAN-13

Decide whether or not to expand the read EAN-8 barcode into EAN-13.

- ▶ If enabled, the next processing will follow the parameters configured for EAN-13.



4.8.2 CHECKSUM TRANSMISSION

Decide whether or not to include the checksum character in the data being transmitted.

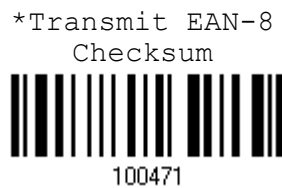

4.9 EAN-13

*Enable EAN-13
(No Addon)



Disable EAN-13
(No Addon)



Enable EAN-13
Addon 2



*Disable EAN-13
Addon 2



Enable EAN-13
Addon 5



*Disable EAN-13
Addon 5



4.9.1 ISBN CONVERSION

Decide whether or not to convert the EAN-13 barcode, starting with 978 and 979, to ISBN.

Convert EAN-13 to ISBN



*Do Not Convert



4.9.2 ISSN CONVERSION

Decide whether or not to convert the EAN-13 barcode, starting with 977 to ISSN.

Convert EAN-13 to ISSN



*Do Not Convert



4.9.3 CHECKSUM TRANSMISSION

Decide whether or not to include the checksum character in the data being transmitted.

*Transmit EAN-13
Checksum



Do Not Transmit



4.10 GS1-128 (EAN-128)

Enable EAN-128



100319

*Disable EAN-128



100318

4.10.1 CODE ID TRANSMISSION

Decide whether or not to include the Code ID ("1c1") in the data being transmitted.

Transmit EAN-128
Code ID



100519

*Do Not Transmit



100518

4.10.2 FIELD SEPARATOR (GS CHARACTER)

Decide whether or not to apply a field separator (to convert the FNC1 control character to human readable character).

Enable Field Separator ...



100616

- 1) Read the label above to enable field separator.
- 2) Read the "[Hexadecimal Value](#)" label on page 188 for the desired character string.
- 3) Read the "Validate" label to complete this setting.



Note: EAN-128 barcodes start with the `FNC1` control character to distinguish themselves from other uses of Code 128. `FNC1` is also used to separate data fields in the EAN-128 barcodes.

4.11 ISBT 128

You can only configure the scanner to read this symbology or not.

Enable ISBT 128



100355

*Disable ISBT 128



100354



4.12 MSI



4.12.1 CHECKSUM VERIFICATION

Select one of the three checksum calculations to perform checksum verification when decoding barcodes.

- ▶ If enabled and the checksum found incorrect, the barcode will not be accepted.

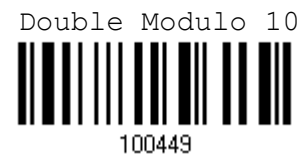

4.12.2 CHECKSUM TRANSMISSION

Decide whether or not to include the checksum character in the data being transmitted.

*Last Digit Not
Transmitted



100452

Both Digits
Transmitted



100453

Both Digits Not
Transmitted



100454



4.12.3 CODE LENGTH QUALIFICATION

Because of the weak structure of the symbology, it is possible to make a "short scan" error. To prevent the "short scan" error, define the "Length Qualification" settings to ensure that the correct barcode is read by qualifying the allowable code length.

- ▶ If "Max/Min Length" is selected, the maximum length and the minimum length must be specified. It only accepts those barcodes with lengths that fall between max/min lengths specified.
- ▶ If "Fixed Length" is selected, up to 2 fixed lengths can be specified.

Note: The specified barcode length(s) must include the checksum, regardless of which option is selected for "Checksum Transmission".

- 1) Read the label to enable either Max. /Min. Length qualification or Fixed Length(s) qualification.

*Enable Max./Min.
Length (0 ~ 127) ...



Enable Fixed Length(s) ...



- 2) Read the label for Max. Length or Fixed Length 1, and follow steps 3~4.
Repeat steps 2~4 for Min. Length or Fixed Length 2.

Max. Length (*127)
Or Fixed Length 1



Min. Length (*4)
Or Fixed Length 2



- 3) Read the "[Decimal Value](#)" label on page 187 for the desired length.
- 4) Read the "Validate" label on the same page to complete this setting.



4.13 FRENCH PHARMACODE

Enable French Pharmacode



100305

*Disable French Pharmacode



100304

4.13.1 CHECKSUM TRANSMISSION

Decide whether or not to include the checksum character in the data being transmitted.

*Transmit French Pharmacode Checksum



100411

Do Not Transmit



100410



4.14 ITALIAN PHARMACODE

Enable Italian Pharmacode



100303

*Disable Italian
Pharmacode

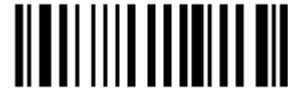

100302

4.14.1 CHECKSUM TRANSMISSION

Decide whether or not to include the checksum character in the data being transmitted.

*Transmit Italian
Pharmacode Checksum



100409

Do Not Transmit



100408



4.15 PLESSEY

Enable Plessey



*Disable Plessey



4.15.1 CONVERT TO UK PLESSEY

Decide whether or not to change each occurrence of the character 'A' to character 'X' in the decoded data.

Convert to UK Plessey



*Do Not Convert



4.15.2 CHECKSUM TRANSMISSION

Decide whether or not to include the checksum characters (two digits) in the data being transmitted.

*Transmit Plessey
Checksum



Do Not Transmit



4.16 GS1 DATABAR (RSS FAMILY)

4.16.1 CODE ID SELECTION

Select a desired Code ID to use – RSS Code ID "j e0" or EAN-128 Code ID "j c1".

"j c1" for RSS Code ID



"j e0" for RSS Code ID
(Default)



4.16.2 GS1 DATABAR OMNIDIRECTIONAL (RSS-14)

Enable RSS-14 &
RSS Expanded



*Disable RSS-14 &
RSS Expanded



Code ID Transmission

Decide whether or not to include the Code ID in the data being transmitted.

*Transmit RSS-14 Code ID



Do Not Transmit



Application ID Transmission

Decide whether or not to include the Application ID ("01") in the data being transmitted.

*Transmit RSS-14
Application ID



100529

Do Not Transmit



100528

Checksum Transmission

Decide whether or not to include the check digit in the data being transmitted.

*Transmit RSS-14
Checksum



100481

Do Not Transmit



100480

4.16.3 GS1 DATABAR EXPANDED (RSS EXPANDED)

Enable RSS-14 &
RSS Expanded



100349

*Disable RSS-14 &
RSS Expanded

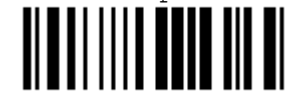

100348



Code ID Transmission

Decide whether or not to include the Code ID in the data being transmitted.



4.16.4 GS1 DATABAR LIMITED (RSS LIMITED)



Code ID Transmission

Decide whether or not to include the Code ID in the data being transmitted.



Application ID Transmission

Decide whether or not to include the Application ID ("01") in the data being transmitted.

*Transmit RSS Limited
Application ID



Do Not Transmit



Checksum Transmission

Decide whether or not to include the check digit in the data being transmitted.

*Transmit RSS
Limited Checksum



Do Not Transmit



4.17 TELEPEN

Enable Telepen



100353

*Disable Telepen



100352

4.17.1 TELEPEN OUTPUT – FULL ASCII/NUMERIC

Decide whether or not to support Telepen in full ASCII code. By default, it supports ASCII mode.

- ▶ AIM Telepen (Full ASCII) includes all the alphanumeric and special characters.

Original Telepen
(Numeric)



100485

* AIM Telepen



100484



4.18 UPC-A

*Enable UPC-A
(No Addon)



Disable UPC-A
(No Addon)



Enable UPC-A
Addon 2



*Disable UPC-A
Addon 2



Enable UPC-A
Addon 5



*Disable UPC-A
Addon 5



4.18.1 CONVERT TO EAN-13

Decide whether or not to expand the read UPC-A barcode into EAN-13.

- ▶ If enabled, the next processing will follow the parameters configured for EAN-13.



4.18.2 SYSTEM NUMBER TRANSMISSION

Decide whether or not to include the system number in the data being transmitted.

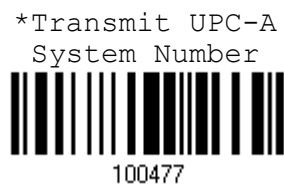

4.18.3 CHECKSUM TRANSMISSION

Decide whether or not to include the checksum character in the data being transmitted.

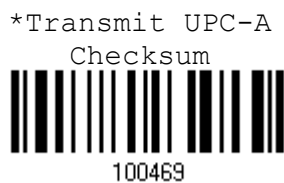

4.19 UPC-E

*Enable UPC-E
(No Addon)



Disable UPC-E
(No Addon)



Enable UPC-E
Addon 2



*Disable UPC-E
Addon 2



Enable UPC-E
Addon 5



*Disable UPC-E
Addon 5



4.19.1 SYSTEM NUMBER SELECTION

Decide whether to decode the ordinary UPC-E barcodes only or both UPC-E0 and UPC-E1 barcodes.

- ▶ System number 0 enabled for decoding UPC-E0 barcodes.
- ▶ System number 1 enabled for decoding UPC-E1 barcodes.

System Number 0 & 1



* System Number 0 Only



Warning: Because of the way system number 1 is encoded, if both system numbers are enabled, the user might suffer from short scanning UPC-A or EAN-13 barcodes into UPC-E1 barcodes.

4.19.2 CONVERT TO UPC-A

Decide whether or not to expand the read UPC-E barcode into UPC-A.

- ▶ If enable, the next processing will follow the parameters configured for UPC-A.

Convert UPC-E
to UPC-A



*Do Not Convert



4.19.3 SYSTEM NUMBER TRANSMISSION

Decide whether or not to include the system number in the data being transmitted.

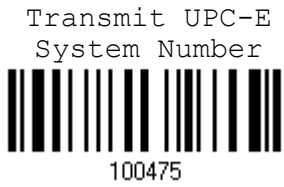

4.19.4 CHECKSUM TRANSMISSION

Decide whether or not to include the checksum character in the data being transmitted.

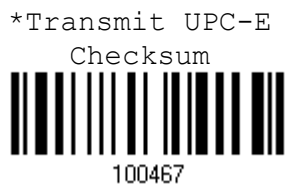



DEFINING OUTPUT FORMAT

You may configure in which format the collected data will be output to the host computer. Barcode read by the scanner will be processed in the following sequence –

- 1) Perform character substitution on the data scanned.
- 2) Add [Code ID](#) and [Length Code](#) to the front of the data: [Code ID] [Length Code] [Data]
- 3) Process the whole data in step 2 with user formats. Data is now divided into fields by user specified rules. Refer to [Chapter 6 Applying Formats for Data Editing](#).
- 4) Add [Prefix Code](#) and [Suffix Code](#) before transmission: [Prefix Code] [Processed Data] [Suffix Code]

IN THIS CHAPTER

5.1 Letter Case	127
5.2 Character Substitution	128
5.3 Prefix/Suffix Code	134
5.4 Code ID	135
5.5 Length Code	139
5.6 Multi-Barcode Editor	142
5.7 Removal of Special Character	145

5.1 LETTER CASE

By default, the alphabets transmission is case-sensitive, meaning that the alphabets will be transmitted according to their original case. Ignoring the original letter case, select [Upper Case] to output data in upper case only; otherwise, select [Lower Case] to output data in lower case only.

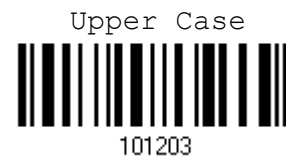

5.2 CHARACTER SUBSTITUTION

Character substitution is performed on every occurrence of the first character specified. If only one character is specified, every occurrence of that character in the barcode will be taken away.

- ▶ The first character will be replaced by the second character(s).
- ▶ Up to three sets of character substitution can be configured.

Note: The character substitution is performed only on the barcode itself and before the processing of editing formats. It is not applicable to the Prefix/Suffix Code, Code ID, Length Code, or any Additional Field.

5.2.1 SELECT A SET FOR CHARACTER SUBSTITUTION

Configure Set 1



Configure Set 2



Configure Set 3



- 1) Read the label above to enable character substitution by set.

For example, have the scanner read the "Set 1" label to configure the first set of character substitution. The scanner will respond with one short beep, high tone, to indicate more setup labels are required.

- 2) Read the "[Hexadecimal Value](#)" label on page 188 for the desired character string.

For example, have the scanner read (1) "3", "0", "2" and "D" to replace the character [0] with a dash [-] for Set 1, and (2) "3", "0", "2", "D", "3" and "0" to replace the character [0] with a dash [- 0] for Set 2.

- 3) Read the "Validate" label to complete this setting. (The defined set or sets will be applied to all symbologies by default.)



5.2.2 SYMBOLOGIES FOR CHARACTER SUBSTITUTION (ALL 3 SETS)

By default character substitution will be performed on all symbologies. If the character substitution is not desired with one or more symbologies, read the “Do Not Apply” label for each undesired symbologies and all the three sets will be ignored for them.

Character Substitution for Codabar



Character Substitution for Code 39



Character Substitution for Code 93



Character Substitution for Code 128



Character Substitution for GS1-128 (EAN-128)



Character Substitution for EAN-8 (No Addon)



Character Substitution for EAN-8 Addon 2



Character Substitution for EAN-8 Addon 5



Character Substitution for EAN-13 (No Addon)



Character Substitution for EAN-13 Addon 2



Character Substitution for EAN-13 Addon 5



Character Substitution for French Pharmacode



Character Substitution for Italian Pharmacode



Character Substitution for Industrial 25



Character Substitution for Interleaved 25



Character Substitution for Matrix 25



Character Substitution for MSI



Character Substitution for Plessey



Character Substitution for GS1 DataBar (RSS)



Character Substitution for Telepen



Character Substitution for UPC-A (No Addon)



Character Substitution for UPC-A Addon 2



Character Substitution for UPC-A Addon 5



Character Substitution for UPC-E (No Addon)



Character Substitution for UPC-E Addon 2



Character Substitution for UPC-E Addon 5



5.3 PREFIX/SUFFIX CODE

By default, there is no prefix code, and [ENTER] or [CR] (Carriage Return) is configured to be suffix code. Up to 8 characters can be configured, for example, "Barcode_", and you will have the string appear in front of the barcode read, like this – "Barcode_1234567890".

- ▶ If "BT HID", "USB HID" or "Keyboard Wedge" is configured for interface, [Key Type](#) and [Key Status](#) will then become applicable. You may decide whether or not to apply Key Status when "Normal Key" is selected for Key Type. Refer to [Keyboard Wedge Table](#).

Key Type		Key Status
Scan Code	Up to 4 scan code values are allowed.	N/A
Normal Key	Up to 8 character strings are allowed. ▶ Default setting	<ul style="list-style-type: none"> ▶ Add Shift ▶ Add Left Ctrl ▶ Add Left Alt ▶ Add Right Ctrl ▶ Add Right Alt ▶ Add Break For example, read labels for [Add Shift], [A], [Add Shift], and [B].

Configure Prefix



Configure Suffix



- 1) Read the label above to apply prefix code or suffix code separately, and follow steps 2~3. (Max. 8 characters each)
- 2) Read the "[Hexadecimal Value](#)" label on page 188 for the desired character string. For example, read "2" and "B" for the scanner to prefix or suffix the character [+].
- 3) Read the "Validate" label to complete this setting.



5.4 CODE ID

Up to two characters for Code ID can be configured for each symbology. To make the Code ID configuration easier, the scanner provides five pre-defined Code ID sets that you can select one and make necessary changes on it.

- ▶ If "BT HID", "USB HID" or "Keyboard Wedge" is configured for interface, [Key Type](#) and [Key Status](#) will then become applicable. You may decide whether or not to apply Key Status when "Normal Key" is selected for Key Type. Refer to [Keyboard Wedge Table](#).

Key Type		Key Status
Scan Code	Up to 1 scan code values are allowed.	N/A
Normal Key	Up to 2 character strings are allowed. <ul style="list-style-type: none"> ▶ Default setting 	<ul style="list-style-type: none"> ▶ Add Shift ▶ Add Left Ctrl ▶ Add Left Alt ▶ Add Right Ctrl ▶ Add Right Alt ▶ Add Break For example, read labels for [Add Shift] and the character [A].

Note: "]C1" is the Code ID of GS1-128 (EAN-128) barcodes; "]e0" is the default Code ID of GS1 DataBar (RSS) barcodes.

5.4.1 SELECT PRE-DEFINED CODE ID

Code ID options	Set 1	Set 2	Set 3	Set 4	Set 5
Code 39	A	C	Y	M	A
Italian Pharmacode	A	C	Y	M	A
French Pharmacode	A	C	Y	M	A
Industrial 25	C	H	H	H	S
Interleaved 25	D	I	Z	I	S
Matrix 25	E	G	G	G	S
Codabar	F	N	X	N	F
Code 93	I	L	L	L	G
Code 128	H	K	K	K	C
UPC-E	S	E	C	E	E
EAN-8	P	B	B	FF	E
EAN-13	M	A	A	F	E



UPC-A	J	A	A	A	E
MSI	V	V	D	P	M
Plessey	W	W	E	Q	P
Telepen	Z	---	---	---	---

Apply Code ID Set 1



Apply Code ID Set 2



Apply Code ID Set 3



Apply Code ID Set 4



Apply Code ID Set 5



5.4.2 CHANGE CODE ID

- 1) Read the label of a specific symbology below to change its code ID.
- 2) Read the "[Hexadecimal Value](#)" label on page 188 for the desired character string. For example, read "4" and "4" for applying the character [D] for Code ID.
- 3) Read the "Validate" label to complete this setting.



Configure Code ID
for Codabar



101456

Configure Code ID
for Code 39



101450

Configure Code ID
for Code 93



101457

Configure Code ID
for Code 128



101458

Configure Code ID
for EAN-8



101460

Configure Code ID
for EAN-13



101461

Configure Code ID for
French Pharmacode



101452

Configure Code ID for
Italian Pharmacode



101451

Configure Code ID
for Industrial 25



101453

Configure Code ID
for Interleaved 25



101454



Configure Code ID
for Matrix 25



Configure Code ID
for MSI



Configure Code ID
for Plessey



Configure Code ID
for Telepen



Configure Code ID
for UPC-A



Configure Code ID
for UPC-E



5.4.3 CLEAR CODE ID SETTINGS

Clear All Code ID Settings



5.5 LENGTH CODE

A two-digit code representing the length of barcode data (character count) can be inserted in front of data being transmitted. Such "Length" code can be individually enabled or disabled for each symbology.

Length Code for Codabar



Length Code for Code 39



Length Code for Code 93



Length Code for Code 128



Length Code for GS1-128 (EAN-128) & GS1 DataBar (RSS)



Length Code for EAN-8



Length Code for EAN-13



Length Code for French Pharmacode



Length Code for Italian Pharmacode



Length Code for Industrial 25



Length Code for Interleaved 25



Length Code for Matrix 25



Length Code for MSI



Length Code for Plessey



Length Code for Telepen



Length Code for UPC-A



Length Code for UPC-E



5.6 MULTI-BARCODE EDITOR

The Multi-Barcode Editor allows you to decide the output sequence of a concatenation of barcodes. Up to five barcodes can be specified. When you enable this mode, it will force the scanner to apply Laser mode as the scan mode.

Note: The Multi-Barcode Editor has nothing to do with [Multi-Barcode Mode](#).

The barcodes that are found meeting the specified criteria below will be arranged in the desired sequence.

- ▶ Code Type
- ▶ 4-digit barcode length, excluding prefix, suffix, length code, etc.
- ▶ Matching the first character of barcode data

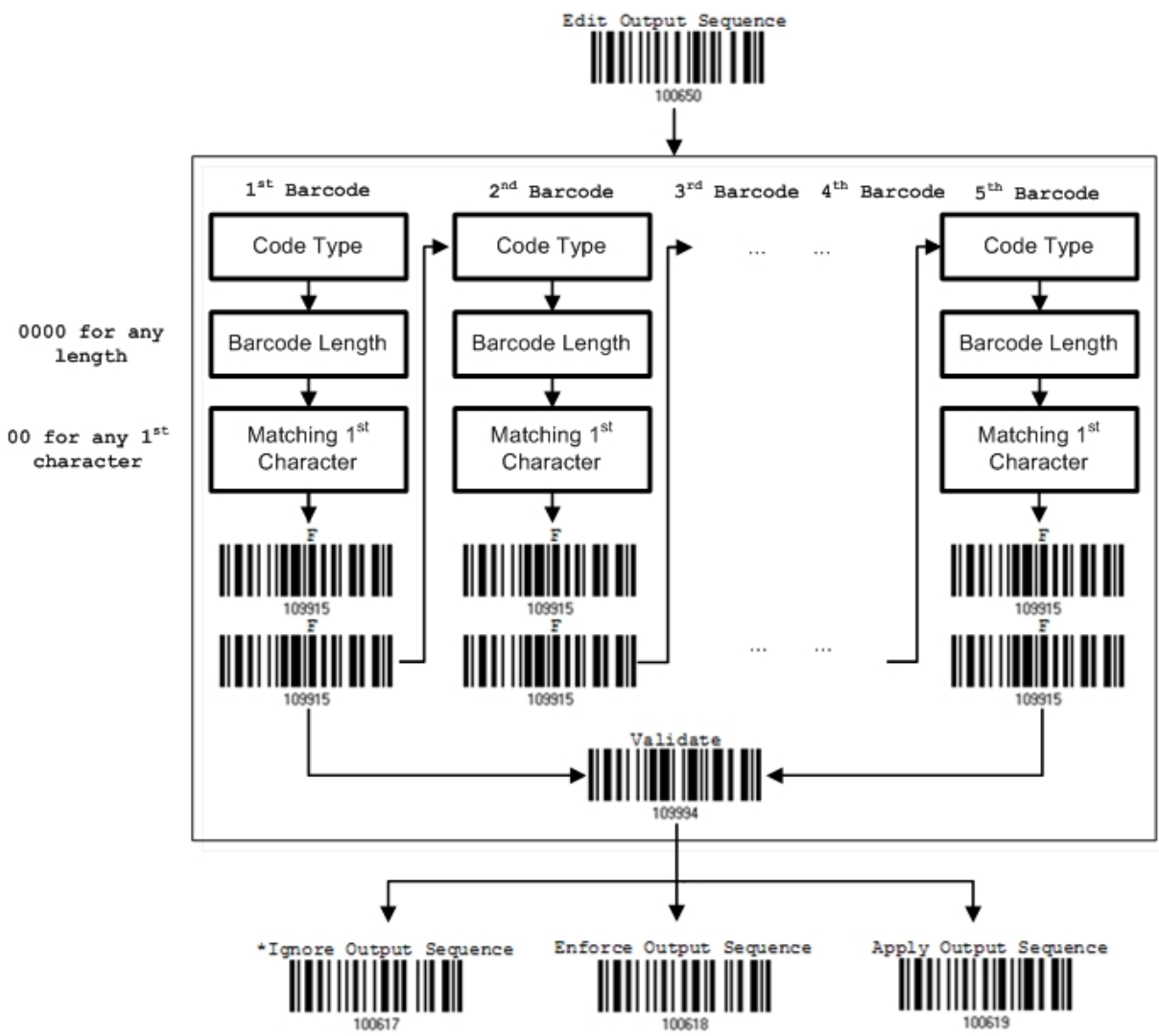

5.6.1 EDIT A CONCATENATION OF BARCODES

Edit Output Sequence



- 1) Read the label above to start editing a concatenation of barcodes.
- 2) Code Type setting – read the “[Hexadecimal Value](#)” label on page 188 for Code Type of the (first) barcode. For example, read “4” and “1” for Code 39.

Code Type	Symbology	Code Type	Symbology
41 (A)	Code 39	4F (O)	EAN-8 with Addon 5
42 (B)	Italian Pharmacode	50 (P)	EAN-13
43 (C)	French Pharmacode)	51 (Q)	EAN-13 with Addon 2
44 (D)	Industrial 25	52 (R)	EAN-13 with Addon 5
45 (E)	Interleaved 25	53 (S)	MSI
46 (F)	Matrix 25	54 (T)	Plessey
47 (G)	Codabar (NW7)	55 (U)	GS1-128 (EAN-128)
48 (H)	Code 93	56 (V)	UPC-A
49 (I)	Code 128	57 (W)	UPC-A with Addon 2
4A (J)	UPC-E0 / UPC-E1	58 (X)	UPC-A with Addon 5
4B (K)	UPC-E with Addon 2		
4C (L)	UPC-E with Addon 5	5A (Z)	Telepen
4D (M)	EAN-8	5B ([)	GS1 DataBar (RSS)
4E (N)	EAN-8 with Addon 2		

- 3) Barcode Length setting – read the “[Decimal Value](#)” label on page 187 for the 4-digit length of the (first) barcode. For example, read “0065” for barcode length of 65 characters or read “0000” for any length.

Note: If not reading 0000 for any length, the 4-digit length must exclude prefix, suffix (0x0d by default), length code, etc.

- 4) Matching Character setting – read the “[Hexadecimal Value](#)” label on page 188 for the 1st character that must be found matching in the (first) barcode. For example, read “4” and “1” for matching character “A” as the first character in the barcode or read “00” for any character.
- 5) Read twice the “F” label on page 188 (“FF”) to complete the setting of each barcode.
- 6) Read the “Validate” label to end the editing of the barcode set.



5.6.2 ACTIVATE THE CONCATENATION OF BARCODES

By default, the output sequence editing of the concatenation of barcodes is not applied.

When "Enforce Output Sequence" is enabled, all barcodes read by the scanner must meet with the criteria for the concatenation. If data is found excluded from all output sequence sets (= not meeting with the criteria), the scanner will not accept the reading, and therefore, data will not be transmitted.

When "Apply Output Sequence" is enabled, only barcodes found meeting with the criteria are counted for the concatenation. Those found not meeting with the criteria are processed normally and individually.

Note: When it requires reading more barcodes to complete the "output sequence" requirements, the scanner will respond with one short beep (low tone). After reading an acceptable barcode, its LED indicator will become solid green and go off quickly (= Good Read).

Upon completion of reading acceptable barcodes, the scanner will respond with one short beep (high tone) and its LED indicator will become solid green and go off quickly (= Good Read).

*Ignore Output Sequence



Enforce Output Sequence



Apply Output Sequence



Warning: When you disable the Multi-Barcode Editor later, the scan mode remains unchanged. If Laser mode is not desired, proceed to select a scan mode best suits your application.



5.7 REMOVAL OF SPECIAL CHARACTER

You can only specify 1 character, but it will remove every matching character encountered from the starting position of barcode data until a different character is met. For example, if it is configured to remove the character "0" (hex value is "30"), one or more zeros will be stripped off the barcode data "012345" and "00012345". However, for barcode data "010333", only the first zero will be stripped off.

- 1) Read the label below to remove the specified character.

Remove Special Character



101470

- 2) Read the "[Hexadecimal Value](#)" label on page 188 for the desired character. For example, read "3" and "0" for the scanner to remove the character "0".
- 3) Read the "Validate" label to complete this setting.





APPLYING FORMATS FOR DATA EDITING

The scanner allows advanced data editing by applying user-configured editing formats. The whole processed data can be divided into fields by user-specified rules. These fields together with the user-configurable additional fields consist of the data actually sent to the host computer.

[Prefix Code]	[Code ID]	[Length Code]	[Data]	[Suffix Code]	Additional Field(s)
None by default	None by default	None by default	Barcode itself	0x0d by default	

IN THIS CHAPTER

6.1 Format Selection	148
6.2 Editing Format.....	150
6.3 Programming Examples	166



6.1 FORMAT SELECTION

6.1.1 ACTIVATE EDITING FORMATS

If you have already configured any editing format before, you may directly apply the editing format. If not, you must start with configuring an editing format first, and then, activate the editing format when it is desired in use.

Editing Format 1



Editing Format 2



Editing Format 3



Editing Format 4



Editing Format 5



6.1.2 EXCLUSIVE DATA EDITING

By default, only barcodes found meeting with the criteria are processed by the editing formats. Those found not meeting with the criteria are processed normally.

When "Exclusive Data Editing" is enabled, all barcodes read by the scanner must be processed by the editing formats. If data is found excluded from all enabled editing formats (= not meeting with the specified criteria), the scanner will not accept the reading, and therefore, data will not be transmitted.



6.2 EDITING FORMAT

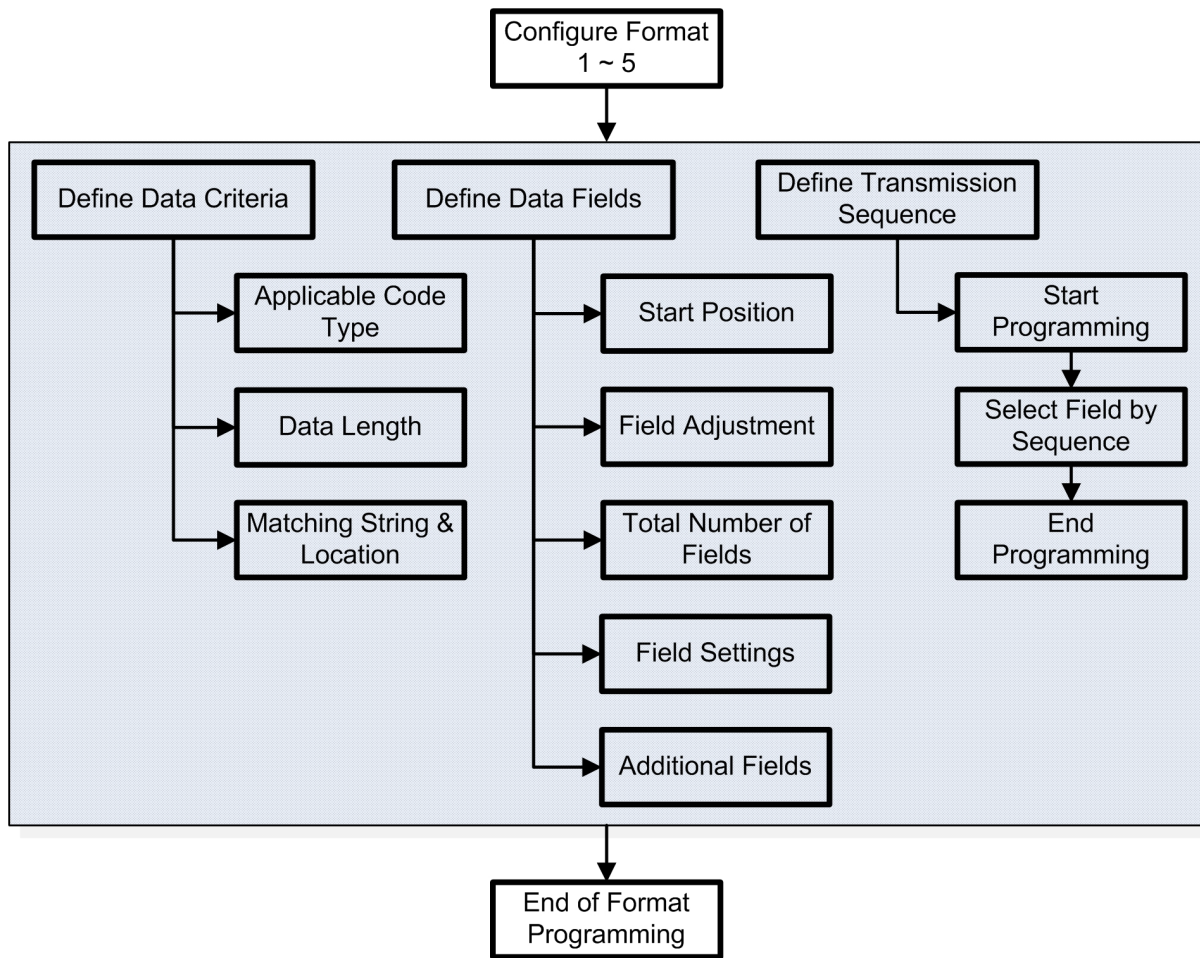

6.2.1 SELECT FORMAT TO CONFIGURE

Start Programming Format

Select one editing format (Format 1~5) and the parameters pertaining to the editing format can then be configured – applicable code type, data length, matching string & location, total number of fields, field settings (field-dividing rule), additional fields, and field transmission sequence.

- ▶ Up to five different formats can be specified.

Configure Format 1



Configure Format 2



Configure Format 3



Configure Format 4



Configure Format 5



Note: Before you complete the programming of an editing format, if you have the scanner read any label for parameters other than those pertaining to the editing format, it will automatically abort the programming process.

End Programming Format

After having configured all the desired parameters, you must have the scanner read the “End Programming Format” label, which can be located at the bottom of every even page in this chapter.

End Programming Format



6.2.2 RESTORE DEFAULT FORMAT

You may select an existing editing format and have the defaults restored. The default settings of an editing format are listed below.

Editing format	Defaults
Applicable Code Type	All
Data Length	0 (No qualification.)
Matching String	Disable
Matching String Location	None
Total Number of Fields	1
Field Setting – field-dividing rule	Not configured.
Additional Fields	None
Field Transmission Sequence	F1

Restore Default Format



109990



6.2.3 DEFINE DATA CRITERIA

Three applicable conditions can be configured to check whether the data read by the scanner can be processed by the particular editing format.

Note: Data editing cannot be performed unless the three conditions are all met.

Applicable Code Type

By default, barcodes of all the supported symbologies will be processed by any editing format, if having been configured and enabled.

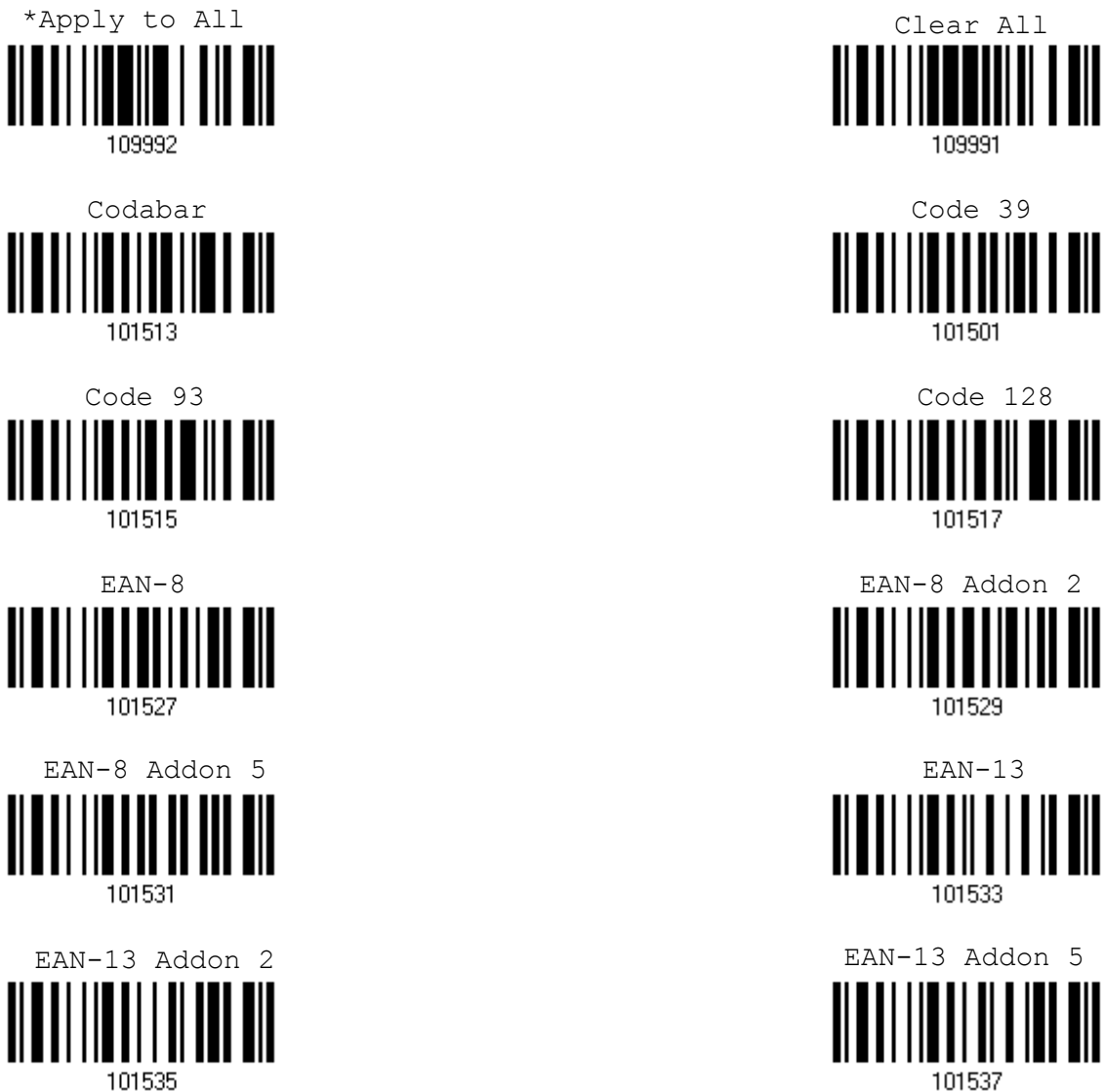

EAN-128 & RSS



101519

French Pharmacode



101505

Italian Pharmacode



101503

Industrial 25



101507

Interleaved 25



101509

Matrix 25



101511

MSI



101545

Plessey



101547

Telepen



101549

UPC-A



101539

UPC-A Addon 2



101541

UPC-A Addon 5



101543

UPC-E



101521

UPC-E Addon 2



101523

UPC-E Addon 5



101525

Data Length

The length must include prefix, suffix (0x0d by default), length code, etc. By default, barcodes of any length (character count) are eligible for data editing.



- ▶ You may specify a value from 0 to 254.
- ▶ When zero is given to both, the scanner will not perform the length qualification.

1. Read the label below to specify Max. Length or Min. Length separately, and follow steps 2~3.



2. Read the "[Decimal Value](#)" label on page 187 for the desired length.
3. Read the "Validate" label on the same page to complete this setting.

Matching String & Location

By default, no matching string is specified, and therefore, it is disabled. You may enable this feature by specifying a matching string; up to four characters are allowed.

- ▶ When the Matching String Location is zero, the scanner will only check for the existence of the matching string in the barcode data.
- ▶ You may specify a value from 1 to 254 to indicate where the matching string starts in the barcode data.

1. Read the label to specify a matching string.

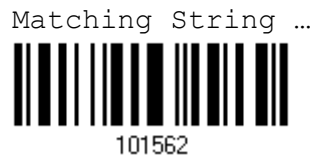

2. Read the "[Hexadecimal Value](#)" label on page 188 for the desired character string.
3. Read the "Validate" label to complete this setting.
4. Read the label to specify the location of the matching string.

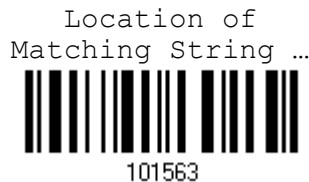

5. Read the "[Decimal Value](#)" label on page 187 for the desired location.
6. Read the "Validate" label on the same page to complete this setting.



6.2.4 DIVIDE DATA INTO FIELDS

Start Position

Data can be divided into fields in one of the following direction –

- ▶ from head (F1) to tail (F5)
- ▶ from tail (F1) to head (F5)



Field Adjustment

You may apply equal length to all fields, if necessary. It will add "Space" (0x20) to field when data is found shorter than specified.

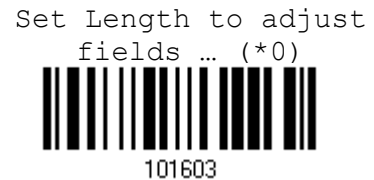

1. Read the label above to adjust field by length.
2. Read the "[Decimal Value](#)" label on page 187 for the desired field length.
3. Read the "Validate" label on the same page to complete this setting.

Total Number of Fields

Data can be divided into at most 6 fields; each of them is numbered from F1 to F6 accordingly. However, only F1~F5 can be configured.

- ▶ The total number of fields must be specified correctly. If three fields are configured for the editing format, the data characters after F3 will be assigned to F4 automatically. This feature is quite useful especially when data of variable lengths is processed by editing formats.





Note: The number of configurable fields is always one less than the total number of fields specified. The extra data characters beyond the last field configured will be automatically assigned to the next field.



6.2.5 FIELD SETTINGS

Data eligible for editing formats is divided into fields by user-specified rules – either using the field terminating string or specified field length.

<p>By Terminating String</p> <p>Specify the field terminating string. Up to two characters are allowed. The scanner will search for the occurrence of this particular string in the data.</p> <p>▶ By default, this string will be included in the field. You may discard it.</p>
<p>By Length</p> <p>Alternatively, you may simply specify the field length. The scanner will assign the next specified number of characters into the field.</p>

Field 1 Setting

Select Field Separator
to Divide Field 1 ...



1. Read the above label to divide field by a specified terminating string.
2. Read the "[Hexadecimal Value](#)" label on page 188 for the desired character string.
3. Read the "Validate" label to complete this setting.
4. Read the "Discard Separator" label if the field separator is not desired in the field.

*Include Separator



Discard Separator



If not dividing the field by a specific separator, you may divide it by a specified length.

Divide Field 1 by Length ...



1. Read the above label to divide field by length.
2. Read the "[Decimal Value](#)" label on page 187 for the desired field length.
3. Read the "Validate" label on the same page to complete this setting.



Field 2 Setting

Select Field Separator
to Divide Field 2 ...



1. Read the above label to divide field by a specified terminating string.
2. Read the "[Hexadecimal Value](#)" label on page 188 for the desired character string.
3. Read the "Validate" label to complete this setting.
4. Read the "Discard Separator" label if the field separator is not desired in the field.

*Include Separator



Discard Separator



If not dividing the field by a specific separator, you may divide it by a specified length.

Divide Field 2 by Length ...



1. Read the above label to divide field by length.
2. Read the "[Decimal Value](#)" label on page 187 for the desired field length.
3. Read the "Validate" label on the same page to complete this setting.



Field 3 Setting

Select Field Separator
to Divide Field 3 ...



1. Read the above label to divide field by a specified terminating string.
2. Read the "[Hexadecimal Value](#)" label on page 188 for the desired character string.
3. Read the "Validate" label to complete this setting.
4. Read the "Discard Separator" label if the field separator is not desired in the field.

*Include Separator



Discard Separator



If not dividing the field by a specific separator, you may divide it by a specified length.

Divide Field 3 by Length ...



1. Read the above label to divide field by length.
2. Read the "[Decimal Value](#)" label on page 187 for the desired field length.
3. Read the "Validate" label on the same page to complete this setting.



Field 4 Setting

Select Field Separator
to Divide Field 4 ...



1. Read the above label to divide field by a specified terminating string.
2. Read the "[Hexadecimal Value](#)" label on page 188 for the desired character string.
3. Read the "Validate" label to complete this setting.
4. Read the "Discard Separator" label if the field separator is not desired in the field.

*Include Separator



Discard Separator



If not dividing the field by a specific separator, you may divide it by a specified length.

Divide Field 4 by Length ...



1. Read the above label to divide field by length.
2. Read the "[Decimal Value](#)" label on page 187 for the desired field length.
3. Read the "Validate" label on the same page to complete this setting.



Field 5 Setting

Select Field Separator
to Divide Field 5 ...



101583

1. Read the above label to divide field by a specified terminating string.
2. Read the "[Hexadecimal Value](#)" label on page 188 for the desired character string.
3. Read the "Validate" label to complete this setting.
4. Read the "Discard Separator" label if the field separator is not desired in the field.

*Include Separator



101581

Discard Separator



101580

If not dividing the field by a specific separator, you may divide it by a specified length.

Divide Field 5 by Length ...



101582

1. Read the above label to divide field by length.
2. Read the "[Decimal Value](#)" label on page 187 for the desired field length.
3. Read the "Validate" label on the same page to complete this setting.



Additional Fields

Up to five additional fields can be created for each editing format; each of them is numbered from AF1 to AF5 accordingly.

1. Read the label below to specify an additional field, one at a time.
2. Read the "[Hexadecimal Value](#)" label on page 188 for the desired additional field.
3. Read the "Validate" label to complete this setting.

Additional Field 1 ...



Additional Field 2 ...



Additional Field 3 ...



Additional Field 4 ...



Additional Field 5 ...



- ▶ If "BT HID", "USB HID" or "Keyboard Wedge" is configured for interface, [Key Type](#) and [Key Status](#) will then become applicable. You may decide whether or not to apply Key Status when "Normal Key" is selected for Key Type. Refer to [Keyboard Wedge Table](#).

Key Type		Key Status
Scan Code	Up to 2 scan code values are allowed.	N/A
Normal Key	Up to 4 character strings are allowed. <ul style="list-style-type: none"> ▶ Default setting 	<ul style="list-style-type: none"> ▶ Add Shift ▶ Add Left Ctrl ▶ Add Left Alt ▶ Add Right Ctrl ▶ Add Right Alt ▶ Add Break For example, read labels for [Add Shift], [A], [Add Shift], and [B].



6.2.6 FIELD TRANSMISSION SEQUENCE

After configuring the data fields and additional fields, you must now program the transmission sequence of these fields that comprise the final data. This field transmission sequence can be assigned in any desired order and fields can be assigned multiple times as well.

Note: Up to twelve fields can be assigned.

- 1) Read the "Start" label to begin with programming the field transmission sequence.

Start (Programming) ...



101589

- 2) Program the transmission sequence by reading the desired fields as well as additional fields.

Field 1



109901

Field 2



109902

Field 3



109903

Field 4



109904

Field 5



109905

Field 6



109906

Additional Field 1



109907

Additional Field 2



109908

Additional Field 3



109909

Additional Field 4



109910

Additional Field 5



109911



3) Read the "End" label to complete this setting.



6.3 PROGRAMMING EXAMPLES

6.3.1 EXAMPLE I

Extract data from the 10th character to the 19th character...

The editing format should be configured as follows:

1. Read the "Enter Setup" label to enter the Configuration Mode.
2. Read the "Configure Format 1" label.
3. Read the "Clear All" and "Code 128" labels for applicable code type.
4. Read the "Three Fields" label.
5. Read the "Divide Field 1 by Length" label, and set length to 9.
Field 1 data starts from the 1st character to the 9th character.
6. Read the "Divide Field 2 by Length" label, and set length to 10.
Field 2 data starts from the 10th character to the 19th character.
7. Read the "Start (Programming)" label to program the transmission sequence.
8. Read the "Field 2" label.
9. Read the "End" label to complete the transmission sequence setting.
10. Read the "End Programming Format" label to complete the setting of Editing Format 1.
11. Read the "Enable Format 1" label to apply Editing Format 1 to Code 128.
12. Read the "Update" label to exit the Configuration Mode.



6.3.2 EXAMPLE II

Extract the date code, item number, and quantity information from barcodes.

Data in a barcode is encoded like this:

- ▶ From the 1st character to the 6th character is the date code.
- ▶ From the 7th character to the dash '-' character is the item number.
- ▶ After the dash '-' character is the quantity information.

Data will be transmitted like this:

- ▶ The item number goes first, then a TAB character, followed by the date code, then another TAB character, and finally the quantity information.

The editing format should be configured as follows:

1. Read the "Enter Setup" label to enter the Configuration Mode.
2. Read the "Configure Format 2" label.
3. Read the "Three Fields" label.
4. Read the "Divide Field 1 by Length" label, and set length to 6.
Field 1 data starts from the 1st character to the 6th character.
5. Read the "Select Field Separator to Divide Field 2" label, and use a dash '-' character.
Field 2 data starts from the 7th character until the dash '-' character is met.
6. Read the "Additional Field 1" label, and use a tab character for the field.
7. Read the "Start (Programming)" label to program the transmission sequence.
8. Read the "Field 2", "Additional Field 1", "Field 1", "Additional Field 1", "Field 3" labels.
9. Read the "End" label to complete the transmission sequence (F2 A1 F1 A1 F3) setting.
10. Read the "End Programming Format" label to complete the setting of Editing Format 1.
11. Read the "Enable Format 2" label to apply Editing Format 2 to all code types.
12. Read the "Update" label to exit the Configuration Mode.





SPECIFICATIONS

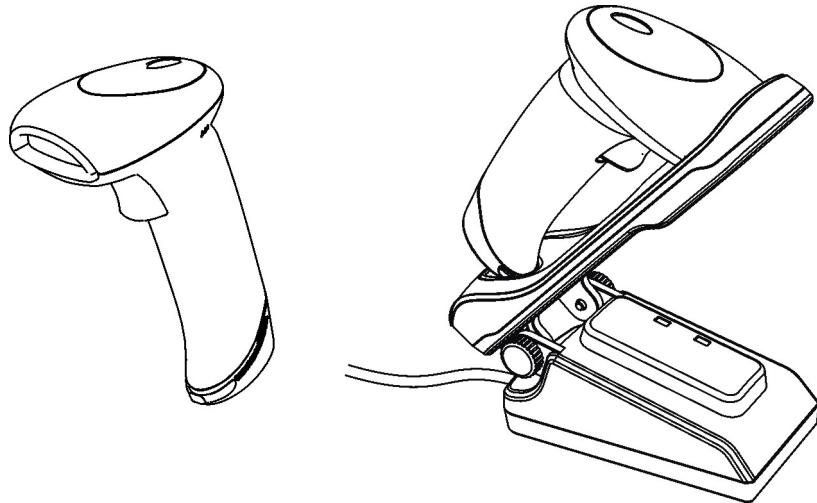

Optical Characteristics	1560	1562
Scan Engine	Non-contact type	Non-contact type
Optical Sensor	CCD, 2500 pixels	Laser
Light Source	Visible red LED	Visible laser diode
RF Characteristics		
WPAN Module	Wireless PAN BT Class 2 compliance	
Coverage (line-of-sight)	90 meters with 3656	
Interface Supported	<ul style="list-style-type: none"> ▶ Serial Port Profile (BT SPP) ▶ Human Interface Device Profile (BT HID) ▶ 3656 	
Physical Characteristics		
Memory	<ul style="list-style-type: none"> ▶ 4 KB for transmit buffer ▶ 512 KB flash for memory mode 	
Switch	Tactile switch	
Weight	Approx. 170 g	Approx. 175 g
Color	Black	



Electrical Characteristics		
Battery	Rechargeable Li-ion battery – 3.7 V, 800 mAh DC 5V ± 5% (with adaptor)	
Power Adapter		
Input	AC 100~240 V, 50/60 Hz	
Output	DC 5V ± 5% (with adaptor via 3656)	
Environmental Characteristics		
Temperature	Operating	0 °C to 50 °C
	Storage	-20 °C to 60 °C
Humidity (Non-condensing)	Operating	10% to 90%
	Storage	5% to 95%
Resistance		
Impact Resistance	1.5 m, 5 drops per 6 sides	
Electrostatic Discharge	± 15 kV air discharge, ± 8 kV contact discharge	
Regulations		
EMC Regulation	FCC, IC, CE, C-Tick, KCC, NCC, SRMC, TELEC	
Programming Support		
Configuration via Setup Labels	Use setup labels or host serial commands.	
Software	Windows®-based ScanMaster	
Firmware upgradeable	Download firmware updates via the download utility.	
Accessories (√ means “supported”)		
Rechargeable Li-ion Battery	√	√
3656 Stand	√	√

Note: The 3656 stand is not only an Auto-Sense stand (for 1560 only) and capable of charging the 1560/1562 scanner, but specifically designed for the scanner to communicate with a host computer wirelessly.



FIRMWARE UPGRADE

You can only upgrade firmware of one scanner at a time. For example, you must turn off each of the rest 1560/1562 scanner when there is more than one scanner connected to your computer.

Note: In case it fails downloading due to low battery, make sure the target scanner is loaded with good alkaline batteries and the battery charge is enough.

HOW TO UPGRADE 1560/1562 FIRMWARE

USING 3656

- 1) Connect the interface cable, RS-232 or USB, between 3656 and your computer.
- 2) Connect the power supply cord from 3656 to a proper power outlet.
- 3) Refer to [3.1.1 Connect to 3656](#) for the target scanner to connect to 3656.
Read the "Set Connection" label first, and then the "Serial Number" label. Both labels can be located at the back of 3656.
- 4) Read the following labels in sequence to configure the scanner to use RS-232 or USB Virtual COM as output interface.

Enter Setup



Activate RS-232



100001

Activate USB Virtual COM



100004

115200 bps



100080

Update



109999



- 5) Read the following labels in sequence for the scanner to enter the download mode. The scanner will respond with beeps to indicate it is ready for downloading.



- 6) Run the download utility "ProgLoad.exe" on your computer.
 - 1. For the communication settings, select "RS-232" and the correct COM port. For RS-232, select 115200 bps for baud rate. For USB Virtual COM interface, ignore the baud rate setting.
 - 2. For the file option, click [Browse] to select the target file for firmware update – Kernel (K*.shx) or user program (STD*.shx).
 - 3. Click [OK].

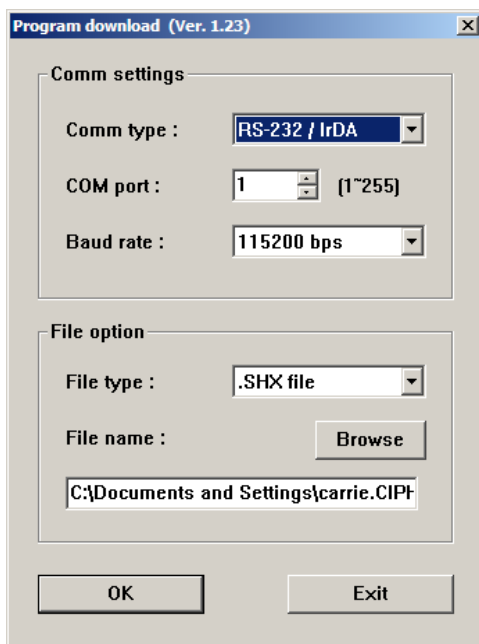

- 7) After upgrading kernel, you will need to manually restart the scanner. After upgrading the user program, the scanner will automatically restart itself once the download is completed successfully.

Note: The output interface remains unchanged as specified in step 4 (= RS-232 or USB Virtual COM). For RS-232, the baud rate setting is still 115200 bps!



USING A GENERIC DONGLE

- 1) Refer to [3.2.3 Connect to Dongle](#) for the target scanner to accept the connection request from your computer.
- 2) Read the following labels in sequence to configure the scanner to use BT SPP as output interface.

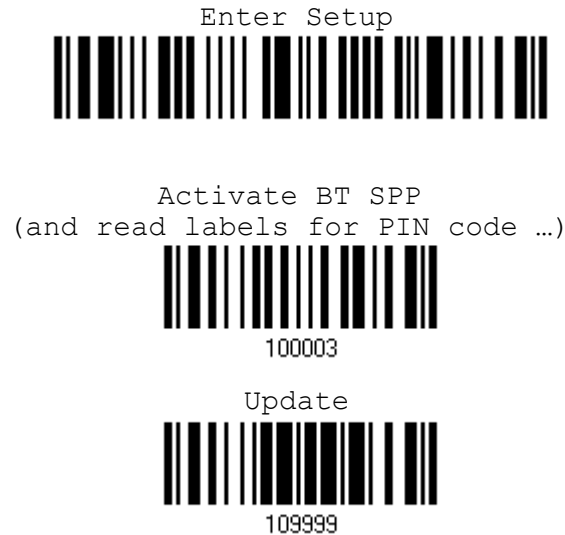

- 3) Read the following labels in sequence for the scanner to enter the download mode. The scanner will respond with beeps to indicate it is ready for downloading.



- 4) Run the download utility "ProgLoad.exe" on your computer.
 1. For the communication settings, select "RS-232" and the correct COM port for BT SPP interface, and ignore the baud rate setting.
 2. For the file option, click [Browse] to select the target file for firmware update — Kernel (K*.shx) or user program (STD*.shx).
 3. Click [OK].



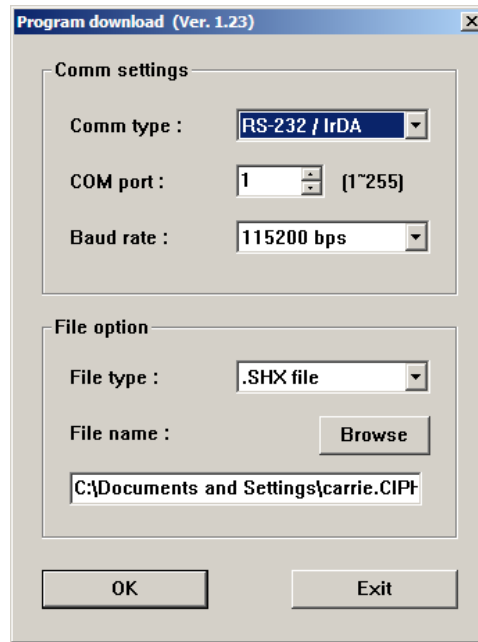

- 5) After upgrading kernel, you will need to manually restart the scanner.
After upgrading the user program, the scanner will automatically restart itself once the download is completed successfully.

Note: The output interface remains unchanged as specified in step 2 (= BT SPP).



HOW TO UPGRADE 3656 FIRMWARE

UPGRADING 3656 CPU FIRMWARE

- 1) Connect the interface cable, RS-232 or USB, between 3656 and your computer.
- 2) Connect the power supply cord from 3656 to a proper power outlet.
- 3) Refer to [3.1.1 Connect to 3656](#) for the target scanner to connect to 3656.

Read the "Set Connection" label first, and then the "Serial Number" label. Both labels can be located at the back of 3656.

- 4) Read the following labels in sequence to configure the scanner to use RS-232 or USB Virtual COM as output interface.



- 5) Read the following labels in sequence for 3656 to enter the download mode. The Communication LED on 3656 will be flashing red to indicate it is ready for downloading.



- 6) Run the download utility "ProgLoad.exe" on your computer.
 1. For the communication settings, select "RS-232" and the correct COM port.
For RS-232, select 115200 bps for baud rate.
For USB Virtual COM interface, ignore the baud rate setting.
 2. For the file option, click [Browse] to select the target file for firmware update (3656*.shx).
 3. Click [OK].
- 7) The 3656 will automatically restart itself when upgrading firmware is completed successfully.
- 8) Read the "Update" label for the scanner to resume its operation (exit the configuration mode).



UPGRADING 3656 USB BRIDGE FIRMWARE

- 1) Connect the USB cable between 3656 and your computer.
- 2) Connect the power supply cord from 3656 to a proper power outlet.
- 3) Refer to [3.1.1 Connect to 3656](#) for the target scanner to connect to 3656.

Read the "Set Connection" label first, and then the "Serial Number" label. Both labels can be located at the back of 3656.

- 4) Read the following labels in sequence to configure the scanner to use USB Virtual COM as output interface.



Note: You can download USB Bridge firmware via USB Virtual COM only!

- 5) Read the following labels in sequence for 3656 to enter the download mode. The Communication LED on 3656 will be flashing red to indicate it is ready for downloading.

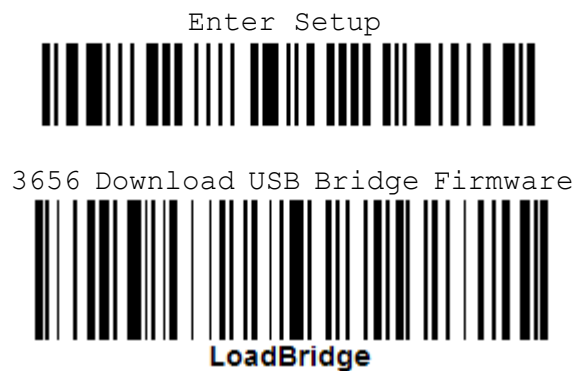

- 6) Run the download utility "ProgLoad.exe" on your computer.



1. For the communication settings, select "RS-232" and the correct COM port for USB Virtual COM interface, and ignore the baud rate setting.
 2. For the file option, click [Browse] to select the target file for firmware update (3656*.shx).
 3. Click [OK].
- 7) The 3656 will automatically restart itself when upgrading firmware is completed successfully.
- 8) Read the "Update" label for the scanner to resume its operation (exit the configuration mode).



HOST SERIAL COMMANDS

1560/1562 SERIAL COMMANDS

D

Purpose To disable the scanner.
Remarks "D"

E

Purpose To enable the scanner.
Remarks "E"

#@ nnnnnn <CR>

Purpose To configure the scanner.
Remarks nnnnnn – the six digits of command parameters.
For example, "109952" is to list the current Code ID settings.



"0x23" + "0x40" + "0x31" + "0x30" + "0x39" + "0x39" + "0x35" + "0x32" + "0x0d"

Note: After configuring the scanner, you may send the serial command "#@109999" to save the settings.

#@ ----<CR>

Purpose To halt the scanner.
Remarks "0x23" + "0x40" + "0x2d" + "0x2d" + "0x2d" + "0x2d" + "0x0d"

#@<CR>

Purpose To resume operation.
Remarks "0x23" + "0x40" + "0x2e" + "0x2e" + "0x2e" + "0x2e" + "0x0d"

#@////<CR>

Purpose To respond with a beep.
Remarks "0x23" + "0x40" + "0x2f" + "0x2f" + "0x2f" + "0x2f" + "0x0d"



#@TRIGOFF<CR>

Purpose	To disable the software trigger
Remarks	"0x23" + "0x40" + "0x54" + "0x52" + "0x49" + "0x47" + "0x4f" + "0x46" + "0x46" + "0x0d"

#@TRIGON<CR>

Purpose	To enable the software trigger
Remarks	"0x23" + "0x40" + "0x54" + "0x52" + "0x49" + "0x47" + "0x4f" + "0x4e" + "0x0d"

EXAMPLE

You may run HyperTerminal.exe on the host computer to send serial commands to the 1560/1562 scanner via RS-232, USB Virtual COM or BT SPP.

- ▶ For the scanner to stop immediately –
D
- ▶ For the scanner to resume working –
E
- ▶ For the scanner to change the beeper to medium volume and beep –
#@101011<CR>
#@////<CR>
- ▶ For the scanner to change the beeper to minimal volume and beep –
#@101010<CR>
#@////<CR>
- ▶ For the scanner to change the beeper frequency to 8 kHz (for Good Read Beep only) and beep –
#@101001<CR>
#@////<CR>
- ▶ For the scanner to change the beeper length to longest (for Good Read Beep only) and beep –
#@101008<CR>
#@////<CR>
- ▶ For the scanner to save the settings, send the serial command "#@109999" –
#@101011<CR>
#@109999<CR>

Note: (1) For RS-232 or USB Virtual COM, you can only configure the first scanner that connects to 3656. To identify the scanner, you may send the serial command to have it respond with a beep.

(2) For BT SPP, you can configure up to seven scanners at the same time.



Config<CR>

Purpose To configure 3656.

Remarks A list of the current settings will be displayed. Run HyperTerminal.exe on your computer and change the settings one by one.



DefaultSetting<CR>

Purpose To restore the default settings.



SingleConnection<CR>

Purpose To allow only one scanner connecting to 3656.



MultiConnection<CR>

Purpose To allow up to seven scanners connecting to 3656.



UseOnePortforAll<CR>

Purpose To use one Virtual COM port for all whenever connecting 3656 to PC via USB. This setting requires you to connect one 3656 at a time, and will facilitate configuring a great amount of 3656 via the same Virtual COM port (for administrators' or factory use).



UseVariablePort<CR>

Purpose To use variable Virtual COM port when connecting more than one 3656 to PC via USB.

Remarks 
UseVariablePort

Version<CR>

Purpose To get the firmware versions (CPU+USB Bridge).

Remarks 
Version

GetID<CR>

Purpose To get MAC ID.

Remarks 
GetID

Download<CR>

Purpose To download CPU firmware to 3656 via RS-232 or USB.

Remarks 
Download

LoadBridge<CR>

Purpose To download USB Bridge firmware to 3656 via USB only.

Remarks 
LoadBridge



EXAMPLE

Without using the scanner to read the above setup labels for configuring the 3656 stand, you may run HyperTerminal.exe on the host computer to send serial commands to 3656 via RS-232, USB Virtual COM or HID.

- 1) Connect the interface cable, RS-232 or USB, between 3656 and your computer.
- 2) Connect the power supply cord from 3656 to a proper power outlet.

The Communication LED will indicate when 3656 can accept serial commands after initializing. Refer to the table below.

Communication LED		Meaning
---	Blue, solid	Initialize
Red, solid	Blue, flashing	Serial command mode with USB Virtual COM or RS-232: wait 3 seconds for starting a serial command
Red, flashing	Blue, flashing	Serial command mode with USB HID: wait 3 seconds for pressing [NumLock] or [CapsLock] 5 times via keyboard

- ▶ If the output interface is USB Virtual COM or RS-232, run HyperTerminal.exe on your computer. While the Communication LED on 3656 is purple (red with flashing blue), type the serial command within three seconds.
- ▶ If the output interface is USB HID, press the "NumLock" or "CapsLoack" key on your keyboard 5 times within 3 seconds while the Communication LED on 3656 is flashing red and blue. This will change the interface from USB HID to USB Virtual COM and the Communication LED will become purple (red with flashing blue). Then, run HyperTerminal.exe on your computer. While the Communication LED on 3656 is purple (red with flashing blue), type the serial command within three seconds. After configuring via serial commands, the interface will be reset to USB HID after re-connecting the power supply cord.



KEYBOARD WEDGE TABLE

	0	1	2	3	4	5	6	7	8
0		F2	SP	0	@	P	`	p	⓪
1	INS	F3	!	1	A	Q	a	q	①
2	DLT	F4	"	2	B	R	b	r	②
3	Home	F5	#	3	C	S	c	s	③
4	End	F6	\$	4	D	T	d	t	④
5	Up	F7	%	5	E	U	e	u	⑤
6	Down	F8	&	6	F	V	f	v	⑥
7	Left	F9	'	7	G	W	g	w	⑦
8	BS	F10	(8	H	X	h	x	⑧
9	HT	F11)	9	I	Y	i	y	⑨
A	LF	F12	*	:	J	Z	j	z	
B	Right	ESC	+	;	K	[k	{	
C	PgUp	Exec	,	<	L	\	l		
D	CR	CR*	-	=	M]	m	}	
E	PgDn		.	>	N	^	n	~	
F	F1		/	?	O	_	o	Dly	ENTER*

Note: (1) ⓪~⑨: Digits of numeric keypad.
 (2) CR*/Send/ENTER*: ENTER key on the numeric keypad.

KEY TYPE

If "BT HID", "USB HID" or "Keyboard Wedge" is configured for interface, Key Type and Key Status will then become applicable.

*Normal



109926





KEY STATUS

Decide whether or not to change key status when "Normal Key" is selected for Key Type.



USER-DEFINED SCAN CODE

1) Read the "Set Scan Code" label to define new scan code.



2) Read the "[Hexadecimal Value](#)" label on page 188 for the desired character string.

3) Read the "Validate" label to complete this setting.

4) Read the "Confirm" label to confirm the action.



NUMERAL SYSTEMS

DECIMAL SYSTEM

Decimal



Validate the Values



HEXADECIMAL SYSTEM

Hexadecimal



Validate the Values



ASCII TABLE

	0	1	2	3	4	5	6	7	
0		DLE	SP	0	@	P	`	p	
1	SOH	DC1	!	1	A	Q	a	q	
2	STX	DC2	"	2	B	R	b	r	
3	ETX	DC3	#	3	C	S	c	s	
4	EOT	DC4	\$	4	D	T	d	t	
5	ENQ	NAK	%	5	E	U	e	u	
6	ACK	SYN	&	6	F	V	f	v	
7	BEL	ETB	'	7	G	W	g	w	
8	BS	CAN	(8	H	X	h	x	
9	HT	EM)	9	I	Y	i	y	
A	LF	SUB	*	:	J	Z	j	z	
B	VT	ESC	+	;	K	[k	{	
C	FF	FS	,	<	L	\	l		
D	CR	GS	-	=	M]	m	}	
E	SO	RS	.	>	N	^	n	~	
F	SI	US	/	?	O	_	o	DEL	

Update



Abort



ENTERING PIN CODE FOR AUTHENTICATION

USE PRESET PIN

- 1) In the configuration mode, read the label below to use a preset PIN for authentication.



- 2) Read one of the labels to specify the PIN code, in decimal or hexadecimal.
By default, the PIN code is set to "0000". Maximum 16 characters are allowed.

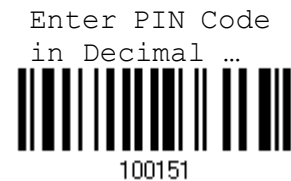

- 3) Read the "[Decimal Value](#)" label on page 187 or the "[Hexadecimal Value](#)" label on page 188 for the desired digits or character string.
Read the "Clear PIN Code" label first if you need to re-input the PIN code.



- 4) Read the "Validate" label to complete this setting.



DISABLE AUTHENTICATION OR USE RANDOM PIN

In the configuration mode, read the label below to disable authentication (= No PIN) or use a random PIN for authentication.



Note: When using BT HID, some device driver may not support pre-defined PIN code for authentication. In this case, make sure you have the scanner set to "No PIN or use random PIN" before pairing. While pairing, the host PIN code will be displayed on the computer screen.

Use Random PIN

When the target device is set to use a random PIN for authentication, wait until the random PIN is displayed on the target device while pairing, and then input the matching PIN code on the scanner.

Note: Follow the steps below to enter the matching PIN on the scanner. There is no need to enter the configuration mode!

1. Read one of the labels to specify the PIN code, in decimal or hexadecimal.

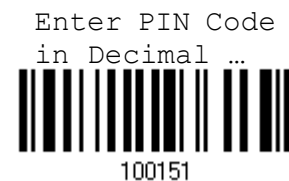

2. Read the "[Decimal Value](#)" label on page 187 or the "[Hexadecimal Value](#)" label on page 188 for the desired digits or character string.

Read the "Clear PIN Code" label first if you need to re-input the PIN.



3. Read the "Validate" label to complete this setting.



Reject Random PIN Request

When the random PIN is displayed on the target device while pairing, you can reject the PIN request by having the scanner read the “Validate” label.

